

Solano Group
P.O. Box 9026
Berkeley, CA 94709

June 17, 2013

RECEIVED

By Alameda County Environmental Health at 10:53 am, Jun 18, 2013

Mr. Mark Detterman
Alameda County Health Care Services Agency
Department of Environmental Health
1131 Harbor Bay Parkway, Suite 250
Alameda, CA 94502-6577

Re: Albany 1-Hour Cleaners

1187 Solano Avenue
Albany, California
ACEH Case No. 2857

Dear Mr. Detterman:

The Solano Group has retained Pangea Environmental Services, Inc. (Pangea) for environmental consulting services for the project referenced above. On my behalf, Pangea is submitting the attached *Assessment Workplan*.

I declare, under penalty of perjury, that the information and/or recommendations contained in the attached report is true and correct to the best of my knowledge.

Sincerely,



J. Anthony Kershaw
General Partner
Solano Group



June 17, 2013

VIA ALAMEDA COUNTY FTP SITE

Mr. Mark Detterman
Alameda County Environmental Health
1131 Harbor Bay Parkway, 2nd Floor
Alameda, California 94502

Re: **Assessment Workplan**
Former Albany 1-Hour Cleaners
1187 Solano Avenue
Albany, CA 94706
ACEH SLIC Case RO0002857

Dear Mr. Detterman:

On behalf of the Solano Group, Pangea Environmental Services, Inc. (Pangea) has prepared this *Assessment Workplan* (Workplan). This Workplan proposes several soil borings and subslab gas sampling locations. The primary objective of this assessment is to further evaluate the potential for vapor intrusion into indoor air, and to help identify any significant PCE mass in the site subsurface that could merit excavation or removal.

If you have any questions or comments, please call me at (510) 435-8664.

Sincerely,
Pangea Environmental Services, Inc.

A handwritten signature in blue ink, appearing to read "Bob Clark-Riddell".

Bob Clark-Riddell, P.E.
Principal Engineer

Attachment: *Assessment Workplan*

cc: Mr. J. Anthony Kershaw, Solano Group, P.O. Box 9026, Berkeley, California 94709
SWRCB Geotracker Database (electronic copy)

PANGEA Environmental Services, Inc.

1710 Franklin Street, Suite 200, Oakland, CA 94612 Telephone 510.836.3700 Facsimile 510.836.3709 www.pangeaenv.com



ASSESSMENT WORKPLAN

**Former Albany 1-Hour Cleaners
1187 Solano Avenue
Albany, CA 94706
ACEH SLIC Case RO0002857**

June 17, 2013

Prepared for:

J. Anthony Kershaw
Solano Group
P.O. Box 9026
Berkeley, California 94709

Prepared by:

Pangea Environmental Services, Inc.
1710 Franklin Street, Suite 200
Oakland, California 94612

Written by:

Tina de la Fuente
Project Scientist



Bob Clark-Riddell, P.E.
Principal Engineer

PANGEA Environmental Services, Inc.

INTRODUCTION

On behalf of the Solano Group, Pangea Environmental Services, Inc. (Pangea) has prepared this *Assessment Workplan* (Workplan). The primary objective of this assessment is to further evaluate the potential for vapor intrusion into indoor air, and to help identify any significant PCE mass in the site subsurface that could merit excavation or removal. This Workplan proposes nine (9) soil borings (5 angled borings and 4 vertical borings) and eleven (11) subslab gas sampling locations. The Workplan also includes two (2) contingent borings in the 1183 Solano unit (dentist), if elevated PCE concentrations are reported in nearby subslab gas probes.

SITE BACKGROUND

Site Description

The subject site consists of a vacant, one-story commercial unit at 1187 Solano Avenue (Figures 1, 2 and 3). Dry cleaner operations occurred at Albany 1-Hour Cleaners at 1187 Solano Avenue (subject site) from approximately 1986 to 2011. In 2004, hydrocarbon-based cleaning equipment was installed to replace the equipment that used tetrachloroethene, also known as perchloroethene (PCE).

The subject site represents one unit of an entire commercial block of single-story units/buildings along Solano Avenue, for which the responsible party (Solano Group) owns the north side of the block. Parcel number 66.2801-22-1 includes 1175 Solano (pizza restaurant), 1181 Solano (medical offices), 1183 Solano (dentist office), and 1185 Solano (vacant and immediately adjacent subject site). Parcel number 66.2801-20 includes 1191 Solano (U.S. Post Office). Residential properties are north and northwest of the subject site. Cornell Elementary School is present about 150 ft southeast (upgradient) of the subject site.

Subsurface assessment was performed in 2004 and 2005 by Avalon Environmental Consultants of Tustin, California, to evaluate potential cleaning solvent impact to soil, soil gas, and groundwater. The assessment included soil gas sampling from 5 ft depth in four (4) temporary probes (SG- 1 through SG-4), soil sampling from three (3) shallow borings at 5 ft depth (GP-1 through GP-3), soil sampling from five (5) deeper borings to 10 to 30 ft depth (GPA-1 through GPA-5), and groundwater sampling from approximately 30 ft deep within the five deeper borings completed to a maximum of 37 ft bgs. Prior site assessment was summarized and evaluated in the *Soil Gas Investigation and Human Health Risk Assessment* dated June 8, 2006. Avalon reported that no sensitive receptors such as schools, day care centers or hospitals are located within 100 ft of the subject property structure, and that the nearest residences are located greater than 100 ft north and separated by a parking lot. Avalon's report concluded that the risk posed by the identified compounds was within acceptable levels for commercial site use and recommended no further action at the time. In a letter dated July 5, 2006, the Alameda County Environmental Health (ACEH) concurred with the report findings and

requested a closure request for commercial land use with a draft deed restriction limiting future land use. The ACEH required additional action to allow case closure with *unrestricted* land use and avoid a deed restriction.

In January 2013, the Solano Group retained Pangea Environmental Services of Oakland, California, to review site environmental conditions prior to site improvements for a planned restaurant. Pangea performed extensive site assessment, remediation, and vapor intrusion mitigation efforts between January and June 2013. A *Site Assessment and Remediation Report* detailing the extensive site work during this period will be submitted in the near future with additional information requested by ACEH. Historic sampling data for soil, groundwater, and soil gas are summarized on Tables 1, 2 and 3, respectively. Current site impact by PCE for subslab gas, groundwater, and soil is summarized on Figures 2, 3 and 4, respectively. Historic (and proposed) sampling locations are shown on Figure 5. The subslab depressurization system is illustrated on Figure 6.

PROPOSED ASSESSMENT

The primary objective of this assessment is to further evaluate the potential for vapor intrusion into indoor air, and to help identify any significant PCE mass in the site subsurface that could merit excavation or removal.

Proposed Sampling Location Overview

This Workplan proposes nine (9) soil borings (5 angled borings and 4 vertical borings) and eleven (11) new subslab gas sampling locations. The proposed soil borings target potential residual PCE impact along the abandoned sanitary sewer beneath the bathrooms and ramp within 1185 Solano Avenue, where recent building renovation (tiled bathrooms and elevated ramp) has inhibited additional assessment and potential soil excavation. The remaining proposed borings and several subslab gas probes target the area near subslab probe SS-6, where elevated PCE vapor concentrations persist after short ventilation testing. Additional proposed subslab probe locations target the center of 1185 Solano, the southern edge of 1187 Solano, and four locations within 1183 Solano. For 1183 Solano, two subslab probe locations are proposed along the abandoned sewer, and two further from the sewer for lateral delineation of subslab gas. The Workplan includes two contingent borings in the 1183 Solano unit (dentist), if elevated PCE concentrations are reported in nearby subslab gas probes. Two subslab sample locations, proposed beneath the concrete alley, will help evaluate shallow soil gas conditions near the medical office at 1181 Solano and if impacted shallow groundwater is offgassing PCE that could pose a vapor intrusion risk. Finally, the Workplan also proposes sampling of soil gas from the existing subslab gas probes and existing ventilation piping. The proposed scope of work to accomplish the investigation objective is detailed below.

Task 1 - Pre-Field Activities

Prior to initiating field activities, Pangea will conduct the following tasks:

- Obtain drilling permits from Alameda County Public Works Agency (ACPWA) as necessary;
- Pre-mark the boring locations with white paint, notify Underground Service Alert (USA) of the drilling and sampling activities at least 72 hours before work begins, and conduct private line locating as merited;
- Prepare a site-specific health and safety plan to educate personnel and minimize their exposure to potential hazards related to site activities; and
- Coordinate with drilling and laboratory subcontractors and other involved parties.

Task 2 – Soil Borings

To evaluate the potential residual mass below the northern portion of 1185 Solano Avenue, Pangea proposes to advance five angled soil borings to approximately two to four ft below grade surface (bgs) and four vertical soil borings to approximately 5 ft bgs. As shown on Figure 5, Pangea plans to install four of the nine soil borings (B-31 through B-34) in the northern portion of the adjacent commercial building, and the five angled borings (A-9 through A-13) in west side of the onsite building extending into the northern portion of the adjacent building. At each angle boring location, soil samples will be collected where shown on Figure 5. For each vertical boring, samples will be collected every foot and screened with a photo-ionization device (PID). Groundwater sampling is not proposed at boring locations.

Pangea will conduct site investigation using hand auger techniques. Soil samples will be collected within new brass or stainless steel liners driven into undisturbed soil with a slide-hammer. Additional soil samples may be collected at lithologic changes. The soil samples will be classified according to the Unified Soil Classification System (USCS) and screened for field indications of potential volatile organic compounds using visual and olfactory observations and a photo-ionization device (PID).

All site investigation activities will be performed under the supervision of a California Registered Civil Professional Engineer (P.E.). Additional soil and assessment procedures are presented in our Standard Operating Procedures (SOPs) in Appendix A.

Soil samples will be analyzed for Volatile Organic Compounds (VOCs) by EPA Method 8260B (Method 8010 Target List).

Task 3 –Subslab Gas Sampling

Pangea proposes to install 11 subslab probes to facilitate collection of subslab gas samples. As shown on Figure 5, three subslab probes are proposed within the northern portion of the immediately adjacent 1185 Solano Avenue building and one in the central portion of 1185 Solano. One subslab probe is proposed within southern end of the subject site (1187 Solano). Within the nearby 1183 Solano unit, two are proposed along the abandoned sanitary sewer and two more distant from the sewer. The final two subslab sample locations, proposed beneath the concrete alley, will help evaluate shallow soil gas conditions near the medical office at 1181 Solano and if impacted shallow groundwater is offgassing PCE that could pose a vapor intrusion risk.

After probe installation and at least 2 hours prior to sampling, Pangea will screen subslab gas with a photoionization device (PID). To control cost, probes with estimated soil gas concentrations above 250 micrograms/cubic meter ($\mu\text{g}/\text{m}^3$) will be collected within a Tedlar bag and submitted for sample extraction the same day. Based on prior site correlation with laboratory data at this site, a PID reading of 0.1 ppmv or greater suggests PCE concentrations above $250 \mu\text{g}/\text{m}^3$. Other samples with estimated low to potentially non-detect PCE concentrations ($<250 \mu\text{g}/\text{m}^3$) will be collected using Summa canisters. All samples will be submitted to a state-certified laboratory for analysis. All subslab gas samples in Tedlar bags will be analyzed for Volatile Organic Compounds (VOCs) by EPA Method 8260B (Method 8010 Target List). All subslab gas samples in Summa canisters will be analyzed by modified Total Organics Method 15 (TO-15) for volatile organic compounds (VOCs); and select subslab gas samples will be analyzed for helium (leak check compound) by Method ASTM D-1946.

The *subslab* gas probe installation procedure involves using a rotohammer to drill a 1 ½-inch diameter, 4-inch deep hole in the approximately 6-inch thick concrete slab of the building, drilling a ½-inch diameter hole through the remaining concrete, installing a rubber stopper with stainless steel tubing (capped on one end with a Swagelok fitting) and placing a bentonite seal from the top of the stopper to within an inch of the surface. A second rubber stopper will be placed over the subslab probe to protect it and the probes will be allowed to equilibrate for at least 2 hours, prior to sampling.

An analytical laboratory will provide sampling assemblies and certified Summa canisters for sampling performed where PCE concentrations are estimated to be below $250 \mu\text{g}/\text{m}^3$. The Summa canisters will come under a complete vacuum of approximately 30 inches of mercury. Prior to sample collection a vacuum/leak test will be conducted on the sampling assembly with a vacuum pump to confirm no leak and the maintenance of the initial vacuum in the sampling manifold system. After vacuum/leak testing, the vacuum pump will be started to purge the manifold/probe assembly. During purging, vapor from the probe will be routed through a Tedlar bag within a vacuum chamber to check for helium within the probe/sampling assembly and to qualitatively screen for contaminants. Upon completion of purging of approximately five or more times the

ambient volume of air in the assembly/probe and void space, the sampling Summa canister will be opened for sample collection. The pre-set valve will regulate the vapor flow to approximately 150 milliliters of air per minute, which equates to approximately 5 minutes to fill a 1-liter canister. Sample collection is typically discontinued when the vacuum decreases to between 5 and 3 inches of mercury.

To further evaluate potential leakage within the sampling system, a leak-check enclosure will be placed over the subslab probe, and helium gas will be introduced into the leak-check enclosure. A helium detector will be used to monitor the concentration of helium within the enclosure during sample collection. Additionally, Tedlar bag samples are collected after sample collection to check for helium in the sampling assembly. This method allows Pangea to monitor for leaks from the sample probe during sample collection and correct problems before sending the samples to the laboratory. The subslab sampling will be conducted in general accordance with procedures described in Pangea's Standard Operating Procedures (SOPs) for Subslab Gas Sampling (Appendix A).

Task 4 – Ventilation Pipe/Well Sampling

To further evaluate subsurface gas under the redeveloped bathroom and hallway area of 1185 Solano, Pangea proposes to sample subslab gas from existing ventilation wells/piping at '1185 Bath' and '1185 Hall Soil'. Ventilation piping locations are shown on Figure 6. Sampling of these vent pipes is proposed to avoid subslab probe installation through the existing remodeled bathrooms. During initial extraction testing on these 'wells', PID readings were approximately 6 and 9 ppmv. Subsequent short-term extraction of these 'wells' after a rebound test yielded significantly lower PID measurements of 0.4 and 0.6 ppmv. Based on prior site correlation with laboratory data, these PID readings from the rebound test correlate to approximately 1,000 to 2,000 $\mu\text{g}/\text{m}^3$. Therefore, for cost control, Pangea will collect gas samples in a Tedlar bag. These readings were obtained using a 2.5 hp Fuji Model VFC50 extraction blower and the piping manifold. Vapor emissions were treated with granular activated carbon and test notification was provided to the Bay Area Air Quality Management District. For the proposed subsurface gas sampling, Pangea will install temporary tubing within the screened portion of the ventilation well and collect a sample using procedures described below.

Vent Well Installation and Construction: The ventilation piping/wells consist of 4-inch diameter slotted schedule 40 PVC piping, wrapped with geotextile material. One end of each 'vent' is capped, and the other plumbed with 2-inch diameter solid schedule 40 PVC to the vent piping manifold within the western wall of 1187 Solano. Ball valves and sampling ports are located within fire-rated enclosures at the vent piping manifold to allow monitoring and adjustment of extracted subslab vapors. Bentonite plugs were installed at the end of each vent to help minimize the potential for vapor flow short-circuiting within the subsurface.

These vents were constructed by the remediation contractor on May 22 and 24, 2013, using a 7-inch diameter hand auger and a PID to screened soil for PCE vapors. '1185 Bath' was installed immediately beneath the primary sanitary sewer as it travelled beneath the bathroom at 1185 Solano, extending beyond 7 ft from the wall where the sewer turned 45 degrees. This 1185 Bath vent was screened from approximately 6 to 10 ft horizontally from the 1187 Solano wall, with the sand pack extending to 11 ft under the wall (where a PID reading of 4 ppmv was measured). To enhance influence within subslab materials, the sanitary sewer piping was removed along with sand/backfill material surrounding the sewer. The vent pipe was installed within the location of the former sewer and the underlying hand auger borehole. (Subsequent vent testing confirmed significant vacuum influence extending from the '1185 Bath' vent through subslab materials to probe SS-6 located approximately 15 ft to the south).

The '1185 Hall Soil' vent well, installed beneath the hallway/ramp in 1185 Solano, was screened from approximately 7 to 12 ft horizontally from the 1187 Solano wall, with the sand pack extending from 6 to 7 ft under to wall and again from 12 to 14.5 ft under the wall. This vent pipe was extended this length to influence potential residual PCE under the abandoned sanitary sewer location as it angled toward 1183 Solano. The screen interval targeted the highest PID readings in this boring, which were 12 ppmv (at 8 ft) and 15 ppmv (at 12 ft). Due to access limitations, this vent pipe was angled slightly downward and allowed soil gas extraction from slightly deeper subsurface soil rather than subslab materials already influenced by the '1185 Bath' vent. For each vent, sand was compacted inside the borehole prior to insertion of the capped and plumbed slotted pipe.

On May 24, 2013, ST also hand augered boring A-8 angled under the bathroom of the adjacent 1185 Solano unit. This boring was performed to evaluate conditions near the abandoned sewer. Due to limited PID readings (maximum of 6 ppmv at 6.5 ft under the wall) and significant vacuum influence from the adjacent '1185 Bathroom' vent, an additional vent was not constructed in this borehole. A soil sample collected from 5 ft under the wall (about 2 ft bgs) contained only 0.0093 mg/Kg. Due to limited impact detected in soil at boring A-8, Pangea does not propose additional soil sampling at this time. If elevated subsurface gas is detected in these vent wells, Pangea may conduct additional angled borings under the bathrooms, or recommend soil excavation.

Vent Well Sampling: To facilitate vent well sampling, Pangea will confirm that each well valve is closed and that soil gas within the piping/well has been allowed to equilibrate for at least five days. Pangea will tap a hole into solid vent piping at the elbow where the conveyance piping exits the 1185 Solano space into the 1187 Solano unit. Inside the hole, Pangea will insert ¼" nominal diameter tubing near the center of the well screen interval, located about 8 and 10 ft laterally, respectively, within the vent wells for 1185 Bath and 1185 Hall Soil. The tubing will be sealed at the insertion point with fittings. Pangea will perform purge testing from each vent. During the purge test, Pangea will purge a specified volume and then screen the extracted vapor

with a PID and collect a Tedlar bag sample for potential analysis. Pangea plans to test vent well gas after purging the following volumes: one pore volume of tubing (about 100 ml), ten (10) tubing pore volumes (1,000 ml, which equals the initial purge volume plus 0.9L for initial Tedlar bag sample), and each additional 1L (1000 ml, which corresponds to bag sample collection and limited PID screening) until PID readings start to decrease. Pangea will submit the Tedlar bag sample with the highest corresponding PID reading to the laboratory for analysis the same day. The subslab gas samples in Tedlar bags will be analyzed for VOCs by EPA Method 8260B (Method 8010 Target List). In the unlikely event that PID readings are <0.1 ppmv, the subslab gas samples will be collected in Summa canisters for analysis for VOCs by modified Method TO-15.

Task 5 – Waste Management and Disposal

Soil cuttings and other investigation-derived waste will be stored onsite in Department of Transportation (DOT)-approved 55-gallon drums. The drums and their contents will be held onsite pending laboratory analytical results. Upon receipt of the analytical reports, the waste will be transported to an appropriate disposal/recycling facility.

Task 6 – Report Preparation

Upon completion of assessment activities, Pangea will prepare a technical report. The report will describe the investigation activities, present tabulated analytical data, and offer conclusions and recommendations. The report will compare subslab gas and soil concentrations to applicable regulatory screening levels. The assessment data will help facilitate preparation of a feasibility study/corrective action plan for residual PCE impact. Two primary alternatives for corrective action include soil excavation and/or operation of a subslab depressurization/soil vapor extraction system.

REFERENCES

- Avalon Environmental Consultants, 2004, (Avalon, 2004), *Phase II Subsurface Site Assessment*, November 10.
- Avalon Environmental Consultants, 2005, (Avalon, 2005), *Phase II Subsurface Groundwater Assessment*, May 4.
- Avalon Environmental Consultants, 2006, (Avalon, 2006), *Soil Gas Investigation and Health Risk Assessment*, June 8.

ATTACHMENTS

Figure 1 – Vicinity Map

Figure 2 – PCE in Subslab Soil Gas After Excavation and SSD Tests, April 25, 2013

Figure 3 – PCE in Shallow Groundwater

Figure 4 – PCE in Soil Before Excavation

Figure 5 – Proposed Sampling Locations

Figure 6 – Subslab Depressurization System

Table 1 – Soil Analytical Data

Table 2 – Groundwater Analytical Data

Table 3 – Soil Gas Analytical Data

Appendix A – Standard Operating Procedures

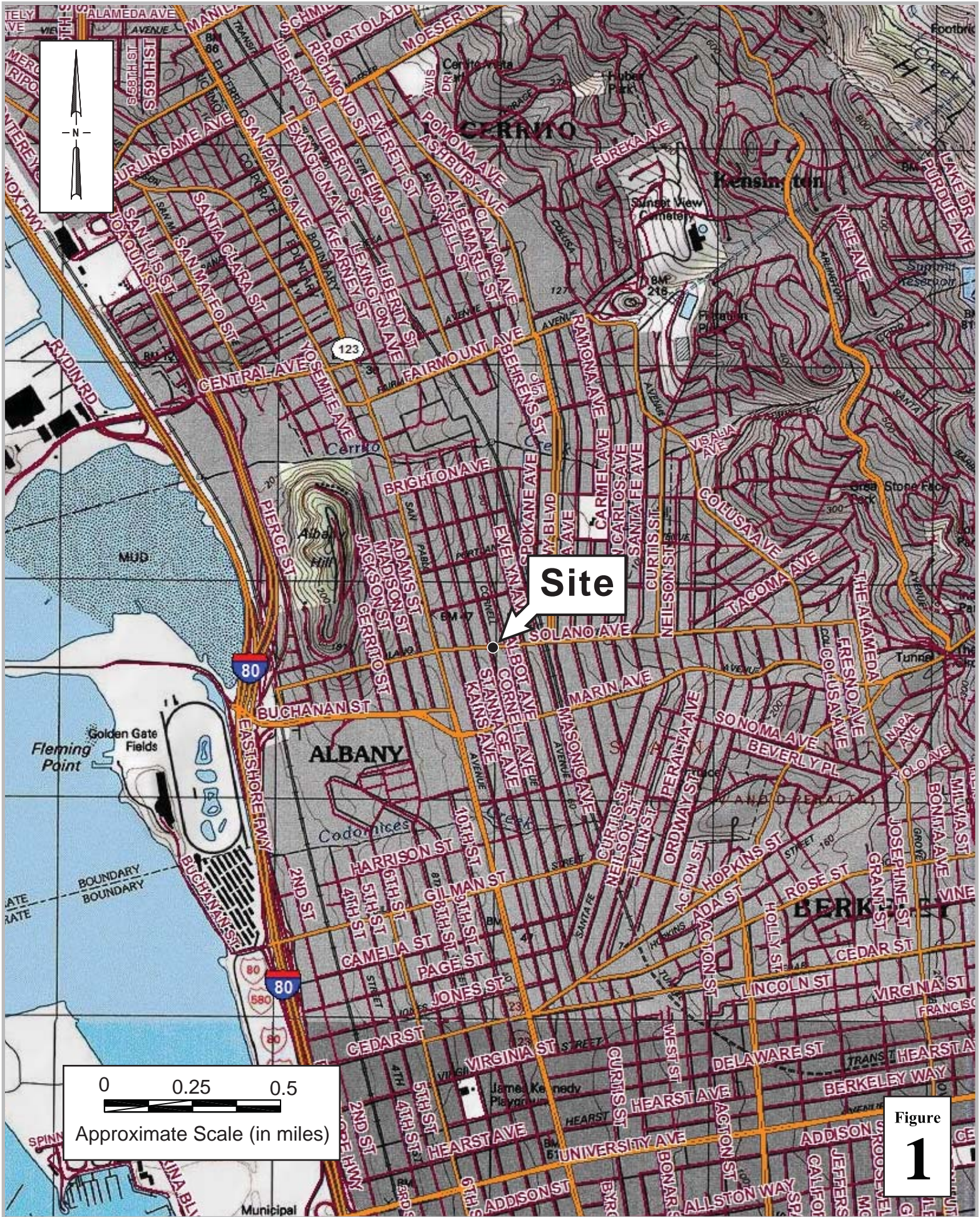
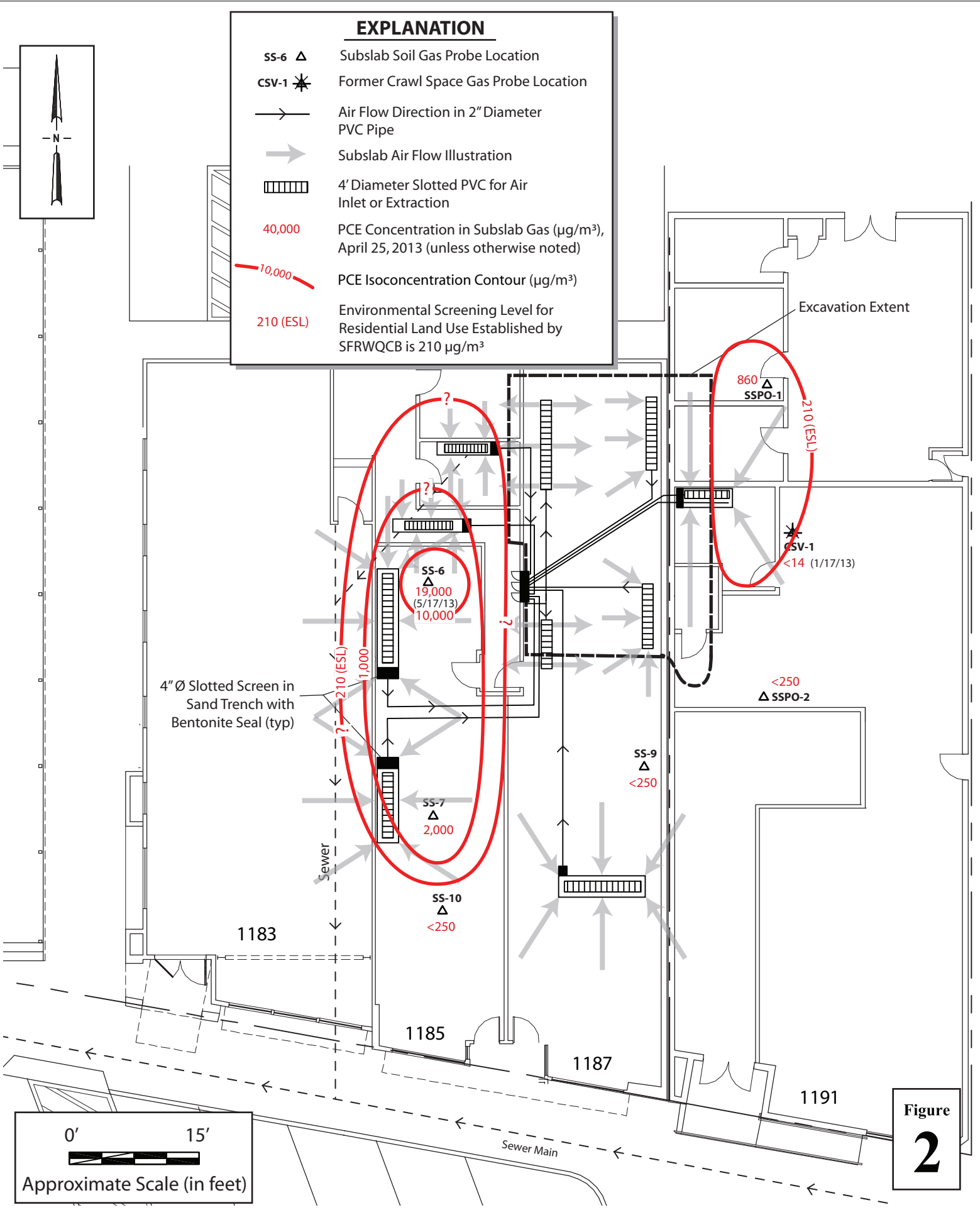





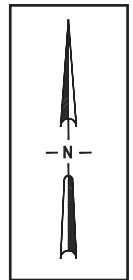

Figure
1



EXPLANATION

-  MW-1 Groundwater Monitoring Well
-  (9-14') Pre-pack screen interval, feet bgs
-  B-21 Boring Location
-  48 PCE Concentration in Groundwater ($\mu\text{g/L}$), 2013
-  100 PCE Isoconcentration Contour ($\mu\text{g/L}$)
-  630(ESL) ESL Screening Level for Groundwater Protective of Indoor Air, Residential Site Use



Estimated Groundwater Flow Direction

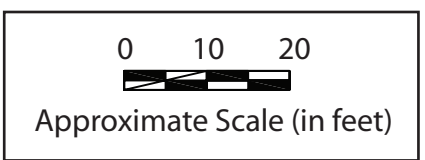

CORNELL AVENUE

SINGLE STORY COMMERCIAL BUILDING

Figure 3

EXPLANATION

- CSV-1 Crawl Space Gas Probe Location
 - SS-3 Subslab Soil Gas Probe Location
 - SG-1 Soil Gas Probe Location
 - B-1 Soil Boring Location (Shallow)
 - GPA-1 Soil Boring Location (Deep)
 - A-2 Angled Soil Boring Location (sample location = ●)
- 0.190 PCE Concentration in Soil, mg/kg
 5' Sample depth, feet
 * Overexcavated Location
 + 1191 Solano grade is ~2.5' higher than 1187 grade
 NS Not Sampled

NOTE:

ESL = 0.43 mg/kg residential soil <3m

PCE in Shallow (<3m) Soil Exceeding Residential ESL

~10' North

| GPA-3 | |
|-------|----|
| 10' | ND |
| 20' | ND |
| 30' | ND |

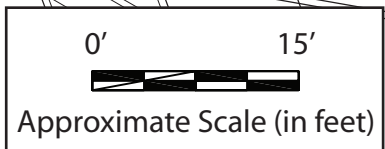
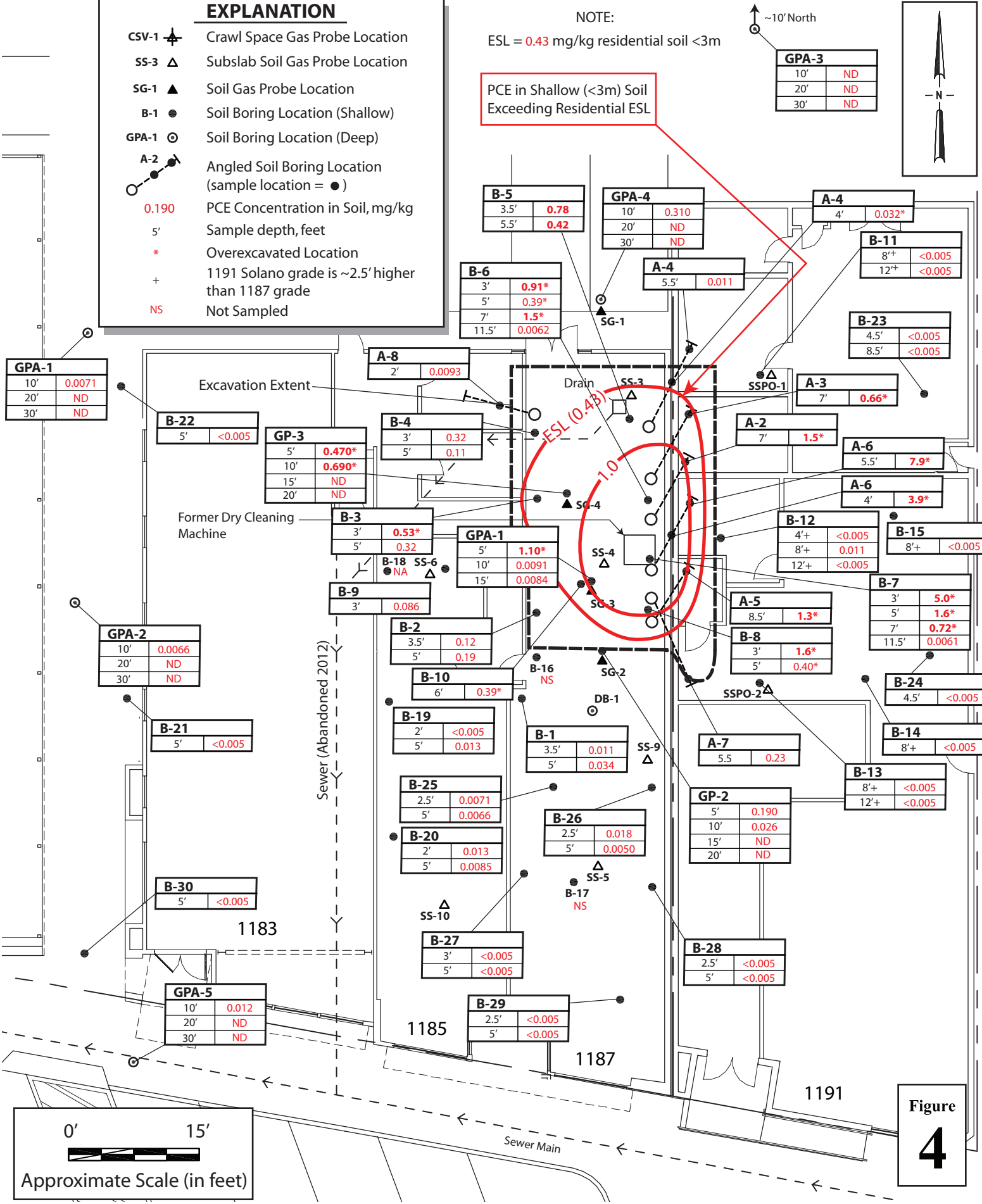
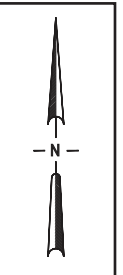

Figure 4

EXPLANATION

- | | | | |
|-------|---|------|--|
| MW-1 | Groundwater Monitoring Well | SS-3 | Destroyed Probe Location |
| CSV-1 | Crawl Space Gas Probe Location | ▲ | Proposed Soil Gas Probe Location |
| SS-6 | Subslab Soil Gas Probe Location | B-31 | Proposed Soil Boring Location |
| SG-1 | Soil Gas Probe Location | A-11 | Proposed Angled Soil Boring Location (sample location = ●) |
| B-1 | Soil Boring Location (Shallow) | | |
| GPA-1 | Soil Boring Location (Deep) | | |
| A-2 | Angled Soil Boring Location (sample location = ●) | | |

~10' North
GPA-3

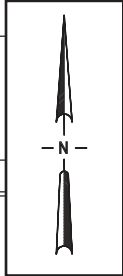



Figure
5

EXPLANATION

| | |
|--|--|
| <p>ss-3 Δ</p> <p>\rightarrow</p> <p>\rightarrow</p> <p></p> | <p>Subslab Soil Gas Probe Location</p> <p>Air Flow Direction in 2" Diameter PVC Pipe</p> <p>Subslab Air Flow Illustration</p> <p>4' Diameter Slotted PVC for Air Inlet or Extraction</p> |
|--|--|

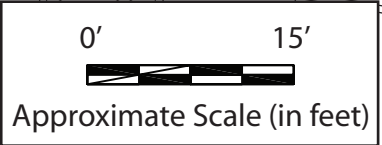
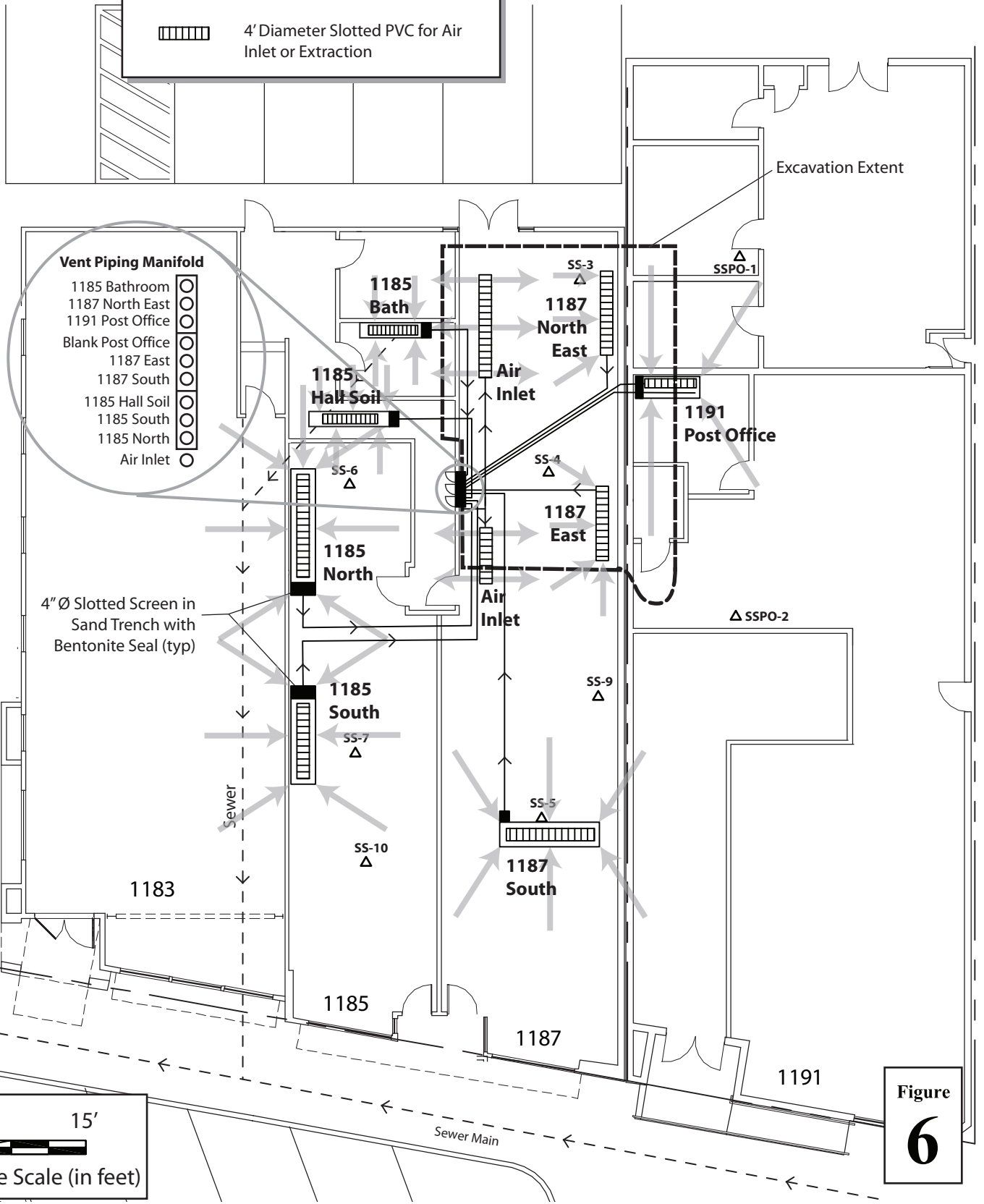
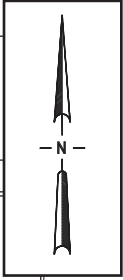

Figure
6

Pangea

Table 1. Soil Analytical Data - 1187 Solano Ave, Albany, California

| | PCE | TCE | cis-1,2-DCE | Other VOCs | Comments |
|---|-------------|-------------|-------------|------------|----------|
| <i>Residential</i> ESL shallow soil dw (<3 m bgs) Final ESL: | 0.43 | 0.46 | 0.19 | Varies | |
| <i>Residential</i> ESL shallow soil non-dw (<3 m bgs) Final ESL: | 0.43 | 1.1 | 18 | Varies | |
| <i>Residential</i> ESL shallow soil dw&non-dw (<3 m bgs) Direct Exp ESL: | 0.43 | 1.1 | 160 | Varies | |
| <i>Commercial</i> ESL shallow soil dw (<3 m bgs) Final ESL: | 0.7 | 0.46 | 0.19 | Varies | |
| <i>Commercial</i> ESL shallow soil non-dw (<3 m bgs) Final ESL: | 3.4 | 5.9 | 18 | Varies | |
| <i>Residential</i> ESL deep soil dw (>3 m bgs) Final ESL: | 0.57 | 0.46 | 0.19 | Varies | |
| <i>Residential</i> ESL deep soil non-dw (>3 m bgs) Final ESL: | 0.57 | 6.7 | 18 | Varies | |
| <i>Commercial</i> ESL deep soil dw (>3 m bgs) Final ESL: | 0.7 | 0.46 | 0.67 | Varies | |
| <i>Commercial</i> ESL deep soil non-dw (>3 m bgs) Final ESL: | 3.4 | 5.9 | 18 | Varies | |
| <i>Commercial</i> ESL deep soil dw & non-dw (>3 m bgs) Direct Exp. ESL: | 0.57 | 6.7 | 2,000 | Varies | |

| Boring/ Sample ID | Date Sampled | Sample Depth (ft bgs) | ←————— mg/Kg —————→ | | | |
|----------------------|-----------------|--------------------------|---------------------|--|--|--|
|----------------------|-----------------|--------------------------|---------------------|--|--|--|

2004 and 2005 Borings

| | | | | | | | |
|-----------|-----------|------|--------------|--------|----|----|----------------------|
| GP-1-5' | 11/2/2004 | 5.0 | 1.10 | 0.0059 | ND | ND | Overexcavated |
| GP-1-10' | 11/2/2004 | 10.0 | 0.0091 | ND | ND | ND | Overexcavated |
| GP-1-15' | 11/2/2004 | 15.0 | 0.0084 | ND | ND | ND | |
| GP-2-5' | 11/2/2004 | 5.0 | 0.190 | 0.0022 | ND | ND | |
| GP-2-10' | 11/2/2004 | 10.0 | 0.026 | ND | ND | ND | |
| GP-2-15' | 11/2/2004 | 15.0 | ND | ND | ND | ND | |
| GP-2-20' | 11/2/2004 | 20.0 | ND | ND | ND | ND | |
| GP-3-5' | 11/2/2004 | 5.0 | 0.470 | ND | ND | ND | Overexcavated |
| GP-3-10' | 11/2/2004 | 10.0 | 0.690 | ND | ND | ND | Overexcavated |
| GP-3-15' | 11/2/2004 | 15.0 | ND | ND | ND | ND | |
| GP-3-20' | 11/2/2004 | 20.0 | ND | ND | ND | ND | |
| GPA-1-10' | 4/20/2005 | 10.0 | 0.0071 | ND | ND | ND | |
| GPA-1-20' | 4/20/2005 | 20.0 | ND | ND | ND | ND | |
| GPA-1-30' | 4/20/2005 | 30.0 | ND | ND | ND | ND | |
| GPA-2-10' | 4/20/2005 | 10.0 | 0.0066 | ND | ND | ND | |
| GPA-2-20' | 4/20/2005 | 20.0 | ND | ND | ND | ND | |
| GPA-2-30' | 4/20/2005 | 30.0 | ND | ND | ND | ND | |
| GPA-3-10' | 4/20/2005 | 10.0 | ND | ND | ND | ND | |
| GPA-3-20' | 4/20/2005 | 20.0 | ND | ND | ND | ND | |
| GPA-3-30' | 4/20/2005 | 30.0 | ND | ND | ND | ND | |
| GPA-4-10' | 4/20/2005 | 10.0 | 0.310 | ND | ND | ND | |
| GPA-4-20' | 4/20/2005 | 20.0 | ND | ND | ND | ND | |
| GPA-4-30' | 4/20/2005 | 30.0 | ND | ND | ND | ND | |
| GPA-5-10' | 4/20/2005 | 10.0 | 0.012 | ND | ND | ND | |
| GPA-5-20' | 4/20/2005 | 20.0 | ND | ND | ND | ND | |
| GPA-5-30' | 4/20/2005 | 30.0 | ND | ND | ND | ND | |

January 2013 Borings

| | | | | | | | |
|----------|-----------|---------|-------------|--------|--------|----|----------------------|
| B-1-3.5 | 1/10/2013 | 3.5-4.0 | 0.011 | <0.005 | <0.005 | ND | |
| B-1-5.5 | 1/10/2013 | 5.0-5.5 | 0.034 | 0.0051 | <0.005 | ND | |
| B-2-4* | 1/10/2013 | 3.5-4.0 | 0.12 | 0.046 | 0.022 | ND | Overexcavated |
| B-2-5.5* | 1/10/2013 | 5.0-5.5 | 0.19 | 0.025 | 0.010 | ND | Overexcavated |
| B-3-3.5* | 1/10/2013 | 3.0-3.5 | 0.53 | <0.025 | <0.025 | ND | Overexcavated |
| B-3-5.5* | 1/10/2013 | 5.0-5.5 | 0.32 | <0.020 | <0.020 | ND | Overexcavated |

Pangea

Table 1. Soil Analytical Data - 1187 Solano Ave, Albany, California

| | PCE | TCE | cis-1,2-DCE | Other VOCs | Comments | | |
|---|-----------------|--------------------------|---------------------|------------|----------|----|----------------------|
| <i>Residential</i> ESL shallow soil dw (<3 m bgs) Final ESL: | 0.43 | 0.46 | 0.19 | Varies | | | |
| <i>Residential</i> ESL shallow soil non-dw (<3 m bgs) Final ESL: | 0.43 | 1.1 | 18 | Varies | | | |
| <i>Residential</i> ESL shallow soil dw&non-dw (<3 m bgs) Direct Exp ESL: | 0.43 | 1.1 | 160 | Varies | | | |
| <i>Commercial</i> ESL shallow soil dw (<3 m bgs) Final ESL: | 0.7 | 0.46 | 0.19 | Varies | | | |
| <i>Commercial</i> ESL shallow soil non-dw (<3 m bgs) Final ESL: | 3.4 | 5.9 | 18 | Varies | | | |
| <i>Residential</i> ESL deep soil dw (>3 m bgs) Final ESL: | 0.57 | 0.46 | 0.19 | Varies | | | |
| <i>Residential</i> ESL deep soil non-dw (>3 m bgs) Final ESL: | 0.57 | 6.7 | 18 | Varies | | | |
| <i>Commercial</i> ESL deep soil dw (>3 m bgs) Final ESL: | 0.7 | 0.46 | 0.67 | Varies | | | |
| <i>Commercial</i> ESL deep soil non-dw (>3 m bgs) Final ESL: | 3.4 | 5.9 | 18 | Varies | | | |
| <i>Commercial</i> ESL deep soil dw & non-dw (>3 m bgs) Direct Exp. ESL: | 0.57 | 6.7 | 2,000 | Varies | | | |
| Boring/ Sample ID | Date Sampled | Sample Depth (ft bgs) | ←————— mg/Kg —————→ | | | | |
| B-4-3.5* | 1/10/2013 | 3.0-3.5 | 0.32 | <0.020 | <0.020 | ND | Overexcavated |
| B-4-5.5* | 1/10/2013 | 5.0-5.5 | 0.11 | <0.005 | <0.005 | ND | Overexcavated |
| B-5-3.5* | 1/10/2013 | 3.0-3.5 | 0.78 | <0.050 | <0.050 | ND | Overexcavated |
| B-5-5.5* | 1/10/2013 | 5.0-5.5 | 0.42 | <0.033 | <0.033 | ND | Overexcavated |
| B-6-3.5* | 1/10/2013 | 3.0-3.5 | 0.91 | <0.10 | <0.10 | ND | Overexcavated |
| B-6-5.5* | 1/10/2013 | 5.0-5.5 | 0.39 | <0.025 | <0.025 | ND | Overexcavated |
| B-6-7.5* | 1/10/2013 | 7.0-7.5 | 1.5 | <0.20 | <0.20 | ND | Overexcavated |
| B-6-12* | 1/18/2013 | 11.5-12.0 | 0.0062 | <0.005 | <0.005 | ND | |
| B-7-3.5* | 1/10/2013 | 3.0-3.5 | 5.0 | <0.20 | <0.20 | ND | Overexcavated |
| B-7-5.5* | 1/10/2013 | 5.0-5.5 | 1.6 | <0.10 | <0.10 | ND | Overexcavated |
| B-7-7.5* | 1/10/2013 | 7.0-7.5 | 0.72 | <0.10 | <0.10 | ND | Overexcavated |
| B-7-12 | 1/18/2013 | 11.5-12.0 | 0.0061 | <0.005 | <0.005 | ND | |
| B-8-3.5* | 1/10/2013 | 3.0-3.5 | 1.6 | <0.10 | <0.10 | ND | Overexcavated |
| B-8-5.5* | 1/10/2013 | 5.0-5.5 | 0.40 | <0.025 | <0.025 | ND | Overexcavated |
| B-9-3 | 1/10/2013 | 2.5-3.0 | 0.086 | <0.005 | <0.005 | ND | 1185 Solano |
| B-10-6* | 1/10/2013 | 5.5-6.0 | 0.39 | <0.033 | <0.033 | ND | Overexcavated |
| B-11-8 | 1/18/2013 | 7.5-8.0 ⁺ | <0.005 | <0.005 | <0.005 | ND | 1191 Solano |
| B-11-12 | 1/18/2013 | 11.5-12.0 ⁺ | <0.005 | <0.005 | <0.005 | ND | 1191 Solano |
| B-12-4 | 1/18/2013 | 3.5-4.0 ⁺ | <0.005 | <0.005 | <0.005 | ND | 1191 Solano |
| B-12-8 | 1/18/2013 | 7.5-8.0 ⁺ | 0.011 | <0.005 | <0.005 | ND | 1191 Solano |
| B-12-12 | 1/18/2013 | 11.5-12.0 ⁺ | <0.005 | <0.005 | <0.005 | ND | 1191 Solano |
| B-13-8 | 1/18/2013 | 7.5-8.0 ⁺ | <0.005 | <0.005 | <0.005 | ND | 1191 Solano |
| B-13-12 | 1/18/2013 | 11.5-12.0 ⁺ | <0.005 | <0.005 | <0.005 | ND | 1191 Solano |
| B-14-8 | 1/18/2013 | 7.5-8.0 ⁺ | <0.005 | <0.005 | <0.005 | ND | 1191 Solano |
| B-15-8 | 1/18/2013 | 7.5-8.0 ⁺ | <0.005 | <0.005 | <0.005 | ND | 1191 Solano |
| February 2013 Borings (Angled Under Wall onto 1191 Solano property) | | | | | | | |
| A-2-11* | 2/1/2013 | 7.0 | 1.5 | <0.10 | <0.10 | ND | Overexcavated |
| A-3-11* | 2/1/2013 | 7.0 | 0.66 | <0.20 | <0.20 | ND | Overexcavated |
| A-4-6* | 2/1/2013 | 4.0 | 0.032 | 0.013 | <0.005 | ND | Overexcavated |
| A-4-9* | 2/8/2013 | 5.5 | 0.011 | 0.005 | <0.005 | ND | |

Pangea

Table 1. Soil Analytical Data - 1187 Solano Ave, Albany, California

| | PCE | TCE | cis-1,2-DCE | Other VOCs | Comments | | |
|---|-----------------|--------------------------|-------------|------------|----------|----|----------------------|
| <i>Residential</i> ESL shallow soil dw (<3 m bgs) Final ESL: | 0.43 | 0.46 | 0.19 | Varies | | | |
| <i>Residential</i> ESL shallow soil non-dw (<3 m bgs) Final ESL: | 0.43 | 1.1 | 18 | Varies | | | |
| <i>Residential</i> ESL shallow soil dw&non-dw (<3 m bgs) Direct Exp ESL: | 0.43 | 1.1 | 160 | Varies | | | |
| <i>Commercial</i> ESL shallow soil dw (<3 m bgs) Final ESL: | 0.7 | 0.46 | 0.19 | Varies | | | |
| <i>Commercial</i> ESL shallow soil non-dw (<3 m bgs) Final ESL: | 3.4 | 5.9 | 18 | Varies | | | |
| <i>Residential</i> ESL deep soil dw (>3 m bgs) Final ESL: | 0.57 | 0.46 | 0.19 | Varies | | | |
| <i>Residential</i> ESL deep soil non-dw (>3 m bgs) Final ESL: | 0.57 | 6.7 | 18 | Varies | | | |
| <i>Commercial</i> ESL deep soil dw (>3 m bgs) Final ESL: | 0.7 | 0.46 | 0.67 | Varies | | | |
| <i>Commercial</i> ESL deep soil non-dw (>3 m bgs) Final ESL: | 3.4 | 5.9 | 18 | Varies | | | |
| <i>Commercial</i> ESL deep soil dw & non-dw (>3 m bgs) Direct Exp. ESL: | 0.57 | 6.7 | 2,000 | Varies | | | |
| Boring/ Sample ID | Date Sampled | Sample Depth (ft bgs) | ← mg/Kg → | | | | |
| A-5-13* | 2/1/2013 | 8.5 | 1.3 | <0.05 | <0.05 | ND | Overexcavated |
| A-6-6* | 2/1/2013 | 4.0 | 3.9 | <0.2 | <0.2 | ND | Overexcavated |
| A-6-10* | 2/1/2013 | 5.5 | 7.9 | <0.5 | <0.5 | ND | Overexcavated |
| A-7-9* | 2/8/2013 | 5.5 | 0.23 | <0.010 | <0.010 | ND | Overexcavated |
| February and March 2013 Excavation Boundary | | | | | | | |
| EX-SE-5 | 2/15/2013 | 5.0 | 0.012 | <0.005 | <0.005 | ND | |
| EX-SE2-6 | 2/18/2013 | 6.0 | <0.005 | <0.005 | <0.005 | ND | |
| EX-E-7 | 2/18/2013 | 7.0 | 0.055 | <0.005 | <0.005 | ND | |
| EX-N-8 | 2/22/2013 | 8.0 | <0.005 | <0.005 | <0.005 | ND | |
| EX-F1-11 | 3/5/2013 | 11.0 | 0.083 | <0.005 | <0.005 | ND | |
| EX-F2-7 | 3/5/2013 | 7.0 | 0.025 | <0.005 | <0.005 | ND | |
| SW-1-4 | 3/5/2013 | 4.0 | 0.021 | <0.005 | <0.005 | ND | |
| EX-F3-6 | 3/6/2013 | 6.0 | 0.57 | <0.005 | <0.005 | ND | Overexcavated |
| EX-F3-8 | 3/12/2013 | 8.0 | 0.36 | <0.005 | <0.005 | ND | |
| EX-F4-6 | 3/6/2013 | 6.0 | 0.20 | <0.005 | <0.005 | ND | |
| EX-F5-9 | 3/7/2013 | 9.0 | 0.0077 | <0.005 | <0.005 | ND | |
| EX-F6-12 | 3/7/2013 | 12.0 | 0.0066 | <0.005 | <0.005 | ND | |
| EX-F7-4 | 3/8/2013 | 4.0 | 0.15 | <0.005 | <0.005 | ND | |
| SW-2-4 | 3/11/2013 | 4.0 | 0.16 | <0.005 | <0.005 | ND | |
| SW-3-4 | 3/11/2013 | 4.0 | 0.10 | <0.005 | <0.005 | ND | |
| EX-F8-11 | 3/13/2013 | 11.0 | 0.059 | <0.005 | <0.005 | ND | |
| EX-F9-11 | 3/14/2013 | 11.0 | 0.026 | <0.005 | <0.005 | ND | |
| SW-4-5 | 3/14/2013 | 5.0 | 0.016 | <0.005 | <0.005 | ND | |
| SW-5-2 | 3/14/2013 | 2.0 | 0.12 | <0.005 | <0.005 | ND | |
| SW-6-2 | 3/14/2013 | 2.0 | 0.12 | <0.005 | <0.005 | ND | |
| SW-7-5 | 3/14/2013 | 5.0 | 0.047 | <0.005 | <0.005 | ND | |
| SW-8-1 | 3/16/2013 | 1.0 | 0.12 | <0.005 | <0.005 | ND | |
| SW-9-1 | 3/16/2013 | 1.0 | 0.096 | <0.005 | <0.005 | ND | |
| Sewer-1-1 | 3/16/2013 | 1.0 | 0.34 | <0.005 | <0.005 | ND | |
| Sewer-2-1 | 3/16/2013 | 1.0 | 0.34 | <0.005 | <0.005 | ND | |

Pangea

Table 1. Soil Analytical Data - 1187 Solano Ave, Albany, California

| | PCE | TCE | cis-1,2-DCE | Other VOCs | Comments |
|---|-------------|-------------|-------------|------------|----------|
| <i>Residential</i> ESL shallow soil dw (<3 m bgs) Final ESL: | 0.43 | 0.46 | 0.19 | Varies | |
| <i>Residential</i> ESL shallow soil non-dw (<3 m bgs) Final ESL: | 0.43 | 1.1 | 18 | Varies | |
| <i>Residential</i> ESL shallow soil dw&non-dw (<3 m bgs) Direct Exp ESL: | 0.43 | 1.1 | 160 | Varies | |
| <i>Commercial</i> ESL shallow soil dw (<3 m bgs) Final ESL: | 0.7 | 0.46 | 0.19 | Varies | |
| <i>Commercial</i> ESL shallow soil non-dw (<3 m bgs) Final ESL: | 3.4 | 5.9 | 18 | Varies | |
| <i>Residential</i> ESL deep soil dw (>3 m bgs) Final ESL: | 0.57 | 0.46 | 0.19 | Varies | |
| <i>Residential</i> ESL deep soil non-dw (>3 m bgs) Final ESL: | 0.57 | 6.7 | 18 | Varies | |
| <i>Commercial</i> ESL deep soil dw (>3 m bgs) Final ESL: | 0.7 | 0.46 | 0.67 | Varies | |
| <i>Commercial</i> ESL deep soil non-dw (>3 m bgs) Final ESL: | 3.4 | 5.9 | 18 | Varies | |
| <i>Commercial</i> ESL deep soil dw & non-dw (>3 m bgs) Direct Exp. ESL: | 0.57 | 6.7 | 2,000 | Varies | |

| Boring/ Sample ID | Date Sampled | Sample Depth (ft bgs) | ←————— mg/Kg —————→ | | | |
|----------------------|-----------------|--------------------------|---------------------|--|--|--|
|----------------------|-----------------|--------------------------|---------------------|--|--|--|

March and April Borings 2013

| | | | | | | |
|----------|-----------|---------|--------|--------|--------|----|
| B-19-2 | 3/20/2013 | 1.5-2.0 | <0.005 | <0.005 | <0.005 | ND |
| B-19-5 | 3/20/2013 | 4.5-5.0 | 0.013 | <0.005 | <0.005 | ND |
| B-20-2 | 3/20/2013 | 1.5-2.0 | 0.013 | <0.005 | <0.005 | ND |
| B-20-5 | 3/20/2013 | 4.5-5.0 | 0.0085 | <0.005 | <0.005 | ND |
| B-21-5 | 4/25/2013 | 4.5-5.0 | <0.005 | <0.005 | <0.005 | ND |
| B-22-5 | 4/25/2013 | 4.5-5.0 | <0.005 | <0.005 | <0.005 | ND |
| B-23-4.5 | 4/25/2013 | 4.0-4.5 | <0.005 | <0.005 | <0.005 | ND |
| B-23-8.5 | 4/25/2013 | 8.0-8.5 | <0.005 | <0.005 | <0.005 | ND |
| B-24-4.5 | 4/25/2013 | 4.0-4.5 | <0.005 | <0.005 | <0.005 | ND |
| B-25-2.5 | 4/25/2013 | 2.0-2.5 | 0.0071 | <0.005 | <0.005 | ND |
| B-25-5 | 4/25/2013 | 4.5-5.0 | 0.0066 | <0.005 | <0.005 | ND |
| B-26-2.5 | 4/25/2013 | 2.0-2.5 | 0.018 | <0.005 | <0.005 | ND |
| B-26-5 | 4/25/2013 | 4.5-5.0 | 0.0050 | <0.005 | <0.005 | ND |
| B-27-3 | 4/25/2013 | 2.5-3.0 | <0.005 | <0.005 | <0.005 | ND |
| B-27-5 | 4/25/2013 | 4.5-5.0 | <0.005 | <0.005 | <0.005 | ND |
| B-28-2.5 | 4/25/2013 | 2.0-2.5 | <0.005 | <0.005 | <0.005 | ND |
| B-28-5 | 4/25/2013 | 4.5-5.0 | <0.005 | <0.005 | <0.005 | ND |
| B-29-2.5 | 4/25/2013 | 2.0-2.5 | <0.005 | <0.005 | <0.005 | ND |
| B-29-5 | 4/25/2013 | 4.5-5.0 | <0.005 | <0.005 | <0.005 | ND |
| B-30-5 | 4/25/2013 | 4.5-5.0 | <0.005 | <0.005 | <0.005 | ND |

May 2013 Boring (Angled Under Bathroom at 1185 Solano)

| | | | | | | |
|-------|-----------|-----|--------|--------|--------|----|
| A-8-5 | 5/24/2013 | 2.0 | 0.0093 | <0.005 | <0.005 | ND |
|-------|-----------|-----|--------|--------|--------|----|

Explanation:

mg/Kg = milligrams per Kilogram

ft bgs = Depth below ground surface (bgs) in feet.

< n = Chemical not present at a concentration in excess of detection limit shown.

* = Sample location overexcavated.

* = Slab elevation is about 2.5 ft higher in Post Office building than adjacent units at 1185 and 1187 Solano.

-- = Not analyzed or not available.

ESL = Environmental Screening Level for Shallow/Deep Soil with Residential and Commercial/Industrial Land Use, Groundwater is/is not a current or potential source of drinking water. (Table A/Table B/Table C/Table D/Table K-1).

ESL established by the SFBRWQCB, Interim Final - February 2005 and amended in February 2013.

non-dw = groundwater is not a current or potential source of drinking water.

dw = groundwater is a current or potential source of drinking water.

Other VOCs = Volatile Organic Compounds besides PCE, TCE and cis-1,2-DCA by EPA Method 8010.

TCE = Trichloroethane by EPA Method 8010.

PCE = Tetrachloroethene by EPA Method 8010.

cis-1,2-DCE = cis-1,2 - Dichloroethene

Bold concentrations exceed **residential** ESL where groundwater is a current or potential source of drinking water.

ND = Not Detected above laboratory reporting limits.

Pangea

Table 2. Groundwater Analytical Data - 1187 Solano Ave, Albany, California

| | PCE | TCE | cis-1,2-DCE | Other VOCs | Comments | | |
|---|-----------------|--------------------------|--------------------|------------|----------|------|--------------|
| <i>Final</i> ESL for groundwater, dw : | 5.0 | 5.0 | 6.0 | Varies | | | |
| <i>Final</i> ESL for groundwater, non-dw : | 63 | 130 | 590 | Varies | | | |
| <i>Residential</i> ESL GW to Indoor Air: | 630 | 130 | --- | -- | | | |
| <i>Commercial</i> ESL GW to Indoor Air: | 640 | 1,300 | -- | -- | | | |
| Boring/ Sample ID | Date Sampled | Sample Depth (ft bgs) | ←————— μg/L —————→ | | | | |
| 2004 and 2005 Borings | | | | | | | |
| GPA-1 | 4/20/2005 | --- | ND (<1.0?) | ND | ND | ND | |
| GPA-2 | 4/20/2005 | --- | ND (<1.0?) | ND | ND | ND | |
| GPA-3 | 4/20/2005 | --- | ND (<1.0?) | ND | ND | ND | |
| GPA-4 | 4/20/2005 | --- | ND (<1.0?) | ND | ND | ND | |
| GPA-5 | 4/21/2005 | --- | ND (<1.0) | ND | ND | ND | |
| Pangea Assessment 2013 | | | | | | | |
| EX-SE | 2/18/2013 | 9.0 | 93 | <2.5 | <2.5 | ND | |
| EX-N-GW | 2/25/2013 | 9.0 | 8.3 | 1.4 | 0.71 | ND | |
| EX-E-GW | 2/25/2013 | 9.0 | 750 | <25 | <25 | ND | |
| B-16 | 3/8/2013 | 8.5 | 520 | <0.5 | <0.5 | ND | |
| B-17 | 3/8/2013 | 9.0 | 25 | <0.5 | <0.5 | ND | |
| B-18 | 3/20/2013 | 9.0 | 620 | <50 | <50 | ND | |
| B-19 | 3/20/2013 | 9.0 | 440 | <50 | <50 | ND | |
| B-20 | 3/20/2013 | 9.4 | 190 | 7.0 | <0.5 | ND | |
| DB-1 | 3/20/2013 | 30-40 | <0.5 | <0.5 | <0.5 | ND | |
| B-21 | 4/25/2013 | 10.0 | 85 | <2.5 | <2.5 | ND | |
| B-22 | 4/25/2013 | 10.0 | 820 | <50 | <50 | ND | |
| B-23 | 4/25/2013 | 12.0 | <0.5 | <0.5 | <0.5 | ND | |
| B-24 | 4/25/2013 | 12.0 | <0.5 | <0.5 | <0.5 | ND | |
| B-30 | 4/25/2013 | 10.0 | 290 | <10 | <10 | ND | |
| Monitoring Wells | | | | | | | |
| MW-1 | 5/24/2013 | 9-14 | --- | --- | --- | --- | Dry |
| MW-2 | 5/22/2013 | 10-15 | 48 | <1.2 | <1.2 | <1.2 | Little water |
| MW-3 | 5/24/2013 | 9-14 | 92 | 2.9 | <2.5 | <2.5 | Little water |

Explanation:

μg/L = Micrograms per Liter

ft bgs = Depth below ground surface (bgs) in feet.

< n = Chemical not present at a concentration in excess of detection limit shown.

-- = Not analyzed or not available.

ESL = Environmental Screening Level for Groundwater, groundwater is a current or potential source of drinking water. (Table F-1a).

ESL = Environmental Screening Level for groundwater, Groundwater is not a current or potential source of drinking water. (Table F-1b).

ESL = Environmental Screening Level for groundwater to indoor air for residential/commercial land use. (Table E-1).

ESL established by the SFBRWQCB, Interim Final - February 2005 and amended in February 2013.

non-dw = groundwater is not a current or potential source of drinking water.

dw = groundwater is a current or potential source of drinking water.

Other VOCs = Volatile Organic Compounds besides PCE, TCE and cis-1,2-DCA by EPA Method 8010.

TCE = Trichloroethane by EPA Method 8010.

PCE = Tetrachloroethene by EPA Method 8010.

cis-1,2-DCE = cis-1,2 - Dichloroethene

Bold concentrations exceed ESL protective of indoor air (commercial).

ND = Not Detected above laboratory reporting limits.

Pangea

Table 3. Subslab and Soil Gas Analytical Data - 1185 - 1191 Solano Avenue, Albany, California

| Boring/ Sample ID | Date Sampled | Sample Depth (ft bgs) | ug/m ³ | | | | | Helium % | Notes |
|----------------------|-----------------|--------------------------|-------------------------|-----------------------|------------------------|--------------------------|------------|-------------|-------|
| | | | Tetrachloroethene (PCE) | Trichloroethene (TCE) | cis-1,2-Dichloroethene | trans-1,2-Dichloroethene | Other VOCs | | |

SUBSLAB DEPRESSURIZATION SYSTEM

| | | | | | | | | | |
|-------------|---------|-----|--------------|------------|------|------|------|-----|-------------------------|
| INF | 4/8/13 | 0.5 | 5,000 | 510 | <250 | <250 | <250 | --- | Day 3 (1st). 1185N+S&PO |
| INF | 4/10/13 | 0.5 | 4,400 | 290 | <250 | <250 | <250 | --- | Day 5 (1st). 1185N+S&PO |
| INF | 5/2/13 | 0.5 | 1,900 | <250 | <250 | <250 | <250 | --- | Day 4 (2nd). 1185N+S&PO |
| INF-PO | 4/10/13 | 0.5 | 700 | <250 | <250 | <250 | <250 | --- | Day 1 - PO Only Test |
| INF-PO | 4/15/13 | 0.5 | 370 | <250 | <250 | <250 | <250 | --- | Day 5 - PO Only Test |
| INF-V-1185N | 5/13/13 | 0.5 | 1,300 | <250 | <250 | <250 | <250 | --- | Short Test 1185N Only |

SUBSLAB GAS (Immediately Under Concrete Slab)

1185 Solano Avenue

| | | | | | | | | | |
|-------|----------|-----|----------------|---------------|------|------|------------|-------|-------------------------------|
| SS-6 | 01/17/13 | 0.5 | 120,000 | 9,100 | 270 | 71 | See Note A | --- | Before excavation and venting |
| | 04/25/13 | 0.5 | 40,000 | 10,000 | <250 | <250 | <250 | --- | 7 days after vent test end |
| | 05/17/13 | 0.5 | 19,000 | 3,800 | <250 | <250 | <250 | --- | Short test |
| SS-7 | 01/17/13 | 0.5 | 54,000 | 1,600 | 22 | 29 | See Note B | 0.086 | Before excavation and venting |
| | 04/25/13 | 0.5 | 2,000 | <250 | <250 | <250 | <250 | --- | 7 days after vent test end |
| SS-10 | 04/25/13 | 0.5 | <250 | <250 | <250 | <250 | <250 | --- | 7 days after vent test end |

1187 Solano Avenue

| | | | | | | | | | |
|------|----------|-----|----------------|---------------|-------|-------|------------|-------|---------------------------------|
| SS-3 | 01/17/13 | 0.5 | 27,000 | 2,600 | 590 | 92 | See Note C | 0.041 | North - Before excavation |
| SS-4 | 01/17/13 | 0.5 | 770,000 | 60,000 | 2,200 | 1,000 | See Note D | --- | At Former Machine - Before exc. |
| SS-5 | 01/17/13 | 0.5 | 190,000 | 6,300 | 81 | 56 | ND | --- | South - Before excavation |
| SS-9 | 04/25/13 | 0.5 | <250 | <250 | <250 | <250 | <250 | --- | 7 days after vent test end |

1191 Solano Avenue

| | | | | | | | | | |
|---------|----------|-----|--------------|------|------|------|------------|-----|-------------------------------|
| SS-PO-1 | 01/17/13 | 0.5 | 1,100 | 110 | 18 | 90 | See Note E | --- | Before excavation and venting |
| | 04/25/13 | 0.5 | 860 | <250 | <250 | <250 | <250 | --- | 7 days after vent test end |
| SS-PO-2 | 01/17/13 | 0.5 | 760 | 35 | <8.1 | 28 | See Note F | --- | Before excavation and venting |
| | 04/25/13 | 0.5 | <250 | <250 | <250 | <250 | <250 | --- | 7 days after vent test end |
| CSV-1 | 01/17/13 | 0.2 | <14 | <11 | <8.1 | <8.1 | See Note G | --- | Crawl Space |

| | | | | | | |
|------------------------------------|--------------|-------------|-------|---------|--------|----|
| Residential ESL for subslab gas: | 210 | 300 | --- | 31,000 | Varies | NA |
| Commercial ESL for subslab gas: | 2,100 | 3,000 | --- | 260,000 | Varies | NA |
| Residential CHHSL for subslab gas: | 8.24 | 24 | 730 | 1,460 | Varies | NA |
| Commercial CHHSL for subslab gas: | 13.86 | 40.8 | 1,020 | 2,040 | Varies | NA |
| Residential CHHSL for indoor air: | 0.412 | 1.22 | 36.5 | 73 | Varies | NA |
| Commercial CHHSL for indoor air: | 0.693 | 2.04 | 51.1 | 102 | Varies | NA |

Pangea

Table 3. Subslab and Soil Gas Analytical Data - 1185 - 1191 Solano Avenue, Albany, California

| Boring/ Sample ID | Date Sampled | Sample Depth (ft bgs) | ug/m ³ | | | | | Other VOCs | Helium | Notes |
|----------------------|-----------------|--------------------------|-------------------------|-----------------------|------------------------|--------------------------|--|------------|--------|-------|
| | | | Tetrachloroethene (PCE) | Trichloroethene (TCE) | cis-1,2-Dichloroethene | trans-1,2-Dichloroethene | | | | |

SOIL GAS (About 5 feet deep into site soil)

1187 Solano Avenue

| Boring | Date | Depth | PCE | TCE | cis-1,2-DCE | trans-1,2-DCE | Other VOCs | Helium | Notes |
|--------|----------|-------|----------------|---------------|-------------|---------------|------------|--------|---------|
| SG-1 | 11/02/04 | 5.0 | 390 | ND | ND | ND | misc | --- | Outside |
| SG-2 | 11/02/04 | 5.0 | 90,000 | 10,000 | 100 | 390 | misc | --- | |
| SG-3 | 11/02/04 | 5.0 | 100,000 | 7,900 | ND | ND | misc | --- | |
| SG-4 | 11/02/04 | 5.0 | 170,000 | 5,500 | ND | ND | misc | --- | |

| | | | | | | |
|---|------------|--------------|--------|---------|--------|----|
| Residential CHHSL for shallow soil gas: | 180 | 528 | 15,900 | 31,900 | Varies | NA |
| Commercial CHHSL for shallow soil gas: | 600 | 1,770 | 44,400 | 88,700 | Varies | NA |
| Residential ESL for shallow soil gas: | 210 | 300 | --- | 31,000 | Varies | NA |
| Commercial ESL for shallow soil gas: | 2,100 | 3,000 | --- | 260,000 | Varies | NA |

Abbreviations:

Tetrachloroethene, Trichloroethene, cis-1,2-Dichloroethene, trans-1,2-Dichloroethene, and Helium analyzed by Method TO-15.

Other VOCs = Volatile Organic Compounds except for Tetrachloroethene, Trichloroethene, cis-1,2-Dichloroethene, trans-1,2-Dichloroethene and Helium analyzed by Method TO-15.
 ug/m³ = Micrograms per cubic meter of air.

ft bgs = Depth interval below ground surface (bgs) in feet.

NA= not applicable

ND = not detected above laboratory reporting limits.

< n = Chemical not present at a concentration in excess of detection limit shown.

CHHSL = California Human Health Screening Levels for Soil Gas below buildings constructed without engineered fill below sub-slab gravel with Commercial/Industrial Land Use Updated 9/23/2010. <http://oehha.ca.gov/risk/chhsltable.html>

CHHSL (subslab) = California Human Health Screening Levels for subslab gas has an attenuation factor of 0.05 of indoor air screening levels per CalEPA/DTSC Vapor Intrusion Guidance Document, October 2011 (p 21).

ESL = Environmental Screening Level for Soil Gas with Commercial Land Use, Groundwater is/is not a current or potential source of drinking water (Table A-2, Table B-2). Established by the SFBRWQCB, Interim Final - November 2007 (Revised Feb 2013).

Tetrachloroethene also referred to as Perchloroethene, PCE or Perc.

Bold concentrations exceed **commercial** CHHSL.

Note A: 7.2 ug/m³ benzene and 13 ug/m³ chloroform

Note B: 7.2 ug/m³ tetrahydrofuran and 32 ug/m³ ethyl acetate

Note C: 23 ug/m³ chloroform

Note D: 28 ug/m³ benzene, 80 ug/m³ chloroform, and 49 ug/m³ 1,1-dichloroethene

Note E: 8.1 ug/m³ tetrahydrofuran and 9.1 ug/m³ vinyl chloride

Note F: 210 ug/m³ ethanol and 14 ug/m³ tetrahydrofuran

Note G: 290 ug/m³ 4-methyl-2-pentanone and 19 ug/m³ toluene (likely associated with building materials).

APPENDIX A

Standard Operating Procedures

STANDARD FIELD PROCEDURES FOR HAND-AUGER SOIL BORINGS

This document describes Pangea Environmental Services' standard field methods for drilling and sampling soil borings using a hand-auger. These procedures are designed to comply with Federal, State and local regulatory guidelines. Specific field procedures are summarized below.

Objectives

Soil samples are collected to characterize subsurface lithology, assess whether the soils exhibit obvious hydrocarbon or other compound vapor odor or staining, estimate ground water depth and quality, and to submit samples for chemical analysis.

Soil Classification/Logging

All soil samples are classified according to the Unified Soil Classification System by a trained geologist or engineer working under the supervision of a California Registered Geologist (RG), Certified Engineering Geologist (CEG), or Professional Engineer. The following soil properties are noted for each soil sample:

- Principal and secondary grain size category (i.e. sand, silt, clay or gravel)
- Approximate percentage of each grain size category,
- Color,
- Approximate water or product saturation percentage,
- Observed odor and/or discoloration,
- Other significant observations (i.e. cementation, presence of marker horizons, mineralogy), and
- Estimated permeability.

Soil Boring and Sampling

Hand-auger borings are typically drilled using a hand-held bucket auger to remove soil to the desired sampling depth. Samples are collected using lined split-barrel or equivalent samplers driven into undisturbed sediments beyond the bottom of the augered hole. The vertical location of each soil sample is determined using a tape measure. All sample depths use the ground surface immediately adjacent to the boring as a datum. The horizontal location of each boring is measured in the field from an onsite permanent reference using a measuring wheel or tape measure.

Augering and sampling equipment is steam-cleaned or washed prior to drilling, between samples and between borings to prevent cross-contamination withalconox/liquinox or an equivalent EPA-approved detergent.

Sample Storage, Handling and Transport

Sampling tubes chosen for analysis are trimmed of excess soil and capped with Teflon tape and plastic end caps. Soil samples are labeled and stored at or below 4°C on either crushed or dry ice, depending upon local regulations. Samples are transported under chain-of-custody to a State-certified analytic laboratory.

Field Screening

One of the remaining tubes is partially emptied into a re-sealable plastic bag. The bag of soil is placed in the sun to allow hydrocarbons to volatilize from the soil. After ten to fifteen minutes, a portable photoionization detector (PID) measures volatile hydrocarbon vapor concentrations in the bag headspace, extracting the vapor through a slit in the bag. PID measurements are used along with the field observations, odors, stratigraphy and ground water depth to select soil samples for analysis.

Water Sampling

Water samples, if they are collected from the boring, are collected from screened PVC casing installed in the hole or from the open borehole using bailers. The ground water samples are decanted into the appropriate containers supplied by the analytic laboratory. Samples are labeled, placed in re-sealable plastic bags, stored on crushed ice at or below 4°C, and transported under chain-of-custody to the laboratory.

Duplicates and Blanks

Blind duplicate water samples are usually collected only for monitoring well sampling programs, at a rate of one blind sample for every 10 wells sampled. Laboratory-supplied trip blanks can be used to check for cross-contamination caused by sample handling and transport. These trip blanks are analyzed if the internal laboratory QA/QC blanks contain the suspected field contaminants. An equipment blank sample may also be analyzed if non-dedicated sampling equipment is used.

Grouting

The borings are filled to the ground surface with cement grout poured or pumped through a tremie pipe.

Waste Handling and Disposal

Soil cuttings from drilling activities are usually stockpiled onsite on top of and covered by plastic sheeting. At least four individual soil samples are collected from the stockpiles for later compositing at the analytic laboratory. The composite sample is analyzed for the same constituents analyzed in the borehole samples. Soil cuttings are transported by licensed waste haulers and disposed in secure, licensed facilities based on the composite analytic results.

Ground water removed during sampling and/or rinsate generated during decontamination procedures are stored onsite in sealed 55-gallon drums. Each drum is labeled with the drum number, date of generation, suspected contents, generator identification and consultant contact. Disposal of the water is based on the analytic results for the well samples. The water is either pumped out using a vacuum truck for transport to a licensed waste treatment/disposal facility or the individual drums are picked up and transported to the waste facility where the drum contents are removed and appropriately disposed.

STANDARD OPERATING PROCEDURE FOR SUBSLAB VAPOR SAMPLING

1.0 PURPOSE

This standard operating procedure (SOP) describes the procedures for collecting subslab vapor samples using evacuated stainless-steel Summa canisters for the purpose of assessing risk to building occupants. The SOP is modified from procedures and information presented in Cal/EPA 2012 (*Advisory-Active Soil Investigations*); Cal/EPA 2011; Cal/EPA 2010; U.S. EPA, 2006; and DiGiulio, 2003. This SOP includes (a) real-time leak-check procedures to evaluate integrity of the soil gas probe and sampling assembly during probe purging and post sampling, and (b) real-time field screening of soil gas concentrations during probe purging and post sampling.

2.0 REQUIRED EQUIPMENT

- Hammer drill with 1” bit and smaller bits (slightly larger than vapor probe tubing)
- Tubing for cleaning boring
- Stainless-steel or Teflon vapor probe tubing with Swagelok threaded compression fitting, vapor-tight cap, and valves.
- Rubber stopper or Teflon disk
- Granulated bentonite, bentonite pellets and cement
- Vacuum pump with adjustable rotameter for purging and leak testing
- 1-Liter Summa canister for each sample
- Stainless-steel sampling manifold with vacuum gauges and critical orifice flow restrictor (request that laboratory leak-check sampling manifold prior to mobilization)
- Leak-check compound (e.g. helium)
- Helium gas analyzer (calibrated)
- Calibrated photoionization detector (PID) or other organic vapor analyzer
- Isobutylene for PID calibration
- Tedlar bags (for helium measurement and vapor screening)
- Vacuum chamber (iron lung) for pre- and post-sampling leak-check
- Leak-check enclosure (bucket with hydrated bentonite pellets [or weather stripping] for sealing enclosure to surface and openings for vapor probe tubing, helium and for sampling enclosure atmosphere)
- Recordkeeping materials
- Latex or nitrile gloves

3.0 PROCEDURES

3.1 Boring Clearance

Prior to installing subslab vapor probes, ensure that a utility clearance has been conducted to ensure that potential subsurface utility and rebar locations have been identified and marked.

3.2 Vapor Probe Construction

1. To protect interior surfaces, lay plastic sheeting around the probe location.
2. Use a rotary hammer drill to create an approximately 3-inch deep, 1 1/2 -inch diameter hole that *partially* penetrates the slab. Use a piece of flexible tubing to blow or vacuum concrete debris and dust from the hole. Do not blow or vacuum after the slab has been completely penetrated.
3. Drill a smaller diameter *inner hole* in the center of the outer hole, periodically blowing dust and debris from the hole until the slab is penetrated. The diameter of the inner hole should exceed the diameter of the vapor probe tubing by the minimum amount practicable. The inner hole should be drilled completely through the slab and 3 to 4 inches into the subslab material (baselock or soil) to form a cavity (**Figure 1**).
4. Insert the capped vapor probe tubing through a tightly fitting rubber stopper or a Teflon disk and insert the stopper or disk into the bottom of the outer hole. The purpose of the stopper is to stop moisture from the annular seal from leaking into subslab materials. The fitting may either be constructed flush, or may protrude above the slab, depending on location and susceptibility to damage. If a lubricant is needed, use only high-vacuum silicone grease.
5. Clean the concrete surfaces in the borehole with a dampened towel to increase the potential of a good seal. Fill the remainder of the hole with hydrated bentonite (temporary probe) or hydrated bentonite topped with expanding cement (semi-permanent probe). Place a protective cap (temporary probe) or flush mounted well box (semi-permanent probe) over the probe to protect it from damage.

3.3 Vapor Sampling

During vapor sampling, record all valve open/close times and canister/manifold vacuum readings at each step. Do not conduct sampling within **5 days following a significant rain event** (0.5 inches of rainfall during any 24-hour period) or significant irrigation adjacent to the building.

Setup

1. Calculate and record the volume of the sampling assembly, tubing, vapor probe and void space created in subslab material.
$$\text{Volume} = \pi * r^2 * L = 3.14 * (1/2 * \text{ID})^2 * L,$$
where ID = cavity, tubing or manifold inside diameter and L = length of cavity or tubing/manifold segment.
2. Wear latex or nitrile gloves while handling sampling equipment. Change gloves whenever a new sample is collected and after handling leak-check compound.
3. Replace the vapor probe cap with a closed Swagelok valve. Connect the sampling manifold to the vapor probe, sample Summa canister and vacuum pump using Swagelok fittings and stainless-steel, Teflon or Tygon tubing. Check all fittings for tightness (do not overtighten).
4. Close all valves. Record pre-test vacuum readings on summa canister.

Manifold Shut-In Check

1. Open valve on vapor sampling manifold and open 3-way valve #1 so the vacuum pump of the purging assembly can evacuate the vapor sampling manifold assembly (keep valves #2 and #3 closed to the Tedlar bag/vacuum chamber of the vapor screening assembly) (**Figure 2**). Start the vacuum pump. Do *not* open #1 valve to the probe assembly, or the valve on the sample Summa canister. Allow manifold/tubing vacuum to stabilize at approximately 10" Hg.
2. Stop the vacuum pump, close 3-way valves #2 and #3 (to allow shut-in testing of vapor sampling manifold), and conduct a shut-in test by waiting at least **5 minutes** (if using 150 inches of water gauge) or **10 minutes** (if using 30 inches of mercury gauge). Monitor manifold vacuum gauge to test for leaks. If the vacuum decreases, rectify the leak before proceeding.

Purge, Flow and Leak Check

1. **Calculate purge volume and duration.** Determine the desired total purge volume and purging duration for the equipment setup. A critical orifice flow restrictor is intended to limit the maximum purge and sampling flow rate (approximately 150 ml/min). If step testing is not required to better determine optimal purge volume, **purge approximately 3 times** the volume of the sampling assembly, tubing, vapor probe and void space or any probe/filter pack material below the concrete slab.
2. **Leak-check enclosure.** Place leak-check enclosure over vapor probe and seal to floor using hydrated bentonite or weather stripping. Introduce helium gas into the leak-check enclosure and monitor with the helium gas analyzer until it reads between 20% and 30% helium.
3. **Conduct purging.** Start vacuum pump and open 3-way valve #1 (and 3-way valves #2 and #3) so the vacuum pump can evacuate the probe. Do *not* over-purge. Closely monitor the flow on the rotameter and the vacuum on the vacuum gauge. For most samples flow should be limited to 150mL/min or less. If the vacuum remains below approximately 7" Hg, then sufficient flow is present to collect a representative sample (Cal/EPA 2012) and continue purging for the planned purge duration.
4. If the probe-side vacuum exceeds approximately 7" Hg, then insufficient flow may be present to collect a representative sample and this condition should be noted. Evaluate probe integrity or consider re-installation of probe, especially if probe installed in coarse-grain material. If no significant flow is attained, the sampling line may be plugged or the vapor probe may be positioned in a low permeability or saturated layer. If the probe cap is opened for probe inspection, record the inspection procedures and duration. If purging and sampling is resumed after opening the probe cap, this information will help determine the representativeness of the sample. **To sample subslab gas under low flow conditions, follow this alternate sampling method** derived from Appendix D, Cal/EPA 2012. Make a reasonable attempt to purge one purge volume. After purging, open sample Summa canister until sampling manifold vacuum threshold is achieved, then close Summa sample valve until probe vacuum dissipates. Repeat this sampling procedure as necessary to sufficiently fill the sample Summa canister. Alternatively, consider installing a subslab gas probe with a larger probe annulus space, or employing passive soil gas sampling methods.
5. When purge duration complete and ready to discontinue purging, close 3-way valve #1 so that the probe is connected to the sampling manifold, and then stop the vacuum pump.

6. Record helium reading for leak-check enclosure at least once every minute during purging and sampling.

Sample Collection

1. **Opening Sample Canister.** Once a helium reading of at least 20% has been reached, open sample canister valve. **Sampling takes approximately 5 minutes for a 1-liter Summa canister** (at 150 ml/min sampling flow rate).
2. Close sampling canister valve when vacuum decreases to 5" mercury. Do *not* allow vacuum to fall below this range.
3. **Post-Sample Vapor Screening.** After sampling, open 3-way valve #1 so that the vapor screening assembly is connected to the probe, turn on the vacuum pump, and open 3-way valves #2 and #3 to partially fill the Tedlar bag within the vacuum chamber (iron lung). When Tedlar bag is sufficiently filled, return valves #2 and #3 to purging position. Check Tedlar bag for indication of sampling leakage using the helium gas analyzer. If helium concentration is below 1% then sample is sufficiently representative. If helium concentration is above 1%, then the sample may not be sufficiently representative; the probe may need to be repaired or re-installed and re-sampled. Additionally, check the Tedlar bag for contaminants using the PID for qualitative contaminant assessment (optional).
4. **Shroud Sample.** To confirm helium meter readings collect one shroud sample per day to analyze for percent helium. Connect the shroud sample summa canister and manifold to a port near the bottom of the shroud and open the canister valve at the beginning of sampling. Close sampling canister valve when vacuum decreases to 5" mercury. Do *not* allow vacuum to fall below this range. Disassemble sampling assembly, and cap (or remove and restore) vapor sampling point.
5. **Analyses.** Fill out chain-of-custody form for analysis for **chemicals of concern (i.e. TO-15)**, and for **leak-check compound** for at least 10% of samples. Analyze all samples for **percent oxygen** by ASTM D1946-90. Additionally, samples may be analyzed for **percent methane and carbon dioxide** by ASTM D1946-90 when in support of sensitive human health risk assessments for regulatory review. Include final vacuum reading and serial numbers of canister and flow restrictor on chain-of-custody form.
6. For vapor sampling in support of sensitive human health risk assessments for regulatory review, collect at least one *duplicate* sample per site per sampling event from the sampling point with the anticipated highest vapor concentrations. The duplicate sample should be collected by attaching a fresh sample canister following collection of the initial sample. If a new manifold is used, follow the same purging and sampling procedures used for the original sample. If the same manifold is used, collect a sample without further purging, using the same sampling procedures used for the original sample.

Decontamination and Decommissioning

1. Use a decontaminated sampling manifold and new tubing for each sample location. Return equipment to laboratory for decontamination.
2. Backfill any open soil vapor probe holes with bentonite slurry or Portland cement and cap with concrete or other surface material to match the area.
3. To retain the subslab probe for future sampling, cap the Swagelock fitting and cover the probe with a small vault or other protective device.

REFERENCES

- Cal/EPA, 2012, Advisory-Active Soil Gas Investigation, California Environmental Protection Agency, Department of Toxic Substances Control, Los Angeles Regional Water Quality Control Board, San Francisco Regional Water Quality Control Board, April.
- Cal/EPA, 2011, Guidance for the evaluation and mitigation of subsurface vapor intrusion to indoor air (vapor intrusion guidance), California Environmental Protection Agency, Department of Toxic Substances Control, October).
- Cal/EPA, 2004, Interim final guidance for the evaluation and mitigation of subsurface vapor intrusion to indoor air, California Environmental Protection Agency, Department of Toxic Substances Control, December 15 (revised February 7, 2005).
- U.S. EPA, 2006, Office Of Research and Development, National Risk Management Research Laboratory, Cincinnati, OH, Assessment of vapor intrusion in homes near the Raymark Superfund Site using basement and sub-slab air samples, March.
- Dominic DiGiulio, 2003, Standard Operating Procedure (SOP) for installation of sub-slab vapor probes and sampling using EPA Method TO-15 to support vapor intrusion investigations, U.S. Environmental Protection Agency, Office of Research and Development, National Risk Management Research Laboratory, Ground-Water and Ecosystem Restoration Division, Ada, Oklahoma (included as Appendix C of Colorado Department of Public Health and Environment, 2004, Draft Indoor Air Guidance, Hazardous Materials and Waste Division), September.

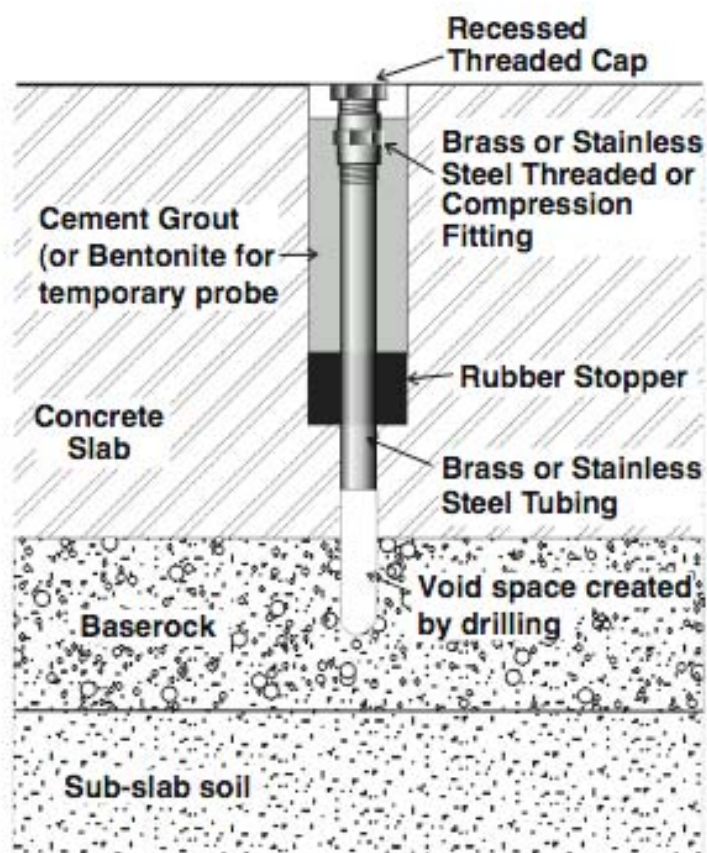



Figure
1

Subslab Vapor Probe Schematic



EXPLANATION

-  Vacuum Gauge
-  Three Way Valve
-  Valve
-  Swagelok Fitting
-  Air Tight Fitting

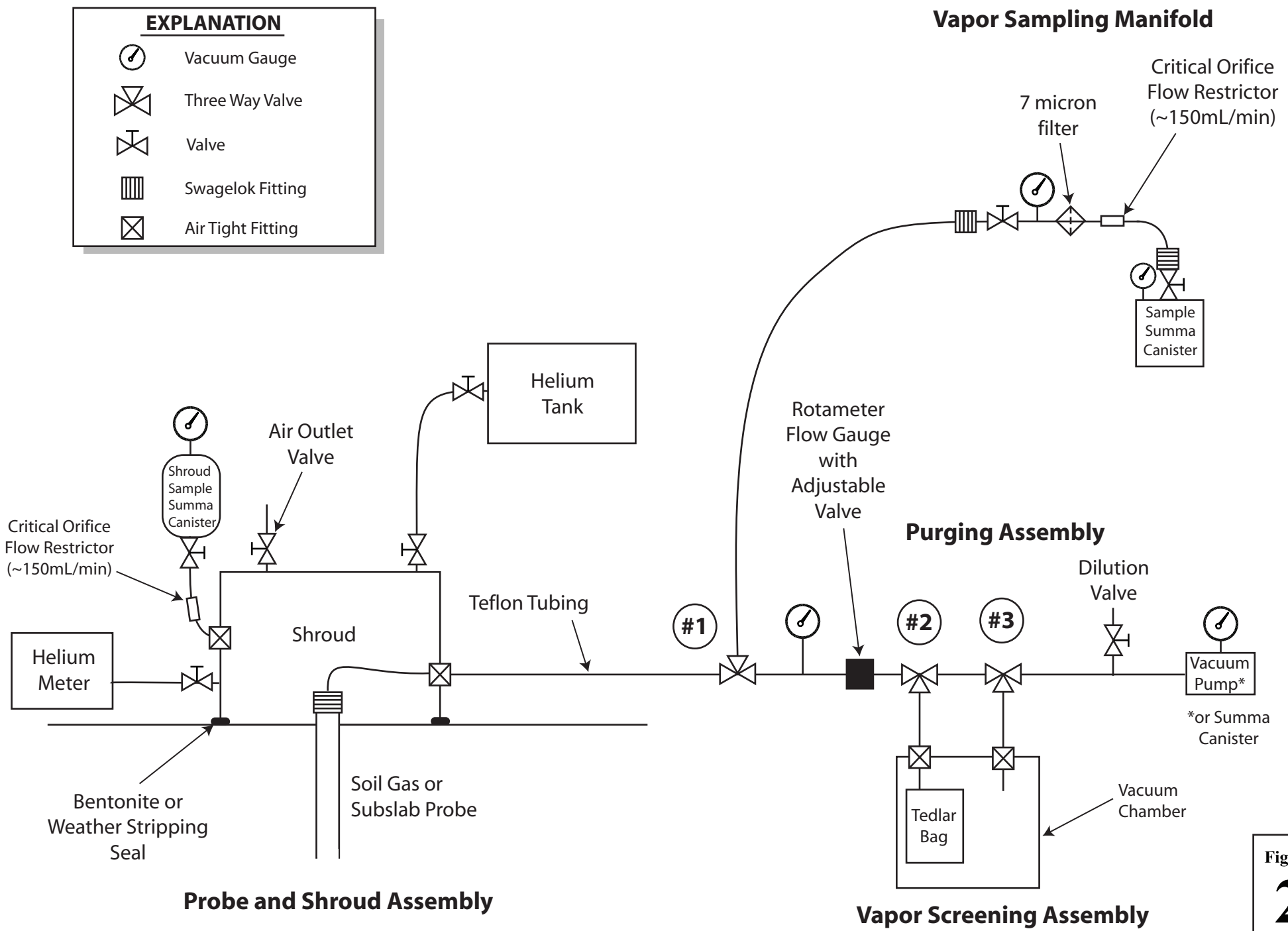

Figure 2