

RECEIVED

By loprojectop at 8:35 am, Dec 02, 2005

W A R E H A M D E V E L O P M E N T

30 November 2005

Barney Chan
Hazardous Materials Specialist
Alameda County Health Care Services Agency
1131 Harbor Bay Parkway, 2nd Floor
Alameda, CA 94502

Subject: Certification Letter
Written Response to Letter Dated 28 October 2005 and Work Plan for
Post-Excavation Soil and Groundwater Sampling
5885 Hollis Street
Emeryville, California

Dear Mr. Chan:

Per your request, the attached letter from Treadwell & Rollo provides the written response to the Alameda County Environmental Health (ACEH) technical comments dated 28 October 2005 to the *Site Management Plan* (SMP) dated 14 July 2005 prepared by Treadwell & Rollo. The SMP and the attached written response letter have been prepared on behalf of the current property owner E S East Associates, LLC, an affiliate of Wareham Development, the developer of the proposed project.

I declare, under penalty of perjury, that the information and/or recommendations contained in the attached document or report is true and correct to the best of my knowledge.

If you have any questions, please call me at (415) 457-4964.

Sincerely yours,

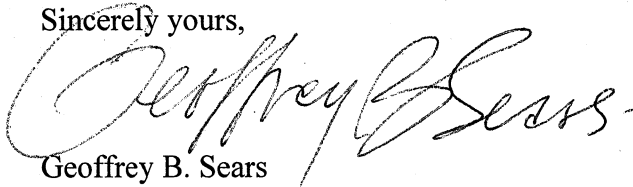

Geoffrey B. Sears
Wareham Development
For: E S East Associates, LLC

30 November 2005
Project 4069.01

Treadwell&Rollo

Barney Chan
Hazardous Materials Specialist
Alameda County Health Care Services Agency
1131 Harbor Bay Parkway, 2nd Floor
Alameda, CA 94502

RECEIVED

By loprojectop at 8:35 am, Dec 02, 2005

Subject: Response to Letter Dated 28 October 2005 and Work Plan
for Post-Excavation Soil and Groundwater Sampling
5885 Hollis Street
Emeryville, California

Dear Mr. Chan:

Per your request, this letter is the written response to the Alameda County Environmental Health (ACEH) technical comments dated 28 October 2005 to the *Site Management Plan (SMP)* dated 14 July 2005 prepared by Treadwell & Rollo on behalf of E S East Associates, LLC, an affiliate of Wareham Development, the developer of the property, as well as the *Clarification of Site Management Plan* dated 21 October 2005. Although the ACEH letter was addressed to Marks Management, future correspondence should be addressed to:

Geoffrey Sears
E S East Associates, LLC, an affiliate of Wareham Development
1120 Nye Street, Suite 400
San Rafael, CA 94901

The subject property (Figure 1, included in Attachment 1) has been referred to as the Emeryville Industrial Court, the 5885 Hollis Street property and the Emerystation East development. For this letter, the property and development are referred to as the Site. Figure 2 (included in Attachment 1) presents the Site Plan, which outlines the current building configurations.

This letter and associated attachments addresses the ACEH technical comments and includes information related to the historical activities at the Site and nearby off-site sources of contamination. Because the historical Site activities and nearby off-site sources form the basis for soil and groundwater sampling, this letter also presents the proposed post-excavation soil sampling and conceptual sampling for groundwater. Attachment 1 includes the figures referenced in this letter. Attachment 2 includes historical aerial photos and Sanborn historical maps requested in the 28 October 2005 ACEH letter.

COMMENT 1 - DEVELOPMENT CLARIFICATION

We consulted with DPR, the general contractor for the proposed construction, for specifics regarding development assumptions. Our letter of 21 October 2005 was correct, indicating that the excavation depth for the foundation will be to approximately 14 feet below ground surface (bgs), although the final excavation depth will vary slightly because the property is not perfectly flat and there are construction features that require slightly deeper excavations, such as elevator

Barney Chan
Hazardous Materials Specialist
Alameda County Health Care Services Agency
30 November 2005
Page 2 of 9

pits (up to 5 feet deeper), thickened sections of the slab for the parking level (up to 1 foot deeper) and installation of drain rock (up to about 1 foot deeper).

The foundation design will be a mat, which will preclude the use of piles. Since shallow groundwater has been encountered between 9 and 14 feet bgs, the entire foundation will be below the shallow groundwater, requiring the installation of the membrane-based waterproofing proposed in Section 5.2.2 of the SMP. The deepest planned excavation for the elevators will be no deeper than approximately 19 feet bgs. This final depth is within the depths of the reported shallow groundwater in the near vicinity of the Site. As noted in Section 5.5.1 of the SMP, construction-phase dewatering will be required during the soil excavation and foundation construction. Therefore, the foundation excavation and construction, including the construction-phase dewatering and the associated membrane-based waterproofing should not provide a pathway for vertical migration of contamination.

COMMENT 2 – IDENTIFICATION OF OFF-SITE SOURCES

Comment 2 of the 28 October 2005 ACEH letter indicates that in addition to potential sources of residual chemicals in soil and groundwater at the Site, there are several known nearby off-site sources of chemicals in soil and groundwater which include the following.

- The Former Westinghouse Site, located directly west of the Site across Peladeau Street
- The Former Tosco/Unocal Gasoline Service Station located directly south of the Site
- Subsurface contamination detected as part of the 59th Street Widening.

These three primary off-site sources are discussed below along with an evaluation of the potential for contamination to spread through the proposed on-site soil excavation and dewatering activities.

The Former Westinghouse Site

The Former Westinghouse Site was a former electrical transformer servicing facility that has since been redeveloped and is currently occupied by the Emerystation office building. Primary chemicals at the Westinghouse Site included polychlorinated biphenyls (PCBs) in soil. During the construction of the Emerystation office building, excavation of PCB-affected soil and other mitigation activities were conducted under the oversight of ACEH. PCBs are relatively insoluble and not very mobile.

The Site development activities are not expected to have an impact on any residual PCB contamination at Emerystation office building. Soil excavation for the Site foundation

Barney Chan
Hazardous Materials Specialist
Alameda County Health Care Services Agency
30 November 2005
Page 3 of 9

construction will not have an impact. Due to the low mobility of PCBs, construction-phase dewatering and treatment should not have an impact on residual PCBs in soil at the Emerystation office building.

The Former Tosco/Unocal Gasoline Service Station

The gasoline service station located directly south of the Site at 1400 Powell Street, has been referred to in various documents as the former TOSCO 76 Service Station, the Unocal Service Station and the Chevron Service. In 1999, a waste oil underground storage tank (UST) was removed from the property under the oversight of the ACEH (TRC Alton Geoscience, 1999). Soil samples collected during the waste oil tank removal indicated total petroleum hydrocarbons as gasoline (TPHg) up to 470 milligrams per kilogram (mg/kg), total petroleum hydrocarbons as diesel (TPHd) up to 1,100 mg/kg, total petroleum hydrocarbons as motor oil (TPHmo) up to 1,100 mg/kg, and benzene up to 300 micrograms per kilogram ($\mu\text{g}/\text{kg}$).

Three 10,000-gallon USTs (containing gasoline and diesel and located near the center of the service station, but southwest of the waste oil UST), were present in 1999 and are reportedly currently used at the service station. A grab groundwater sample collected near the northern end of the three active USTs indicated TPHg at 4,400 micrograms per liter ($\mu\text{g}/\text{L}$), TPHd at 2,600 $\mu\text{g}/\text{L}$, benzene at 520 $\mu\text{g}/\text{L}$, and methyl-tert-butyl ether at 1,300 $\mu\text{g}/\text{L}$.

In addition to residual chemical contamination from service station operations, the gasoline service station was also part of the Union Oil of California distribution facility. According to the 1952 Sanborn Map of the area (Attachment 2), the service station property included multiple aboveground storage tanks at the western edge of the property along Peladeau Street, including a 5,000-barrel (210,000 gallon) gasoline tank, a 7,000-barrel (294,000 gallon) fuel oil tank, and six 20,000 gallon oil tanks. The gasoline tank and some of the oil tanks were located along the border between the Site and the gasoline service station. The berm surrounding the multiple tanks previously extended over to the Site area. An oil warehouse was located along the west side of the property along Hollis Street.

No information is currently available regarding the potential impacts to soil and groundwater of the former Union Oil of California operations to the service station. As noted in the SMP, residual TPHg up to 150,000 $\mu\text{g}/\text{L}$ and benzene up to 4,300 $\mu\text{g}/\text{L}$ have been detected in grab groundwater samples collected from the southern edge of the Site. The presence of TPHg and benzene may be due to the service station operations and/or due to the former Union Oil of California operations.

The Site development activities may have an impact on the residual contamination at the service station. Soil excavation for the foundation construction will not have an impact alone. Construction-phase dewatering and treatment will be conducted, as required in Section 5.5.1 of the SMP. Although the general groundwater gradient in the area has been reported to be to the

Barney Chan
Hazardous Materials Specialist
Alameda County Health Care Services Agency
30 November 2005
Page 4 of 9

west, the construction-phase dewatering will draw groundwater from the service station toward the Site, possibly causing more of the TPHg, benzene, and other associated chemicals in groundwater to move towards the Site. However, the extracted water will be treated prior to discharge. Thus, the dewatering and treatment will reduce the overall mass of TPHg, benzene and other associated chemicals in the subsurface at both the Site and the service station.

Subsurface Contamination Detected as Part of the 59th Street Widening

In 1999, the City of Emeryville widened a portion of 59th Street, as well as acquired a portion of the Site, both areas located along the northern edge of the Site. Soil samples collected in 1999 indicated soils at a depth of approximately 2 to 4 feet bgs had TPHd detected up to 13,000 mg/kg and TPH as motor oil (TPHmo) detected up to 15,000 mg/kg. No benzene or TPH as gasoline were detected in soil samples. Approximately 18 tons of petroleum-affected soil was removed and disposed off-site as part of the street widening. Additional documentation of residual concentrations of petroleum-affected soils in the subsurface is not available, although soil samples collected by Treadwell & Rollo in April 2000 (Section 3.1.1 of the SMP) approximately 100 feet from the street widening area indicated TPHmo detected at 6,600 mg/kg at location TR-1 at a depth of 5 feet below ground surface, with no detection at a depth of 9 feet below ground surface. Grab groundwater collected at TR-1 indicated no detection TPHmo. No apparent source of the TPHmo has been identified, although the area near TR-1 and the area around the 59th Street widening were in the general vicinity of the former Union Oil of California Auto Repair Shop.

Other than potential excavation of the TPH-affected soils, the Site development activities are not likely to have an impact on the residual contamination in the area of the 59th Street widening. Soil excavation for the foundation construction will result in removal of the TPH-affected soils in the area. Construction-phase dewatering and treatment, as required in Section 5.5.1 of the SMP, will likely change the local shallow groundwater gradient temporarily, but the TPHmo in soil has been reported at depths above the shallow groundwater table.

COMMENT 3, 4 AND 5 – HISTORICAL AERIAL PHOTOS, FIGURE OVERLAYS, AND SITE CHARACTERIZATION

Historical Aerial Photos and Sanborn Maps

Historical aerial photos (Comment 3) and Sanborn maps (Comment 4) are included in Attachment 2 to this letter. Aerial photos provided by Environmental Data Resources (EDR) included those for 1939, 1946, 1958, 1965, 1982, 1993 and 1998. Sanborn maps provided by EDR included those for 1911, 1951, 1952, 1967 and 1969. In addition to the aerial photos and Sanborn maps, the Site configuration from the 1995 Environmental Site Assessment (ESA) prepared by Weiss Associates is presented in Figure 3 (Comment 5). The current site

Barney Chan
Hazardous Materials Specialist
Alameda County Health Care Services Agency
30 November 2005
Page 5 of 9

configuration is not significantly different than that depicted in Figure 3 (included in Attachment 1).

The aerial photos, Sanborn maps, and available site historical information indicate that significant changes in Site land use occurred before 1917 and after 1964. Prior to 1917, the Site was apparently vacant, as confirmed by the 1911 Sanborn Map.

Union Oil of California occupied the Site and the gasoline service station to the south of the Site between 1917 and 1964. Sanborn Maps from 1951 and 1952, as well as aerial photos from 1939 and 1946 confirm the presence of multiple potential sources of petroleum contamination at the Site and gasoline service station, including aboveground storage tanks along Peladeau Street, including a 5,000-barrel (210,000 gallon) gasoline tank, a 7,000-barrel (294,000 gallon) fuel oil tank, and six 20,000 gallon oil tanks. The gasoline tank and some of the oil tanks were located along the border between the Site and the gasoline service station. The berm surrounding the multiple tanks previously extended over to the Site area. An oil warehouse was located along the west side of the property along Hollis Street. A loading rack was present Peladeau Street. An auto repair shop was located along Peladeau Street and a garage was present along Hollis Street. Figure 4 (included in Attachment 1) presents an overly of the 1995 site features and the 1951 Sanborn Map (Comment 4).

The 1965 and 1967 Sanborn map and the 1965 aerial photo indicate that the tanks and other oil handling operations by Union Oil were not present at the Site, but that the long buildings constructed parallel to Hollis and Peladeau Street remained. Aerial photos from 1982 and 1993 indicate the additional presence of the Site building along southern border of the Site, as well as the gasoline service station at 1400 Powell Street.

Additional Site Characterization Information

In addition to the potential impacts to the Site from the Union Oil of California operations, several on-site chemicals were identified during a site visit in 1995, as documented in the 1995 Phase II ESA (Weiss Associates). The locations and site features that included chemical use are presented on Figure 3 and also discussed below:

- BMP Seismic Retrofitting – located at 5847 Hollis Street and identified as Tenant 2 on Figure 3. Paints and thinners were observed at this location.
- Graphic Traffic – located at 5845 Hollis Street and identified as Tenant 3 on Figure 3. Inks, paints and solvents used in the sign production activities were observed at this location.

Barney Chan
Hazardous Materials Specialist
Alameda County Health Care Services Agency
30 November 2005
Page 6 of 9

- Canova Marble – located at 5835 Hollis Street and identified as Tenant 4 on Figure 4. Paints and adhesives used in the marble installation activities were observed at this location
- S.B. Thomas – located at 5805 Hollis Street and identified as Tenant 5 on Figure 3. A former 10,000 gallon gasoline UST, used to fuel vehicles for the distribution facility, was located approximately in the middle of the yard. This UST was reportedly removed in 1990.
- Correris Cabinets – located at 5830 Peladeau Street and identified as Tenant 8 on Figure 3. Paints and associated finishing materials were stored in paint storage cabinets located in the yard area.
- Fleetcare Repair – located at 5850 Peladeau Street and identified as Tenant 9 on Figure 3. Two 3,000 gallon waste oil aboveground storage tanks (ASTs) were used to store oil from the vehicle maintenance activities. The waste oil was eventually transferred to the waste oil AST located in the yard behind the 5850 Peladeau space.
- Ellerson Weaver – located in the yard area of 5858 Peladeau Street and identified as Tenant 11 on Figure 3. Several 55-gallon drums were observed outside of the fenced salvage storage area.
- Subsurface contamination detected as part of the 59th Street Widening – the approximate location of the TPHd and TPHmo detected in subsurface soil was located along 59th Street.

As noted in the SMP, soil and groundwater investigations conducted by Treadwell & Rollo indicated TPHg was detected in soil and groundwater near the southwest corner of the Site at TR-23, TR-24 and TR-25 (Figure 5). At TR-25, TPHg was detected at 2,100 mg/kg at 6 feet bgs. The grab groundwater samples collected from TR-25 had TPHg at 150,000 µg/L and benzene at 2,500 µg/L. The grab groundwater samples collected from borings TR-23 and TR-24 indicated the presence of TPHd at 8,400 µg/L and 6,800 µg/L, respectively. TPHg was detected at 28,000 µg/L at TR-23 and 91,000 µg/L at TR-24. Benzene was also detected at 4,300 µg/L in TR-23 and 2,500 µg/L in TR-24. These three locations are near the former 5,000-barrel (210,000 gallon) gasoline AST associated with the former Union Oil of California operations. At this time, it is unclear whether the presence of TPHg and benzene at this area of the Site is due to the current and/or previous gasoline service station activities at 1400 Powell Street or due to the Union Oil of California operations across both the Site and the gasoline service station property.

Barney Chan
Hazardous Materials Specialist
Alameda County Health Care Services Agency
30 November 2005
Page 7 of 9

COMMENT 5 – POST-EXCAVATION SOIL AND GROUNDWATER WORK PLAN

Soil Sampling

As noted in the response to Comment 1 above, the excavation depth for the foundation will be to approximately 14 feet bgs, although the final excavation depth will vary slightly because the property is not perfectly flat and there are construction features that require slightly deeper excavations, such as elevator pits (up to 5 feet deeper), thickened sections of the slab for the parking level (up to 1 foot deeper) and installation of drain rock (up to about 1 foot deeper).

Based upon the Site characterization information, chemicals of potential concern in soil vary based upon location and include solvents/volatile organic compounds (VOCs), TPHg, TPHd/mo and benzene, toluene, ethylbenzene, xylenes (BTEX), and methyl-tert-butyl ether (MTBE). Soil samples will be collected and submitted under Chain-of-Custody documentation to a California-certified laboratory for laboratory analyses. The analyses will include one or more of the following:

- TPHg by EPA Modified Method 8015
- BTEX and MTBE by EPA Modified Method 8020
- TPHd/TPHmo by EPA Modified Method 8015
- Volatile Organic Compounds (VOCs) by EPA Method 8260.

Figure 6 present proposed locations for the collection of soil samples. Based upon the Site characterization information presented above, soil samples will be collected from the base of the excavation in the following areas (Figure 6) during soil excavation activities:

- BMP Seismic Retrofitting – one sample will be collected from this the area to evaluate the potential presence of paint thinners in soil. The sample will be analyzed for TPHg and VOCs.
- Graphic Traffic – one sample will be collected from this area to evaluate the potential presence of solvents. The sample will be analyzed for TPHg and VOCs.
- Canova Marble – one sample will be collected from this area to evaluate the potential presence of solvents associated with paints and adhesives. The sample will be analyzed for TPHg and VOCs.
- S.B. Thomas – two samples will be collected from this area near the former 10,000 gallon gasoline UST. The samples will be analyzed for TPHg and BTEX/MTBE.

Barney Chan
Hazardous Materials Specialist
Alameda County Health Care Services Agency
30 November 2005
Page 8 of 9

- Correris Cabinets – one sample will be collected from the yard area near the former paint storage cabinets. The sample will be analyzed for TPHg and VOCs.
- Fleetcare Repair – one sample will be collected from the yard area near the former waste oil AST and another sample will be collected from the two former 3,000 gallon waste oil ASTs. The samples will be analyzed for TPHd/mo.
- Ellerson Weaver – one sample will be collected from the yard area near the former drum locations. The sample will be analyzed for TPHd/mo.
- Subsurface contamination detected as part of the 59th Street Widening – Two soil samples will be collected near the former area where TPHd and TPHmo were detected in subsurface soil. Samples will be analyzed for TPHd/mo.
- Southwest corner of the Site near TR-23, TR-24 and TR-25 - two soil samples will be collected from areas near TR-23, TR-24 and TR-25, which are near the former 5,000-barrel (210,000 gallon) gasoline AST and the former lubrication oil tanks. The locations may also be impacted by the gasoline service station. Samples will be analyzed for TPHg, TPHd/mo, BTEX and MTBE.
- Former Loading Rack – one sample will be collected from the area where a loading rack associated with the former Union Oil of California operations was located. The sample will be analyzed for TPHg, TPHd/mo, BTEX and MTBE.

In accordance with Section 5.10 of the SMP, the results of the soil sampling and associated documentation will be submitted to ACEH as part of the excavation completion report required by Section 5.10 of the SMP. The report will be submitted to ACEH within 90 days of completion of the excavation activities.

Groundwater Sampling

As noted in Section 5.5.1 of the SMP, construction-phase dewatering will be required during the soil excavation and foundation construction. Based upon the grab groundwater samples collected to date, TPHg and BTEX are present in groundwater along the southern perimeter of the Site.

In addition to the discharge permit-required discharge sampling, the extracted water will be sampled on a weekly basis and analyzed using the following methods:

- TPHg by EPA Modified Method 8015
- BTEX and MTBE by EPA Modified Method 8020.

Barney Chan
Hazardous Materials Specialist
Alameda County Health Care Services Agency
30 November 2005
Page 9 of 9

Water samples will be collected in laboratory-supplied containers and submitted under Chain-of-Custody documentation to a California-certified laboratory for analysis. The results of the extracted water sampling and associated documentation will be submitted to ACEH as part of the excavation completion report required by Section 5.10 of the SMP. The report will be submitted to ACEH within 90 days of completion of the excavation activities.

A post-development groundwater monitoring plan, identifying proposed locations for groundwater monitoring wells will be submitted along with the excavation completion report. Pending post-development access limitations, it is likely that the proposed well locations will be along the southern border of the Site, adjacent to the gasoline service station.

If you have any questions, please call Glenn Leong at (510) 874-4500 at extension 554.

Sincerely yours,
TREADWELL & ROLLO, INC.



Glenn M. Leong, REA
Senior Scientist

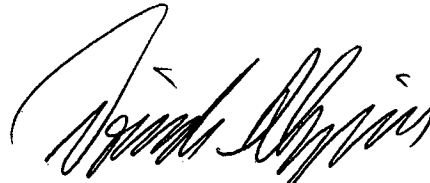

Dorinda C. Shipman, PG, CHG
Principal



40690104.OAK

Attachment 1 – Figures 1-6

Attachment 2 – Aerial Photos and Sanborn Maps

cc: Geoff Sears, E S East Associates, LLC, an affiliate of Wareham Development
Ignacio Dayrit, City of Emeryville

ATTACHMENT 1

FIGURES 1-6

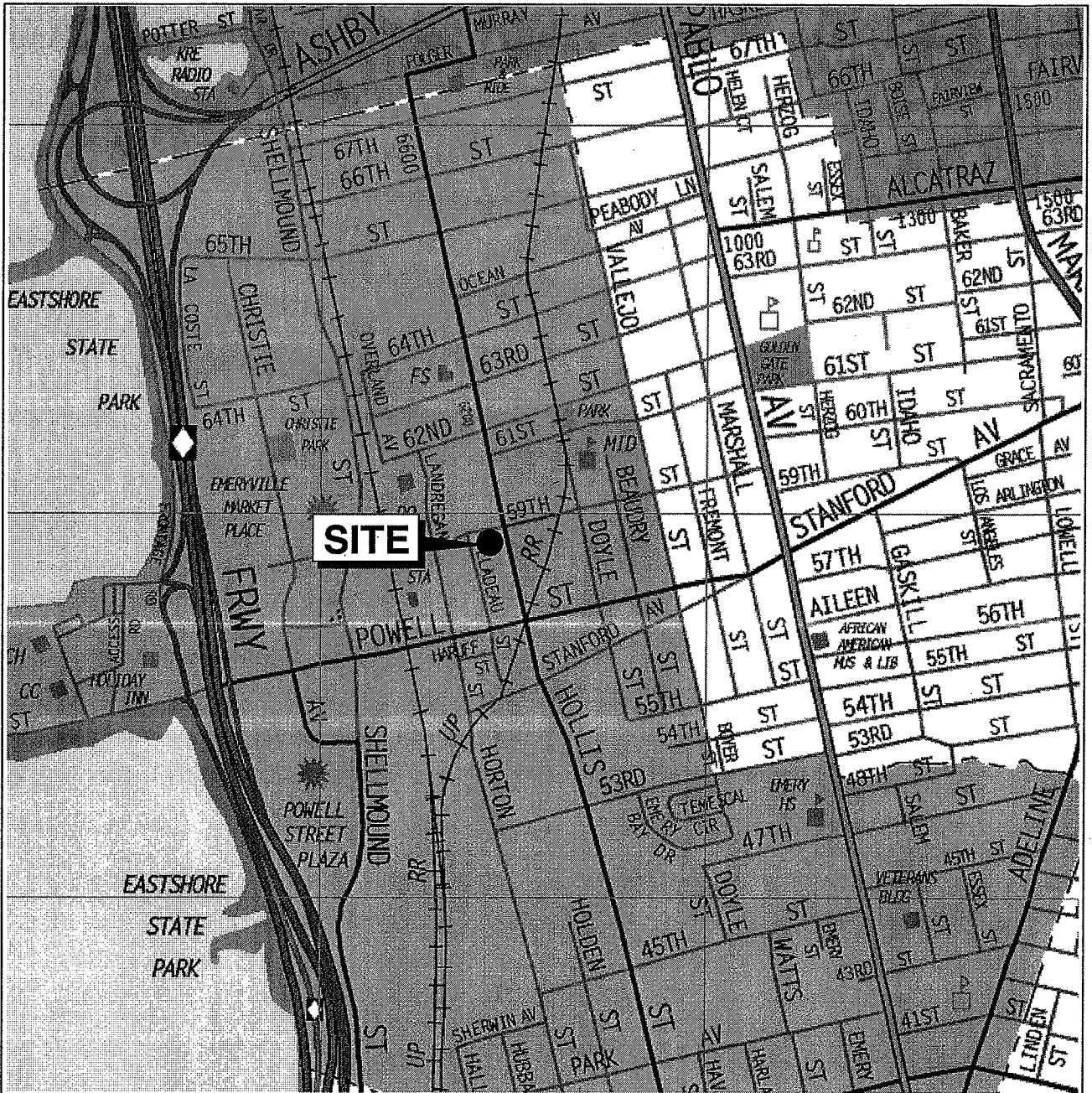

Base map: The Thomas Guide
Alameda County
1999



No scale

5885 HOLLIS STREET
Emeryville, California

SITE LOCATION MAP

Treadwell&Rollb

Date 05/13/05

Project No. 4069.01

Figure 1

HOLLIS STREET

59TH STREET

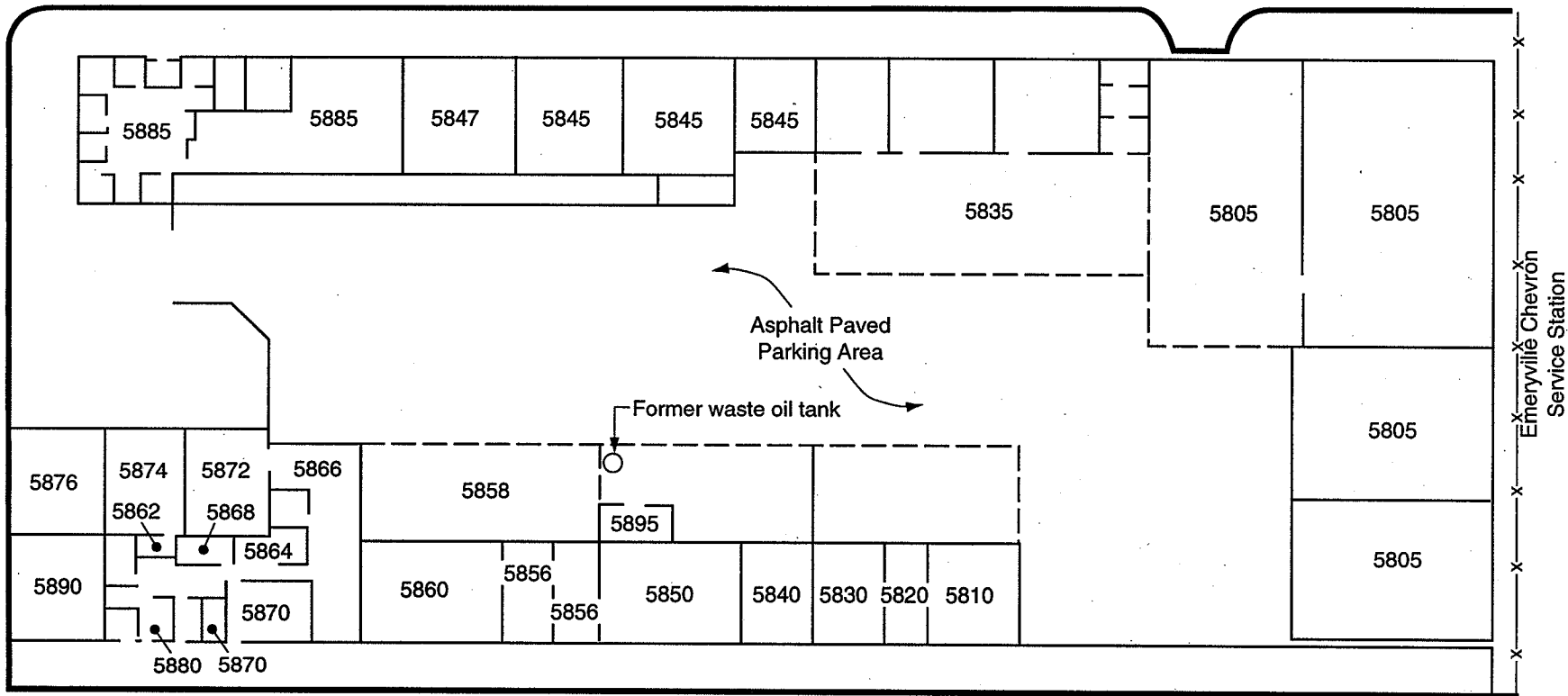

PELADEAU STREET

5885 HOLLIS STREET
Emeryville, California

SITE PLAN

Date 05/23/05 | Project No. 4069.01 | Figure 2

Treadwell & Rollo



0 60 Feet
Approximate scale

HOLLIS STREET

59TH STREET

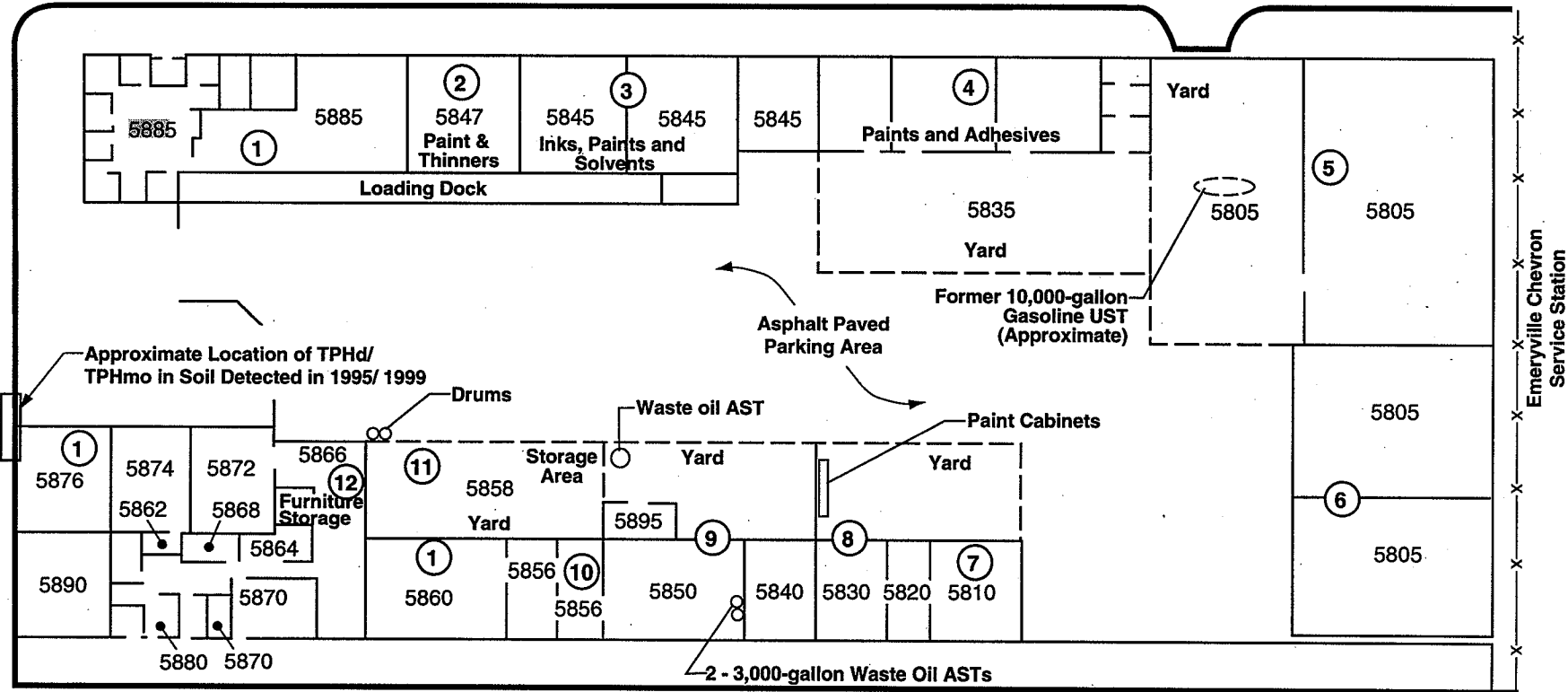

Emeryville Chevron Service Station

PELADEAU STREET

TENANTS

- ① McLaughlin Coffee
- ② BMP Seismic Retrofitting
- ③ Graphic Traffic
- ④ Canova Marble
- ⑤ S.B. Thomas
- ⑥ Pro-Formance Lighting
- ⑦ Edy's Candy Kitchen
- ⑧ Correris Cabinets
- ⑨ Fleetcare Repair
- ⑩ TLC Windshield
- ⑪ Ellerson Weaver
- ⑫ Alpha Furniture Restoration

Note: Site features from Environmental Site Assessment, March 19, 1995 (Weiss Associates)

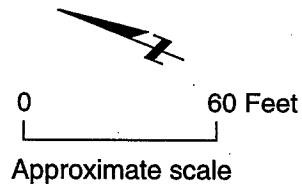

5885 HOLLIS STREET
Emeryville, California

1995 SITE USE

Date 11/23/05 Project No. 4069.01 Figure 3

Treadwell & Rollo

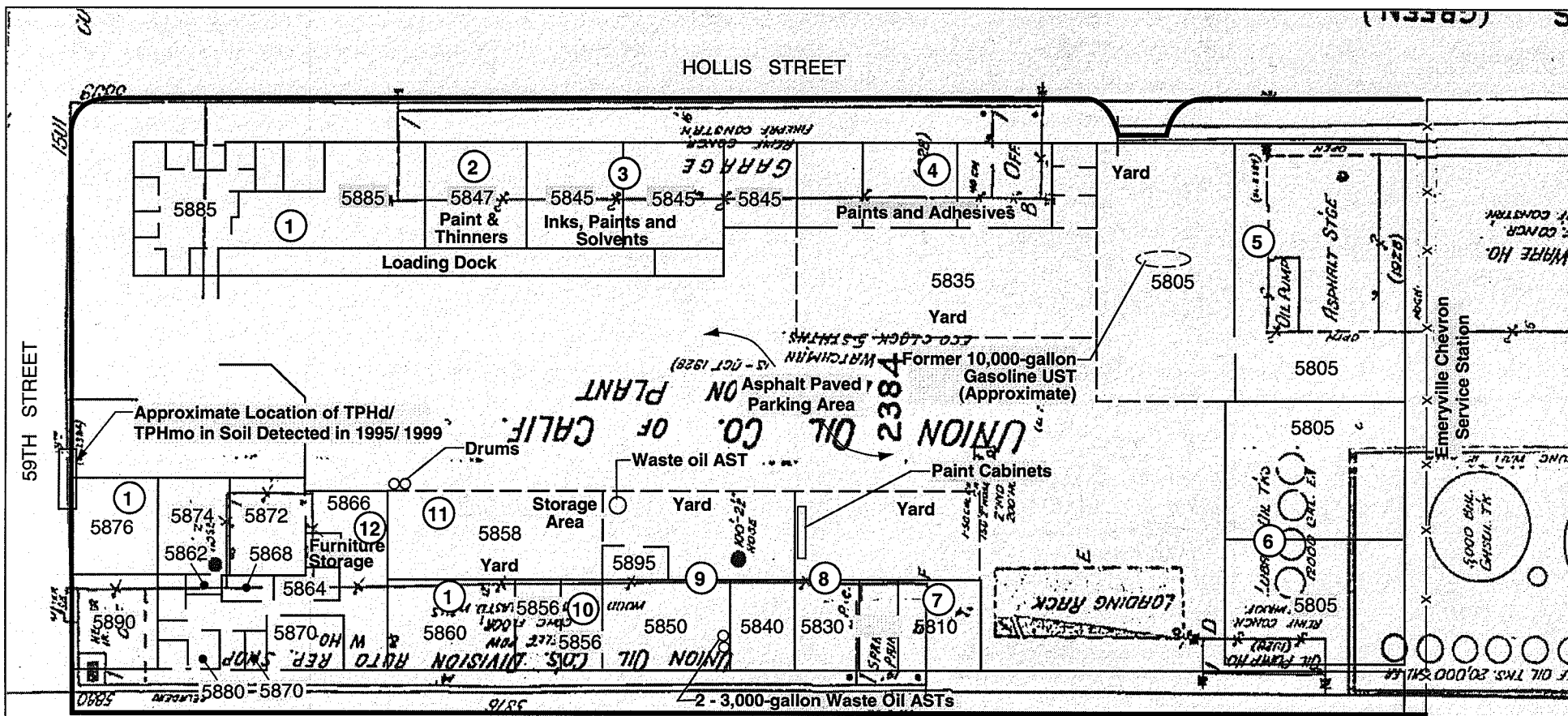

59TH STREET

HOLLIS STREET

PELADEAU STREET

TENANTS

- ① McLaughlin Coffee
- ② BMP Seismic Retrofitting
- ③ Graphic Traffic
- ④ Canova Marble
- ⑤ S.B. Thomas
- ⑥ Pro-Formance Lighting
- ⑦ Edy's Candy Kitchen
- ⑧ Correris Cabinets
- ⑨ Fleetcare Repair
- ⑩ TLC Windshield
- ⑪ Ellerson Weaver
- ⑫ Alpha Furniture Restoration

Note: Site features from Environmental Site Assessment, March 19, 1995 (Weiss Associates)

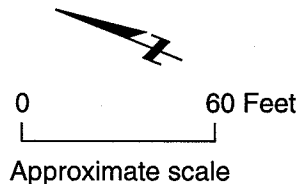

5885 HOLLIS STREET Emeryville, California		
1951 AND 1995 SITE USES		
Date 11/23/05	Project No. 4069.01	Figure 4

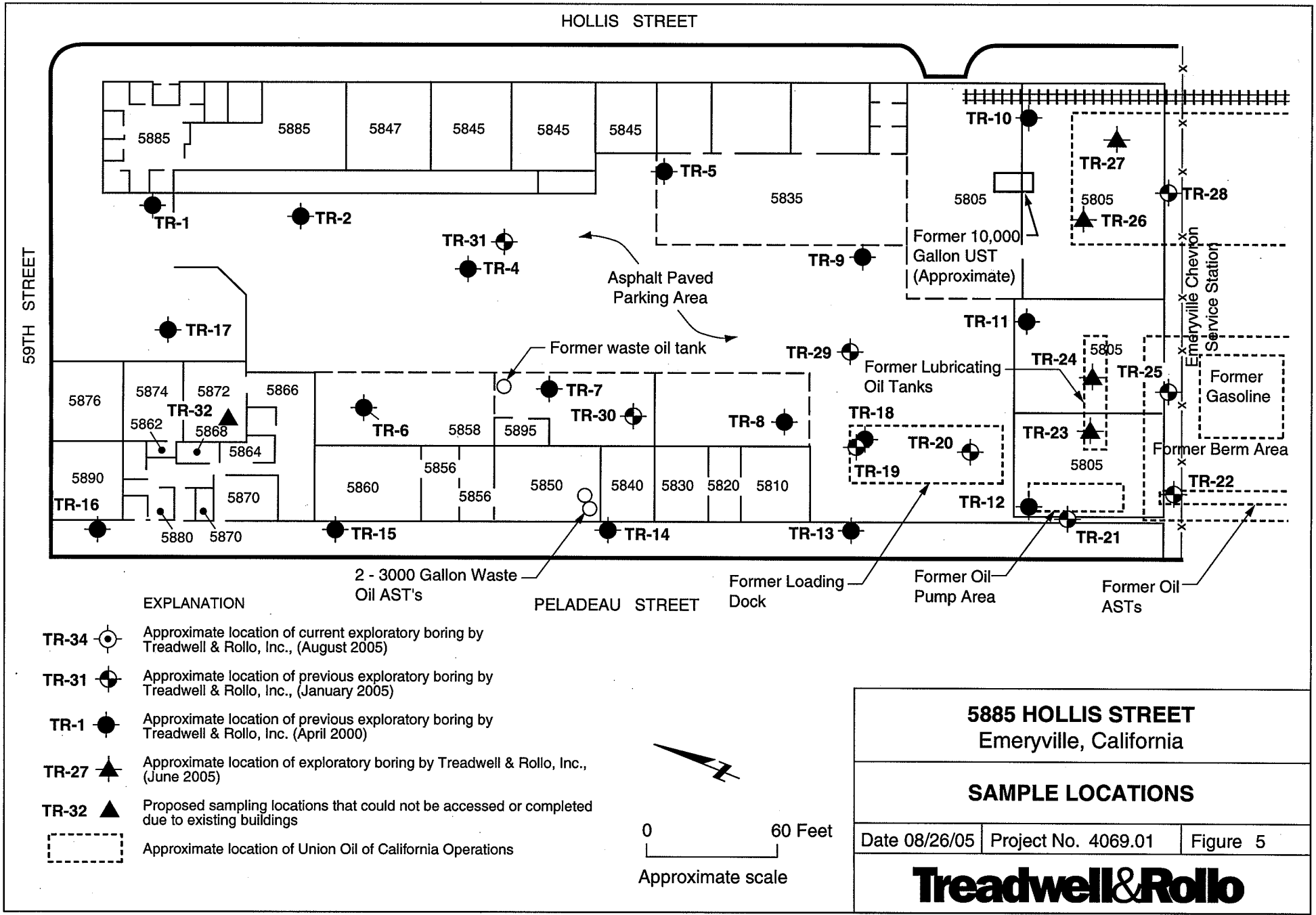

EXPLANATION

- TR-34 Approximate location of current exploratory boring by Treadwell & Rollo, Inc., (August 2005)
- TR-31 Approximate location of previous exploratory boring by Treadwell & Rollo, Inc., (January 2005)
- TR-1 Approximate location of previous exploratory boring by Treadwell & Rollo, Inc. (April 2000)
- TR-27 Approximate location of exploratory boring by Treadwell & Rollo, Inc., (June 2005)
- TR-32 Proposed sampling locations that could not be accessed or completed due to existing buildings
- Approximate location of Union Oil of California Operations

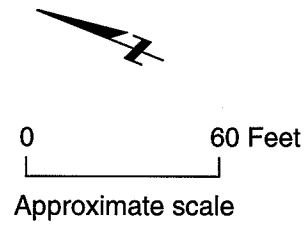

5885 HOLLIS STREET Emeryville, California		
SAMPLE LOCATIONS		
Date 08/26/05	Project No. 4069.01	Figure 5
Treadwell & Rollo		

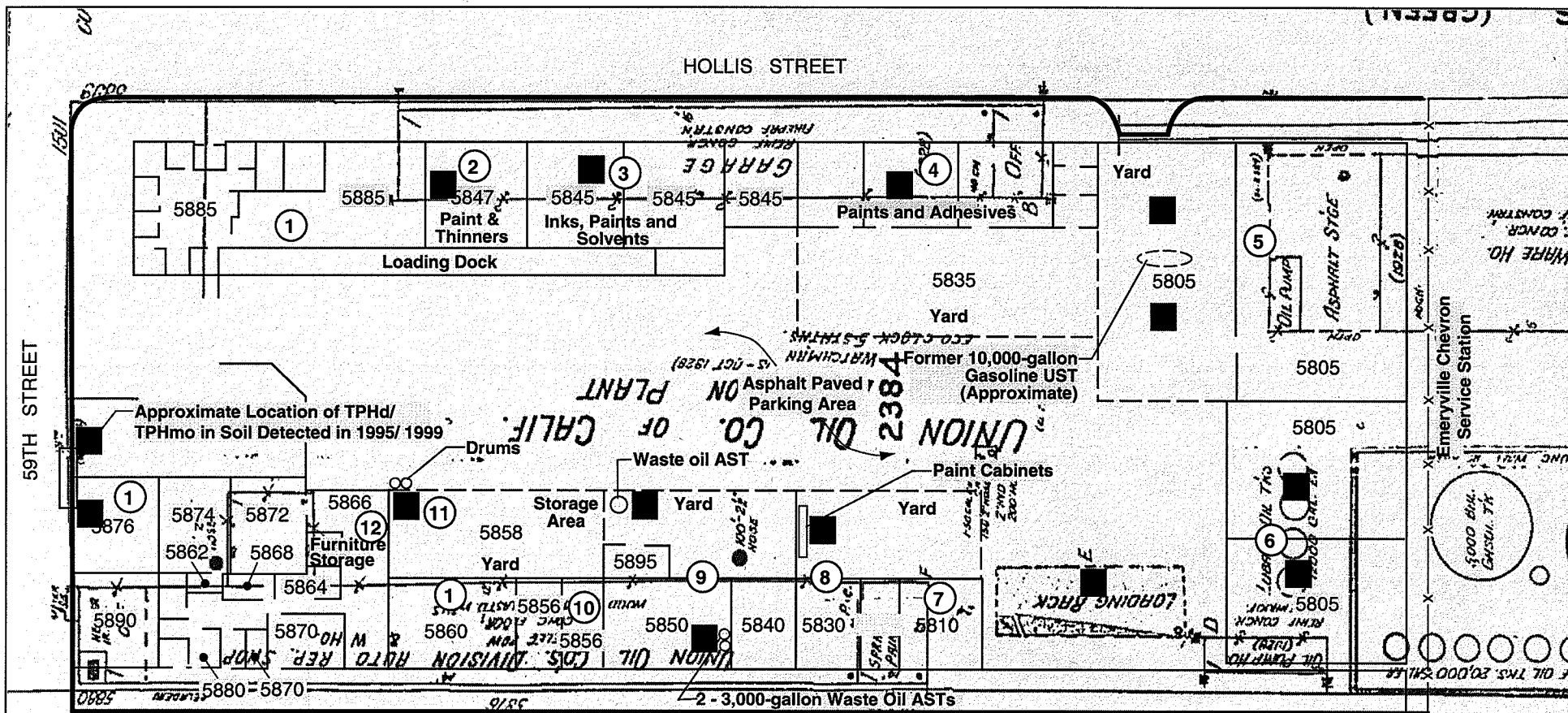

HOLLIS STREET

59TH STREET

PELADEAU STREET

TENANTS

- ① McLaughlin Coffee
- ② BMP Seismic Retrofitting
- ③ Graphic Traffic
- ④ Canova Marble
- ⑤ S.B. Thomas
- ⑥ Pro-Formance Lighting
- ⑦ Edy's Candy Kitchen
- ⑧ Correris Cabinets
- ⑨ Fleetcare Repair
- ⑩ TLC Windshield
- ⑪ Ellerson Weaver
- ⑫ Alpha Furniture Restoration

■ Approximate location of Post Excavation Soil Sample

Note: Site features from Environmental Site Assessment, March 19, 1995 (Weiss Associates)

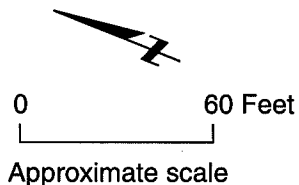

5885 HOLLIS STREET Emeryville, California		
PROPOSED POST EXCAVATION SOIL SAMPLE LOCATIONS		
Date 11/29/05	Project No. 4069.01	Figure 6

ATTACHMENT 2

AERIAL PHOTOS AND SANBORN MAPS



EDR® Environmental
Data Resources Inc

"Linking Technology with Tradition"®

Sanborn® Map Report

Ship To: Glenn Leong
Treadwell & Rollo Inc.
501 14th Street
Oakland, CA 94612

Order Date: 11/21/2005 **Completion Date:** 11/21/2005

Inquiry #: 1559763.3s

P.O. #: 4069.01.1400

Site Name: Emerystation East

Address: 5885 Hollis Street

City/State: Emeryville, CA 94608

Cross Streets:

Customer Project: 4069.01
1047659VLA 510-874-4500

Based on client-supplied information, fire insurance maps for the following years were identified

- 1911 - 1 Map
- 1951 - 1 Map
- 1952 - 1 Map
- 1967 - 1 Map
- 1969 - 1 Map

Limited Permission to Photocopy

Total Maps: 5

Treadwell & Rollo Inc. (the client) is permitted to make up to THREE photocopies of this Sanborn Map transmittal and each fire insurance map accompanying this report solely for the limited use of its customer. No one other than the client is authorized to make copies. Upon request made directly to an EDR Account Executive, the client may be permitted to make a limited number of additional photocopies. This permission is conditioned upon compliance by the client, its customer and their agents with EDR's copyright policy; a copy of which is available upon request.

This Report contains certain information obtained from a variety of public and other sources reasonably available to Environmental Data Resources, Inc. It cannot be concluded from this Report that coverage information for the target and surrounding properties does not exist from other sources. NO WARRANTY EXPRESSED OR IMPLIED, IS MADE WHATSOEVER IN CONNECTION WITH THIS REPORT. ENVIRONMENTAL DATA RESOURCES, INC. SPECIFICALLY DISCLAIMS THE MAKING OF ANY SUCH WARRANTIES, INCLUDING WITHOUT LIMITATION, MERCHANTABILITY OR FITNESS FOR A PARTICULAR USE OR PURPOSE. ALL RISK IS ASSUMED BY THE USER. IN NO EVENT SHALL ENVIRONMENTAL DATA RESOURCES, INC. BE LIABLE TO ANYONE, WHETHER ARISING OUT OF ERRORS OR OMISSIONS, NEGLIGENCE, ACCIDENT OR ANY OTHER CAUSE, FOR ANY LOSS OF DAMAGE, INCLUDING, WITHOUT LIMITATION, SPECIAL, INCIDENTAL, CONSEQUENTIAL, OR EXEMPLARY DAMAGES. ANY LIABILITY ON THE PART OF ENVIRONMENTAL DATA RESOURCES, INC. IS STRICTLY LIMITED TO A REFUND OF THE AMOUNT PAID FOR THIS REPORT. Purchaser accepts this Report AS IS. Any analyses, estimates, ratings, environmental risk levels or risk codes provided in this Report are provided for illustrative purposes only, and are not intended to provide, nor should they be interpreted as providing any facts regarding, or prediction or forecast of, any environmental risk for any property. Only a Phase I Environmental Site Assessment performed by an environmental professional can provide information regarding the environmental risk for any property. Additionally, the information provided in this Report is not to be construed as legal advice.

Copyright 2005 by Environmental Data Resources, Inc. All rights reserved. Reproduction in any media or format, in whole or in part, of any report or map of Environmental Data Resources, Inc., or its affiliates, is prohibited without prior written permission. EDR and its logos (including Sanborn and Sanborn Map) are trademarks of Environmental Data Resources, Inc. or its affiliates. All other trademarks used herein are the property of their respective owners.

USER'S GUIDE

This User's Guide provides guidelines for accessing Sanborn Map® images and for transferring them to your Word Processor.

Reading Sanborn Maps

- Sanborn Maps document historical property use by displaying property information through words, abbreviations, and map symbols. The Sanborn Map Key provides information to help interpret the symbols and abbreviations used on Sanborn Maps. The Key is available from EDR's Web Site at: <http://www.edrnet.com/reports/samples/key.pdf>

Organization of Electronic Sanborn Image File

- Sanborn Map Report, listing years of coverage
- User's Guide
- Oldest Sanborn Map Image
- Most recent Sanborn Map Image

Navigating the Electronic Sanborn Image File

1. Open file on screen.
2. Identify TP (Target Property) on the most recent map.
3. Find TP on older printed images.
4. Using Acrobat® Reader®, zoom to 250% in order to view more clearly. (200-250% is the approximate equivalent scale of hardcopy Sanborn Maps.)
 - A. On the menu bar, click "View" and then "Zoom to..."
 - B. Or, use the magnifying tool and drag a box around the TP

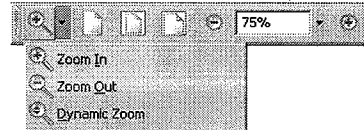

Printing a Sanborn Map From the Electronic File

- EDR recommends printing images at 300 dpi (300 dpi prints faster than 600 dpi)
- To print only the TP area, cut and paste from Acrobat to your word processor application.

Acrobat Versions 6 and 7

1. Go to the menu bar
2. Click the "Select Tool"
3. Draw a box around the area selected
4. "Right click" on your mouse
5. Select "Copy Image to Clipboard"
6. Go to Word Processor such as Microsoft Word, paste and print.



Acrobat Version 5

1. Go to the menu bar
2. Click the "Graphics Select Tool"
3. Draw a box around the area selected
4. Go to "Menu"
5. Highlight "Edit"
6. Highlight "Copy"
7. Go to Word Processor such as Microsoft Word, paste and print.



Important Information about Email Delivery of Electronic Sanborn Map Images

- Images are grouped into one file, up to 2MB.
- In cases where in excess of 6-7 map years are available, the file size typically exceeds 2MB. In these cases, you will receive multiple files, labeled as "1 of 3", "2 of 3", etc. including all available map years.
- Due to file size limitations, certain ISPs, including AOL, may occasionally delay or decline to deliver files. Please contact your ISP to identify their specific file size limitations.

59TH ST. 262

266

EMERYVILLE

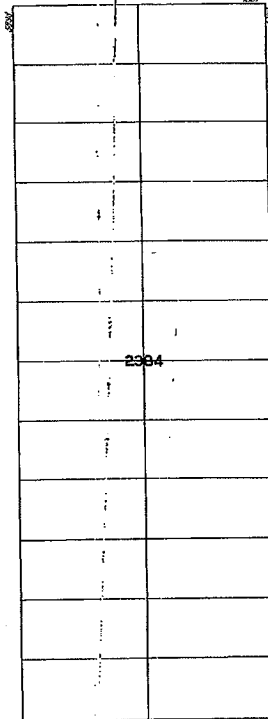
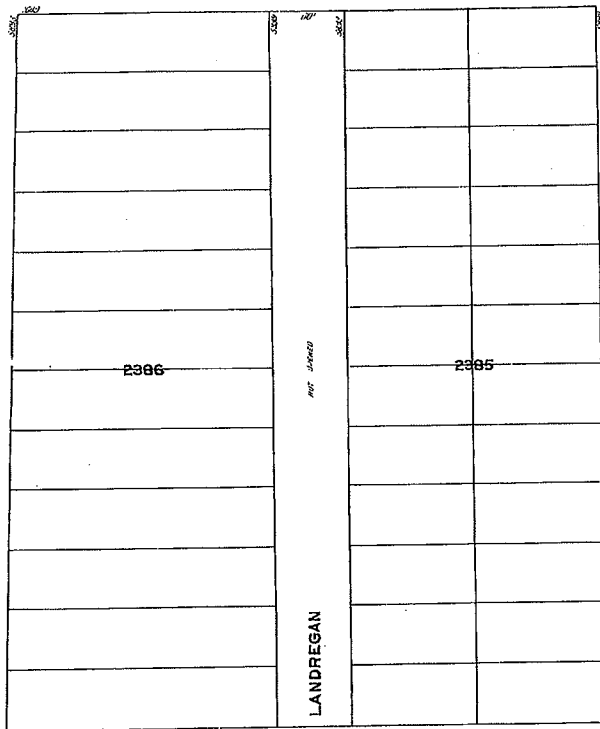

267

265

26

POWELL

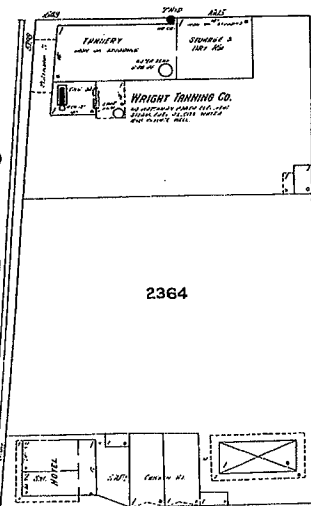

2364

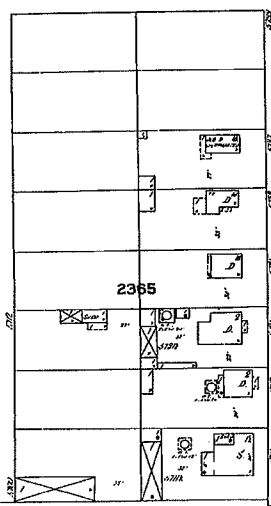

2365

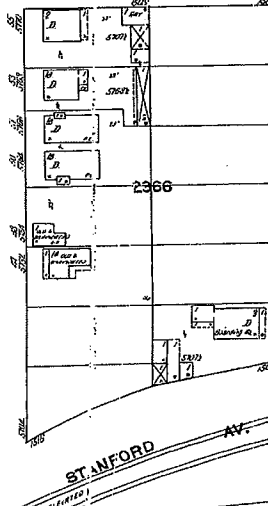

2366

323

319

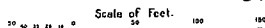

ST. ANFORD AV.



The Sanborn Library, LLC

Copyright © 1911 The Sanborn Library, LLC LHE
Year EDR Research Associate

Reproduction in whole or in part of any map of The Sanborn Library, LLC may be prohibited without prior written permission from The Sanborn Library, LLC.

369

370

59TH ST.

262

266

EMERYVILLE
CAL. . . 063

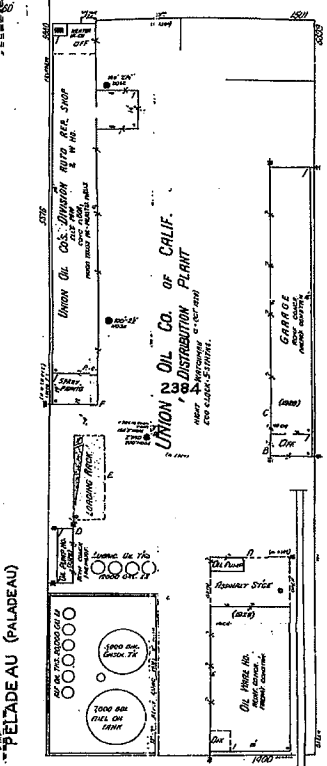
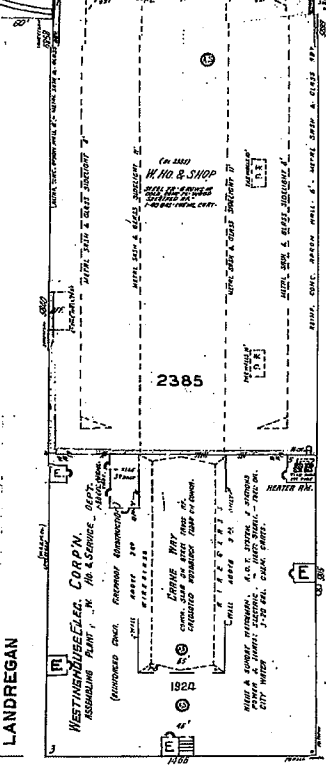
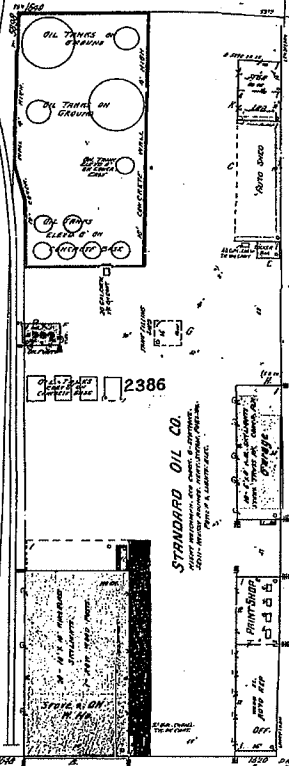

267

POWELL

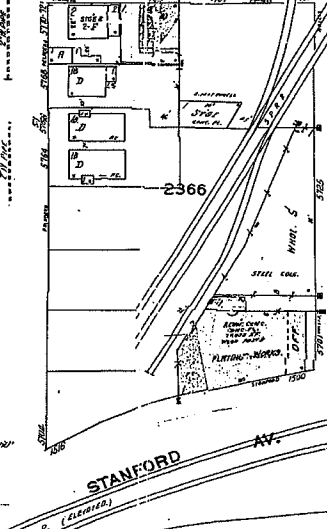
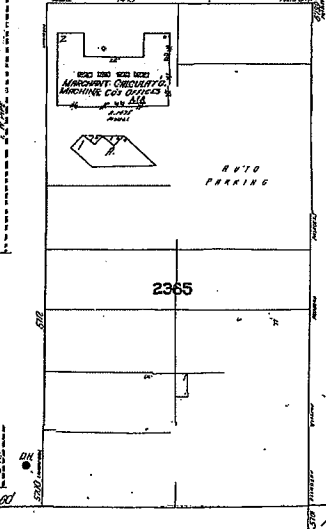
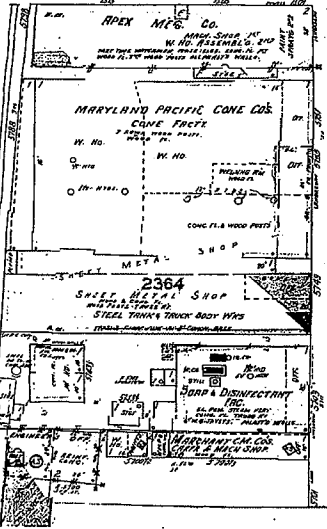

Scale of Feet. 0 50 100 150

323

319

STANFORD AV.

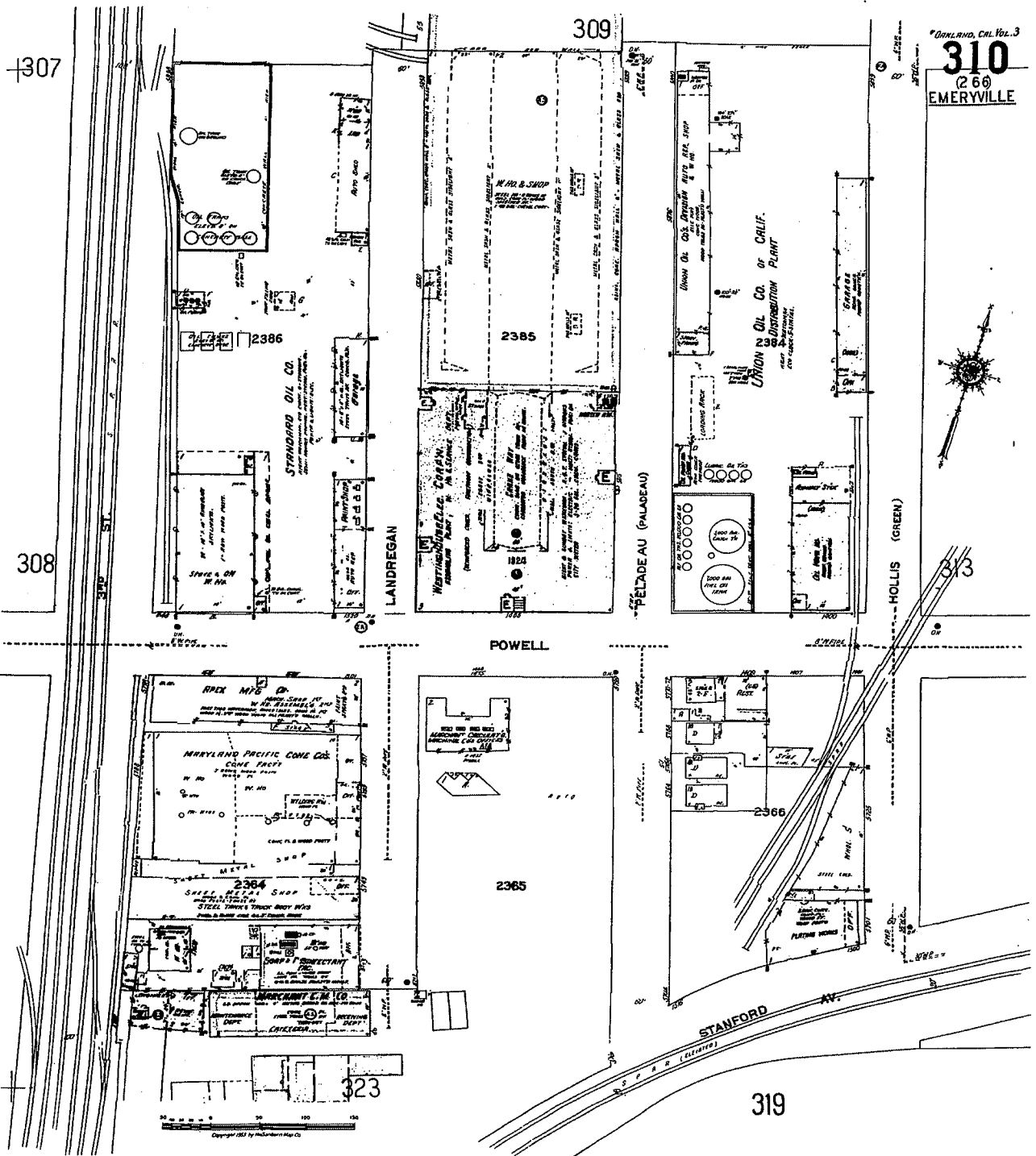

ORLANDO, CAL. VOL. 3
310
 (260)
 EMERYVILLE

307

309

308

POWELL

HOLLIS (GREEN)

313

STANFORD AV.

319

323

2386
 STANDARD OIL CO.
 2385
 M. H. & SHOP
 2366
 MARYLAND PACIFIC COKE CO.
 2365
 SHELL M. H. & SHOP
 323

UNION OIL CO. OF CALIF.
 DISTRIBUTION PLANT
 1000 GAL. TANK
 1000 GAL. TANK

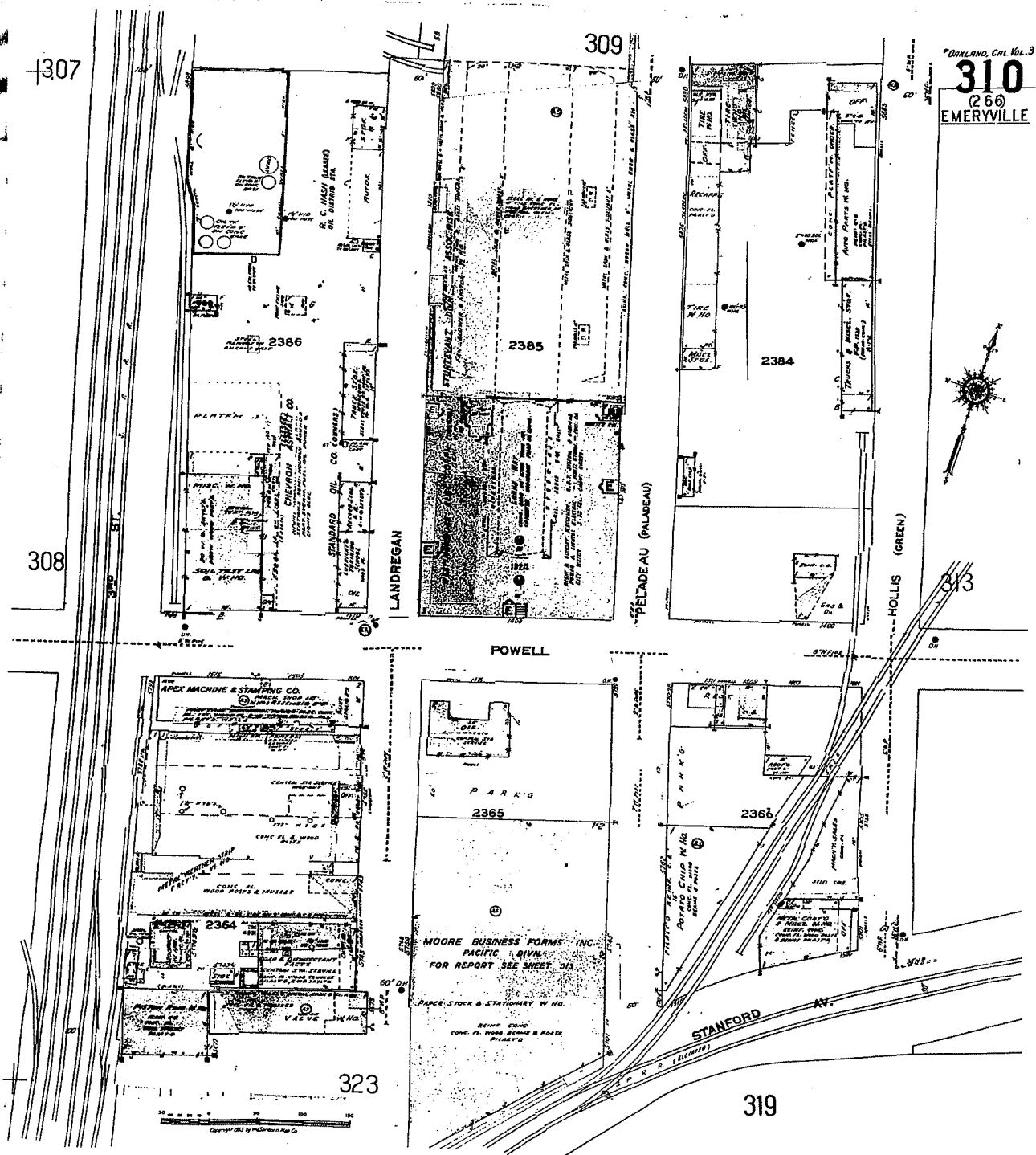

307

309

310
260
EMERYVILLE
(1907)

THIS SHEET
NOT REVISION SINCE 11/67

308

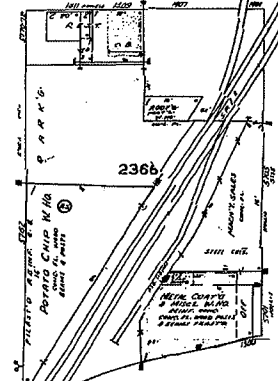
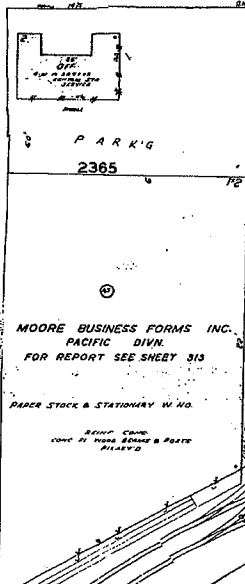
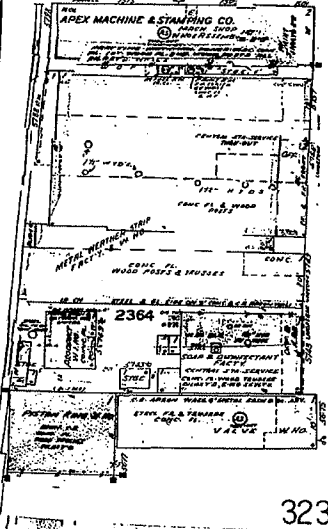
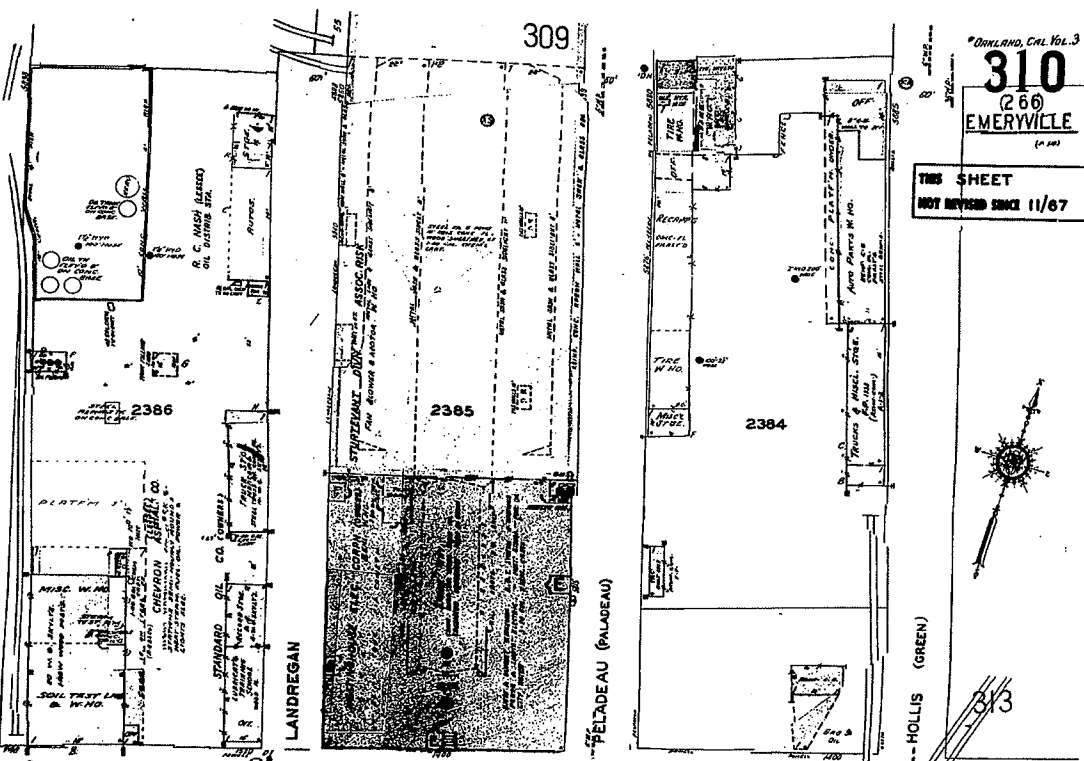

323

319

STANFORD

66



The Sanborn Library, LLC

Copyright 1989 The Sanborn Library, LLC LHE
Year EOR Research Associate

Reproduction in whole or in part of any map of The Sanborn Library, LLC may be prohibited without prior written permission from The Sanborn Library, LLC.



EDR® Environmental
Data Resources Inc

The EDR Aerial Photo Decade Package

**Emerystation East
5885 Hollis Street
Emeryville, CA 94608**

Inquiry Number: 1559763.6

November 22, 2005

The Standard in Environmental Risk Management Information

**440 Wheelers Farms Road
Milford, Connecticut 06461**

Nationwide Customer Service

Telephone: 1-800-352-0050
Fax: 1-800-231-6802
Internet: www.edrnet.com

Environmental Data Resources, Inc.

Aerial Photography Print Service

Environmental Data Resources, Inc.'s (EDR) Aerial Photography Print Service is a screening tool designed to assist professionals in evaluating potential liability on a target property resulting from past activities. ASTM E 1527-00, Section 7.3 on Historical Use Information, identifies the prior use requirements for a Phase I environmental site assessment. The ASTM standard requires a review of *reasonably ascertainable standard historical sources*. *Reasonably ascertainable means information that is publicly available, obtainable from a source with reasonable time and cost constraints, and practically reviewable.*

To meet the prior use requirements of ASTM E 1527-00, Section 7.3.4, the following *standard historical sources* may be used: aerial photographs, fire insurance maps, property tax files, land title records (although these cannot be the sole historical source consulted), topographic maps, city directories, building department records, or zoning/land use records. ASTM E 1527-00 requires *"All obvious uses of the property shall be identified from the present, back to the property's obvious first developed use, or back to 1940, whichever is earlier. This task requires reviewing only as many of the standard historical sources as are necessary, and that are reasonably ascertainable and likely to be useful."* (ASTM E 1527-00, Section 7.3.2, page 12.)

Aerial Photographs

When delivered electronically by EDR, the aerial photo images included with this report are for ONE TIME USE ONLY. Further reproduction of these aerial photo images is prohibited without permission from EDR. For more information contact your EDR Account executive.

Aerial photographs are a valuable historical resource for documenting past land use and can be particularly helpful when other historical sources (such as city directories or fire insurance maps) are not reasonably ascertainable. The EDR Aerial Photograph Print Service includes a search of local aerial photograph collections flown by public and private agencies. EDR's professional field-based researchers provide digitally reproduced historical aerial photographs at ten year intervals.

Thank you for your business.
Please contact EDR at 1-800-352-0050
with any questions or comments.

Disclaimer - Copyright and Trademark Notice

This Report contains certain information obtained from a variety of public and other sources reasonably available to Environmental Data Resources, Inc. It cannot be concluded from this Report that coverage information for the target and surrounding properties does not exist from other sources. NO WARRANTY EXPRESSED OR IMPLIED, IS MADE WHATSOEVER IN CONNECTION WITH THIS REPORT. ENVIRONMENTAL DATA RESOURCES, INC. SPECIFICALLY DISCLAIMS THE MAKING OF ANY SUCH WARRANTIES, INCLUDING WITHOUT LIMITATION, MERCHANTABILITY OR FITNESS FOR A PARTICULAR USE OR PURPOSE. ALL RISK IS ASSUMED BY THE USER. IN NO EVENT SHALL ENVIRONMENTAL DATA RESOURCES, INC. BE LIABLE TO ANYONE, WHETHER ARISING OUT OF ERRORS OR OMISSIONS, NEGLIGENCE, ACCIDENT OR ANY OTHER CAUSE, FOR ANY LOSS OF DAMAGE, INCLUDING, WITHOUT LIMITATION, SPECIAL, INCIDENTAL, CONSEQUENTIAL, OR EXEMPLARY DAMAGES. ANY LIABILITY ON THE PART OF ENVIRONMENTAL DATA RESOURCES, INC. IS STRICTLY LIMITED TO A REFUND OF THE AMOUNT PAID FOR THIS REPORT. Purchaser accepts this Report AS IS. Any analyses, estimates, ratings, environmental risk levels or risk codes provided in this Report are provided for illustrative purposes only, and are not intended to provide, nor should they be interpreted as providing any facts regarding, or prediction or forecast of, any environmental risk for any property. Only a Phase I Environmental Site Assessment performed by an environmental professional can provide information regarding the environmental risk for any property. Additionally, the information provided in this Report is not to be construed as legal advice.

Copyright 2005 by Environmental Data Resources, Inc. All rights reserved. Reproduction in any media or format, in whole or in part, of any report or map of Environmental Data Resources, Inc., or its affiliates, is prohibited without prior written permission.

EDR and its logos (including Sanborn and Sanborn Map) are trademarks of Environmental Data Resources, Inc. or its affiliates. All other trademarks used herein are the property of their respective owners.

Date EDR Searched Historical Sources:

Aerial Photography November 22, 2005

Target Property:

5885 Hollis Street

Emeryville, CA 94608

<u>Year</u>	<u>Scale</u>	<u>Details</u>	<u>Source</u>
1939	Aerial Photograph. Scale: 1"=555'	Flight Year: 1939	Fairchild
1946	Aerial Photograph. Scale: 1"=655'	Flight Year: 1946	Jack Ammann
1958	Aerial Photograph. Scale: 1"=555'	Flight Year: 1958	Cartwright
1965	Aerial Photograph. Scale: 1"=333'	Flight Year: 1965	Cartwright
1982	Aerial Photograph. Scale: 1"=690'	Flight Year: 1982	WSA
1993	Aerial Photograph. Scale: 1"=666'	Flight Year: 1993	USGS
1998	Aerial Photograph. Scale: 1"=666'	Flight Year: 1998	USGS

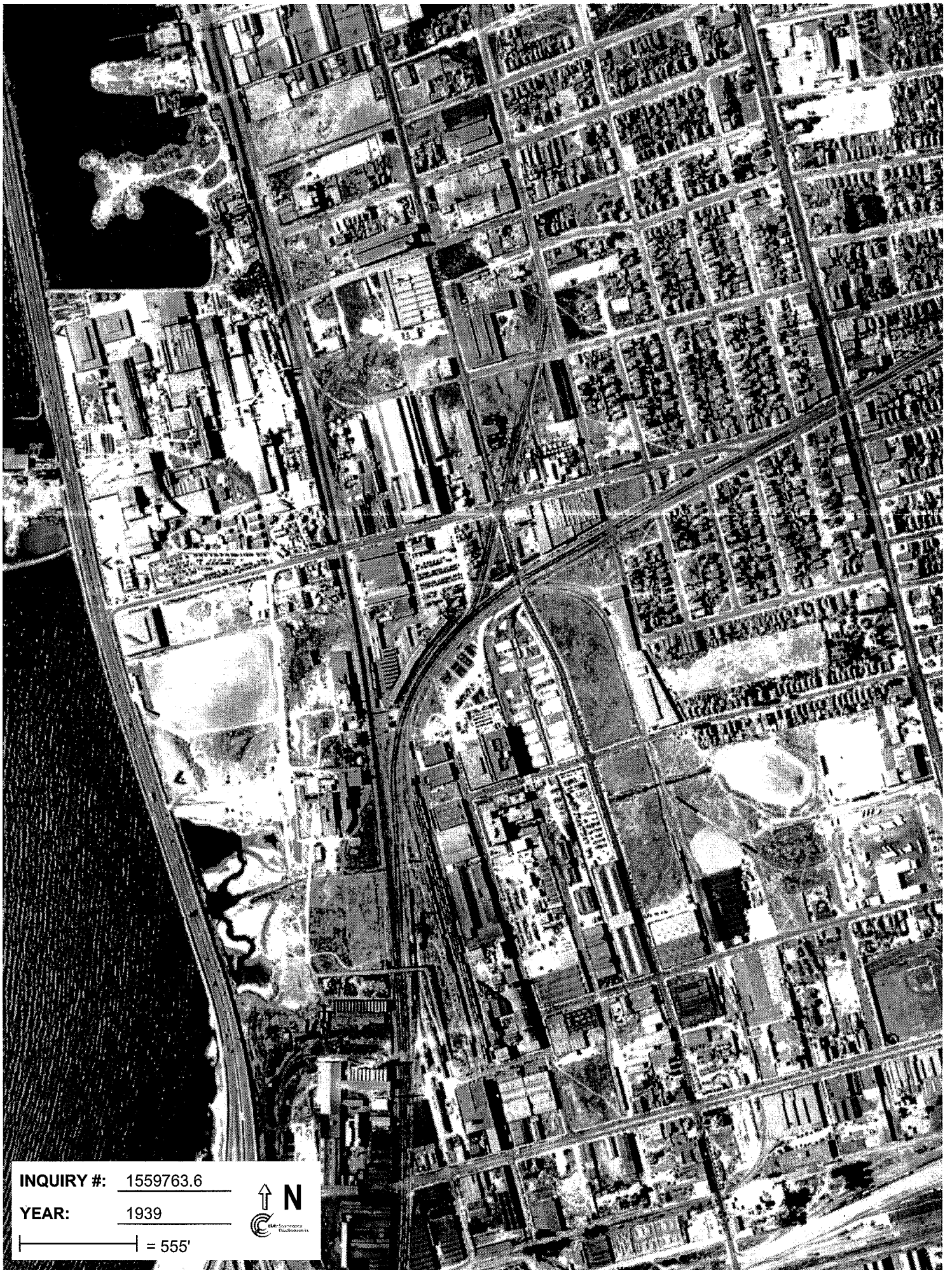

INQUIRY #: 1559763.6

YEAR: 1939

| = 555'





INQUIRY #: 1559763.6

YEAR: 1946

| = 655'





INQUIRY #: 1559763.6

YEAR: 1958

— = 555'





INQUIRY #: 1559763.6

YEAR: 1965

| = 333'





INQUIRY #: 1559763.6

YEAR: 1982

| = 690'





INQUIRY #: 1559763.6

YEAR: 1993

| = 666'





INQUIRY #: 1559763.6

YEAR: 1998

— = 666'

