

**RECEIVED**

By Alameda County Environmental Health at 4:18 pm, Apr 15, 2014



**Union Pacific Railroad**

**Environmental Management Group**

9451 Atkinson Street, Suite 100 - Roseville, California 95747

James E. Diel  
Manager Environmental Site Remediation

(916) 789-5184  
Facsimile (402) 501-2396

April 16, 2014

Ms. Karel Detterman  
Alameda County Health Care Services Agency  
Environmental Health Services  
1131 Harbor Bay Parkway, Suite 250  
Alameda, CA 94502-6577

Subject: Submittal of the Addendum to the Site Conceptual  
Model Report and Data Gap Work Plan, 744 and 758 High  
Street, Oakland, California, Fuel Leak Case No.  
R01135 and GeoTracker Global ID T0600101305

Dear Ms. Detterman:

Enclosed is the Addendum to the Site Conceptual Model Report and Data  
Gap Work Plan, which describes the plan to conduct additional  
investigation activities at the 744 and 758 High Street site in  
Oakland, California.

I declare, under penalty of perjury, that the information and  
recommendations contained in the attached document is true and correct  
to the best of my knowledge.

If you have any questions or comments after reviewing this material,  
please feel free to contact me by email at [JEDIEL@up.com](mailto:JEDIEL@up.com) or by phone  
at (916) 789-5184.

Sincerely,



James E. Diel  
Manager of Site Remediation  
Union Pacific Railroad Company

C: David Hodson/CH2M HILL



CH2M HILL  
155 Grand Avenue  
Suite 800  
Oakland, CA 94612  
Tel 510.251.2888  
Fax 510.622.9000

April 16, 2014

Ms. Karel Detterman  
Alameda County Health Care Services Agency  
Environmental Health Services  
1131 Harbor Bay Parkway, Suite 250  
Alameda, California 94502-6577

Subject: Addendum to the *Site Conceptual Model Report and Data Gap Work Plan, 744 and 758 High Street, Oakland, California*

Dear Ms. Detterman:

On behalf of Union Pacific Railroad Company (UPRR), CH2M HILL has prepared this addendum to the *Site Conceptual Model Report and Data Gap Work Plan (Work Plan) (CH2M HILL, 2013a)* for the former UPRR property located within the property currently located at 750 High Street, Oakland, California (the site). A site location map is attached as Figure 1 (figures are enclosed with this letter report). This addendum describes the proposed scope of work and procedures for conducting an additional investigation.

The *Site Conceptual Model Update and Soil and Groundwater Investigation Report (Site Investigation Report) (CH2M HILL, 2013b)* concluded that the current understanding of the nature and extent of soil and groundwater impacts at the site were inadequate to assess the need for remediation; additionally, it was recommended to pave an unpaved portion of the site to limit potential worker exposure to contaminants of potential concern (COPCs) identified in shallow soil. The plan to pave the unpaved portion is currently under evaluation and will be submitted under separate cover. The objectives of the proposed additional investigation include:

- Obtain better vertical and lateral definition of COPCs to address data gaps as presented in the Site Investigation Report.
- Install new groundwater monitoring wells to assess groundwater hydrogeology and potential impacts to groundwater.
- Update the conceptual site model.
- Obtain data to evaluate the need for soil or groundwater remedial action at the site.

Site background information is presented in Work Plan (CH2M HILL, 2013a) and Site Investigation Report (CH2M HILL, 2013b).

## Scope of Work

This addendum proposes advancing 20 borings to depths ranging from 5 to 17 feet below ground surface (bgs) to collect soil and groundwater samples and install five groundwater monitoring wells. Proposed activities are located within the private property owned by Economy Lumber located at 750 High Street. Further details regarding drilling and sampling methodologies are described below.

## Field Preparations

The following activities will be completed before fieldwork begins at the site:

- Update the site-specific health and safety plan

- Obtain a soil boring permit from Alameda County Public Works (ACPW)
- Obtain entry approval from the property owner
- Contact Underground Service Alert for utility clearance at least 3 working days before beginning boring advancement
- Conduct a subsurface survey using a private utility locator to identify underground utilities at the locations of the proposed borings
- Contact UPRR's fiber optic hotline and complete UPRR fiber optic notifications
- Notify Alameda County Health Care Services Agency Environmental Health Services (ACEH) of the field investigation schedule

## Soil and Grab Groundwater Sampling

Twenty soil borings (GB030 through GB049) will be advanced using direct-push drilling to facilitate the collection of discrete soil and grab groundwater samples from locations shown on Figure 2. The planned depths for these borings are presented in Table 1. The actual locations, drilling depths, and quantity and depths of soil and grab groundwater samples will be based on field conditions and observations.

Borings will be advanced with a track-mounted direct-push drill rig by Vironex of Concord, California (California C57 Drilling License #705927), under the oversight of CH2M HILL. Core samples will be retrieved to record soil lithology, screen soil samples using a photoionization detector (PID), and collect soil samples for laboratory analysis. Where drilling conditions permit, continuous core samples will be collected. The borings will be logged by a CH2M HILL geologist according to ASTM International D2488-06 (Standard Practice for Description and Identification of Soils [Visual-Manual Procedure]). Additionally, the following drilling activities will be conducted:

- Before and between drilling each boring, appropriate portions of the drilling rig, drilling tools, and any reusable sampling equipment will be decontaminated.
- Drill cuttings and equipment decontamination rinse water will be contained onsite in labeled 55-gallon steel drums in a secure temporary staging area. Investigation-derived waste (IDW) management is discussed in a subsequent section of this addendum.
- Soil borings will be abandoned in accordance with county requirements. Soil borings will be backfilled with neat cement from the bottom up using a tremie pipe.

Soil samples, grab groundwater samples, or both will be collected from borings for select laboratory analyses. Soil samples will be selected for laboratory analyses based on the general sampling depths specified in Table 1 and refined using field observations and PID field screening, if necessary. Soil samples for VOC analysis will be collected using 5-gram Terra Core sampling devices. Soil samples for non-VOC analyses will be collected in pre-cleaned, laboratory-supplied glass jars. Where borings penetrate first encountered groundwater with sufficient water for sampling, grab groundwater samples will be collected near the soil-water interface using temporary wells constructed from ¾-inch polyvinyl chloride (PVC) riser and factory-milled screens. The temporary well materials will be discarded and not reused between borings. Grab groundwater samples from temporary wells will be collected using a peristaltic pump and dedicated high-density polyethylene (HDPE) tubing. If necessary, groundwater may be collected using bailer or HDPE tubing with a check valve.

It is anticipated that an undetermined number borings will not produce sufficient groundwater volume for laboratory analysis during one working day. At these locations, sample collection will take place as soon as sufficient groundwater is available and an ACPW variance will be requested to leave the boring

open/ungouted for up to 48 hours to allow for groundwater infiltration. Borings left overnight or unattended will be clearly marked and adequately covered.

## **Monitoring Well Installation and Development**

Five monitoring wells (MW-01 through MW-05) will be installed during the proposed field investigation. The proposed locations of monitoring wells MW-01 through MW-05 are shown on Figure 2, and rationales for the monitoring wells, possible soil sample selections, and initial groundwater sample analyses are presented in Table 1. Groundwater is anticipated to be encountered at depths ranging from 10 to 17 feet bgs. Boreholes for monitoring well installation will be advanced to the target depths using a track-mounted drill rig equipped with 8-inch hollow stem augers by Vironex of Concord, California. The borings will be logged according to ASTM International D2488-06 by a CH2M HILL geologist. Wells will be constructed of 2-inch-diameter Schedule 40 flush-threaded PVC risers and screens. The perforated intervals will be constructed with 5 to 10 feet of 0.010-inch factory-milled slots across the upper water-bearing zone. The final screen length and placement will be determined by a geologist based on field conditions. A 4-inch-long threaded PVC bottom cap will be installed at the bottom of each well. Well construction diagrams are provided in Attachment 1.

During installation, the well casings will be suspended until the filter pack is placed. The filter pack will consist of a size number 3 silica sand placed from the base of the borehole to approximately 1 foot above the top of the screened interval. An approximately 1-foot-thick hydrated bentonite seal will be placed on top of the filter pack. The remaining borehole annulus was sealed with a neat cement grout, consisting of approximately 5 gallons of water per 94-pound sack of Portland cement placed from the bottom of the boring by tremie pipe, or a consistency determined by the ACPW inspector. The surface completion of the wells will include a flush-mount 8-inch-diameter, traffic-rated road box set in concrete.

Development of monitoring wells will be attempted a minimum of 72 hours after completing well construction. The development procedure will include surging and bailing the well to remove the most silt-laden water, then surging and pumping until the monitored groundwater parameters of temperature, pH, and conductivity stabilize to within 10 percent of the previous reading or until a minimum volume of water equal to three wetted casing volumes have been removed.

Soil from the well installation and groundwater purged during well development will be placed in 55-gallon steel drums and labeled. The drums will be temporarily stored in a secure on-site location. The disposal of IDW is discussed in a subsequent section of this addendum.

Groundwater sampling of monitoring wells MW-01 through MW-05 will be conducted no sooner than 48 hours following the completion of well development and then quarterly for 1 year. The need for continued groundwater sampling from these monitoring wells will be evaluated in consultation with ACEH. Groundwater samples will be collected using low-flow sampling procedures with a peristaltic pump and dedicated high-density polyethylene tubing of the water column within the well. The sampling procedure will include purging the well at approximately 50 to 200 milliliters per minute until the monitored groundwater parameters (turbidity, temperature, pH, and conductivity) stabilize to within 10 percent for the final three readings, or until a volume of water equal to three wetted-casing volumes have been removed.

## **Laboratory Analysis of Samples**

Soil and groundwater samples will be submitted under chain-of-custody to TestAmerica in Pleasanton, California (California ELAP No. 2496). Soil and groundwater samples will be analyzed for one or more of the following:

- Polychlorinated biphenyls by United States Environmental Protection Agency (EPA) Method 8082
- Metals by EPA Method 6010B

- Total petroleum hydrocarbons (TPH) (as diesel, motor oil, and gasoline) by EPA Modified Method 8015
- Semivolatile organic compounds (SVOCs) by EPA Method 8270C SIM

Field duplicates, equipment and trip blanks, and matrix spike/matrix spike duplicate (MS/MSD) samples will be collected and analyzed for quality assurance/quality control (QA/QC) purposes as presented in the Work Plan (CH2M HILL, 2013a).

## Surveying

The horizontal positions of soil borings and groundwater monitoring wells will be established using real time kinematic measurements of global positioning system data referenced to the National Geodetic Survey Continuously Operating Reference Station network consistent with Geotracker requirements. The vertical control of monitoring wells will be established by surveying using differential leveling. The location and elevation of monitoring wells will be measured to North American Datum of 1983 (latitude and longitude) and National American Vertical Datum of 1988 (with a 1991 adjustment) (elevation) at vertical accuracies of 0.01 foot or less. All surveying data will be reviewed and approved for use by a California-licensed land surveyor.

## Investigation-derived Waste Management

The IDW expected to be generated will include equipment decontamination rinsate, personal protective equipment, soil cuttings, and dedicated sampling equipment. The IDW is anticipated to be nonhazardous, and will be temporarily stored onsite in 55-gallon drums. The drums will be sealed and labeled to indicate the site name, drilling or sampling location(s), contents, and date. At the end of each day of field operations, the 55-gallon drum(s) of IDW will be transported to an onsite location, which is fenced.

## Schedule and Reporting

Fieldwork discussed in this work plan is scheduled to begin after approval by the ACEH and after permits and access permissions are obtained. The proposed field investigation will take approximately 7 days to complete. The ACEH and ACPW will be notified at least 1 week before fieldwork begins.

Results of the activities performed under this addendum will be presented in a report. The report will contain the following:

- A brief description of the site
- A summary of the fieldwork, including modifications to this addendum made in the field, and a map showing sampling locations
- Figures showing the site vicinity, sampling locations, and the distribution of COPCs in soil and groundwater
- Tables summarizing laboratory analytical data for soil and groundwater samples collected during the investigation and first groundwater monitoring event
- A data quality evaluation report
- A review and evaluation of the analytical data
- An update to the nature and extent of COPCs and the conceptual site model
- Supporting documentation, such as chain-of-custody forms, analytical reports, lithologic logs, and sampling forms, and waste disposal documentation
- Recommendations, if applicable

Ms. Karel Detterman

April 16, 2014

Page 5

Groundwater monitoring reports will be submitted after each of the remaining three quarters of groundwater monitoring.

## Works Cited

CH2M HILL. 2013a. *Site Conceptual Model Report and Data Gap Work Plan, 744 and 758 High Street, Oakland, California*. March 29.

CH2M HILL. 2013b. *Site Conceptual Model Update and Soil and Groundwater Investigation Report, 744 and 758 High Street, Oakland, California*. November 8.

Please contact me at (510) 316-2323 if you have any questions.

Sincerely,  
CH2M HILL

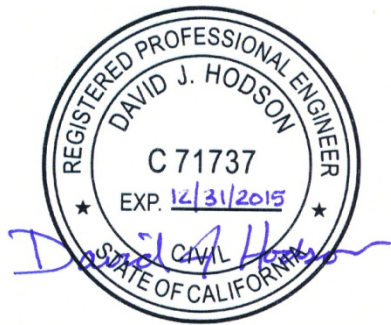

David Hodson, P.E.  
Project Manager

### Enclosures:

Table 1	Proposed Sampling Rationale
Figure 1	Site Location Map
Figure 2	Proposed Boring and Monitoring Well Locations
Attachment 1	Well Construction Diagrams

**Table**

---

TABLE 1  
**Proposed Sampling Rationale**  
*Addendum to the Site Conceptual Model and Data Gap Work Plan*  
*744 and 758 High Street, Oakland, California*

Location ID	Location <sup>a</sup>	Matrix	Sample Start Depth/Screen Interval (feet bgs)	PCBs	TPH-D/-MO	SVOCs	Metals	Rationale
GB030	At the location of previous soil boring GB003	Soil	14 16			x x		Vertically delineate concentrations of SVOCs detected above screening levels in soil at 12 feet bgs at previous boring GB003.
GB031	Approximately 25 feet northwest of previous soil boring GB001	Soil	1 4			x x		Evaluate the presence of SVOCs in soil northwest of previous soil boring GB001, and in groundwater northwest of previous soil boring GB005.
		Water	WT			x		
GB032	Approximately 20 feet northeast of previous soil boring GB002	Soil	1 4			x x		Evaluate the presence of SVOCs in soil northeast of previous soil boring GB002, and in groundwater northeast of previous soil boring GB005.
		Water	WT			x		
GB033	Approximately 40 feet southeast of previous soil boring GB003 and GB005	Soil	1		x	x	x	Evaluate the presence of metals, TPH, and SVOCs southeast of previous soil boring GB003, and SVOCs in groundwater southeast of GB005.
			3		x	x	x	
			6		x	x	x	
			14			x		
		16			x			
Water	WT				x			
GB034 (offsite)	Approximately 30 feet southwest of previous soil boring B-1	Soil	1	x	x	x	x	Evaluate the presence of metals, PCBs, and TPH southwest of previous soil boring B-1, composite surface soil sample No. 4-2, and Excavation A, respectively.
			4	x	x	x	x	
GB035	At the previous location of soil boring GB008	Water	WT	x	x	x	x	Evaluate the presence of metals, PCBs, SVOCs, and TPH in groundwater northwest of GB027 and Excavation C.
GB036	Approximately 40 feet southwest of previous soil boring GB029 and on the eastern margin of Excavation A	Soil	1 4	x x	x x	x x	x x	Evaluate the presence of metals, PCBs, SVOCs, and TPH in soil and metals, PCBs, and TPH in groundwater southwest of previous soil boring GB029 and east of Excavation A. Evaluate the presence of SVOCs in groundwater based on soil concentrations at previous soil boring GB029. Further evaluation of COPCs east of GB029 (offsite) is not proposed because of safety concerns posed by working in the high speed rail corridor.
		Water	WT	x	x	x	x	
GB037	Approximately 40 feet northwest of previous soil boring GB029	Soil	1	x	x	x	x	Evaluate the presence of metals, PCBs, SVOCs, and TPH in soil and metals, PCBs, and TPH in groundwater northwest of previous soil boring GB029. Evaluate the presence of SVOCs in groundwater northwest of previous soil boring GB029 where sufficient groundwater volume for SVOC analyses was not available. Further evaluation of COPCs east of GB029 (offsite) is not proposed because of safety concerns posed by working in the high-speed rail corridor.
			4	x	x	x	x	
		Water	WT	x	x	x	x	



TABLE 1

**Proposed Sampling Rationale***Addendum to the Site Conceptual Model and Data Gap Work Plan**744 and 758 High Street, Oakland, California*

Location ID	Location <sup>a</sup>	Matrix	Sample Start Depth/Screen Interval (feet bgs)	PCBs	TPH-D/-MO	SVOCs	Metals	Rationale
GB038 (offsite)	Approximately 45 feet southwest of previous soil boring GB010	Soil	1 5 9 WT	x	x x x x	x x x x	x	Evaluate the presence of: 1) SVOCs in soil southwest of previous soil borings GB010, GB011, and GB012; 2) SVOCs in groundwater based on concentrations in soil samples from previous soil borings GB010 through GB012; 3) TPH in soil west of previous soil borings GB010 and GB012, and in groundwater southwest of previous soil boring GB011; 4) metals in groundwater southwest of GB011 and GB027; and 5) PCBs in groundwater southwest of previous soil boring GB027.
GB039	Approximately 40 feet southeast of previous soil boring GB012	Soil	1 5 9 WT	x	x x x x	x x x x	x	Evaluate the presence of: 1) SVOCs in soil southeast of previous soil boring GB010; 2) SVOCs in groundwater based on concentrations in soil samples from GB012; 3) TPH in soil southeast of previous soil borings GB012 and in groundwater southeast of previous soil boring GB011; 4) metals in groundwater southeast of GB012; and 5) PCBs in groundwater samples from previous soil boring GB027 to the northwest, previous soil boring GB028 to the northeast, previous monitoring well MW-C-6 to the southeast.
GB040	At the location of previous soil boring GB007	Soil	15			x	x	Vertically delineate concentrations of SVOCs detected above screening levels in soil at 12 feet bgs at previous boring GB007. Further evaluation of COPCs east of GB007 is not proposed because of safety concerns posed by working in the high speed rail corridor (offsite) and insufficient working space within the interior of the building (onsite).
GB041 (offsite)	Approximately 40 feet southwest of previous soil boring GB009	Soil  Water	1 5 9 WT	x	x x x x	x x x x	x	Evaluate the presence of: 1) SVOCs in soil southwest of previous soil boring GB009 and northwest of previous soil borings GB010 and GB011; 2) SVOCs in groundwater based on concentrations in soil samples from previous soil borings GB009 through GB011; 3) TPH in soil northwest of previous soil borings GB010 and in groundwater southwest and northwest of previous soil borings GB027 and GB011, respectively; 4) metals in groundwater southwest and northwest of previous soil borings GB027 and GB011, respectively; and 5) PCBs in groundwater southwest from previous soil boring GB027.
GB042	Approximately 40 feet northeast of previous soil boring GB028	Soil  Water	1 5 9 WT	x x x	x x x	x x x x	x x x	Evaluate the presence of metals, PCBs, SVOCs, and TPH detected in soil and groundwater northeast of previous soil boring GB028.
GB043 (offsite)	Approximately 40 feet south of previous soil boring GB026	Soil  Water	1 5 9 WT	x x x	x x x	x x x x	x x x	Evaluate the presence of: 1) metals, SVOCs, and TPH in soil southwest of previous soil boring GB026; 2) metals in groundwater southwest of GB026; 3) TPH-diesel and TPH-motor oil in groundwater southwest of previous soil boring GB026 where detected in soil and insufficient groundwater volume was available to analyze for these constituents; 4) PCBs in groundwater southwest of former monitoring well MW-C-6; and 5) PCBs in soil southwest of previous soil boring C-8.
GB044	Approximately 50 feet northwest of previous soil boring GB015	Soil  Water	1 5 WT	x x x	x x x	x x x	x x x	Evaluate the presence of metals, PCBs, SVOCs, and TPH in soil northwest of previous soil boring GB015. Evaluate the presence of metals, PCBs, SVOCs, and TPH in groundwater southeast of previous boring location GB028.

TABLE 1  
**Proposed Sampling Rationale**  
*Addendum to the Site Conceptual Model and Data Gap Work Plan*  
*744 and 758 High Street, Oakland, California*

Location ID	Location <sup>a</sup>	Matrix	Sample Start Depth/Screen Interval (feet bgs)	PCBs	TPH-D/-MO	SVOCs	Metals	Rationale
GB045	Step out from GB016, GB017, and GB018	Soil  Water	1 4 WT	x x x	x x x	x x x	x x x	Evaluate the presence of: 1) SVOCs in soil easterly of previous soil borings GB016, GB017, and GB018; 2) PCBs in soil northeast of previous soil borings GB017; 3) metals in soil because of historical storage of scrap metal on bare soil along the site's southeastern fence line; 4) TPH easterly of previous soil borings GB016 and GB017; 5) metals and TPH in groundwater southeast of GB018; 6) SVOCs in groundwater because of the occurrence of SVOCs in soil at previous soil borings GB016, GB017, and GB018; and 7) PCBs in groundwater southeast of previous monitoring well MW-C-2, because of the occurrence in soil at GB017, and because of the historical storage of possibly PCB-containing scrap materials on bare soil along the site's southeastern fence line.
GB046 (offsite)	Step out from GB021	Soil  Water	1 5 9 WT	x x x	x x x	x x x	x x x	Evaluate the presence of: 1) SVOCs in soil southwest of previous soil boring GB021; 2) TPH in groundwater southwest of previous soil boring GB024; 3) metals, TPH, and PCBs in soil and metals, PCBs, and SVOCs in groundwater because of possible historical storage of scrap materials on bare soil along the site's southwestern fence line and the occurrence of these constituents in the southern portion of the site.
GB047	Approximately 40 feet northeast of previous soil boring GB019	Soil  Water	1 5 9 WT	x x x	x x x	x x x	x x x	Evaluate the presence of: 1) SVOCs in soil northeast of previous soil boring GB019; 2) PCBs and TPH in soil because of the occurrence of these constituents in the southern portion of the site and possible historical storage of scrap materials on bare soil along the site's southeastern fence line; 3) metals in soil because of the possible historical storage of scrap materials on bare soil along the site's southeastern fence line, and 4) PCBs, SVOCs, and PCBs in groundwater because of the occurrence of these constituents in soil within the southern portion of the site and possible historical of scrap materials on bare soil along the site's southeastern fence line.
GB048 (offsite)	Approximately 30 feet southwest of previous soil boring GB024	Soil  Water	1 5 9 WT	x x x	x x x	x x x	x x x	Evaluate the presence of: 1) SVOCs in soil southwest of the previous soil boring GB024; 2) PCBs and TPH in soil because of the occurrence of these constituents in the southern portion of the site and possible historical storage of scrap materials on bare soil along the site's southwestern fence line; 3) metals in soil because of possible historical storage of scrap materials on bare soil along the site's southwestern fence line; 4) TPH in groundwater southwest of previous soil boring GB024; and 5) metals, PCBs, and SVOCs in groundwater because of the occurrence of these constituents in soil within the southern portion of the site and possible historical of scrap materials on bare soil along the site's southwestern fence line.
GB049	Approximately 35 feet northeast of previous monitoring well MW-C-5	Soil  Water	1 5 9 WT	x x x	x x x	x x x	x x x	Evaluate the presence of PCBs, metals, SVOCs, and TPH in soil and groundwater in the northern corner of the southeastern portion of the site because of the occurrence of these constituents in soil and/or groundwater within the southern portion of the site and possible historical storage of scrap materials on bare soil along the site's southern fence line.
MW-01	Approximately 25' northwest	Soil	1	x	x	x	x	Evaluate the presence of metals, PCBs, SVOCs, and TPH in soil southeast of previous soil

TABLE 1

**Proposed Sampling Rationale**

*Addendum to the Site Conceptual Model and Data Gap Work Plan  
744 and 758 High Street, Oakland, California*

Location ID	Location <sup>a</sup>	Matrix	Sample Start Depth/Screen Interval (feet bgs)	PCBs	TPH-D/-MO	SVOCs	Metals	Rationale
	of the former monitoring well MW-A-1		5	x	x	x	x	boring GB029. Intended to generally replace former groundwater monitoring well MW-A-1, monitor groundwater gradients at the site, and to evaluate the presence of metals, PCBs, SVOCs, and TPH in groundwater because of detections of these constituents at the previous soil boring GB029 and/or the previous monitoring well MW-A-1.
			9	x	x	x	x	
		Water	5–15	x	x	x	x	
MW-02	Location of previous soil boring GB028 and former monitoring well MW-A-5	Water	6–16	x	x	x	x	Intended to generally replace former groundwater monitoring well MW-A-5, monitor groundwater gradients at the site, and to evaluate the presence of metals, PCBs, SVOCs, and TPH detected in groundwater at previous soil boring GB028 and former monitoring well MW-A-2.
MW-03	Location of former monitoring well MW-C-2	Water	7–12 or 16–21	x	x	x	x	Intended to generally replace former groundwater monitoring well MW-C-2, monitor groundwater gradients at the site, and to evaluate: 1) metals and PCBs in groundwater at former monitoring well MW-C-2; 2) TPH in groundwater west of previous soil boring GB018, and 3) SVOCs in groundwater because of occurrences in soil near the proposed location.
MW-04	Approximately 15 feet southeast of former monitoring well MW-B-2	Water	Top of fill material (if present)	x	x	x	x	Intended to generally replace former groundwater monitoring well MW-B-2, monitor groundwater gradients at the site, and to evaluate metals, PCBs, SVOCs, and TPH in groundwater at former monitoring well MW-B-2 and southeast of previous soil boring GB027.
		Water	5–15	x	x	x	x	
MW-05	Approximately 10 feet southeast of former monitoring well MW-C-5	Water	7–17	x	x	x	x	Intended to generally replace former groundwater monitoring well MW-C-5, monitor groundwater gradients at the site, and to evaluate: 1) TPH detected in groundwater at previous soil boring GB024; and 2) metals, PCBs, and SVOCs in groundwater because of the occurrence of these constituents in soil within the southern portion of the site and possible historical storage of scrap materials on bare soil along the site's southern fence line.

<sup>a</sup> Sampling locations and depths, as well as the final number of samples, may change in the field on the basis of site conditions and results of field screening using a photoionization detector.

## Notes:

bgs = below ground surface

WT = water table

PCB = polychlorinated biphenyl

SVOC = semivolatle organic compound

TPH = total petroleum hydrocarbons

**Figures**

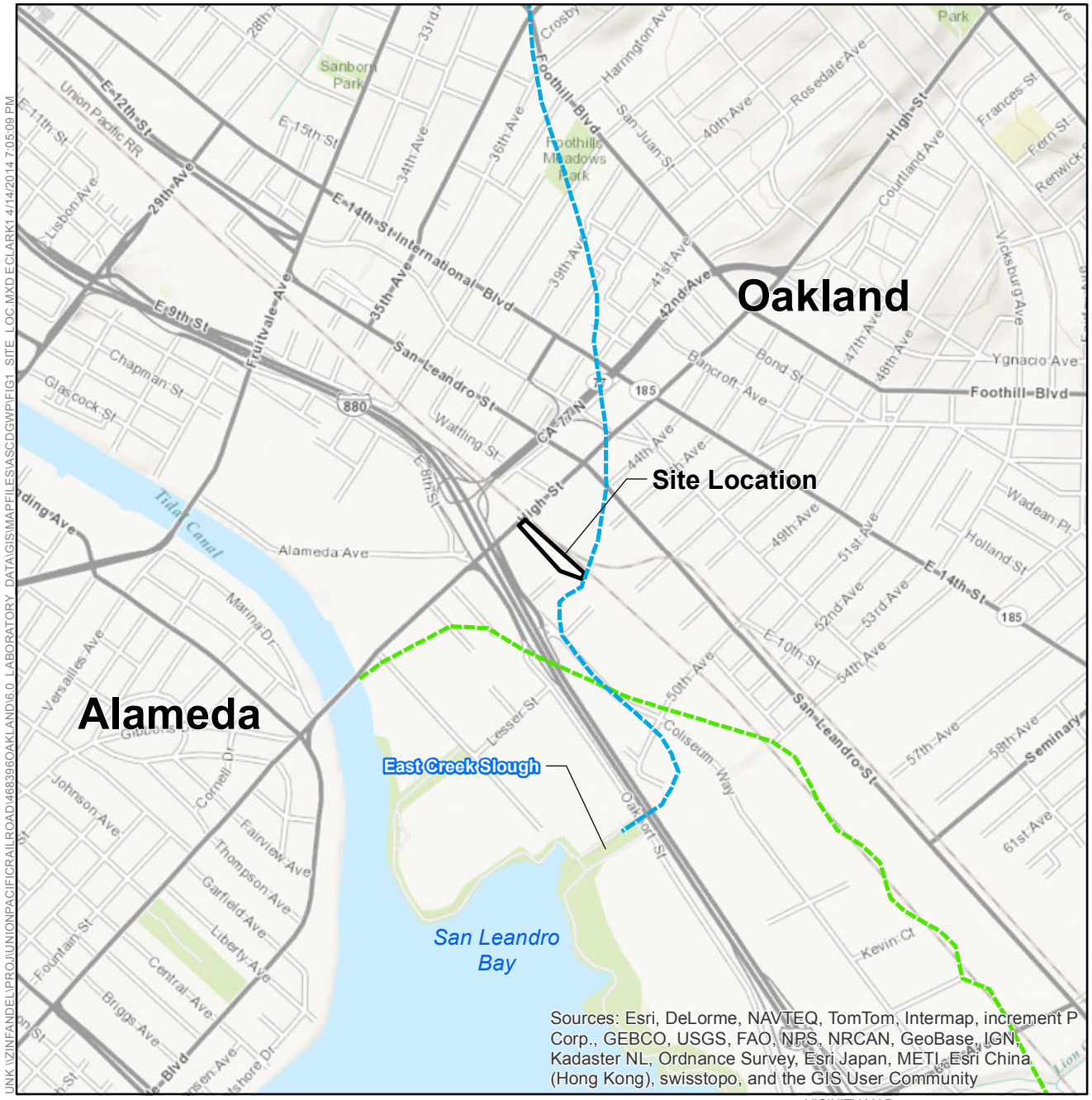

---



Sources: Esri, DeLorme, NAVTEQ, TomTom, Intermap, increment P Corp., GEBCO, USGS, FAO, NPS, NRCAN, GeoBase, IGN, Kadaster NL, Ordnance Survey, Esri Japan, METI, Esri China (Hong Kong), swisstopo, and the GIS User Community

VICINITY MAP

**LEGEND**

-  Site Location
-  Approximate Location of Peralta Creek
-  Approximate Boundary of 1850 Tidal Marshes

Note:  
Creek and historical shoreline features from Sowers and Richard (2009)

Reference:  
Sowers, J.M., and C.M. Richard. 2009. Creek & Watershed Map of Oakland & Berkeley (Fourth Edition). Oakland Museum of California, Oakland, CA.  
<http://www.museumca.org/creeks/images/TitleBlockOak.gif>.  
Accessed on March 10, 2013.

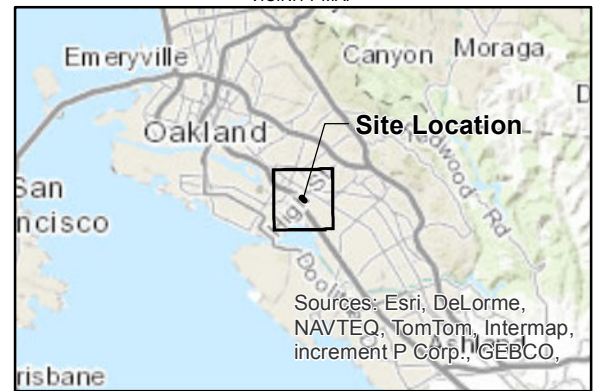

Sources: Esri, DeLorme, NAVTEQ, TomTom, Intermap, increment P Corp., GEBCO,

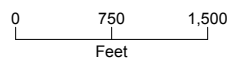

**FIGURE 1**  
**Site Location Map**  
*Addendum to the Site Conceptual Model and Data Gap Work Plan,*  
*744 and 758 High Street, Oakland, California*  
**CH2MHILL.**

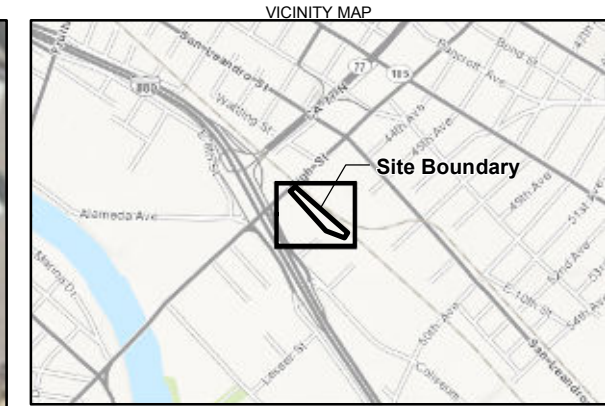
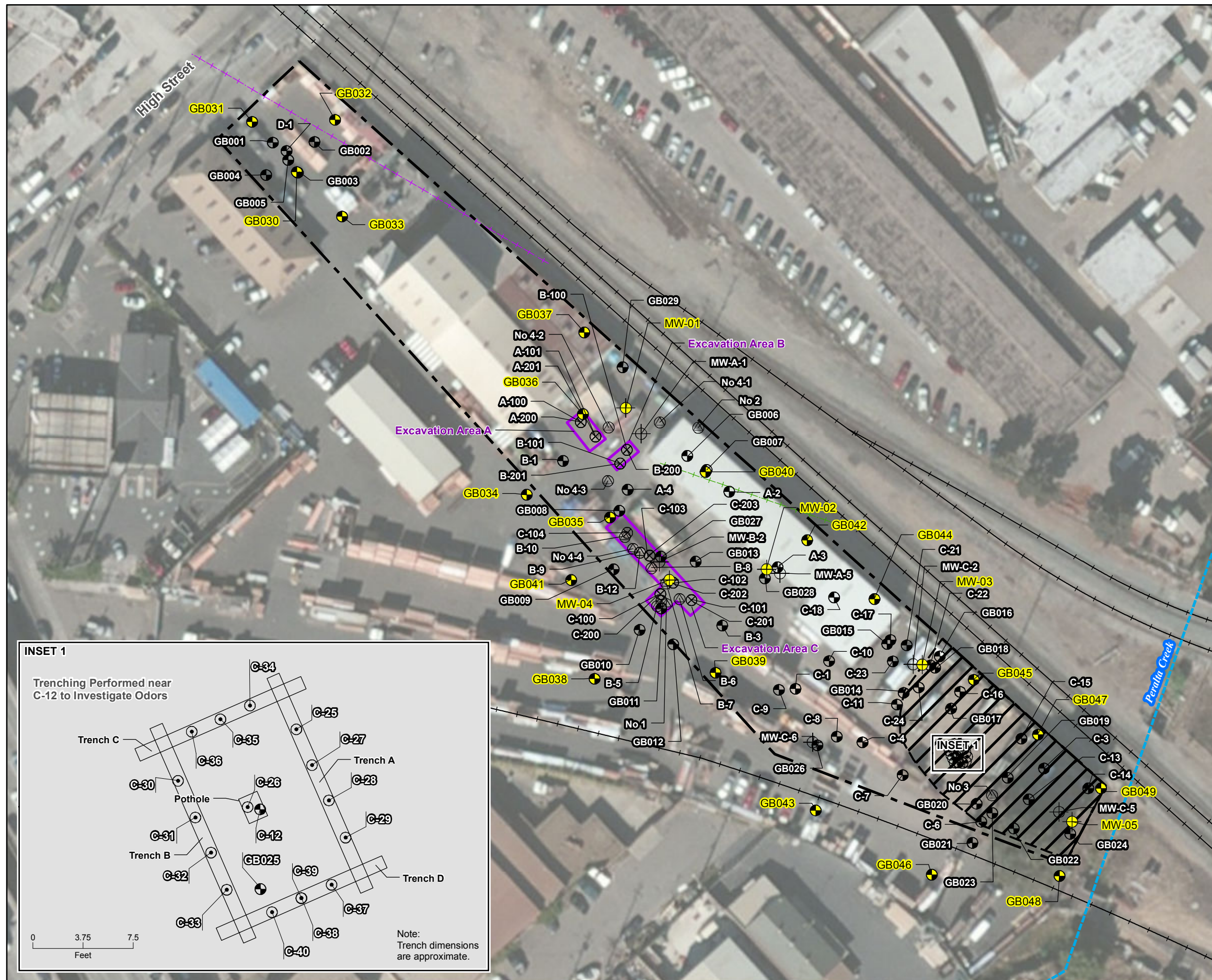

**LEGEND**

- Proposed Monitoring Well
- Proposed Soil Boring
- Surface Soil Sample
- Soil Boring
- Monitoring Well
- Trench Sample
- Excavation Bottom Sample
- Active Rail Line
- Former Rail Spur (1939-1958)
- Former Rail Spur (1944-1989)
- Approximate Location of 1990 Excavation Area
- Site Boundary
- Unpaved Area

**Notes:**

- The years cited for the rail spurs and fenceline represent the earliest and latest documented dates for the feature.
- Monitoring wells MW-A-1, MW-A-5, MW-B-2, MW-C-2, MW-C-5, and MW-C-6 are considered former features. Despite no definite information indicating that the monitoring wells were destroyed, none were located during 2013 field work.
- All locations from previous investigations are approximate and based on positioning from historical documents.

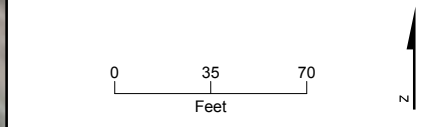
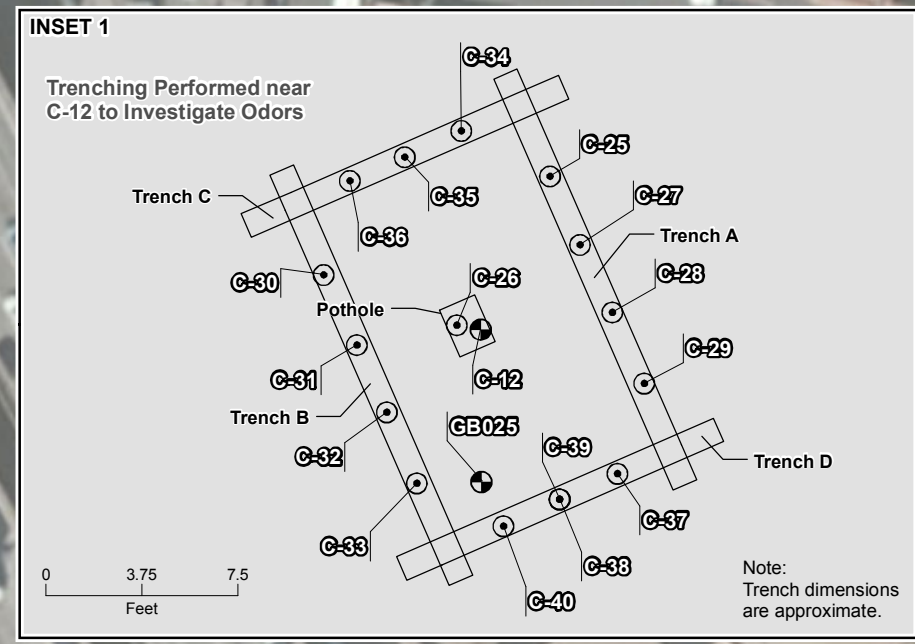

**FIGURE 2**  
**Proposed Boring and Monitoring Well Locations**  
*Addendum to the Site Conceptual Model and Data Gap Work Plan,*  
 744 and 758 High Street, Oakland, California

**Attachment**  
**Well Construction Diagram**

---



**CH2MHILL**

PROJECT NUMBER:

MONITORING WELL:

SHEET 1 OF 1

### WELL COMPLETION DIAGRAM

PROJECT NAME:

LOCATION:

GROUND SURFACE ELEVATION:

DRILLING CONTRACTOR:

DRILLING METHOD AND EQUIPMENT:

WATER LEVELS, DATE AND TIME:

DRILLING START DATE & TIME:

DRILLING FINISH DATE & TIME:

LOGGER:

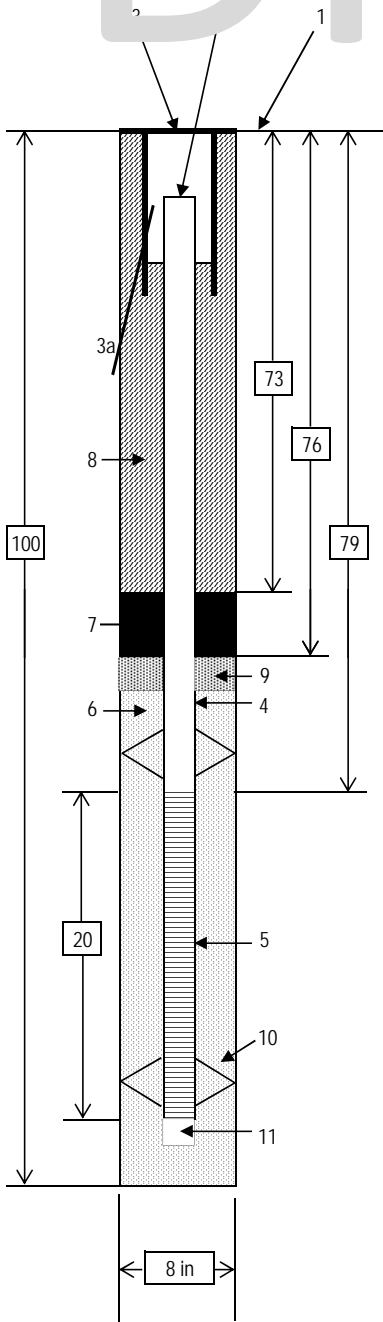

1. Ground elevation of well: TBD (NAVD88)

2. Top of Casing Elevation: TBD (NAVD88)

3. Wellhead protection cover type: 12-inch traffic rated

a) Drain tube installed (Yes/No)?: No

b) Concrete cover dimensions: \_\_\_\_\_

4. Diameter and type of well casing: 2-inch diameter Schedule 40 PVC blank

5. Type and slot size of screen: 2-inch diameter factory slotted Schedule 40 PVC  
0.010-inch apertures

6. Type of Filter Pack:

a) Type of material: Silica Sand #2/16

b) Quantity used: 50-pound bags

7. Type of seal:

a) Type of material: 1/4 inch Bentonite pellets

b) Quantity used: 50-pound bag

8. Grout:

a) Grout mix used: Bentonite-Cement Slurry

b) Method of placement: Freefall

c) Quantity of well casing grout: \_\_\_\_\_ gallons (\_\_\_bags)

9. Transition sand: Silica Sand #0/30

a) Quantity used: 50-pound bags

10. Centralizers: \_\_\_\_\_

a) Quantity used: \_\_\_\_\_

b) Placement (bgs): \_\_\_\_\_

11. PVC Sump: 2-inch diameter Schedule 40 PVC

**Notes:**

bgs = below ground surface

ft = feet

PVC = polyvinyl chloride

NAVD88 = North American Vertical Datum of 1988

NOT TO SCALE