

ALAMEDA COUNTY
HEALTH CARE SERVICES
AGENCY
ALEX BRISCOE, Director



ENVIRONMENTAL HEALTH SERVICES
ENVIRONMENTAL PROTECTION
1131 Harbor Bay Parkway, Suite 250
Alameda, CA 94502-6577
(510) 567-6700
FAX (510) 337-9335

April 15, 2014

Ms. Paula Sime
Tesoro Petroleum Companies, Inc.
400 Oceangate, Ste. 600
Long Beach, CA 90802

Bedrock Oil, Inc.
PO Box 1245
San Ramon, CA 94583-6245

Mr. Sam Hirbod
Hirbod Enterprises
111 Deerwood Road, Suite 110
San Ramon, CA 94583

Ms. Barbara Wozniak
Flyers LLC
2360 Lindbergh Street
Auburn, CA 95601-9537

Mr. Robert Ehlers
Valero
685 West Third Street
Hanford, CA 93230

Mr. Bill Borgh
ConocoPhillips
76 Broadway
Sacramento, CA 95818

Abdula and Ramsey Mohamed
3401 Laguna, Ste.#3
Oakland, CA 94602

Mr. John Giguere
Giguere Enterprises, Inc.
2888 Gray Fox Ct.
Pleasanton, CA 94566-6920

Subject: Case Closure for Fuel Leak Case No. RO0000498 and GeoTracker Global ID T0600101414,
Beacon #721, 44 Lewelling Blvd., San Lorenzo, CA 94580

Dear Responsible Parties:

This letter transmits the enclosed underground storage tank (UST) case closure letter in accordance with Chapter 6.75 (Article 4, Section 25296.10[g]). The State Water Resources Control Board adopted this letter on February 20, 1997. As of March 1, 1997, the Alameda County Environmental Health (ACEH) is required to use this case closure letter for all UST leak sites. We are also transmitting to you the enclosed case closure summary. These documents confirm the completion of the investigation and cleanup of the reported release at the subject site. The subject fuel leak case is closed. This case closure letter and the case closure summary can also be viewed on the State Water Resources Control Board's Geotracker website (<http://geotracker.swrcb.ca.gov>) and the Alameda County Environmental Health website (<http://www.acgov.org/aceh/index.htm>).

Due to residual contamination, the site was closed with Site Management Requirements that limit future land use to the current commercial land use. Site Management Requirements are further described in section IV of the attached Case Closure Summary.

If you have any questions, please call Jerry Wickham at (510) 567-6791. Thank you.

Sincerely,

Dilan Roe, P.E.
LOP and SCP Program Manager

Responsible Parties
RO0000498
April 15, 2014
Page 2

Enclosures: 1. Remedial Action Completion Certification
 2. Case Closure Summary

Cc w/enc.:

Michael Purchase, ARCTOS Environmental, 1332 Peralta Avenue, Berkeley, CA 94702 (*Sent via E-mail to: mpurchase@orionenv.com*)

Leroy Griffin, Oakland Fire Department, 250 Frank H. Ogawa Plaza, Ste. 3341, Oakland, CA 94612-2032 2032 (*Sent via E-mail to: lgriffin@oaklandnet.com*)

Jerry Wickham, ACEH (*Sent via E-mail to: jerry.wickham@acgov.org*)
GeoTracker, eFile



REMEDIAL ACTION COMPLETION CERTIFICATION

April 15, 2014

Ms. Paula Sime
Tesoro Petroleum Companies, Inc.
400 Oceangate, Ste. 600
Long Beach, CA 90802

Bedrock Oil, Inc.
PO Box 1245
San Ramon, CA 94583-6245

Mr. Sam Hirbod
Hirbod Enterprises
111 Deerwood Road, Suite 110
San Ramon, CA 94583

Ms. Barbara Wozniak
Flyers LLC
2360 Lindbergh Street
Auburn, CA 95601-9537

Mr. Robert Ehlers
Valero
685 West Third Street
Hanford, CA 93230

Mr. Bill Borgh
ConocoPhillips
76 Broadway
Sacramento, CA 95818

Abdula and Ramsey Mohamed
3401 Laguna, Ste.#3
Oakland, CA 94602

Mr. John Giguere
Giguere Enterprises, Inc.
2888 Gray Fox Ct.
Pleasanton, CA 94566-6920

Subject: Case Closure for Fuel Leak Case No. RO0000498 and GeoTracker Global ID T0600101414, Beacon #721, 44 Lewelling Blvd., San Lorenzo, CA 94580

Dear Responsible Parties:

This letter confirms the completion of a site investigation and remedial action for the underground storage tanks formerly located at the above-described location. Thank you for your cooperation throughout this investigation. Your willingness and promptness in responding to our inquiries concerning the former underground storage tank(s) are greatly appreciated.

Based on information in the above-referenced file and with the provision that the information provided to this agency was accurate and representative of site conditions, this agency finds that the site investigation and corrective action carried out at your underground storage tank(s) site is in compliance with the requirements of subdivisions (a) and (b) of Section 25296.10 of the Health and Safety Code and with corrective action regulations adopted pursuant to Section 25299.3 of the Health and Safety Code and that no further action related to the petroleum release(s) at the site is required.

Please be aware that claims for reimbursement of corrective action costs submitted to the Underground Storage Tank Cleanup Fund more than 365 days after the date of this letter or issuance or activation of the Fund's Letter of Commitment, whichever occurs later, will not be reimbursed unless one of the following exceptions applies:

- Claims are submitted pursuant to Section 25299.57, subdivision (k) (reopened UST case); or
- Submission within the timeframe was beyond the claimant's reasonable control, ongoing work is required for closure that will result in the submission of claims beyond that time period, or that under the circumstances of the case, it would be unreasonable or inequitable to impose the 365-day time period.

This notice is issued pursuant to subdivision (g) of Section 25296.10 of the Health and Safety Code. Please contact our office if you have any questions regarding this matter.

Sincerely,



Ariu Levi
Director

**CASE CLOSURE SUMMARY
LEAKING UNDERGROUND FUEL STORAGE TANK - LOCAL OVERSIGHT PROGRAM**

I. AGENCY INFORMATION

Date: August 7, 2013

Agency Name: Alameda County Environmental Health	Address: 1131 Harbor Bay Parkway
City/State/Zip: Alameda, CA 94502-6577	Phone: (510) 567-6791
Responsible Staff Person: Jerry Wickham	Title: Senior Hazardous Materials Specialist

II. CASE INFORMATION

Site Facility Name: Beacon #3721		
Site Facility Address: 44 Lewelling Boulevard, San Lorenzo, 94580		
RB Case No.: 01-1531	Local Case No.: STID 1497	LOP Case No.: RO0000498
URF Filing Date: 05/08/87	Geotracker ID: T0600101414	APN: 413-70-4-4

Responsible Parties	Addresses	Phone Numbers
Paula Sime Tesoro Petroleum Companies, Inc.	400 Oceangate, Suite 600 Long Beach, CA 90802	562-495-6916
Bedrock Oil, Inc.	P.O.Box 1245 San Ramon, CA 94583-6245	No phone number
Abdula and Ramsey Mohamed	3401 Laguna #3 Oakland, CA 94602	No phone number
Barbara Wozniak Flyers LLC	2360 Lindbergh Street Auburn, CA 95602-9537	No phone number
Giguere Enterprises, Inc.	2888 Gray Fox Ct. Pleasanton, CA 94566-6920	No phone number
Bill Borgh ConocoPhillips	76 Broadway Sacramento, CA 95818	916-558-7612
Robert Ehlers Valero	685 West Third Street Hanford, CA 93230	210-345-2227
Sam Hirbod Hirbod Enterprises	111 Deerwood Road, Suite 110 San Ramon, CA 94583	No phone number

Tank I.D. No	Size in Gallons	Contents	Closed In Place/Removed?	Date
----	7,500	Gasoline	Removed	4/28/1987
----	10,000	Gasoline	Removed	4/28/1987
----	10,000	Gasoline	Removed	4/28/1987
Piping			Removed	7/10/2001

III. RELEASE AND SITE CHARACTERIZATION INFORMATION

Cause and Type of Release: Unknown. At the time of tank removal on April 28, 1987, the tanks had slight to moderate corrosion and pitting; however, no holes or other signs of failure were observed in the tanks.		
Site characterization complete? Yes	Date Approved By Oversight Agency: ----	
Monitoring wells installed? Yes	Number: 19	Proper screened interval? Yes
Highest GW Depth Below Ground Surface: 10.25 feet bgs	Lowest Depth: 33.59 feet bgs	Flow Direction: Southwest
Most Sensitive Current Use: Potential drinking water source.		

Summary of Production Wells in Vicinity: There are 11 water supply wells with an active status within 1,000 feet of the site. In addition, there are 4 water supply wells with a non-active status and 4 wells with an unknown status within 1,000 feet of the site. Irrigation wells at 15800 Via Cordoba and 15808 Via Cordoba are approximately 175 to 200 feet downgradient from the edge of the plume and appear to be the nearest water supply wells. The two irrigation wells on Cordoba Drive were sampled five times between January 2003 and May 2007. Petroleum hydrocarbons and fuel oxygenates were not detected at concentrations above reporting limits. Based on the current plume extent, decreasing trends in concentrations which indicate that the plume is shrinking, and sampling results, the irrigation wells at 15800 Via Cordoba and 15808 Via Cordoba are not expected to be receptors for the site. An irrigation well at 246 Peach Drive, which is approximately 600 feet downgradient from the edge of the plume, was sampled four times between September 2006 and May 2007. Petroleum hydrocarbons and fuel oxygenates were not detected at concentrations above reporting limits during three of the four sampling events. During one sampling event, TBA was detected at a concentration of 7 ppb. Based on the current plume extent, decreasing trends in concentrations which indicate that the plume is shrinking, and sampling results, the irrigation well at 246 Peach Drive is not expected to be a receptor for the site. Eleven additional irrigation wells are located south and southeast of the site at greater distances from the plume than the irrigation wells at 15800 Via Cordoba and 15808 Via Cordoba. Based on the current plume extent and decreasing trends in concentrations which indicate that the plume is shrinking, the eleven additional irrigation wells are not expected to be receptors for the site.

A 65-foot deep irrigation well and an 80-foot deep irrigation wells are located approximately 350 to 400 feet west northwest of the plume. Based on their cross gradient location and distance from the site, the irrigation wells are not expected to be receptors for the site.

Two water supply wells are located at San Lorenzo High School, approximately 600 feet northeast (upgradient) from the site. The water supply wells are 600 and 616 feet deep, respectively, with perforations beginning at a depth of 142 feet below ground surface. Based on the upgradient location and distance from the site, the San Lorenzo High School water supply wells are not expected to be receptors for the site.

Are drinking water wells affected? No	Aquifer Name: East Bay Plain
Is surface water affected? No	Nearest SW Name: San Lorenzo Creek is approximately 150 feet southwest of the site. The channel is concrete-lined.
Off-Site Beneficial Use Impacts (Addresses/Locations): None identified.	
Reports on file? Yes	Where are reports filed? Alameda County Environmental Health

TREATMENT AND DISPOSAL OF AFFECTED MATERIAL			
Material	Amount (Include Units)	Action (Treatment or Disposal w/Destination)	Date
Tank	Three 10,000-gallon USTs	Disposal Destination Not Reported	April 28, 1987
Piping	Not Reported	Not Reported. Assumed Disposed with USTs	April 28, 1987
Free Product	----	----	----
Soil	31.25 cubic yards	Disposal at Forward Landfill in Stockton, CA	July 13, 2001
Groundwater	1,184,000 gallons 7,040,000 gallons	Groundwater was treated, and discharged to the sanitary sewer under permit to Oro Loma Sanitary District	April 1993 to December 1995 October 2000 to March 2008

MAXIMUM DOCUMENTED CONTAMINANT CONCENTRATIONS BEFORE AND AFTER CLEANUP (Please see Attachments 1 through 6 for additional information on contaminant locations and concentrations)				
Contaminant	Soil (ppm)		Water (ppb)	
	Before	After	Before	After
TPH (Gas)	1,900	1,900	2,100,000 ⁽¹⁾	2,200 ⁽¹⁾
TPH (Diesel)	----	----	----	----
Oil and Grease	----	----	----	----
Benzene	52	28	19,000 ⁽¹⁾	15 ⁽¹⁾
Toluene	158	136	22,000 ⁽¹⁾	<0.5 ⁽¹⁾
Ethylbenzene	43	29	22,000 ⁽¹⁾	6 ⁽¹⁾
Xylenes	288	179	4,300 ⁽¹⁾	0.95 ⁽¹⁾
Heavy Metals (Cd, Cr, Pb, Ni, Zn)	7.9 ⁽²⁾	7.9 ⁽²⁾	Not Analyzed	Not Analyzed
MTBE	13 ⁽³⁾	13 ⁽³⁾	97,000 ⁽⁴⁾	6.1 ⁽⁵⁾
Other (8240/8270)	----	----	----	----

Notes:

⁽¹⁾ Maximum concentration before cleanup is a groundwater sample from monitoring well MW-1 collected on June 21, 1990; maximum concentration after cleanup is from the most recent groundwater monitoring event on January 2, 2013.

⁽²⁾ Lead = 7.9 ppm; no other metals analyzed.

⁽³⁾ MTBE = 13 ppm; TBA = 1.7 ppm; TAME = 0.04 ppm; DIPE, ETBE, EDB, and EDC <0.01 ppm in soil

⁽⁴⁾ MTBE = 97,000 ppb; TBA = 580 ppb; TAME = 68 ppb; DIPE and ETBE <0.5 ppb; EDB and EDC not analyzed.

⁽⁵⁾ From the most recent groundwater monitoring event on January 2, 2013: MTBE = 6.1 ppb; TBA = 13 ppb; TAME, DIPE, and ETBE <0.5 ppb; EDB and EDC not analyzed.

Site History and Description of Corrective Actions:

The site is an active gasoline service station near the intersection of Via Granada and Lewelling Boulevard in San Lorenzo, CA. Surrounding land use is mixed commercial and residential.

On April 28, 1987, three underground storage tanks (USTs) were excavated and removed during tank replacement activities. Total Volatile Hydrocarbons (TVH) and benzene were detected in 5 of 6 soil samples collected beneath the ends of each UST at a depth of approximately 14 feet bgs (3 to 4 feet below the tank bottom) at concentrations up to 1,136 and 52 parts per million (ppm), respectively. On April 30, 1987, the excavation was extended down to the saturated zone in the vicinity of sample S-3. A soil sample collected at the bottom of the excavation at a depth of 17 feet bgs detected 7 ppm TVH and 1.4 ppm benzene. The volume of soil removed and disposed off-site during the tank removal and over-excavation near sample S-3 was not reported. New tanks were installed and the excavation was reportedly backfilled with imported pea gravel.

Three groundwater monitoring wells (MW-1 through MW-3) were installed near the USTs on May 26, and 27, 1987. A total of four soil samples collected from the three borings detected up to 101 ppm TVH. Groundwater samples collected from the wells on May 29, 1987 detected up to 40,300 parts per billion (ppb) Total Petroleum Hydrocarbons as gasoline (TPHg) and 5,400 ppb benzene.

In December 1988, four groundwater monitoring wells (MW-4 through MW-7) were installed and soil boring B-1 was advanced to a depth of 37 feet. Soil samples from the monitoring well borings and boring B-1 detected up to 250 ppm TPHg and 0.55 ppm benzene.

Two off-site monitoring wells MW-8 and MW-9 were installed west and south of the site, respectively, in September 1989. TPHg was detected in soil from the MW-8 boring at concentrations up to 43 ppm but was not detected at concentrations above the reporting limit in soil samples from the MW-9 boring. Benzene was not detected in soil samples from the two well borings. During groundwater sampling in 1990, up to 0.9 feet of free product was measured in monitoring wells MW-1 and MW-2.

In October 1991, off-site monitoring wells MW-10 and MW-11 were installed southwest (downgradient) from the site and recovery well RW-1 was installed on-site. TPHg and benzene were detected in soil samples from the RW-1 borings at concentrations up to 1,900 and 7.9 ppm, respectively. TPHg and benzene were not detected at concentrations above the reporting limit in soil samples from the MW-10 and MW-11 borings.

Soil and groundwater remediation systems were installed between April 1993 and December 1995. Three air sparge wells (AS-1 through AS-3) were installed in October 1995. Groundwater extraction began in March 1994 and removed, treated, and discharged approximately 1,184,000 gallons of groundwater. Soil vapor extraction (SVE) began in March 1994 and removed 103 gallons of TPHg before being shut down in January 1997.

The SVE system was restarted in April 2000 to further remediate the site. From April 2000 to November 2003, the SVE system removed a total of approximately 211 pounds of TPHg. The SVE and air sparge systems were shut down in November 2003 when influent concentrations decreased and the system reached the limit of its effectiveness.

The groundwater extraction system was restarted in October 2000 and operated until March 2008. During this period, approximately 7,040,000 gallons of water was removed, treated, and discharged. The groundwater extraction system was shut down in March 2008 based on low transmissivity and extraction rates.

During station upgrade activities in July 2001, the product lines, dispensers, fill ports, turbines, and concrete cover over the tank basin were replaced. Six product line and dispenser soil samples collected on July 10, 2001, detected up to 9.7 ppm TPHg and 0.99 ppm benzene. Contaminated soil was encountered in the vicinity of the eastern and western dispenser islands. Approximately 8.25 cubic yards of contaminated soil was overexcavated from the eastern and western dispenser islands. Two over-excavation soil samples collected from a depth of 5 feet bgs did not detect TPHg or benzene at concentrations above the reporting limit.

In September 2004, monitoring well MW-3 was replaced with recovery well MW-3R and recovery well RW-2 was installed on-site. Soil samples collected from the RW-2 boring detected up to 11 ppm TPHg.

Site History and Description of Corrective Actions (continued):

In June 2007, three soil borings (DP-1 through DP-3) were advanced south southwest of the site to address a potential data gap in plume delineation in the area between wells MW-9 and MW-11. TPHg was detected in soil samples from the borings at concentrations up to 8.5 ppm. Benzene and MTBE were not detected in soil samples at concentrations above the reporting limits. Based on the soil boring results, monitoring well MW-12 was installed adjacent to boring DP-1 to provide monitoring of the plume to the south southwest.

Oxygen injection wells OS-1 through OS-4 were installed in the western portion of the site in 2008 and the oxygen injection was initiated in March 2009. Based on monitoring results that indicated dissolved oxygen concentrations were above 1 milligram per liter in downgradient well PT-1 and decreases in petroleum hydrocarbon concentrations, oxygen injection was stopped in March 2011.

Groundwater monitoring has been conducted since the second quarter of 1987. Following groundwater remediation, the concentrations of TPHg, benzene, and MTBE in groundwater have decreased up to 99% from the maximum observed concentrations. Verification monitoring after remediation indicates the plume of petroleum hydrocarbons is stable and decreasing in extent. During the groundwater monitoring event on January 2, 2013, the maximum concentrations of TPHg, benzene, and MTBE in groundwater were 2,200, 15 and 3.6 ppb, respectively.

IV. CLOSURE

Does completed corrective action protect existing beneficial uses per the Regional Board Basin Plan? Yes		
Does completed corrective action protect potential beneficial uses per the Regional Board Basin Plan? Yes		
Does corrective action protect public health for current land use? Alameda County Environmental Health staff does not make specific determinations concerning public health risk. However, based upon the information available in our files to date, closure of this site appears to be consistent with the policies established by the State Water Resources Control Board Low-Threat Underground Storage Tank Closure Policy which became effective on August 17, 2012.		
Site Management Requirements: This fuel leak case has been evaluated for closure consistent with the State Water Resources Control Board Low-Threat Underground Storage Tank Closure Policy (LTCP). Based on this evaluation, no site management requirements appear to be necessary.		
Should corrective action be reviewed if land use changes? No		
Was a deed restriction or deed notification filed? No		Date Recorded: ----
Monitoring Wells Decommissioned: No	Number Decommissioned: 0	Number Retained: 19
List Enforcement Actions Taken: None		
List Enforcement Actions Rescinded: ----		

V. ADDITIONAL COMMENTS, DATA, ETC.

Considerations and/or Variances:

EDB and EDC were not analyzed in groundwater.

The site meets the general criteria for case closure under the LTCP.

The site does not meet the groundwater media-specific criteria in scenarios 1 through 4 for closure under the LTCP based on the following:

1. The plume is greater than 100 but less than 250 feet in length.
2. There are 11 water supply wells with an active status within 1,000 feet of the site.
3. San Lorenzo Creek is approximately 150 feet southwest of the site.

Although the site does not meet the groundwater media specific criteria in scenarios 1 through 4, closure of the site is appropriate based on an analysis of site specific conditions (scenario 5) that includes the following:

1. The plume is stable or decreasing in size.
2. The downgradient edge of the plume appears to be approximately 175 feet from the nearest irrigation well.
3. Sampling of three irrigation wells downgradient from the site indicates that the plume has not impacted the wells. Since the plume is stable and decreasing in size, the wells are not expected to be receptors in the future. Therefore, under current and reasonably anticipated near-term future scenarios, the site appears to pose a low threat to the irrigation wells.
4. There is no free product.
5. During the most recent groundwater monitoring event, the maximum dissolved concentration of benzene on-site was 15 ppb and benzene was not detected at concentrations above the reporting limit in groundwater from off-site monitoring wells.
6. During the most recent groundwater monitoring event, the maximum dissolved concentration of MTBE on-site was 6.1 ppb and the maximum concentration of MTBE off-site was 0.62 ppb.
7. San Lorenzo Creek is within a concrete-lined channel and is not expected to be a receptor from the plume.

Since the site is an active commercial fueling station, the LTCP does not require evaluation of the potential for vapor intrusion to indoor air for the on-site building. No soil vapor sampling has been performed at the site. Based on the apparent horizontal distance between off-site buildings and the residual contamination and the criteria for consideration of bioattenuation zones described in the LTCP, evaluation of the potential for vapor intrusion to indoor air does not appear to be warranted for the off-site buildings.

The maximum concentrations of benzene and ethylbenzene detected in soil samples collected to date within the upper 10 feet are less than the media-specific criteria in Table 1 of the LTCP for direct contact and outdoor air exposure. Since the release at the site consisted primarily of gasoline, naphthalene concentrations are not likely to exceed the media-specific criteria in Table 1 of the LTCP. Therefore, the site appears to meet the media-specific criteria for direct contact and outdoor air exposure under the LTCP.

Conclusion:

Alameda County Environmental Health staff believe that the site meets the conditions for case closure under the State Water Resources Control Board Low-Threat Underground Storage Tank Closure Policy. Based upon the information available in our files to date, no further investigation or cleanup for the fuel leak case is necessary at this time.

VI. LOCAL AGENCY REPRESENTATIVE DATA

Prepared by: Jerry Wickham, P.G.	Title: Senior Hazardous Materials Specialist
Signature: <i>Jerry Wickham</i>	Date: 8/7/13
Approved by: Donna L. Drogos, P.E.	Title: Division Chief
Signature: <i>Donna L. Drogos</i>	Date: 8/7/13

This closure approval is based upon the available information and with the provision that the information provided to this agency was accurate and representative of site conditions.

VII. REGIONAL BOARD NOTIFICATION

Regional Board Staff Name: Cherie McCaulou	Title: Engineering Geologist
Notification Date: 7/24/13	

VIII. MONITORING WELL DECOMMISSIONING

Date Requested by ACEH: 10/03/13	Date of Well Decommissioning Report: 03/06/14	
All Monitoring Wells Decommissioned: <input checked="" type="radio"/> Yes <input type="radio"/> No	Number Decommissioned: 25	Number Retained: 0
Reason Wells Retained: NA		
Additional requirements for submittal of groundwater data from retained wells: None		
ACEH Concurrence - Signature: <i>Jerry Wickham</i>	Date: 04/15/14	

Attachments:

1. Site Vicinity Maps and Aerial Photo (3 pp)
2. Site Plans and Groundwater Concentration Maps (6 pp)
3. Groundwater Elevation and Concentration Graphs (7 pp)
4. Soil Analytical Data (7 pp)
5. Groundwater Analytical Data (28 pp)
6. Boring Logs (37 pp)

This document and the related CASE CLOSURE LETTER & REMEDIAL ACTION COMPLETION CERTIFICATE shall be retained by the lead agency as part of the official site file.

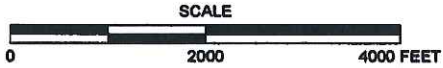
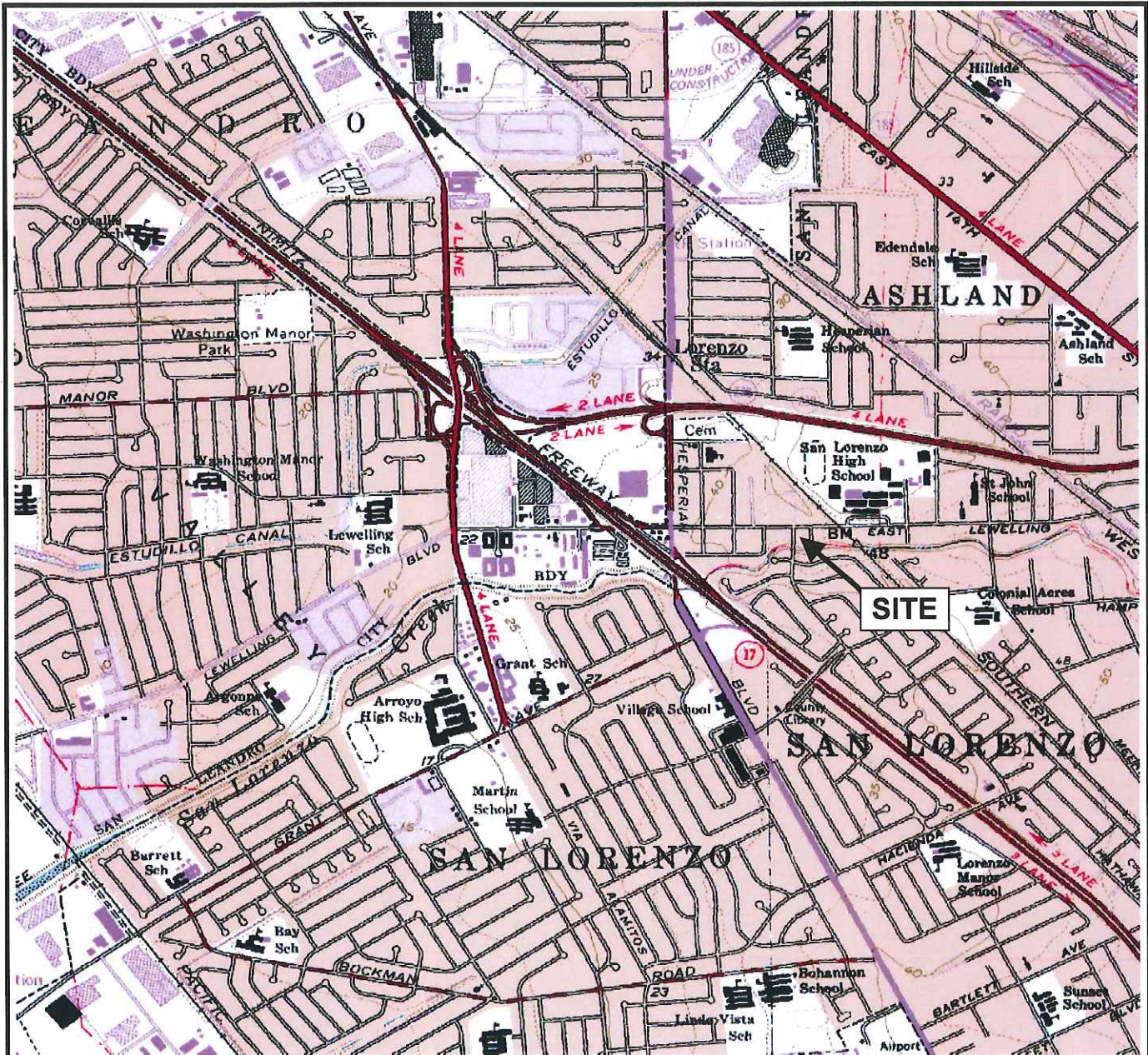

REFERENCE
 7.5 MINUTE USGS TOPOGRAPHIC MAPS OF
 SAN LEANDRO AND HAYWARD, CALIFORNIA QUADRANGLES
 DATE: 1959, PHOTOREVISED 1980
 SCALE = 1:24,000

ARCTOS ENVIRONMENTAL			
TESORO - SAN LORENZO, 67107			
SITE LOCATION MAP			
PROJECT NO. 01ZO	DRAWN BY MP	CHECKED BY MP	APPROVED BY JG
FILE NO. Site Map.xls		FIGURE 1	

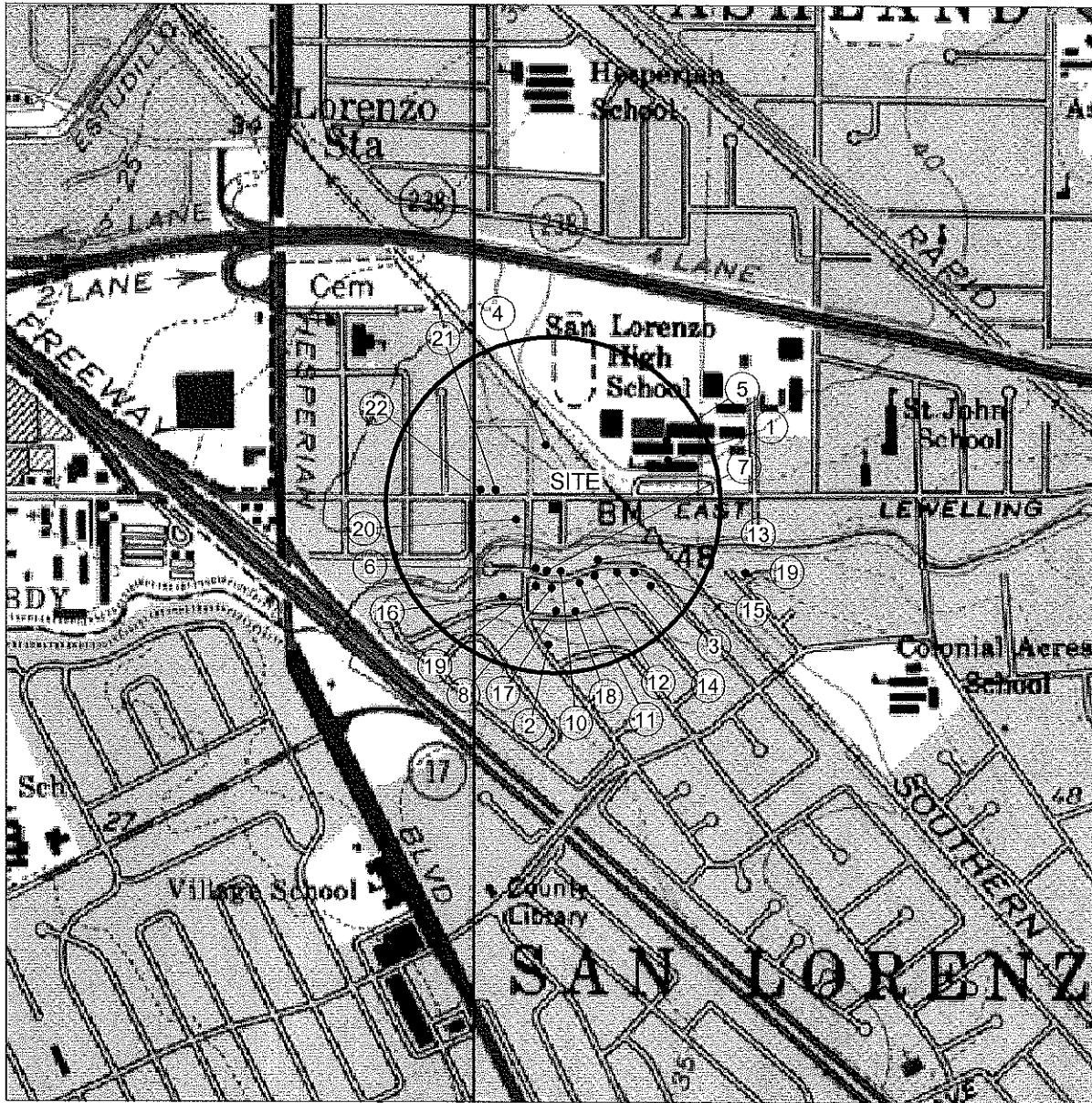

T.3S.

R.2W.

GENERAL NOTES:
 BASE MAP FROM U.S.G.S.
 HAYWARD, CA.
 7.5 MINUTE TOPOGRAPHIC
 PHOTOREVISED 1980



QUADRANGLE LOCATION

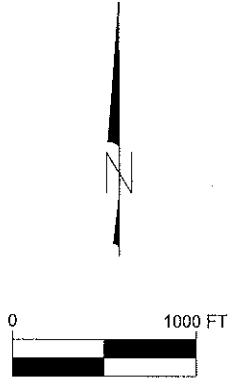

SCALE

FIGURE 3

WELL SEARCH MAP

TESORO STATION NO. 67107
 (FORMER BEACON STATION NO. 3721)
 44 LEWELLING BOULEVARD
 SAN LORENZO, CA.

PROJECT NO. 00-3721	DRAWN BY M.L. 7/10/06
FILE NO. 00-3721-1A	PREPARED BY RDM
REVISION NO. 2	REVIEWED BY



Environmental

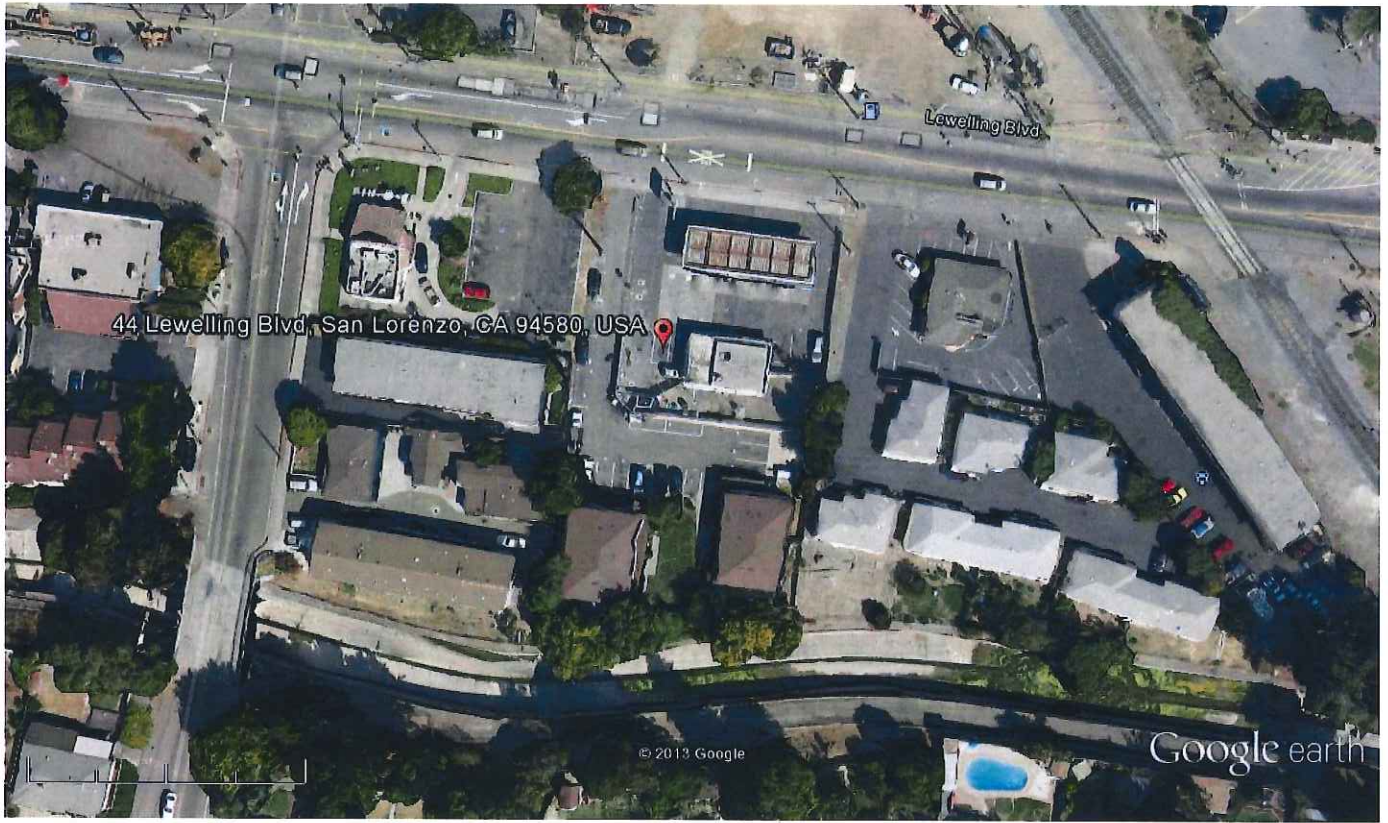

44 Lewelling Blvd, San Lorenzo, GA 94580, USA

Lewelling Blvd

© 2013 Google

Google earth

Google earth

feet
meters



Legend

- MW-1 (30.46) Monitoring Well with 2 January 2013 Groundwater Elevation (Feet MSL)
- DP-1 (31.39) Soil Boring
- OS-1 (31.0) Oxygen Injection Well
- 30.60 Groundwater Elevation Contour (Feet MSL)
- * Elevation Not Used For Contours
- A-A' Geologic Cross Section AA'

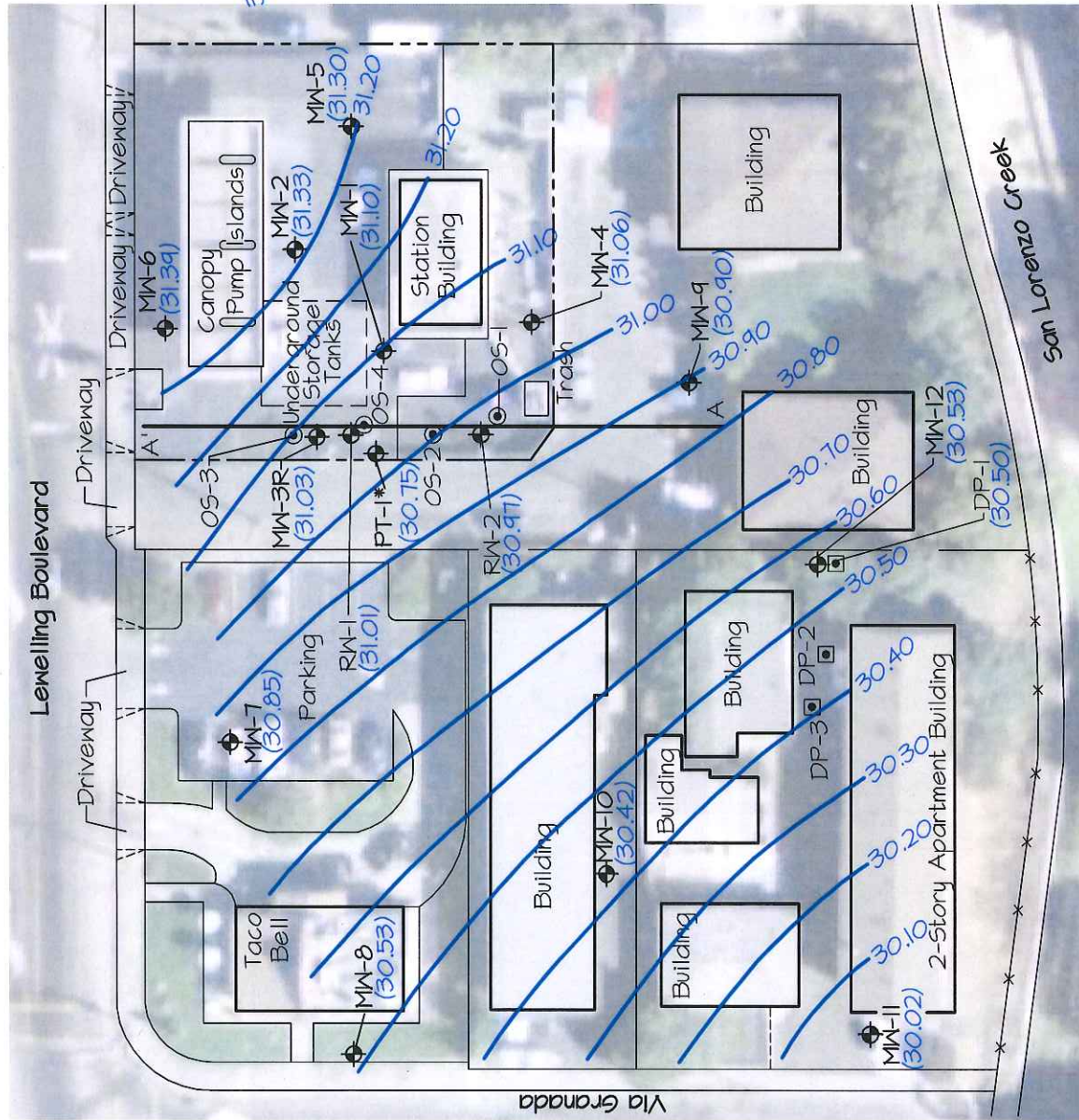

REVISION		REVISIONS	
NO.	BY	DATE	DESCRIPTION
13	MY	6/20/11	Second Quarter 2011 Status Report
14	MY	12/15/11	Fourth Quarter 2011 Status Report
15	MY	7/15/12	2012 Status Report and Request for Closure
16	MY	1/24/13	Fourth Quarter 2012 Status Report

ARCTOS ENVIRONMENTAL			
TESORO - SAN LORENZO			
SITE PLAN			
PROJECT NO.	DRAWN BY	CHECKED BY	APPROVED BY
0120	MY	MP	JPG

ATTACHMENT 2

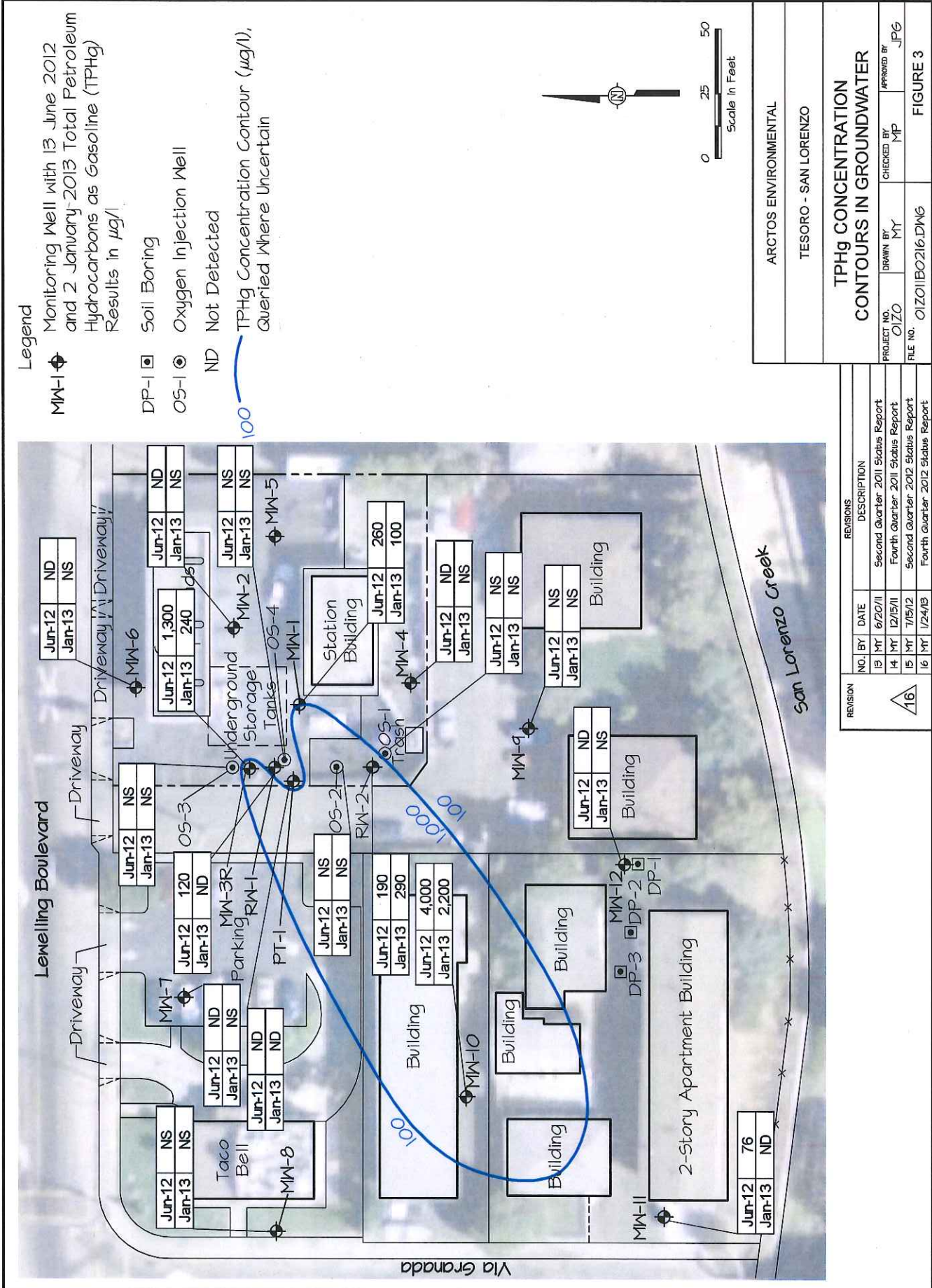

Legend

- MW-1 Monitoring Well with 13 June 2012 and 2 January-2013 Total Petroleum Hydrocarbons as Gasoline (TPHg) Results in µg/l
- DP-1 Soil Boring
- OS-1 Oxygen Injection Well
- ND Not Detected
- 100 TPHg Concentration Contour (µg/l), Queried Where Uncertain



ARCTOS ENVIRONMENTAL	
TESORO - SAN LORENZO	
TPHg CONCENTRATION CONTOURS IN GROUNDWATER	
PROJECT NO. O120	CHECKED BY: MP
DRAWN BY: MY	APPROVED BY: JPG
FILE NO. O12011B0216.DWG	FIGURE 3

REVISION		REVISIONS	
NO.	BY	DATE	DESCRIPTION
13	MY	6/20/11	Second Quarter 2011 Status Report
14	MY	12/15/11	Fourth Quarter 2011 Status Report
15	MY	7/15/12	Second Quarter 2012 Status Report
16	MY	1/24/13	Fourth Quarter 2012 Status Report

Legend

- MW-1 Monitoring Well with 13 June 2012 and 2 January 2013 Benzene Results in $\mu\text{g/l}$
- OS-1 Oxygen Injection Well
- DP-1 Soil Boring
- ND Not Detected
- 10 Benzene Concentration Contour ($\mu\text{g/l}$), Queried Where Uncertain

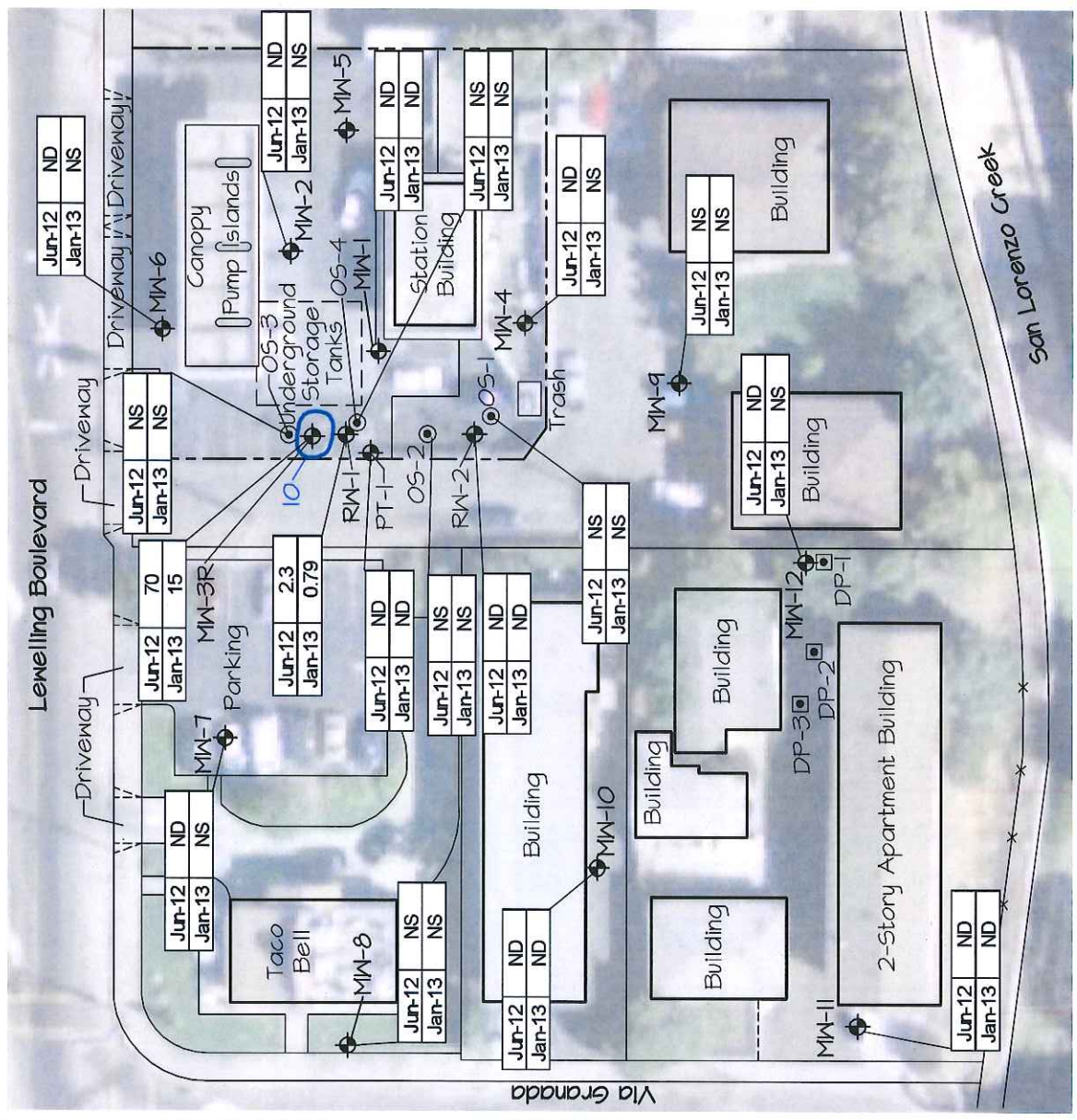

ARCTOS ENVIRONMENTAL	
TESORO - SAN LORENZO	
BENZENE CONCENTRATION CONTOURS IN GROUNDWATER	
PROJECT NO. 0120	CHECKED BY M/P
DRAWN BY M/Y	APPROVED BY J/P
FILE NO. 012011B0316.DWG	FIGURE 4

REVISION		REVISIONS	
NO.	BY	DATE	DESCRIPTION
13	MT	6/20/11	Second Quarter 2011 Status Report
14	MT	12/15/11	Fourth Quarter 2011 Status Report
15	MT	7/15/12	Second Quarter 2012 Status Report
16	MT	1/24/13	Fourth Quarter 2012 Status Report

Legend

- MW-1 Monitoring Well with 13 June 2012 and 2 January 2013 Methyl Tert-Butyl Ether (MTBE) Results in $\mu\text{g/l}$
- OS-1 Oxygen Injection Well
- DP-1 Soil Boring
- ND Not Detected
- MTBE Concentration Contour ($\mu\text{g/l}$), Queried Where Uncertain

Scale In Feet
0 25 50

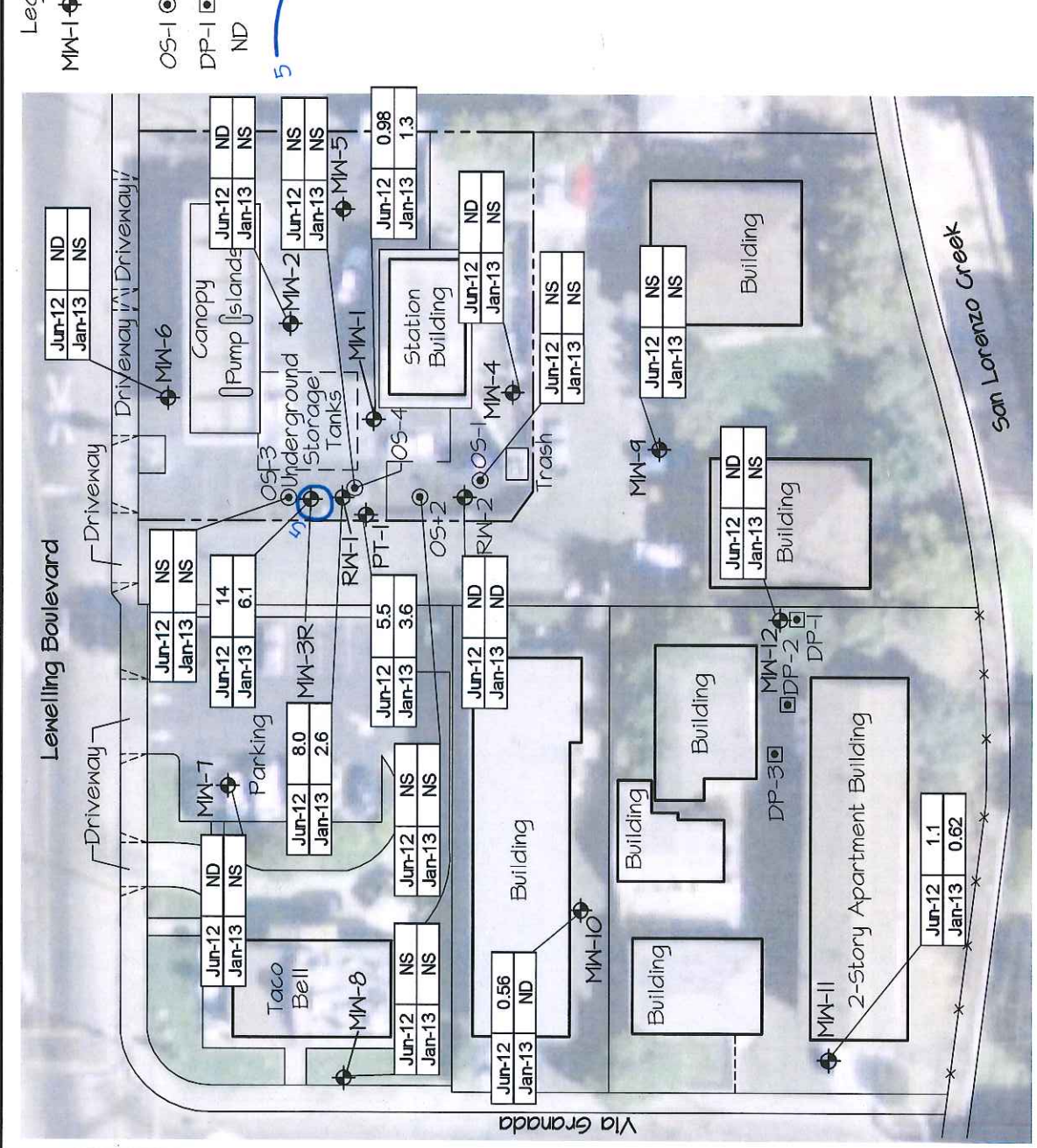

NO.	BY	DATE	DESCRIPTION
13	MT	6/20/11	Second Quarter 2011 Status Report
14	MT	12/15/11	Fourth Quarter 2011 Status Report
15	MT	7/15/12	Second Quarter 2012 Status Report
16	MT	1/24/13	Fourth Quarter 2012 Status Report

16

REVISION

ARCTOS ENVIRONMENTAL
TESORO - SAN LORENZO

**MTBE CONCENTRATION
CONTOUR IN GROUNDWATER**

PROJECT NO.	0120	DRAWN BY	MY	CHECKED BY	MJP	APPROVED BY	JPG
FILE NO.	012011B0416.DWG					FIGURE 5	

Lewelling Blvd.

Driveway

Driveway

Driveway



S-3
S-17- NW

S-4

S-5

Removed
Underground
Storage Tanks

S-2

S-1

S-6

Easement

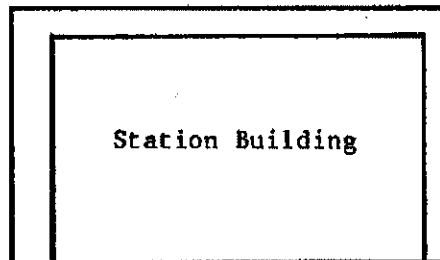

● Soil Sample Location



Source: Site Plan provided
by Kayo Oil Co.



GENERALIZED SITE PLAN
Econo Gas Station
San Lorenzo, California

PLATE

P-2

PROJECT NO. 87044-1

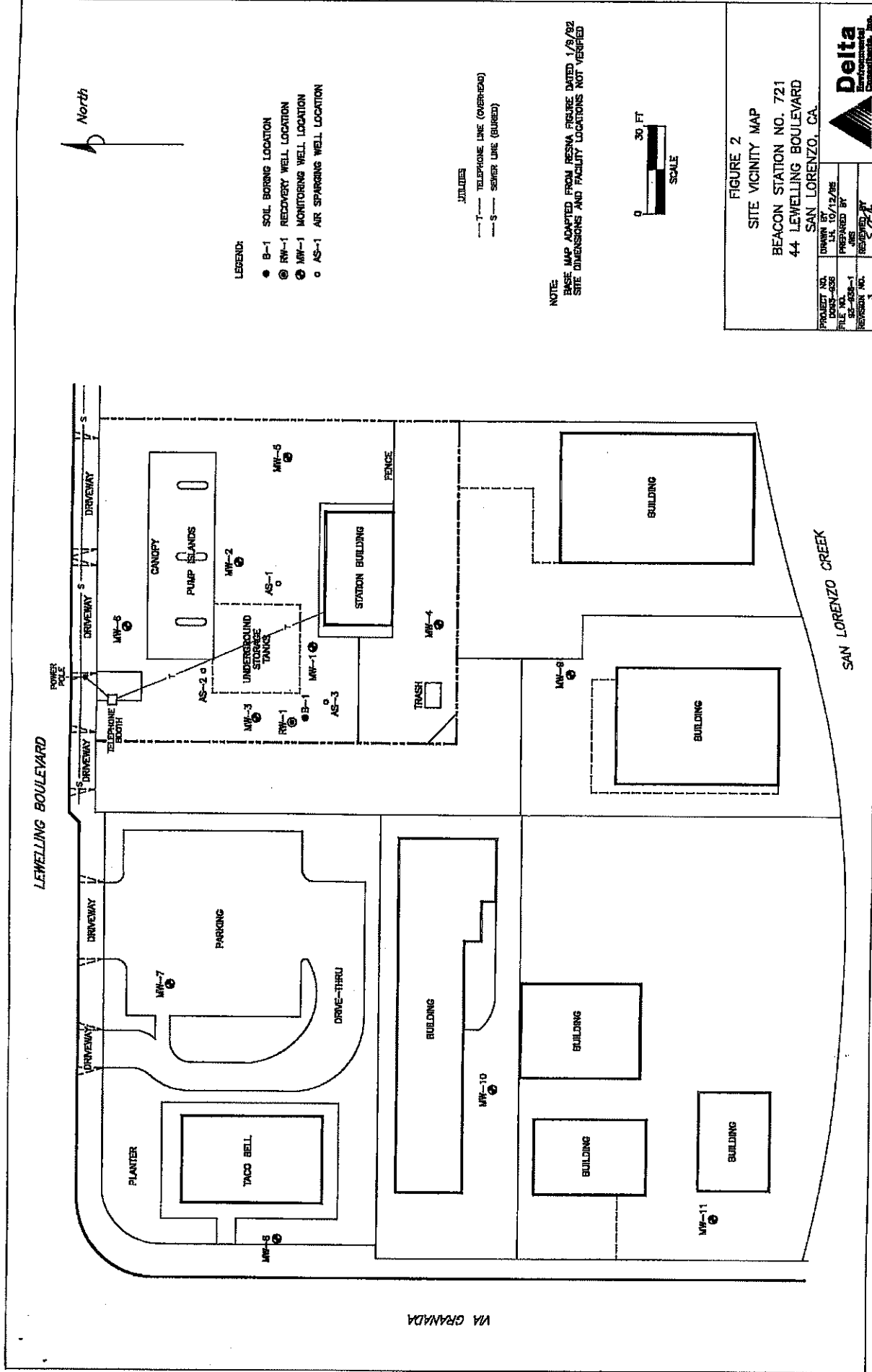

- LEGEND:**
- B-1 SOIL BORING LOCATION
 - ⊙ RW-1 RECOVERY WELL LOCATION
 - ⊙ MW-1 MONITORING WELL LOCATION
 - AS-1 AIR SPARGING WELL LOCATION

- UTILITIES**
- T- TELEPHONE LINE (OVERHEAD)
 - S- SEWER LINE (BURIED)

NOTE:
 BASE MAP ADAPTED FROM RESNA FIGURE DATED 1/9/82
 SITE DIMENSIONS AND FACILITY LOCATIONS NOT VERIFIED

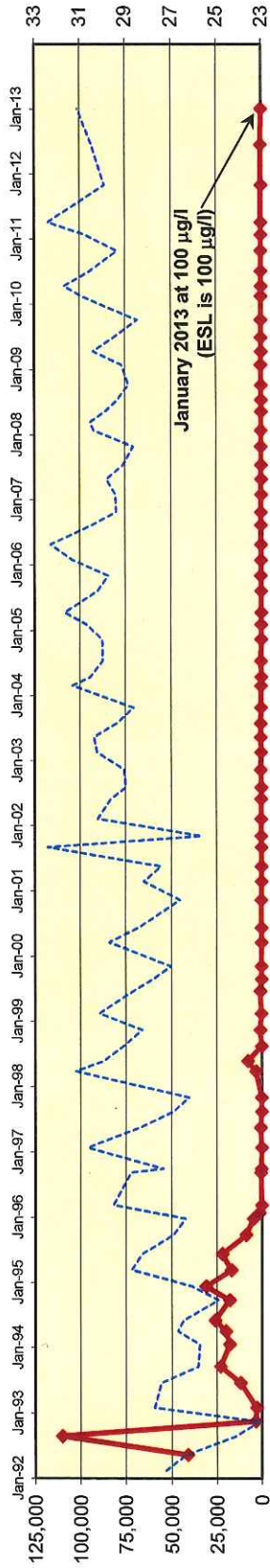

FIGURE 2
SITE VICINITY MAP
 BEACON STATION NO. 721
 44 LEWELLING BOULEVARD
 SAN LORENZO, CA.

PROJECT NO.	DRAWN BY
1005-638	JLS
FILE NO.	DATE
1005-638-1	10/12/86
REVISION NO.	PREPARED BY
3	JLS
	REVIEWED BY
	JLS

Delta
 Environmental
 Consultants, Inc.

TPHg and Groundwater Elevation



Benzene and Groundwater Elevation

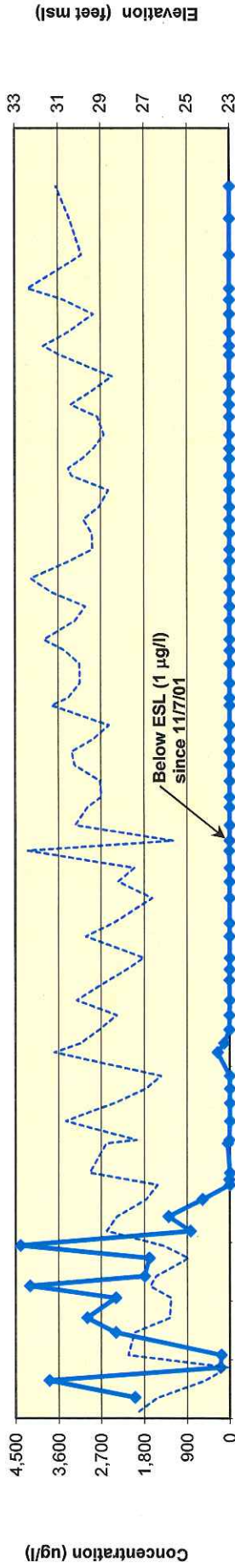

MTBE and Groundwater Elevation

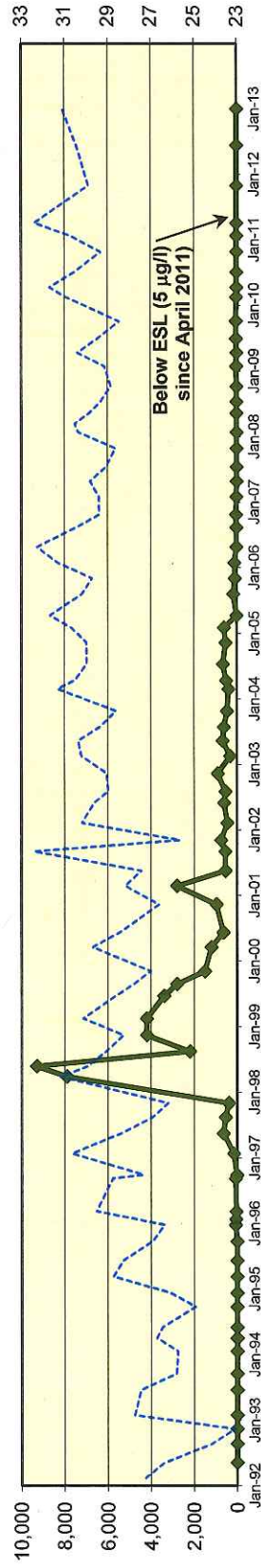

Date

TPHg — Benzene — MTBE — Elevation

TPHg and Groundwater Elevation

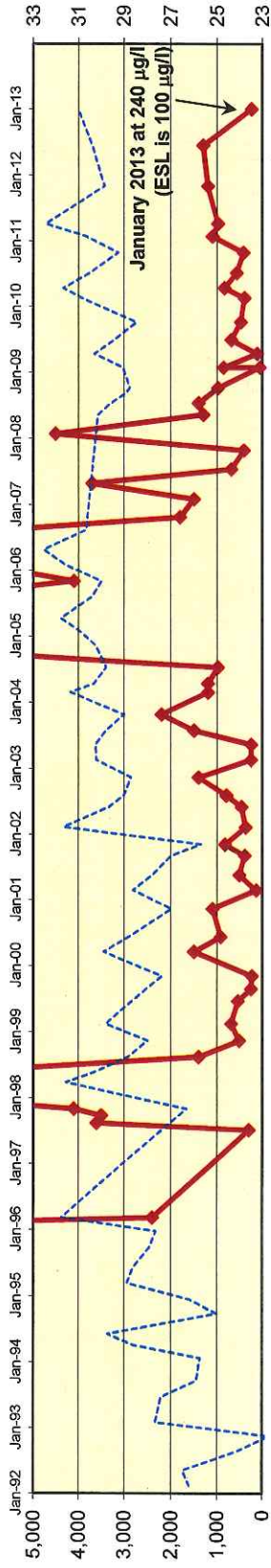

Benzene and Groundwater Elevation

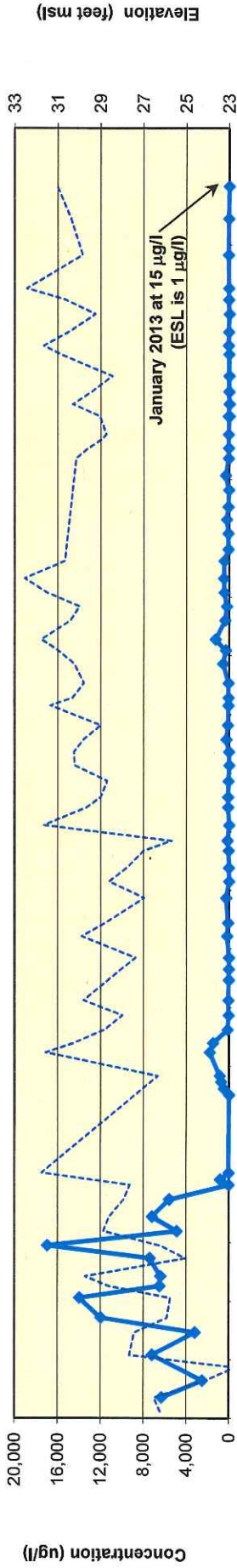

MTBE and Groundwater Elevation

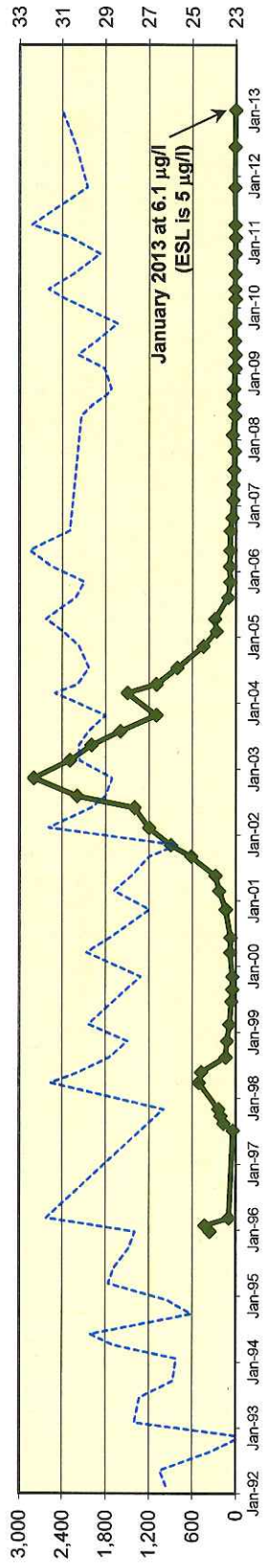

—◆— TPHg
 —◆— Benzene
 —◆— MTBE
 - - - Elevation

TPHg and Groundwater Elevation

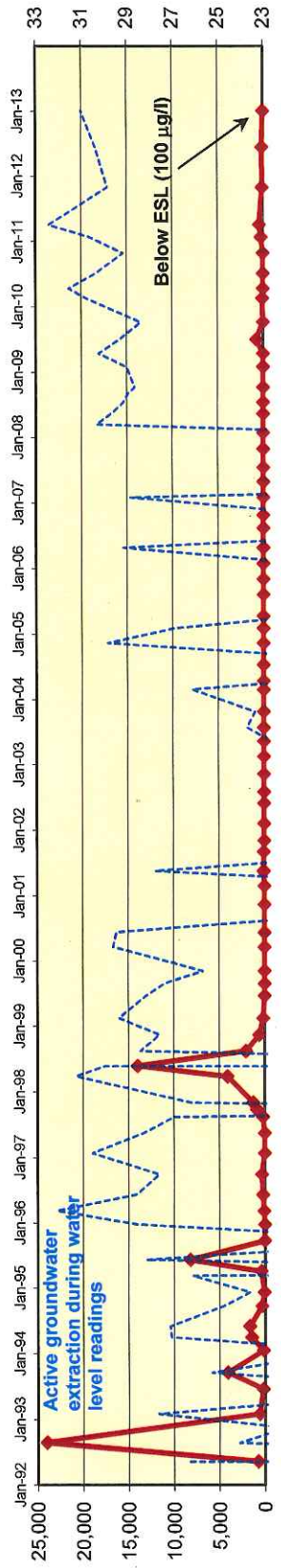

Benzene and Groundwater Elevation

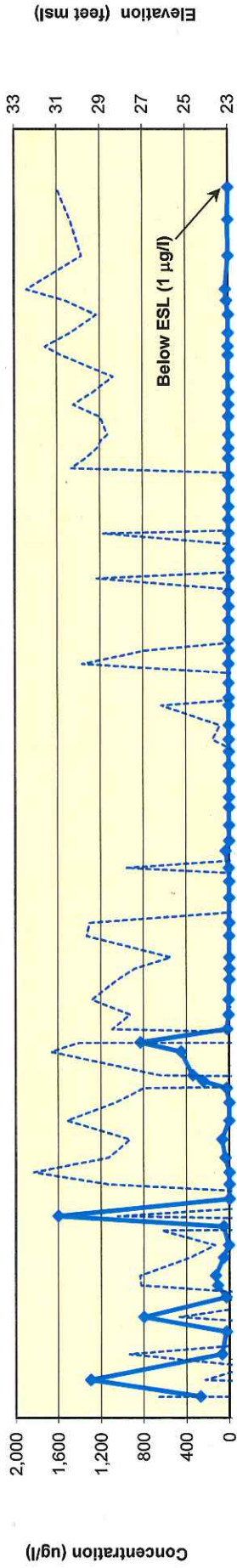

MTBE and Groundwater Elevation

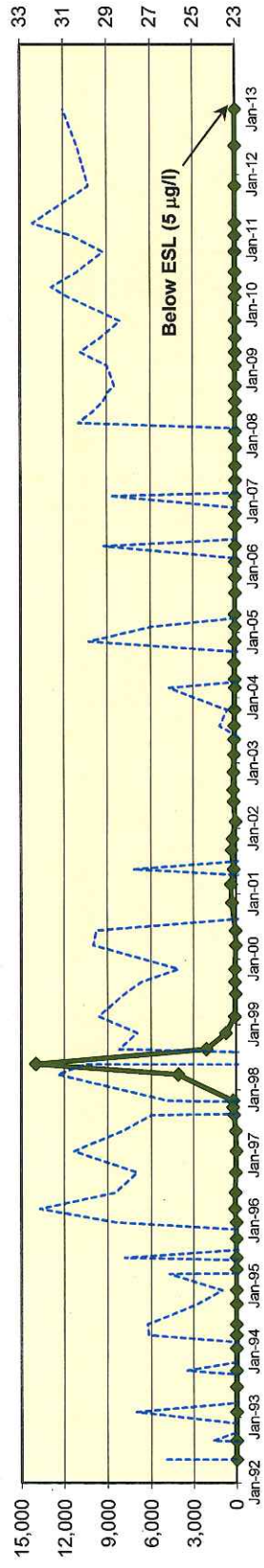

Date

◆ TPHg
 ◆ Benzene
 ◆ MTBE
 - - - - Elevation

TPHg and Groundwater Elevation

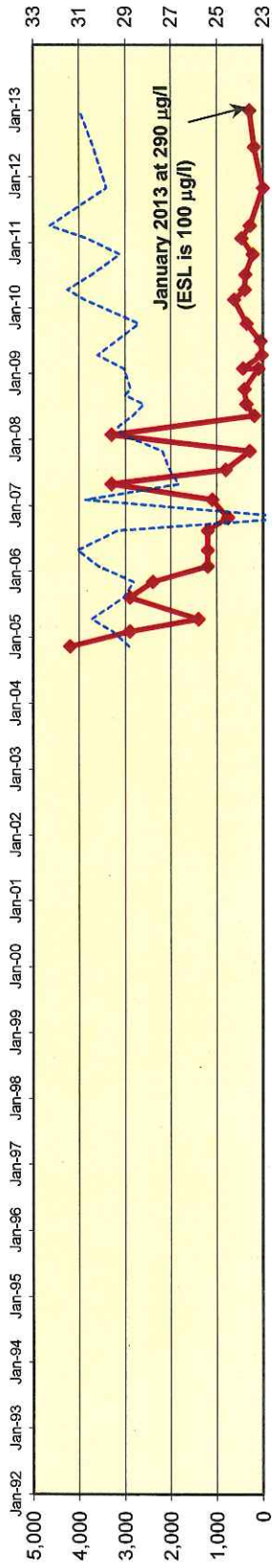

Benzene and Groundwater Elevation

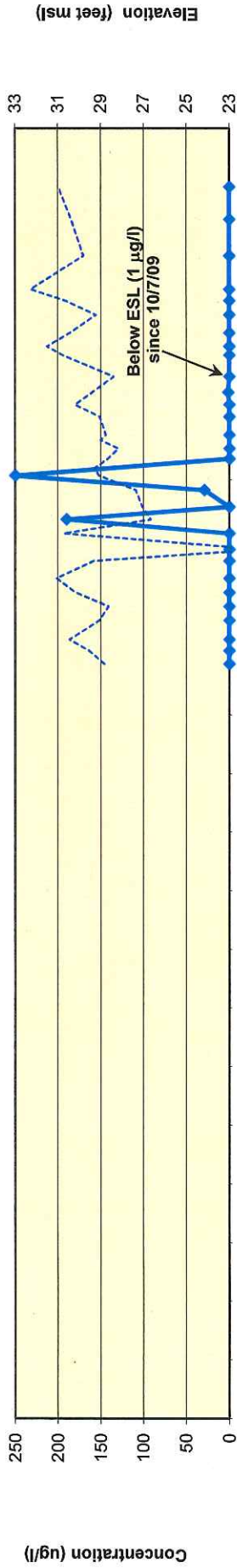

MTBE and Groundwater Elevation

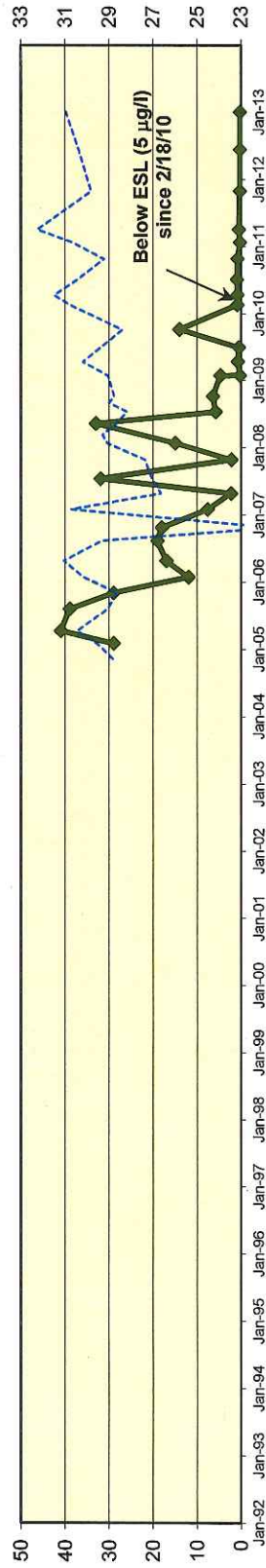

Date

TPHg — Benzene — MTBE — Elevation

TPHg and Groundwater Elevation

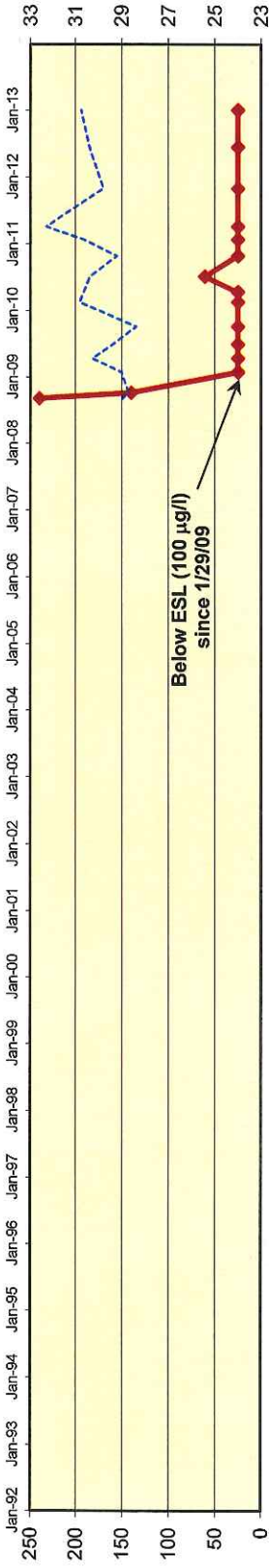

Benzene and Groundwater Elevation

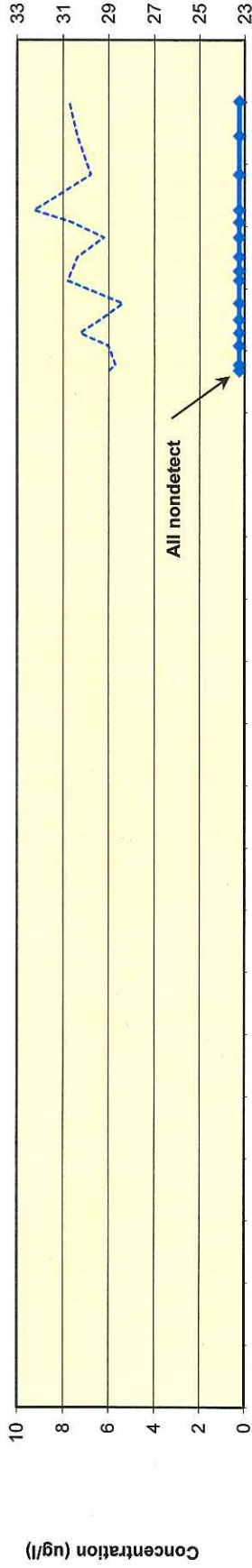

MTBE and Groundwater Elevation

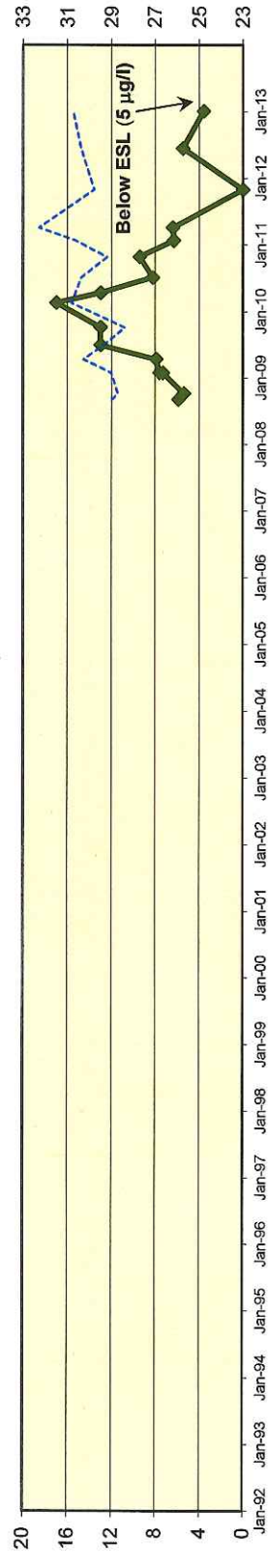

Date

◆ TPHg
 ◆ Benzene
 ◆ MTBE
 --- Elevation

TPHg and Groundwater Elevation

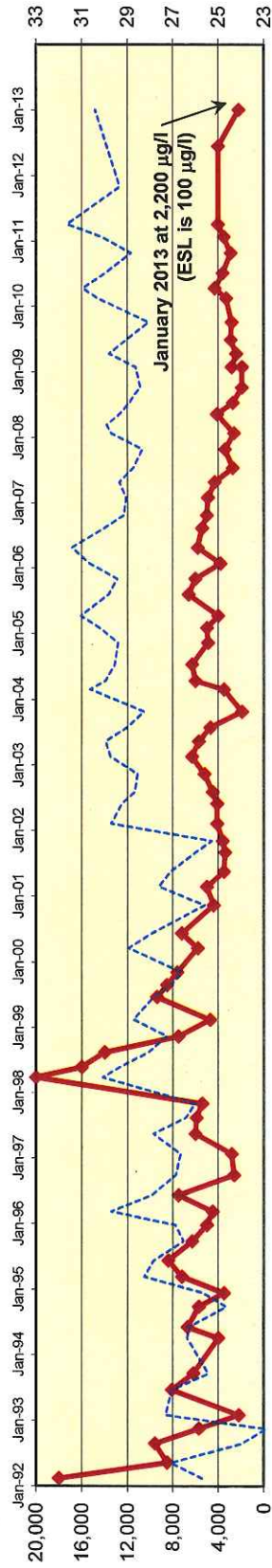

Benzene and Groundwater Elevation

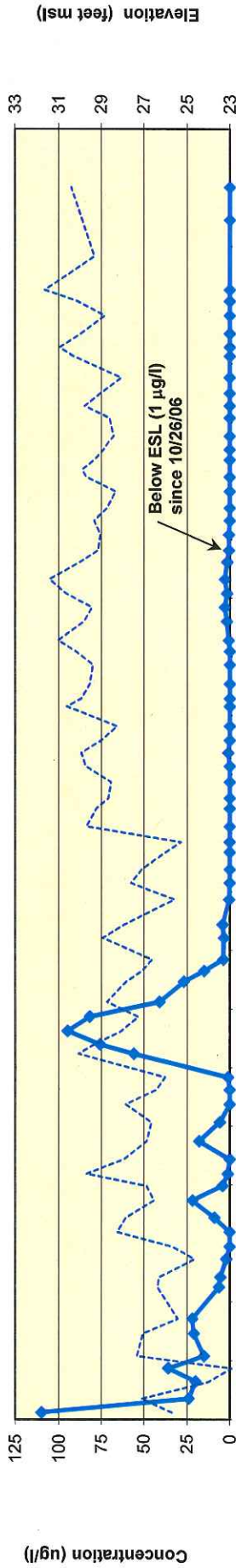

MTBE and Groundwater Elevation

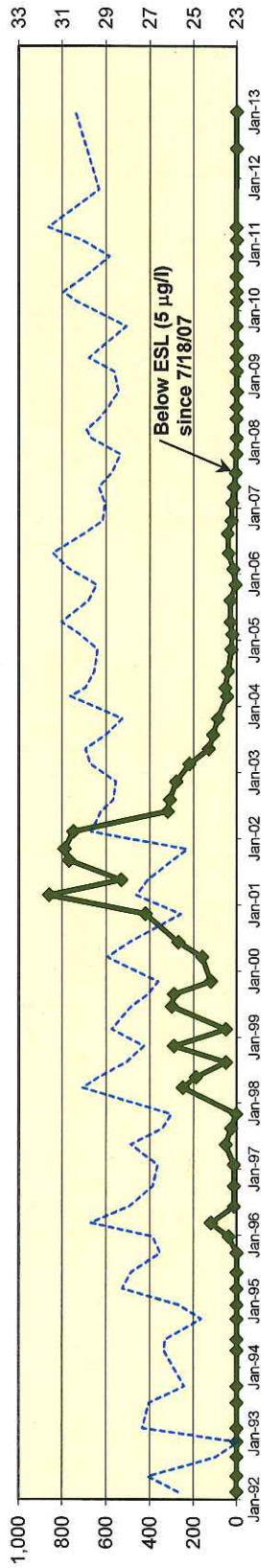

Date

—◆— TPHg
 —◆— Benzene
 —◆— MTBE
 - - - Elevation

TPHg and Groundwater Elevation

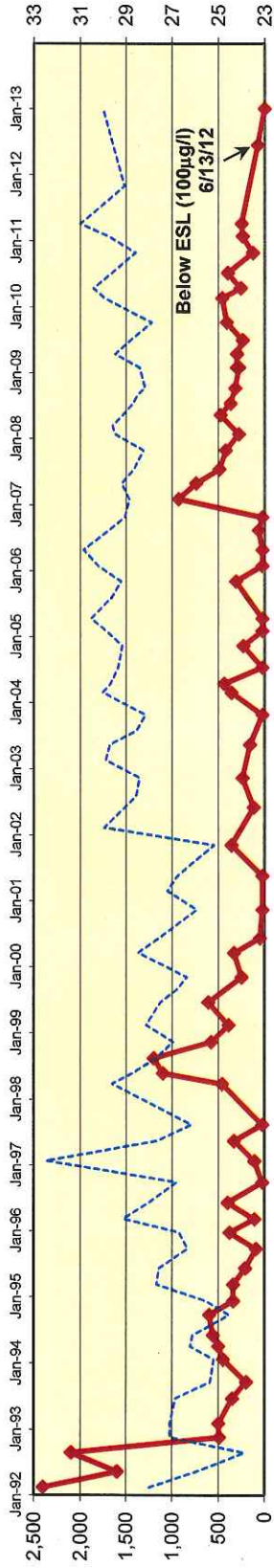

Benzene and Groundwater Elevation

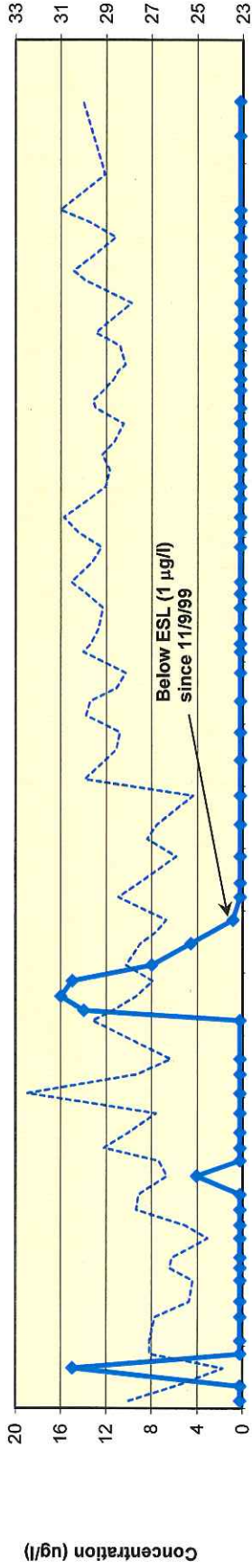

MTBE and Groundwater Elevation

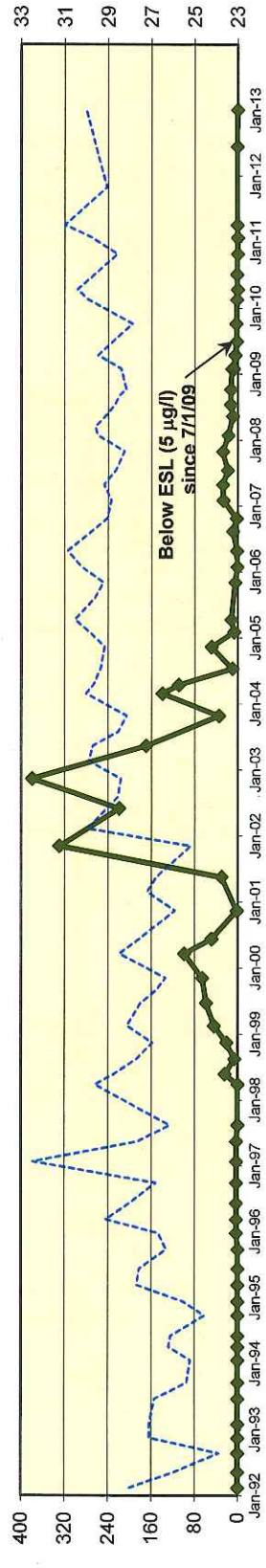

Date

◆ TPHg
 ◆ Benzene
 ◆ MTBE
 --- Elevation

TABLE F

SUMMARY OF ANALYTICAL RESULTS - SOIL

JET GAS STATION
44 LEWELLING BOULEVARD
SAN LORENZO, CALIFORNIA

SAMPLE I.D.	DATE SAMPLED	DEPTH (feet)	ETHYL-				TPHg (mg/kg)	COMMENTS
			BENZENE (mg/kg)	BENZENE (mg/kg)	TOLUENE (mg/kg)	XYLENES (mg/kg)		
B-1	2-DEC-88	11.5	ND(0.09)	ND(0.2)	ND(0.1)	ND(0.7)	ND(0.5)	No Odor
B-1	2-DEC-88	16.0	ND(2.0)	7.8	ND(3.0)	39.0	250.0	No Odor
B-1	2-DEC-88	21.5	0.55	0.25	0.1	0.9	7.1	Slight Odor
B-1	2-DEC-88	33.0	ND(0.09)	ND(0.2)	ND(0.1)	ND(0.7)	ND(0.5)	No Odor
MW-4	1-DEC-88	11.5	ND(0.09)	ND(0.2)	ND(0.2)	ND(0.7)	ND(0.5)	No Odor
MW-4	1-DEC-88	21.0	ND(0.09)	ND(0.2)	ND(0.1)	ND(0.7)	ND(0.5)	No Odor
MW-4	1-DEC-88	26.5	ND(0.09)	ND(0.2)	ND(0.1)	ND(0.7)	0.64	No Odor
MW-5	1-DEC-88	11.5	ND(0.09)	ND(0.2)	ND(0.1)	ND(0.7)	ND(0.5)	No Odor
MW-5	1-DEC-88	21.5	ND(0.09)	ND(0.2)	ND(0.1)	ND(0.7)	ND(0.5)	No Odor
MW-5	1-DEC-88	26.5	ND(0.09)	ND(0.2)	ND(0.1)	ND(0.7)	ND(0.5)	No Odor
MW-6	1-DEC-88	11.5	ND(0.09)	ND(0.2)	ND(0.1)	ND(0.7)	ND(0.5)	No Odor
MW-6	1-DEC-88	21.0	ND(0.09)	ND(0.2)	ND(0.1)	ND(0.7)	5.5	No Odor
MW-6	1-DEC-88	26.5	ND(0.09)	ND(0.2)	ND(0.1)	ND(0.7)	ND(0.5)	No Odor
MW-7	2-DEC-88	11.5	ND(0.09)	ND(0.2)	ND(0.1)	ND(0.7)	ND(0.5)	No Odor
MW-7	2-DEC-88	21.5	ND(0.09)	ND(0.2)	ND(0.1)	ND(0.7)	ND(0.5)	No Odor
MW-7	2-DEC-88	26.0	ND(0.09)	ND(0.2)	ND(0.1)	ND(0.7)	ND(0.5)	No Odor
MW-8C	5-SEP-8	15.0	ND(0.01)	ND(0.02)	ND(0.02)	ND(0.06)	ND(0.5)	No Odor
MW-8D	5-SEP-8	20.0	ND(0.01)	0.16	0.84	ND(0.06)	43.0	Slight Odor
MW-9C	5-SEP-8	15.0	ND(0.01)	ND(0.02)	ND(0.04)	ND(0.06)	ND(0.5)	No Odor
MW-9E	5-SEP-8	19.0	ND(0.01)	ND(0.02)	ND(0.01)	ND(0.06)	ND(0.5)	No Odor

Notes: 1) All results are presented in parts per million.
2) TPHg = Total petroleum hydrocarbon as gasoline.
3) ND = Not detected; detection limits are in parentheses.
4) Odor refers to petroleum hydrocarbon odor.

TABLE 2
SUMMARY OF SOIL ANALYTICAL RESULTS

Sample I.D.	Date Sampled	Depth (feet)	Benzene (mg/kg)	Ethyl-benzene (mg/kg)	Toluene (mg/kg)	Xylenes (mg/kg)	TPHG (mg/kg)	TVH (mg/kg)	Comments	Consultant
MW-9C	09/05/88	15.0	ND(0.01)	ND(0.02)	ND(0.04)	ND(0.06)	ND(0.5)		No Odor	DE
MW-9E	09/05/88	19.0	ND(0.01)	ND(0.02)	ND(0.01)	ND(0.06)	ND(0.5)		No Odor	DE
RW-1	10/17/91	5	0.005	0.005	0.005	0.005	ND		Recovery Well RW-1	R
RW-1	10/17/91	10	0.009	0.025	0.018	0.11	1.5		Recovery Well RW-1	R
RW-1	10/17/91	15	7.9	29	28	160	1,900		Recovery Well RW-1	R
S-1	04/28/87	14.0	12.0	14.0	2.0	63.0		329.0	Tank Pit Sample	AGS
S-2	04/28/87	14.0	22.0	26.0	136.0	179.0		663.0	Tank Pit Sample	AGS
S-3	04/28/87	14.0	52.0	43.0	158.0	288.0		1136.0	Tank Pit Sample*	AGS
S-4	04/28/87	14.0	16.0	19.0	8.0	116.0		510.0	Tank Pit Sample	AGS
S-5	04/28/87	14.0	ND(0.05)	ND(0.05)	ND(0.05)	ND(0.05)		1.64	Tank Pit Sample	AGS
S-6	04/28/87	14.0	0.41	0.21	0.08	0.31		4.22	Tank Pit Sample	AGS
S-17NW	04/30/87	17.0	1.37	0.40	1.06	1.18		6.98	Tank Pit Sample	AGS
S-20B1	05/26/87	20.0	NA	NA	NA	NA		904.0	Monitoring Well MW-1	AGS
S-20B2	05/26/87	20.0	NA	NA	NA	NA		0.62	Monitoring Well MW-2	AGS
S-15B3	05/27/87	15.0	NA	NA	NA	NA		101.39	Monitoring Well MW-3	AGS
S-20B3	05/27/87	20.0	NA	NA	NA	NA		9.40	Monitoring Well MW-3	AGS

*Additional soil excavation performed in this area. For post-excavation sample, refer to sample S-17-NW. [Reference 1].

mg/kg parts per million
TVH Total Volatile Hydrocarbons
ND Not detected; detection limits are shown in parentheses
NA Not Analyzed
TPHG Total Petroleum Hydrocarbons as Gasoline

DE = Dupont Environmental Services
R = RESNA Industries, Inc.
AGS = Applied Geosystems, Inc.

quarterly report dated January 25, 1991 prepared by DuPont for Ultramar Inc. Groundwater Technology, Inc. performed three groundwater monitoring and sampling rounds on March 28, 1991, June 25, 1991, and September 17, 1991.

Exploratory Drilling and Soil Sampling

RESNA drilled exploratory borings MW-10, MW-11 and RW-1 in the site vicinity on October 17, 1991, at the locations shown on Figure 2. The borings for MW-10 and MW-11 were drilled with a truck-mounted Mobile B-34 drill rig, and the boring for RW-1 was drilled with a Mobile B-61 drill rig. Continuous flight, hollow-stem auger of 4-1/4- and 8-1/4-inch-inside diameters were used, respectively. The augers and other tools were steam cleaned before drilling each boring to minimize the possibility of cross-contamination.

The borings were drilled in the following manner: the drill rig was situated over the boring location, and the hollow-stem auger was used to advance the hole to the desired sampling depth. Relatively undisturbed soil samples were collected at approximately 5-foot depth intervals to the bottom of the boring. The samples were collected using a pre-cleaned modified California split-spoon sampler which contained 2-inch-diameter by 6-inch-long brass liners. When the boring was advanced to the desired sampling depth, the sampler was lowered to the bottom of the hole. The sampler was driven 1-1/2 feet ahead of the auger into native soil with a 140-pound, rig-operated hammer. The sampler was then removed and disassembled into its component parts.

The lowermost brass liner from the sampler was sealed with aluminum foil, capped, labeled, logged on a chain-of-custody form, and placed in a chilled ice chest for transport to a state-certified laboratory. The samples were field checked for hydrocarbon vapors using a portable photoionization detector (PID) and the readings were recorded on the boring log. Earth materials were characterized using the Unified Soil Classification System. Boring logs and well construction details for each well are in Appendix A. A description of the RESNA soil sampling protocol is in Appendix B, results of the soil analyses are presented in Table 1, and certified laboratory results are located in Appendix C.

Table 1
Summary of Soil Analyses

Date	Boring Number	Sample Number	Sample Depth (feet)	Benzene ppm	Ethyl Toluene ppm	Benzene ppm	Xylenes ppm	TPHG ppm
10/17/91	B-10	S-6-B10	6	ND	ND	ND	ND	ND
10/17/91	B-10	S-11-B10	11	ND	ND	ND	ND	ND
10/17/91	B-10	S-16-B10	16	ND	ND	ND	ND	ND
10/17/91	B-11	S-6-B11	6	ND	ND	ND	ND	ND
10/17/91	B-11	S-11-B11	11	ND	ND	ND	ND	ND
10/17/91	B-11	S-16-B11	16	ND	ND	ND	ND	ND
10/17/91	RW-1	RW-5	5	ND	ND	ND	ND	ND
10/17/91	RW-1	RW-10	10	0.009	0.025	0.018	0.11	1.5
10/17/91	RW-1	RW-15	15	7.9	29	28	160	1,900

TPHG - Total petroleum hydrocarbons as gasoline
 ppm - Parts per million = mg/kg — milligrams per kilogram

Note: B10 = MW-10; B11 = MW-11

TABLE 1

SOIL SAMPLE ANALYTICAL RESULTS
 Concentrations in milligrams per kilogram (mg/kg)

Beacon Station No. 721
 44 Lewelling Boulevard
 San Lorenzo, California

<u>Sample ID</u>	<u>Date</u>	<u>Depth (ft)</u>	<u>Benzene</u>	<u>Toluene</u>	<u>Ethyl- benzene</u>	<u>Total Xylenes</u>	<u>TPH^a as gasoline</u>
AS-1-10	10/10/95	10.0	<0.005	<0.005	<0.005	<0.005	<1.0
AS-1-15	10/10/95	15.0	<0.005	<0.005	<0.005	<0.005	<1.0
AS-1-20	10/10/95	20.0	<0.005	<0.005	<0.005	<0.005	<1.0
AS-2-10	10/10/95	10.0	<0.005	<0.005	<0.005	<0.005	<1.0
AS-2-15	10/10/95	15.0	1.2	12	14	81	570
AS-2-20	10/10/95	20.0	2.6	3.5	0.40	2.6	21
AS-3-10	10/10/95	10.0	<0.005	<0.005	<0.005	<0.005	<1.0
AS-3-15	10/10/95	15.0	<0.005	<0.005	<0.005	0.023	5.3 ^b
AS-3-20	10/10/95	20.0	0.47	0.38	0.74	4.5	26

^a Total petroleum hydrocarbons.

^b Product is not typical gasoline.

TABLE 1
SOIL SAMPLE ANALYTICAL RESULTS

Beacon Station No.3721
44 Lewelling Boulevard
San Lorenzo, California

Sample ID	Sample Date	Depth (ft)	Benzene (mg/kg)	Toluene (mg/kg)	Ethyl-benzene (mg/kg)	Total Xylenes (mg/kg)	TPH as gasoline (mg/kg)	MTBE (mg/kg)	Oxygenate Compounds (mg/kg)	Total Lead (mg/kg)	1,2-DCA (mg/kg)	EDB (mg/kg)
Line Samples												
LS-1-2'	07/10/01	2.0	<0.005	<0.005	<0.005	<0.005	<1.0	<0.005	NA	NA	NA	NA
LS-2-2'	07/10/01	2.0	<0.005	<0.005	<0.005	<0.005	<1.0	0.740	NA	NA	NA	NA
LS-3-4'	07/10/01	4.0	<0.005	<0.005	<0.005	<0.005	<1.0	<0.005	NA	NA	NA	NA
LS-4-2.5'	07/10/01	2.5	<0.005	<0.005	<0.005	<0.005	<1.0	0.0052	NA	NA	NA	NA
LS-5-3'	07/10/01	3.0	0.27	0.99	0.31	1.9	9.7	13.0	0.044 ^a , 1.7 ^b	7.9	<0.010	<0.010
LS-5-2-4.5'	07/10/01	4.5	<0.005	<0.005	<0.005	<0.005	<1.0	0.094	NA	NA	NA	NA
Stockpile												
SP-ABCD	07/10/01	—	<0.005	0.17	0.26	4.7	200	0.72	NA	7.7	NA	NA
Over-Excavation												
OX-1-5'	07/13/01	5.0	<0.005	0.015	<0.005	0.16	<1.0	0.0068	NA	NA	NA	NA
OX-2-5'	07/13/01	5.0	<0.005	<0.005	<0.005	<0.005	<1.0	<0.005	NA	NA	NA	NA

^a Tert-amy methyl ether

^b Tert-butanol

TPH = Total petroleum hydrocarbons.

MTBE = Methyl tertiary butyl ether

Oxygenate compounds = Methyl tertiary butyl ether, diisopropyl ether, ethyl-t-butyl ether, tert-amy methyl ether, tert-butanol by EPA Method 8260B.

1,2-DCA = 1,2-Dichloroethane

EDB = 1,2-Dibromoethane

mg/kg = Milligrams per kilogram.

NA = Not analyzed.

ND = Not detected at or above the laboratory reporting limit.

TABLE 1
SOIL SAMPLE ANALYTICAL RESULTS

Tesoro Station No. 67107
(Former Beacon Station No. 3721)
44 Lewelling Boulevard
San Lorenzo, California

Sample ID	Sample Date	Depth (ft)	Benzene (mg/kg)	Toluene (mg/kg)	Ethylbenzene (mg/kg)	Total Xylenes (mg/kg)	TPH as gasoline (mg/kg)	MTBE (mg/kg)	Oxygenate Compounds (mg/kg)	Total Lead (mg/kg)
<u>Soil Samples</u>										
RW2-15	09/16/04	15.0	<0.005	<0.005	<0.005	<0.005	<1.0	<0.005	ND	NA
RW2-20	09/16/04	20.0	<0.005	<0.005	0.20	0.23	11	<0.005	ND	NA
RW2-30	09/16/04	30.0	<0.005	<0.005	<0.005	<0.005	3.5	<0.005	ND	NA
<u>Stockpile</u>										
SP-1ABCD	09/16/04	---	<0.025	<0.025	0.032	0.49	69	NA	NA	8.23

TPH = Total petroleum hydrocarbons.

MTBE = Methyl tertiary butyl ether

Oxygenate compounds = Methyl tertiary butyl ether, diisopropyl ether, diisobutyl ether, ethyl-t-butyl ether, tert-amyl methyl ether, tert-butanol by EPA Method 8260B.

mg/kg = Milligrams per kilogram.

NA = Not analyzed.

ND = Not detected at or above the laboratory reporting limit.

TABLE 1
Soil Sample Analytical Results

Tesoro Station No. 67107 (former Beacon Station No. 3721)
44 Lewelling Boulevard
San Lorenzo, California

Sample ID	Date	Depth (feet)	Benzene (mg/kg)	Toluene (mg/kg)	Ethyl- benzene (mg/kg)	Total Xylenes (mg/kg)	TPH as gasoline (mg/kg)	Fuel Oxygenates (mg/kg)	Total Lead (mg/kg)
Soil Borings									
DP-1-24'	06/25/07	24	<0.0050	<0.0050	<0.0050	<0.0050	8.5	<0.0050	NA
DP-1-28'	06/25/07	28	<0.0050	<0.0050	<0.0050	<0.0050	1.2	<0.0050	NA
DP-1-36'	06/25/07	36	<0.0050	<0.0050	<0.0050	<0.0050	<1.0	<0.0050	NA
DP-1-40'	06/25/07	40	<0.0050	<0.0050	<0.0050	<0.0050	<1.0	<0.0050	NA
DP-2-16'	06/25/07	16	<0.0050	<0.0050	<0.0050	<0.0050	<1.0	<0.0050	NA
DP-2-24'	06/25/07	24	<0.0050	<0.0050	<0.0050	<0.0050	<1.0	<0.0050	NA
DP-3-24.5'	06/26/07	24.5	<0.0050	<0.0050	<0.0050	<0.0050	8.3	<0.0050	NA
DP-3-28'	06/26/07	28	<0.0050	<0.0050	<0.0050	<0.0050	<1.0	<0.0050	NA
DP-3-36'	06/26/07	36	<0.0050	<0.0050	<0.0050	<0.0050	<1.0	<0.0050	NA
Soil Stockpile (Drill Cuttings)									
SP-1a,b	06/26/07	--	<0.0050	<0.0050	<0.0050	<0.0050	<1.0	<0.0050	7.42

TABLE 3

SUMMARY OF GROUNDWATER ANALYTICAL RESULTS

Well No.	Date Sampled	Benzene (ppb)	Toluene (ppb)	Ethyl Benzene (ppb)	Xylenes (ppb)	TPHG (ppb)	Comments
MW-1	05/29/87	490	150	930	3,790	18,050	
	07/14/87	560	120	950	3,270	14,750	
	08/17/87	630	40	320	1,130	12,860	
	09/01/87	558	84	562	1,942	14,269	
	12/10/87	200	138	273	777	14,000	
	03/10/88	70	40	340	940	7,300	
	06/14/88	290	ND	330	790	34,000	
	12/05/88	100	16	140	310	4,000	
	03/08/89	670	20	580	1,200	9,100	Sheen
	06/22/89	1,000	20	1,200	2,200	12,000	Sheen
	09/27/89	960	9	260	360	6,800	
	12/29/89	210	33	1,200	250	4,800	
	03/29/90	1,100	42	510	1,800	14,000	
	06/21/90	1,400	ND	160	130	7,900	
	09/25/90	NS	NS	NS	NS	NS	0.9 ft free-product
	12/18/90	NS	NS	NS	NS	NS	0.4 ft free-product
	03/28/91	230	75	570	2,000	26,000	Sheen
	06/25/91	970	35	300	610	22,000	
	09/17/91	490	150	250	370	16,000	
	11/05/91	420	45	410	780	35,000	
02/18/92	NS	NS	NS	NS	NS	Sheen	
MW-2	05/29/87	113	14	46	58	4,870	
	07/14/87	103	25	34	48	2,207	
	08/17/87	37.6	10.9	8.2	11.1	756	
	09/01/87	75.3	14.2	16.4	27.6	1,482	
	12/10/87	28	40.6	38.1	100.3	1,800	
	03/10/88	9.2	3.1	7.3	2.6	1,200	
	06/14/88	ND	ND	2.2	5.7	500	
	12/05/88	ND	1.3	5.6	3.6	500	
	03/08/89	ND	1.3	3.5	3.7	730	
	06/22/89	ND	ND	ND	ND	570	
	09/27/89	3.8	0.64	2.9	54	420	
	12/29/89	6.7	2	5.7	2.9	270	
	03/29/90	10	0.88	10	3.3	420	
	06/21/90	ND	ND	4	ND	650	
	09/25/90	ND	1.5	3.5	1.5	680	
12/18/90	ND	1.7	2.2	0.6	500		

TABLE 3

SUMMARY OF GROUNDWATER ANALYTICAL RESULTS

Well No.	Date Sampled	Benzene (ppb)	Toluene (ppb)	Ethyl Benzene (ppb)	Xylenes (ppb)	TPHG (ppb)	Comments
MW-2 (cont)	03/28/91	ND	2.2	2.7	1.1	730	
	06/25/91	ND	ND	ND	1.2	610	
	09/17/91	ND	ND	2.5	1.2	820	
	11/05/91	ND	ND	1.1	ND	700	
	02/18/92	ND	ND	1.9	ND	1600	
MW-3	05/29/87	5,400	3,900	1,700	5,200	40,300	
	07/14/87	6,880	7,080	1,580	4,770	30,320	
	08/17/87	5,930	4,180	1,240	3,370	25,620	
	09/01/87	8,540	6,660	1,020	3,740	38,210	
	12/10/87	4,240	2,350	890	1,860	25,000	
	03/10/88	3,210	950	940	950	13,400	
	06/14/88	5,900	7,600	450	4,600	54,000	
	12/05/88	4,200	2,400	1,000	3,100	19,000	
	03/08/89	11,000	9,400	2,300	9,900	53,000	Sheen
	06/22/89	16,000	5,900	2,100	6,600	60,000	Sheen
	09/27/89	8,100	2,800	1,200	4,300	34,000	
	12/29/89	NS	NS	NS	NS	NS	0.02 ft free-product
	03/29/90	NS	NS	NS	NS	NS	0.04 ft free-product
	06/21/90	19,000	22,000	22,000	120,000	2,100,000	
	09/25/90	NS	NS	NS	NS	NS	0.04 ft free-product
	12/18/90	NS	NS	NS	NS	NS	0.42 ft free-product
	03/28/91	NS	NS	NS	NS	NS	0.25 ft free-product
	06/25/91	NS	NS	NS	NS	NS	0.02 ft free-product
	09/17/91	NS	NS	NS	NS	NS	0.44 ft free-product
	11/05/91	NS	NS	NS	NS	NS	Sheen
02/18/92	NS	NS	NS	NS	NS	Sheen	
MW-4	12/05/88	ND	ND	2.3	6.5	4,500	
	03/08/89	ND	ND	ND	ND	3,900	
	06/22/89	ND	ND	ND	ND	1,500	
	09/27/89	11	ND	ND	ND	1,200	
	12/29/89	ND	2.1	2.3	ND	920	
	03/29/90	ND	ND	8	ND	870	
	06/21/90	ND	ND	ND	ND	1,500	
	09/25/90	ND	11	4.6	6	3,100	
	12/18/90	ND	4.4	15	6.3	3,600	
	03/28/91	8.9	4.4	4.4	2.2	2,000	
06/25/91	ND	5.4	1.7	ND	2,000		

TABLE 3

SUMMARY OF GROUNDWATER ANALYTICAL RESULTS

Well No.	Date Sampled	Benzene (ppb)	Toluene (ppb)	Ethyl Benzene (ppb)	Xylenes (ppb)	TPHG (ppb)	Comments
MW-4 (Con't)	09/17/91	ND	ND	0.8	ND	2,300	
	11/05/91	ND	ND	3.2	1.1	3,500	
	02/18/92	ND	ND	12	21	5,100	
MW-5	12/05/88	ND	0.78	0.23	0.92	3.9	
	03/08/89	2.7	6.7	2.7	15	58	
	06/22/89	0.91	ND	ND	ND	5	
	09/27/89	1.3	ND	ND	ND	5.3	
	12/29/89	ND	ND	ND	ND	ND	
	03/29/90	ND	ND	ND	ND	ND	
	06/21/90	ND	ND	ND	ND	12	
	09/25/90	ND	ND	ND	ND	ND	
	12/18/90	ND	ND	ND	ND	ND	
	03/28/91	ND	ND	ND	ND	ND	
	06/25/91	ND	ND	ND	ND	ND	
	09/17/91	ND	ND	ND	ND	ND	
	11/05/91	ND	ND	ND	ND	ND	
02/18/92	ND	ND	ND	ND	ND		
MW-6	12/05/88	4	1.3	0.63	1.3	190	
	03/08/89	2.2	ND	ND	1.1	23	
	06/22/89	0.82	2.6	0.18	1.2	57	
	09/27/89	0.2	0.24	ND	ND	2.1	
	12/29/89	ND	ND	ND	ND	ND	
	03/29/90	2.1	ND	ND	ND	12	
	06/21/90	ND	ND	ND	ND	ND	
	09/25/90	1.4	ND	ND	ND	98	
	12/18/90	2.2	ND	ND	ND	200	
	03/28/91	3.5	ND	ND	ND	140	
	06/25/91	ND	ND	ND	ND	95	
	09/17/91	ND	ND	ND	ND	ND	
	11/05/91	ND	ND	ND	ND	130	
02/18/92	4.8	ND	ND	ND	370		
MW-7	12/05/88	140	150	40	370	1,500	
	03/08/89	730	72	180	370	2,400	
	06/22/89	570	43	180	220	2,000	
	09/27/89	420	5.9	140	28	1,400	
	12/29/89	87	3.5	18	15	150	

TABLE 3

SUMMARY OF GROUNDWATER ANALYTICAL RESULTS

Well No.	Date Sampled	Benzene (ppb)	Toluene (ppb)	Ethyl Benzene (ppb)	Xylenes (ppb)	TPHG (ppb)	Comments
MW-7 (con't)	03/29/90	110	40	53	150	530	
	06/21/90	620	34	290	400	4,100	
	09/25/90	49	2.4	30	42	750	
	12/18/90	74	4.5	25	69	510	
	03/28/91	53	0.8	24	24	500	
	06/25/91	23	ND	32	37	570	
	09/17/91	79	1	89	100	1,400	
	11/05/91	52	ND	76	58	1,100	
	02/18/92	16	ND	10	16	670	
MW-8	09/27/89	ND	ND	16	ND	4,200	
	12/29/89	ND	3.2	18	ND	2,800	
	03/29/90	ND	ND	19	ND	2,600	
	06/21/90	ND	ND	13	ND	4,600	
	09/25/90	2.3	22	16	26	4,500	
	12/18/90	0.7	6	9.7	2.3	1,100	
	03/28/91	2.6	4.6	3.2	3.1	1,600	
	06/25/91	ND	ND	2.5	1.3	760	
	09/17/91	ND	ND	13	3.9	1,900	
	11/05/91	ND	ND	15	ND	1,400	
	02/18/92	ND	ND	9.5	ND	1,200	
MW-9	09/27/89	ND	ND	ND	ND	25	
	12/29/89	ND	ND	ND	2.5	11	
	03/29/90	ND	ND	ND	ND	ND	
	06/21/90	ND	ND	ND	ND	ND	
	09/25/90	ND	ND	ND	ND	ND	
	12/18/90	ND	ND	ND	ND	100	
	03/28/91	ND	ND	ND	ND	ND	
	06/25/91	ND	ND	ND	ND	ND	
	09/17/91	ND	ND	ND	ND	ND	
	11/05/91	ND	ND	ND	ND	ND	
	02/18/92	ND	ND	ND	ND	ND	
MW-10	11/05/91	29	140	500	320	27,000	
	02/18/92	110	57	440	63	18,000	

TABLE 3

SUMMARY OF GROUNDWATER ANALYTICAL RESULTS

Well No.	Date Sampled	Benzene (ppb)	Toluene (ppb)	Ethyl Benzene (ppb)	Xylenes (ppb)	TPHG (ppb)	Comments
MW-11	11/05/91	ND	ND	ND	ND	890	
	02/18/92	ND	ND	ND	ND	2,400	
RW-1	11/13/91	74	68	7	99	1,600	

1. TPHG Total petroleum hydrocarbons as gasoline
2. ND - Not detected
3. NS - Not sampled
4. Samples prior to December 1988 collected by Applied GeoSystems
5. Sample from December 1988 through December 1990 collected by DuPont Environmental
6. Sample from March 1991 through September 1991 collected by Groundwater Technology

TABLE D-1

HISTORICAL GROUNDWATER MONITORING ANALYTICAL RESULTS
TESORO - SAN LORENZO, 67107

Monitoring Well	Sample Date ^(a)	TPHg ^(b) (µg/l)	Benzene ^(b) (µg/l)	Toluene ^(b) (µg/l)	Ethylbenzene ^(b) (µg/l)	Total Xylenes ^(b) (µg/l)	MTBE ^(b) (µg/l)	DIPE ^(b) (µg/l)	ETBE ^(b) (µg/l)	TAME ^(b) (µg/l)	TBA ^(b) (µg/l)
ESLs ^(c)		100	1.0	40	30	20	5.0	NE ^(d)	NE	NE	12
MW-1	5/15/92	41,000	2,000	47	1,200	400	-- ^(e)	--	--	--	--
	8/28/92	110,000	3,800	54	850	970	--	--	--	--	--
	11/19/92	3,600	200	ND<0.5 ^(f)	90	140	--	--	--	--	--
	2/3/93	3,000	180	22	79	130	--	--	--	--	--
	6/23/93	12,000	2,400	74	650	510	--	--	--	--	--
	9/22/93	23,000	3,000	290	1,100	1,200	--	--	--	--	--
	1/24/94	18,000	2,400	280	1,100	1,700	--	--	--	--	--
	4/7/94	20,000	4,200	820	1,600	2,100	--	--	--	--	--
	6/7/94	26,000	1,800	510	1,100	1,600	--	--	--	--	--
	9/28/94	18,000	1,700	210	970	870	--	--	--	--	--
	12/14/94	31,000	4,400	2,400	2,300	4,300	--	--	--	--	--
	3/15/95	17,000	830	310	840	1,200	--	--	--	--	--
	6/13/95	22,000	1,300	99	1,500	1,100	--	--	--	--	--
	9/28/95	8,800	580	ND<25	780	410	--	--	--	--	--
	12/28/95	4,800	4.9	ND<1.3	ND<1.3	290	74	--	--	--	--
	1/30/96	1,500	17	7.1	20	45	63	--	--	--	--
	3/12/96	110	ND<0.5	ND<0.5	ND<0.5	ND<0.5	44	--	--	--	--
	9/11/96	600	48	0.90	37	26	75	--	--	--	--
	10/2/96	210	16	ND<0.5	6.0	0.92	11	--	--	--	--
	1/28/97	150	ND<0.5	ND<0.5	ND<0.5	ND<0.5	160	--	--	--	--
	5/20/97	680	ND<2.5	ND<2.5	ND<2.5	ND<2.5	640	--	--	--	--
	8/18/97	ND<250	ND<2.5	ND<2.5	ND<2.5	ND<2.5	540	--	--	--	--
	11/5/97	ND<250	2.8	ND<2.5	ND<2.5	ND<2.5	390	--	--	--	--
	3/31/98	3,300	260	13	110	150	7,900	--	--	--	--
	5/28/98	7,800	120	ND<10	39	55	9,300	--	--	--	--
	8/19/98	ND<250	12	ND<2.5	6.0	3.8	2,200	--	--	--	--
	11/17/98	860	8.3	ND<2.5	9.2	7.6	4,200	--	--	--	--
2/18/99	310	2.7	ND<2.5	ND<2.5	3.9	4,200	--	--	--	--	
6/24/99	860	10	ND<2.5	12	6.5	3,400	--	--	--	--	
8/30/99	140	2.0	ND<0.5	3.9	2.0	2,800	--	--	--	--	
11/9/99	170	ND<0.5	ND<0.5	3.1	2.0	1,500	--	--	--	--	
3/22/00	ND<200	2.8	ND<2	3.6	ND<2	1,200	--	--	--	--	
6/12/00	190	1.3	ND<1	ND<1	ND<1	640	--	--	--	--	
11/15/00	240	ND<1	ND<1	ND<1	ND<1	960	--	--	--	--	
2/26/01	ND<100	1.2	ND<1	ND<1	ND<1	2,800	--	--	--	--	
5/21/01	ND<200	ND<2	ND<2	ND<2	ND<2	540	--	--	--	--	
9/5/01	ND<200	7.0	ND<2	ND<2	ND<2	550	--	--	--	--	

TABLE D-1

HISTORICAL GROUNDWATER MONITORING ANALYTICAL RESULTS
TESORO - SAN LORENZO, 67107

Monitoring Well	Sample Date ^(a)	TPHg ^(b) (µg/l)	Benzene ^(b) (µg/l)	Toluene ^(b) (µg/l)	Ethylbenzene ^(b) (µg/l)	Total Xylenes ^(b) (µg/l)	MTBE ^(b) (µg/l)	DiPE ^(b) (µg/l)	ETBE ^(b) (µg/l)	TAME ^(b) (µg/l)	TBA ^(b) (µg/l)
ESLs ^(c)		100	1.0	40	30	20	5.0	NE ^(d)	NE	NE	12
MW-1 (cont.)	11/7/01	290	ND<2	ND<2	ND<2	ND<2	750	--	--	--	--
	2/11/02	270	ND<1	ND<1	ND<1	ND<1	450	--	--	--	--
	6/3/02	310	ND<2	ND<2	ND<2	ND<2	610	--	--	--	--
	8/6/02	170	ND<0.5	ND<0.5	ND<0.5	ND<0.5	540	--	--	--	--
	11/14/02	490	ND<2	ND<2	ND<2	ND<2	900	--	--	--	--
	2/20/03	210	ND<1	ND<1	ND<1	ND<1	320	--	--	--	--
	5/15/03	400	ND<1.5	ND<1.5	ND<1.5	ND<1.5	670	ND<1.5	ND<1.5	ND<1.5	ND<15
	7/31/03	380	ND<1.5	ND<1.5	ND<1.5	ND<1.5	620	ND<1.5	ND<1.5	ND<1.5	ND<15
	10/28/03	230	ND<1	ND<1	ND<1	ND<1	470	ND<1	ND<1	ND<1	ND<10
	2/28/04	300	ND<0.5	ND<0.5	ND<0.5	ND<0.5	400	ND<0.5	ND<0.5	ND<0.5	ND<5
	4/16/04	ND<200	ND<1.5	ND<1.5	ND<1.5	ND<1.5	510	ND<1.5	ND<1.5	ND<1.5	ND<15
	7/16/04	280	ND<1.5	ND<1.5	ND<1.5	ND<1.5	660	ND<1.5	ND<1.5	ND<1.5	ND<15
	11/13/04	ND<100	ND<1	ND<1	ND<1	ND<1	530	ND<1	ND<1	ND<1	19
	2/4/05	140	ND<1	ND<1	ND<1	ND<1	610	ND<1	ND<1	ND<1	18
	4/13/05	ND<50	ND<0.5	ND<0.5	ND<0.5	ND<0.5	19	ND<0.5	ND<0.5	ND<0.5	12
	8/10/05	100	ND<0.5	ND<0.5	ND<0.5	ND<0.5	170	ND<0.5	ND<0.5	ND<0.5	17
	11/5/05	220	ND<0.5	ND<0.5	ND<0.5	ND<0.5	95	ND<0.5	ND<0.5	ND<0.5	24
	1/30/06	92	ND<0.5	ND<0.5	ND<0.5	ND<0.5	120	ND<0.5	ND<0.5	ND<0.5	20
	4/28/06	57	ND<0.5	ND<0.5	ND<0.5	ND<0.5	18	ND<0.5	ND<0.5	ND<0.5	13
	8/15/06	60	ND<0.5	ND<0.5	ND<0.5	ND<0.5	15	ND<0.5	ND<0.5	ND<0.5	10
10/26/06	110	ND<0.5	ND<0.5	ND<0.5	ND<0.5	34	ND<0.5	ND<0.5	ND<0.5	6.2	
2/2/07	ND<50	ND<0.5	ND<0.5	ND<0.5	ND<0.5	17	ND<0.5	ND<0.5	ND<0.5	6.7	
4/30/07	ND<50	ND<0.5	ND<0.5	ND<0.5	ND<0.5	1.5	ND<0.5	ND<0.5	ND<0.5	ND<5	
7/18/07	ND<50	ND<0.5	ND<0.5	ND<0.5	ND<0.5	0.94	ND<0.5	ND<0.5	68	5.5	
10/30/07	77 ^(g)	ND<0.5	ND<0.5	ND<0.5	ND<0.5	1.0	ND<0.5	ND<0.5	ND<0.5	ND<5	
1/28/08	56 ^(g)	ND<0.5	ND<0.5	ND<0.5	ND<0.5	1.6	ND<0.5	ND<0.5	ND<0.5	ND<5	
5/13/08	ND<50	ND<0.5	ND<0.5	ND<0.5	ND<0.5	7.2	ND<0.5	ND<0.5	ND<0.5	ND<5	
7/16/08	ND<50	ND<0.5	ND<0.5	ND<0.5	ND<0.5	7.3	ND<0.5	ND<0.5	ND<0.5	ND<5	
10/8/08	ND<50	ND<0.5	ND<0.5	ND<0.5	ND<0.5	5.7	ND<0.5	ND<0.5	ND<0.5	ND<5	
1/29/09	98	ND<0.5	ND<0.5	ND<0.5	ND<0.5	11	ND<0.5	ND<0.5	ND<0.5	ND<5	
DUP ^(h)	1/29/09	250	ND<0.5	ND<0.5	ND<0.5	ND<0.5	19	ND<0.5	ND<0.5	ND<0.5	ND<5
	4/14/09	ND<50	ND<0.5	ND<0.5	ND<0.5	ND<0.5	5.2	ND<0.5	ND<0.5	ND<0.5	ND<5
	7/1/09	110	ND<0.5	ND<0.5	ND<0.5	ND<0.5	24	ND<0.5	ND<0.5	ND<0.5	ND<5
	10/7/09	170	ND<0.5	ND<0.5	ND<0.5	ND<0.5	28	ND<0.5	ND<0.5	ND<0.5	ND<5
	2/17/10	60	ND<0.5	ND<0.5	ND<0.5	ND<0.5	21	ND<0.5	ND<0.5	ND<0.5	ND<5
	4/13/10	ND<50	ND<0.5	ND<0.5	ND<0.5	ND<0.5	4.9	ND<0.5	ND<0.5	ND<0.5	ND<5
	7/6/10	160	ND<0.5	ND<0.5	ND<0.5	ND<0.5	6.1	ND<0.5	ND<0.5	ND<0.5	ND<5

TABLE D-1

HISTORICAL GROUNDWATER MONITORING ANALYTICAL RESULTS
TESORO - SAN LORENZO, 67107

Monitoring Well	Sample Date ^(a)	TPHg ^(b) (µg/l)	Benzene ^(b) (µg/l)	Toluene ^(b) (µg/l)	Ethylbenzene ^(b) (µg/l)	Total Xylenes ^(b) (µg/l)	MTBE ^(b) (µg/l)	DIPE ^(b) (µg/l)	ETBE ^(b) (µg/l)	TAME ^(b) (µg/l)	TBA ^(b) (µg/l)
ESLs ^(c)		100	1.0	40	30	20	5.0	NE ^(d)	NE	NE	12
MW-1 (cont.)	10/27/10	200	ND<0.5	ND<0.5	ND<0.5	ND<0.5	4.7	ND<0.5	ND<0.5	ND<0.5	ND<5
	1/25/11	140	ND<0.5	ND<0.5	ND<0.5	ND<0.5	6.8	ND<0.5	ND<0.5	ND<0.5	ND<5
	4/5/11	63	ND<0.5	ND<0.5	ND<0.5	ND<0.5	0.59	ND<0.5	ND<0.5	ND<0.5	ND<5
	10/31/11	ND<50	ND<0.5	ND<0.5	ND<0.5	ND<0.5	3.0	ND<0.5	ND<0.5	ND<0.5	ND<5
	6/13/12	260	ND<0.5	ND<0.5	ND<0.5	ND<0.5	0.98	ND<0.5	ND<0.5	ND<0.5	ND<5
	1/2/13	100	ND<0.5	ND<0.5	ND<0.5	ND<0.5	1.3	ND<0.5	ND<0.5	ND<0.5	ND<5
MW-2	2/18/92	1,600	ND<0.5	ND<0.5	1.9	ND<0.5	--	--	--	--	--
	5/14/92	740	1.2	1.0	1.3	ND<0.5	--	--	--	--	--
	8/27/92	1,400	6.5	1.1	0.60	ND<0.5	--	--	--	--	--
	11/19/92	360	ND<0.5	ND<0.5	2.7	ND<0.5	--	--	--	--	--
	2/3/93	590	1.2	1.6	4.5	6.4	--	--	--	--	--
	6/23/93	160	ND<0.5	ND<0.5	0.52	0.50	--	--	--	--	--
	9/22/93	290	ND<0.5	0.59	1.2	0.59	--	--	--	--	--
	1/24/94	330	ND<0.5	ND<0.5	0.68	ND<0.5	--	--	--	--	--
	4/7/94	490	ND<0.5	ND<0.5	ND<0.5	4.4	--	--	--	--	--
	6/7/94	550	ND<0.5	ND<0.5	1.5	ND<0.5	--	--	--	--	--
	9/28/94	190	ND<0.5	ND<0.5	ND<0.5	ND<0.5	--	--	--	--	--
	12/14/94	1,400	7.2	0.84	ND<0.5	ND<0.5	--	--	--	--	--
	3/15/95	730	39	ND<0.5	0.53	ND<0.5	--	--	--	--	--
	6/13/95	750 ^(g)	8.3	ND<0.5	ND<0.5	ND<0.5	--	--	--	--	--
	9/28/95	670 ^(g)	ND<0.5	ND<0.5	ND<0.5	ND<0.5	--	--	--	--	--
	12/28/95	3,100	9.5	ND<5	ND<5	5.2	4,800	--	--	--	--
	3/12/96	710	ND<1.3	ND<1.3	ND<1.3	ND<1.3	3,200	--	--	--	--
	6/13/96	1,900 ^(g)	1.6	1.6	ND<1.3	ND<1.3	5,100	--	--	--	--
	10/2/96	2,800	ND<2.5	ND<2.5	ND<2.5	ND<2.5	7,900	--	--	--	--
	1/28/97	130	ND<0.5	ND<0.5	ND<0.5	ND<0.5	210	--	--	--	--
	5/20/97	1,400	120	16	ND<2.5	4.0	390	--	--	--	--
	8/18/97	ND<250	ND<2.5	ND<2.5	ND<2.5	ND<2.5	2,000	--	--	--	--
	11/5/97	ND<250	ND<2.5	ND<2.5	ND<2.5	ND<2.5	2,900	--	--	--	--
	3/31/98	ND<10,000	ND<0.5	ND<0.5	ND<0.5	ND<0.5	85,000	--	--	--	--
5/28/98	ND<50,000	ND<500	ND<500	ND<500	ND<500	97,000	--	--	--	--	
8/19/98	210	ND<0.5	ND<0.5	ND<0.5	ND<0.5	22,000	--	--	--	--	
11/17/98	ND<50	ND<0.5	ND<0.5	ND<0.5	ND<0.5	17,000	--	--	--	--	
2/18/99	ND<50	ND<0.5	ND<0.5	ND<0.5	ND<0.5	13,000	--	--	--	--	
6/24/99	180	ND<15	ND<15	ND<15	ND<15	39,000	--	--	--	--	
8/30/99	ND<2,500	ND<25	ND<25	ND<25	ND<25	18,000	--	--	--	--	
11/9/99	ND<500	ND<5	ND<5	ND<5	ND<5	14,000	--	--	--	--	

TABLE D-1

HISTORICAL GROUNDWATER MONITORING ANALYTICAL RESULTS
TESORO - SAN LORENZO, 67107

Monitoring Well	Sample Date ^(a)	TPHg ^(b) (µg/l)	Benzene ^(b) (µg/l)	Toluene ^(b) (µg/l)	Ethylbenzene ^(b) (µg/l)	Total Xylenes ^(b) (µg/l)	MTBE ^(b) (µg/l)	DIPE ^(b) (µg/l)	ETBE ^(b) (µg/l)	TAME ^(b) (µg/l)	TBA ^(b) (µg/l)
ESLs ^(c)		100	1.0	40	30	20	5.0	NE ^(d)	NE	NE	12
MW-2 (cont.)	3/22/00	ND<500	ND<5	ND<5	ND<5	ND<5	54,000	--	--	--	--
	6/12/00	ND<2,000	ND<20	ND<20	ND<20	ND<20	53,000	--	--	--	--
	11/15/00	ND<5,000	ND<50	ND<50	ND<50	ND<50	35,000	--	--	--	--
	2/26/01	ND<2,000	ND<20	ND<20	ND<20	ND<20	2,800	--	--	--	--
	5/21/01	ND<5,000	ND<25	ND<25	ND<25	ND<25	20,000	--	--	--	--
	9/5/01	ND<2,000	ND<20	ND<20	ND<20	ND<20	12,000	--	--	--	--
	11/7/01	ND<2,000	ND<20	ND<20	ND<20	ND<20	7,800	--	--	--	--
	2/11/02	ND<500	ND<5	ND<5	ND<5	ND<5	1500	--	--	--	--
	6/3/02	ND<500	ND<5	ND<5	ND<5	ND<5	2,200	--	--	--	--
	8/6/02	ND<500	ND<5	ND<5	ND<5	ND<5	3,300	--	--	--	--
	11/14/02	ND<1,000	ND<10	ND<10	ND<10	ND<10	3,200	--	--	--	--
	2/20/03	ND<50	ND<2	ND<2	ND<2	ND<2	160	--	--	--	--
	5/15/03	ND<50	ND<0.5	ND<0.5	ND<0.5	ND<0.5	270	ND<0.5	ND<0.5	ND<0.5	ND<5
	7/31/03	ND<50	ND<0.5	ND<0.5	ND<0.5	ND<0.5	300	ND<2	ND<0.5	ND<0.5	ND<5
	10/28/03	ND<50	ND<0.5	ND<0.5	ND<0.5	ND<0.5	1,800	ND<1	ND<0.5	1.8	20
	2/28/04	ND<50	ND<0.5	ND<0.5	ND<0.5	ND<0.5	340	ND<1.5	ND<0.5	ND<0.5	ND<5
	4/16/04	ND<50	ND<0.5	ND<0.5	ND<0.5	ND<0.5	130	ND<1.5	ND<0.5	ND<0.5	35
	7/16/04	ND<50	ND<0.5	ND<0.5	ND<0.5	ND<0.5	68	ND<1	ND<0.5	ND<0.5	ND<5
	11/13/04	ND<50	ND<0.5	ND<0.5	ND<0.5	ND<0.5	35	ND<0.5	ND<0.5	ND<0.5	ND<5
	2/4/05	ND<50	ND<0.5	ND<0.5	ND<0.5	ND<0.5	22	ND<0.5	ND<0.5	ND<0.5	ND<5
	4/13/05	ND<50	ND<0.5	ND<0.5	ND<0.5	ND<0.5	11	ND<0.5	ND<0.5	ND<0.5	ND<5
	8/10/05	ND<50	ND<0.5	ND<0.5	ND<0.5	ND<0.5	12	ND<0.5	ND<0.5	ND<0.5	ND<5
	11/5/05	ND<50	ND<0.5	ND<0.5	ND<0.5	ND<0.5	11	ND<0.5	ND<0.5	ND<0.5	ND<5
	1/30/06	ND<50	ND<0.5	ND<0.5	ND<0.5	ND<0.5	5.2	ND<0.5	ND<0.5	ND<0.5	ND<5
	4/28/06	ND<50	ND<0.5	ND<0.5	ND<0.5	ND<0.5	1.3	ND<0.5	ND<0.5	ND<0.5	ND<5
	8/15/06	ND<50	ND<0.5	ND<0.5	ND<0.5	ND<0.5	2.7	ND<0.5	ND<0.5	ND<0.5	ND<5
	10/26/06	ND<50	ND<0.5	ND<0.5	ND<0.5	ND<0.5	1.9	ND<0.5	ND<0.5	ND<0.5	ND<5
	2/2/07	ND<50	ND<0.5	ND<0.5	ND<0.5	ND<0.5	1.1	ND<0.5	ND<0.5	ND<0.5	ND<5
4/30/07	ND<50	ND<0.5	ND<0.5	ND<0.5	ND<0.5	0.85	ND<0.5	ND<0.5	ND<0.5	ND<5	
7/18/07	ND<50	ND<0.5	ND<0.5	ND<0.5	ND<0.5	1.2	ND<0.5	ND<0.5	ND<0.5	ND<5	
10/30/07	ND<50	ND<0.5	ND<0.5	ND<0.5	ND<0.5	1.7	ND<0.5	ND<0.5	ND<0.5	ND<5	
1/28/08	ND<50	ND<0.5	ND<0.5	ND<0.5	ND<0.5	0.89	ND<0.5	ND<0.5	ND<0.5	ND<5	
5/13/08	ND<50	ND<0.5	ND<0.5	ND<0.5	ND<0.5	0.86	ND<0.5	ND<0.5	ND<0.5	ND<5	
7/16/08	ND<50	ND<0.5	ND<0.5	ND<0.5	ND<0.5	1.3	ND<0.5	ND<0.5	ND<0.5	ND<5	
10/8/08	ND<50	ND<0.5	ND<0.5	ND<0.5	ND<0.5	1.8	ND<0.5	ND<0.5	ND<0.5	ND<5	
1/29/09	ND<50	ND<0.5	ND<0.5	ND<0.5	ND<0.5	1.6	ND<0.5	ND<0.5	ND<0.5	ND<5	
4/14/09	ND<50	ND<0.5	ND<0.5	ND<0.5	ND<0.5	0.77	ND<0.5	ND<0.5	ND<0.5	ND<5	

TABLE D-1

HISTORICAL GROUNDWATER MONITORING ANALYTICAL RESULTS
TESORO - SAN LORENZO, 67107

Monitoring Well	Sample Date ^(a)	TPH ^(b) (µg/l)	Benzene ^(b) (µg/l)	Toluene ^(b) (µg/l)	Ethylbenzene ^(b) (µg/l)	Total Xylenes ^(b) (µg/l)	MTBE ^(b) (µg/l)	DIPE ^(b) (µg/l)	ETBE ^(b) (µg/l)	TAME ^(b) (µg/l)	TBA ^(b) (µg/l)
ESLs ^(c)		100	1.0	40	30	20	5.0	NE ^(d)	NE	NE	12
MW-2 (cont.)	7/1/09	ND<0.5	ND<0.5	ND<0.5	ND<0.5	ND<0.5	1.6	ND<0.5	ND<0.5	ND<0.5	ND<0.5
	10/7/09	ND<0.5	ND<0.5	ND<0.5	ND<0.5	ND<0.5	1.3	ND<0.5	ND<0.5	ND<0.5	ND<0.5
	2/17/10	ND<0.5	ND<0.5	ND<0.5	ND<0.5	ND<0.5	0.58	ND<0.5	ND<0.5	ND<0.5	ND<0.5
	4/13/10	ND<0.5	ND<0.5	ND<0.5	ND<0.5	ND<0.5	ND<0.5	ND<0.5	ND<0.5	ND<0.5	ND<0.5
	7/6/10	ND<0.5	ND<0.5	ND<0.5	ND<0.5	ND<0.5	ND<0.5	ND<0.5	ND<0.5	ND<0.5	ND<0.5
	10/27/10	ND<0.5	ND<0.5	ND<0.5	ND<0.5	ND<0.5	ND<0.5	ND<0.5	ND<0.5	ND<0.5	ND<0.5
	1/25/11	ND<0.5	ND<0.5	ND<0.5	ND<0.5	ND<0.5	ND<0.5	ND<0.5	ND<0.5	ND<0.5	ND<0.5
	4/5/11	ND<0.5	ND<0.5	ND<0.5	ND<0.5	ND<0.5	ND<0.5	ND<0.5	ND<0.5	ND<0.5	ND<0.5
	6/13/12	ND<0.5	ND<0.5	ND<0.5	ND<0.5	ND<0.5	ND<0.5	ND<0.5	ND<0.5	ND<0.5	ND<0.5
MW-3	5/15/92	160,000	6,300	5,900	1,700	6,100	--	--	--	--	--
	8/28/92	1,300,000	2,500	40,000	6,700	44,000	--	--	--	--	--
	2/3/93	82,000	7,200	11,000	2,900	13,000	--	--	--	--	--
	6/23/93	61,000	3,200	5,300	2,500	9,100	--	--	--	--	--
	9/22/93	94,000	12,000	14,000	3,900	18,000	--	--	--	--	--
	1/24/94	110,000	14,000	17,000	4,200	14,000	--	--	--	--	--
	4/7/94	28,000	6,500	1,800	1,700	4,100	--	--	--	--	--
	6/7/94	27,000	6,400	2,300	1,500	3,500	--	--	--	--	--
	9/28/94	40,000	7,400	4,300	1,500	4,600	--	--	--	--	--
	12/14/94	140,000	17,000	21,000	3,900	22,000	--	--	--	--	--
	3/15/95	58,000	4,900	1,900	1,800	7,100	--	--	--	--	--
	6/13/95	44,000	7,200	2,900	1,200	4,600	--	--	--	--	--
	9/28/95	30,000	5,600	2,100	1,900	6,900	--	--	--	--	--
	12/28/95	16,000	32	5.8	18	4,700	360	--	--	--	--
	1/30/96	8,700	850	800	190	1,700	430	--	--	--	--
	3/12/96	2,400	48	64	5.3	630	97	--	--	--	--
	7/10/97	300	ND<0.5	ND<0.5	ND<0.5	4.8	40	--	--	--	--
	8/18/97	3,600	480	8.4	100	230	170	--	--	--	--
	9/29/97	3,500	740	8.6	160	240	210	--	--	--	--
	11/5/97	4,100	870	15	180	210	240	--	--	--	--
	3/31/98	12,000	1,800	600	410	1,400	510	--	--	--	--
	5/28/98	6,500	1,500	400	280	870	480	--	--	--	--
	8/19/98	1,400	130	11	24	60	140	--	--	--	--
11/17/98	510	48	3.5	9.9	14	120	--	--	--	--	
2/18/99	690	67	28	24	81	88	--	--	--	--	
6/24/99	540	27	21	8.6	32	61	--	--	--	--	
8/30/99	250	12	12	3.2	13	50	--	--	--	--	
11/9/99	230	9.8	5.3	3.4	10	48	--	--	--	--	

TABLE D-1

HISTORICAL GROUNDWATER MONITORING ANALYTICAL RESULTS
TESORO - SAN LORENZO, 67107

Monitoring Well	Sample Date ^(a)	TPHg ^(b) (µg/l)	Benzene ^(b) (µg/l)	Toluene ^(b) (µg/l)	Ethylbenzene ^(b) (µg/l)	Total Xylenes ^(b) (µg/l)	MTBE ^(b) (µg/l)	DIPE ^(b) (µg/l)	ETBE ^(b) (µg/l)	TAME ^(b) (µg/l)	TBA ^(b) (µg/l)
ESLs ^(c)		100	1.0	40	30	20	5.0	NE ^(d)	NE	NE	12
MW-3 (cont.)	3/22/00	1,500	180	47	46	100	80	--	--	--	--
	6/12/00	920	100	6.2	20	25	76	--	--	--	--
	11/15/00	1,100	280	5.0	21	20	140	--	--	--	--
	2/26/01	140	14	4.3	3.1	11	230	--	--	--	190
	5/21/01	510	36	0.72	1.0	2.2	280	--	--	--	110
	9/5/01	390	59	0.53	0.75	0.57	620	--	--	--	120
	11/7/01	830	170	2.3	4.9	4.8	900	--	--	--	--
	2/11/02	370	17	ND<2.5	4.7	7.9	1,200	--	--	--	--
	6/3/02	460	120	ND<2.5	5.6	8.4	1,400	--	--	--	140
	8/6/02	800	110	ND<5	ND<5	ND<5	2,200	--	--	--	170
	11/14/02	1,400	89	ND<10	ND<10	ND<10	2,800	--	--	--	210
	2/20/03	ND<500	14	ND<5	ND<5	ND<5	2,300	--	--	--	97
	5/15/03	ND<500	43	ND<5	ND<5	ND<5	2,000	ND<5	ND<5	ND<5	87
	7/31/03	1,500	280	ND<5	6.6	7.4	1,600	ND<5	ND<5	ND<5	130
10/28/03	2,200	140	1.6	6.5	4.0	1,100	ND<0.5	ND<0.5	0.75	74	
2/28/04	1,200	99	31	12	52	1,500	ND<0.5	ND<0.5	ND<0.5	82	
4/16/04	1,200	95	19	12	48	1,100	ND<0.5	ND<0.5	ND<0.5	340	
7/16/04	980	94	27	9.4	38	810	ND<0.5	ND<0.5	ND<0.5	580	
MW-3R	11/13/04	9,000	580	52	440	1,600	450	ND<0.5	ND<0.5	ND<0.5	440
	2/4/05	5,400	350	29	260	1,100	270	ND<0.5	ND<0.5	ND<0.5	390
	4/13/05	20,000	1,300	84	1,200	3,200	290	ND<0.5	ND<0.5	ND<0.5	150
	8/10/05	7,100	400	23	340	1,200	110	ND<0.5	ND<0.5	ND<0.5	160
	11/5/05	4,100	230	10	250	600	81	ND<0.5	ND<0.5	ND<0.5	200
	1/30/06	6,100	460	20	470	1,000	85	ND<0.5	ND<0.5	ND<0.5	190
	4/28/06	8,200	510	15	490	940	81	ND<0.5	ND<0.5	ND<0.5	90
	8/15/06	5,600	470	11	500	660	80	ND<0.5	ND<0.5	ND<0.5	92
	10/26/06	1,800	82	4.2	38	220	53	ND<0.5	ND<0.5	ND<0.5	45
	2/2/07	1,500	94	4.3	7.0	110	42	ND<0.5	ND<0.5	ND<0.5	26
	4/30/07	3,700	240	17	280	300	38	ND<0.5	ND<0.5	ND<0.5	22
	7/18/07	690	85	1.5	3.6	20	29	ND<0.5	ND<0.5	ND<0.5	17
	10/30/07	410	46	0.90	4.7	12	19	ND<0.5	ND<0.5	ND<0.5	14
	1/28/08	4,500	350	10	250	220	48	ND<0.5	ND<0.5	ND<0.5	22
	5/13/08	1,300	68	4.4	74	38	18	ND<0.5	ND<0.5	ND<0.5	15
7/16/08	1,400	71	9.8	38	20	35	ND<0.5	ND<0.5	ND<0.5	33	
10/8/08	980	66	2.5	6.7	ND<0.5	32	ND<0.5	ND<0.5	ND<0.5	22	
1/29/09	58	ND<0.5	ND<0.5	ND<0.5	ND<0.5	11	ND<0.5	ND<0.5	ND<0.5	8.0	
DUP	1/30/09	860	82	1.4	16	4.3	19	ND<0.5	ND<0.5	ND<0.5	21

TABLE D-1

HISTORICAL GROUNDWATER MONITORING ANALYTICAL RESULTS
TESORO - SAN LORENZO, 67107

Monitoring Well	Sample Date ^(a)	TPH ^(b) (µg/l)	Benzene ^(b) (µg/l)	Toluene ^(b) (µg/l)	Ethylbenzene ^(b) (µg/l)	Total Xylenes ^(b) (µg/l)	MTBE ^(b) (µg/l)	DIPE ^(b) (µg/l)	ETBE ^(b) (µg/l)	TAME ^(b) (µg/l)	TBA ^(b) (µg/l)
ESLs ^(c)		100	1.0	40	30	20	5.0	NE ^(d)	NE	NE	12
MW-3R (cont.)	4/15/09	120	1.6	ND<0.5	ND<0.5	ND<0.5	12	ND<0.5	ND<0.5	ND<0.5	16
	7/1/09	690	30	1.2	4.4	2.0	19	ND<0.5	ND<0.5	ND<0.5	20
	10/7/09	480	28	0.73	2.3	1.5	20	ND<0.5	ND<0.5	ND<0.5	16
	2/18/10	400	38	0.76	25	6.5	10	ND<0.5	ND<0.5	ND<0.5	18
	4/14/10	840	81	1.4	62	22	16	ND<0.5	ND<0.5	ND<0.5	16
	7/7/10	570	59	0.94	21	5.6	13	ND<0.5	ND<0.5	ND<0.5	16
	10/27/10	420	24	0.56	2.1	0.83	12	ND<0.5	ND<0.5	ND<0.5	14
	1/25/11	1,100	64	1.1	40	9.4	9.8	ND<0.5	ND<0.5	ND<0.5	14
	4/6/11	980	71	1.2	43	14	14	ND<0.5	ND<0.5	ND<0.5	11
	10/31/11	1,200	83	1.1	24	4.8	16	ND<0.5	ND<0.5	ND<0.5	14
	6/13/12	1,300	70	1.4	23	4.4	14	ND<0.5	ND<0.5	ND<0.5	16
1/2/13	240	15	ND<0.5	6.0	0.95	6.1	ND<0.5	ND<0.5	ND<0.5	13	
MW-4	2/18/92	5,100	ND<0.5	ND<0.5	12	21	--	--	--	--	--
	5/14/92	4,600	ND<0.5	5.6	1.8	2.2	--	--	--	--	--
	8/28/92	1,700	6.6	1.3	1.6	3.1	--	--	--	--	--
	11/19/92	400	ND<0.5	ND<0.5	ND<0.5	ND<0.5	--	--	--	--	--
	2/3/93	1,100	ND<0.5	ND<0.5	ND<0.5	ND<0.5	--	--	--	--	--
	6/23/93	120	ND<0.5	ND<0.5	ND<0.5	ND<0.5	--	--	--	--	--
	9/22/93	110	ND<0.5	ND<0.5	ND<0.5	ND<0.5	--	--	--	--	--
	1/24/94	260	ND<0.5	ND<0.5	ND<0.5	ND<0.5	--	--	--	--	--
	4/7/94	430	ND<0.5	ND<0.5	ND<0.5	ND<0.5	--	--	--	--	--
	6/7/94	150	ND<0.5	ND<0.5	ND<0.5	ND<0.5	--	--	--	--	--
	9/28/94	75	ND<0.5	ND<0.5	ND<0.5	ND<0.5	--	--	--	--	--
	12/14/94	160	ND<0.5	ND<0.5	ND<0.5	ND<0.5	--	--	--	--	--
	3/15/95	500	ND<0.5	ND<0.5	ND<0.5	ND<0.5	--	--	--	--	--
	6/13/95	210 ^(g)	ND<0.5	ND<0.5	ND<0.5	ND<0.5	--	--	--	--	--
	9/28/95	140 ^(g)	ND<0.5	ND<0.5	ND<0.5	ND<0.5	--	--	--	--	--
	12/28/95	510 ^(g)	ND<0.5	ND<0.5	ND<0.5	ND<0.5	ND<5	--	--	--	--
	3/12/96	ND<50	ND<0.5	ND<0.5	ND<0.5	ND<0.5	ND<5	--	--	--	--
	6/11/96	50 ^(g)	ND<0.5	ND<0.5	ND<0.5	ND<0.5	ND<5	--	--	--	--
	10/2/96	ND<50	ND<0.5	ND<0.5	ND<0.5	ND<0.5	ND<5	--	--	--	--
	1/28/97	270 ^(g)	ND<0.5	ND<0.5	ND<0.5	ND<0.5	ND<5	--	--	--	--
5/20/97	ND<50	ND<0.5	ND<0.5	ND<0.5	ND<0.5	ND<5	--	--	--	--	
8/18/97	ND<50	ND<0.5	ND<0.5	ND<0.5	ND<0.5	ND<5	--	--	--	--	
11/5/97	ND<50	ND<0.5	ND<0.5	ND<0.5	ND<0.5	ND<0.5	--	--	--	--	
3/31/98	110	ND<0.5	ND<0.5	ND<0.5	ND<0.5	ND<5	--	--	--	--	
5/28/98	94	ND<0.5	ND<0.5	ND<0.5	ND<0.5	ND<5	--	--	--	--	

TABLE D-1

HISTORICAL GROUNDWATER MONITORING ANALYTICAL RESULTS
TESORO - SAN LORENZO, 67107

Monitoring Well	Sample Date ^(a)	TPHg ^(b) (µg/l)	Benzene ^(b) (µg/l)	Toluene ^(b) (µg/l)	Ethylbenzene ^(b) (µg/l)	Total Xylenes ^(b) (µg/l)	MTBE ^(b) (µg/l)	DIPE ^(b) (µg/l)	ETBE ^(b) (µg/l)	TAME ^(b) (µg/l)	TBA ^(b) (µg/l)
ESLs ^(c)		100	1.0	40	30	20	5.0	NE ^(d)	NE	NE	12
MW-4 (cont.)	8/19/98	120 ^(g)	ND<0.5	ND<0.5	ND<0.5	ND<0.5	46	--	--	--	--
	11/17/98	ND<50	1.3	ND<0.5	ND<0.5	ND<0.5	780	--	--	--	--
	2/18/99	130	8.2	ND<0.5	ND<0.5	ND<0.5	240	--	--	--	--
	6/24/99	ND<50	ND<1	ND<0.5	ND<0.5	ND<0.5	2,100	--	--	--	--
	11/9/99	ND<50	ND<0.5	ND<0.5	ND<0.5	ND<0.5	2,500	--	--	--	--
	3/22/00	69	ND<0.5	ND<0.5	ND<0.5	ND<0.5	12,000	--	--	--	--
	6/12/00	ND<2,000	ND<20	ND<20	ND<20	ND<20	17,000	--	--	--	--
	11/15/00	ND<100	ND<1	ND<1	ND<1	ND<1	17,000	--	--	--	--
	5/21/01	ND<5,000	ND<25	ND<25	ND<25	ND<25	13,000	--	--	--	--
	11/7/01	ND<1,000	ND<10	ND<10	ND<10	ND<10	3,800	--	--	--	--
	6/3/02	ND<200	ND<2	ND<2	ND<2	ND<2	1,100	--	--	--	--
	11/14/02	ND<200	ND<2	ND<2	ND<2	ND<2	700	--	--	--	--
	5/15/03	ND<50	ND<0.5	ND<0.5	ND<0.5	ND<0.5	73	ND<0.5	ND<0.5	ND<0.5	ND<5
	10/28/03	ND<50	ND<0.5	ND<0.5	ND<0.5	ND<0.5	65	ND<0.5	ND<0.5	ND<0.5	ND<5
	4/16/04	ND<50	ND<0.5	ND<0.5	ND<0.5	ND<0.5	6.0	ND<0.5	ND<0.5	ND<0.5	ND<5
	11/13/04	ND<50	ND<0.5	ND<0.5	ND<0.5	ND<0.5	50	ND<0.5	ND<0.5	ND<0.5	ND<5
	1/30/06	ND<50	ND<0.5	ND<0.5	ND<0.5	ND<0.5	3.5	ND<0.5	ND<0.5	ND<0.5	ND<5
	4/28/06	ND<50	ND<0.5	ND<0.5	ND<0.5	ND<0.5	0.89	ND<0.5	ND<0.5	ND<0.5	ND<5
	8/15/06	ND<50	ND<0.5	ND<0.5	ND<0.5	ND<0.5	8.8	ND<0.5	ND<0.5	ND<0.5	ND<5
	10/26/06	ND<50	ND<0.5	ND<0.5	ND<0.5	ND<0.5	7.7	ND<0.5	ND<0.5	ND<0.5	ND<5
	2/2/07	ND<50	ND<0.5	ND<0.5	ND<0.5	ND<0.5	1.0	ND<0.5	ND<0.5	ND<0.5	ND<5
	4/30/07	ND<50	ND<0.5	ND<0.5	ND<0.5	ND<0.5	ND<0.5	ND<0.5	ND<0.5	ND<0.5	ND<5
	7/18/07	ND<50	ND<0.5	ND<0.5	ND<0.5	ND<0.5	ND<0.5	ND<0.5	ND<0.5	ND<0.5	ND<5
	10/30/07	90	ND<0.5	ND<0.5	ND<0.5	ND<0.5	ND<0.5	ND<0.5	ND<0.5	ND<0.5	ND<5
	1/28/08	ND<50	ND<0.5	ND<0.5	ND<0.5	ND<0.5	1.7	ND<0.5	ND<0.5	ND<0.5	ND<5
	5/13/08	ND<50	ND<0.5	ND<0.5	ND<0.5	ND<0.5	ND<0.5	ND<0.5	ND<0.5	ND<0.5	ND<5
	7/16/08	ND<50	ND<0.5	ND<0.5	ND<0.5	ND<0.5	0.51	ND<0.5	ND<0.5	ND<0.5	ND<5
10/8/08	ND<50	ND<0.5	ND<0.5	ND<0.5	ND<0.5	ND<0.5	ND<0.5	ND<0.5	ND<0.5	ND<5	
1/29/09	ND<50	ND<0.5	ND<0.5	ND<0.5	ND<0.5	ND<0.5	ND<0.5	ND<0.5	ND<0.5	ND<5	
4/14/09	ND<50	ND<0.5	ND<0.5	ND<0.5	ND<0.5	ND<0.5	ND<0.5	ND<0.5	ND<0.5	ND<5	
7/1/09	ND<50	ND<0.5	ND<0.5	ND<0.5	ND<0.5	ND<0.5	ND<0.5	ND<0.5	ND<0.5	ND<5	
10/7/09	ND<50	ND<0.5	ND<0.5	ND<0.5	ND<0.5	0.56	ND<0.5	ND<0.5	ND<0.5	ND<5	
2/17/10	ND<50	ND<0.5	ND<0.5	ND<0.5	ND<0.5	ND<0.5	ND<0.5	ND<0.5	ND<0.5	ND<5	
4/13/10	ND<50	ND<0.5	ND<0.5	ND<0.5	ND<0.5	ND<0.5	ND<0.5	ND<0.5	ND<0.5	ND<5	
7/6/10	ND<50	ND<0.5	ND<0.5	0.62	0.83	ND<0.5	ND<0.5	ND<0.5	ND<0.5	ND<5	
10/27/10	ND<50	ND<0.5	ND<0.5	ND<0.5	ND<0.5	0.65	ND<0.5	ND<0.5	ND<0.5	ND<5	
1/25/11	ND<50	ND<0.5	ND<0.5	ND<0.5	ND<0.5	ND<0.5	ND<0.5	ND<0.5	ND<0.5	ND<5	

TABLE D-1

HISTORICAL GROUNDWATER MONITORING ANALYTICAL RESULTS
TESORO - SAN LORENZO, 67107

Monitoring Well	Sample Date ^(a)	TPH ^(b) (µg/l)	Benzene ^(b) (µg/l)	Toluene ^(b) (µg/l)	Ethylbenzene ^(b) (µg/l)	Total Xylenes ^(b) (µg/l)	MTBE ^(b) (µg/l)	DIPE ^(b) (µg/l)	ETBE ^(b) (µg/l)	TAME ^(b) (µg/l)	TBA ^(b) (µg/l)
ESLs ^(c)		100	1.0	40	30	20	5.0	NE ^(d)	NE	NE	12
MW-4	4/5/11	ND<50	ND<0.5	ND<0.5	ND<0.5	ND<0.5	ND<0.5	ND<0.5	ND<0.5	ND<0.5	ND<5
(cont.)	6/13/12	ND<50	ND<0.5	ND<0.5	ND<0.5	ND<0.5	ND<0.5	ND<0.5	ND<0.5	ND<0.5	ND<5
MW-5	2/18/92	ND<50	ND<0.5	ND<0.5	ND<0.5	ND<0.5	--	--	--	--	--
	5/14/92	ND<50	ND<0.5	ND<0.5	ND<0.5	ND<0.5	--	--	--	--	--
	8/27/92	ND<50	ND<0.5	ND<0.5	ND<0.5	ND<0.5	--	--	--	--	--
	11/19/92	ND<50	ND<0.5	ND<0.5	ND<0.5	ND<0.5	--	--	--	--	--
	2/3/93	55	3.0	2.7	8.0	9.9	--	--	--	--	--
	6/23/93	ND<50	ND<0.5	ND<0.5	ND<0.5	ND<0.5	--	--	--	--	--
	9/22/93	ND<50	0.66	1.1	ND<0.5	0.60	--	--	--	--	--
	1/24/94	ND<50	ND<0.5	ND<0.5	ND<0.5	ND<0.5	--	--	--	--	--
	4/7/94	ND<50	ND<0.5	ND<0.5	ND<0.5	ND<0.5	--	--	--	--	--
	6/7/94	ND<50	ND<0.5	ND<0.5	ND<0.5	ND<0.5	--	--	--	--	--
	9/28/94	ND<50	ND<0.5	ND<0.5	ND<0.5	ND<0.5	--	--	--	--	--
	12/14/94	ND<50	ND<0.5	ND<0.5	ND<0.5	ND<0.5	--	--	--	--	--
	3/15/95	ND<50	ND<0.5	ND<0.5	ND<0.5	ND<0.5	--	--	--	--	--
	6/13/95	ND<50	ND<0.5	0.52	ND<0.5	ND<0.5	--	--	--	--	--
	9/28/95	ND<50	ND<0.5	ND<0.5	ND<0.5	ND<0.5	--	--	--	--	--
	12/28/95	120	ND<0.5	ND<0.5	ND<0.5	ND<0.5	ND<5	--	--	--	--
	3/12/96	ND<50	ND<0.5	ND<0.5	ND<0.5	ND<0.5	9.0	--	--	--	--
	6/11/96	ND<50	ND<0.5	ND<0.5	ND<0.5	ND<0.5	ND<5	--	--	--	--
	10/2/96	ND<50	ND<0.5	ND<0.5	ND<0.5	ND<0.5	ND<5	--	--	--	--
	1/28/97	ND<50	ND<0.5	ND<0.5	ND<0.5	ND<0.5	ND<5	--	--	--	--
	5/20/97	ND<50	ND<0.5	ND<0.5	ND<0.5	ND<0.5	ND<5	--	--	--	--
	8/18/97	ND<50	ND<0.5	ND<0.5	ND<0.5	ND<0.5	ND<5	--	--	--	--
	11/5/97	ND<50	ND<0.5	ND<0.5	ND<0.5	ND<0.5	ND<0.5	--	--	--	--
3/31/98	ND<50	ND<0.5	ND<0.5	ND<0.5	ND<0.5	ND<5	--	--	--	--	
5/28/98	ND<50	ND<0.5	ND<0.5	ND<0.5	ND<0.5	ND<5	--	--	--	--	
8/19/98	ND<50	ND<0.5	ND<0.5	ND<0.5	ND<0.5	7.1	--	--	--	--	
11/17/98	ND<50	ND<0.5	ND<0.5	ND<0.5	ND<0.5	6.3	--	--	--	--	
2/18/99	ND<50	ND<0.5	ND<0.5	ND<0.5	ND<0.5	ND<5	--	--	--	--	
3/22/00	ND<50	ND<0.5	ND<0.5	ND<0.5	ND<0.5	ND<5	--	--	--	--	
10/8/08	ND<50	ND<0.5	ND<0.5	ND<0.5	ND<0.5	ND<0.5	ND<0.5	ND<0.5	ND<0.5	ND<5	
1/29/09	ND<50	ND<0.5	ND<0.5	ND<0.5	ND<0.5	ND<0.5	ND<0.5	ND<0.5	ND<0.5	ND<5	
10/7/09	ND<50	ND<0.5	ND<0.5	ND<0.5	ND<0.5	ND<0.5	ND<0.5	ND<0.5	ND<0.5	ND<5	
4/13/10	ND<50	ND<0.5	ND<0.5	ND<0.5	ND<0.5	ND<0.5	ND<0.5	ND<0.5	ND<0.5	ND<5	
10/27/10	ND<50	ND<0.5	ND<0.5	ND<0.5	ND<0.5	ND<0.5	ND<0.5	ND<0.5	ND<0.5	ND<5	

TABLE D-1

HISTORICAL GROUNDWATER MONITORING ANALYTICAL RESULTS
TESORO - SAN LORENZO, 67107

Monitoring Well	Sample Date ^(a)	TPH ^(b) (µg/l)	Benzene ^(b) (µg/l)	Toluene ^(b) (µg/l)	Ethylbenzene ^(b) (µg/l)	Total Xylenes ^(b) (µg/l)	MTBE ^(b) (µg/l)	DIPE ^(b) (µg/l)	ETBE ^(b) (µg/l)	TAME ^(b) (µg/l)	TBA ^(b) (µg/l)
ESLs ^(c)		100	1.0	40	30	20	5.0	NE ^(d)	NE	NE	12
MW-6	2/18/92	370	4.8	ND<0.5	ND<0.5	ND<0.5	--	--	--	--	--
	5/14/92	120	ND<0.5	ND<0.5	ND<0.5	ND<0.5	--	--	--	--	--
	8/27/92	ND<50	1.2	ND<0.5	ND<0.5	ND<0.5	--	--	--	--	--
	11/19/92	66	1.3	ND<0.5	1.0	1.1	--	--	--	--	--
	2/3/93	100	1.9	2.6	23	12	--	--	--	--	--
	6/23/93	ND<50	ND<0.5	ND<0.5	ND<0.5	ND<0.5	--	--	--	--	--
	9/22/93	81	2.2	3.8	0.53	2.7	--	--	--	--	--
	1/24/94	98	ND<0.5	ND<0.5	ND<0.5	ND<0.5	--	--	--	--	--
	4/7/94	150	0.71	ND<0.5	ND<0.5	ND<0.5	--	--	--	--	--
	6/7/94	180	ND<0.5	ND<0.5	ND<0.5	ND<0.5	--	--	--	--	--
	9/28/94	100	ND<0.5	ND<0.5	ND<0.5	ND<0.5	--	--	--	--	--
	12/14/94	140	ND<0.5	ND<0.5	ND<0.5	ND<0.5	--	--	--	--	--
	3/15/95	110	ND<0.5	ND<0.5	ND<0.5	ND<0.5	--	--	--	--	--
	6/13/95	150 ^(g)	ND<0.5	0.87	ND<0.5	ND<0.5	ND<0.5	--	--	--	--
	9/28/95	ND<50	0.78	ND<0.5	ND<0.5	ND<0.5	ND<0.5	--	--	--	--
	12/28/95	410	ND<0.5	ND<0.5	ND<0.5	ND<0.5	70	--	--	--	--
	1/30/96	81	1.0	ND<0.5	ND<0.5	ND<0.5	46	--	--	--	--
	3/12/96	ND<50	ND<0.5	ND<0.5	ND<0.5	ND<0.5	7.0	--	--	--	--
	6/11/96	ND<50	ND<0.5	ND<0.5	ND<0.5	ND<0.5	ND<5	--	--	--	--
	10/2/96	ND<50	ND<0.5	ND<0.5	ND<0.5	ND<0.5	ND<5	--	--	--	--
	1/28/97	ND<50	ND<0.5	ND<0.5	ND<0.5	ND<0.5	ND<5	--	--	--	--
	5/20/97	ND<50	ND<0.5	ND<0.5	ND<0.5	ND<0.5	ND<5	--	--	--	--
	8/18/97	ND<50	ND<0.5	ND<0.5	ND<0.5	ND<0.5	ND<5	--	--	--	--
	11/5/97	ND<50	ND<0.5	ND<0.5	ND<0.5	ND<0.5	2.8	--	--	--	--
	3/31/98	ND<50	ND<0.5	ND<0.5	ND<0.5	ND<0.5	ND<5	--	--	--	--
	5/28/98	ND<50	ND<0.5	ND<0.5	ND<0.5	ND<0.5	ND<5	--	--	--	--
	8/19/98	ND<50	ND<0.5	ND<0.5	ND<0.5	ND<0.5	ND<5	--	--	--	--
	11/17/98	ND<50	ND<0.5	ND<0.5	ND<0.5	ND<0.5	ND<5	--	--	--	--
2/18/99	ND<50	ND<0.5	ND<0.5	ND<0.5	ND<0.5	ND<5	--	--	--	--	
3/22/00	ND<50	ND<0.5	ND<0.5	ND<0.5	ND<0.5	ND<5	--	--	--	--	
10/8/08	ND<50	ND<0.5	ND<0.5	ND<0.5	ND<0.5	5.1	ND<0.5	ND<0.5	ND<0.5	ND<5	
1/29/09	ND<50	ND<0.5	ND<0.5	ND<0.5	ND<0.5	3.5	ND<0.5	ND<0.5	ND<0.5	ND<5	
4/15/09	ND<50	ND<0.5	ND<0.5	ND<0.5	ND<0.5	ND<0.5	ND<0.5	ND<0.5	ND<0.5	ND<5	
7/1/09	ND<50	ND<0.5	ND<0.5	ND<0.5	ND<0.5	0.71	ND<0.5	ND<0.5	ND<0.5	ND<5	
10/7/09	ND<50	ND<0.5	ND<0.5	ND<0.5	ND<0.5	2.0	ND<0.5	ND<0.5	ND<0.5	ND<5	
2/18/10	ND<50	ND<0.5	ND<0.5	ND<0.5	ND<0.5	0.71	ND<0.5	ND<0.5	ND<0.5	ND<5	
4/14/10	ND<50	ND<0.5	ND<0.5	ND<0.5	ND<0.5	ND<0.5	ND<0.5	ND<0.5	ND<0.5	ND<5	

TABLE D-1

HISTORICAL GROUNDWATER MONITORING ANALYTICAL RESULTS
TESORO - SAN LORENZO, 67107

Monitoring Well	Sample Date ^(a)	TPH _g ^(b) (µg/l)	Benzene ^(b) (µg/l)	Toluene ^(b) (µg/l)	Ethylbenzene ^(b) (µg/l)	Total Xylenes ^(b) (µg/l)	MTBE ^(b) (µg/l)	DIPE ^(b) (µg/l)	ETBE ^(b) (µg/l)	TAME ^(b) (µg/l)	TBA ^(b) (µg/l)
ESLs ^(c)		100	1.0	40	30	20	5.0	NE ^(d)	NE	NE	12
MW-6 (cont.)	7/7/10	ND<50	ND<0.5	ND<0.5	ND<0.5	ND<0.5	ND<0.5	ND<0.5	ND<0.5	ND<0.5	ND<5
	10/27/10	ND<50	ND<0.5	ND<0.5	ND<0.5	ND<0.5	0.64	ND<0.5	ND<0.5	ND<0.5	ND<5
	1/25/11	ND<50	ND<0.5	ND<0.5	ND<0.5	ND<0.5	ND<0.5	ND<0.5	ND<0.5	ND<0.5	ND<5
	4/6/11	ND<50	ND<0.5	ND<0.5	ND<0.5	ND<0.5	ND<0.5	ND<0.5	ND<0.5	ND<0.5	ND<5
	6/13/12	ND<50	ND<0.5	ND<0.5	ND<0.5	ND<0.5	ND<0.5	ND<0.5	ND<0.5	ND<0.5	ND<5
MW-7	2/18/92	670	16	ND<0.5	10	16	--	--	--	--	--
	5/14/92	1,500	44	ND<0.5	38	88	--	--	--	--	--
	8/27/92	23,000	400	5.8	290	1,400	--	--	--	--	--
	11/19/92	330	29	ND<0.5	10	53	--	--	--	--	--
	2/3/93	2,000	200	ND<0.5	110	480	--	--	--	--	--
	6/23/93	280	20	ND<0.5	16	16	--	--	--	--	--
	9/22/93	860	71	2.2	33	210	--	--	--	--	--
	1/24/94	900	61	ND<1.3	10	160	--	--	--	--	--
	4/7/94	630	53	ND<0.5	7.1	49	--	--	--	--	--
	6/7/94	730	55	ND<0.5	14	24	--	--	--	--	--
	9/28/94	300	21	ND<0.5	2.3	3.1	--	--	--	--	--
	12/14/94	430	19	ND<0.5	3.3	32	--	--	--	--	--
	3/15/95	70	0.88	ND<0.5	ND<0.5	ND<0.5	--	--	--	--	--
	6/13/95	190	7.3	0.79	7.6	8.9	--	--	--	--	--
	9/28/95	60	1.5	ND<0.5	1.2	0.84	--	--	--	--	--
	12/28/95	60	ND<0.5	ND<0.5	0.91	0.69	10	--	--	--	--
	3/12/96	ND<50	ND<0.5	ND<0.5	ND<0.5	ND<0.5	11	--	--	--	--
	6/11/96	79	ND<0.5	ND<0.5	ND<0.5	ND<0.5	16	--	--	--	--
	10/2/96	ND<50	ND<0.5	ND<0.5	ND<0.5	ND<0.5	26	--	--	--	--
	1/28/97	ND<50	ND<0.5	ND<0.5	ND<0.5	ND<0.5	13	--	--	--	--
	5/20/97	78	ND<0.5	0.85	ND<0.5	ND<0.5	40	--	--	--	--
	8/18/97	ND<50	ND<0.5	ND<0.5	ND<0.5	ND<0.5	18	--	--	--	--
	11/5/97	ND<50	ND<0.5	ND<0.5	ND<0.5	ND<0.5	8.0	--	--	--	--
	3/31/98	ND<50	ND<0.5	ND<0.5	ND<0.5	ND<0.5	1.3	6.0	--	--	--
	5/28/98	ND<50	ND<0.5	ND<0.5	ND<0.5	ND<0.5	10	--	--	--	--
	8/19/98	ND<50	ND<0.5	ND<0.5	ND<0.5	ND<0.5	27	--	--	--	--
11/17/98	ND<50	ND<0.5	ND<0.5	ND<0.5	ND<0.5	30	--	--	--	--	
2/18/99	51	ND<0.5	ND<0.5	ND<0.5	ND<0.5	22	--	--	--	--	
11/9/99	ND<50	ND<0.5	ND<0.5	ND<0.5	ND<0.5	16	--	--	--	--	
3/22/00	ND<50	ND<0.5	ND<0.5	ND<0.5	ND<0.5	18	--	--	--	--	
11/15/00	ND<50	ND<0.5	ND<0.5	ND<0.5	ND<0.5	17	--	--	--	--	
11/7/01	ND<50	ND<0.5	ND<0.5	ND<0.5	ND<0.5	5.4	--	--	--	--	

TABLE D-1

HISTORICAL GROUNDWATER MONITORING ANALYTICAL RESULTS
TESORO - SAN LORENZO, 67107

Monitoring Well	Sample Date ^(a)	TPHg ^(b) (µg/l)	Benzene ^(b) (µg/l)	Toluene ^(b) (µg/l)	Ethylbenzene ^(b) (µg/l)	Total Xylenes ^(b) (µg/l)	MTBE ^(b) (µg/l)	DIPE ^(b) (µg/l)	ETBE ^(b) (µg/l)	TAME ^(b) (µg/l)	TBA ^(b) (µg/l)
ESLs ^(c)		100	1.0	40	30	20	5.0	NE ^(d)	NE	NE	12
MW-7 (cont.)	11/14/02	ND<50	ND<0.5	ND<0.5	ND<0.5	ND<0.5	0.64	ND<0.5	ND<0.5	ND<0.5	ND<5
	10/28/03	ND<50	ND<0.5	ND<0.5	ND<0.5	ND<0.5	ND<0.5	ND<0.5	ND<0.5	ND<0.5	ND<5
	11/13/04	ND<50	ND<0.5	ND<0.5	ND<0.5	ND<0.5	ND<0.5	ND<0.5	ND<0.5	ND<0.5	ND<5
	1/30/06	ND<50	ND<0.5	ND<0.5	ND<0.5	ND<0.5	ND<0.5	ND<0.5	ND<0.5	ND<0.5	ND<5
	2/2/07	ND<50	ND<0.5	ND<0.5	ND<0.5	ND<0.5	ND<0.5	ND<0.5	ND<0.5	ND<0.5	ND<5
	4/30/07	ND<50	ND<0.5	ND<0.5	ND<0.5	ND<0.5	ND<0.5	ND<0.5	ND<0.5	ND<0.5	ND<5
	10/30/07	ND<50	ND<0.5	ND<0.5	ND<0.5	ND<0.5	ND<0.5	ND<0.5	ND<0.5	ND<0.5	ND<5
	5/13/08	ND<50	ND<0.5	ND<0.5	ND<0.5	ND<0.5	ND<0.5	ND<0.5	ND<0.5	ND<0.5	ND<5
	7/16/08	ND<50	ND<0.5	ND<0.5	ND<0.5	ND<0.5	ND<0.5	ND<0.5	ND<0.5	ND<0.5	ND<5
	10/8/08	ND<50	ND<0.5	ND<0.5	ND<0.5	ND<0.5	ND<0.5	ND<0.5	ND<0.5	ND<0.5	ND<5
	1/29/09	ND<50	ND<0.5	ND<0.5	ND<0.5	ND<0.5	ND<0.5	ND<0.5	ND<0.5	ND<0.5	ND<5
	4/14/09	ND<50	ND<0.5	ND<0.5	ND<0.5	ND<0.5	ND<0.5	ND<0.5	ND<0.5	ND<0.5	ND<5
	10/7/09	ND<50	ND<0.5	ND<0.5	ND<0.5	ND<0.5	ND<0.5	ND<0.5	ND<0.5	ND<0.5	ND<5
	4/13/10	ND<50	ND<0.5	ND<0.5	ND<0.5	ND<0.5	ND<0.5	ND<0.5	ND<0.5	ND<0.5	ND<5
	10/27/10	ND<50	ND<0.5	ND<0.5	ND<0.5	ND<0.5	ND<0.5	ND<0.5	ND<0.5	ND<0.5	ND<5
	4/5/11	ND<50	ND<0.5	ND<0.5	ND<0.5	ND<0.5	ND<0.5	ND<0.5	ND<0.5	ND<0.5	ND<5
6/13/12	ND<50	ND<0.5	ND<0.5	ND<0.5	ND<0.5	ND<0.5	ND<0.5	ND<0.5	ND<0.5	ND<5	
MW-8	2/18/92	1,200	ND<0.5	ND<0.5	9.5	ND<0.5	--	--	--	--	--
	5/14/92	130	ND<0.5	ND<0.5	ND<0.5	ND<0.5	--	--	--	--	--
	8/27/92	140	ND<0.5	ND<0.5	ND<0.5	ND<0.5	--	--	--	--	--
	11/19/92	320	ND<0.5	ND<0.5	2.0	ND<0.5	--	--	--	--	--
	2/3/93	ND<50	ND<0.5	ND<0.5	ND<0.5	ND<0.5	--	--	--	--	--
	6/23/93	ND<50	ND<0.5	ND<0.5	ND<0.5	ND<0.5	--	--	--	--	--
	9/22/93	ND<50	ND<0.5	ND<0.5	0.67	ND<0.5	--	--	--	--	--
	1/24/94	290	ND<0.5	ND<0.5	ND<0.5	ND<0.5	--	--	--	--	--
	4/7/94	ND<50	ND<0.5	ND<0.5	ND<0.5	ND<0.5	--	--	--	--	--
	6/7/94	ND<50	ND<0.5	ND<0.5	ND<0.5	ND<0.5	--	--	--	--	--
	9/28/94	ND<50	ND<0.5	ND<0.5	ND<0.5	ND<0.5	--	--	--	--	--
	12/14/94	ND<50	ND<0.5	ND<0.5	ND<0.5	ND<0.5	--	--	--	--	--
	3/15/95	ND<50	ND<0.5	ND<0.5	ND<0.5	ND<0.5	--	--	--	--	--
	6/13/95	ND<50	ND<0.5	ND<0.5	ND<0.5	ND<0.5	--	--	--	--	--
	12/28/95	ND<50	ND<0.5	ND<0.5	ND<0.5	ND<0.5	ND<5	--	--	--	--
	3/12/96	ND<50	ND<0.5	ND<0.5	ND<0.5	ND<0.5	ND<5	--	--	--	--
	6/11/96	ND<50	ND<0.5	ND<0.5	ND<0.5	ND<0.5	ND<5	--	--	--	--
	10/2/96	ND<50	ND<0.5	ND<0.5	ND<0.5	ND<0.5	ND<5	--	--	--	--
1/28/97	ND<50	ND<0.5	ND<0.5	ND<0.5	ND<0.5	ND<5	--	--	--	--	
5/20/97	ND<50	ND<0.5	ND<0.5	ND<0.5	ND<0.5	ND<5	--	--	--	--	

TABLE D-1

HISTORICAL GROUNDWATER MONITORING ANALYTICAL RESULTS
TESORO - SAN LORENZO, 67107

Monitoring Well	Sample Date ^(a)	TPH ^(b) (µg/l)	Benzene ^(b) (µg/l)	Toluene ^(b) (µg/l)	Ethylbenzene ^(b) (µg/l)	Total Xylenes ^(b) (µg/l)	MTBE ^(b) (µg/l)	DIPE ^(b) (µg/l)	ETBE ^(b) (µg/l)	TAME ^(b) (µg/l)	TBA ^(b) (µg/l)
ESLs ^(c)		100	1.0	40	30	20	5.0	NE ^(d)	NE	NE	12
MW-8 (cont.)	8/18/97	ND<50	ND<0.5	ND<0.5	ND<0.5	ND<0.5	ND<5	--	--	--	--
	11/5/97	ND<50	ND<0.5	ND<0.5	ND<0.5	ND<0.5	ND<0.5	--	--	--	--
	3/31/98	ND<50	ND<0.5	ND<0.5	ND<0.5	ND<0.5	ND<5	--	--	--	--
	5/28/98	ND<50	ND<0.5	ND<0.5	ND<0.5	ND<0.5	ND<5	--	--	--	--
	8/19/98	ND<50	ND<0.5	ND<0.5	ND<0.5	ND<0.5	ND<5	--	--	--	--
	11/17/98	ND<50	ND<0.5	ND<0.5	ND<0.5	ND<0.5	ND<5	--	--	--	--
	2/18/99	ND<50	ND<0.5	ND<0.5	ND<0.5	ND<0.5	ND<5	--	--	--	--
	3/22/00	ND<50	ND<0.5	ND<0.5	ND<0.5	ND<0.5	ND<5	--	--	--	--
	4/30/07	ND<50	ND<0.5	ND<0.5	ND<0.5	ND<0.5	ND<0.5	ND<0.5	ND<0.5	ND<0.5	ND<5
	7/18/07	ND<50	ND<0.5	ND<0.5	ND<0.5	ND<0.5	ND<0.5	ND<0.5	ND<0.5	ND<0.5	ND<5
	5/13/08	ND<50	ND<0.5	ND<0.5	ND<0.5	ND<0.5	ND<0.5	ND<0.5	ND<0.5	ND<0.5	ND<5
	7/16/08	ND<50	ND<0.5	ND<0.5	ND<0.5	ND<0.5	ND<0.5	ND<0.5	ND<0.5	ND<0.5	ND<5
	10/8/08	ND<50	ND<0.5	ND<0.5	ND<0.5	ND<0.5	ND<0.5	ND<0.5	ND<0.5	ND<0.5	ND<5
	1/29/09	ND<50	ND<0.5	ND<0.5	ND<0.5	ND<0.5	ND<0.5	ND<0.5	ND<0.5	ND<0.5	ND<5
	4/14/09	ND<50	ND<0.5	ND<0.5	ND<0.5	ND<0.5	ND<0.5	ND<0.5	ND<0.5	ND<0.5	ND<5
	10/7/09	ND<50	ND<0.5	ND<0.5	ND<0.5	ND<0.5	ND<0.5	ND<0.5	ND<0.5	ND<0.5	ND<5
4/13/10	ND<50	ND<0.5	ND<0.5	ND<0.5	ND<0.5	ND<0.5	ND<0.5	ND<0.5	ND<0.5	ND<5	
10/27/10	ND<50	ND<0.5	ND<0.5	ND<0.5	ND<0.5	ND<0.5	ND<0.5	ND<0.5	ND<0.5	ND<5	
MW-9	2/18/92	ND<50	ND<0.5	ND<0.5	ND<0.5	ND<0.5	--	--	--	--	--
	5/14/92	ND<50	ND<0.5	ND<0.5	ND<0.5	ND<0.5	--	--	--	--	--
	8/27/92	ND<50	ND<0.5	ND<0.5	ND<0.5	ND<0.5	--	--	--	--	--
	11/19/92	ND<50	ND<0.5	ND<0.5	ND<0.5	1.3	--	--	--	--	--
	2/3/93	ND<50	ND<0.5	ND<0.5	ND<0.5	ND<0.5	--	--	--	--	--
	6/23/93	ND<50	ND<0.5	ND<0.5	ND<0.5	ND<0.5	--	--	--	--	--
	9/22/93	ND<50	ND<0.5	ND<0.5	ND<0.5	ND<0.5	--	--	--	--	--
	1/24/94	ND<50	ND<0.5	ND<0.5	ND<0.5	ND<0.5	--	--	--	--	--
	4/7/94	ND<50	ND<0.5	ND<0.5	ND<0.5	ND<0.5	--	--	--	--	--
	6/7/94	ND<50	ND<0.5	ND<0.5	ND<0.5	ND<0.5	--	--	--	--	--
	9/28/94	ND<50	ND<0.5	ND<0.5	ND<0.5	ND<0.5	--	--	--	--	--
	12/14/94	ND<50	ND<0.5	ND<0.5	ND<0.5	ND<0.5	--	--	--	--	--
	3/15/95	ND<50	ND<0.5	ND<0.5	ND<0.5	ND<0.5	--	--	--	--	--
	6/13/95	ND<50	ND<0.5	ND<0.5	ND<0.5	ND<0.5	--	--	--	--	--
	9/28/95	ND<50	ND<0.5	ND<0.5	ND<0.5	ND<0.5	--	--	--	--	--
	12/28/95	ND<50	ND<0.5	ND<0.5	ND<0.5	ND<0.5	ND<5	--	--	--	--
6/11/96	ND<50	ND<0.5	ND<0.5	ND<0.5	ND<0.5	ND<5	--	--	--	--	
10/2/96	ND<50	ND<0.5	ND<0.5	ND<0.5	ND<0.5	ND<5	--	--	--	--	
1/28/97	ND<50	ND<0.5	ND<0.5	ND<0.5	ND<0.5	ND<5	--	--	--	--	

TABLE D-1

HISTORICAL GROUNDWATER MONITORING ANALYTICAL RESULTS
TESORO - SAN LORENZO, 67107

Monitoring Well	Sample Date ^(a)	TPH _g ^(b) (µg/l)	Benzene ^(b) (µg/l)	Toluene ^(b) (µg/l)	Ethylbenzene ^(b) (µg/l)	Total Xylenes ^(b) (µg/l)	MTBE ^(b) (µg/l)	DIPE ^(b) (µg/l)	ETBE ^(b) (µg/l)	TAME ^(b) (µg/l)	TBA ^(b) (µg/l)
ESLs ^(c)		100	1.0	40	30	20	5.0	NE ^(d)	NE	NE	12
MW-9 (cont.)	5/20/97	ND<50	ND<0.5	ND<0.5	ND<0.5	ND<0.5	ND<5	--	--	--	--
	11/5/97	ND<50	ND<0.5	ND<0.5	ND<0.5	ND<0.5	ND<0.5	--	--	--	--
	8/19/98	ND<50	ND<0.5	ND<0.5	ND<0.5	ND<0.5	ND<5	--	--	--	--
	11/17/98	ND<50	ND<0.5	ND<0.5	ND<0.5	ND<0.5	ND<5	--	--	--	--
	2/18/99	ND<50	ND<0.5	ND<0.5	ND<0.5	ND<0.5	ND<5	--	--	--	--
	3/22/00	ND<50	ND<0.5	ND<0.5	ND<0.5	ND<0.5	ND<5	--	--	--	--
	6/3/02	ND<50	ND<0.5	ND<0.5	ND<0.5	ND<0.5	ND<0.5	--	--	--	--
	8/6/02	ND<50	ND<0.5	ND<0.5	ND<0.5	ND<0.5	ND<0.5	ND<0.5	ND<0.5	ND<0.5	ND<5
	4/30/07	ND<50	ND<0.5	ND<0.5	ND<0.5	ND<0.5	ND<0.5	ND<0.5	ND<0.5	ND<0.5	ND<5
	7/18/07	ND<50	ND<0.5	ND<0.5	ND<0.5	ND<0.5	ND<0.5	ND<0.5	ND<0.5	ND<0.5	ND<5
	5/13/08	ND<50	ND<0.5	ND<0.5	ND<0.5	ND<0.5	ND<0.5	ND<0.5	ND<0.5	ND<0.5	ND<5
	7/16/08	ND<50	ND<0.5	ND<0.5	ND<0.5	ND<0.5	ND<0.5	ND<0.5	ND<0.5	ND<0.5	ND<5
	10/8/08	ND<50	ND<0.5	ND<0.5	ND<0.5	ND<0.5	ND<0.5	ND<0.5	ND<0.5	ND<0.5	ND<5
	1/29/09	ND<50	ND<0.5	ND<0.5	ND<0.5	ND<0.5	ND<0.5	ND<0.5	ND<0.5	ND<0.5	ND<5
	4/14/09	ND<50	ND<0.5	ND<0.5	ND<0.5	ND<0.5	ND<0.5	ND<0.5	ND<0.5	ND<0.5	ND<5
	7/1/09	ND<50	ND<0.5	ND<0.5	ND<0.5	ND<0.5	ND<0.5	ND<0.5	ND<0.5	ND<0.5	ND<5
	10/7/09	ND<50	ND<0.5	ND<0.5	ND<0.5	ND<0.5	ND<0.5	ND<0.5	ND<0.5	ND<0.5	ND<5
2/18/10	ND<50	ND<0.5	ND<0.5	ND<0.5	ND<0.5	ND<0.5	ND<0.5	ND<0.5	ND<0.5	ND<5	
4/14/10	ND<50	ND<0.5	ND<0.5	ND<0.5	ND<0.5	ND<0.5	ND<0.5	ND<0.5	ND<0.5	ND<5	
10/27/10	ND<50	ND<0.5	ND<0.5	ND<0.5	ND<0.5	ND<0.5	ND<0.5	ND<0.5	ND<0.5	ND<5	
1/25/11	ND<50	ND<0.5	ND<0.5	ND<0.5	ND<0.5	ND<0.5	ND<0.5	ND<0.5	ND<0.5	ND<5	
MW-10	2/18/92	18,000	110	57	440	53	--	--	--	--	--
	5/15/92	8,500	24	9.8	97	ND<0.5	--	--	--	--	--
	8/29/92	9,600	20	2.8	40	3.5	--	--	--	--	--
	11/19/92	5,700	36	21	330	31	--	--	--	--	--
	2/3/93	2,200	15	4.6	36	9.6	--	--	--	--	--
	6/23/93	8,100	21	24	540	45	--	--	--	--	--
	9/22/93	6,200	22	17	350	16	--	--	--	--	--
	4/7/94	4,000	6.4	2.9	150	4.7	--	--	--	--	--
	6/7/94	6,700	5.6	ND<2.5	150	5.7	--	--	--	--	--
	9/28/94	5,700	2.2	2.6	110	44	--	--	--	--	--
	12/14/94	3,500	ND<1.3	ND<1.3	77	27	--	--	--	--	--
	3/15/95	7,200	ND<5	6.7	150	23	--	--	--	--	--
	6/13/95	8,400	9.0	48	610	130	--	--	--	--	--
	9/28/95	6,300	22	17	360	24	--	--	--	--	--
12/28/95	5,000	4.4	5.6	340	11	37	--	--	--	--	
3/12/96	4,500	1.4	5.9	41	73	120	--	--	--	--	

TABLE D-1

HISTORICAL GROUNDWATER MONITORING ANALYTICAL RESULTS
TESORO - SAN LORENZO, 67107

Monitoring Well	Sample Date ^(a)	TPHg ^(b) (µg/l)	Benzene ^(b) (µg/l)	Toluene ^(b) (µg/l)	Ethylbenzene ^(b) (µg/l)	Total Xylenes ^(b) (µg/l)	MTBE ^(b) (µg/l)	DIPE ^(b) (µg/l)	ETBE ^(b) (µg/l)	TAME ^(b) (µg/l)	TBA ^(b) (µg/l)
ESLs ^(c)		100	1.0	40	30	20	5.0	NE ^(d)	NE	NE	12
MW-10 (cont.)	6/11/96	7,500	ND<5	25	350	81	ND<25	--	--	--	--
	10/2/96	2,600	18	ND<2.5	ND<2.5	ND<2.5	ND<25	--	--	--	--
	1/28/97	2,800	5.9	ND<2.5	29	19	ND<25	--	--	--	--
	5/20/97	6,000	ND<20	34	290	74	ND<100	--	--	--	--
	8/18/97	5,900	ND<20	7.7	94	15	ND<50	--	--	--	--
	11/5/97	5,400	1.1	0.86	47	1.6	2.3	--	--	--	--
	3/31/98	20,000	56	180	1,400	3,700	250	--	--	--	--
	5/28/98	16,000	76	200	1,600	3,900	190	--	--	--	--
	8/19/98	14,000	95	160	1,300	1,700	ND<100	--	--	--	--
	11/17/98	7,500	82	64	590	150	290	--	--	--	--
	2/18/99	4,700	41	16	270	79	ND<100	--	--	--	--
	6/24/99	9,400	27	74	280	160	300	--	--	--	--
	8/30/99	8,500	15	33	160	33	290	--	--	--	--
	11/9/99	7,600	3.9	11	60	14	120	--	--	--	--
	3/22/00	5,800	3.5	33	360	320	160	--	--	--	--
	6/12/00	7,200	4.3	47	370	210	270	--	--	--	--
	11/15/00	4,400	0.54	2.2	3.8	7.3	420	--	--	--	--
	2/26/01	5,000	ND<1	2.5	24	13	860	--	--	--	--
	5/21/01	3,500	ND<0.5	3.2	4.1	12	530	--	--	--	--
	9/5/01	3,400	ND<2	ND<2	ND<2	4.1	770	--	--	--	--
	11/7/01	3,600	ND<0.5	0.64	0.75	2.7	790	--	--	--	--
	2/11/02	4,100	ND<2	2.2	61	26	750	--	--	--	--
	6/3/02	4,100	ND<1	7.0	67	37	320	--	--	--	--
	8/6/02	4,500	ND<1	5.4	18	18	310	--	--	--	--
	11/14/02	5,200	ND<1	ND<1	2.2	6.4	280	ND<0.5	ND<0.5	ND<0.5	13
	2/20/03	6,300	ND<1.5	9.5	280	69	220	ND<2	ND<2	ND<2	--
	5/15/03	5,700	1.2	14	280	78	130	ND<1	ND<1	ND<1	11
7/31/03	4,700	ND<0.5	4.5	20	17	110	ND<1.5	ND<1.5	ND<1.5	7.5	
10/28/03	1,900	ND<0.5	0.54	0.80	2.9	88	ND<1.5	ND<1.5	ND<1.5	5.9	
2/28/04	3,500	ND<1	ND<1	17	7.9	44	ND<1	ND<1	ND<1	ND<10	
4/16/04	6,000	ND<1.5	3.0	150	34	53	ND<0.5	ND<0.5	ND<0.5	ND<5	
7/16/04	6,300	ND<1	3.5	110	29	40	ND<0.5	ND<0.5	ND<0.5	ND<5	
11/13/04	4,900	ND<0.5	4.8	42	23	25	ND<0.5	ND<0.5	ND<0.5	ND<5	
2/4/05	5,000	ND<0.5	3.3	46	30	21	ND<0.5	ND<0.5	ND<0.5	ND<5	
4/13/05	4,000	0.81	6.5	200	120	29	ND<0.5	ND<0.5	ND<0.5	ND<5	
8/10/05	6,600	2.0	6.5	74	72	29	ND<0.5	ND<0.5	ND<0.5	ND<5	
11/5/05	6,000	3.0	9.7	17	56	5.5	ND<0.5	ND<0.5	ND<0.5	ND<5	

TABLE D-1

HISTORICAL GROUNDWATER MONITORING ANALYTICAL RESULTS
TESORO - SAN LORENZO, 67107

Monitoring Well	Sample Date ^(a)	TPHg ^(b) (µg/l)	Benzene ^(b) (µg/l)	Toluene ^(b) (µg/l)	Ethylbenzene ^(b) (µg/l)	Total Xylenes ^(b) (µg/l)	MTBE ^(b) (µg/l)	DIPE ^(b) (µg/l)	ETBE ^(b) (µg/l)	TAME ^(b) (µg/l)	TBA ^(b) (µg/l)
ESLs ^(c)		100	1.0	40	30	20	5.0	NE ^(d)	NE	NE	12
MW-10 (cont.)	1/30/06	3,800	1.8	3.9	61	29	16	ND<0.5	ND<0.5	ND<0.5	ND<5
	4/28/06	5,800	3.1	7.0	210	120	38	ND<0.5	ND<0.5	ND<0.5	8.4
	8/15/06	5,400	1.7	4.2	22	40	42	ND<0.5	ND<0.5	ND<0.5	7.3
	10/26/06	5,000	0.71	2.2	4.8	25	24	ND<0.5	ND<0.5	ND<0.5	5.0
	2/2/07	4,900	0.72	2.3	7.4	15	21	ND<0.5	ND<0.5	ND<0.5	ND<5
	4/30/07	4,300	ND<0.5	2.2	7.6	16	13	ND<0.5	ND<0.5	ND<0.5	ND<5
	7/18/07	2,700	ND<0.5	0.97	ND<0.5	3.4	4.8	ND<0.5	ND<0.5	ND<0.5	ND<5
	10/30/07	3,400	ND<0.5	0.73	ND<0.5	2.1	1.9	ND<0.5	ND<0.5	ND<0.5	ND<5
	1/28/08	2,600	ND<0.5	0.88	ND<0.5	1.5	0.76	ND<0.5	ND<0.5	ND<0.5	ND<5
	5/13/08	4,100	ND<0.5	0.66	ND<0.5	3.0	1.1	ND<0.5	ND<0.5	ND<0.5	ND<5
DUP	7/16/08	2,700	ND<0.5	ND<0.5	ND<0.5	1.4	0.80	ND<0.5	ND<0.5	ND<0.5	ND<5
	10/8/08	1,900	ND<0.5	ND<0.5	ND<0.5	0.63	0.63	ND<0.5	ND<0.5	ND<0.5	ND<5
	1/30/09	1,900	ND<0.5	ND<0.5	ND<0.5	ND<0.5	0.88	ND<0.5	ND<0.5	ND<0.5	ND<5
	1/30/09	2,800	ND<0.5	ND<0.5	ND<0.5	ND<0.5	0.72	ND<0.5	ND<0.5	ND<0.5	ND<5
	4/15/09	2,400	ND<0.5	ND<0.5	0.67	1.4	1.7	ND<0.5	ND<0.5	ND<0.5	ND<5
	7/1/09	2,900	ND<0.5	ND<0.5	ND<0.5	1.4	1.4	ND<0.5	ND<0.5	ND<0.5	ND<5
	10/7/09	2,800	ND<0.5	ND<0.5	ND<0.5	0.61	1.3	ND<0.5	ND<0.5	ND<0.5	ND<5
	2/17/10	3,300	ND<0.5	ND<0.5	0.58	0.90	1.0	ND<0.5	ND<0.5	ND<0.5	ND<5
	4/14/10	4,300	ND<0.5	ND<0.5	24	6.9	0.80	ND<0.5	ND<0.5	ND<0.5	ND<5
	7/7/10	3,600	ND<0.5	ND<0.5	2.0	9.1	1.8	ND<0.5	ND<0.5	ND<0.5	ND<5
	10/27/10	2,900	ND<0.5	ND<0.5	ND<0.5	2.0	0.88	ND<0.5	ND<0.5	ND<0.5	ND<5
	1/25/11	3,500	ND<0.5	ND<0.5	1.6	2.1	0.59	ND<0.5	ND<0.5	ND<0.5	ND<5
	4/5/11	4,000	ND<0.5	0.55	34	11	1.7	ND<0.5	ND<0.5	ND<0.5	ND<5
6/13/12	4,000	ND<0.5	ND<0.5	1.3	3.3	0.56	ND<0.5	ND<0.5	ND<0.5	ND<5	
1/2/13	2,200	ND<0.5	ND<0.5	ND<0.5	ND<0.5	ND<0.5	ND<0.5	ND<0.5	ND<0.5	ND<5	
MW-11	2/18/92	2,400	ND<0.5	ND<0.5	ND<0.5	ND<0.5	--	--	--	--	--
	5/14/92	1,600	ND<0.5	1.9	1.3	0.70	--	--	--	--	--
	8/27/92	2,100	15	2.0	0.60	1.2	--	--	--	--	--
	11/19/92	490	ND<0.5	ND<0.5	ND<0.5	ND<0.5	--	--	--	--	--
	2/3/93	500	ND<0.5	ND<0.5	0.55	ND<0.5	--	--	--	--	--
	6/23/93	350	ND<0.5	ND<0.5	ND<0.5	ND<0.5	--	--	--	--	--
	9/22/93	200	ND<0.5	0.65	ND<0.5	0.71	--	--	--	--	--
	1/24/94	450	ND<0.5	ND<0.5	ND<0.5	ND<0.5	--	--	--	--	--
	4/7/94	500	ND<0.5	ND<0.5	ND<0.5	ND<0.5	--	--	--	--	--
	6/7/94	560	ND<0.5	ND<0.5	ND<0.5	0.64	--	--	--	--	--
	9/28/94	600	ND<0.5	ND<0.5	ND<0.5	ND<0.5	--	--	--	--	--
	12/14/94	340	ND<0.5	ND<0.5	ND<0.5	ND<0.5	--	--	--	--	--

TABLE D-1

HISTORICAL GROUNDWATER MONITORING ANALYTICAL RESULTS
TESORO - SAN LORENZO, 67107

Monitoring Well	Sample Date ^(a)	TPH ^(b) (µg/l)	Benzene ^(b) (µg/l)	Toluene ^(b) (µg/l)	Ethylbenzene ^(b) (µg/l)	Total Xylenes ^(b) (µg/l)	MTBE ^(b) (µg/l)	DIPE ^(b) (µg/l)	ETBE ^(b) (µg/l)	TAME ^(b) (µg/l)	TBA ^(b) (µg/l)
ESLs ^(c)		100	1.0	40	30	20	5.0	NE ^(d)	NE	NE	12
MW-11 (cont.)	3/15/95	340	ND<0.5	ND<0.5	ND<0.5	ND<0.5	--	--	--	--	--
	6/13/95	210 ^(g)	ND<0.5	ND<0.5	ND<0.5	ND<0.5	--	--	--	--	--
	9/28/95	93	4.1	0.50	ND<0.5	ND<0.5	--	--	--	--	--
	12/28/95	380 ^(g)	ND<0.5	ND<0.5	ND<0.5	ND<0.5	ND<5	--	--	--	--
	3/12/96	110	ND<0.5	ND<0.5	ND<0.5	ND<0.5	ND<5	--	--	--	--
	6/11/96	400 ^(g)	ND<0.5	ND<0.5	ND<0.5	ND<0.5	ND<5	--	--	--	--
	10/2/96	ND<50	ND<0.5	ND<0.5	ND<0.5	ND<0.5	ND<5	--	--	--	--
	1/28/97	110 ^(g)	ND<0.5	ND<0.5	ND<0.5	ND<0.5	ND<5	--	--	--	--
	5/20/97	330	ND<0.5	ND<0.5	ND<0.5	ND<0.5	ND<5	--	--	--	--
	8/18/97	ND<50	ND<0.5	ND<0.5	ND<0.5	ND<0.5	ND<0.5	--	--	--	--
	3/31/98	460	ND<0.5	2.8	12	16	ND<0.5	--	--	--	--
	5/28/98	1,100	14	24	88	75	24	--	--	--	--
	8/19/98	1200	16	9.6	69	17	6.0	--	--	--	--
	11/17/98	580	15	4.4	14	ND<0.5	21	--	--	--	--
	2/18/99	390	8.0	ND<0.5	1.4	ND<0.5	44	--	--	--	--
	6/24/99	610	4.6	ND<0.5	0.66	ND<0.5	59	--	--	--	--
	11/9/99	250	0.87	ND<0.5	ND<0.5	ND<0.5	66	--	--	--	--
	3/22/00	330	ND<0.5	ND<0.5	ND<0.5	ND<0.5	100	--	--	--	--
	6/12/00	52	ND<0.5	ND<0.5	ND<0.5	ND<0.5	49	--	--	--	--
	11/15/00	ND<50	ND<0.5	ND<0.5	ND<0.5	ND<0.5	1.8	--	--	--	--
	5/21/01	ND<50	ND<0.5	ND<0.5	ND<0.5	ND<0.5	30	--	--	--	--
	11/7/01	360	ND<0.5	ND<0.5	ND<0.5	ND<0.5	330	--	--	--	--
	6/3/02	120	ND<0.5	ND<0.5	ND<0.5	ND<0.5	220	ND<0.5	ND<0.5	ND<0.5	13
	11/14/02	240	ND<1	ND<1	ND<1	ND<1	380	ND<0.5	ND<0.5	ND<0.5	ND<5
	5/15/03	160	ND<0.5	ND<0.5	ND<0.5	ND<0.5	170	ND<0.5	ND<0.5	ND<0.5	ND<5
	10/28/03	ND<50	ND<0.5	ND<0.5	ND<0.5	ND<0.5	35	ND<0.5	ND<0.5	ND<0.5	ND<5
	2/28/04	360	ND<0.5	ND<0.5	ND<0.5	ND<0.5	140	ND<0.5	ND<0.5	ND<0.5	ND<5
	4/16/04	440	ND<0.5	ND<0.5	ND<0.5	ND<0.5	110	ND<0.5	ND<0.5	ND<0.5	ND<5
	7/16/04	ND<50	ND<0.5	ND<0.5	ND<0.5	ND<0.5	10	ND<0.5	ND<0.5	ND<0.5	ND<5
	11/13/04	230	ND<0.5	ND<0.5	ND<0.5	ND<0.5	49	ND<0.5	ND<0.5	ND<0.5	ND<5
2/4/05	ND<50	ND<0.5	ND<0.5	ND<0.5	ND<0.5	7.0	ND<0.5	ND<0.5	ND<0.5	ND<5	
4/13/05	ND<50	ND<0.5	ND<0.5	ND<0.5	ND<0.5	12	ND<0.5	ND<0.5	ND<0.5	ND<5	
11/5/05	310	ND<0.5	0.71	ND<0.5	ND<0.5	1.6	4.8	ND<0.5	ND<0.5	ND<0.5	ND<5
1/30/06	ND<50	ND<0.5	ND<0.5	ND<0.5	ND<0.5	1.0	ND<0.5	ND<0.5	ND<0.5	ND<5	
4/28/06	ND<50	ND<0.5	ND<0.5	ND<0.5	ND<0.5	1.8	ND<0.5	ND<0.5	ND<0.5	ND<5	
8/15/06	65	ND<0.5	ND<0.5	ND<0.5	ND<0.5	9.1	ND<0.5	ND<0.5	ND<0.5	ND<5	
10/26/06	ND<50	ND<0.5	ND<0.5	ND<0.5	ND<0.5	2.3	ND<0.5	ND<0.5	ND<0.5	ND<5	

TABLE D-1

HISTORICAL GROUNDWATER MONITORING ANALYTICAL RESULTS
TESORO - SAN LORENZO, 67107

Monitoring Well	Sample Date ^(a)	TPHg ^(b) (µg/l)	Benzene ^(b) (µg/l)	Toluene ^(b) (µg/l)	Ethylbenzene ^(b) (µg/l)	Total Xylenes ^(b) (µg/l)	MTBE ^(b) (µg/l)	DiPE ^(b) (µg/l)	ETBE ^(b) (µg/l)	TAME ^(b) (µg/l)	TBA ^(b) (µg/l)
ESLs ^(c)		100	1.0	40	30	20	5.0	NE ^(d)	NE	NE	12
MW-11 (cont.)	2/2/07	930	ND<0.5	ND<0.5	ND<0.5	0.72	27	ND<0.5	ND<0.5	ND<0.5	ND<5
	4/30/07	740	ND<0.5	0.58	ND<0.5	0.64	28	ND<0.5	ND<0.5	ND<0.5	ND<5
DUP	7/18/07	490	ND<0.5	ND<0.5	ND<0.5	ND<0.5	19	ND<0.5	ND<0.5	ND<0.5	ND<5
	10/30/07	420	ND<0.5	ND<0.5	ND<0.5	ND<0.5	28	ND<0.5	ND<0.5	ND<0.5	ND<5
	1/28/08	280	ND<0.5	ND<0.5	ND<0.5	ND<0.5	18	ND<0.5	ND<0.5	ND<0.5	ND<5
	5/13/08	480	ND<0.5	ND<0.5	ND<0.5	ND<0.5	9.5	ND<0.5	ND<0.5	ND<0.5	ND<5
	7/16/08	370	ND<0.5	ND<0.5	ND<0.5	ND<0.5	13	ND<0.5	ND<0.5	ND<0.5	ND<5
	10/8/08	320	ND<0.5	ND<0.5	ND<0.5	ND<0.5	13	ND<0.5	ND<0.5	ND<0.5	ND<5
	1/30/09	280	ND<0.5	ND<0.5	ND<0.5	ND<0.5	11	ND<0.5	ND<0.5	ND<0.5	ND<5
	1/30/09	300	ND<0.5	ND<0.5	ND<0.5	ND<0.5	8.1	ND<0.5	ND<0.5	ND<0.5	ND<5
	4/15/09	300	ND<0.5	ND<0.5	ND<0.5	ND<0.5	5.2	ND<0.5	ND<0.5	ND<0.5	ND<5
	7/1/09	240	ND<0.5	ND<0.5	ND<0.5	ND<0.5	2.1	ND<0.5	ND<0.5	ND<0.5	ND<5
	10/7/09	410	ND<0.5	ND<0.5	ND<0.5	ND<0.5	3.0	ND<0.5	ND<0.5	ND<0.5	ND<5
	2/17/10	460	ND<0.5	ND<0.5	ND<0.5	ND<0.5	2.0	ND<0.5	ND<0.5	ND<0.5	ND<5
	4/14/10	260	ND<0.5	ND<0.5	ND<0.5	ND<0.5	0.77	ND<0.5	ND<0.5	ND<0.5	ND<5
	7/7/10	400	ND<0.5	ND<0.5	ND<0.5	0.80	1.9	ND<0.5	ND<0.5	ND<0.5	ND<5
	10/27/10	130	ND<0.5	ND<0.5	ND<0.5	ND<0.5	0.74	ND<0.5	ND<0.5	ND<0.5	ND<5
	1/25/11	240	ND<0.5	ND<0.5	ND<0.5	ND<0.5	0.77	ND<0.5	ND<0.5	ND<0.5	ND<5
	4/5/11	250	ND<0.5	ND<0.5	ND<0.5	ND<0.5	1.2	ND<0.5	ND<0.5	ND<0.5	ND<5
6/13/12	76	ND<0.5	ND<0.5	ND<0.5	ND<0.5	1.1	ND<0.5	ND<0.5	ND<0.5	ND<5	
1/2/13	ND<5	ND<0.5	ND<0.5	ND<0.5	ND<0.5	0.62	ND<0.5	ND<0.5	ND<0.5	ND<5	
MW-12	7/18/07	68 ^(g)	ND<0.5	ND<0.5	ND<0.5	ND<0.5	ND<0.5	ND<0.5	ND<0.5	ND<0.5	ND<5
	10/30/07	70 ^(g)	ND<0.5	ND<0.5	ND<0.5	ND<0.5	ND<0.5	ND<0.5	ND<0.5	ND<0.5	ND<5
	1/28/08	60 ^(g)	ND<0.5	ND<0.5	ND<0.5	0.57	ND<0.5	ND<0.5	ND<0.5	ND<0.5	ND<5
	5/13/08	ND<50	ND<0.5	ND<0.5	ND<0.5	ND<0.5	ND<0.5	ND<0.5	ND<0.5	ND<0.5	ND<5
	7/16/08	ND<50	ND<0.5	ND<0.5	ND<0.5	ND<0.5	ND<0.5	ND<0.5	ND<0.5	ND<0.5	ND<5
	10/8/08	ND<50	ND<0.5	ND<0.5	ND<0.5	ND<0.5	ND<0.5	ND<0.5	ND<0.5	ND<0.5	ND<5
	1/29/09	ND<50	ND<0.5	ND<0.5	ND<0.5	ND<0.5	ND<0.5	ND<0.5	ND<0.5	ND<0.5	ND<5
	4/14/09	ND<50	ND<0.5	ND<0.5	ND<0.5	ND<0.5	ND<0.5	ND<0.5	ND<0.5	ND<0.5	ND<5
	7/1/09	ND<50	ND<0.5	ND<0.5	ND<0.5	ND<0.5	ND<0.5	ND<0.5	ND<0.5	ND<0.5	ND<5
	10/7/09	ND<50	ND<0.5	ND<0.5	ND<0.5	ND<0.5	ND<0.5	ND<0.5	ND<0.5	ND<0.5	ND<5
	2/17/10	ND<50	ND<0.5	ND<0.5	ND<0.5	ND<0.5	ND<0.5	ND<0.5	ND<0.5	ND<0.5	ND<5
	4/13/10	ND<50	ND<0.5	ND<0.5	ND<0.5	ND<0.5	ND<0.5	ND<0.5	ND<0.5	ND<0.5	ND<5
	10/27/10	ND<50	ND<0.5	ND<0.5	ND<0.5	ND<0.5	ND<0.5	ND<0.5	ND<0.5	ND<0.5	ND<5
	1/25/11	ND<50	ND<0.5	ND<0.5	ND<0.5	ND<0.5	ND<0.5	ND<0.5	ND<0.5	ND<0.5	ND<5
4/5/11	53	ND<0.5	ND<0.5	ND<0.5	ND<0.5	ND<0.5	ND<0.5	ND<0.5	ND<0.5	ND<5	
6/13/12	ND<50	ND<0.5	ND<0.5	ND<0.5	ND<0.5	ND<0.5	ND<0.5	ND<0.5	ND<0.5	ND<5	

TABLE D-1

HISTORICAL GROUNDWATER MONITORING ANALYTICAL RESULTS
TESORO - SAN LORENZO, 67107

Monitoring Well	Sample Date ^(a)	TPHg ^(b) (µg/l)	Benzene ^(b) (µg/l)	Toluene ^(b) (µg/l)	Ethylbenzene ^(b) (µg/l)	Total Xylenes ^(b) (µg/l)	MTBE ^(b) (µg/l)	DIPE ^(b) (µg/l)	ETBE ^(b) (µg/l)	TAME ^(b) (µg/l)	TBA ^(b) (µg/l)
ESLs ^(c)		100	1.0	40	30	20	5.0	NE ^(d)	NE	NE	12
RW-1	5/15/92	790	270	62	29	140	--	--	--	--	--
	8/27/92	24,000	1,300	200	68	810	--	--	--	--	--
	2/3/93	620	71	35	22	110	--	--	--	--	--
	6/23/93	220	30	33	9.8	35	--	--	--	--	--
	9/22/93	4,100	800	400	170	910	--	--	--	--	--
	1/24/94	190	33	6.0	6.9	23	--	--	--	--	--
	4/7/94	1,500	110	57	32	260	--	--	--	--	--
	6/7/94	1,700	130	51	45	180	--	--	--	--	--
	9/28/94	350	54	9.2	12	29	--	--	--	--	--
	12/14/94	79	6.8	2.1	1.2	3.4	--	--	--	--	--
	4/10/95	410	54	11	11	69	--	--	--	--	--
	6/13/95	8,200	1,600	780	340	1,400	--	--	--	--	--
	9/28/95	ND<0.5	ND<0.5	ND<0.5	ND<0.5	ND<0.5	--	--	--	--	--
	12/28/95	ND<0.5	ND<0.5	ND<0.5	ND<0.5	ND<0.5	ND<5	--	--	--	--
	3/12/96	86	ND<0.5	ND<0.5	ND<0.5	ND<0.5	110	--	--	--	--
	6/11/96	230	38	11	4.7	50	68	--	--	--	--
	10/2/96	360	68	29	14	75	47	--	--	--	--
	1/28/97	ND<0.5	0.77	ND<0.5	ND<0.5	ND<0.5	9.0	--	--	--	--
	5/20/97	ND<0.5	ND<0.5	ND<0.5	ND<0.5	ND<0.5	32	--	--	--	--
	8/18/97	220	25	ND<0.5	ND<0.5	3.6	170	--	--	--	--
	9/29/97	900	240	2.8	51	55	230	--	--	--	--
	11/5/97	1,300	340	3.2	59	78	220	--	--	--	--
	3/31/98	4,100	450	130	200	940	4,100	--	--	--	--
	5/28/98	14,000	830	210	170	720	14,000	--	--	--	--
	8/19/98	2,100	20	ND<2.5	7.1	15	2,100	--	--	--	--
	11/17/98	830	7.8	ND<2.5	5.6	ND<2.5	730	--	--	--	--
	2/18/99	180	6.7	1.6	3.2	15	100	--	--	--	--
6/24/99	ND<0.5	ND<0.5	ND<0.5	ND<0.5	ND<0.5	42	--	--	--	--	
8/30/99	ND<0.5	ND<0.5	ND<0.5	ND<0.5	ND<0.5	79	--	--	--	--	
11/9/99	ND<0.5	ND<0.5	ND<0.5	ND<0.5	ND<0.5	78	--	--	--	--	
3/22/00	ND<0.5	1.2	ND<0.5	ND<0.5	ND<0.5	17	--	--	--	--	
6/12/00	ND<0.5	ND<0.5	ND<0.5	ND<0.5	1.0	40	--	--	--	--	
11/15/00	ND<0.5	ND<0.5	ND<0.5	ND<0.5	ND<0.5	290	--	--	--	--	
2/26/01	ND<0.5	ND<0.5	ND<0.5	ND<0.5	ND<0.5	360	--	--	--	--	
5/21/01	100	4.1	1.6	1.8	23	170	--	--	--	--	
9/5/01	73	33	ND<0.5	ND<0.5	ND<0.5	310	--	--	--	--	
11/7/01	ND<0.5	ND<0.5	ND<0.5	ND<0.5	ND<0.5	240	--	--	--	--	

TABLE D-1

**HISTORICAL GROUNDWATER MONITORING ANALYTICAL RESULTS
TESORO - SAN LORENZO, 67107**

Monitoring Well	Sample Date ^(a)	TPHg ^(b) (µg/l)	Benzene ^(b) (µg/l)	Toluene ^(b) (µg/l)	Ethylbenzene ^(b) (µg/l)	Total Xylenes ^(b) (µg/l)	MTBE ^(b) (µg/l)	DIPE ^(b) (µg/l)	ETBE ^(b) (µg/l)	TAME ^(b) (µg/l)	TBA ^(b) (µg/l)
ESLs ^(c)		100	1.0	40	30	20	5.0	NE ^(d)	NE	NE	12
RW-1 (cont.)	2/11/02	ND<50	ND<0.5	ND<0.5	ND<0.5	ND<0.5	21	--	--	--	--
	6/3/02	ND<50	ND<0.5	ND<0.5	ND<0.5	ND<0.5	160	ND<0.5	ND<0.5	ND<0.5	7.7
	8/6/02	ND<50	ND<0.5	ND<0.5	ND<0.5	ND<0.5	190	ND<0.5	ND<0.5	ND<0.5	6.0
	11/14/02	ND<50	ND<0.5	ND<0.5	ND<0.5	ND<0.5	170	ND<0.5	ND<0.5	ND<0.5	ND<5
	2/20/03	ND<50	ND<0.5	ND<0.5	ND<0.5	ND<0.5	120	ND<0.5	ND<0.5	ND<0.5	ND<5
	5/15/03	ND<50	ND<0.5	ND<0.5	ND<0.5	ND<0.5	110	ND<0.5	ND<0.5	ND<0.5	ND<5
	7/31/03	ND<50	ND<0.5	ND<0.5	ND<0.5	ND<0.5	99	ND<0.5	ND<0.5	ND<0.5	ND<5
	10/28/03	ND<50	ND<0.5	ND<0.5	ND<0.5	ND<0.5	88	ND<0.5	ND<0.5	ND<0.5	ND<5
	2/28/04	ND<50	1.3	ND<0.5	ND<0.5	ND<0.5	52	ND<0.5	ND<0.5	ND<0.5	ND<5
	4/16/04	ND<50	ND<0.5	ND<0.5	ND<0.5	ND<0.5	57	ND<0.5	ND<0.5	ND<0.5	ND<5
	7/16/04	ND<50	0.72	ND<0.5	ND<0.5	ND<0.5	100	ND<0.5	ND<0.5	ND<0.5	4.2
	11/13/04	ND<50	1.0	ND<0.5	ND<0.5	ND<0.5	71	ND<0.5	ND<0.5	ND<0.5	ND<5
	2/4/05	ND<50	ND<0.5	ND<0.5	ND<0.5	ND<0.5	45	ND<0.5	ND<0.5	ND<0.5	ND<5
	4/13/05	ND<50	1.1	ND<0.5	ND<0.5	ND<0.5	52	ND<0.5	ND<0.5	ND<0.5	12
	8/10/05	ND<50	ND<0.5	ND<0.5	ND<0.5	ND<0.5	29	ND<0.5	ND<0.5	ND<0.5	ND<5
	11/5/05	ND<50	ND<0.5	ND<0.5	ND<0.5	ND<0.5	27	ND<0.5	ND<0.5	ND<0.5	ND<5
	1/30/06	ND<50	0.61	ND<0.5	ND<0.5	ND<0.5	1.3	23	ND<0.5	ND<0.5	ND<5
	4/28/06	ND<50	0.69	ND<0.5	ND<0.5	ND<0.5	1.6	16	ND<0.5	ND<0.5	ND<5
	8/15/06	ND<50	ND<0.5	ND<0.5	ND<0.5	ND<0.5	18	ND<0.5	ND<0.5	ND<0.5	ND<5
	10/26/06	ND<50	ND<0.5	ND<0.5	ND<0.5	ND<0.5	16	ND<0.5	ND<0.5	ND<0.5	ND<5
2/2/07	ND<50	ND<0.5	ND<0.5	ND<0.5	ND<0.5	12	ND<0.5	ND<0.5	ND<0.5	ND<5	
4/30/07	ND<50	ND<0.5	ND<0.5	ND<0.5	ND<0.5	8.5	ND<0.5	ND<0.5	ND<0.5	ND<5	
7/18/07	ND<50	ND<0.5	ND<0.5	ND<0.5	ND<0.5	7.3	ND<0.5	ND<0.5	ND<0.5	ND<5	
10/30/07	ND<50	ND<0.5	ND<0.5	ND<0.5	ND<0.5	6.9	ND<0.5	ND<0.5	ND<0.5	ND<5	
1/28/08	ND<50	ND<0.5	ND<0.5	ND<0.5	ND<0.5	5.3	ND<0.5	ND<0.5	ND<0.5	ND<5	
5/13/08	ND<50	ND<0.5	ND<0.5	ND<0.5	ND<0.5	5.5	ND<0.5	ND<0.5	ND<0.5	6.8	
7/16/08	ND<50	ND<0.5	ND<0.5	ND<0.5	ND<0.5	7.2	ND<0.5	ND<0.5	ND<0.5	ND<5	
10/8/08	ND<50	ND<0.5	ND<0.5	ND<0.5	ND<0.5	6.6	ND<0.5	ND<0.5	ND<0.5	ND<5	
1/29/09	ND<50	ND<0.5	ND<0.5	ND<0.5	ND<0.5	7.2	ND<0.5	ND<0.5	ND<0.5	ND<5	
DUP	1/30/09	ND<50	ND<0.5	ND<0.5	ND<0.5	ND<0.5	8.7	ND<0.5	ND<0.5	ND<0.5	ND<5
	4/14/09	ND<50	ND<0.5	ND<0.5	ND<0.5	ND<0.5	6.3	ND<0.5	ND<0.5	ND<0.5	6.6
	7/1/09	750	ND<0.5	ND<0.5	ND<0.5	0.67	1.7	ND<0.5	ND<0.5	ND<0.5	ND<5
	10/7/09	ND<50	0.68	ND<0.5	ND<0.5	ND<0.5	23	ND<0.5	ND<0.5	ND<0.5	ND<5
	2/17/10	82	3.0	ND<0.5	4.0	1.4	10	ND<0.5	ND<0.5	ND<0.5	ND<5
	4/13/10	ND<50	4.2	ND<0.5	4.8	1.1	9.7	ND<0.5	ND<0.5	ND<0.5	7.5
	7/6/10	ND<50	0.82	ND<0.5	ND<0.5	ND<0.5	8.0	ND<0.5	ND<0.5	ND<0.5	ND<5
	10/28/10	ND<50	ND<0.5	ND<0.5	ND<0.5	ND<0.5	6.4	ND<0.5	ND<0.5	ND<0.5	6.6

TABLE D-1

HISTORICAL GROUNDWATER MONITORING ANALYTICAL RESULTS
TESORO - SAN LORENZO, 67107

Monitoring Well	Sample Date ^(a)	TPHg ^(b) (µg/l)	Benzene ^(b) (µg/l)	Toluene ^(b) (µg/l)	Ethylbenzene ^(b) (µg/l)	Total Xylenes ^(b) (µg/l)	MTBE ^(b) (µg/l)	DIPE ^(b) (µg/l)	ETBE ^(b) (µg/l)	TAME ^(b) (µg/l)	TBA ^(b) (µg/l)
ESLs ^(c)		100	1.0	40	30	20	5.0	NE ^(d)	NE	NE	12
DW-15800 ^(f)	1/14/03	ND<0.5	ND<0.5	ND<0.5	ND<0.5	ND<0.5	0.81	ND<0.5	ND<0.5	ND<0.5	ND<0.5
	3/20/03	ND<0.5	ND<0.5	ND<0.5	ND<0.5	ND<0.5	ND<0.5	ND<0.5	ND<0.5	ND<0.5	ND<0.5
	9/19/06	NS ^(j)	NS	NS	NS	NS	NS	NS	NS	NS	NS
	2/5/07	ND<0.5	ND<0.5	ND<0.5	ND<0.5	ND<0.5	ND<0.5	ND<0.5	ND<0.5	ND<0.5	ND<0.5
	5/29/07	ND<0.5	ND<0.5	ND<0.5	ND<0.5	ND<0.5	ND<0.5	ND<0.5	ND<0.5	ND<0.5	ND<0.5
DW-15808 ^(f)	1/14/03	ND<0.5	ND<0.5	ND<0.5	ND<0.5	ND<0.5	ND<0.5	ND<0.5	ND<0.5	ND<0.5	ND<0.5
	3/20/03	ND<0.5	ND<0.5	ND<0.5	ND<0.5	ND<0.5	ND<0.5	ND<0.5	ND<0.5	ND<0.5	ND<0.5
	9/19/06	ND<0.5	ND<0.5	ND<0.5	ND<0.5	ND<0.5	ND<0.5	ND<0.5	ND<0.5	ND<0.5	ND<0.5
	2/5/07	ND<0.5	ND<0.5	ND<0.5	ND<0.5	ND<0.5	ND<0.5	ND<0.5	ND<0.5	ND<0.5	ND<0.5
	5/29/07	ND<0.5	ND<0.5	ND<0.5	ND<0.5	ND<0.5	ND<0.5	ND<0.5	ND<0.5	ND<0.5	ND<0.5
DW-246 ^(f)	9/19/06	ND<0.5	ND<0.5	ND<0.5	ND<0.5	ND<0.5	ND<0.5	ND<0.5	ND<0.5	ND<0.5	ND<0.5
	2/5/07 ^(k)	ND<0.5	ND<0.5	ND<0.5	ND<0.5	ND<0.5	ND<0.5	ND<0.5	ND<0.5	ND<0.5	7.0
	2/21/07	ND<0.5	ND<0.5	ND<0.5	ND<0.5	ND<0.5	ND<0.5	ND<0.5	ND<0.5	ND<0.5	ND<0.5
	5/29/07	ND<0.5	ND<0.5	ND<0.5	ND<0.5	ND<0.5	ND<0.5	ND<0.5	ND<0.5	ND<0.5	ND<0.5
OS-1 DUP	9/5/08	800	ND<0.5	ND<0.5	ND<0.5	ND<0.5	ND<0.5	ND<0.5	ND<0.5	ND<0.5	ND<0.5
	10/8/08	610	ND<0.5	ND<0.5	ND<0.5	ND<0.5	ND<0.5	ND<0.5	ND<0.5	ND<0.5	ND<0.5
	1/29/09	65	ND<0.5	ND<0.5	ND<0.5	ND<0.5	ND<0.5	ND<0.5	ND<0.5	ND<0.5	ND<0.5
	1/30/09	150	ND<0.5	ND<0.5	ND<0.5	ND<0.5	ND<0.5	ND<0.5	ND<0.5	ND<0.5	ND<0.5
	4/15/09	ND<0.5	ND<0.5	ND<0.5	ND<0.5	ND<0.5	ND<0.5	ND<0.5	ND<0.5	ND<0.5	ND<0.5
	7/1/09	ND<0.5	ND<0.5	ND<0.5	ND<0.5	ND<0.5	ND<0.5	ND<0.5	ND<0.5	ND<0.5	ND<0.5
	10/7/09	60	ND<0.5	ND<0.5	ND<0.5	ND<0.5	ND<0.5	ND<0.5	ND<0.5	ND<0.5	ND<0.5
	2/18/10	ND<0.5	ND<0.5	ND<0.5	ND<0.5	ND<0.5	ND<0.5	ND<0.5	ND<0.5	ND<0.5	ND<0.5
	1/25/11	ND<0.5	ND<0.5	ND<0.5	ND<0.5	ND<0.5	ND<0.5	ND<0.5	ND<0.5	ND<0.5	ND<0.5
OS-2	9/5/08	1,300	ND<0.5	0.56	ND<0.5	ND<0.5	0.99	ND<0.5	ND<0.5	ND<0.5	ND<0.5
	1/29/09	200	ND<0.5	ND<0.5	ND<0.5	ND<0.5	ND<0.5	ND<0.5	ND<0.5	ND<0.5	ND<0.5
	1/30/09	1900	ND<0.5	ND<0.5	ND<0.5	ND<0.5	0.55	ND<0.5	ND<0.5	ND<0.5	ND<0.5
	4/15/09	1200	ND<0.5	ND<0.5	0.72	ND<0.5	1.3	ND<0.5	ND<0.5	ND<0.5	ND<0.5
	7/1/09	1,500	ND<0.5	ND<0.5	0.69	ND<0.5	1.8	ND<0.5	ND<0.5	ND<0.5	ND<0.5
	10/7/09	1,200	ND<0.5	ND<0.5	0.55	ND<0.5	1.4	ND<0.5	ND<0.5	ND<0.5	ND<0.5
	2/18/10	140	ND<0.5	ND<0.5	ND<0.5	ND<0.5	0.82	ND<0.5	ND<0.5	ND<0.5	ND<0.5
	1/25/11	1,200	ND<0.5	ND<0.5	ND<0.5	ND<0.5	1.2	ND<0.5	ND<0.5	ND<0.5	ND<0.5
OS-3 DUP	9/5/08	3,200	160	15	72	470	19	ND<0.5	ND<0.5	ND<0.5	23
	10/8/08	4,100	240	38	240	630	22	ND<0.5	ND<0.5	ND<0.5	20
	1/29/09	670	78	3.5	75	28	11	ND<0.5	ND<0.5	ND<0.5	7.8
	1/30/09	1,400	140	5.3	120	120	11	ND<0.5	ND<0.5	ND<0.5	16
	4/15/09	ND<0.5	ND<0.5	ND<0.5	ND<0.5	ND<0.5	32	ND<0.5	ND<0.5	ND<0.5	ND<0.5
	7/1/09	2,100	220	6.8	190	250	20	ND<0.5	ND<0.5	ND<0.5	18

TABLE D-1

HISTORICAL GROUNDWATER MONITORING ANALYTICAL RESULTS
TESORO - SAN LORENZO, 67107

Monitoring Well	Sample Date ^(a)	TPH _g ^(b) (µg/l)	Benzene ^(b) (µg/l)	Toluene ^(b) (µg/l)	Ethylbenzene ^(b) (µg/l)	Total Xylenes ^(b) (µg/l)	MTBE ^(b) (µg/l)	DIPE ^(b) (µg/l)	ETBE ^(b) (µg/l)	TAME ^(b) (µg/l)	TBA ^(b) (µg/l)
ESLs ^(c)		100	1.0	40	30	20	5.0	NE ^(d)	NE	NE	12
OS-3 (cont.)	10/7/09	2,100	230	6.5	150	230	20	ND<0.5	ND<0.5	ND<0.5	16
	2/18/10	1,600	180	3.7	120	140	23	ND<0.5	ND<0.5	ND<0.5	8.6
	1/25/11	140	13	ND<0.5	3.1	0.64	25	ND<0.5	ND<0.5	ND<0.5	6.7
OS-4	9/5/08	210	ND<0.5	ND<0.5	ND<0.5	3.6	16	ND<0.5	ND<0.5	ND<0.5	ND<5
	10/8/08	170	4.2	ND<0.5	ND<0.5	2.4	12	ND<0.5	ND<0.5	ND<0.5	ND<5
DUP	1/29/09	ND<50	1.4	ND<0.5	ND<0.5	ND<0.5	21	ND<0.5	ND<0.5	ND<0.5	ND<5
	1/30/09	ND<50	ND<0.5	ND<0.5	0.79	ND<0.5	22	ND<0.5	ND<0.5	ND<0.5	ND<5
	4/15/09	88	12	ND<0.5	2.2	0.58	19	ND<0.5	ND<0.5	ND<0.5	28
	7/1/09	ND<50	ND<0.5	ND<0.5	ND<0.5	ND<0.5	34	ND<0.5	ND<0.5	ND<0.5	ND<5
	10/7/09	680	14	ND<0.5	8.6	12	38	ND<0.5	ND<0.5	ND<0.5	12
	2/18/10	ND<50	ND<0.5	ND<0.5	ND<0.5	0.55	25	ND<0.5	ND<0.5	ND<0.5	ND<5
	1/25/11	ND<50	ND<0.5	ND<0.5	ND<0.5	ND<0.5	7.8	ND<0.5	ND<0.5	ND<0.5	ND<5
PT-1	9/5/08	240	ND<0.5	ND<0.5	ND<0.5	ND<0.5	5.9	ND<0.5	ND<0.5	ND<0.5	ND<5
	10/8/08	140	ND<0.5	ND<0.5	ND<0.5	1.0	5.4	ND<0.5	ND<0.5	ND<0.5	ND<5
DUP	1/29/09	ND<50	ND<0.5	ND<0.5	ND<0.5	ND<0.5	7.3	ND<0.5	ND<0.5	ND<0.5	ND<5
	1/30/09	ND<50	ND<0.5	ND<0.5	ND<0.5	ND<0.5	7.6	ND<0.5	ND<0.5	ND<0.5	ND<5
	4/15/09	ND<50	ND<0.5	ND<0.5	ND<0.5	ND<0.5	7.9	ND<0.5	ND<0.5	ND<0.5	ND<5
	7/1/09	ND<50	ND<0.5	ND<0.5	ND<0.5	ND<0.5	13	ND<0.5	ND<0.5	ND<0.5	ND<5
	10/7/09	ND<50	ND<0.5	ND<0.5	ND<0.5	ND<0.5	13	ND<0.5	ND<0.5	ND<0.5	ND<5
	2/18/10	ND<50	ND<0.5	ND<0.5	ND<0.5	ND<0.5	17	ND<0.5	ND<0.5	ND<0.5	ND<5
	4/14/10	ND<50	ND<0.5	ND<0.5	ND<0.5	ND<0.5	13	ND<0.5	ND<0.5	ND<0.5	ND<5
	7/7/10	81	ND<0.5	ND<0.5	ND<0.5	ND<0.5	8.2	ND<0.5	ND<0.5	ND<0.5	ND<5
	10/28/10	ND<50	ND<0.5	ND<0.5	ND<0.5	ND<0.5	9.4	ND<0.5	ND<0.5	ND<0.5	ND<5
	1/25/11	ND<50	ND<0.5	ND<0.5	ND<0.5	ND<0.5	6.3	ND<0.5	ND<0.5	ND<0.5	ND<5
	4/6/11	ND<50	ND<0.5	ND<0.5	ND<0.5	ND<0.5	6.4	ND<0.5	ND<0.5	ND<0.5	ND<5
10/31/11	ND<50	ND<0.5	ND<0.5	ND<0.5	ND<0.5	8.7	ND<0.5	ND<0.5	ND<0.5	ND<5	
6/13/12	ND<50	ND<0.5	ND<0.5	ND<0.5	ND<0.5	5.5	ND<0.5	ND<0.5	ND<0.5	ND<5	
1/2/13	ND<50	ND<0.5	ND<0.5	ND<0.5	ND<0.5	3.6	ND<0.5	ND<0.5	ND<0.5	ND<5	

- (a) Samples collected before January 2008 reported by others; data provided by RDM Environmental, Inc. (RDM), Fourth Quarter 2007 Groundwater Monitoring Report
- (b) Total petroleum hydrocarbons as gasoline (TPH_g), benzene, toluene, ethylbenzene, xylenes, methyl tert-butyl ether (MTBE), di-isopropyl ether (DIPE), ethyl tert-butyl ether (ETBE), tert-amyl methyl ether (TAME), tert-butyl alcohol (TBA), analyzed by EPA Method 8260; reported in micrograms per liter (µg/l).
- (c) Environmental Screening Levels (ESLs) taken from Regional Water Quality Control Board, San Francisco Bay Region, Screening for Environmental Concerns at Sites with Contaminated Soil and Groundwater, Volume 1: Summary Tier 1 Lookup tables dated November 2007.
- (d) NE - Not established.
- (e) "-" - Not analyzed.
- (f) ND - Not detected at the reporting limit listed; reporting limit not listed if not previously reported.
- (g) Not typical gasoline.
- (h) DUP - Duplicate sample
- (i) Domestic water wells (used as irrigation wells); DW-15800 collected from well at 15800 Via Cordoba, DW-15808 collected from well at 15808 Via Cordoba, DW-246 collected from well at 246 Peach Drive in San Lorenzo, CA.
- (j) NS - Not sampled this sampling period.
- (k) Property owner had the RDM technician sample a faucet plumbed to city water. RDM resampled the 246 Peach well on 21 February 2007.

Blows/ Ft.	Sample No.	USCS	DESCRIPTION	WELL CONST.
0			Asphalt (10") over roadfill (2")	
2		CL	Silty clay with lenses of silty sand, brown and black, damp, slight plasticity, very stiff, no product odor.	
4				
6	17	S-5		
8				
10	8	S-10	ML Clayey silt with lenses of sand, silt, and sandy clay, green, damp, slight plasticity, medium stiff, slight product odor, (in silt only)	
12				
14				
16	14	S-15	Clayey silt, moist, stiff, very slight product odor.	
18				
20		ML		
22	15	S-20	Sandy silt with lenses of silty clay and poorly sorted silty sand, brown, wet, moderate product odor.	
24		ML		
26	25	S-25	Silt with trace sand, black, very stiff.	
28				
30		CL	Sandy clay, brown and black, wet, slight plasticity, very stiff, strong product odor.	

(Section continues downward)



41255 Mission Blvd Suite B Fremont, CA 94539 4151651-9006

LOG OF BORING B-1/MW-1 PLATE

Econo Gasoline Station
San Lorenzo, California

P-4

PROJECT NO. 87044-3

ATTACHMENT 6

DEPTH IN FEET	Blows/ Ft.	Sample No.	USCS	DESCRIPTION	WELL CONST.
	30	18	S-30	CL	Sandy clay, brown and black, wet, slight plasticity, very stiff, strong product odor.
32					
34			CL		
36	30	s-35		Clay with trace gravel, black, high plasticity, very slight product odor.	Caved
38				Total Depth = 36.5 feet Boring terminated at sufficient depth for monitoring well.	
40					



Applied GeoSystems
 43255 Alvarado Blvd Suite B Fremont, CA 94539 (415) 651-9906

PROJECT NO. 87044-3

LOG OF BORING B-1/MW-1

Econo Gasoline Station
 San Lorenzo, California

PLATE P-5

DEPTH IN FEET	Blows/ Ft.	Sample No.	USCS	DESCRIPTION	WELL CONST.
0				Asphalt (8") over roadfill (4")	
2			ML	Silt with lenses of clayey silt, brown, slightly damp, slight plasticity, stiff, no product odor.	
4					
6	15	S-5			
8			CL	Silty clay with lenses of silt, black and brown, slightly damp, slight plasticity, stiff, no product odor.	
10	15	S-10			
12			ML	Silt with some clay and lenses of sandy silt, green, very moist, very stiff, no product odor.	
14	23	S-15			
16					
18			ML		
20	9	S-20	▼ ≡	Clayey silt, brown, slight plasticity, stiff.	
22					
24	34	S-25		Brown and black, hard.	
26					
28			ML		
30	44	S-30		Silt with some clay, brown, very moist, slight plasticity, hard, no product odor.	

(Section continues downward)



Applied GeoSystems
43255 Mission Blvd. Suite B Fremont, CA 94539 (415) 651-7906

LOG OF BORING B-2/MW-2 PLATE

Econo Gasoline Station
San Lorenzo, California

P-6

PROJECT NO. 87044-3

DEPTH IN FEET	Blows/ Ft.	Sample No.	USCS	DESCRIPTION	WELL CONST.
	30			ML	Silt with some clay, brown, very moist, slight plasticity, hard, no product odor.
32			CL	Clay with trace silt, brown, damp, medium plasticity, very stiff, no product odor.	
34					
36	17	S-35			Caved
38				Total Depth = 37 feet Boring terminated at sufficient depth for monitoring well.	
40					



Applied GeoSystems
82155 Alvarado Blvd. Suite B Torrance, CA 90509-1419 651-1906

LOG OF BORING B-2/MW-2 PLATE

Econo Gasoline Station
San Lorenzo, California

P-7

PROJECT NO. 87044-3

Blows/ Ft.	Sample No.	USCS	DESCRIPTION	WELL CONST.
0			Asphalt (6") over concrete (3")	
2		ML	Silt, brown, slightly damp, slight plasticity, stiff, very slight product odor.	
4				
6	15	S-5		
8				
10	12	S-10	Silt with trace clay and lenses of silt, green and brown, damp.	
12				
14	9	S-15	Clayey silt, moist, medium plasticity, moderate product odor.	
16				
18				
20	14	S-20	With trace sand, green, very moist, strong product odor.	
22		ML		
24	34	S-25	Silt with some clay, slight plasticity, hard.	
26				
28		CL	Clay with trace silt and gravel, green, moist, very stiff, slight product odor.	
30	20	S-30		

(Section continues downward)



Applied GeoSystems
43255 Mission Blvd. Suite B Fremont, CA 94539 4151691-1906

LOG OF BORING B-3/MW-3 PLATE

Econo Gasoline Station
San Lorenzo, California

P-8

PROJECT NO. 87044-3

DEPTH IN FEET	Blows/ Ft.	Sample No.	USCS	DESCRIPTION	WELL CONST.
	30			CL	Clay with trace silt and gravel, green, moist, very stiff, slight product odor.
32					
34			CL		
36	13	S-35		Silty clay, brown, medium plasticity, stiff, very slight product odor.	Caved
38				Total Depth = 37 feet Boring terminated at sufficient depth for monitoring well.	
40					



Applied GeoSystems
43275 Mission Blvd. Suite B Fremont, CA 94539 (415) 651-7906

LOG OF BORING B-3/MW-3 PLATE

Econo Gasoline Station
San Lorenzo, California

P-9

PROJECT NO. 87044-3

BORING LOG B-1

JOB NUMBER: 211-71-11
 JOB NAME: SAN LORENZO
 DRILL RIG: MOBILE B-61

DATE DRILLED: 12-2-88
 SURFACE ELEVATION: _____
 DATUM: _____

SAMPLER TYPE:
2 1/2' SPLIT SPOON || 5 FOOT CONTINUOUS

* Laboratory Analysis: S - Soil Properties, C - Chemical Analysis

DEPTH FEET	BLOWS/ FOOT	LAB * ANALYSIS	USCS SYSTEM	DESCRIPTION
				Asphalt
2			SM	SILTY SAND - Light brown, dry, loose, (Fill). SILTY SAND - Dark brown, moist, medium dense, (Fill).
4				SILTY SAND - Light brown, moist, medium dense, no hydrocarbon odor.
6	12		SM	
8			SP-SM	SAND with silt - Light brown, moist, medium dense, no hydrocarbon odor.
10	8			SILTY SAND - Grayish-black, moist, medium stiff, slight hydrocarbon odor.
12	7	C	SM	
14				As above.
16	10	C		
18	5		ML	SANDY SILT - Mixed brown & tan, moist, medium stiff, moderate hydrocarbon odor.
20	7		SM	SILTY SAND - Grayish-olive, wet, loose, no hydrocarbon odor.
22		C	CH	FAT CLAY - Dark grey, wet, very stiff, slight hydrocarbon odor.
24			SM	SILTY SAND - Mixed gray & tan, wet, dense, no hydrocarbon odor.
26	21			

Du Pont Environmental Services

Logged by: [Signature]

Approved by: [Signature]

BORING LOG B-1

JOB NUMBER: 211-71-11
 JOB NAME: SAN LORENZO
 DRILL RIG: MOBILE B-61

DATE DRILLED: 12-2-88
 SURFACE ELEVATION: _____
 DATUM: _____

SAMPLER TYPE:
2 1/2" SPLIT SPOON || 5 FOOT CONTINUOUS

* Laboratory Analysis: S - Soil Properties, C - Chemical Analysis

DEPTH FEET	BLOWS/FOOT	LAB * ANALYSIS	USCS SYSTEM	DESCRIPTION
	36		SM	SILTY SAND - Mixed gray & tan, wet, no hydrocarbon odor.
30	17			
	7		CL	LEAN CLAY - Tan, wet, medium stiff, no hydrocarbon odor.
			SM	SILTY SAND - Tan, saturated, loose, no hydrocarbon odor.
32				
	23	C	SP-SM	POORLY GRADED SAND with silt - Tan, saturated, very stiff, no hydrocarbon odor.
			SP	POORLY GRADED SAND - Mixed gray & tan, saturated, medium dense, no hydrocarbon odor.
34			SP	SILTY SAND - Tan, saturated, medium dense, no hydrocarbon odor.
			SM	
36	27			
38				Boring terminated at 37 feet. Ground water encountered at approximately 21.5 feet.
40				
42				
44				
46				
48				
50				
52				
54				

Du Pont Environmental Services

Logged by: M. Miller

Approved by: D. Fed

WELL LOG MW-4

JOB NUMBER: 211-71-11
 JOB NAME: SAN LORENZO
 DRILL RIG: MOBILE B-61

DATE DRILLED: 12-1-88
 SURFACE ELEVATION: _____
 DATUM: _____

SAMPLER TYPE:
2 1/2" SPLIT SPOON
5' CONTINUOUS

DRIVE WEIGHT - LB:
140

HEIGHT OF FALL-IN:
30

* Laboratory Analysis: S-Soil Properties C-Chemical Properties

Depth feet	Well Construction	Lab * Analysis	Blows Per Foot	Sample Depth	Sample Type	USCS Symbol	Description
2	Watertight utility box Locking Cap			2			Asphalt
2				2		CL	SILTY CALY - Mottled brown and tan, moist, medium stiff, (Fill).
4	2" SCH 40 PVC Blank			4			SILTY SAND - Light brown, moist, loose, no hydrocarbon odor.
6	Bentonite Cement/ Grout		9	6		SH	
8	Bentonite Seal		6	8			SILTY SAND - Tan, moist, loose, no hydrocarbon odor.
10				10			
12	2" SCH 40 PVC Screen 0.01" slot 3" Borehole	C	7	12		CL-ML	SANDY SILTY CLAY - Light brown, moist, medium stiff, no hydrocarbon odor.
14				14		CL	SILTY CLAY - Light brown, moist, medium stiff, no hydrocarbon odor.
16				16		SM	SILTY SAND - Tan, moist, medium stiff, no hydrocarbon odor.
18			6	18		CL-ML	SANDY SILTY CLAY - Mixed light brown and tan, moist, medium stiff, water lense encountered at 17.5'.
20	# 2/16 Filter Sand			20		SM	SILTY SAND - Tan, wet, medium dense, no hydrocarbon odor.
22		C	18	22		GP	POORLY GRADED GRAVEL with sand - Grayish tan, saturated, medium dense, slight hydrocarbon odor.
24				24			FAT CLAY - Grayish black, moist, medium stiff, no hydrocarbon odor.
26	Threaded End Cap		17	26		CH	
28	Bentonite	C	9	28		CL-ML	SILTY CLAY - Grayish-brown, wet, medium stiff, no hydrocarbon odor.
30				30		CL	SANDY LEAN CLAY - Light tannish-brown, wet, medium stiff, no hydrocarbon odor.
							Boring terminated at 30 feet. Ground water encountered at 22.5'.

Du Pont Environmental Services

Logged by: W. Little
 Approved by: J. King

WELL LOG MW-5

JOB NUMBER: 211-71-11
 JOB NAME: SAN LORENZO
 DRILL RIG: MOBILE B-61

DATE DRILLED: 12-1-88
 SURFACE ELEVATION: _____
 DATUM: _____

SAMPLER TYPE:
2 1/2" SPLIT SPOON
5' CONTINUOUS

DRIVE WEIGHT - LB:
140

HEIGHT OF FALL-IN:
30

* Laboratory Analysis: S-Soil Properties C-Chemical Properties

Depth feet	Well Construction	Lab # Analysis	Blows Per Foot	Sample Depth	Sample Type	USCS Symbol	Description
2	Watertight utility box Locking Cap			2		SM	Asphalt
4	Bentonite Cement/Grout			4		SM	SILTY SAND - Dark brown, moist, medium dense, (Fill). SILTY SAND - Light brown, moist, loose, no hydrocarbon odor.
6	2" SCH 40 PVC Lining		9	6			As above, increasing sand content.
8	Bentonite		12	8			
10	8" Borehole		9	10			As above, increasing fines content.
12		C	6	12			
14				14		GP	POORLY GRADED GRAVEL with sand - Tan, moist, loose, no hydrocarbon odor.
16	2" SCH 40 PVC Screen 0.01" Slot		6	16			CL LEAN CLAY - Light tannish-brown, moist, medium stiff, no hydrocarbon odor. SP-SM POORLY GRADED SAND with silt - Tan, moist, loose, no hydrocarbon odor. CL-NL SILTY CLAY - Light tannish-brown, moist, medium stiff, no hydrocarbon odor.
18			5	18			
20			11	20		SM	SILTY SAND - Tan, saturated, loose, no hydrocarbon odor.
22		C	13	22			FAT CLAY - Dark grey, saturated, stiff, no hydrocarbon odor.
24	#2/16 Filter Sand		9	24		CN	
26			21	26		CL-ML	SILTY CLAY - Tannish-gray, saturated, medium stiff, no hydrocarbon odor.
28		C	19	28		CL	SANDY LEAN CLAY - Mixed tan & light brown, wet, very stiff, no hydrocarbon odor.
30	Threaded End Cap			30			Boring terminated at 30 feet. Groundwater encountered at approximately 21.5 feet.

Du Pont Environmental Services

Logged by: [Signature]
 Approved by: [Signature]

WELL LOG MW-6

JOB NUMBER: 211-71-11
 JOB NAME: SAN LORENZO
 DRILL RIG: MOBILE B-61

DATE DRILLED: 12-1-88
 SURFACE ELEVATION: _____
 DATUM: _____

SAMPLER TYPE:
2 1/2" SPLIT SPOON
5' CONTINUOUS

DRIVE WEIGHT - LB:
140

HEIGHT OF FALL-IN:
30

* Laboratory Analysis: S-Soil Properties C-Chemical Properties

Depth feet	Well Construction	Lab * Analysis	Blows Per Foot	Sample Depth	Sample Type	USCS Symbol	Description
2	Watertight utility box Locking Cap			2		CH	Asphalt FAT CLAY - Black, moist, medium stiff, (Fill).
4	2" SCH 40 PVC Casing			4		SM	SILTY SAND - Grayish-olive, moist, loose, slight organic hydrocarbon odor.
6	Bentonite Cement/Grout		7	6			
8	Bentonite Seal		8	8			
10			11	10			
12	8" Borehole	C	10	12			As above, medium dense, slight organic odor.
14			11	14		CL	LEAN CLAY - Grayish-olive, moist, soft, no hydrocarbon odor.
16	2" SCH 40 PVC Screen 0.01" Slot		6	16			
18				18		SM	SILTY SAND - Grayish-olive, moist, loose, no hydrocarbon odor.
20			14	20		SP-SM	POORLY GRADED SAND with silt - mixed tan and olive, wet, medium dense, no hydrocarbon odor.
22	# 2/16 Filter Sand	C	15	22		CH	FAT CLAY - Grayish-black, wet, stiff, no hydrocarbon odor.
24				24		CL	LEAN CLAY - Mixed grayish-black, tan & light brown, wet, stiff, no hydrocarbon odor.
26			55	26		CL-ML	SILTY CLAY with sand - Mixed tan & light brown, wet, hard, no hydrocarbon odor.
28		C	35	28			
30	Threaded End Cap		43	30		CL	SANDY LEAN CLAY - Tan, wet, hard, no hydrocarbon odor.
							Boring terminated at 30 feet. Ground water encountered at 22 feet.

Du Pont Environmental Services

Logged by: [Signature]
 Approved by: [Signature]

WELL LOG MW-7

JOB NUMBER: 211-71-11
 JOB NAME: SAN LORENZO
 DRILL RIG: MOBILE B-61

DATE DRILLED: 12-2-88
 SURFACE ELEVATION: _____
 DATUM: _____

SAMPLER TYPE:
2 1/2" SPLIT SPOON
5' CONTINUOUS

DRIVE WEIGHT - LB: _____
140

HEIGHT OF FALL-IN: _____
30

* Laboratory Analysis: S-Soil Properties C-Chemical Properties

Depth feet	Well Construction	Lab * Analysis	Blows Per Foot	Sample Depth	Sample Type	USCS Symbol	Description
2	Watertight utility box Locking Cap			2		SM	Asphalt.
4	2" SCH 40 PVC Casing			4		SM	SILTY SAND - Mottled bluish-gray & brown moist, medium dense, (fill).
6	Bentonite Cement/Grout		18	6			SILTY SAND - Light brown, moist, medium dense, no hydrocarbon odor.
8			10	8			As above, grayish-olive, increasing sand content.
10	Bentonite Seal		9	10		ML	SANDY SILT - Grayish-olive, moist, stiff, no hydrocarbon odor.
12	8" Borehole	C	9	12			As above, slight organic odor.
14				14		SP-SM	POORLY GRADED SAND with silt - Bluish-olive, moist, medium stiff.
16	2" SCH 40 PVC Casing 0.01" slot		8	16		CL	LEAN CLAY - Light brown, moist, medium stiff, no hydrocarbon odor. As above, dark brown, moderate hydrocarbon odor @ 18 feet.
18			6	18		SM	SILTY SAND - Dark brown, wet, loose, moderate hydrocarbon odor.
20	#2/16 Filter Sand		23	20			
22		C	15	22		CH	FAT CLAY - Grayish-black, wet, stiff, no hydrocarbon odor.
24				24		CL	SANDY LEAN CLAY - Mixed tan & light brown, wet, stiff, no hydrocarbon odor.
26	Threaded End Cap Bentonite	C	27	26		CH	FAT CLAY - Grayish-black, moist, very stiff, no hydrocarbon odor.
28				28			Boring terminated at 27 feet. Ground water encountered at 21 feet.
30				30			

Du Pont Environmental Services

Logged by: *[Signature]*
 Approved by: *[Signature]*

WELL LOG MW-8

JOB NUMBER: 211-71-11
 JOB NAME: San Lorenzo
 DRILL RIG: B-40

DATE DRILLED: 9/15/89
 SURFACE ELEVATION: _____
 DATUM: _____

SAMPLER TYPE: 2 1/2" SPLIT SPOON DRIVE WEIGHT-LB: 140 HEIGHT OF FALL-IN: 30
1" STANDARD PENETROMETER

* Laboratory Analysis: S-Soil Properties C-Chemical Properties

Depth feet	Well Construction	Lab # Analysis	Blows Per Foot	Sample Depth	Sample Type	USCS Symbol	Description
2	Locking Steel Stovepipe Watertight Locking Cap			2		ML	SILT - Dark brown, moist, slightly sandy, pebbly. No hydrocarbon odor. Fill.
4	Cement-Bentonite Grout			4			
6	2" SCH 40 PVC Blank		15	6		CH	CLAY with silt and minor sand - Medium brown, moist, stiff, high plasticity; sand is fine-grained. No hydrocarbon odor.
8				8			
10	Bentonite		20	10			CLAY - Medium brown, moist, very stiff, high plasticity, silt. No hydrocarbon odor.
12	No. 2/12 Monterey Sand			12			
14	2" SCH PVC 0.02" Slotted Screen			14		ML	SANDY SILT - Medium brown, very moist, medium dense. No hydrocarbon odor.
16		C	12	16		SM	SILTY SAND with clay - Medium brown, orange mottling, moist, medium dense; sand is fine-grained. No hydrocarbon odor.
18			13	18		ML	SANDY SILT with clay - Dark brown to black, moist; sand is fine to coarse-grained, some pebbles. No hydrocarbon odor.
20		C	35	20		SP	POORLY GRADED SAND with silt - Grey, saturated, dense; sand is coarse to medium-grained. Degraded hydrocarbon odor.
22	Threaded Bottom Cap		36	22		CH	FAT CLAY - Medium brown, moist, hard, high plasticity. No hydrocarbon odor.
24	Bentonite		49	24			As above.
26			27	26			
28				28			
30				30			Boring terminated at 25.5 feet. Free ground water encountered at 20.0 feet.

Du Pont Environmental Services

Logged by: [Signature]

Approved by: [Signature]

WELL LOG MW-9

JOB NUMBER: 211-71-11
 JOB NAME: San Lorenzo
 DRILL RIG: B-40

DATE DRILLED: 9/15/89
 SURFACE ELEVATION: _____
 DATUM: _____

SAMPLER TYPE:
2 1/2" SPLIT SPOON
1" STANDARD PENETROMETER

DRIVE WEIGHT-LB: 140
 HEIGHT OF FALL-IN: 30

* Laboratory Analysis: S-Soil Properties C-Chemical Properties

Depth feet	Well Construction	Lab * Analysis	Blows Per Foot	Sample Depth	Sample Type	USCS Symbol	Description
2	Watertight utility box Locking steel cover Locking cap			2		ML	SILT - Medium brown, moist, broken wood, glass, etc. No hydrocarbon odor. Fill.
4	Cement Bentonite Grout			4			
6	2" SCH 40 PVC 0.02" Slotted Screen		10	6		ML	SILT with clay and minor sand - Medium brown, moist, stiff. No hydrocarbon odor.
8	Bentonite			8			
10	No. 2/12 Monterey Sand			10			As above.
12	2" SCH PVC 0.02" Slotted Screen		14	12		SM/ML	SILTY SAND/SANDY SILT - Medium brown, moist, medium dense; sand is fine-grained. No hydrocarbon odor.
14				14			
16		C	21	16		ML	SILT with clay and minor sand - Medium brown, orange mottling, moist, very stiff; sand is fine grained. No hydrocarbon odor.
18			17	18			
20				20			SILT with sand and clay - Medium brown, very moist, very stiff; sand is fine to coarse-grained. No hydrocarbon odor.
22		C	22	22		SC/SM	SILTY CLAYEY SAND with minor gravel - Medium brown, very moist, medium dense; sand is fine to coarse-grained. No hydrocarbon odor.
24	PVC Slip Cap		54	24		GP	POORLY GRADED GRAVEL - Medium brown, saturated, very dense; gravel is medium to coarse-grained. No hydrocarbon odor.
26	Bentonite		26	26		CH	FAT CLAY - Grey to brown, moist, very stiff, high plasticity. No hydrocarbon odor.
28			29	28		CL	As above - Minor sand.
30			31	30			SANDY CLAY - Brown, moist, very stiff, high plasticity. No hydrocarbon odor.
							Boring terminated at 28.0 feet. Free ground water encountered at 22.0'.

Du Pont Environmental Services

Logged by: [Signature]

Approved by: [Signature]

RESNA EXPLORATORY BORING LOG

Project Name: Ultramar/Beacon No. 721
 44 Lewelling Boulevard
 San Lorenzo, California

Boring No. MW-10
 Date Drilled: 10-17-91

Project Number: 3-30092-32

Logged By: K. McVicker

Depth (ft.)	Sample No.	Blows/Foot	Unified Soil Classification	SOIL DESCRIPTION	Water Level	OVM Reading (ppm)
1				Asphalt over baserock		
2			SM	SILTY SAND, brown, medium dense, damp, (some gravel)		
3				-----		
4						
5			ML	SANDY SILT, grey brown, low plasticity, very stiff, damp (some clay)		
6	S-6-B10	21				0
7						
8						
9						
10						
11	S-11-B10	11		CLAYEY SILT, low plasticity, stiff, moist (with lenses of fine sand)		0
12						
13						
14						
15				SANDY SILT, grey brown, low plasticity, very moist (with fine sand and clay)		
16	S-16-B10	17	SM	SAND, light grey brown, medium dense, very moist (fine to medium sand)		0
17						
18				Encountered water at approximately 18 feet	▽	
19						
20				with clay lenses, wet		
21	S-21-B10	38	GW	SANDY GRAVEL, grey with green streaks, dense, wet (some clay)		0

REVIEWED BY R.G./C.E.G.

ok *W*

RESNA EXPLORATORY BORING LOG

Project Name: Ultramar/Beacon No. 721
 44 Lewelling Boulevard
 San Lorenzo, California

Boring No. MW-10

Date Drilled: 10-17-91

Project Number: 3-30092-32

Logged By: K. McVicker

Depth (ft.)	Sample No.	Blows/Foot	Unified Soil Classification	SOIL DESCRIPTION	Water Level	OVN Reading (ppm)
22			GW	Sandy gravel, grey with green streaks, dense, wet (some clay)		
23						
24						
25			CL	SILTY CLAY, dark grey, medium plasticity, very stiff, very moist, (trace fine to medium sand)		
26	S-26-B10	23				0
27						
28						
29						
30	S-29.5-B10	17		green-brown mottling		0
31				Bottom of boring at approximately 30 feet		
32						
33						
34						
35						
36						
37						
38						
39						
40						
41						
42						

REVIEWED BY R.G./C.E.G.

Handwritten signature

MONITORING WELL DETAIL

Project Number	<u>3-30092-32</u>	Boring/Well No.	<u>MW-10</u>
Project Name	<u>Ultramar/Beacon No. 721</u>	Top of Casing Elev.	<u>42.34</u>
County	<u>Alameda</u>	Ground Surface Elev.	<u>43.09</u>
Well Permit No.	<u>91606</u>	Datum	<u>Alameda County Datum</u>

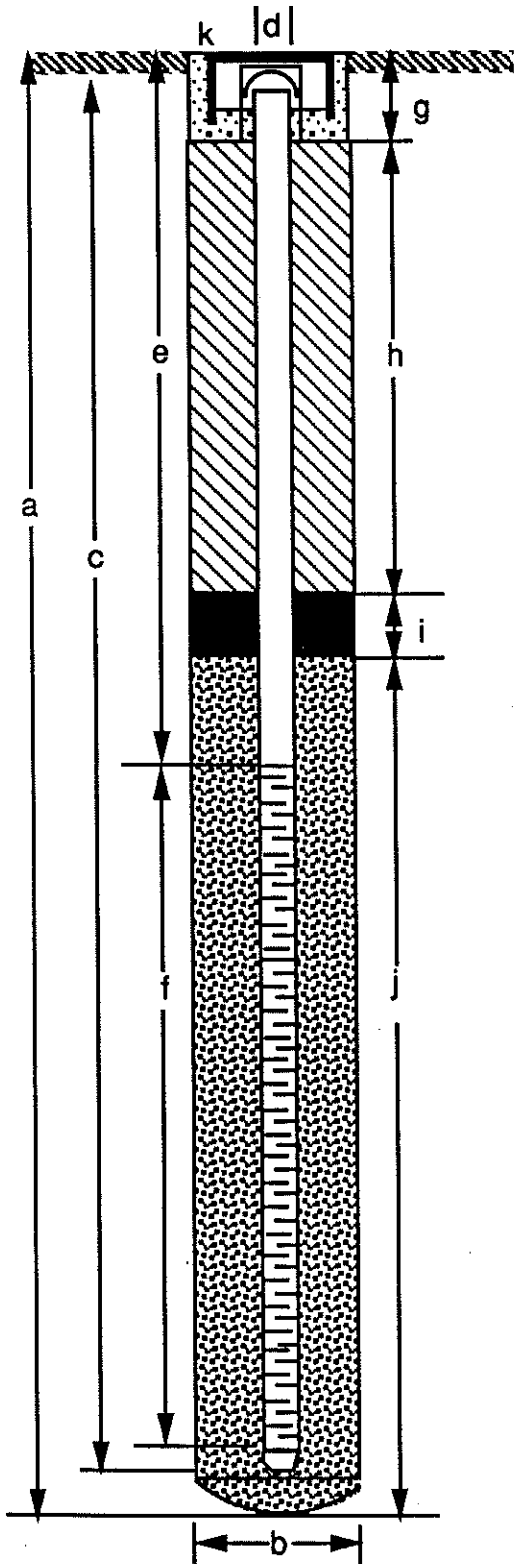

EXPLORATORY BORING

a. Total depth 30 ft.
 b. Diameter 8 in.
 Drilling method Hollow Stem Auger

WELL CONSTRUCTION

c. Casing length 30 ft.
 Material PVC
 d. Diameter 2 in.
 e. Depth to top perforations 15 ft.
 f. Perforated length 15 ft.
 Perforated interval from 30 to 15 ft.
 Perforation type Machine Slot
 Perforation size 0.020 in.
 g. Surface seal 1 ft.
 Seal material Concrete
 h. Backfill 11 ft.
 Backfill material Neat Cement
 i. Seal 1 ft.
 Seal material Hydrated Bentonite Pellets
 j. Gravel pack 17 ft.
 Pack material 2/12 Sand
 k. Expansion plug, lock, 12-inch water-tight vault box

ole w/w

MONITORING WELL DETAIL

Project Number	<u>3-30092-32</u>	Boring/Well No.	<u>MW-11</u>
Project Name	<u>Ultramar/Beacon No. 721</u>	Top of Casing Elev.	<u>45.00</u>
County	<u>Alameda</u>	Ground Surface Elev.	<u>45.36</u>
Well Permit No.	<u>91606</u>	Datum	<u>Alameda County Datum</u>

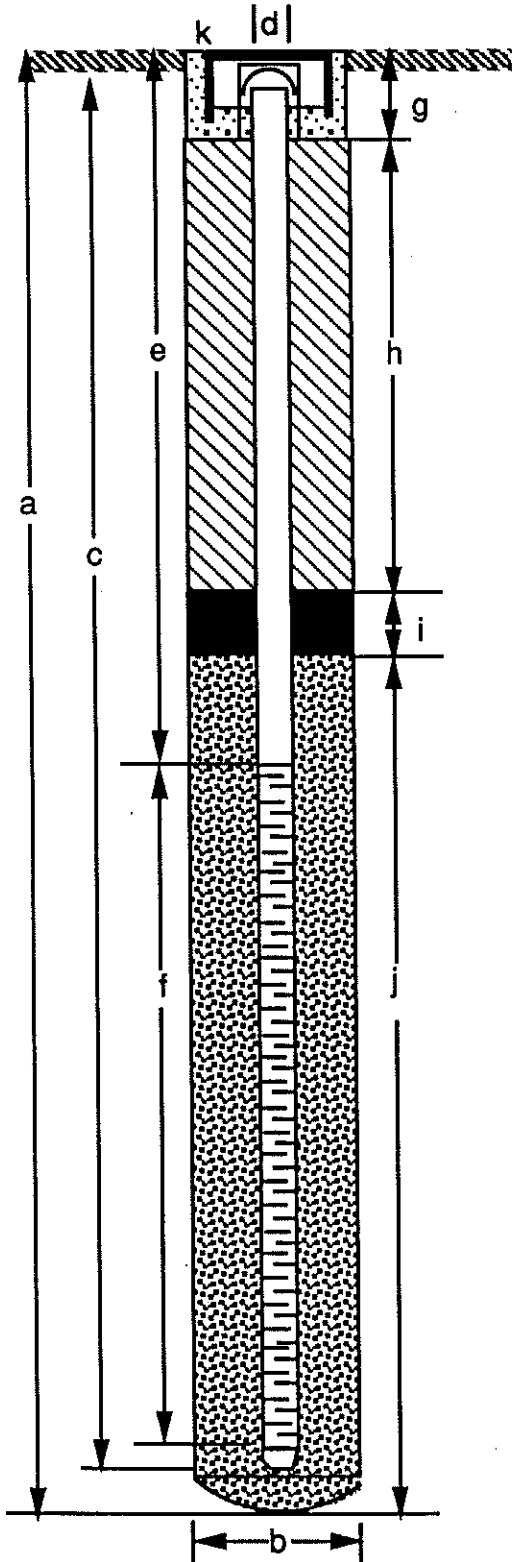

EXPLORATORY BORING

a. Total depth 30 ft.
 b. Diameter 8 in.
 Drilling method Hollow Stem Auger

WELL CONSTRUCTION

c. Casing length 30 ft.
 Material PVC
 d. Diameter 2 in.
 e. Depth to top perforations 15 ft.
 f. Perforated length 15 ft.
 Perforated interval from 30 to 15 ft.
 Perforation type Machine Slot
 Perforation size 0.020 in.
 g. Surface seal 1 ft.
 Seal material Concrete
 h. Backfill 11 ft.
 Backfill material Neat Cement
 i. Seal 1 ft.
 Seal material Hydrated Bentonite Pellets
 j. Gravel pack 17 ft.
 Pack material 2/12 Sand
 k. Expansion plug, lock, 12-inch water-tight vault box

ok. Wny

RESNA EXPLORATORY BORING LOG

Project Name: Ultramar/Beacon No. 721
 44 Lewelling Boulevard
 San Lorenzo, California

Boring No. MW-11

Date Drilled: 10/17/91

Project Number: 3-30092-32

Logged By: K. McVicker

Depth (ft.)	Sample No.	Blows/Foot	Unified Soil Classification	SOIL DESCRIPTION	Water Level	OVM Reading (ppm)
1			ML	SANDY SILT, dark reddish brown, low plasticity, stiff, damp (fine sand)		0
2						
3						
4						
5						
6	S-6-B11	10		(Some fine sand and clay)		0
7						
8						
9						
10						
11	S-11-B11	19		Very stiff		0
12						
13						
14						
15						
16	S-16-B11	16		CLAYEY SILT with some fine sand, moist		0
17						
18						
19				Encountered water at approximately 18 feet	▽	
20						
21	S-21B11	14	CL	SILTY CLAY, dark olive brown, stiff, wet, trace fine to medium sand		0

REVIEWED BY R.G./C.E.G.

ok Wm

RESNA EXPLORATORY BORING LOG

Project Name: Ultramar/Beacon No. 721
 44 Lewelling Boulevard
 San Lorenzo, California

Boring No. MW-11

Date Drilled: 10/17/91

Project Number: 3-30092-32

Logged By: K. McVicker

Depth (ft.)	Sample No.	Blows/Foot	Unified Soil Classification	SOIL DESCRIPTION	Water Level	OVM Reading (ppm)
22	S-21-B11	14	CL	Silty clay, dark olive brown, stiff, wet, trace fine to medium sand		0
23						
24						
25	S-26-B11	17		Color change to dark grey, very stiff		0
26						
27						
28	S-29.5-B11	28		Color change to light olive brown, trace gravel		
29						
30						
31				Bottom of boring at approximately 30 feet		
32						
33						
34						
35						
36						
37						
38						
39						
40						
41						
42						

REVIEWED BY R.G./C.E.G.

ole W

RESNA EXPLORATORY BORING LOG

Project Name: Ultramar/Beacon No. 721
 44 Lewelling Boulevard
 San Lorenzo, California

Boring No. RW-1
 Date Drilled: 10/17/91
 Logged By: D. Wolfe

Project Number: 3-30092-32

Depth (ft.)	Sample No.	Blows/Foot	Unified Soil Classification	SOIL DESCRIPTION	Water Level	OM Reading (ppm)
1				Asphalt over baserock		
2			CL	SILTY CLAY, very dark grayish brown (10YR 3/2), moist, (minor sand and gravel)		8
3						
4						
5						
6	RW-5	11	SC	SILTY-CLAYEY SAND, dark brown (7.5YR 4/3), medium plasticity, medium dense, moist (minor gravel)		69
7						
8						
9						
10			CL	SANDY CLAY, dark grey (7.5YR N4), silt≈20%, sand ≈30% very plastic stiff, moist		
11	RW-10	9				51
12						
13						
14						
15						
16	RW-15	12	SC	CLAYEY SAND, dark grey (7.5YR N4), (fine to coarse with trace silt and gravel), slightly plastic, medium dense, moist-very moist, poorly sorted		702
17						
18						
19						
20						
21	RW-20	18	ML	SANDY SILT, dark grey (10YR N4), 40% fine to medium sand, ≈10% clay, ≈10% gravel, stiff, saturated (hydrocarbon product)	▽	3384

REVIEWED BY R.G./C.E.G.

MONITORING WELL DETAIL

Project Number 3-30092-32 Boring/Well No. RW-1
 Project Name Ultramar/Beacon No. 721 Top of Casing Elev. 43.17
 County Alameda Ground Surface Elev. 43.71
 Well Permit No. 91606 Datum Alameda County Datum

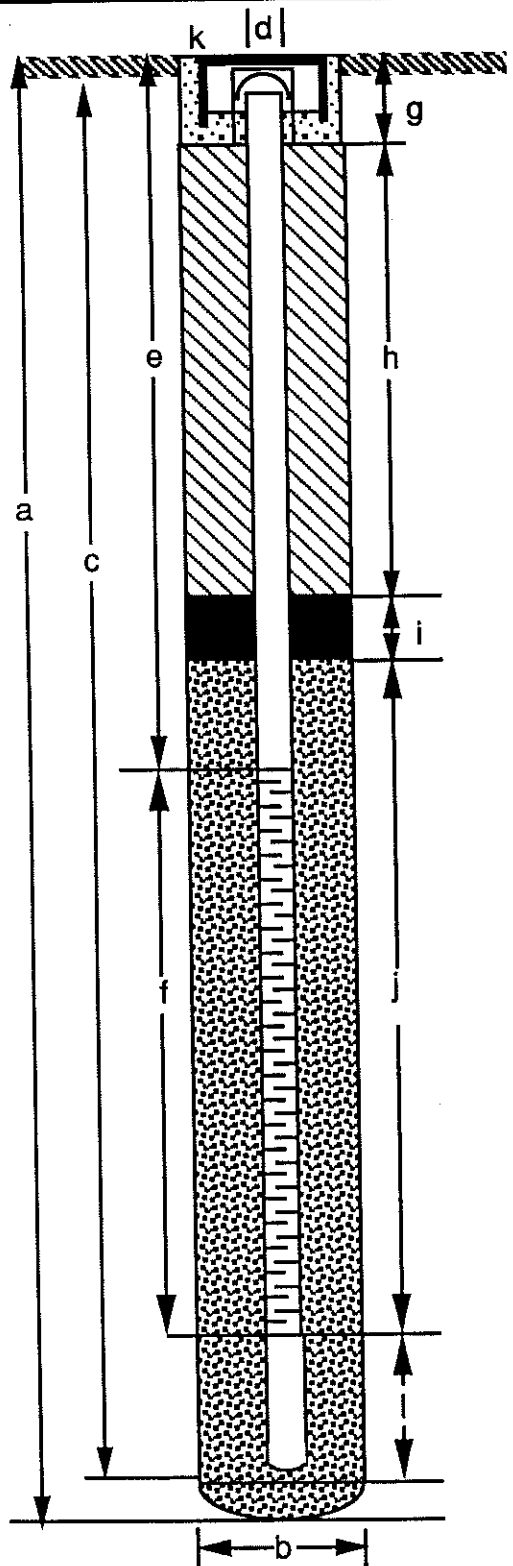

EXPLORATORY BORING

a. Total depth 39 ft.
 b. Diameter 15 in.
 Drilling method Hollow Stem Auger

WELL CONSTRUCTION

c. Casing length 37 ft.
 Material PVC
 d. Diameter 6 in.
 e. Depth to top perforations 15 ft.
 f. Perforated length 20 ft.
 Perforated interval from 35 to 15 ft.
 Perforation type Wire wrap, PVC coated
slots
 Perforation size 0.020 in.
 g. Surface seal 1 ft.
 Seal material Concrete
 h. Backfill 12 ft.
 Backfill material Neat Cement
 i. Seal 1 ft.
 Seal material Hydrated Bentonite Pellets
 j. Gravel pack 21 ft.
 Pack material 2/12 Sand
 k. Expansion plug, lock, 12-inch water-tight
vault box. Bentonite pellets backfilled at
the bottom of the well.
 l. Silt trap 2 ft.

o.k. w/j

RESNA EXPLORATORY BORING LOG

Project Name: Ultramar/Beacon No. 721
 44 Lewelling Boulevard
 San Lorenzo, California

Boring No. RW-1
 Date Drilled: 10/17/91
 Logged By: D. Wolfe

Project Number: 3-30092-32

Depth (ft.)	Sample No.	Blows/Foot	Unified Soil Classification	SOIL DESCRIPTION	Water Level	OVM Reading (ppm)
22	RW-20	18	ML	(Same as above)		250
23			CL	SILTY CLAY, grey (7.5YR N6), very plastic, very stiff, saturated (mottled with calcite and limonite streaks, trace gravel)		
24						
25	RW-25	30	CL	SANDY CLAY, brown (7.5YR 5/3), ≈20% silt, carbonaceous and caliche streaks, very plastic, very stiff, saturated		
26						
27			SW	GRAVELLY SAND, (fine to medium sand, poorly sorted) loose (flowing), saturated		
28						
29						
30	RW-30	29	CL	SILTY CLAY, dark yellowish brown (10YR 4/4), trace gravel and sand, plastic, stiff, saturated		
31						
32			CL	SANDY CLAY, brown (7.5YR 5/3), ≈20% silt, carbonaceous and caliche streaks, very plastic, very stiff, saturated		
33						
34	RW-30	14	SW	GRAVELLY SAND, (fine to medium sand, poorly sorted) loose (flowing), saturated		
35						
36			CL	SILTY CLAY, dark yellowish brown (10YR 4/4), trace gravel and sand, plastic, stiff, saturated		
37						
38				Bottom of boring at approximately 39 feet		
39						
40						
41						
42						

RDM Environmental, Inc.
6280 Brookshire Drive
Rocklin, CA

LOG OF BORING DP-1/MW-12

(Page 1 of 1)

Tesoro Service Station No. 67107
44 Lewelling Boulevard
San Lorenzo, CA

Date Started/Completed 6-26-2007

Drill Rig : PowerProbe Model 9630

Hole Diameter : 2.25-in./8.25-in.

Logged By : M. Berrington, P.G. #7124

Drilling Method : Direct Push/HSA

Survey By : Pending

Installation of Monitoring Well MW-12
and Soil Borings DP-1 thru DP-3

Sampling Method : Dual Tube; 1.75 in. X 48 in. acetate

Northing/Easting Coord:

Drilling Company/Driller: Woodward Drilling/F. Rowe

Casing Elev. :

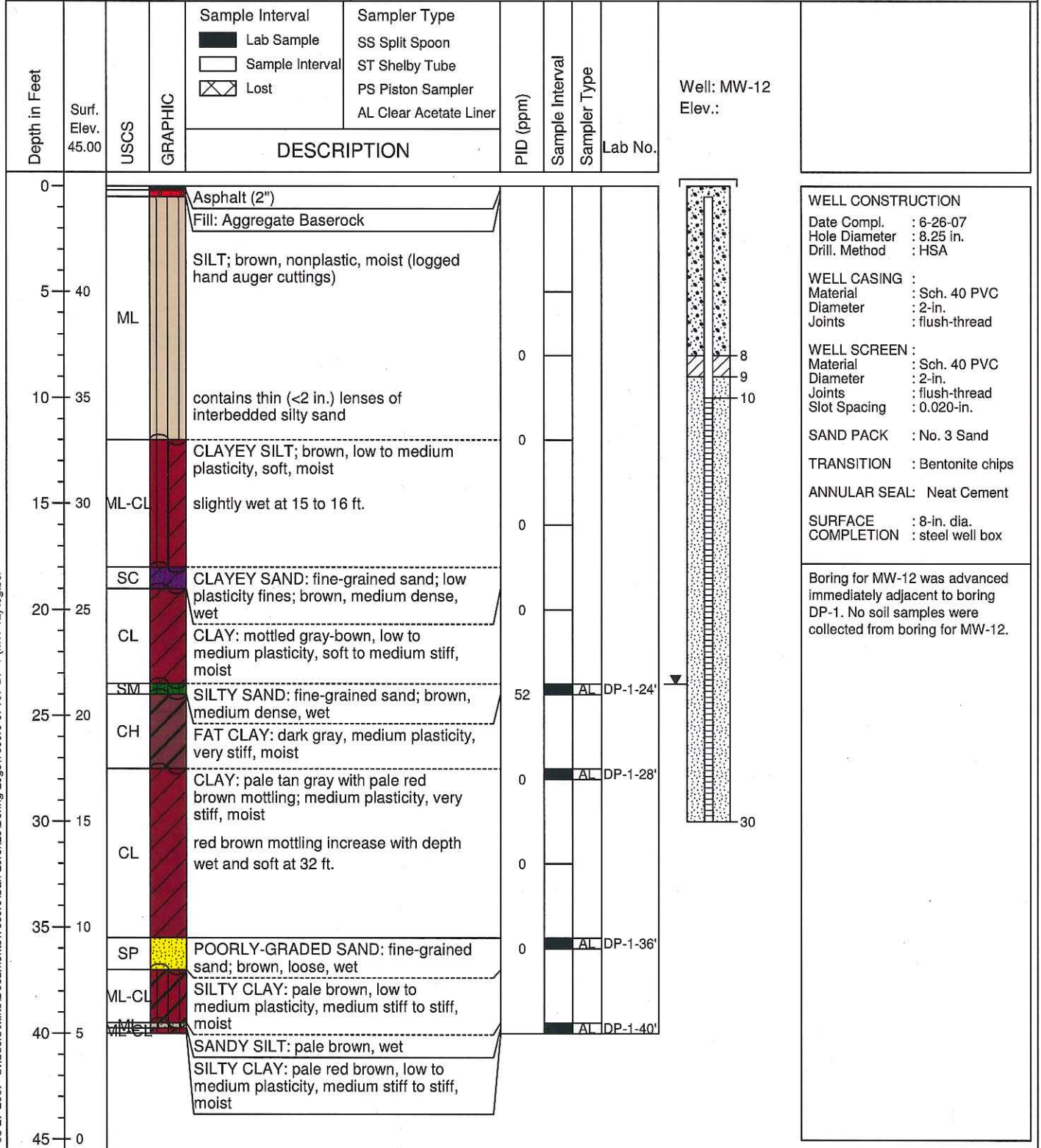

08-27-2007 C:\Users\Mike\Documents\Tesoro\San Lorenzo\Boring Logs\Tesoro 67107 DP-1 (MW-12) log.boi

RDM Environmental, Inc.
6280 Brookshire Drive
Rocklin, CA

LOG OF BORING DP-2

(Page 1 of 1)

Tesoro Service Station No. 67107
44 Lewelling Boulevard
San Lorenzo, CA

Date Started/Completed 6-25-2007

Drill Rig : PowerProbe Model 9630

Hole Diameter : 2.25-in.

Logged By : M. Berrington, P.G. #7124

Drilling Method : Direct Push/HSA

Survey By : Pending

Installation of Monitoring Well MW-12
and Soil Borings DP-1 thru DP-3

Sampling Method : Dual Tube; 1.75 in. X 48 in. acetate

Northing/Easting Coord:

Drilling Company/Driller: Woodward Drilling/F. Rowe

Casing Elev. :

Depth in Feet	Surf. Elev. 45.00	USCS	GRAPHIC	Sample Interval	Sampler Type	Water Level	PID (ppm)	Sample Interval	Sampler Type	Lab No.	REMARKS
				<ul style="list-style-type: none"> ■ Lab Sample □ Sample Interval ⊗ Lost 	<ul style="list-style-type: none"> SS Split Spoon ST Shelby Tube PS Piston Sampler AL Clear Acetate Liner 						
DESCRIPTION											
0				Asphalt (2")							
				Fill: Aggregate Baserock							
5	40	ML		SILT; brown, nonplastic, moist (logged hand auger cuttings)			0				
10	35			contains thin (<2 in.) lenses of interbedded silty sand			0				
				CLAYEY SILT; brown, low to medium plasticity, soft, moist			0				
15	30	ML-CL		wet from 16 to 20 ft.; soft to medium stiff			0	AL		DP-2-16'	
20	25	SP		POORLY GRADED SAND: fine to medium grained sand; brown, medium dense, wet			0				
		CL		CLAY: mottled gray-brown, low to medium plasticity, soft to medium stiff, moist			0				
25	20	SP-SM		POORLY GRADED SAND WITH SILT: fine to medium grained sand; trace (<10%) fine, subrounded gravel to 0.25-in dia.; gray brown to green brown, medium dense, wet			0	AL		DP-2-24'	
		CH		FAT CLAY: dark gray, medium to high plasticity, very stiff, moist			0				
30	15	CL		CLAY: pale tan gray with pale red brown mottling; medium plasticity, very stiff, moist red brown mottling increase with depth wet and soft at 32 ft.			0				
35	10	CL-MI		grades into clayey silt at 35 ft.			0				
		SM		CLAYEY SILT: pale brown, low to medium plasticity, moist to wet			0				
		CL-MI		SILTY SAND: fine grained sand; trace (<10%) fine, subangular gravel to 2-in. dia.; medium dense, wet			0				
40	5	SP		CLAYEY SILT: pale brown, low to medium plasticity, medium stiff to stiff, moist to wet			0				
				POORLY GRADED SAND ??- determination based on observation of material on drill bit			0				
45	0										Total Depth = 40 ft.

RDM Environmental, Inc.
6280 Brookshire Drive
Rocklin, CA

LOG OF BORING DP-3

(Page 1 of 1)

Tesoro Service Station No. 67107
44 Lewelling Boulevard
San Lorenzo, CA

Date Started/Completed 6-26-2007

Drill Rig : PowerProbe Model 9630

Hole Diameter : 2.25-in.

Logged By : M. Berrington, P.G. #7124

Drilling Method : Direct Push/HSA

Survey By : Pending

Installation of Monitoring Well MW-12
and Soil Borings DP-1 thru DP-3

Sampling Method : Dual Tube; 1.75 in. X48 in. acetate

Northing/Easting Coord:

Drilling Company/Driller: Woodward Drilling/F. Rowe

Casing Elev. :

Depth in Feet	Surf. Elev. 45.00	USCS	GRAPHIC	Sample Interval	Sampler Type	Water Level	PID (ppm)	Sample Interval	Sampler Type	Lab No.	REMARKS
				■ Lab Sample □ Sample Interval ⊗ Lost	SS Split Spoon ST Shelby Tube PS Piston Sampler AL Clear Acetate Liner						
				DESCRIPTION							
0				Asphalt (2")							
				Fill: Aggregate Baserock							
5	40	ML		SILT; brown, nonplastic, moist (logged hand auger cuttings)			0				
10	35			contains thin (<2 in.) lenses of interbedded silty sand			0				
				CLAYEY SILT; brown, low to medium plasticity, soft, moist			0				
15	30	ML-CL		first groundwater between 17 to 18 ft.; soft to medium stiff			0				
20	25	SC		CLAYEY SAND: fine to medium grained sand; brown, medium dense, wet			0				
		CL		CLAY WITH SAND: fine-grained sand; trace (<10%) fine, subrounded gravel to 0.5-in. dia.; mottled gray-brown, low to medium plasticity, soft to medium stiff, moist			15	AL		DP-3-24.5'	
25	20	CH		SILTY SAND: fine to medium grained sand; trace (<10%) fine, subrounded gravel to 0.25-in. dia.; gray brown to green brown, medium dense, wet			6.5				
				FAT CLAY: dark gray, medium to high plasticity, very stiff, moist			0	AL		DP-3-28	
30	15	CL		CLAY: pale tan gray with pale red brown mottling; medium plasticity, very stiff, moist			0				
				red brown mottling increase with depth			0				
				wet and soft at 32 ft.			0				
35	10	ML		SILT WITH SAND: pale brown, low to medium plasticity, moist to wet			0	AL		DP-3-36	
		SP-SM		POORLY GRADED SAND WITH SILT; fine grained sand; trace (<10%) fine, subangular gravel to 2-in. dia.; medium dense, wet			0				
40	5	CL-ML		CLAYEY SILT: pale brown, low to medium plasticity, medium stiff to stiff, moist to wet			0				No recovery from 39 to 40 ft.
		SP		POORLY GRADED SAND ??- determination based on observation of material on drill bit			0				Total Depth = 40 ft.
45	0										

PROJECT NAME/LOCATION:		Project Number: D093-936	Logging Number: AS-1
Beacon Station No. 721 44 Lewelling Boulevard San Lorenzo, CA		Contractor: Turner Explorations	Drilling Method: 8" HSA
		Driller: Mark Nelson	Drilling Rig: B-59
		Start: 1:55 p.m. 10/10/95	Completed: 2:47 p.m. 10/10/95
Landowner: Ultramar Inc.		Surface Elev.: --	Logged By: Will Speth

Sample		Blow Count	Sample		Depth Scale [1" = 4"]	Descriptions of Materials and Conditions	Comments
Type	No.		Interval (ft)	Recovery (%)			
CAM	AS-1-5	1	5.0-6.5	14	0	SANDY SILT WITH TRACE FINES; fine grained sand; light brown, low plasticity, dry, soft (ML)	
		3			1		
		3			2		
					3		
					4		
CAM	AS-1-10	2	10.0-11.5	14	5	SANDY SILT WITH TRACE FINES; fine grained sand; light brown, low plasticity, dry, soft (ML)	
		2			6		
		5			7		
					8		
					9		
CAM	AS-1-15	3	15.0-16.5	18	10	SANDY SILT WITH FINES; medium to fine grained sand; medium brown with oxide mottling, medium plasticity, wet, medium stiff (ML)	
		5			11		
		7			12		
					13		
					14		
CAM	AS-1-20	3	20.0-21.5	18	15	SANDY SILT WITH FINES; medium to fine grained sand; olive green with oxide mottling, medium plasticity, wet, medium stiff (ML)	
		6			16		
		8			17		
					18		
					19		
			20				First water
			21				
			22				
			23				

BOREHOLE WATER LEVEL DATA			
Date	10/10/95		
Time			
GWL			
Casing Depth	27 ft.		



PROJECT NAME/LOCATION:		Project Number	D093-936	Boring Number	AS-1
Beacon Station No. 721 44 Lewelling Boulevard San Lorenzo, CA		Contractor	Turner Explorations	Drilling Method	8" HSA
		Driller	Mark Nelson	Drilling Rig	B-59
		Start	1:55 p.m. 10/10/95	Completed	2:47 p.m. 10/10/95
Landowner: Ultramar Inc.		Surface Elev.	—	Logged By	Will Speth

Sample		Blow Count	Sample		Depth Scale 1" = 4'	Descriptions of Materials and Conditions	Comments
Type	No.		Interval (ft)	Recovery (in)			
CAM	AS-1-25	5 7 17	25.0- 26.5	16	24 25 26 27 28 29 30 31 32 33 34 35 36 37 38 39 40 41 42 43 44 45 46 47	SANDY CLAY; fine grained sand; light brown with oxide mottling, low plasticity, wet, very stiff (CL) Total depth 27 ft.	

BOREHOLE WATER LEVEL DATA

Date	10/10/95		
Time			
GWL			
Casing Depth	27 ft.		



PROJECT NAME/LOCATION:		Project Number	D093-936	Boring Number	AS-2
Beacon Station No. 721 44 Lewelling Boulevard San Lorenzo, CA		Contractor	Turner Explorations	Drilling Method	8" HSA
		Driller	Mark Nelson	Drilling Rig	B-59
		Start	9:00 a.m. 10/10/95	Completed	10:15 a.m. 10/10/95
Landowner: Ultramar Inc.		Surface Elev.	---	Logged By	Will Speth

Sample		Blow Count	Sample		Depth Scale [1" = 4']	Descriptions of Materials and Conditions	Comments
Type	No.		Interval (ft)	Recovery (%)			
					0	7" ASPHALT	
					1		
					2		
					3		
					4		
CAM	AS-2-5	3 4 5	5.0-6.5	18	5	SANDY SILT WITH TRACE FINES; fine grained sand; medium brown, low plasticity, dry, soft (ML/SM)	
					6		
					7		
					8		
					9		
CAM	AS-2-10	3 4 7	10.0-11.5	18	10	SANDY SILT WITH FINES; fine grained sand; dark brown, low plasticity, moist, medium stiff (ML)	
					11		
					12		
					13		
					14		
CAM	AS-2-15	9 6 5	15.0-16.5	18	15	POORLY GRADED GRAVEL; coarse sand; gravel subangular to subround 5 to 20 mm; dark gray, wet (GP)	First water
					16		
					17		
					18		
					19		
CAM	AS-2-20	5 5 9	20.0-21.5	14	20	SILTY SAND WITH TRACE GRAVEL; medium to fine grain sand; gravel subangular to subrounded 5 mm to 10 mm; low plasticity, wet (SM/ML)	
					21		
					22		
					23		

BOREHOLE WATER LEVEL DATA			
Date	10/10/95		
Time			
GWL			
Casing Depth	27 ft.		



PROJECT NAME/LOCATION:		Project Number	D093-936	Boring Number	AS-2
Beacon Station No. 721 44 Lewelling Boulevard San Lorenzo, CA		Contractor	Turner Explorations	Drilling Method	8" HSA
		Driller	Mark Nelson	Drilling Rig	B-59
		Start	9:00 a.m. 10/10/95	Completed	10:15 a.m. 10/10/95
Landowner: Ultramar Inc.		Surface Elev.	—	Logged By	Will Speth

Sample		Blow Count	Sample		Depth Scale 1" = 4'	Descriptions of Materials and Conditions	Comments
Type	No.		Interval (ft)	Recovery (ft)			
CAM	AS-2-25	7 15 29	25.0- 26.5	18	24 25 26 27 28 29 30 31 32 33 34 35 36 37 38 39 40 41 42 43 44 45 46 47	SILTY SAND WITH TRACE GRAVEL; medium to fine grain sand; gravel subangular to subrounded 5 mm to 10 mm; greenish gray with yellow orange mottles and with fines, low plasticity, moist (ML)	
						Total depth 27 ft.	

BOREHOLE WATER LEVEL DATA			
Date	10/10/95		
Time			
GWL			
Casing Depth	27 ft.		



PROJECT NAME/LOCATION		Project Number	D093-936	Boring Number	AS-3
Beacon Station No. 721 44 Lewelling Boulevard San Lorenzo, CA		Contractor	Turner Explorations	Drilling Method	8" HSA
		Driller	Mark Nelson	Drilling Rig	B-59
		Start	12:00 p.m. 10/10/95	Completed	1:15 p.m. 10/10/95
Landowner: Ultramar Inc.		Surface Elev.	--	Logged By	Will Speth

Sample		Blow Count	Sample		Depth Scale (ft. - 4")	Descriptions of Materials and Conditions	Comments
Type	No.		Interval (ft)	Recovery (%)			
CAM	AS-3-5	3 3 4	5.0-6.5	18	0	8" ASPHALT	
					1		
					2		
					3		
					4		
CAM	AS-3-10	1 2 3	10.0-11.5	18	5	SANDY SILT WITH FINES; fine grained sand; medium brown, low plasticity, dry, soft (ML)	
					6		
					7		
					8		
					9		
CAM	AS-3-15	4 4 5	15.0-16.5	18	10	POORLY GRADED SAND; fine grained sand; light brown, no plasticity, dry, loose sand (SP)	
					11	SANDY SILT WITH TRACE FINES; fine grained sand; medium brown, low plasticity, soft, moist (SM/ML)	
					12		
					13		
					14		
CAM	AS-3-20	3 6 11	20.0-21.5	0/18	15	POORLY GRADED SAND WITH GRAVEL; fine to coarse grained sand; gravel subangular to subrounded 5 mm to 20 mm; loose sand; medium brown, wet (SW)	First water
					16		
					17		
					18	CLAY SILT WITH SAND; fine grained sand; greenish gray, medium plasticity, soft, wet (ML)	
					19		
					20	SILTY SAND WITH TRACE GRAVEL; medium to fine grained; gravel subrounded 5 mm, greenish gray, low plasticity, stiff, wet (SM)	No recovery. Resample with sand catch
					21		
					22		
					23		

BOREHOLE WATER LEVEL DATA			
Date	10/10/95		
Time			
GWL			
Casing Depth	27 ft.		



PROJECT NAME/LOCATION:		Project Number	D093-936	Boring Number	AS-3
Beacon Station No. 721 44 Lewelling Boulevard San Lorenzo, CA		Contractor	Turner Explorations	Drilling Method	8" HSA
		Driller	Mark Nelson	Drilling Rig	B-59
		Start	12:00 p.m. 10/10/95	Completed	1:15 p.m. 10/10/95
Landowner: Ultramar Inc.		Surface Elev.	--	Logged By	Will Speth

Sample		Blow Count	Sample		Depth Scale 1" = 4'	Descriptions of Materials and Conditions	Comments
Type	No.		Interval (ft)	Recovery (ft)			
CAM	AS-3-25	6	25.0-26.5	18	24	SILTY SAND WITH TRACE GRAVEL; medium to fine grained; gravel subrounded 5 mm, greenish gray, low plasticity, stiff, wet (SM) Total depth 27 ft.	
		9			25		
		16			26		
					27		
					28		
					29		
					30		
					31		
					32		
					33		
					34		
					35		
					36		
					37		
					38		
					39		
					40		
					41		
					42		
					43		
					44		
					45		
					46		
					47		

BOREHOLE WATER LEVEL DATA			
Date	10/10/95		
Time			
GWL			
Casing Depth	27 ft.		



INSTALLATION OF AIR SPARGING MONITORING WELL

Project

Beacon Station No. 721

Monitoring Well No.

AS-1

44 Lewelling Boulevard

Elevations:

San Lorenzo, California

Top of Riser: _____

Delta No.

D093-936

Ground Level: _____

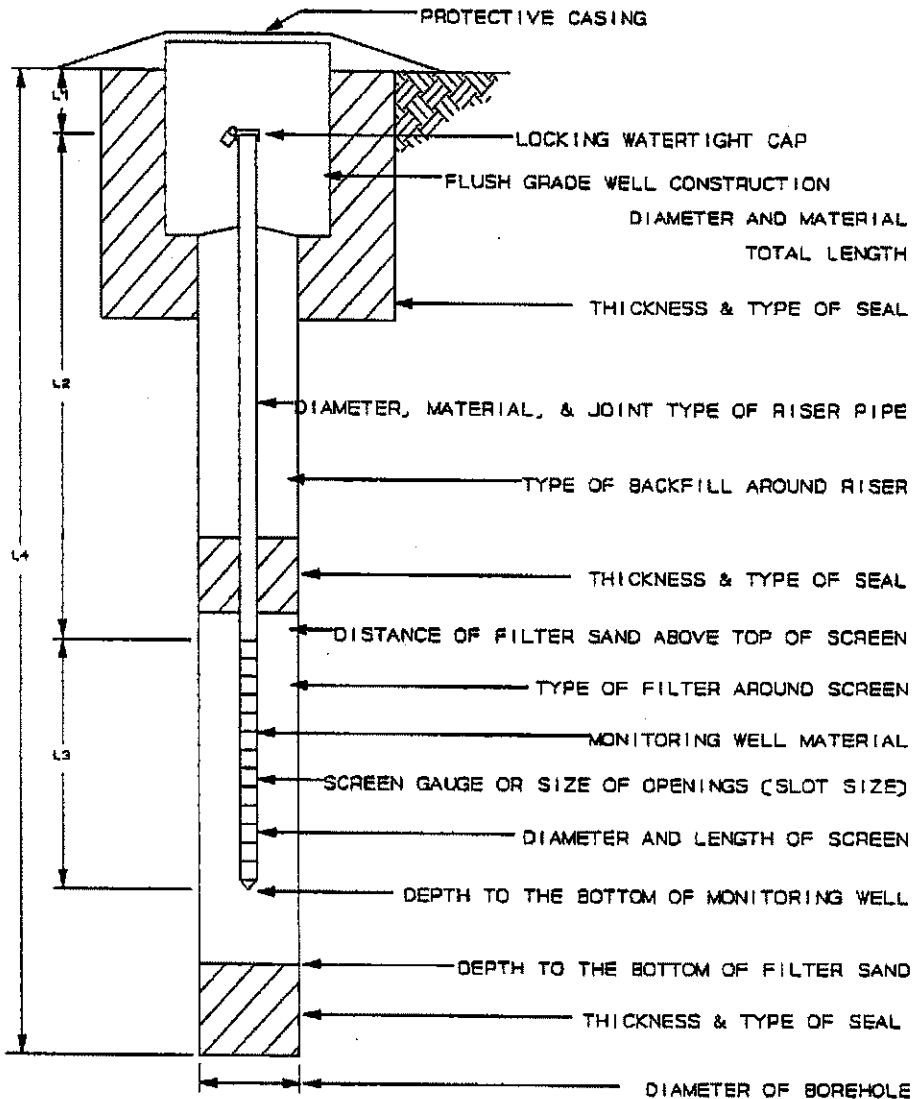

DIAMETER AND MATERIAL	<u>12-inch steel</u>
TOTAL LENGTH	<u>12 inches</u>
THICKNESS & TYPE OF SEAL	<u>12 inches concrete</u>
DIAMETER, MATERIAL, & JOINT TYPE OF RISER PIPE	<u>1-inch Schedule 40 flush threaded</u>
TYPE OF BACKFILL AROUND RISER	<u>Cement grout with 5% bentonite</u>
THICKNESS & TYPE OF SEAL	<u>1 foot bentonite</u>
DISTANCE OF FILTER SAND ABOVE TOP OF SCREEN	<u>1 foot</u>
TYPE OF FILTER AROUND SCREEN	<u>No. 3 Lonestar</u>
MONITORING WELL MATERIAL	<u>Schedule 40 PVC</u>
SCREEN GAUGE OR SIZE OF OPENINGS (SLOT SIZE)	<u>20 microns</u>
DIAMETER AND LENGTH OF SCREEN	<u>2 inches x 2.5 feet</u>
DEPTH TO THE BOTTOM OF MONITORING WELL	<u>27 feet</u>
DEPTH TO THE BOTTOM OF FILTER SAND	<u>27 feet</u>
THICKNESS & TYPE OF SEAL	<u>NA</u>
DIAMETER OF BOREHOLE	<u>8 inches</u>

- L1 = 0.5 FT
- L2 = 24.0 FT
- L3 = 2.5 FT
- L4 = 27.0 FT

Installation Completed

Date: 10/10/95

Time: 2:47 p.m.



INSTALLATION OF AIR SPARGING MONITORING WELL

Project

Beacon Station No. 721

Monitoring Well No. AS-2

44 Lewelling Boulevard

Elevations:

San Lorenzo, California

Top of Riser: _____

Delta No. D093-936

D093-936

Ground Level: _____

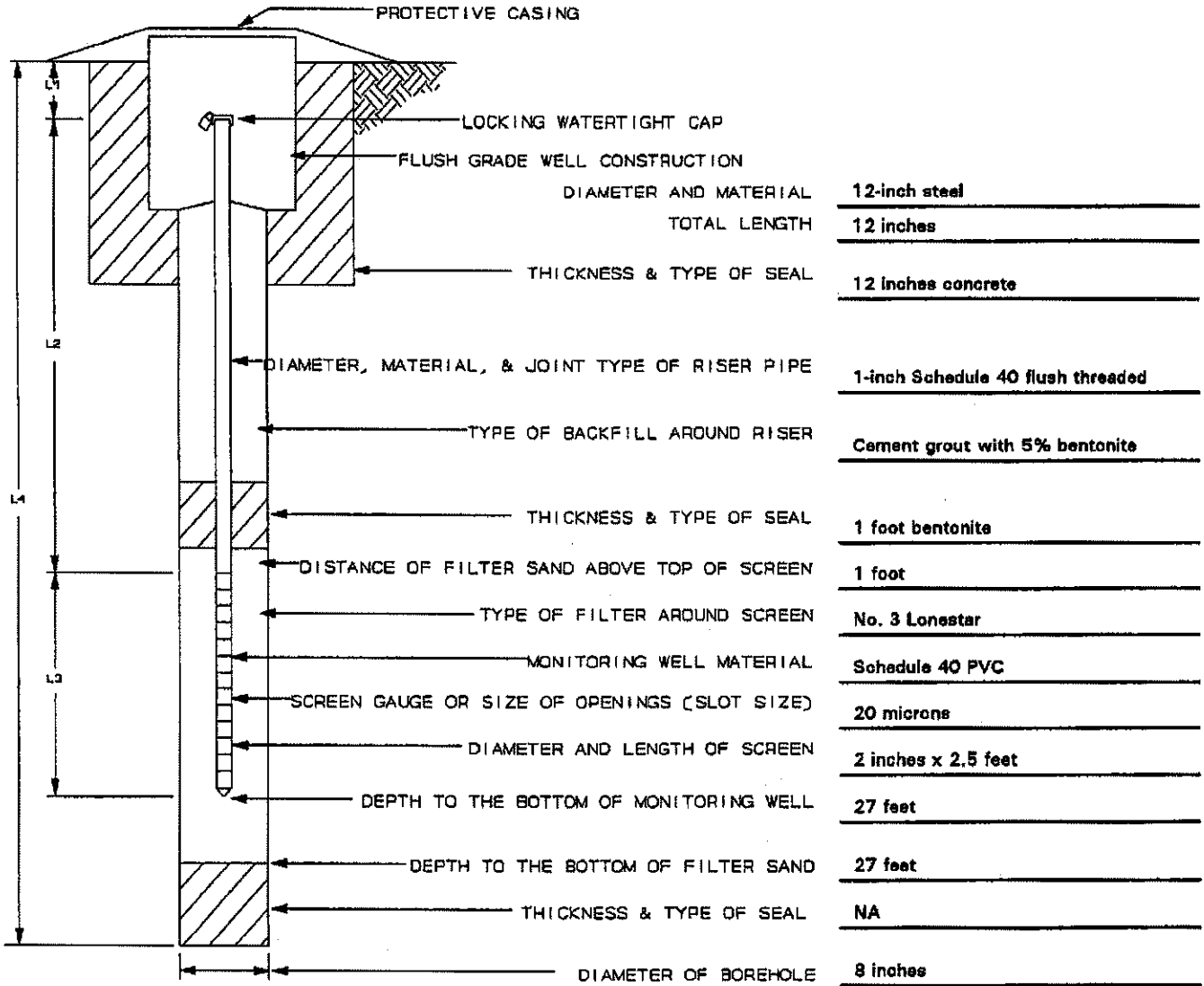

L1 = 0.5 FT

L2 = 24.0 FT

L3 = 2.5 FT

L4 = 27.0 FT

Installation Completed

Date: 10/10/95

Time: 10:15 a.m.



INSTALLATION OF AIR SPARGING MONITORING WELL

Project

Beacon Station No. 721

Monitoring Well No.

AS-3

44 Lewelling Boulevard

Elevations:

San Lorenzo, California

Top of Riser: _____

Delta No.

D093-936

Ground Level: _____

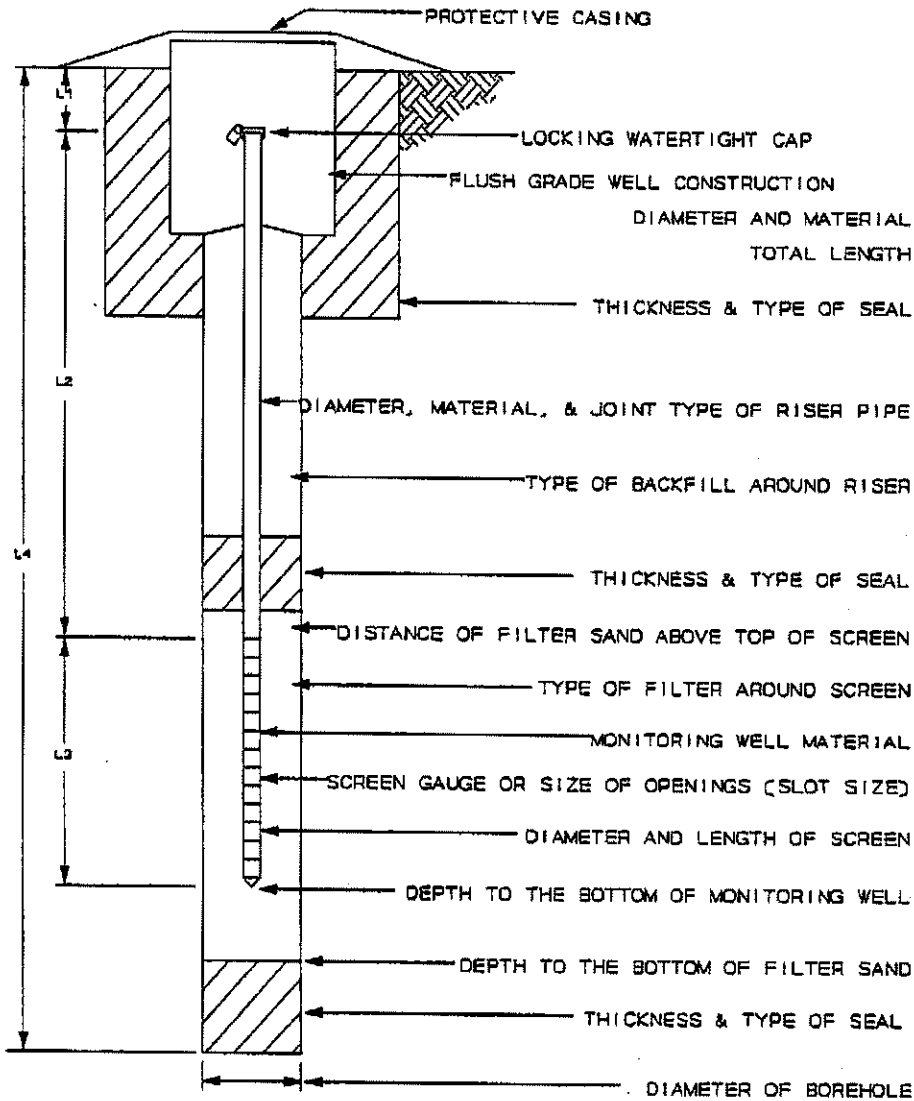

DIAMETER AND MATERIAL	12-inch steel
TOTAL LENGTH	12 inches
THICKNESS & TYPE OF SEAL	12 inches concrete
DIAMETER, MATERIAL, & JOINT TYPE OF RISER PIPE	1-inch Schedule 40 flush threaded
TYPE OF BACKFILL AROUND RISER	Cement grout with 5% bentonite
THICKNESS & TYPE OF SEAL	1 foot bentonite
DISTANCE OF FILTER SAND ABOVE TOP OF SCREEN	1 foot
TYPE OF FILTER AROUND SCREEN	No. 3 Lonestar
MONITORING WELL MATERIAL	Schedule 40 PVC
SCREEN GAUGE OR SIZE OF OPENINGS (SLOT SIZE)	20 microns
DIAMETER AND LENGTH OF SCREEN	2 inches x 2.5 feet
DEPTH TO THE BOTTOM OF MONITORING WELL	27 feet
DEPTH TO THE BOTTOM OF FILTER SAND	27 feet
THICKNESS & TYPE OF SEAL	NA
DIAMETER OF BOREHOLE	8 inches

L1 = 0.5 FT
 L2 = 24.0 FT
 L3 = 2.5 FT
 L4 = 27.0 FT

Installation Completed

Date: 10/10/95

Time: 1:15 p.m.

