

# Atlantic Richfield Company

**Shannon Couch**  
Operations Project Manager

**RECEIVED**

By Alameda County Environmental Health at 9:18 am, Mar 04, 2013

PO Box 1257  
San Ramon, CA 94583  
Phone: (925) 275-3804  
Mobile: (510) 798-8314  
E-Mail: Shannon.Couch1@bp.com

February 28, 2013

Re: Revised Soil & Groundwater Investigation Work Plan  
Atlantic Richfield Company Station #2111  
1156 Davis Street, San Leandro, California  
ACEH Case #RO0000494

"I declare, that to the best of my knowledge at the present time, that the information and/or recommendations contained in the attached document are true and correct."

Submitted by,



Shannon Couch  
Operations Project Manager

Attachment:

**REVISED SOIL & GROUNDWATER INVESTIGATION WORK  
PLAN**

Atlantic Richfield Company Station No.2111  
1156 Davis Street  
San Leandro, California

Prepared for

Ms. Shannon Couch  
Environmental Business Manager  
Atlantic Richfield Company  
P.O. Box 1257  
San Ramon, California 94583

Prepared by



875 Cotting Lane, Suite G  
Vacaville, California 95688  
(707) 455-9270  
[www.broadbentinc.com](http://www.broadbentinc.com)

February 28, 2013

Project No. 06-88-615



**BROADBENT**

875 Colting Ln., Suite G, Vacaville, CA 95688  
[T] 707-455-7290 [F] 707-455-7295  
broadbentinc.com

**CREATING SOLUTIONS. BUILDING TRUST.**

February 28, 2013

Project No. 06-88-615

Atlantic Richfield Company  
P.O. Box 1257  
San Ramon, CA 94583  
Submitted via ENFOS

Attn.: Ms. Shannon Couch

Re: Revised Soil & Groundwater Investigation Work Plan, Atlantic Richfield Company Station No.2111, 1156 Davis Street, San Leandro, California; ACEH Case No.RO0000494

Dear Ms. Couch:

Broadbent & Associates, Inc. (Broadbent) is pleased to submit this *Revised Soil & Groundwater Investigation Work Plan* for Atlantic Richfield Company Station No.2111 located at 1156 Davis Street, San Leandro, California (Site). This document was prepared to evaluate current Site conditions and define the downgradient extent of hydrocarbons in groundwater. Within it, Broadbent is proposing to advance six soil borings downgradient from Station No.2111 and perform additional data evaluations to close Site data gaps

Should you have questions or require additional information, please do not hesitate to contact us at (707) 455-7290.

Sincerely,  
BROADBENT & ASSOCIATES, INC.

Kristene Tidwell, P.G., C.HG.  
Senior Geologist

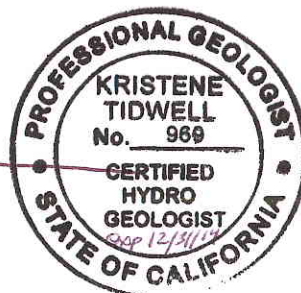

Enclosures

cc: Ms. Dilan Roe, Alameda County Environmental Health (Submitted via ACEH ftp site)  
Electronic copy uploaded to GeoTracker

**REVISED SOIL & GROUNDWATER INVESTIGATION WORK PLAN**  
**Atlantic Richfield Company Station No.2111**  
**1156 Davis Street, San Leandro, California**  
**Fuel Leak Case No. RO0000494**

**TABLE OF CONTENTS**

<b>1.0 INTRODUCTION.....</b>	<b>1</b>
<b>2.0 BACKGROUND INFORMATION.....</b>	<b>1</b>
2.1 Site Location.....	1
2.2 Previous Environmental Activities at Site.....	1
2.3 Regional Geology and Hydrogeology.....	4
<b>3.0 PROPOSED SCOPE OF WORK.....</b>	<b>4</b>
3.1 Proposed Soil Boring Locations.....	4
3.2 Preliminary Activities, Permitting and Notifications.....	5
3.3 CPT Boring Activities.....	5
3.4 Soil and Ground-Water Investigation Report.....	5
3.5 Proposed CPT Boring Locations and Data Objectives.....	6
3.6 Preliminary Activities, Permitting, and Notifications.....	6
3.7 Soil Boring Activities.....	7
3.7.1 Soil Sample Collection and Analysis.....	7
3.7.2 Groundwater Collection and Analysis.....	7
3.7.3 Investigation-Derived Waste.....	8
3.8 Soil and Groundwater Investigation Report.....	8
<b>4.0 PROPOSED SCHEDULE .....</b>	<b>8</b>
<b>5.0 LIMITATIONS .....</b>	<b>8</b>
<b>6.0 REFERENCES.....</b>	<b>9</b>

**DRAWINGS**

- 1-Site Location Map
- 2-Area Development Photo
- 3-Site Layout Plan with Proposed Offsite Soil Boring Locations

**APPENDICES**

- A - Recent Regulatory Correspondence
- B - Historical Soil & Groundwater Data
- C - Soil Boring and Well Construction Logs
- D - Geologic Cross-Sections
- E - Field Methods



**REVISED SOIL & GROUNDWATER INVESTIGATION WORK PLAN**  
**Atlantic Richfield Company Station No.2111**  
**1156 Davis Street, San Leandro, California**  
**Fuel Leak Case No. RO0000494**

## **1.0 INTRODUCTION**

On behalf of the Atlantic Richfield Company (ARC)- a BP affiliated company, Broadbent & Associates, Inc. (Broadbent) has prepared this *Revised Soil & Groundwater Investigation Work Plan* (Work Plan) for the Atlantic Richfield Company (ARC) Station No. 2111 (Site), located at 1156 Davis Street, San Leandro, California (Site). The initial *Soil and Groundwater Investigation Work Plan* (Previous Work Plan; Broadbent, 2009a) was prepared in response to a July 9, 2009 directive letter from Mr. Paresh Khatri of Alameda County Environmental Health (ACEH), provided within Appendix A. This Previous Work Plan was never implemented due to access not being obtained for one of the neighboring properties where access was needed. Since 2009, Site conditions, regulatory oversight, and the regulations have changed and it is the opinion of Broadbent and ARC that this Revised Work Plan was necessary to address these changes. This Work Plan includes discussions on the Site background and previous environmental activities, regional and Site geology and hydrogeology, proposed scope of work, and proposed schedule. Appendices referenced within this report are provided following the conclusion of the document's text.

A previous *Revised Soil and Groundwater Investigation Work Plan* was submitted on October 26, 2012. ACEH responded to this email with comments in an email dated January 14, 2013 (ACEH Email). This email requested a revised work plan be submitted addressing those comments. The scope of work presented herein is intended to satisfy the requirements of the ACEH email.

## **2.0 BACKGROUND INFORMATION**

### **2.1 Site Location**

Station No. 2111 is located at 1156 Davis Street in San Leandro, California. It is an active ARCO branded gasoline station. Current improvements at the Site include two gasoline underground storage tanks (USTs) believed to have been installed in 2000, two fuel dispenser islands with a total of four double-sided dispensers, and a convenience store building. The majority of the Site surface is paved with asphalt and concrete. The Site is bound by Preda Street to the east, Davis Street to the south, single-family residential dwellings to the north and the First Christian Church property immediately to the west. A Site Location Map is provided as Drawing 1. A recent aerial photo showing the Site and local area development is provided as Drawing 2.

### **2.2 Previous Environmental Activities at Site**

On August 30, 1993 GeoStrategies, Inc. (GSI) observed the removal of a hydraulic hoist and underlying material. GSI collected four soil samples from the excavation pit S-7-HL (7.0 feet below ground surface, ft bgs), S-7½-HL (7.5 ft bgs), S-8-HL (8 ft bgs), and S-9-HL (9 ft bgs). The concentrations of Total Extractable Petroleum Hydrocarbons (TEPH) as Hydraulic Oil ranged from 9,200 milligrams per kilogram (mg/kg) to 27,000 mg/kg in samples S-9-HL and S-7-HL, respectively (GSI, 10/4/1993). Historical analytical results are tabulated within Appendix B.

On March 4, 1994 GSI observed the advancement of two soil borings (B-1 and B-2) to find the extent of the hydraulic oil contamination. Both borings were advanced to a depth of approximately 20.0 ft bgs in the vicinity of the former hydraulic hoist. During the investigation eight soil samples were collected with concentrations ranging from non-detect at 1.0 mg/kg to 11 ppm in samples B1-4.5 and B2-20

respectively. GSI concluded that the hydraulic oil had not significantly impacted the surrounding area. However, GSI also concluded that unidentified hydrocarbons had impacted the capillary fringe beneath the northwestern corner of the service station building (GSI, 4/13/1994).

On August 15, 1994 GSI observed the removal of a 280 gallon waste-oil tank and over excavation of the surrounding area. Seven soil samples were collected during the excavation, four of which (soil samples WO-N, WO-1, WO-B and WO-B2) contained petroleum hydrocarbon at maximum concentrations of: 310 ppm total petroleum hydrocarbons as gasoline (TPH-g); 780 mg/kg total petroleum hydrocarbons as diesel (TPH-g); 2,000 ppm total petroleum hydrocarbons as motor oil range (TPH-mo); 7,900 mg/kg total recoverable petroleum hydrocarbons (TRPH) (GSI, 9/27/1994). On 12 September 1994 GSI observed the installation of a 600 gallon waste-oil tank in the same area as the former waste-oil tank.

On July 12 and 13, 1995 EMCON observed the installation of onsite monitoring wells MW-1 through MW-4. The total depths for the monitoring well borings ranged between 27.5 ft bgs and 40 ft bgs. Soil samples collected from borings for wells MW-1, MW-3, and MW-4 did not contain any petroleum hydrocarbon contamination. However, soil samples collected from the boring for well MW-2 contained maximum concentrations of TPH-g at 320 mg/kg, benzene at 0.26 mg/kg, ethylbenzene at 3.4 mg/kg, and Total Xylenes at 1.5 mg/kg (EMCON, 11/8/1995). Boring locations are depicted in Drawing 3. Tabulated historic soil and groundwater analytical results are provided within Appendix B. Copies of available soil boring and monitoring well construction logs are provided within Appendix C.

Between 28 February and 1 March 1996, EMCON observed the installation of offsite monitoring wells MW-5 and MW-6, onsite monitoring well MW-7, and onsite vapor extraction wells VW-1 through VW-4. Soil samples collected from offsite wells MW-5 and MW-6 did not contain petroleum hydrocarbons. Soil samples from onsite well MW-7 adjacent to the corner of the UST pit contained up to 55 mg/kg TPH-g, up to 0.11 mg/kg benzene, up to 0.80 mg/kg ethylbenzene, and up to 1.5 mg/kg total xylenes. Soil samples from each of vapor extraction wells VW-1 through VW-4 contained petroleum hydrocarbons, with the most significant concentrations being in VW-2 and VW-4: up to 1,100 mg/kg TPH-g (VW-4), up to 0.30 mg/kg benzene (VW-2), up to 0.50 mg/kg ethylbenzene (VW-1), and up to 3 mg/kg total xylenes (VW-4) (EMCON, 9/19/1996).

In October 2000, Petcon Technologies, Inc. removed the three 12,000-gallon former USTs, product lines and dispensers from the Site. Approximately 930 cubic yards (yd<sup>3</sup>) of soil was excavated from under the former gasoline USTs (to a depth of 17 ft bgs), product lines and dispenser islands. A representative of Delta Environmental Consultants, Inc. (Delta) collected soil samples from former USTs, product lines and dispenser islands. In the area of the former gasoline USTs, soil samples T1-S, T1-N, T2-S, T2-N, T2-M, T3-S and T3-N contained maximum concentrations of TPH-g at 4,400 mg/kg (T2-N), methyl tertiary butyl ether (MTBE) at 89 mg/kg, benzene, toluene, ethylbenzene and total xylenes (BTEX) at 7.7 mg/kg, 190 mg/kg, 58 mg/kg, and 300 mg/kg, respectively. Soil samples collected under the product lines contained at 430 mg/kg TPH-g (PL-1), MTBE at 4.7 mg/kg and BTEX at 0.16 mg/kg, 0.02 mg/kg, 2.1 mg/kg, and 3.6 mg/kg, respectively. Soil samples collected under the dispenser islands contained 2,100 mg/kg TPH-g, 13 mg/kg MTBE and BTEX at 2.0 mg/kg, 20 mg/kg, 30 mg/kg, and 170 mg/kg, respectively. The highest product line (PL-1) and dispenser island soil confirmation sample concentrations (DP-1) were from the southeast dispenser pump area. This area was over-excavated up to 10 ft bgs, with confirmation samples still containing 19 mg/kg TPH-g, 7.7 mg/kg MTBE, and BTEX at 0.4 mg/kg, 0.81 mg/kg, 0.42 mg/kg, and 2.6 mg/kg, respectively. The excavations were reportedly backfilled with clean pea gravel (Delta, 2/2/2001).

On May 5, 2001 Delta conducted soil sampling during the removal and upgrade of a sump within the service station building. A Delta representative collected one soil core sample at two feet below the bottom of the sump following its removal. Laboratory analysis of the soil sample reported 305 mg/kg TPH-g, 465 mg/kg TPH-d, and 543 mg/kg TRPH. No concentrations of benzene, toluene or MTBE were detected above the laboratory reporting limits. Minor to trace concentrations of ethylbenzene, total xylenes, sec-butylbenzene, p-isopropyltoluene, naphthalene, 2-methylnaphthalene, n-propylbenzene, 1,2,4-trimethylbenzene, and 1,3,5-trimethylbenzene (Delta, 8/9/2001).

In January 2002, Delta conducted a three-day dual-phase soil vapor and groundwater extraction (DPE) pilot test from the vapor extraction well VW-2, and then limited DPE pilot tests from monitoring wells MW-2 and MW-7. Water levels typically decreased several feet in the extraction wells and exhibited varied responses in the observation wells. Estimated average vapor-phase removal rates were 11.6 pounds of TPH-g per day from well VW-2 and 7.32 pounds of TPH-g per day from well MW-7. Grab groundwater samples collected showed a decreasing trend in petroleum hydrocarbon concentrations from well VW-2 during the short-term pilot test. Concentrations of petroleum hydrocarbons in soil vapor before and after the pilot tests remained approximately the same order of magnitude. A total of 14,900 gallons of water was extracted during the DPE pilot test. Delta concluded that limited DPE was possible at the Site. Even though in the short term they admitted that DPE was limited in its ability to quickly lower groundwater levels to expose impacted soils for soil vapor extraction (SVE), they hypothesized that given enough time of system operation it was reasonable to expect that the groundwater levels could be adequately lowered. Furthermore, Delta admitted that even though significant hydrocarbon vapor recovery rates might not be reasonably expected from DPE due to the fine-grained soils, the overall effect of reducing the groundwater levels in itself might allow the soils to be exposed to atmospheric oxygen from SVE, which in turn might enhance the natural attenuation of the impacted soils and groundwater. The test also indicated that just those wells completed in finer-grained materials onsite would be effective in a DPE system, whereas monitoring well MW-2 would not serve as a practical DPE well due to its excessive groundwater production rates (Delta, 7/16/2002).

On November 26, 2003 URS observed the installation of onsite monitoring well MW-8. Eight soil samples were collected from the borehole advanced prior to the installation of well MW-8 with a maximum concentration of 150 mg/kg TPH-g at 16.5 ft-bgs. On March 20 and 21, 2004 URS observed the drilling of six off-site borings (H-1 through H-5 and SB-1) and one on-site boring (SB-2) using direct-push technology. Five of the seven borings (H-1 through H-5) had sufficient groundwater for grab samples. Grab groundwater samples were collected from H-1, H-2, and H-3 while multiple depth-discrete groundwater samples were collected from borings H-4 and H-5. Borings SB-1 and SB-2 were advanced for lithologic logging purposes and were not sampled. Groundwater samples H-1, H-2, and H-5 at 40 feet bgs contained Gasoline Range Organics (GRO) at 820 micrograms per liter ( $\mu\text{g/L}$ ), 260,000  $\mu\text{g/L}$  and 53  $\mu\text{g/L}$ , respectively. Grab groundwater sample H-2 also contained ethylbenzene at 5,800  $\mu\text{g/L}$ , total xylenes at 11,000  $\mu\text{g/L}$ , and MTBE 7,600  $\mu\text{g/L}$ . Depth-discrete groundwater sample H-4 at 27 ft bgs also contained 0.72  $\mu\text{g/L}$  total xylenes. Benzene, toluene, ethanol, tert-butyl alcohol (TBA), diisopropyl alcohol (DIPE), ethyl tert-butyl ether (ETBE), tert-amyl methyl ether (TAME), 1,2-dichloroethane (1,2-DCA), and 1,2-dibromomethane (EDB) were not detected above the various laboratory reporting limits (URS, 5/6/2004).

During the First Quarter of 2007, a DPE system was started up at the Site that extracted soil vapor and groundwater from wells V-1, V-2, V-3, MW-1, MW-2 (groundwater extraction only), MW-3 and MW-7. The DP system operated until September 2009, when it was shut down due to asymptotic mass removal rates (Broadbent, 2009b). In July 2012 the DPE system, which had been sitting idle since 2009, was removed. All equipment was removed and properly disposed of by Belshire Environmental.

## **2.3 Regional Geology and Hydrogeology**

According to the *East Bay Plain Groundwater Basin Beneficial Use Evaluation Report* (California Regional Water Quality Control Board – San Francisco Bay Region/SFRWQCB, June 1999), the Site is located within the San Leandro Sub-Area, near the northern boundary of the San Lorenzo Sub-Area, in the East Bay Plain of the San Francisco Basin. These Sub-Areas share the same hydrogeologic characteristics, yet are separated by the junction of the surface trace between the San Leandro and San Lorenzo alluvial fans. These Sub-Areas consist primarily of alluvial fan sediments with the distinction of the Yerba Buena Mud extending west into the San Leandro and San Lorenzo Sub-Areas, unlike the northern Sub-Areas. The Yerba Buena Mud forms a major aquitard between the shallow and deep aquifers throughout much of southwestern area of the East Bay Plain. The San Leandro and San Lorenzo Sub-Areas alluvial fans are finer grained and produce less groundwater than the Niles Cone basin to the south.

Geologic data derived from on-site borings indicate unconsolidated sediments consisting of silts and clays from two to 40 feet bgs. Poor and well graded sands, and sandy clays zone underlies and overlies these silty clays and silts. Soil boring and well construction logs are provided in Appendix C. Copies of geologic cross-sections for the Site are provided in Appendix D.

## **3.0 PROPOSED SCOPE OF WORK**

This scope of work is being proposed in order to move this Site towards closure based on the new Low Threat UST Closure Policy. Broadbent proposes to complete site characterization in a phased approach. The first phase of this investigation will consist of six off-site borings. Additional activities have been proposed to close Site data gaps and evaluate the potential effects of Site impacts to offsite receptors. To determine the downgradient extent of hydrocarbons in groundwater, the scope of work presented herein is being proposed. A description of the proposed activities is presented below.

### **3.1 Confirmation Soil Sampling**

The January 14, 2013 ACEH Email recommended additional confirmation soil sampling near former source areas in order to confirm that the former DPE system has effectively remediated that soil in the source area in the upper 10 feet of the subsurface. However, a cursory review of available previous soil sampling data (Appendix C) indicates that samples collected from the upper 10 feet of the subsurface at the Site do not contain petroleum compounds in excess of the values listed in Table 1 of the Low Threat UST Closure Policy. The highest concentration of benzene reported above 10 feet bgs was 2 mg/kg detected during product line sampling. The highest ethylbenzene concentration was reported at 30 mg/kg also during product line sampling. Volatile organic compounds (VOCs) including naphthalene were not reported in any soil sample collected during the waste-oil tank removal, including soil samples collected above 10 feet bgs. It appears that the large majority of hydrocarbon mass was originally present in groundwater and in the smear zone of approximately 12 to 17 feet bgs. This assumption is consistent with the major primary source at the Site as the former USTs. The base of these USTs extended below the water table, where the mass was primarily released. The former DPE system has effectively reduced the hydrocarbon mass in groundwater, as noted in the January 14, 2013 ACEH Email. For these reasons, confirmation sampling of shallow soils near the former source areas is not recommended.

### **3.2 Sensitive Receptor Survey**

Preliminary results of a Sensitive Receptor Survey (SRS) performed by Closure Solutions, Inc. indicated potential private-use wells are located downgradient of the Site. One potential downgradient well located approximately 820 feet northwest (downgradient) of the Site. In addition to the SRS activities already conducted by Closure Solutions (which included a Department of Water Resources records request), additional SRS activities are planned including inquiring with Alameda County for the locations and/or uses of any wells in the vicinity of the Site. In addition, an effort will be made to contact the residents of the address where wells are suspected to be located, and determine the presence and/or purpose and extent of its use, as described below in Section 3.2. The final SRS report will be submitted upon completion of these activities and review of all SRS data collected. Additional groundwater sampling locations have been added to the scope of work since the October 2012 Revised Work Plan was submitted. These additional borings have been added to the scope of work to further evaluate impacts to potential offsite receptors. The data from the SRS and current investigation, plus an evaluation of previous data, will be included in the report following field activities. As previously discussed with the ACEH, this report will include an updated Conceptual Site Model (CSM).

### **3.3 Vapor Intrusion to Indoor Air**

Per ACEH's request, Broadbent evaluate the need for a vapor intrusion to indoor air assessment located on parcels downgradient and potentially impacted by the Site contaminants. Broadbent will evaluate this investigation after the current phase of work. The necessity and potential scope of any soil vapor sampling will be highly dependent on current hydrocarbon concentrations in soil and groundwater downgradient of the Site, which will not be understood until the currently proposed investigation is completed. If the results of the currently proposed offsite investigation indicated that a vapor an offsite vapor intrusion study is necessary, the forthcoming CSM/report will include a work plan for this assessment.

### **3.4 Additional Monitoring Well Sampling**

Soil samples were historically collected at the time of waste oil tank removal (see Section 2.2), and these samples were tested for a variety of analyses including VOCs and poly aromatic hydrocarbons (PAHs). However, the reporting limits at the time were elevated, and groundwater in the area has not been analyzed for these compounds. Data collected to date indicates that naphthalene is not present in soil above 10 ft bgs above concentrations listed in the Low Threat UST Closure Policy, and little if any was ever present in groundwater due to the non-detect historic soil concentrations. However concentrations of VOCs and PAHs in groundwater have not been evaluated explicitly. Although the existing data strongly indicates that "the unauthorized release consists only of petroleum"(CRWQCB, 2012), a one-time additional sampling effort is recommended to definitively confirm the absence of non-petroleum related VOCs and or PAHs in groundwater.

The additional sampling is proposed to be carried out during regularly scheduled semi-annual groundwater monitoring activities. The additional sampling will entail collecting samples for a full list of VOCs by EPA Method 8260B and PAHs for EPA Method 8270 for monitoring well MW-3 (nearest to the former waste oil tank). Additional sampling (i.e – additional monitoring wells and/or during additional monitoring events) will be evaluated based on the results of the one-time additional sampling in well MW-3.

### **3.5 Proposed CPT Boring Locations and Data Objectives**

The purpose of the proposed soil and groundwater investigation is to further characterize groundwater downgradient of the onsite source area and evaluate groundwater conditions in the vicinity of offsite receptors. Onsite soil and groundwater conditions were initially characterized in 1994 by GSI and in 1995 by EMCON as described in previous sections. Characterization of the Site is incomplete due to the lack of monitoring points directly downgradient of the suspected source area.

Broadbent proposes advancing six soil borings using cone penetration technology (CPT) at locations shown on Drawing 3.

- Boring SB-1 is proposed to be located approximately 20 feet south of former boring H-2 on the First Christian Church and Community Center property. Proposed boring SB-1 will enable collection of current soil and groundwater data near former boring H-2 which contained high petroleum concentrations in grab-groundwater at the time of collection.
- Boring SB-2 is proposed to be located on Douglas Court in a residential area west of the Site and is intended to define the downgradient extent of hydrocarbons in groundwater.
- At the request of ACEH, advancement of soil boring SB-3 is proposed at the offsite property of 1290 Davis Street and is intended to define hydrocarbon impacts directly west of the Site.
- Borings SB-4, SB-5, and SB-6 are proposed to be advanced in the driveway of the First Christian Church and Community Center. Boring SB-4 will be approximately located between former borings H-2 and H-3; boring SB-5 will be approximately located between former borings H-3 and H-4. Boring SB-6 is proposed a few feet east of former boring H-1.

The proposed boring locations are shown in Drawing 3. The proposed boring locations are preliminary, and may be subject to change in order to obtain the necessary clearance from underground and above-ground utilities per Broadbent's drilling and utility clearance policy.

Broadbent will make an attempt to obtain offsite access from the property owners at the Liberty Fitness building located at 1290 Davis Street (boring SB-3). If access is unsuccessful, Broadbent will move forward with the remaining scope of work.

### **3.6 Preliminary Activities, Permitting, and Notifications**

Broadbent has historically obtained for offsite access agreements with the private property owners at boring location SB-1, SB-4, SB-5, and SB-6. An encroachment permit with the City of San Leandro will be secured prior to drilling boring SB-2 in the public right of way. Access will also be pursued at the property where boring SB-3 is proposed, as noted above. Prior to initiating field activities, Broadbent will obtain the necessary permits from Alameda County; prepare a site health and safety plan (HASp) for the proposed work; clear the Site for subsurface utilities; and provide 72-hour advance written notification to ACEH prior to start of field activities. The utility clearance will include notifying Underground Service Alert (USA) of the pending work a minimum of 48 hours prior to initiating the field investigation, and securing the services of a private utility locating company to confirm the absence of underground utilities at the boring location. Boreholes will be physically cleared to 6.5 ft bgs and 110% of the CPT rod diameter using hand auger or air knife methods, in accordance with the Broadbent's Ground Disturbance Defined Practice.

The Site-specific HASP will be prepared for use by personnel implementing the work plan. A copy of the HASP will be available on-site during work. Additionally, ARC requires the completion of a detailed Job Safety Analysis (JSA) and Work Risk Assessment Tool (WRAT) prior to the commencement of field activities. The subcontractor(s) performing field activities will be provided with a copy of the HASP prior to initiating work. Safety tailgate meetings will also be conducted to review potential hazards and scope of work.

Prior to drilling activities, the potential presence of nearby water wells, specifically the potential domestic well, will be evaluated. This will be achieved by conducting a mailer survey within a 1000-foot radius of the Site. The mailer survey will include questions regarding the presence and use of wells at the specified address. The results of this survey will be included in the forthcoming investigation report.

### **3.7 Soil Boring Activities**

A Broadbent field geologist will observe a California-licensed drilling company advance the soil borings using a direct-push CPT rig to a proposed total approximate depth of 30 ft bgs. Soils will be logged by the contractor using the CPT designated soil behavior types. These soil behavior types are based on measurements made by the CPT rig including sleeve friction, tip friction, and pore pressure. Soil borings SB-1 through SB-6 will be logged beginning at a depth of 6.5 feet following borehole clearance, until total depth. The soil samples from the capillary fringe within each boring will be collected and submitted to the laboratory for chemical analysis. For each soil boring, historic encountered groundwater will be evaluated to observe possible fluctuations relative to historical measurements and samples will be collected in top and bottom of the suspected smear zone and analyzed as described below. One grab-groundwater sample from each boring will be collected and submitted to the laboratory for chemical analysis using a hydropunch-type sampler. This type of groundwater sample allows a specific interval of groundwater to be isolated. A small-diameter bailer or tubing is lowered into the CPT rods into the isolated interval, where a groundwater sample can be collected. Upon completion, the soil borings will be abandoned by filling cement bentonite grout mix from the bottom of the borehole to the surface. Field Methods for soil borings are included in Appendix E.

#### **3.7.1 Soil Sample Collection and Analysis**

Soil samples collected in brass sleeves for laboratory analysis will be capped with Teflon tape and plastic caps, placed on ice and submitted under chain-of-custody protocol to TestAmerica Environmental Laboratories, Inc. of Irvine, California, a State-certified environmental laboratory. Soil samples will be analyzed for GRO (hydrocarbon chain lengths of C6-12) by EPA Method 8015B; BTEX, MTBE, TBA, TAME, ETBE, DIPE, EDB, 1,2-DCA, and Ethanol by EPA Method 8260. The January 14, 2013 ACEH email additionally requested that ethylene dichloride (EDC) be analyzed. However, this compound is the same as 1,2-DCA, which had already been proposed.

#### **3.7.2 Groundwater Collection and Analysis**

Groundwater samples will be collected in a 45 mL Volatile Organic Analysis (VOA) vial preserved with hydrochloric acid, placed on ice, and submitted under chain-of-custody protocol to TestAmerica Environmental Laboratories, Inc. of Irvine, California, a State-certified environmental laboratory. Groundwater samples collected during this phase of investigation will be analyzed for the following: for GRO (hydrocarbon chain lengths of C6-12) by EPA Method 8015B; BTEX, MTBE, TBA, TAME, ETBE, DIPE, EDB, 1,2-DCA, and Ethanol by EPA Method 8260. The January 14, 2013 ACEH email additionally

requested that ethylene dichloride (EDC) be analyzed. However, this compound is the same as 1,2-DCA, which had already been proposed.

### **3.7.3 Investigation-Derived Waste**

Investigation-derived residuals will be temporarily stored onsite in 55-gallon, DOT-approved drums, pending characterization for proper management. Broadbent will coordinate the removal and transportation of surplus soils and liquids to appropriate California-regulated facilities.

### **3.8 Soil and Groundwater Investigation Report**

Upon completion of field activities, Broadbent will prepare a Soil and Groundwater Investigation Report and updated CSM. The report will document the results of the investigation, field activities, copies of required permit(s), copies of field notes, soil boring logs, laboratory analytical reports with copies of chain-of-custody records, discussion of findings, conclusions and recommendations. Deviations from this Work Plan or data inconsistencies will be discussed in the report. Broadbent will additionally evaluate the SRS results in this report/CSM following the investigation. Existing monitoring well MW-8 will be evaluated in CSM /report following the investigation.

### **4.0 PROPOSED SCHEDULE**

The schedule for the above-noted work shall proceed as follows:

- Implementation of Soil and Groundwater Investigation – Within 60 days following successful negotiation of access agreements and approval of this Work Plan
- Soil & Groundwater Investigation Report– Within 90 days following successful negotiation of access agreements and approval of this work plan

Due to the unknown amount of time necessary to successfully negotiate offsite access agreements with the private property owners, Broadbent suggests that strict calendar dates not be immediately established in the anticipated work plan approval letter, but instead be established after Broadbent immediately notifies ACEH that offsite access with the private property owners has been secured. If a signed access agreement is not in place within 90 days following approval of this work plan by the ACEH, assistance with access agreement negotiations from the ACEH will be requested.

### **5.0 LIMITATIONS**

The findings presented in this document are based upon: observations of field personnel from previous consultants, the points investigated, and results of analytical tests performed by various laboratories. Our services were performed in accordance with the generally accepted standard of practice at the time this document was written. No other warranty, expressed or implied was made. This report has been prepared for the exclusive use of BP. It is possible that variations in soil or groundwater conditions could exist beyond points explored in this investigation. Also changes in site conditions could occur in the future due to variations in rainfall, temperature, regional water usage, or other factors.



## 6.0 REFERENCES

- Alameda County Environmental Health (ACEH). January 14, 2013. *Email from Dilan Roe to Kristene Tidwell regarding Atlantic Richfield Company Station #2111, 1156 Davis Street, San Leandro, California; ACEH Case #RO0000494.*
- Broadbent & Associates, Inc., 31 August 2009 (Broadbent, 2009a). *Soil & Ground-Water Investigation Work Plan, Atlantic Richfield Company Station #2111, 1156 Davis Street, San Leandro, California; ACEH Case #RO0000494*
- Broadbent & Associates, Inc., 30 October 2009 (Broadbent, 2009b). *Third Quarter 2009 Ground-Water Monitoring and Remediation System Status Report, Atlantic Richfield Company Station #2111, 1156 Davis Street, San Leandro, California; ACEH Case #RO0000494*
- Delta Environmental Consultants, Inc., 2 February 2001. *Tank Basin, Product Line and Dispenser Island Sampling Results, ARCO Station No.2111, 1156 Davis Street, San Leandro, California.*
- Delta Environmental Consultants, Inc., 9 August 2001. *Sump Sampling Results, ARCO Service Station No.2111, 1156 Davis Street, San Leandro, California.*
- Delta Environmental Consultants, Inc., 16 July 2002. *Results of a Dual Phase Extraction Pilot Test, ARCO Service Station No.2111, 1156 Davis Street, San Leandro, California.*
- EMCON, 19 September 1996. *Soil and Groundwater Assessment Report, ARCO Service Station 2111, San Leandro, California.*
- EMCON, 8 November 1995. *Site Characterization, ARCO Service Station 2111, 1156 Davis Street, San Leandro, California.*
- GeoStrategies, Inc., 4 October 1993. *Letter Report of The Results of Soil Sampling Associated with Hydraulic Hoist Removal at ARCO Station 2111, 1156 Davis Street in San Leandro, California.*
- GeoStrategies, Inc., 13 April 1994. *Report of Initial Subsurface Investigation, ARCO Station 2111, 1156 Davis Street, San Leandro, California.*
- GeoStrategies, Inc., 27 September 1994. *Report for Waste-Oil Tank Removal Activities at ARCO Station 2111, 1156 Davis Street, San Leandro, California.*
- URS Consultants, Inc., 6 May 2004. *Additional Subsurface Investigation Report, ARCO Service Station #2111, 1156 Davis Street, Hayward [sic], California.*



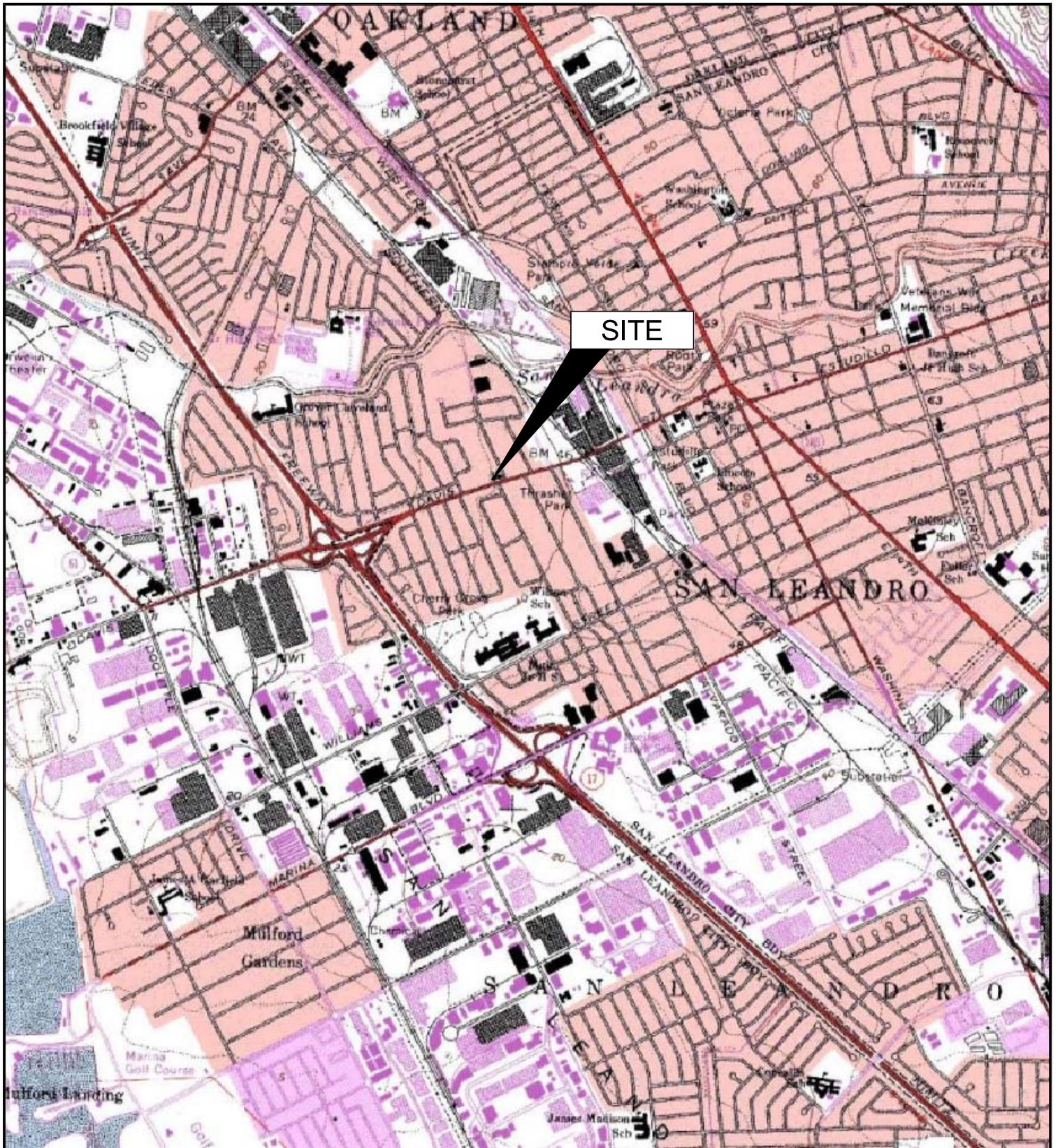

IMAGE SOURCE: USGS









**LEGEND**

- PROPOSED CPT BORING LOCATION
- MONITORING WELL
- VAPOR EXTRACTION WELL
- SOIL BORING LOCATION
- HYDROPUNCH LOCATION
- DESTROYED WELL

NOTE: SITE MAP ADAPTED FROM DELTA ENVIRONMENTAL FIGURES. SITE DIMENSIONS AND FACILITY LOCATIONS NOT VERIFIED.

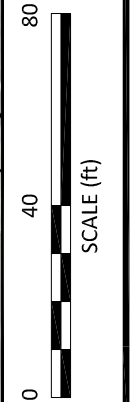

APPENDIX A

Recent Regulatory Correspondence



## Kristene Tidwell

---

**From:** Kristene Tidwell  
**Sent:** Monday, February 18, 2013 3:59 PM  
**To:** dilan.roe@acgov.org  
**Subject:** FW: Fuel Leak Case RO0000494, ARCO Station #2111

---

**From:** Roe, Dilan, Env. Health [mailto:Dilan.Roe@acgov.org]  
**Sent:** Monday, January 14, 2013 7:39 PM  
**To:** Kristene Tidwell  
**Cc:** Couch, Shannon L. (URS) (Shannon.Couch@bp.com); Matt Herrick  
**Subject:** Fuel Leak Case RO0000494, ARCO Station #2111

Hi Kristine:

Thank you for the recently submitted document prepared by Broadbent and Associates, Inc. (Broadbent) on behalf of Atlantic Richfield Company (ARCO) entitled, "*Revised Soil & Groundwater Investigation Work Plan*" (Revised Work Plan), dated November 6, 2012, for the ARCO Station No. 2111, Fuel Leak Case No. RO0000494. Alameda County Environmental Health (ACEH) staff has reviewed the proposed Work Plan in conjunction with our review of the case under the State Water Resources Control Board's Low Threat Underground Storage Tank Case Closure Policy (LTCP).

The Work Plan is intended to supersede the initial *Soil and Groundwater Investigation Work Plan*, dated August 31, 2009, prepared by Broadbent on behalf of ARCO in response to a September 24, 2009 directive letter from ACEH. ACEH concurs with Broadbent's assertion that "since 2009, site conditions, regulatory oversight, and the regulations have changed" and therefore a Revised Work Plan was necessary to address these changes". The operation of the dual-phase extraction system from 2007 until September 2009 appears to have effectively reduced petroleum hydrocarbon contaminant mass in soil and groundwater as indicated by decreasing trends in contaminants detected in groundwater samples collected from on-site monitoring wells.

Based on ACEH's review of the Work Plan and the case files, and our discussions during the meetings held on October 9, 2012 and January 11, 2013 with representatives from ACEH, Broadbent, and ARCO, we request that you resubmit the work plan to address the data gaps and technical comments listed below in order to move the site towards case closure under the LTCP.

- **Soil Boring Locations** - Broadbent states that the initial *Soil and Groundwater Investigation Work Plan*, dated August 31, 2009, and prepared by Broadbent on behalf of ARCO, was prepared in response to a July 9, 2009 directive letter from ACEH. Broadbent further states that the August 31, 2009 work plan, which included installation of three off-site groundwater monitoring wells, was approved by ACEH but never implemented due to off-site access issues on neighboring property. However, a review of the case file indicates that ACEH requested an addendum to the work plan in a directive letter dated September 24, 2009 to justify proposed monitoring well construction (15 foot screen intervals) and groundwater sample representativeness.

In the Revised Work Plan, Broadbent proposes to install two soil borings rather than the three groundwater monitoring wells originally proposed in the August 31, 2009 Work Plan to determine the downgradient extent of hydrocarbons in groundwater. Boring SB-1 is proposed to be located in the general vicinity of the previously proposed monitoring well MW-11, approximately 20 feet south of former boring H-2 on the First Christian Church and Community property. Boring SB-2 is proposed to be located on Douglas Court in a residential area west of the Site, and corresponds to the location of the originally proposed monitoring well MW-10.



A review of historic groundwater elevation maps indicates the direction of groundwater flow at the site has ranged from southwest to northwest. However, no boring is proposed in the Revised Work Plan in the vicinity of the originally proposed monitoring well MW-9 (i.e., within the Liberty Fitness parking lot southwest of the site) due to unsuccessful attempts by ACEH, Broadbent and ARCO to obtain offsite access from the property owners at 1290 Davis Street. ACEH recommends ARCO and Broadbent make a final attempt to gain access to the property for advancement of a third boring in the location previously proposed in the August 31, 2009 work plan. ACEH will assist in this matter by writing a second letter to the Jaheh's requesting access to their property for the purpose of conducting a subsurface investigation.

Additionally, ACEH recommends advancing an additional boring in the vicinity of boring H-4/H-5 to define the extent of the groundwater plume and potential impacts on the residences located downgradient in the west-northwest direction.

- **Well Survey** –According to a well survey conducted in 1996 (based on the County of Alameda Public Works Agency database) 43 irrigations wells, 6 industrial supply wells, and 4 domestic supply wells are within ½ mile radius of the site. Wells identified downgradient of the site included several active irrigation and industrial wells and one domestic supply well. The downgradient domestic supply well (#2S/3W 27R-7) was reported to be located approximately 650 feet west-southwest of the site. ACEH understands a new well survey has been conducted by Closure Solutions, Inc. on behalf of ARCO. Due to off-site access issues, ACEH recommends Broadbent evaluate the results of the new well survey and identify the location of additional borings into the Work Plan if appropriate and/or develop a well sampling plan to rule out the possibility that downgradient wells have been impacted by the site.
- **Soil Sample Collection** - Broadbent proposes to advance the soil borings using direct-push technology to a proposed total approximate depth of 25 feet below ground surface (bgs). Soil samples will be collected from borings at three-foot intervals, beginning at a depth of 6.5 feet bgs following borehole clearance with an air knife or hand auger methods until total depth. The soil samples from above the first encountered groundwater (capillary fringe) within each boring will be submitted to the laboratory for chemical analysis. ACEH understands that the depth to groundwater has historically ranged from approximately to 12 feet bgs to 24 feet bgs. Therefore, please prepare a scope of work to submit soil samples collected within the entire extent of the smear zone to the laboratory for chemical analysis.
- **Groundwater Sample Collection** – Broadbent proposes to collect one grab-groundwater sample from each boring for submittal to the laboratory for chemical analysis using a hydropunch-type sampler. Although ACEH agrees that this type of groundwater sample allows a specific interval of groundwater to be isolated, ACEH is concerned that due to the low permeability of the soil and difficulties collecting depth discrete groundwater samples during the 2004 field investigation, the proposed use of direct push technology may not provide sufficient delineation of the subsurface conditions and groundwater plume and adequately define permeable layers extending in the vicinity and down-gradient beyond boring H-2 which contained high petroleum concentrations in grab groundwater at the time it was collected in 2004. Please prepare a scope of work using cone penetration technology (CPT) to adequately delineate the vertical distribution of soil and groundwater impacts and identify locations for collection of depth discrete groundwater samples.
- **Soil Sample Analysis** – Broadbent proposes to analyze soil samples collected from borings SB-1 and SB-2 for gasoline range organics (hydrocarbon chain lengths of C6 – 12) by EPA Method 8015B, and benzene, toluene, ethyl benzene, and xylenes (BTEX), methyl tertiary-butyl ether (MTBE), t-butyl alcohol (TBA), tert-amyl-methyl ether (TAME), ethyl tert-butyl ether (ETBE), di-isopropyl ether (DIPE), ethylene dibromide (EDB), 1,2,- DCA, and ethanol by EPA Method 8260. Please include ethylene dichloride (EDC) in the list of analytes for soil samples.
- **Groundwater Sample Analysis** - ACEH also notes that Broadbent does not propose specific analytes for groundwater samples. Please revise the Work Plan to include appropriate analytes for groundwater. Additionally, please collect and analyze groundwater samples from the proposed soil borings SB-1 and SB-2 and



existing groundwater monitoring wells for volatile organic compounds, polycyclic aromatic hydrocarbons (PAHs) and naphthalene by EPA Method 8260 in order to close the data gap on potential impacts from the waste oil tank removed in 2004 due to laboratory reporting limits being greater than the environmental screening limits for these analytes.

- **Existing Monitoring Well MW-8** – A review of the construction log and historic groundwater elevation data for monitoring well MW-8 indicates the well may not be screened appropriately to adequately characterize groundwater conditions. Please present an analysis of this data and make conclusions regarding the validity of data collected from this well and recommendations for corrective action if appropriate.
- **Confirmation Sampling** – As indicted above, ACEH concurs that operation of the dual-phase extraction system from 2007 until September 2009 appears to have effectively reduced petroleum hydrocarbon contaminant mass in soil and groundwater as indicated by decreasing trends in contaminants detected in groundwater samples collected from on-site monitoring wells. ACEH recommends collection of confirmation sampling in the source areas to verify that the site satisfies the LTCP media specific criteria for Direct Contact and Outdoor Air Exposure in the upper ten feet of soil. Please note, in lieu of this data, the LTCP allows closure under the LTCP if the maximum concentration of petroleum constituents in soil are less than levels that a site specific risk assessment demonstrates will have no significant risk of adversely affecting human health or the regulatory agency determines that the concentrations of petroleum constituents in soil will have no significant risk of adversely affecting human health as a result of controlling exposure through the use of institutional controls (i.e., land use restrictions, etc).
- **Field Investigation Standard Operating Procedures** – The Work Plan does not provide a description of the proposed methods for collection of soil and groundwater samples. Please include Broadbent's standard operating procedures in an appendix to the Work Plan.
- **Site Figures** – As requested in ACEH's Directive Letter dated July 9, 2009, please prepare site maps which utilize aerial photographs as base maps for the site, and accurately depict neighboring structures and site features in relation to the groundwater contaminant plume in all future reports.
- **Vapor Intrusion to Indoor Air** – Although the site is an active commercial petroleum fueling facility, it does not qualify for an exemption from the LTCP Media Specific Criteria for Vapor Intrusion to Indoor Air due historic off-site migration of the petroleum hydrocarbon groundwater plume and potentially impacted adjacent residential and commercial parcels. Evidence of historic off-site migration can be found in free product observations in MW-2, soil and groundwater analytical data collected from the off-site monitoring well MW-5 and the onsite perimeter monitoring well network, and depth-discrete and grab groundwater samples collected from offsite borings H-1 through H-5. Please prepare a work plan to collect and analyze the data required to evaluate vapor intrusion to indoor air impacts on buildings located on parcels potentially impacted by the site using one of the three petroleum vapor intrusion to indoor air specific criteria in the LTCP criteria (i.e., survey of building foundations, characterization of bioattenuation zone, direct measurement of soil gas concentrations, or a site specific risk assessment).

ACEH looks forward to working with Broadbent and ARCO in identifying and implementing the steps necessary to move the site to closure under the LTCP as expeditiously as possible. Please submit a schedule with proposed dates to ACEH by **January 25, 2013** for resubmittal and implementation of the Revised Soil and Groundwater Investigation Work Plan, as well as the other phases of work discussed above as deemed necessary to satisfy the LTCP General and Media Specific Criteria (i.e., Groundwater, Vapor Intrusion to Indoor Air, Direct Contact and Outdoor Air Exposure).

Regards,

**Dilan Roe, P.E.**  
Hazardous Materials Specialist





ENVIRONMENTAL HEALTH SERVICES  
ENVIRONMENTAL PROTECTION  
1131 Harbor Bay Parkway, Suite 250  
Alameda, CA 94502-6577  
(510) 567-6700  
FAX (510) 337-9335

July 9, 2009

(Paul Supple (Sent via E-mail to: [paul.supple@bp.com](mailto:paul.supple@bp.com))  
Atlantic Richfield Company  
(A BP Affiliated Company)  
P.O. Box 1257  
San Ramon, CA 94583

Subject: Fuel Leak Case No. RO0000494 and GeoTracker Global ID T0600101764, ARCO  
#2111, 1156 Davis Street, San Leandro, CA 94577

Dear Mr. Supple:

Alameda County Environmental Health (ACEH) staff has reviewed the case file for the above-referenced site including the recently submitted document entitled, "Response To Request For Site Conceptual Model and Soil & Ground-Water Investigation Work Plan," dated June 23, 2009, which was prepared by Broadbent & Associates, Inc. (BAI) for the subject site. In our April 24, 2009 correspondence, ACEH noted that elevated concentrations of hydrocarbons were detected in a "grab" groundwater sample collected in March 2004 from boring H-2, in which a permeable sand unit was identified between 15 to 20 feet bgs. A permeable unit was also identified in MW-7 from approximately 20 feet bgs to its total installed depth of 35 feet bgs. BAI states that "[f]rom review of the available lithologic logs and resultant cross sections, we do not believe the permeable unit (identified as Clayey Sand at MW-7) extends to the H-2 location. Furthermore, the URS cross section C-C' (Figure 4 of the 6 May 2004 report) does not connect the 29-foot deep, two foot thick well-graded Sand (SW) at SB-2 with the much shallower 16-foot deep, four foot thick well-graded sand (SW) found at the boring H-2 location." BAI further states that "[t]o verify or refute this lack of continuity depicted by URS might require additional drilling of multiple borings in the area north of the First Christian Church Community Center building. To extend this level of investigation does not appear to be justified as one may, or may not discover a reliable conclusion of a preferential pathway between the MW-7, SB-2 and H-2 locations."

ACEH's requests that you address the following technical comments work and send us the technical reports requested below

#### **TECHNICAL COMMENTS**

1. **Regional Geologic and Hydrogeologic Setting** – As mentioned above, in our April 24, 2009 correspondence, ACEH stated that elevated concentrations of petroleum hydrocarbons were detected in a "grab" groundwater sample collected in March 2004 from boring H-2, in which a permeable sand unit was identified between 15 to 20 feet bgs. ACEH does not dispute BAI's technical rationale for why they believe the permeable layer identified at MW-7 located on-site does not extend to boring H-2 located off-site. However, ACEH's primary concern is that contaminants may be migrating further off-site through this permeable zone.

BAI did not provide any rationale for why significantly elevated concentrations of TPH-g and MTBE detected at 260,000 µg/L and 7,600 µg/L, respectively, in a “grab” groundwater sample collected from boring H-2 located offsite, if the permeable layer encountered in boring H-2 is not connected in some way to the permeable layer identified at MW-7, located near the source area. Please note that during that same timeframe, groundwater samples collected from monitoring well MW-5 detected TPH-g and MTBE at concentrations of 8,000 µg/L and 2,000 µg/L, respectively, and the highest concentrations of TPH-g and MTBE on-site were detected in well MW-7 at concentrations of 62,000 µg/L and 37,000 µg/L, respectively. Based on the analytical data, the extent of the groundwater contaminant plume appears undefined and a permanent monitoring point in the vicinity of boring H-2 appears warranted in addition to proposed groundwater monitoring wells MW-9 and MW-10. Please propose a scope of work to address the above-mentioned concerns and submit a work plan due by the date specified below. The need for additional boring locations to evaluate the potential for groundwater contaminant migration along preferential pathways (i.e. contaminant flow through permeable zones on and off-site) may be required based on current groundwater contaminant data collected in the immediate vicinity of boring H-2.

2. **Extended Site Figures** - Please note that the figures included in submittals provided to date are insufficient to adequately depict the extent of your contaminant plume in relation to adjacent and neighboring properties. Please prepare extended site maps, which utilize aerial photographs as base maps for your site, and accurately depict neighboring structures and site features in relation to the groundwater contaminant plume in all future reports.

### **NOTIFICATION OF FIELDWORK ACTIVITIES**

Please schedule and complete the fieldwork activities by the date specified below and provide ACEH with at least three (3) business days notification prior to conducting the fieldwork, including routine groundwater sampling.

### **TECHNICAL REPORT REQUEST**

Please submit technical reports to ACEH (Attention: Paresh Khatri), according to the following schedule:

- **July 30, 2009** – Remediation Summary Report (2<sup>nd</sup> Quarter 2009)
- **August 31, 2009** – Soil and Water Investigation Work Plan
- **October 30, 2009** – Semi-annual Monitoring & Remediation Summary Report (3<sup>rd</sup> Quarter 2009)
- **January 30, 2010** – Remediation Summary Report (4<sup>th</sup> Quarter 2009)
- **April 30, 2010** – Semi-annual Monitoring & Remediation Summary Report (1<sup>st</sup> Quarter 2010)

These reports are being requested pursuant to California Health and Safety Code Section 25296.10. 23 CCR Sections 2652 through 2654, and 2721 through 2728 outline the responsibilities of a responsible party in response to an unauthorized release from a petroleum UST system, and require your compliance with this request.

#### ELECTRONIC SUBMITTAL OF REPORTS

ACEH's Environmental Cleanup Oversight Programs (LOP and SLIC) require submission of reports in electronic form. The electronic copy replaces paper copies and is expected to be used for all public information requests, regulatory review, and compliance/enforcement activities. Instructions for submission of electronic documents to the Alameda County Environmental Cleanup Oversight Program FTP site are provided on the attached "Electronic Report Upload Instructions." Submission of reports to the Alameda County FTP site is an addition to existing requirements for electronic submittal of information to the State Water Resources Control Board (SWRCB) GeoTracker website. In September 2004, the SWRCB adopted regulations that require electronic submittal of information for all groundwater cleanup programs. For several years, responsible parties for cleanup of leaks from underground storage tanks (USTs) have been required to submit groundwater analytical data, surveyed locations of monitoring wells, and other data to the GeoTracker database over the Internet. Beginning July 1, 2005, these same reporting requirements were added to Spills, Leaks, Investigations, and Cleanup (SLIC) sites. Beginning July 1, 2005, electronic submittal of a complete copy of all reports for all sites is required in GeoTracker (in PDF format). Please visit the SWRCB website for more information on these requirements ([http://www.swrcb.ca.gov/ust/electronic\\_submittal/report\\_rqmts.shtml](http://www.swrcb.ca.gov/ust/electronic_submittal/report_rqmts.shtml)).

#### PERJURY STATEMENT

All work plans, technical reports, or technical documents submitted to ACEH must be accompanied by a cover letter from the responsible party that states, at a minimum, the following: "I declare, under penalty of perjury, that the information and/or recommendations contained in the attached document or report is true and correct to the best of my knowledge." This letter must be signed by an officer or legally authorized representative of your company. Please include a cover letter satisfying these requirements with all future reports and technical documents submitted for this fuel leak case.

#### PROFESSIONAL CERTIFICATION & CONCLUSIONS/RECOMMENDATIONS

The California Business and Professions Code (Sections 6735, 6835, and 7835.1) requires that work plans and technical or implementation reports containing geologic or engineering evaluations and/or judgments be performed under the direction of an appropriately registered or certified professional. For your submittal to be considered a valid technical report, you are to present site specific data, data interpretations, and recommendations prepared by an appropriately licensed professional and include the professional registration stamp, signature, and statement of professional certification. Please ensure all that all technical reports submitted for this fuel leak case meet this requirement.

Mr. Supple  
RO0000494  
July 9, 2009, Page 4

### **UNDERGROUND STORAGE TANK CLEANUP FUND**

Please note that delays in investigation, later reports, or enforcement actions may result in your becoming ineligible to receive grant money from the state's Underground Storage Tank Cleanup Fund (Senate Bill 2004) to reimburse you for the cost of cleanup.

### **AGENCY OVERSIGHT**

If it appears as though significant delays are occurring or reports are not submitted as requested, we will consider referring your case to the Regional Board or other appropriate agency, including the County District Attorney, for possible enforcement actions. California Health and Safety Code, Section 25299.76 authorizes enforcement including administrative action or monetary penalties of up to \$10,000 per day for each day of violation.

If you have any questions, please call me at (510) 777-2478 or send me an electronic mail message at [paresh.khatri@acgov.org](mailto:paresh.khatri@acgov.org).

Sincerely,

Paresh C. Khatri  
Hazardous Materials Specialist

Enclosure: ACEH Electronic Report Upload (ftp) Instructions

cc: Tom Venus, Broadbent & Associates, 1324 Mangrove Avenue, Suite 212, Chico, CA 95926  
(Sent via E-mail to: [tvenus@broadbentinc.com](mailto:tvenus@broadbentinc.com))  
Donna Drogos, ACEH (Sent via E-mail to: [donna.drogos@acgov.org](mailto:donna.drogos@acgov.org))  
Paresh Khatri, ACEH (Sent via E-mail to: [paresh.khatri@acgov.org](mailto:paresh.khatri@acgov.org))  
GeoTracker  
File

## APPENDIX B

### Historical Soil and Groundwater Data



**EXPLANATION**

● Soil boring

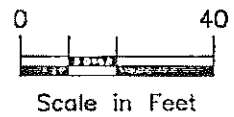
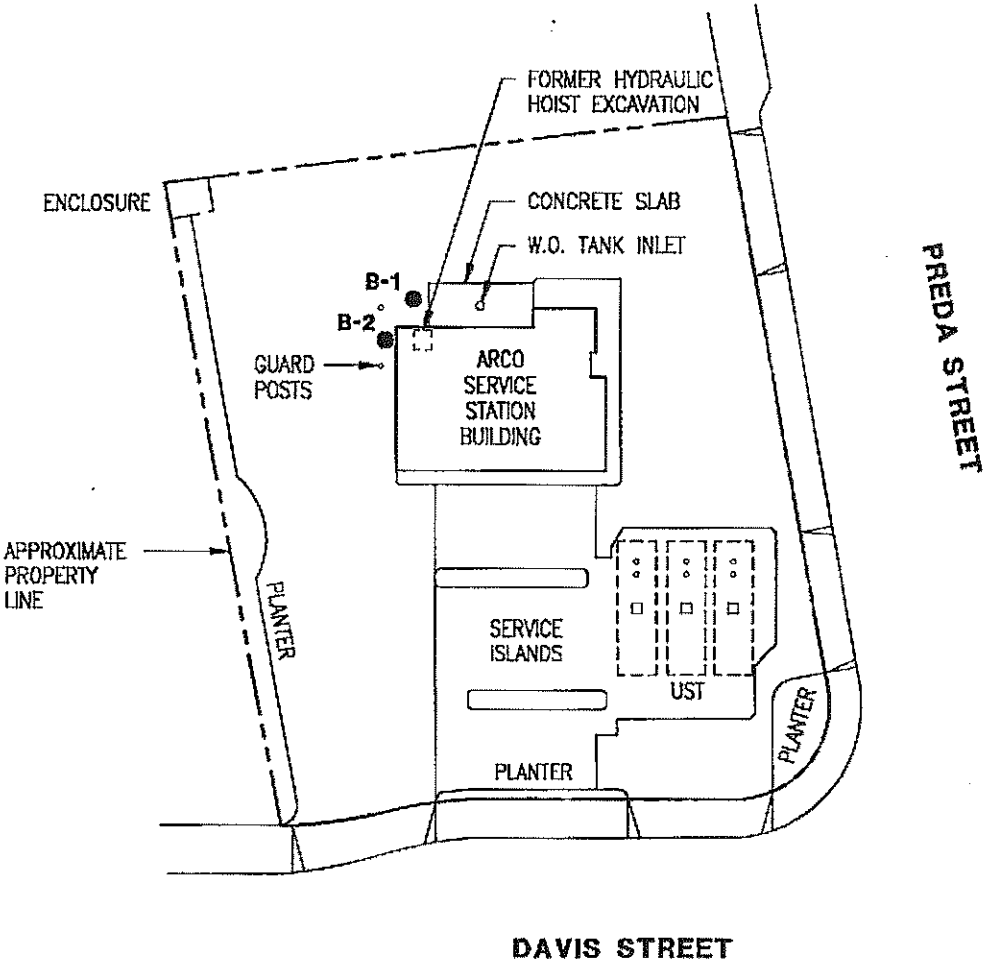

Base Map: ARCO Petroleum Products Company  
conversion to MP & G tune-up  
dwg. dated 6/6/85 sht. 1 of 1



GeoStrategies Inc.

**SITE PLAN**  
ARCO Service Station #2111  
1156 Davis Street  
San Leandro, California

PLATE  
**2**

JOB NUMBER  
7940

REVIEWED BY

DATE  
3/94

REVISED DATE

ARCO Station 2111  
Initial Subsurface Investigation  
7940.03

April 13, 1994

TABLE 2  
RESULTS OF LABORATORY ANALYSES  
OF SOIL SAMPLES - Fuel Fingerprint as Hydraulic Oil  
ARCO Station 2111  
San Leandro, California

Sample ID	Fuel Fingerprint as Hydraulic Oil	TPH-G	BTEX	TCLP BTEX	TCLP TPH-G	STLC Lead	RCI
<u>March 4, 1994</u>							
B1-4.5	3.0*	NA	NA	NA	NA	NA	NA
B1-10	<1.0	NA	NA	NA	NA	NA	NA
B1-15	<1.0	NA	NA	NA	NA	NA	NA
B1-20	1.7**	NA	NA	NA	NA	NA	NA
B2-5	1.7	NA	NA	NA	NA	NA	NA
B2-10	<1.0	NA	NA	NA	NA	NA	NA
B2-15	2.0***	NA	NA	NA	NA	NA	NA
B2-20	11****	NA	NA	NA	NA	NA	NA
CSS-1A-1D	NA	<0.0050	<1.0	<50	<0.5	0.18	NH

All results shown in parts per million (ppm), except TCLP TPH-G and BTEX are shown in parts per billion (ppb). Fuel fingerprint as hydraulic oil was performed using EPA Methods 3550/8015.

TPH-G = Total petroleum hydrocarbons as gasoline using EPA modified Method 8015.  
BTEX = Benzene, toluene, ethylbenzene, and total xylenes using EPA Method 8020.  
TCLP = Toxicity Characteristic Leaching Procedure  
STLC = Soluble Threshold Limit Concentration  
RCI = Reactivity, ignitability, and corrosivity

NH = Non hazardous. Compositd Sample indicated non-reactivity with sulfide, cyanide, and water, a pH of 7.0 and ignitability of greater than 100 degrees centigrade.

\* = Unidentified hydrocarbons greater than C9.  
\*\* = Unidentified hydrocarbons greater ranging from C11 to C15.  
\*\*\* = Discrete peaks - unidentified.  
\*\*\*\* = Unidentified hydrocarbons ranging from C11 to C24.

Sample Identification:

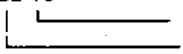
B2-10  

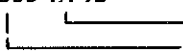
 Sample Depth in Feet  
Soil Boring

CSS 1A-1D  

 Sample Numbers  
Composite Soil Sample



**Table 1**  
**Well Details**  
**ARCO Service Station 2111**

Well ID	Installation Date	Total Depth of Well (feet)	Casing Diameter (inches)	Screened Interval (feet)
MW-1	7/12/95	27.0	4.0	12.5 - 26.2
MW-2	7/12/95	27.0	4.0	12.0 - 26.2
MW-3	7/13/95	27.0	4.0	11.9 - 26.2
MW-4	7/13/95	25.0	4.0	10.0 - 24.0
MW-5	3/1/96	25.0	2.0	9.4 - 23.4
MW-6	3/1/96	25.0	2.0	10.0 - 25.0
MW-7	2/29/96	27.0	4.0	12.0 - 27.0
V-1	2/29/96	20.0	4.0	5.0 - 20.0
V-2	2/29/96	20.0	4.0	5.0 - 20.0
V-3	2/28/96	20.0	4.0	5.0 - 20.0
V-4	2/28/96	20.0	4.0	6.5 - 19.5

Table 2  
 Historical Groundwater Elevation and Analytical Data  
 Petroleum Hydrocarbons and Their Constituents

ARCO Service Station 2111  
 1156 Davis Street, San Leandro, California

Date: 09-17-96

Well Designation	Water Level Field Date	Top of Casing Elevation	Depth to Water	Groundwater Elevation	Flloating Product Thickness	Groundwater Flow Direction	Hydraulic Gradient	Water Sample Field Date	TPHG LUFT Method	Benzene EPA 8020	Toluene EPA 8020	Ethylbenzene EPA 8020	Total Xylenes EPA 8020	MTBE EPA 8020	TRPH EPA 418.1	TPHD LUFT Method
		ft-MSL	feet	ft-MSL	feet	MWN	ft/ft		µg/L	µg/L	µg/L	µg/L	µg/L	µg/L	µg/L	µg/L
MW-1	08-01-95	39.60	17.45	22.15	ND	NR	NR	08-01-95	<50	<0.5	<0.5	<0.5	<0.5	--	--	--
MW-1	12-14-95	39.60	17.09	22.51	ND	W	0.002	12-14-95	<50	<0.5	<0.5	<0.5	<0.5	<3	--	--
MW-1	03-21-96	39.60	14.72	24.88	ND	WSW	0.005	03-21-96	<50	<0.5	<0.5	<0.5	<0.5	<3	--	--
MW-1	05-24-96	39.60	15.94	23.66	ND	W	0.003	05-24-96	<50	<0.5	<0.5	<0.5	<0.5	<3	--	--
MW-1	08-09-96	39.60	17.89	21.71	ND	WNW	0.01	08-09-96	<50	<0.5	<0.5	<0.5	<0.5	<3	--	--
MW-2	08-01-95	37.99	15.67	22.32	ND	NR	NR	08-01-95	23000	1300	310	500	3500	--	--	--
MW-2	12-14-95	37.99	15.36	22.63	ND	W	0.002	12-14-95	7300	900	25	180	1000	<200*	--	--
MW-2	03-21-96	37.99	12.84	25.15	ND	WSW	0.005	03-21-96	9600	850	30	280	1400	250	--	--
MW-2	05-24-96	37.99	14.03	23.96	ND	W	0.003	05-24-96	2300	300	<5*	73	310	<25*	--	--
MW-2	08-09-96	37.99	16.10	21.89	ND	WNW	0.01	08-09-96	2800	290	6	75	320	50	--	--
MW-3	08-01-95	39.32	17.00	22.32	ND	NR	NR	08-01-95	<50	<0.5	<0.5	<0.5	<0.5	--	600	76^
MW-3	12-14-95	39.32	16.70	22.62	ND	W	0.002	12-14-95	<50	<0.5	<0.5	<0.5	<0.5	<3	<500	<50
MW-3	03-21-96	39.32	14.17	25.15	ND	WSW	0.005	03-21-96	<50	<0.5	<0.5	<0.5	<0.5	<3	<500	<50
MW-3	05-24-96	39.32	15.30	24.02	ND	W	0.003	05-24-96	<50	<0.5	<0.5	<0.5	<0.5	<3	<500	<50
MW-3	08-09-96	39.32	17.58	21.74	ND	WNW	0.01	08-09-96	<50	<0.5	<0.5	<0.5	<0.5	<3	<0.5	--
MW-4	08-01-95	38.10	15.65	22.45	ND	NR	NR	08-01-95	<50	<0.5	<0.5	<0.5	<0.5	--	--	--
MW-4	12-14-95	38.10	15.35	22.75	ND	W	0.002	12-14-95	<50	<0.5	<0.5	<0.5	<0.5	<3	--	--
MW-4	03-21-96	38.10	12.74	25.36	ND	WSW	0.005	03-21-96	<50	<0.5	<0.5	<0.5	<0.5	<3	--	--
MW-4	05-24-96	38.10	14.03	24.07	ND	W	0.003	05-24-96	<50	<0.5	<0.5	<0.5	<0.5	<3	--	--
MW-4	08-09-96	38.10	16.10	22.00	ND	WNW	0.01	08-09-96	<50	<0.5	<0.5	<0.5	<0.5	<3	--	--
MW-5	03-21-96	37.21	12.60	24.61	ND	WSW	0.005	03-22-96	<50	<0.5	<0.5	<0.5	<0.5	82	--	--
MW-5	05-24-96	37.21	13.71	23.50	ND	W	0.003	05-24-96	<50	<0.5	<0.5	<0.5	<0.5	7	--	--
MW-5	08-09-96	37.21	15.60	21.61	ND	WNW	0.01	08-09-96	<50	<0.5	<0.5	<0.5	<0.5	8	--	--

**Table 2**  
**Historical Groundwater Elevation and Analytical Data**  
**Petroleum Hydrocarbons and Their Constituents**

ARCO Service Station 2111  
 1156 Davis Street, San Leandro, California

Date: 09-17-96

Well Designation	Water Level Field Date	Top of Casing Elevation	Depth to Water	Groundwater Elevation	Floating Product Thickness	Groundwater Flow Direction	Hydraulic Gradient	Water Sample Field Date	TPHG LUFT Method	Benzene EPA 8020	Toluene EPA 8020	Ethylbenzene EPA 8020	Total Xylenes EPA 8020	MTBE EPA 8020	TRPH EPA 418.1	TPHD LUFT Method
		ft-MSL	feet	ft-MSL	feet	MWN	ft/ft		µg/L	µg/L	µg/L	µg/L	µg/L	µg/L	µg/L	µg/L
MW-6	03-21-96	37.11	11.55	25.56	ND	WSW	0.005	03-22-96	<50	<0.5	1.9	<0.5	<0.5	<3	--	--
MW-6	05-24-96	37.11	12.80	24.31	ND	W	0.003	05-24-96	<50	<0.5	<0.5	<0.5	<0.5	6	--	--
MW-6	08-09-96	37.11	Not surveyed: Car parked on well					08-09-96	Not sampled: Car parked on well							
MW-7	03-21-96	38.68	13.32	25.36	ND	WSW	0.005	03-22-96	32000	870	450	970	4900	280	--	--
MW-7	05-24-96	38.68	14.58	24.10	ND	W	0.003	05-24-96	22000	570	40	42	1900	<200*	--	--
MW-7	08-09-96	38.68	15.33	23.35	ND	WNW	0.01	08-09-96	14000	390	<10*	180	470	<200*	--	--

ft-MSL: elevation in feet, relative to mean sea level  
 MWN: ground-water flow direction and gradient apply to the entire monitoring well network  
 ft/ft: foot per foot  
 TPHG: total petroleum hydrocarbons as gasoline, California DHS LUFT Method  
 µg/L: micrograms per liter  
 EPA: United States Environmental Protection Agency  
 MTBE: Methyl-tert-butyl ether  
 TRPH: total recoverable petroleum hydrocarbons  
 TPHD: total petroleum hydrocarbons as diesel, California DHS LUFT Method  
 NR: not reported; data not available or not measurable  
 ND: none detected  
 W: west  
 WSW: west-southwest  
 NW: northwest  
 ^: chromatogram fingerprint is not characteristic of diesel  
 \*: method reporting limit was raised due to: (1) high analyte concentration requiring sample dilution, or (2) matrix interference  
 -: not available

Table 3

**Soil Analytical Data  
ARCO Service Station 2111**

Sample Identification	Date Sampled	Depth (feet)	TPHG <sup>2</sup>	Benzene	Toluene	Ethylbenzene	Xylenes	TRPH	TPHD
MW-1	7/12/95	6.5	ND	ND	ND	ND	ND	NA	NA
MW-1	7/12/95	11.5	ND	ND	ND	ND	ND	NA	NA
MW-1	7/12/95	16.5	ND	ND	ND	ND	ND	NA	NA
MW-1	7/12/95	21.5	ND	ND	ND	ND	ND	NA	NA
MW-1	7/12/95	26	ND	ND	ND	ND	ND	NA	NA
MW-2	7/12/95	6.5	ND	ND	ND	ND	ND	NA	NA
MW-2	7/12/95	11.5	ND	ND	ND	ND	ND	NA	NA
MW-2	7/12/95	16.5	2	0.045	ND	0.027	0.04	NA	NA
MW-2	7/12/95	19	29	0.26	ND	0.3	1.5	NA	NA
MW-2	7/12/95	21	320	<0.5**	<1**	3.4	1.4	NA	NA
MW-3	7/13/95	6.5	ND	ND	ND	ND	ND	10	ND
MW-3	7/13/95	11	ND	ND	ND	ND	ND	ND	ND
MW-3	7/13/95	14	ND	ND	ND	ND	ND	ND	ND
MW-3	7/13/95	17	ND	ND	ND	ND	ND	ND	ND
MW-3	7/13/95	19.5	ND	ND	ND	ND	ND	ND	ND
MW-3	7/13/95	22.5	ND	ND	ND	ND	ND	ND	ND
MW-3	7/13/95	27.5	ND	ND	ND	ND	ND	ND	ND
MW-3	7/13/95	36	ND	ND	ND	ND	ND	ND	ND
MW-3	7/13/95	40	ND	ND	ND	ND	ND	ND	ND
MW-4	7/13/95	6.5	ND	ND	ND	ND	ND	NA	NA
MW-4	7/13/95	11.5	ND	ND	ND	ND	ND	NA	NA
MW-4	7/13/95	16.5	ND	ND	ND	ND	ND	NA	NA
MW-4	7/13/95	21.5	ND	ND	ND	ND	ND	NA	NA
MW-5	3/1/96	5	ND	ND	ND	ND	ND	NA	NA
MW-5	3/1/96	10	ND	ND	ND	ND	ND	NA	NA
MW-5	3/1/96	15	ND	ND	ND	ND	ND	NA	NA
MW-5	3/1/96	30	ND	ND	ND	ND	ND	NA	NA
MW-6	3/1/96	5	ND	ND	ND	ND	ND	NA	NA
MW-6	3/1/96	10	ND	ND	ND	ND	ND	NA	NA
MW-6	3/1/96	15	ND	ND	ND	ND	ND	NA	NA
MW-6	3/1/96	27	ND	ND	ND	ND	ND	NA	NA

Table 3

Soil Analytical Data  
ARCO Service Station 2111

(continued)

Sample Identification	Date Sampled	Depth (feet)	TPHG <sup>2</sup>	Benzene	Toluene	Ethylbenzene	Xylenes	TRPH	TPHD
MW-7	2/29/96	5.5	ND	ND	ND	ND	ND	NA	NA
MW-7	2/29/96	10	ND	0.01	ND	ND	ND	NA	NA
MW-7	2/29/96	15	1	0.11	ND	0.080	0.90	NA	NA
MW-7	2/29/96	21	55	<0.1*	<0.2*	0.80	1.5	NA	NA
MW-7	2/29/96	33	ND	ND	ND	ND	0.006	NA	NA
VW-1	2/29/96	5.5	ND	ND	ND	ND	ND	NA	NA
VW-1	2/29/96	10.5	ND	ND	ND	ND	ND	NA	NA
VW-1	2/29/96	13	1	0.020	ND	ND	ND	NA	NA
VW-1	2/29/96	19.5	40	0.10	ND	0.50	0.80	NA	NA
VW-2	2/29/96	5.5	ND	ND	ND	ND	ND	NA	NA
VW-2	2/29/96	10.5	ND	ND	ND	ND	ND	NA	NA
VW-2	2/29/96	13	4	0.20	<0.025*	0.080	0.080	NA	NA
VW-2	2/29/96	15.5	18	0.30	<0.05*	0.30	0.40	NA	NA
VW-2	2/29/96	19.5	230	<0.5*	<1*	<1*	2	NA	NA
VW-3	2/28/96	5	ND	ND	ND	ND	ND	NA	NA
VW-3	2/28/96	10	ND	0.020	ND	ND	0.005	NA	NA
VW-3	2/28/96	15	ND	ND	ND	ND	ND	NA	NA
VW-3	2/28/96	19.5	76	<0.1*	<0.2*	0.4	0.8	NA	NA
VW-4	2/28/96	5	ND	ND	ND	ND	ND	NA	NA
VW-4	2/28/96	10.5	12	<0.05*	<0.1*	<0.1*	<0.1*	NA	NA
VW-4	2/28/96	15	1,100	<1*	<2	<2*	3	NA	NA
VW-4	2/28/96	19.5	420	<0.5*	<1*	<1*	3	NA	NA

<sup>1</sup> mg/kg = milligrams per kilogram  
<sup>2</sup> TPHG = total petroleum hydrocarbons as gasoline  
<sup>3</sup> TRPH = total recoverable petroleum hydrocarbons  
<sup>4</sup> TPHD = total petroleum hydrocarbons as diesel  
<sup>5</sup> NA = not analyzed  
< indicates laboratory minimum reporting limit  
\* raised MRL due to high analyte concentration requiring sample dilution

TABLE 1

**ANALYTICAL RESULTS OF SOIL SAMPLES  
COLLECTED FROM BENEATH THE FORMER WASTE-OIL TANK  
AT ARCO STATION 2111  
1155 Davis Street  
San Leandro, California**

Sample ID	Date	Depth feet	TPHmo (ppm)	TPHd (ppm)	TPHg (ppm)	TRPH (ppm)	VOCs (ppm)	PCBs/BNAs (ppm)	Cadmium (ppm)	Chromium (ppm)	Nickel (ppm)	Lead (ppm)	Zinc (ppm)
WO-E	8/15/94	10	<10	<1.0	NA	NA	NA	NA	NA	NA	NA	NA	NA
WO-W	8/15/94	10.5	<10	<1.0	NA	NA	NA	NA	NA	NA	NA	NA	NA
WO-N	8/15/94	14	12	2.8	NA	NA	NA	NA	NA	NA	NA	NA	NA
WO-S	8/15/94	12.5	<10	<1.0	NA	NA	NA	NA	NA	NA	NA	NA	NA
WO-1	8/15/94	9.5	NA	780	310	7,900	<2.5 <0.5	<5.0	0.79	38	34	56	50
WO-B	8/15/94	14.5	800	660	NA	NA	NA	NA	NA	NA	NA	NA	NA
WO-B2	8/16/94	18.5	2,000	400	130	2,500	<2.5	<5.0	0.90	46	8.6	55	53
CCS-1A-1D	9/14/94	—	840	NA	5.7	960	<0.5	<0.5	<0.01	0.13	0.81	0.27	4.4
CCS-2A-2D	9/14/94	—	1,400	NA	6.1	2,300	<0.5	<0.5	0.011	0.11	0.96	1.4	0.63

TPHmo = Total petroleum hydrocarbons reported as motor oil by Standard Method (SM) 5520E&F.

TPHd = Total petroleum hydrocarbons reported as diesel by Environmental Protection Agency (EPA) Methods 5030/8015 (modified).

TPHg = Total petroleum hydrocarbons reported as gasoline by EPA Methods 5030/8015 (modified).

TRPH = Total recoverable petroleum hydrocarbons by SM 5520E&F.

VOCs = Volatile organic compounds by EPA Method 8240.

PCBs/BNAs = Polychlorinated biphenyls and base/acid neutrals by EPA Method 8270.

ppm = Parts per million.

Metals were analyzed using EPA Methods 6010/7010 series.

Notes: 1. All data listed as <x indicates a not detected concentration.

\\Sacramento\CAD Files\Sacramento\ARCO21112111-1

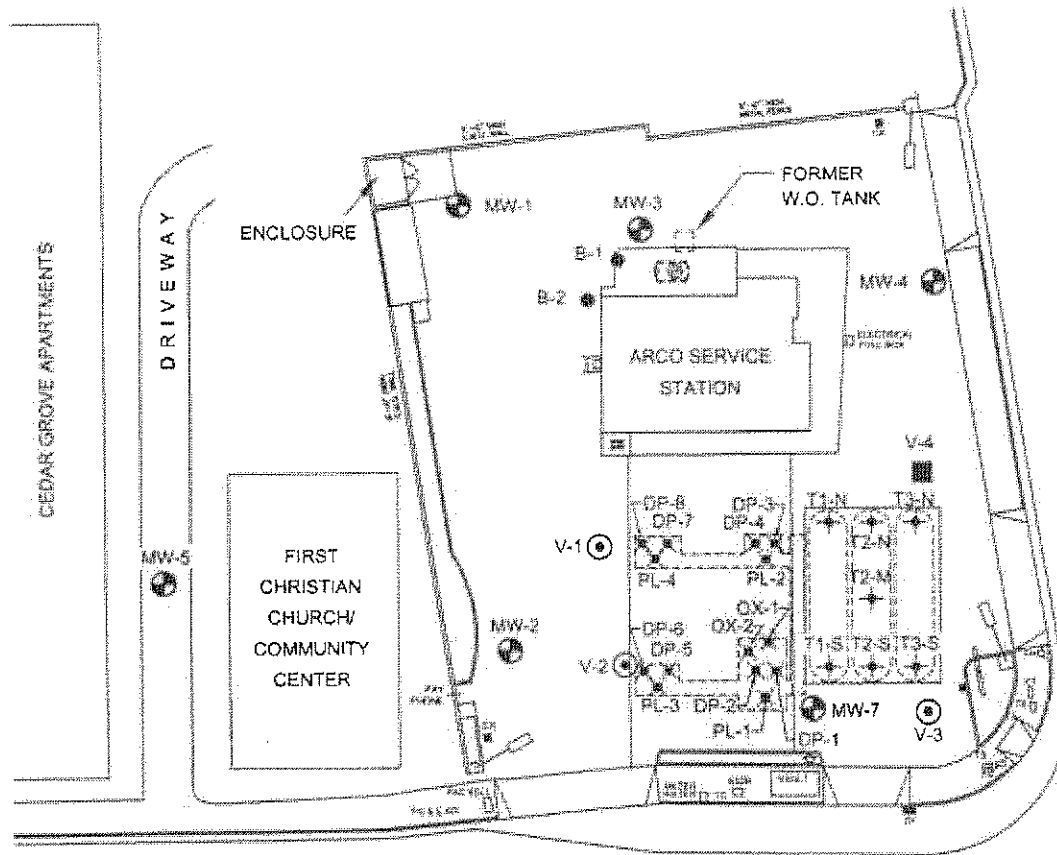

DISPENSER PUMP & PRODUCT LINES

SAMPLE I.D.	SAMPLE DEPTH
DP-1	5.0 FEET
DP-2	8.0 FEET
DP-3	4.0 FEET
DP-4	4.5 FEET
DP-5	4.0 FEET
DP-6	4.0 FEET
DP-7	5.0 FEET
DP-8	5.0 FEET
PL-1	4.0 FEET
PL-2	6.0 FEET
PL-3	6.0 FEET
PL-4	5.0 FEET
OX-1	10.0 FEET
OX-2	9.5 FEET

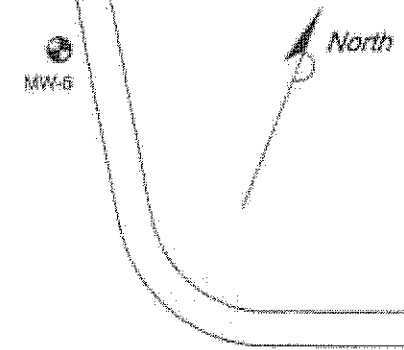

DAVIS STREET

LEGEND:

- MW-1 MONITORING WELL LOCATION
- V-1 VAPOR EXTRACTION WELL LOCATION
- B-1 SOIL BORING LOCATION
- V-4 DESTROYED WELL LOCATION
- T-1N TANK BASIN SOIL SAMPLE LOCATIONS
- PL-1 FORMER PRODUCT LINE/ DISPENSER PUMP SOIL SAMPLE LOCATIONS

FORMER TANK BASIN

SAMPLE I.D.	SAMPLE DEPTH
T1-N	17 FEET
T2-N	17 FEET
T3-N	16 FEET
T2-M	16 FEET
T1-S	16 FEET
T2-S	16 FEET
T3-S	16 FEET

FIGURE 3  
SOIL SAMPLE LOCATION MAP  
ARCO SERVICE STATION NO. 2111  
1156 DAVIS STREET  
SAN LEANDRO, CALIFORNIA

PROJECT NO 0000-358	DRAWN BY TLA 11/23/00
FILE NO	PREPARED BY TLA
REVISION NO 1	REVIEWED BY



TABLE 1

## SOIL SAMPLE LABORATORY ANALYTICAL RESULTS

ARCO Service Station No. 2111  
1156 Davis Street  
San Leandro California

Sample ID	Date	Depth (ft)	Benzene (mg/kg)	Toluene (mg/kg)	Ethyl-benzene (mg/kg)	Total Xylenes (mg/kg)	TPH as Gasoline (mg/kg)	MTBE (mg/kg)	Lead (mg/kg)
<b>Dispenser Island Samples</b>									
DP-1	10/17/00	5.0	2	20	30	170	2,100	13	15
DP-2	10/17/00	8.0	0.77	0.84	7.4	32	440	4.4	13
DP-3	10/17/00	4.0	0.014	0.12	0.26	1.9	31	2.2	15
DP-4	10/17/00	4.5	0.0056	0.059	0.1	0.68	9.4	0.9	12
DP-5	10/17/00	4.0	0.0061	<0.005	<0.005	<0.005	<1.0	1.5	14
DP-6	10/17/00	4.0	<0.005	<0.005	<0.005	<0.005	<1.0	0.2	25
DP-7	10/17/00	5.0	<0.005	<0.005	<0.005	<0.005	2.2	2.4	13
DP-8	10/17/00	5.0	<0.005	<0.005	<0.005	0.092	<1.0	0.35	13
<b>Product Line Samples</b>									
PL-1	10/17/00	4.0	0.16	<0.05	2.1	3.6	430	0.36	14
PL-2	10/17/00	6.0	<0.005	0.02	0.0077	0.6	14	4.7	12
PL-3	10/17/00	5.0	<0.005	<0.005	<0.005	<0.005	<1.0	0.17	12
PL-4	10/17/00	5.0	<0.005	<0.005	<0.005	0.043	1.3	0.86	11
<b>Tank Basin Samples</b>									
T1-S	10/19/00	17.0	0.21	2.1	1.6	8.5	110	33	8.9
T1-N	10/19/00	16.0	4.7	79	30	170	1,900	89	10
T2-S	10/19/00	16.0	1.1	26	14	77	1,100	18	8.1
T2-M	10/19/00	16.0	1.9	38	11	59	800	59	8.3
T2-N	10/19/00	17.0	7.7	190	58	300	4,400	76	13
T3-S	10/19/00	16.0	1.3	8.4	29	120	340	6.5	12
T3-N	10/19/00	16.0	5.0	76	28	140	1,800	83	12
<b>Soil Overexcavation Samples</b>									
OX-1	10/26/00	10.0	0.4	<0.005	<0.005	0.0091	2.7	1.5	9.7
OX-2	10/26/00	9.5	0.18	0.81	0.42	2.6	19	7.7	11
<b>Soil Stockpile Results</b>									
STK-1	10/19/00	Composite	0.019	0.017	0.052	0.27	8	NA	11
STK-2	10/26/00	Composite	0.054	0.48	0.64	3.8	86	0.91	9.6

TPH = Total petroleum hydrocarbons.

MTBE = Methyl tertiary butyl ether (analyzed by EPA Method 8260)

NA = Not Analyzed



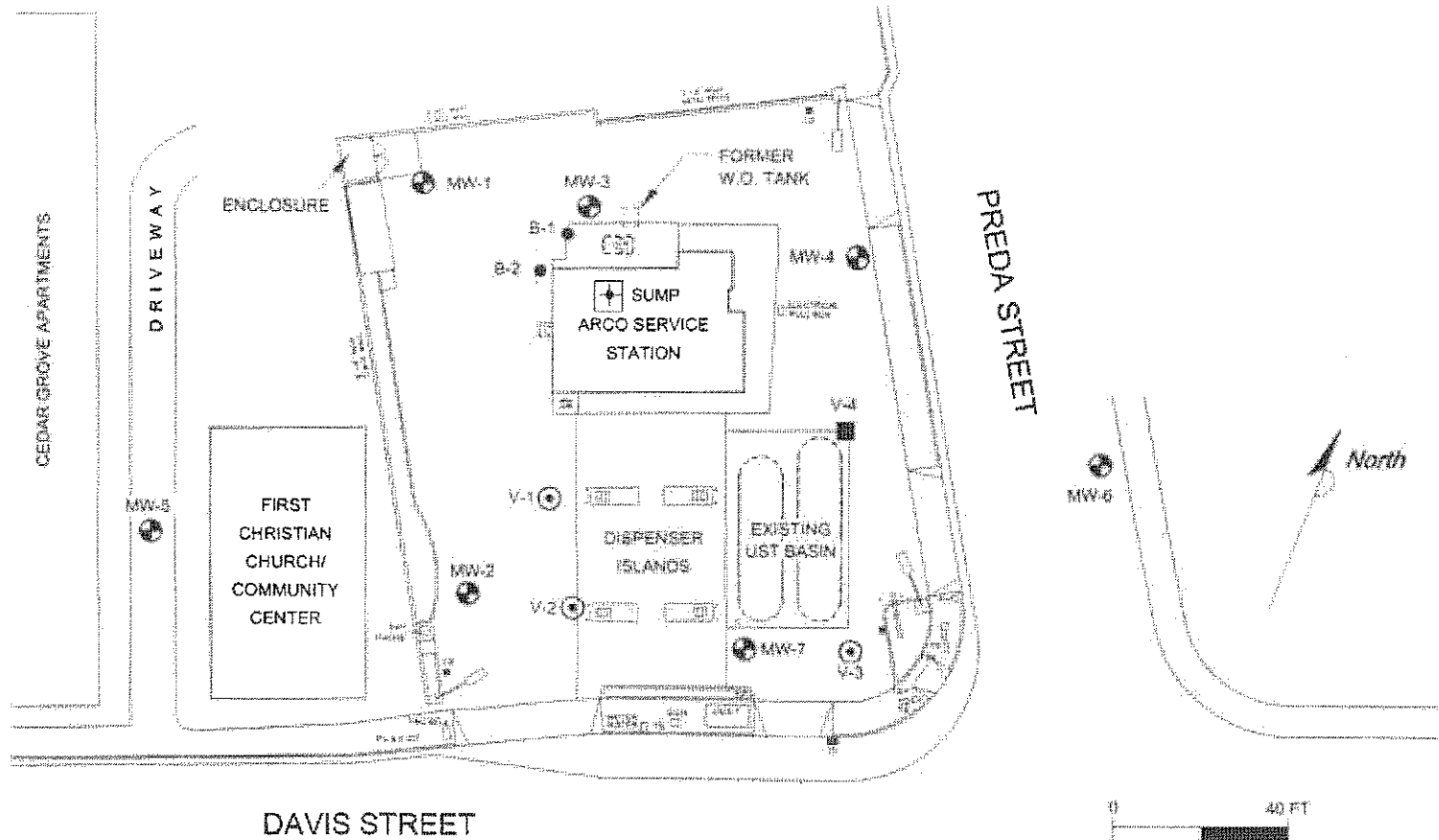

LEGEND:





-  MW-1 MONITORING WELL LOCATION
-  V-1 VAPOR EXTRACTION WELL LOCATION
-  B-1 SDI BORING LOCATION
-  V-4 DESTROYED WELL LOCATION
-  SUMP SUMP SAMPLE LOCATION

FIGURE 2  
SITE MAP  
ARCO SERVICE STATION NO. 2111  
1158 DAVIS STREET  
SAN LEANDRO, CALIFORNIA

PROJECT NO. 0000-108	DRAWN BY T.L.A. 8/20/01
FILE NO. 2111-1	PREPARED BY T.L.A.
REVISION NO. 2	REVIEWED BY



TABLE 1

SOIL CHEMICAL ANALYTICAL DATA

ARCO Service Station No. 2111  
 1156 Davis Street  
 San Leandro, California

Sample ID	Date Collected	Depth (feet)	Benzene (mg/kg)	Toluene (mg/kg)	Ethylbenzene (mg/kg)	Total Xylenes (mg/kg)	TPHg (mg/kg)	TPHd (mg/kg)	MTBE (mg/kg)	PCB (mg/kg)	TRPH (mg/kg)	VOC <sup>1</sup> (mg/kg)	VOC <sup>2</sup> (mg/kg)	SVOC (mg/kg)	Total Metals (mg/kg)
Sump	5/5/2001	2	<0.025	<0.025	0.0618	0.209	305	465	*0.25	ND	543	ND	0.637 <sup>a</sup> , 1.11 <sup>b</sup> , 4.47 <sup>c</sup> , 0.575 <sup>d</sup> , 9.81 <sup>e</sup> , 3.30 <sup>f</sup> , 0.219 <sup>g</sup>	0.51 <sup>h</sup> , 0.61 <sup>i</sup>	38 <sup>h</sup> , 52 <sup>i</sup> , 8.7, 60 <sup>j</sup>

Explanations:

BTEX = benzene, toluene, ethylbenzene, and total xylenes

TPHg = total petroleum hydrocarbons as gasoline

TPHd = total petroleum hydrocarbons as diesel

MTBE = methyl tertiary butyl ether

PCB = polychlorinated biphenyls

TRPH = total recoverable petroleum hydrocarbons (oil & greases)

VOC = volatile organic compounds

VOC<sup>1</sup>

VOC<sup>2</sup>

SVOC = semi-volatile organic compounds

Total Metals

Analytical Methods

DHS LUFT

DHS LUFT

DHS LUFT

DHS LUFT

EPA Method 8082

APHA/EPA Methods

EPA Method 8010

EPA Method 8260A

EPA Method 8270C

EPA 6000/7000 Series Methods

<sup>a</sup> = sec-butylbenzene, <sup>b</sup> = p-isopropyltoluene, <sup>c</sup> = naphthalene,

<sup>d</sup> = o-propylbenzene, <sup>e</sup> = 1,2,4-trimethylbenzene,

<sup>f</sup> = 1,3,5-trimethylbenzene, <sup>g</sup> = m,p-xylene

<sup>h</sup> = chromium, <sup>i</sup> = nickel, <sup>j</sup> = lead, <sup>k</sup> = zinc

<sup>l</sup> = 2-methylnaphthalene

ND = Non detect (see laboratory reports for specific detection levels)

**TABLE 1**  
**PILOT TEST AIR ANALYTICAL DATA**

ARCO Service Station No. 2111  
1156 Davis Street  
San Leandro, California

Sample	I.D.	Date Sampled	Time	Benzene (ppmv)	Toluene (ppmv)	Ethyl-benzene (ppmv)	Total Xylenes (ppmv)	TPHg (ppmv)	MTBE (8020) (ppmv)	MTBE (8260) (ppmv)
VW-2 (V-2)		01/07/02	10:45	4.1	0.82	1.8	4.5	55 <sup>a</sup>	84	84
1-7-02 (V-2)		01/07/02	16:00	2.1	0.34	0.68	1.5	25	NA	64
1-8-02 (V-2)		01/08/02	8:00	2.9	1.0	1.3	2.2	97	NA	209
1-9-02 (V-2)		01/09/02	8:00	5.5	2.3	2.1	3.8	210	NA	179
1-10-02 (V-2)		01/10/02	8:00	3.9	1.3	1.9	4.2	190	53	95
1-11-02 (MW-7)		01/11/02	9:00	2.0	2.3	0.85	2.3	80	72	128

<sup>a</sup> = Hydrocarbon pattern is present in the requested fuel quantitation but does not resemble the pattern of the requested fuel.

TPH = Total Petroleum Hydrocarbons

MTBE = Methyl tertiary butyl ether analyzed by EPA Method 8021B unless otherwise noted

µg/L = Micrograms per liter

NA = Not analyzed

TABLE 2

## PILOT TEST WATER ANALYTICAL DATA

ARCO Service Station No. 2111  
 1156 Davis Street  
 San Leandro, California

Sample	I.D.	Date Sampled	Time	Benzene (µg/L)	Toluene (µg/L)	Ethyl-benzene (µg/L)	Total Xylenes (µg/L)	TPH (µg/L)	MTBE (8020) (µg/L)	MTBE (8260) (µg/L)
VW-2 (V-2)		01/07/02	10:50	860	<500	<500	1,400	<50,000	160,000	180,000
1-7-02 (V-2)		01/07/02	16:00	240	51	93	280	18,000 <sup>a</sup>	NA	98,000
1-8-02 (V-2)		01/08/02	8:00	42	11	<0.5	53	1,800	NA	16,000
1-9-02 (V-2)		01/09/02	8:00	46	45	81	360	6,600	NA	8,100
1-10-02 (V-2)		01/10/02	8:00	28	<20	25	71	<2,000	6,300	5,600
1-11-02 (MW-7)		01/11/02	9:00	<20	23	<20	52	<2,000	6,800	5,800

<sup>a</sup> = Hydrocarbon pattern is present in the requested fuel quantitation but does not resemble the pattern of the requested fuel.

TPH = Total Petroleum Hydrocarbons

MTBE = Methyl tertiary butyl ether analyzed by EPA Method 8021B unless otherwise noted

µg/L = Micrograms per liter

NA = Not analyzed

TABLE 3

## DUAL PHASE EXTRACTION PILOT TEST VAPOR RESULTS TABLE

ARCO Service Station No. 2111  
1156 Davis Street  
San Leandro, California

## V-2 PILOT TEST VAPOR EXTRACTION RESULTS - 2002

Date & Time Sampled	Influent Flowrate (ft <sup>3</sup> /min)	Laboratory TPHg Influent (ppmv)	Influent Non-methane Hydrocarbons by FID (ppmv)	Laboratory Benzene Influent (ppmv)	TPH Extraction Rate (lbs/hour)	Non- Methane Hydrocarbons by FID (lbs/hour)	Benzene Extraction Rate (lbs/hour)	Cumulative Volume of Processed Air (cubic feet)	Cumulative Laboratory TPHg Extraction (lbs)	Cumulative FID Non-Methane Hydrocarbon Extraction (lbs)	Total Hours Operated	Change in Hours of Operation
1/7/02 9:00	236	NA	260	NA	NC	0.82	NC	0	NC	0.0	0.00	0.00
1/7/02 9:30	236	NA	260	NA	NC	0.94	NC	7,080	NC	0.4	0.50	0.50
1/7/02 9:45	226	NA	262	NA	NC	0.91	NC	10,470	NC	0.7	0.75	0.25
1/7/02 10:00	226	NA	216	NA	NC	0.75	NC	13,860	NC	0.9	1.00	0.25
1/7/02 10:30	247	NA	112	NA	NC	0.42	NC	21,270	NC	1.2	1.50	0.50
1/7/02 10:45	247	55	112	4.1	0.18	0.37	0.34	24,975	0.3	1.3	1.75	0.25
1/7/02 12:00	238	NA	197	NA	NC	0.72	NC	42,825	NC	2.0	3.00	1.25
1/7/02 16:00	260	25	884	2.1	0.09	3.06	0.18	105,225	1.0	9.5	7.00	4.00
1/7/02 17:00	263	NA	808	NA	NC	3.26	NC	121,005	NC	12.7	8.00	1.00
1/7/02 18:00	261	NA	1,087	NA	NC	4.36	NC	136,665	NC	16.5	9.00	1.00
1/8/02 8:00	274	97	381	2.9	0.35	1.39	0.27	366,825	4.5	56.7	23.00	14.00
1/9/02 8:00	263	210	417	5.5	0.74	1.46	0.48	745,545	17.6	91.0	47.00	24.00
1/10/02 8:00	224	190	381	3.9	0.57	1.14	0.29	1,068,105	33.3	122.1	71.00	24.00
1/10/02 15:45	261	190*	185	3.9*	0.66	0.64	0.34	1,189,470	38.0	129.0	78.75	7.75

TPHg = Total petroleum hydrocarbons as gasoline.

ppmv = Parts per million by volume.

\* = assumed to be same as previous sample results

NC = Not Calculated

NA = Not Analyzed

Gallons of Vapor Equivalent Gasoline Removed: 6.2  
Average Vapor Gallons Removed per Minute: 0.001

TABLE 3

## DUAL PHASE EXTRACTION PILOT TEST VAPOR RESULTS TABLE

ARCO Service Station No. 2111  
1156 Davis Street  
San Leandro, California

## MW-7 PILOT TEST VAPOR EXTRACTION RESULTS - 2002

Date & Time Sampled	Influent Flowrate (ft <sup>3</sup> /min)	Laboratory TPHg Influent (ppmv)	Influent Non-methane Hydrocarbons by FID (ppmv)	Laboratory Benzene Influent (ppmv)	Laboratory TPHg Extraction Rate (lbs/hour)	Non- Methane Hydrocarbons by FID (lbs/hour)	Benzene Extraction Rate (lbs/hour)	Cumulative Volume of Processed Air (cubic feet)	Cumulative Laboratory TPHg Extraction (lbs)	Cumulative FID Non-Methane Hydrocarbon Extraction (lbs)	Total Hours Operated	Change in Hours of Operation
1/10/02 16:00	NM	NA	NM	NA	NC	NC	NC	0	0.0	NC	0.00	0.00
1/10/02 17:00	NM	NA	NM	NA	NC	NC	NC	15,000	0.3	NC	1.00	1.00
1/11/02 9:00	250	80	NM	2	0.31	NC	0.17	255,000	5.2	NC	17.00	16.00
1/11/02 10:00	NM	NA	NM	NA	NC	NC	NC	270,000	5.5	NC	18.00	1.00
1/11/02 11:00	NM	NA	NM	NA	NC	NC	NC	285,000	5.8	NC	19.00	1.00
1/11/02 12:00	NM	NA	NM	NA	NC	NC	NC	300,000	6.1	NC	20.00	1.00

TPHg = Total petroleum hydrocarbons as gasoline.

ppmv = Parts per million by volume.

Note : Laboratory results and flow rates are assumed to be consistant for entire event on MW-7. FID did not function properly during test on MW-7 therefore, no recordings were made.

NC = Not Calculated

NA = Not Analyzed

Gallons of Vapor Equivalent Gasoline Removed: 1.0  
Average Vapor Gallons Removed per Minute: 0.001

TABLE 3

## DUAL PHASE EXTRACTION PILOT TEST VAPOR RESULTS TABLE

ARCO Service Station No. 2111  
1156 Davis Street  
San Leandro, California

## MW-2 PILOT TEST VAPOR EXTRACTION RESULTS - 2002

Date & Time Sampled	Influent Flowrate (ft <sup>3</sup> /min)	Laboratory TPHg Influent (ppmv)	Influent Non-methane Hydrocarbons by FID (ppmv)	Laboratory Benzene Influent (ppmv)	Laboratory TPHg Extraction Rate (lbs/hour)	Non- Methane Hydrocarbons by FID (lbs/hour)	Benzene Extraction Rate (lbs/hour)	Cumulative Volume of Processed Air (cubic feet)	Cumulative Laboratory TPHg Extraction (lbs)	Cumulative FID Non-Methane Hydrocarbon Extraction (lbs)	Total Hours Operated	Change in Hours of Operation
1/11/02 12:00	292	NA	10,176	NA	NC	45.65	NC	0	NC	0.0	0.00	0.00
1/11/02 12:15	NM	NA	2,406	NA	NC	10.79	NC	4,380	NC	7.1	0.25	0.25
1/11/02 12:30	NM	NA	971	NA	NC	4.36	NC	8,760	NC	8.9	0.50	0.25
1/11/02 13:00	NM	NA	690	NA	NC	3.09	NC	17,520	NC	10.8	1.00	0.50
1/11/02 14:00	NM	NA	300	NA	NC	1.35	NC	35,040	NC	13.0	2.00	1.00
1/11/02 15:00	NM	NA	351	NA	NC	1.58	NC	52,560	NC	14.5	3.00	1.00
1/11/02 17:00	NM	NA	351	NA	NC	1.58	NC	87,600	NC	17.6	5.00	2.00

TPHg = Total petroleum hydrocarbons as gasoline.

ppmv = Parts per million by volume.

NC = Not Calculated

NA = Not Analyzed

Gallons of Vapor Equivalent Gasoline Removed:

2.9

Average Vapor Gallons Removed per Minute:

0.016

TABLE 4

DUAL PHASE EXTRACTION SYSTEM FIELD DATA

ARCO Service Station No. 2111  
 1156 Davis Street  
 San Leandro, California

Pilot Test on V-2

		System Readings					V-2		MW-2		MW-7		V-1		V-3		MW-1	
Date	Time	System Vacuum ("Hg)	System Conc (ppmv)	System Flowrate (ft <sup>3</sup> /min)	Water Meter (gallons)	Total Discharge (gpm)	Vacuum Reading ("H <sub>2</sub> O)	Depth to Water (Feet)	Vacuum Reading ("H <sub>2</sub> O)	Depth to Water (Feet)	Vacuum Reading ("H <sub>2</sub> O)	Depth to Water (Feet)	Vacuum Reading ("H <sub>2</sub> O)	Depth to Water (Feet)	Vacuum Reading ("H <sub>2</sub> O)	Depth to Water (Feet)	Vacuum Reading ("H <sub>2</sub> O)	Depth to Water (Feet)
1/7/02	9:00	24	260.3	236	NM	NC	NM	13.48	NM	13.20	NM	13.60	NM	14.14	NM	12.99	NM	15.09
1/7/02	9:30	24	260.3	236	2,552,890	NC	265	NM	0.10	13.22	0.00	13.62	0.00	14.12	0.00	13.00	0.00	15.12
1/7/02	9:45	24	261.7	226	NM	NC	265	NM	0.10	13.21	0.00	13.61	0.00	14.14	0.00	13.00	0.00	15.11
1/7/02	10:00	24	216.4	NM	2,552,980	3.00	NM	NM	0.05	13.24	0.01	13.60	0.00	14.16	0.00	13.01	0.02	15.13
1/7/02	10:30	24	112.4	247	NM	NC	265	NM	0.05	13.25	0.01	13.60	0.00	14.16	0.00	13.01	0.02	15.14
1/7/02	11:00	24	60.3	224	NM	NC	NM	NM	0.05	13.24	0.01	13.60	0.00	14.25	0.00	13.00	0.02	15.14
1/7/02	12:00	20	196.7	238	NM	NC	220	NM	0.05	13.25	0.01	13.60	0.00	14.15	0.00	13.00	0.02	15.14
1/7/02	13:00	22	320.4	247	2,553,140	0.89	230	NM	0.05	13.25	0.01	13.60	0.00	14.16	0.00	13.01	0.02	15.14
1/7/02	14:00	22	387.4	263	NM	NC	230	NM	0.05	13.25	0.01	13.60	0.00	14.16	0.00	13.01	0.02	15.14
1/7/02	15:00	NM	System Down		NM	NC	NM	NM	NM	NM	NM	NM	NM	NM	NM	NM	NM	NM
1/7/02	16:00	NM	883.7	260	NM	NC	NM	NM	0.05	13.24	0.01	13.60	0.00	14.15	0.00	13.00	0.02	15.14
1/7/02	17:00	22	807.6	263	2,553,250	0.46	230	NM	0.05	13.25	0.01	13.60	0.00	14.15	0.00	13.01	0.02	15.14
1/7/02	18:00	24	1087	261	NM	NC	265	NM	0.05	13.25	0.01	13.61	0.00	14.15	0.00	13.01	0.02	15.14
1/8/02	8:00	24	380.7	274	2,554,700	1.61	265	15+	NM	13.31	NM	13.64	NM	14.24	NM	13.04	NM	15.17
1/9/02	8:00	24	416.6	263	2,557,220	1.75	265	19+	0.08	13.35	0.00	13.68	0.00	14.25	0.00	13.11	0.02	15.25
1/10/02	8:00	24	380.7	224	2,559,570	1.63	240	NM	0.22	13.39	0.00	13.69	0.00	14.29	0.00	13.16	0.03	15.27
1/10/02	15:45	24	184.7	261	2,560,010	0.95	240	19+	0.22	13.46	0.00	13.70	0.00	14.36	0.00	13.20	0.02	15.30
Totals/Avg:		4725	23.3	388.6	248.2	7,120	1.51	248.3	5.52	0.26	0.10	0.22	0.21	0.21	0.21	0.21	0.21	0.21

ppmv = parts per million by volume.  
 "Hg = inches of Mercury  
 "H<sub>2</sub>O = inches of water column  
 NM = Not Measured



TABLE 4

DUAL PHASE EXTRACTION SYSTEM FIELD DATA

ARCO Service Station No. 2111  
 1156 Davis Street  
 San Leandro, California

Pilot Test on MW-7

		System Readings					V-2		MW-2		MW-7		V-1		V-3		MW-1	
Date	Time	System Vacuum ("Hg)	System Conc (ppmv)	System Flowrate (ft <sup>3</sup> /min)	Water Meter (gallons)	Total Discharge (gpm)	Vacuum Reading ("H <sub>2</sub> O)	Depth to Water (Feet)	Vacuum Reading ("H <sub>2</sub> O)	Depth to Water (Feet)	Vacuum Reading ("H <sub>2</sub> O)	Depth to Water (Feet)	Vacuum Reading ("H <sub>2</sub> O)	Depth to Water (Feet)	Vacuum Reading ("H <sub>2</sub> O)	Depth to Water (Feet)	Vacuum Reading ("H <sub>2</sub> O)	Depth to Water (Feet)
1/10/02	16:00	24	NM	250	2,560,010	NC	NM	13.69	NM	13.45	240.00	13.77	NM	14.35	NM	13.20	NM	15.32
1/11/02	12:00	24	NM	250	2,561,910	1.58	NM	13.67	NM	13.50	240.00	13.89	NM	14.37	NM	13.20	NM	15.35
Totals/Avg:		1200		250	1,900	1.58		-0.02		0.05	240.0	0.12		0.02		0.00		0.03

Pilot Test on MW-2

		System Readings					V-2		MW-2		MW-7		V-1		V-3		MW-1	
Date	Time	System Vacuum ("Hg)	System Conc (ppmv)	System Flowrate (ft <sup>3</sup> /min)	Water Meter (gallons)	Total Discharge (gpm)	Vacuum Reading ("H <sub>2</sub> O)	Depth to Water (Feet)	Vacuum Reading ("H <sub>2</sub> O)	Depth to Water (Feet)	Vacuum Reading ("H <sub>2</sub> O)	Depth to Water (Feet)	Vacuum Reading ("H <sub>2</sub> O)	Depth to Water (Feet)	Vacuum Reading ("H <sub>2</sub> O)	Depth to Water (Feet)	Vacuum Reading ("H <sub>2</sub> O)	Depth to Water (Feet)
1/11/02	12:00	18	10,176	342	2,561,910	NC	NM	13.67	NM	13.50	NM	13.80	NM	14.37	NM	13.21	NM	15.35
1/11/02	17:00	18	351.4	292	2,567,870	19.87	NM	13.71	150.00	13.69	NM	13.87	NM	14.38	NM	13.20	NM	15.35
Totals/Avg:		300		317	5,960	19.87		0.04	150.0	0.19		0.07		0.01		-0.01		0.00

ppmv = parts per million by volume.

"Hg = inches of Mercury

"H<sub>2</sub>O = inches of water column

NM = Not Measured

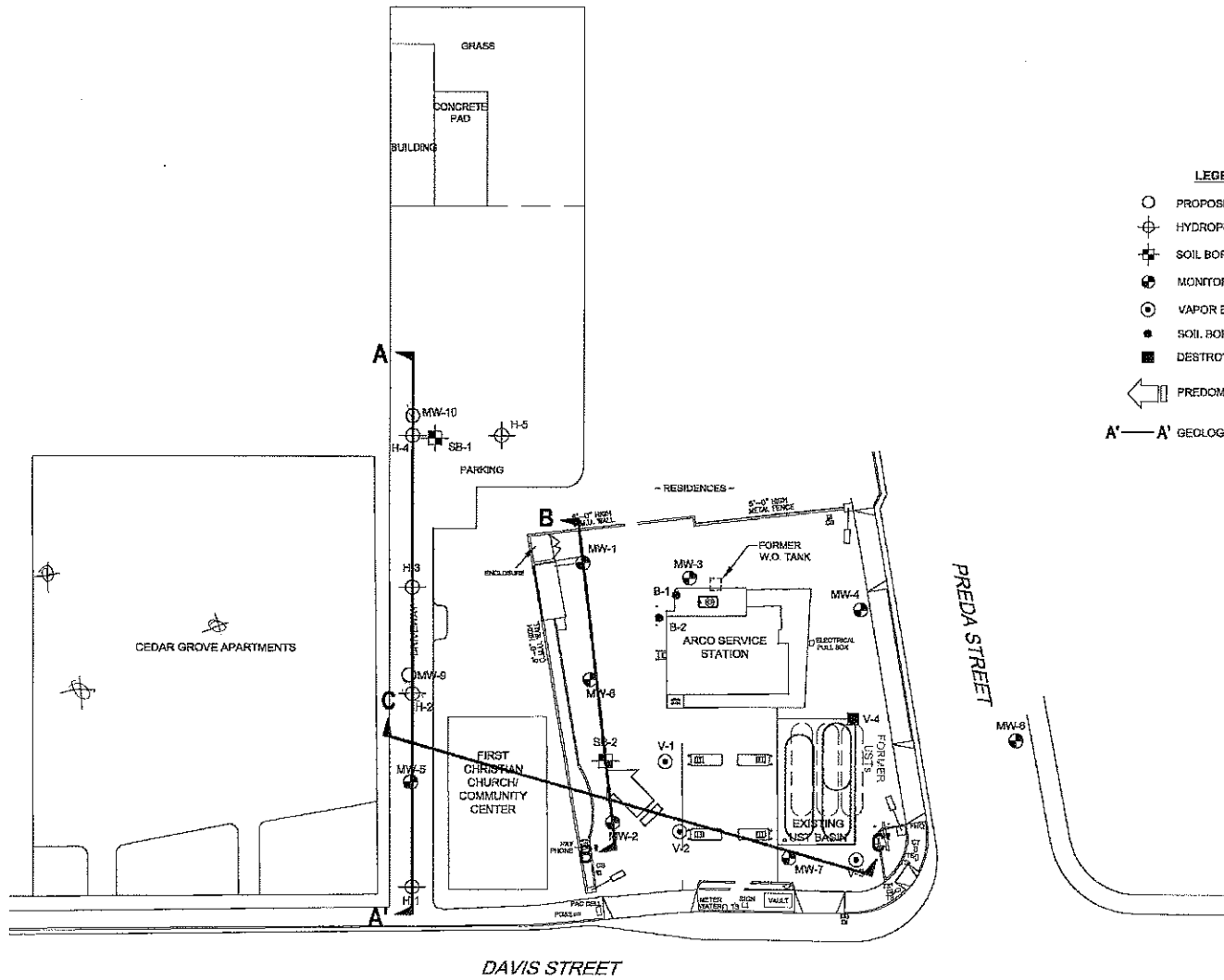

- LEGEND**
- PROPOSED MONITORING WELL LOCATION
  - ⊕ HYDROFUNCH LOCATION
  - ⊕ SOIL BORING LOCATION
  - ⊕ MONITORING WELL
  - ⊕ VAPOR EXTRACTION WELL
  - SOIL BORING
  - DESTROYED WELL
  - ← PREDOMINANT GROUNDWATER FLOW DIRECTION
  - A'—A' GEOLOGICAL CROSS SECTION LINE



NOTE: SITE MAP ADAPTED FROM DELTA ENVIRONMENTAL FIGURES. SITE DIMENSIONS AND FACILITY LOCATIONS NOT VERIFIED.

Arco Service Station #2111 - 1156 Davis Street - San Leandro, CA - 94605 - 11/1/00  
 X:\proj\1156 Davis Street\GIS\GIS\Map\Map\_SitePlan.dwg - 11/1/00 - Page 1 of 1

<b>URS</b>	Project No. 38486896	<b>SITE PLAN</b>	FIGURE <b>1</b>
	Arco Service Station #2111 1156 Davis Street San Leandro, California		

Table 1  
Soil Analytical Results  
ARCO #2111  
1156 Davis St., San Leandro, CA

Well Number	Date Sampled	TPH-g (mg/kg)	Benzene (mg/kg)	Toluene (mg/kg)	Ethyl-benzene (mg/kg)	Total Xylenes (mg/kg)	TBA (mg/kg)	MTBE (mg/kg)	DIPE (mg/kg)	ETBE (mg/kg)	TAME (mg/kg)
MW-8-5	11/26/04	ND<1.0	ND<0.005	ND<0.005	ND<0.005	ND<0.005	ND<0.010	ND<0.005	ND<0.010	ND<0.005	ND<0.005
MW-8-10	11/26/04	ND<1.0	ND<0.005	ND<0.005	ND<0.005	ND<0.005	ND<0.010	ND<0.005	ND<0.010	ND<0.005	ND<0.005
MW-8-15	11/26/04	2.1	ND<0.005	ND<0.005	ND<0.005	ND<0.005	0.017	0.032	ND<0.010	ND<0.005	ND<0.005
MW-8-16.5	11/26/04	150	ND<0.5	ND<0.5	0.60	0.64	ND<2.5	ND<0.50	ND<1.0	ND<0.5	25
MW-8-23	11/26/04	ND<5.0	ND<0.025	ND<0.025	ND<0.025	ND<0.025	ND<0.050	1.4	ND<0.050	ND<0.025	ND<0.025
MW-8-28	11/26/04	ND<1.0	ND<0.005	ND<0.005	ND<0.005	ND<0.005	ND<0.010	0.12	ND<0.010	ND<0.005	ND<0.005
MW-8-33	11/26/04	ND<1.0	ND<0.005	ND<0.005	ND<0.005	ND<0.005	ND<0.010	0.037	ND<0.010	ND<0.005	ND<0.005
MW-8-38	11/26/04	ND<1.0	ND<0.005	ND<0.005	ND<0.005	ND<0.005	ND<0.010	0.027	ND<0.010	ND<0.005	ND<0.005

Notes:

- TPH-g = Total Petroleum Hydrocarbons analyzed by EPA method 8260B.
- BTEX = Benzene, Toluene, Ethyl-benzene, and Total Xylenes analyzed by EPA method 8260B.
- MTBE = Methyl tertiary butyl ether analyzed by EPA Method 8260B.
- TBA = tert-Butyl alcohol
- DIPE = Di-isopropyl ether
- ETBE = Ethyl tert-butyl ether
- TAME = tert-Amyl methyl ether
- 1,2-DCA = 1,2-Dichloroethane
- 1,2-DBA = 1,2-Dibromoethane (EDB)
- mg/kg = Micrograms per kilogram
- MSL = Mean sea level
- ND< = Not detected at or above specified laboratory method detection limit

**Table 2**  
**Groundwater Analytical Results**  
**ARCO #2111**  
**1156 Davis St., San Leandro, CA**

Well Number	Date Sampled	GRO (µg/L)	Benzene (µg/L)	Toluene (µg/L)	Ethyl-benzene (µg/L)	Total Xylenes (µg/L)	Ethanol (µg/L)	TBA (µg/L)	MTBE (µg/L)	DIE (µg/L)	ETBE (µg/L)	TAME (µg/L)	1,2-DCA (mg/L)	1,2-DBA (mg/L)
H-1	03/21/04	820	ND<5	ND<5	ND<5	ND<5	ND<1000	ND<200	550	ND<5	ND<5	ND<5	ND<5	ND<5
H-2	03/21/04	260,000	ND<500	ND<500	5,800	11,000	ND<100,000	ND<500	7,600	ND<500	ND<500	ND<500	ND<500	ND<500
H-3	03/21/04	ND<50	ND<0.50	ND<0.50	ND<0.50	ND<0.50	ND<100	ND<20	ND<0.50	ND<0.50	ND<0.50	ND<0.50	ND<0.50	ND<0.50
H-4-27	03/20/04	ND<50	ND<0.50	ND<0.50	ND<0.50	0.72	ND<100	ND<20	ND<0.50	ND<0.50	ND<0.50	ND<0.50	ND<0.50	ND<0.50
H-4-35	03/20/04	ND<50	ND<0.50	ND<0.50	ND<0.50	ND<0.50	ND<100	ND<20	ND<0.50	ND<0.50	ND<0.50	ND<0.50	ND<0.50	ND<0.50
H-5-27	03/20/04	ND<50	ND<0.50	ND<0.50	ND<0.50	ND<0.50	ND<100	ND<20	ND<0.50	ND<0.50	ND<0.50	ND<0.50	ND<0.50	ND<0.50
H-5-32	03/20/04	ND<50	ND<0.50	ND<0.50	ND<0.50	ND<0.50	ND<100	ND<20	ND<0.50	ND<0.50	ND<0.50	ND<0.50	ND<0.50	ND<0.50
H-5-40	03/21/04	53	ND<0.50	ND<0.50	ND<0.50	ND<0.50	ND<100	ND<20	ND<0.50	ND<0.50	ND<0.50	ND<0.50	ND<0.50	ND<0.50

Notes:

- GRO = Gasoline Range Organics
- BTEX = Benzene, Toluene, Ethyl-benzene, and Total Xylenes analyzed by EPA method 8260B.
- MTBE = Methyl tertiary butyl ether analyzed by EPA Method 8260B.
- TBA = tert-Butyl alcohol
- DIE = Di-isopropyl ether
- ETBE = Ethyl tert-butyl ether
- TAME = tert-Amyl methyl ether
- 1,2-DCA = 1,2-Dichloroethane
- 1,2-DBA = 1,2-Dibromoethane (EDB)
- µg/L = Micrograms per liter
- MSL = Mean sea level
- ND< = Not detected at or above specified laboratory method detection limit
- \* = Groundwater elevation measurements are from first encountered groundwater during drilling.

Source : The data within this table collected prior to July 2002 was provided to URS by Group Environmental Management Company and their previous consultants. URS has not verified the accuracy of this information.

**Table 1**  
**Historical Groundwater Elevation and Analytical Data**  
**Petroleum Hydrocarbons and Their Constituents**

**ARCO Service Station 2111**  
**1156 Davis Street, San Leandro, California**

Well Designation	Water Level Field Date	Top of Casing Elevation ft-MSL	Depth to Water feet	Free Product Thickness feet	Groundwater Elevation ft-MSL	Water Sample Field Date	TPHG LUFT Method µg/L	Benzene EPA 8021B* µg/L	Toluene EPA 8021B* µg/L	Ethylbenzene EPA 8021B* µg/L	Total Xylenes EPA 8021B* µg/L	MTBE EPA 8021B* µg/L	MTBE EPA 8260 µg/L	TRPH EPA 418.1 LUFT Method µg/L	Dissolved Oxygen mg/L	Purged/Not Purged P/NP
MW-1	08-01-95	39.60	17.45	ND	22.15	08-01-95	<50	<0.5	<0.5	<0.5	<0.5	..	..	..		
MW-1	12-14-95	39.60	17.09	ND	22.51	12-14-95	<50	<0.5	<0.5	<0.5	<0.5	Δ	..	..		
MW-1	03-21-96	39.60	14.72	ND	24.88	03-21-96	<50	<0.5	<0.5	<0.5	<0.5	Δ	..	..		
MW-1	05-24-96	39.60	15.94	ND	23.66	05-24-96	<50	<0.5	<0.5	<0.5	<0.5	Δ	..	..		
MW-1	08-09-96	39.60	17.89	ND	21.71	08-09-96	<50	<0.5	<0.5	<0.5	<0.5	Δ	..	..		
MW-1	11-06-96	39.60	18.66	ND	20.94	11-06-96	<50	<0.5	<0.5	<0.5	<0.5	Δ	..	..		
MW-1	03-24-97	39.60	16.13	ND	23.47	03-24-97	<50	<0.5	<0.5	<0.5	<0.5	Δ	..	..		
MW-1	05-27-97	39.60	17.23	ND	22.37	05-28-97	<50	<0.5	<0.5	<0.5	<0.5	Δ	..	..		
MW-1	08-07-97	39.60	18.68	ND	20.92	08-07-97	<50	<0.5	<0.5	<0.5	<0.5	Δ	..	..		
MW-1	11-10-97	39.60	19.19	ND	20.41	11-10-97	<50	<0.5	<0.5	<0.5	<0.5	Δ	..	..		
MW-1	02-16-98	39.60	12.61	ND	26.99	02-16-98	<50	<0.5	<0.5	<0.5	<0.5	Δ	..	..		
MW-1	04-15-98	39.60	14.30	ND	25.30	04-15-98	<50	<0.5	<0.5	<0.5	<0.5	Δ	..	..		
MW-1	07-24-98	39.60	16.40	ND	23.20	07-24-98	<50	<0.5	<0.5	<0.5	<0.5	Δ	..	..		
MW-1	10-19-98	39.60	17.90	ND	21.70	10-19-98	<50	<0.5	<0.5	<0.5	<0.5	Δ	..	..		
MW-1	01-28-99	39.60	16.85	ND	22.75	01-28-99	<20,000	580	<200	<200	320	14,000	..	..		
MW-1	06-25-99	39.60	17.35	ND	22.25	06-25-99	730	140	5	3	2	7,700	..	..	0.79	NP
MW-1	08-25-99	39.60	18.20	ND	21.40	08-25-99	390	66	8.5	<2.5	8.6	3,700	..	..	1.56	NP
MW-1	11-10-99	39.60	17.77	ND	21.83	11-10-99	360	70	13	2.2	13	980	..	..	0.30	NP
MW-1	02-09-00	39.60	16.25	ND	23.35	02-09-00	190	4.5	0.9	<0.5	12	3,500	..	..	0.53	NP
MW-2	08-01-95	37.99	15.67	ND	22.32	08-01-95	23,000	1,300	310	500	3,500	..	..	..		
MW-2	12-14-95	37.99	15.36	ND	22.63	12-14-95	7,300	900	25	180	1,000	<200	..	..		
MW-2	03-21-96	37.99	12.84	ND	25.15	03-21-96	9,600	850	30	280	1,400	250	..	..		
MW-2	05-24-96	37.99	14.03	ND	23.96	05-24-96	2,300	300	<5	73	310	<25	..	..		
MW-2	08-09-96	37.99	16.10	ND	21.89	08-09-96	2,800	290	6	75	320	50	..	..		

**Table 1**  
**Historical Groundwater Elevation and Analytical Data**  
**Petroleum Hydrocarbons and Their Constituents**

**ARCO Service Station 2111**  
**1156 Davis Street, San Leandro, California**

Well Designation	Water Level Field Date	Top of Casing Elevation ft-MSL	Depth to Water feet	Free Product Thickness feet	Groundwater Elevation ft-MSL	Water Sample Field Date	TPHG LUFT Method µg/L	Benzene EPA 8021B* µg/L	Toluene EPA 8021B* µg/L	Ethylbenzene EPA 8021B* µg/L	Total Xylenes EPA 8021B* µg/L	MTBE EPA 8021B* µg/L	MIBE EPA 8260 µg/L	TRPH EPA 418.1 LUFT Method µg/L	Dissolved Oxygen mg/L	Purged/Not Purged
MW-2	11-06-96	37.99	16.98	ND	21.01	11-06-96	750	76	<1	15	51	110	--	--	--	
MW-2	03-24-97	37.99	14.22	ND	23.77	03-24-97	790	18	<1	2	6	280	--	--	--	
MW-2	05-27-97	37.99	15.42	ND	22.57	05-28-97	750	14	<1	<1	10	150	--	--	--	
MW-2	08-07-97	37.99	16.92	ND	21.07	08-07-97	360	31	<2.5	<2.5	15	260	--	--	--	
MW-2	11-10-97	37.99	17.52	ND	20.47	11-10-97	1,300	82	<5	14	49	550	--	--	--	
MW-2	02-16-98	37.99	12.04	ND	25.95	02-16-98	<2,500	<25	<25	<25	<25	4,200	--	--	--	
MW-2	04-15-98	37.99	12.34	ND	25.65	04-15-98	<10,000	<100	<100	<100	<100	7,300	--	--	--	
MW-2	07-24-98	37.99	14.45	ND	23.54	07-24-98	<2,500	<25	<25	<25	<25	1,500	--	--	--	
MW-2	10-19-98	37.99	16.08	ND	21.91	10-19-98	<1,000	18	<10	<10	<10	1,100	--	--	--	
MW-2	01-28-99	37.99	15.59	0.02	22.41 [1]	01-28-99	160,000	3,000	24,000	4,400	31,000	23,000	--	--	--	
MW-2	06-25-99	37.99	19.20	3.73[4]	21.51 [1]	06-25-99	120,000	6,900	21,000	2,600	19,000	18,000	17,000[3]	--	0.49	NP
MW-2	08-25-99	37.99	16.49	0.02	21.51 [1]	08-25-99	92,000	2,200	16,000	3,200	19,000	11,000	9,400[3]	--	0.84	NP
MW-2	11-10-99	37.99	16.08	ND	21.91	11-10-99	56,000	2,400	5,900	1,500	10,000	17,000	21,000[3]	--	0.41	NP
MW-2	02-09-00	37.99	14.85	ND	23.14	02-09-00	1,700	270	14	17	21	70,000	55,000[3]	--	0.97	NP
MW-3	08-01-95	39.32	17.00	ND	22.32	08-01-95	<50	<0.5	<0.5	<0.5	<0.5	--	--	600	76[2]	
MW-3	12-14-95	39.32	16.70	ND	22.62	12-14-95	<50	<0.5	<0.5	<0.5	<0.5	<3	--	<500	<50	
MW-3	03-21-96	39.32	14.17	ND	25.15	03-21-96	<50	<0.5	<0.5	<0.5	<0.5	<3	--	<500	<50	
MW-3	05-24-96	39.32	15.30	ND	24.02	05-24-96	<50	<0.5	<0.5	<0.5	<0.5	<3	--	<500	<50	
MW-3	08-09-96	39.32	17.58	ND	21.74	08-09-96	<50	<0.5	<0.5	<0.5	<0.5	<3	--	<500	--	
MW-3	11-06-96	39.32	18.33	ND	20.99	11-06-96	<50	<0.5	<0.5	<0.5	<0.5	<3	--	--	--	
MW-3	03-24-97	39.32	15.44	ND	23.88	03-24-97	<50	<0.5	<0.5	<0.5	<0.5	<3	--	--	--	
MW-3	05-27-97	39.32	16.75	ND	22.57	05-28-97	<50	<0.5	<0.5	<0.5	<0.5	<3	--	--	--	
MW-3	08-07-97	39.32	18.35	ND	20.97	08-07-97	<50	<0.5	<0.5	<0.5	<0.5	<3	--	--	--	
MW-3	11-10-97	39.32	18.83	ND	20.49	11-10-97	<50	<0.5	<0.5	<0.5	<0.5	<3	--	--	--	

**Table 1**  
**Historical Groundwater Elevation and Analytical Data**  
**Petroleum Hydrocarbons and Their Constituents**

**ARCO Service Station 2111**  
**1156 Davis Street, San Leandro, California**

Well Designation	Water Level Field Date	Top of Casing Elevation ft-MSL	Depth to Water teet	Free Product Thickness teet	Groundwater Elevation ft-MSL	Water Sample Field Date	TPHG LUFT Method µg/L	Benzene EPA 8021B* µg/L	Toluene EPA 8021B* µg/L	Ethylbenzene EPA 8021B* µg/L	Total Xylenes EPA 8021B* µg/L	MTBE EPA 8021B* µg/L	MTBE EPA 8260 µg/L	TRPH EPA 418.1 µg/L	LUFT Method µg/L	Dissolved Oxygen mg/L	Purged/Not Purged Y/NP
MW-3	02-16-98	39.32	11.99	ND	27.33	02-16-98	<50	<0.5	<0.5	<0.5	<0.5	<0.5	--	--	--		
MW-3	04-15-98	39.32	13.75	ND	25.57	04-15-98	<50	<0.5	<0.5	<0.5	<0.5	<0.5	--	--	--		
MW-3	07-24-98	39.32	15.90	ND	23.42	07-24-98	<50	<0.5	<0.5	<0.5	<0.5	<0.5	--	--	--		
MW-3	10-19-98	39.32	17.45	ND	21.87	10-19-98	<50	<0.5	<0.5	<0.5	<0.5	<0.5	--	--	--		
MW-3	01-28-99	39.32	16.40	ND	22.92	01-28-99	<100	14	4	<1	6	100	--	--	--		
MW-3	06-25-99	39.32	17.92	ND	21.40	06-25-99	83	9.0	1.4	<0.5	2.5	220	--	--	--	1.11	NP
MW-3	08-25-99	39.32	17.79	ND	21.53	08-25-99	240	41	12	3.7	9.9	160	--	--	--	1.13	NP
MW-3	11-10-99	39.32	17.37	ND	21.95	11-10-99	620	100	9.7	4.1	21	150	--	--	--	0.24	NP
MW-3	02-09-00	39.32	15.77	ND	23.55	02-09-00	<50	<0.5	0.7	<0.5	<1	180	--	--	--	0.62	NP
MW-4	08-01-95	38.10	15.65	ND	22.45	08-01-95	<50	<0.5	<0.5	<0.5	<0.5	<0.5	--	--	--		
MW-4	12-14-95	38.10	15.35	ND	22.75	12-14-95	<50	<0.5	<0.5	<0.5	<0.5	<0.5	--	--	--		
MW-4	03-21-96	38.10	12.74	ND	25.36	03-21-96	<50	<0.5	<0.5	<0.5	<0.5	<0.5	--	--	--		
MW-4	05-24-96	38.10	14.03	ND	24.07	05-24-96	<50	<0.5	<0.5	<0.5	<0.5	<0.5	--	--	--		
MW-4	08-09-96	38.10	16.10	ND	22.00	08-09-96	<50	<0.5	<0.5	<0.5	<0.5	<0.5	--	--	--		
MW-4	11-06-96	38.10	17.00	ND	21.10	11-06-96	<50	<0.5	<0.5	<0.5	<0.5	<0.5	--	--	--		
MW-4	03-24-97	38.10	14.21	ND	23.89	03-24-97	<50	<0.5	<0.5	<0.5	<0.5	<0.5	--	--	--		
MW-4	05-27-97	38.10	15.38	ND	22.72	05-28-97	<50	<0.5	<0.5	<0.5	<0.5	<0.5	--	--	--		
MW-4	08-07-97	38.10	16.95	ND	21.15	08-07-97	<50	<0.5	<0.5	<0.5	<0.5	<0.5	--	--	--		
MW-4	11-10-97	38.10	17.53	ND	20.57	11-10-97	<50	<0.5	<0.5	<0.5	<0.5	<0.5	--	--	--		
MW-4	02-16-98	38.10	10.65	ND	27.45	02-16-98	<50	<0.5	<0.5	<0.5	<0.5	<0.5	--	--	--		
MW-4	04-15-98	38.10	12.20	ND	25.90	04-15-98	<50	<0.5	<0.5	<0.5	<0.5	<0.5	--	--	--		
MW-4	07-24-98	38.10	14.47	ND	23.63	07-24-98	<50	<0.5	<0.5	<0.5	<0.5	<0.5	--	--	--		
MW-4	10-19-98	38.10	16.20	ND	21.90	10-19-98	<50	<0.5	<0.5	<0.5	<0.5	<0.5	--	--	--		
MW-4	01-28-99	38.10	15.02	ND	23.08	01-28-99	340	52	5.5	<0.5	74	31	--	--	--		

**Table 1**  
**Historical Groundwater Elevation and Analytical Data**  
**Petroleum Hydrocarbons and Their Constituents**

**ARCO Service Station 2111**  
**1156 Davis Street, San Leandro, California**

Well Designation	Water Level Field Date	Top of Casing Elevation ft-MSL	Depth to Water feet	Free Product Thickness feet	Groundwater Elevation ft-MSL	Water Sample Field Date	TPHG LUFT Method	Benzene EPA 8021B* µg/L	Toluene EPA 8021B* µg/L	Ethylbenzene EPA 8021B* µg/L	Total Xylenes EPA 8021B* µg/L	MTBE EPA 8021B* µg/L	MTBE EPA 8260 µg/L	TRPH EPA 418.1 LUFT Method µg/L	Dissolved Oxygen mg/L	Purged/Not Purged
MW-4	06-25-99	38.10	15.57	ND	22.53	06-25-99	510	78	4.1	0.5	18	94	--	--	0.90	NP
MW-4	08-25-99	38.10	16.43	ND	21.67	08-25-99	660	130	21	6.4	39	110	--	--	1.01	NP
MW-4	11-10-99	38.10	16.02	ND	22.08	11-10-99	510	98	5.1	3.1	15	69	--	--	0.28	NP
MW-4	02-09-00	38.10	14.30	ND	23.80	02-09-00	<50	<0.5	0.9	<0.5	<1	55	--	--	0.67	NP
MW-5	03-21-96	37.21	12.60	ND	24.61	03-22-96	<50	<0.5	<0.5	<0.5	<0.5	82	--	--	--	--
MW-5	05-24-96	37.21	13.71	ND	23.50	05-24-96	<50	<0.5	<0.5	<0.5	<0.5	7	--	--	--	--
MW-5	08-09-96	37.21	15.60	ND	21.61	08-09-96	<50	<0.5	<0.5	<0.5	<0.5	8	--	--	--	--
MW-5	11-06-96	37.21	16.36	ND	20.85	11-06-96	<50	<0.5	<0.5	<0.5	<0.5	100	--	--	--	--
MW-5	03-24-97	37.21	13.87	ND	23.34	03-24-97	<50	<0.5	<0.5	<0.5	<0.5	460	--	--	--	--
MW-5	05-27-97	37.21	14.71	ND	22.50	05-28-97	<100	<1	<1	<1	<1	120	--	--	--	--
MW-5	08-07-97	37.21	16.90	ND	20.31	08-07-97	<250	<2.5	<2.5	<2.5	<2.5	250	--	--	--	--
MW-5	11-10-97	37.21	16.88	ND	20.33	11-10-97	<1,000	<10	<10	<10	<10	770	--	--	--	--
MW-5	02-16-98	37.21	10.56	ND	26.65	02-16-98	<200	<2	<2	<2	<2	230	--	--	--	--
MW-5	04-15-98	37.21	12.20	ND	25.01	04-15-98	<500	<5	<5	<5	<5	900	--	--	--	--
MW-5	07-24-98	37.21	14.20	ND	23.01	07-24-98	<500	<5	<5	<5	<5	570	--	--	--	--
MW-5	10-19-98	37.21	15.74	ND	21.47	10-19-98	<250	<2.5	<2.5	<2.5	<2.5	300	--	--	--	--
MW-5	01-28-99	37.21	14.60	ND	22.61	01-28-99	<500	8	<5	<5	<5	290	--	--	--	--
MW-5	06-25-99	37.21	15.10	ND	22.11	06-25-99	<50	<0.5	<0.5	<0.5	<0.5	1,300	--	--	0.76	NP
MW-5	08-25-99	37.21	15.91	ND	21.30	08-25-99	<50	<0.5	<0.5	<0.5	<0.5	6,700	--	--	0.98	NP
MW-5	11-10-99	37.21	15.52	ND	21.69	11-10-99	130	2.0	7.0	1.3	21	5,000	--	--	0.21	NP
MW-5	02-09-00	37.21	14.03	ND	23.18	02-09-00	92	<0.5	0.8	<0.5	1.0	7,900	--	--	0.51	NP
MW-6	03-21-96	37.11	11.55	ND	25.56	03-22-96	<50	<0.5	1.9	<0.5	<0.5	<3	--	--	--	--
MW-6	05-24-96	37.11	12.80	ND	24.31	05-24-96	<50	<0.5	<0.5	<0.5	<0.5	6	--	--	--	--



**Table 1**  
**Historical Groundwater Elevation and Analytical Data**  
**Petroleum Hydrocarbons and Their Constituents**

**ARCO Service Station 2111**  
**1156 Davis Street, San Leandro, California**

Well Designation	Water Level Field Date	Top of Casing Elevation ft-MSL	Depth to Water feet	Free Product Thickness feet	Groundwater Elevation ft-MSL	Water Sample Field Date	TPHG LUFT Method µg/L	Benzene EPA 8021B* µg/L	Toluene EPA 8021B* µg/L	Ethylbenzene EPA 8021B* µg/L	Total Xylenes EPA 8021B* µg/L	MTBE EPA 8021B* µg/L	MTBE EPA 8260 µg/L	TRPH EPA 418.1 LUFT Method µg/L	Dissolved Oxygen mg/L	Purged/Not Purged P/NP
MW-6	08-09-96	37.11	Not surveyed			08-09-96	Not sampled: Car parked on well									
MW-6	11-06-96	37.11	Not surveyed			11-06-96	Not sampled: Car parked on well									
MW-6	03-24-97	37.11	13.06	ND	24.05	03-24-97	<50	<0.5	<0.5	<0.5	<0.5	∆	--	--	--	--
MW-6	05-27-97	37.11	14.30	ND	22.81	05-28-97	<50	<0.5	<0.5	<0.5	<0.5	∆	--	--	--	--
MW-6	08-07-97	37.11	16.40	ND	20.71	08-07-97	<50	<0.5	<0.5	<0.5	<0.5	∆	--	--	--	--
MW-6	11-10-97	37.11	16.53	ND	20.58	11-10-97	<50	<0.5	<0.5	<0.5	<0.5	∆	--	--	--	--
MW-6	02-16-98	37.11	Not surveyed			02-16-98	Not sampled: Car parked on well									
MW-6	04-15-98	37.11	10.95	ND	26.16	04-15-98	<50	<0.5	<0.5	<0.5	<0.5	∆	--	--	--	--
MW-6	07-24-98	37.11	13.30	ND	23.81	07-24-98	<50	<0.5	<0.5	<0.5	<0.5	∆	--	--	--	--
MW-6	10-19-98	37.11	Not surveyed			10-19-98	Not sampled: Car parked on well									
MW-6	01-28-99	37.11	13.92	ND	23.19	01-28-99	<50	<0.5	<0.5	<0.5	<0.5	∆	--	--	--	--
MW-6	06-25-99	37.11	15.47	ND	21.64	06-25-99	<50	<0.5	<0.5	<0.5	<0.5	∆	--	--	--	--
MW-6	08-25-99	37.11	15.39	ND	21.72	08-25-99	<50	<0.5	3.4	0.6	3.7	∆	--	--	0.74	NP
MW-6	11-10-99	37.11	14.92	ND	22.19	11-10-99	<50	<0.5	<0.5	<0.5	<1	∆	--	--	0.92	NP
MW-6	02-09-00	37.11	13.30	ND	23.81	02-09-00	<50	<0.5	0.9	<0.5	1.3	∆	--	--	0.79	NP
MW-7	03-21-96	38.68	13.32	ND	25.36	03-22-96	32,000	870	450	970	4,900	280	--	--	--	--
MW-7	05-24-96	38.68	14.58	ND	24.10	05-24-96	22,000	570	40	42	1,900	<200[2]	--	--	--	--
MW-7	08-09-96	38.68	15.33	ND	23.35	08-09-96	14,000	390	<10	180	470	<200[2]	--	--	--	--
MW-7	11-06-96	38.68	16.95	ND	21.73	11-06-96	9,500	440	<10	210	150	<100[2]	--	--	--	--
MW-7	03-24-97	38.68	14.65	ND	24.03	03-24-97	6,400	420	<10	260	13	480	--	--	--	--
MW-7	05-27-97	38.68	15.58	ND	23.10	05-28-97	5,000	420	<5	230	10	460	--	--	--	--
MW-7	08-07-97	38.68	17.10	ND	21.58	08-07-97	3,900	350	<5	200	10	330	--	--	--	--
MW-7	11-10-97	38.68	18.05	ND	20.63	11-10-97	5,600	590	10	370	43	540	--	--	--	--
MW-7	02-16-98	38.68	12.03	ND	26.65	02-16-98	<5,000	390	<50	<50	61	4,300	--	--	--	--

**Table 1  
Historical Groundwater Elevation and Analytical Data  
Petroleum Hydrocarbons and Their Constituents**

**ARCO Service Station 2111  
1156 Davis Street, San Leandro, California**

Well Designation	Water Level Field Date	Top of Casing Elevation ft-MSL	Depth to Water feet	Free Product Thickness feet	Groundwater Elevation ft-MSL	Water Sample Field Date	TPHG LUFT Method µg/L	Benzene EPA 8021B* µg/L	Toluene EPA 8021B* µg/L	Ethylbenzen EPA 8021B* µg/L	Total Xylenes EPA 8021B* µg/L	MTBE EPA 8021B* µg/L	MTBE EPA 8260 µg/L	TRPH EPA 418.1 LUFT Method µg/L	Dissolved Oxygen mg/L	Purged/Not Purged P/NP
MW-7	04-15-98	38.68	13.02	ND	25.66	04-15-98	<10,000	<100	<100	<100	<100	8,900	--	--	--	
MW-7	07-24-98	38.68	14.18	ND	24.50	07-24-98	5,800	180	<50	74	<50	4,200	--	--	--	
MW-7	10-19-98	38.68	15.99	ND	22.69	10-19-98	<2,500	54	<25	72	<25	3,000	--	--	--	
MW-7	01-28-99	38.68	15.69	ND	22.99	01-28-99	4,500	560	250	<50	94	6,200	--	--	--	
MW-7	06-25-99	38.68	15.36	ND	23.32	06-25-99	3,900	520	160	46	100	45,000	63,000[3]	--	--	0.56 NP
MW-7	08-25-99	38.68	16.71	ND	21.97	08-25-99	3,400	730	77	51	110	62,000	76,000[3]	--	--	0.90 NP
MW-7	11-10-99	38.68	16.76	ND	21.92	11-10-99	15,000	340	19	13	20	55,000	91,000[3]	--	--	0.37 NP
MW-7	02-09-00	38.68	14.45	0.03	24.25 [1]	02-09-00	Not sampled: free product present									

ft-MSL: elevation in feet, relative to mean sea level  
 TPHG: total petroleum hydrocarbons as gasoline, California DHS LUFT Method  
 MTBE: Methyl tert-butyl ether  
 TRPH: total recoverable petroleum hydrocarbons  
 TPHD: total petroleum hydrocarbons as diesel, California DHS LUFT Method  
 \*: EPA method 8020 prior to 11/10/99  
 EPA: United States Environmental Protection Agency  
 µg/L: micrograms per liter  
 mg/L: milligrams per liter  
 ND: none detected  
 --: not available or not analyzed  
 <: less than laboratory detection limit stated to the right  
 [1]: [corrected elevation (Z')] = Z + (h \* 0.73) where: Z = measured elevation, h = floating product thickness, 0.73 = density ratio of oil to water  
 [2]: chromatogram fingerprint is not characteristic of diesel  
 [3]: also analyzed for fuel oxygenates  
 [4]: this value is suspected to be erroneous based on subsequent check by bailer (following day). See discussion

**Table 1. Summary of Groundwater Monitoring Data: Relative Water Elevations and Laboratory Analyses**

**ARCO Service Station #2111, 1156 Davis St, San Leandro, CA**

Well ID and Date Monitored	P/NP	TOC (feet)	Top of Screen (ft bgs)	Bottom of Screen (ft bgs)	DTW (feet)	Water Level Elevation (feet)	Concentrations in µg/L						DO (mg/L)	pH	Footnote
							GRO/TPHg	Benzene	Toluene	Ethyl-Benzene	Total Xylenes	MTBE			
<b>MW-1</b>															
6/26/2000	--	39.60	12.50	26.00	16.46	23.14	--	--	--	--	--	--	--	--	
7/20/2000	--		12.50	26.00	16.89	22.71	360	110	<0.5	<0.5	2.7	2,100	--	--	
9/19/2000	--		12.50	26.00	17.62	21.98	290	76	<0.5	<0.5	2.3	1,500	--	--	
12/21/2000	--		12.50	26.00	17.39	22.21	257	64	2.89	1.31	4.57	1,080/1,060	--	--	
3/13/2001	--		12.50	26.00	15.70	23.90	<500	52.5	<5.0	<5.0	<5.0	1,430/1,370	--	--	
9/18/2001	--		12.50	26.00	18.24	21.36	<500	64	7.3	<5.0	52	810/1,100	--	--	
12/28/2001	--		12.50	26.00	15.95	23.65	<500	<5.0	<5.0	5	22	1,200/1,100	--	--	
3/14/2002	--		12.50	26.00	16.01	23.59	<50	<0.5	<0.5	<0.5	<0.5	34/40	--	--	
4/23/2002	--		12.50	26.00	15.43	24.17	<50	<0.5	<0.5	<0.5	<0.5	30	--	--	
7/17/2002	NP		12.50	26.00	17.50	22.10	<50	1.2	<0.50	<0.50	<0.50	29	6.9	6.9	
10/9/2002	--		12.50	26.00	18.27	21.33	240	4.9	<1.0	4.1	7.0	290	6.5	6.5	c
1/13/2003	--		12.50	26.00	15.37	24.23	760	34	11	17	56	300	6.8	6.8	c
04/07/03	--		12.50	26.00	16.61	22.99	<50	<0.50	<0.50	<0.50	<0.50	22	6.8	6.8	
7/9/2003	--		12.50	26.00	17.27	22.33	<2,500	<25	<25	<25	<25	690	6.7	6.7	
02/05/2004	NP	39.49	12.50	26.00	16.28	23.21	2,800	31	<25	<25	<25	1,100	0.9	6.5	m
04/05/2004	NP		12.50	26.00	16.25	23.24	5,800	46	<25	<25	<25	1,700	1.0	--	
07/13/2004	NP		12.50	26.00	17.57	21.92	<1,000	<10	<10	<10	<10	730	0.5	6.6	
11/04/2004	NP		12.50	26.00	17.78	21.71	560	<5.0	<5.0	<5.0	<5.0	380	0.8	6.5	
01/20/2005	NP		12.50	26.00	15.50	23.99	670	<5.0	<5.0	<5.0	<5.0	570	0.6	6.0	
04/11/2005	NP		12.50	26.00	14.82	24.67	<2,500	<25	<25	<25	25	1,100	0.9	6.9	
08/01/2005	NP		12.50	26.00	16.77	22.72	2,200	33	<10	110	<10	1,400	1.27	7.3	
10/21/2005	NP		12.50	26.00	17.71	21.78	<2,500	<25	<25	<25	<25	970	1.17	6.6	
01/18/2006	NP		12.50	26.00	14.70	24.79	300	<2.5	<2.5	<2.5	<2.5	330	1.07	6.6	n
04/14/2006	NP		12.50	26.00	13.41	26.08	330	<2.5	<2.5	<2.5	<2.5	310	0.79	6.6	
7/19/2006	NP		12.50	26.00	15.86	23.63	<250	<2.5	<2.5	<2.5	<2.5	180	1.2	6.7	q
10/24/2006	P		12.50	26.00	17.15	22.34	710	4.2	<2.5	19	13	360	--	6.68	
1/15/2007	P		12.50	26.00	16.81	22.68	470	2.8	<2.5	14	8.4	220	1.14	7.12	
4/18/2007	NP		12.50	26.00	16.69	22.80	100	<2.5	<2.5	<2.5	<2.5	150	1.20	6.85	
7/17/2007	NP		12.50	26.00	20.85	18.64	<50	<1.0	<1.0	<1.0	<1.0	94	1.91	6.98	
10/11/2007	NP		12.50	26.00	18.10	21.39	66	<0.50	<0.50	<0.50	<0.50	62	1.60	7.00	

**Table 1. Summary of Groundwater Monitoring Data: Relative Water Elevations and Laboratory Analyses**  
**ARCO Service Station #2111, 1156 Davis St, San Leandro, CA**

Well ID and Date Monitored	P/NP	TOC (feet)	Top of Screen (ft bgs)	Bottom of Screen (ft bgs)	DTW (feet)	Water Level Elevation (feet)	Concentrations in µg/L						DO (mg/L)	pH	Footnote
							GRO/TPHg	Benzene	Toluene	Ethyl-Benzene	Total Xylenes	MTBE			
<b>MW-1 Cont.</b>															
1/8/2008	NP	39.49	12.50	26.00	15.97	23.52	140	<0.50	<0.50	<0.50	<0.50	90	1.19	5.60	n
4/8/2008	NP		12.50	26.00	16.53	22.96	88	<0.50	<0.50	<0.50	<0.50	110	1.73	6.89	
8/20/2008	NP		12.50	26.00	18.32	21.17	<50	<0.50	<0.50	<0.50	<0.50	3.3	2.37	6.95	
11/17/2008	NP		12.50	26.00	18.38	21.11	<50	<0.50	<0.50	<0.50	<0.50	21	0.94	6.96	
2/3/2009	NP		12.50	26.00	18.08	21.41	<50	<0.50	<0.50	<0.50	<0.50	16	1.66	6.95	
5/12/2009	NP		12.50	26.00	17.05	22.44	<50	<0.50	<0.50	<0.50	<0.50	9.3	0.88	6.88	
8/13/2009	NP		12.50	26.00	18.01	21.48	<50	<0.50	<0.50	<0.50	<0.50	5.5	0.14	7.02	u
2/18/2010	NP		12.50	26.00	16.14	23.35	<50	<0.50	<0.50	<0.50	<0.50	1.4	2.22	6.69	
7/23/2010	NP		12.50	26.00	17.11	22.38	<50	<0.50	<0.50	<0.50	<0.50	1.3	0.77	6.7	
2/10/2011	NP		12.50	26.00	16.42	23.07	<50	<0.50	<0.50	<0.50	<0.50	1.1	1.19	7.2	
8/30/2011	NP		12.50	26.00	17.13	22.36	<50	<0.50	<0.50	<0.50	<0.50	2.1	0.98	6.9	
<b>2/17/2012</b>	<b>P</b>		<b>12.50</b>	<b>26.00</b>	<b>17.41</b>	<b>22.08</b>	<b>&lt;50</b>	<b>&lt;0.50</b>	<b>&lt;0.50</b>	<b>&lt;0.50</b>	<b>&lt;0.50</b>	<b>0.85</b>	<b>1.39</b>	<b>7.05</b>	
<b>MW-2</b>															
6/26/2000	--	37.99	12.00	26.00	14.60	23.39	--	--	--	--	--	--	--	--	a
7/20/2000	--		12.00	26.00	15.14	22.85	95,000	2,300	18,000	2,500	19,000	13,000	--	--	
9/19/2000	--		12.00	26.00	15.95	22.04	63,000	1,200	6,300	2,000	14,000	19,000	--	--	
12/21/2000	--		12.00	26.00	15.60	22.39	5,010	360	189	213	626	54,300/89,200	--	--	b
12/21/2000	--		12.00	26.00	15.60	22.39	45,900	--	2,130	1,160	9,460	22,400/24,700	--	--	
3/13/2001	--		12.00	26.00	13.77	24.22	<20,000	525	466	408	1,460	91,700/76,000	--	--	b
3/13/2001	--		12.00	26.00	13.77	24.22	3,650	98.1	<5.0	<5.0	6.42	3,590/3,260	--	--	
9/18/2001	--		12.00	26.00	16.86	21.13	--	--	--	--	--	--	--	--	a
12/28/2001	--		12.00	26.00	14.28	23.71	31,000	1,500	3,800	1,300	4,800	9,300/8,800	--	--	
3/14/2002	--		12.00	26.00	14.15	23.84	1,800	25	43	43	270	990/960	--	--	
4/23/2002	--		12.00	26.00	13.60	24.39	9,000	220	110	470	2,500	8,500	--	--	
7/17/2002	NP		12.00	26.00	15.75	22.24	74,000	280	290	820	10,000	19,000/0.4	6.8	6.8	a, c
10/9/02	NP		12.00	26.00	16.69	21.30	--	--	--	--	--	--	--	--	g
1/13/03	--		12.00	26.00	13.59	24.40	--	--	--	--	--	--	--	--	g, h
04/07/03	--		12.00	26.00	14.70	23.29	--	--	--	--	--	--	--	--	g, h
07/09/03	--		12.00	26.00	15.48	22.51	--	--	--	--	--	--	--	--	g, h
02/05/2004	NP	37.86	12.00	26.00	14.43	23.43	--	--	--	--	--	--	--	--	g,m

**Table 1. Summary of Groundwater Monitoring Data: Relative Water Elevations and Laboratory Analyses**  
**ARCO Service Station #2111, 1156 Davis St, San Leandro, CA**

Well ID and Date Monitored	P/NP	TOC (feet)	Top of Screen (ft bgs)	Bottom of Screen (ft bgs)	DTW (feet)	Water Level Elevation (feet)	Concentrations in µg/L						DO (mg/L)	pH	Footnote
							GRO/TPHg	Benzene	Toluene	Ethyl-Benzene	Total Xylenes	MTBE			
<b>MW-2 Cont.</b>															
04/05/2004	NP	37.86	12.00	26.00	14.35	23.51	2,300	33	<5.0	<5.0	200	750	0.6	--	
07/13/2004	NP		12.00	26.00	15.79	22.07	59,000	380	<50	2,100	7,900	5,800	0.3	6.4	
08/31/2004	--		12.00	26.00	15.89	21.97	--	--	--	--	--	--	--	--	
11/04/2004	--		12.00	26.00	15.92	21.94	--	--	--	--	--	--	--	--	g, h
01/20/2005	NP		12.00	26.00	13.71	24.15	30,000	450	<50	1,300	3,300	7,000	0.7	6.2	o
04/11/2005	NP		12.00	26.00	12.70	25.16	11,000	170	<50	580	630	2,700	0.9	6.8	
08/01/2005	NP		12.00	26.00	14.89	22.97	24,000	170	<50	1,100	2,700	2,700	0.64	6.9	
10/21/2005	--		12.00	26.00	16.05	21.81	--	--	--	--	--	--	--	--	a
01/18/2006	NP		12.00	26.00	12.81	25.05	21,000	71	<50	470	1,400	1,600	1.18	6.6	a
04/14/2006	NP		12.00	26.00	12.24	25.62	7,800	78	<50	94	130	2,100	0.81	6.7	a
7/19/2006	NP		12.00	26.00	14.00	23.86	4,900	31	<10	98	75	930	1.1	6.5	q
10/24/2006	--		12.00	26.00	15.38	22.48	--	--	--	--	--	--	--	6.45	g
1/15/2007	P		12.00	26.00	15.00	22.86	5,000	51	<10	49	34	1,400	1.85	7.13	
4/18/2007	NP		12.00	26.00	14.82	23.04	3,000	39	<10	32	22	1,100	1.95	7.10	
7/17/2007	NP		12.00	26.00	18.00	19.86	1,100	53	<10	28	<10	1,300	4.84	7.09	n
10/11/2007	NP		12.00	26.00	16.38	21.48	1,800	17	<10	<10	11	1,000	1.52	7.05	
1/8/2008	NP		12.00	26.00	14.10	23.76	1,900	65	<10	37	28	1,300	1.06	4.22	n
4/8/2008	NP		12.00	26.00	14.70	23.16	200	34	<0.50	<0.50	<0.50	690	3.24	6.95	
8/20/2008	NP		12.00	26.00	16.66	21.20	990	21	<10	<10	<10	190	1.54	6.91	
11/17/2008	NP		12.00	26.00	19.28	18.58	290	9.3	<5.0	<5.0	<5.0	89	0.71	6.75	
2/3/2009	NP		12.00	26.00	16.45	21.41	86	3.5	<2.5	<2.5	<2.5	31	2.71	6.96	
5/12/2009	NP		12.00	26.00	15.30	22.56	390	1.3	<0.50	<0.50	0.82	25	0.82	6.96	
8/13/2009	NP		12.00	26.00	16.88	20.98	330	<10	<10	<10	<10	39	0.81	7.12	u
2/18/2010	NP		12.00	26.00	14.20	23.66	950	<5.0	<5.0	<5.0	<5.0	<5.0	1.18	6.94	
7/23/2010	NP		12.00	26.00	15.37	22.49	330	<2.0	<2.0	<2.0	<2.0	6.5	1.70	6.7	v (GRO)
2/10/2011	NP		12.00	26.00	14.53	23.33	960	<4.0	<4.0	<4.0	<4.0	12	0.58	6.8	v (GRO)
8/30/2011	NP		12.00	26.00	15.35	22.51	200	<0.50	<0.50	<0.50	<0.50	4.5	0.67	6.7	w (GRO)
<b>2/17/2012</b>	<b>P</b>		<b>12.00</b>	<b>26.00</b>	<b>15.63</b>	<b>22.23</b>	<b>190</b>	<b>&lt;2.5</b>	<b>&lt;2.5</b>	<b>&lt;2.5</b>	<b>&lt;2.5</b>	<b>2.9</b>	<b>0.80</b>	<b>7.00</b>	<b>w (GRO)</b>
<b>MW-3</b>															
6/26/2000	--	39.32	12.00	26.00	15.96	23.36	--	--	--	--	--	--	--	--	

**Table 1. Summary of Groundwater Monitoring Data: Relative Water Elevations and Laboratory Analyses**

**ARCO Service Station #2111, 1156 Davis St, San Leandro, CA**

Well ID and Date Monitored	P/NP	TOC (feet)	Top of Screen (ft bgs)	Bottom of Screen (ft bgs)	DTW (feet)	Water Level Elevation (feet)	Concentrations in µg/L						DO (mg/L)	pH	Footnote
							GRO/TPHg	Benzene	Toluene	Ethyl-Benzene	Total Xylenes	MTBE			
<b>MW-3 Cont.</b>															
7/20/2000	--	39.32	12.00	26.00	16.42	22.90	<50	<0.5	<0.5	<0.5	<1.0	130	--	--	
9/19/2000	--		12.00	26.00	17.18	22.14	190	17	<0.5	1.4	2.4	160	--	--	
12/21/2000	--		12.00	26.00	16.97	22.35	187	17.8	<0.5	2.47	2.5	143/125	--	--	
3/13/2001	--		12.00	26.00	15.17	24.15	72.4	2.83	<0.5	<0.5	<0.5	126/122	--	--	
9/18/2001	--		12.00	26.00	17.81	21.51	140	6.4	<0.5	3.5	1.6	110/75	--	--	
12/28/2001	--		12.00	26.00	15.44	23.88	130	5.9	<0.5	0.99	0.55	90/63	--	--	
3/14/2002	--		12.00	26.00	15.50	23.82	<50	<0.5	<0.5	<0.5	<0.5	100/88	--	--	
4/23/2002	--		12.00	26.00	14.96	24.36	<50	<0.5	<0.5	<0.5	<0.5	77	--	--	
7/17/2002	NP		12.00	26.00	17.09	22.23	<50	<0.50	<0.50	<0.50	<0.50	47	7.2	7.2	
10/9/2002	NP		12.00	26.00	17.87	21.45	<50	<0.50	<0.50	<0.50	<0.50	26/29	7.2	7.2	
1/13/2003	NP		12.00	26.00	14.78	24.54	<50	<0.50	<0.50	<0.50	<0.50	59	6.8	6.8	l
04/07/03	NP		12.00	26.00	16.15	23.17	88	<0.50	<0.50	<0.50	<0.50	75	7.0	7.0	
7/9/2003	--		12.00	26.00	16.79	22.53	100	<0.50	<0.50	<0.50	<0.50	52	6.5	6.5	
02/05/2004	NP	39.19	12.00	26.00	15.66	23.53	240	<0.50	<0.50	<0.50	<0.50	37	0.5	--	m
04/05/2004	NP		12.00	26.00	15.78	23.41	140	<0.50	<0.50	<0.50	0.60	53	1.0	6.6	
07/13/2004	NP		12.00	26.00	17.20	21.99	120	<0.50	<0.50	<0.50	<0.50	35	0.8	6.7	
11/04/2004	NP		12.00	26.00	17.32	21.87	160	<0.50	<0.50	<0.50	<0.50	25	0.8	6.5	
01/20/2005	NP		12.00	26.00	15.07	24.12	160	<0.50	<0.50	<0.50	<0.50	27	0.6	6.1	
04/11/2005	NP		12.00	26.00	14.24	24.95	<50	<0.50	<0.50	<0.50	<0.50	21	0.6	6.1	
08/01/2005	NP		12.00	26.00	16.29	22.90	<50	<0.50	<0.50	<0.50	<0.50	23	1.04	7.2	
10/21/2005	NP		12.00	26.00	17.41	21.78	88	<0.50	<0.50	<0.50	<0.50	19	1.9	6.6	
01/18/2006	NP		12.00	26.00	13.80	25.39	73	<0.50	<0.50	<0.50	<0.50	13	1.13	6.6	
04/14/2006	NP		12.00	26.00	12.55	26.64	<50	<0.50	<0.50	<0.50	<0.50	6.7	0.71	6.6	
7/19/2006	NP		12.00	26.00	15.04	24.15	<50	<0.50	<0.50	<0.50	<0.50	11	2.0	6.6	q
10/24/2006	P		12.00	26.00	16.45	22.74	<50	<0.50	<0.50	<0.50	<0.50	33	--	6.77	
1/15/2007	P		12.00	26.00	16.00	23.19	<50	<0.50	<0.50	0.61	<0.50	29	1.11	7.03	
4/18/2007	NP		12.00	26.00	15.87	23.32	<50	<0.50	<0.50	<0.50	<0.50	9.5	1.67	7.07	
7/17/2007	NP		12.00	26.00	19.40	19.79	<50	<0.50	<0.50	<0.50	<0.50	19	4.25	7.27	
10/11/2007	NP		12.00	26.00	17.43	21.76	<50	<0.50	<0.50	<0.50	<0.50	5.3	1.62	7.10	
1/8/2008	NP		12.00	26.00	15.16	24.03	<50	<0.50	<0.50	<0.50	<0.50	8.9	2.02	6.94	

**Table 1. Summary of Groundwater Monitoring Data: Relative Water Elevations and Laboratory Analyses**

**ARCO Service Station #2111, 1156 Davis St, San Leandro, CA**

Well ID and Date Monitored	P/NP	TOC (feet)	Top of Screen (ft bgs)	Bottom of Screen (ft bgs)	DTW (feet)	Water Level Elevation (feet)	Concentrations in µg/L						DO (mg/L)	pH	Footnote
							GRO/TPHg	Benzene	Toluene	Ethyl-Benzene	Total Xylenes	MTBE			
<b>MW-3 Cont.</b>															
4/8/2008	NP	39.19	12.00	26.00	15.75	23.44	<50	<0.50	<0.50	<0.50	<0.50	<0.50	1.98	6.80	
8/20/2008	NP		12.00	26.00	17.65	21.54	<50	<0.50	<0.50	<0.50	<0.50	<0.50	2.85	7.62	
11/17/2008	NP		12.00	26.00	17.76	21.43	<50	<0.50	<0.50	<0.50	<0.50	3.6	1.36	6.90	
2/3/2009	NP		12.00	26.00	17.36	21.83	<50	<0.50	<0.50	<0.50	<0.50	2.1	2.55	7.04	
5/12/2009	NP		12.00	26.00	16.30	22.89	<50	<0.50	<0.50	<0.50	<0.50	2.1	1.68	6.98	
8/13/2009	NP		12.00	26.00	18.75	20.44	<50	<0.50	<0.50	<0.50	<0.50	2.7	0.15	7.03	
2/18/2010	NP		12.00	26.00	15.31	23.88	<50	<0.50	<0.50	<0.50	<0.50	0.59	2.07	6.83	v (GRO)
7/23/2010	NP		12.00	26.00	16.34	22.85	<50	<0.50	<0.50	<0.50	<0.50	0.85	1.23	7.4	
2/10/2011	NP		12.00	26.00	15.63	23.56	<50	<0.50	<0.50	<0.50	<0.50	0.51	2.11	6.9	
8/30/2011	NP		12.00	26.00	16.45	22.74	<50	<0.50	<0.50	<0.50	<0.50	<0.50	0.83	6.9	
<b>2/17/2012</b>	<b>P</b>		<b>12.00</b>	<b>26.00</b>	<b>16.70</b>	<b>22.49</b>	<b>&lt;50</b>	<b>&lt;0.50</b>	<b>&lt;0.50</b>	<b>&lt;0.50</b>	<b>&lt;0.50</b>	<b>&lt;0.50</b>	<b>0.85</b>	<b>7.12</b>	
<b>MW-4</b>															
6/26/2000	--	38.10	10.00	24.00	14.59	23.51	--	--	--	--	--	--	--	--	
7/20/2000	--		10.00	24.00	15.04	23.06	97	7.9	<0.5	<0.5	1.1	51	--	--	
9/19/2000	--		10.00	24.00	15.83	22.27	110	7	<0.5	<0.5	<1.0	60	--	--	
12/21/2000	--		10.00	24.00	15.59	22.51	120	5.6	<0.5	1.72	<0.5	46.3/48.6	--	--	
3/13/2001	--		10.00	24.00	13.73	24.37	76	0.796	<0.5	<0.5	<0.5	53.7/50	--	--	
9/18/2001	--		10.00	24.00	16.50	21.60	<50	<0.5	<0.5	<0.5	<0.5	25/26	--	--	
12/28/2001	--		10.00	24.00	14.03	24.07	<50	<0.5	<0.5	<0.5	<0.5	15/11	--	--	
3/14/2002	--		10.00	24.00	14.10	24.00	<50	<0.5	<0.5	<0.5	<0.5	31/28	--	--	
4/23/2002	--		10.00	24.00	13.57	24.53	<50	2.8	<0.5	<0.5	<0.5	42	--	--	
7/17/2002	NP		10.00	24.00	15.76	22.34	<50	<0.50	<0.50	<0.50	<0.50	16	7.1	7.1	
10/9/2002	NP		10.00	24.00	16.59	21.51	<50	2.2	<0.50	<0.50	<0.50	20/23	7.1	7.1	
1/13/2003	NP		10.00	24.00	13.43	24.67	52	<0.50	1.6	<0.50	<0.50	22	6.6	6.6	d
04/07/03	NP		10.00	24.00	14.74	23.36	65	<0.50	<0.50	<0.50	<0.50	24	6.6	6.6	
7/9/2003	--		10.00	24.00	15.44	22.66	120	<0.50	<0.50	<0.50	<0.50	34	6.6	6.6	
02/05/2004	NP	37.99	10.00	24.00	14.39	23.60	120	<0.50	<0.50	<0.50	<0.50	22	0.5	6.6	m
04/05/2004	NP		10.00	24.00	14.37	23.62	110	<0.50	<0.50	<0.50	<0.50	27	1.1	6.5	
07/13/2004	NP		10.00	24.00	15.96	22.03	77	<0.50	<0.50	<0.50	<0.50	27	0.6	6.6	
11/04/2004	NP		10.00	24.00	16.02	21.97	<50	<0.50	<0.50	<0.50	<0.50	19	1.2	6.7	

**Table 1. Summary of Groundwater Monitoring Data: Relative Water Elevations and Laboratory Analyses**  
**ARCO Service Station #2111, 1156 Davis St, San Leandro, CA**

Well ID and Date Monitored	P/NP	TOC (feet)	Top of Screen (ft bgs)	Bottom of Screen (ft bgs)	DTW (feet)	Water Level Elevation (feet)	Concentrations in µg/L						DO (mg/L)	pH	Footnote
							GRO/TPHg	Benzene	Toluene	Ethyl-Benzene	Total Xylenes	MTBE			
<b>MW-4 Cont.</b>															
01/20/2005	NP	37.99	10.00	24.00	13.72	24.27	65	<0.50	<0.50	<0.50	<0.50	18	0.6	6.1	
04/11/2005	NP		10.00	24.00	12.80	25.19	51	<0.50	<0.50	<0.50	<0.50	14	0.7	6.2	
08/01/2005	NP		10.00	24.00	14.88	23.11	<50	<0.50	<0.50	<0.50	<0.50	18	1.46	7.3	
10/21/2005	NP		10.00	24.00	15.01	22.98	<50	<0.50	<0.50	<0.50	<0.50	15	1.24	7.6	
01/18/2006	NP		10.00	24.00	12.92	25.07	<50	<0.50	<0.50	<0.50	<0.50	8.9	0.77	6.5	
04/14/2006	NP		10.00	24.00	11.41	26.58	<50	<0.50	<0.50	<0.50	<0.50	4.2	0.84	6.6	
7/19/2006	NP		10.00	24.00	13.86	24.13	<50	<0.50	<0.50	<0.50	<0.50	3.4	1.0	6.7	
10/24/2006	P		10.00	24.00	15.35	22.64	<50	<0.50	<0.50	2.0	<0.50	3.5	--	6.90	
1/15/2007	P		10.00	24.00	14.96	23.03	<50	<0.50	<0.50	0.96	<0.50	3.8	--	7.04	
4/18/2007	NP		10.00	24.00	14.80	23.19	<50	<0.50	<0.50	<0.50	<0.50	5.6	5.33	6.93	
7/17/2007	NP		10.00	24.00	16.10	21.89	<50	<0.50	<0.50	<0.50	<0.50	6.6	3.73	6.87	
10/11/2007	NP		10.00	24.00	16.45	21.54	<50	<0.50	<0.50	<0.50	<0.50	0.81	2.68	7.07	
1/8/2008	NP		10.00	24.00	14.10	23.89	<50	<0.50	<0.50	<0.50	<0.50	1.2	3.50	6.74	
4/8/2008	NP		10.00	24.00	14.68	23.31	<50	<0.50	<0.50	<0.50	<0.50	1.7	2.54	6.80	
8/20/2008	NP		10.00	24.00	16.65	21.34	<50	<0.50	<0.50	<0.50	<0.50	0.70	2.36	6.90	
11/17/2008	NP		10.00	24.00	16.73	21.26	<50	<0.50	<0.50	<0.50	<0.50	0.73	1.07	6.83	
2/3/2009	NP		10.00	24.00	16.36	21.63	<50	<0.50	<0.50	<0.50	<0.50	0.67	3.92	7.34	
5/12/2009	NP		10.00	24.00	15.26	22.73	<50	<0.50	<0.50	<0.50	<0.50	0.62	0.81	6.98	
8/13/2009	NP		10.00	24.00	16.87	21.12	<50	<0.50	<0.50	<0.50	<0.50	0.65	0.94	7.12	u
2/18/2010	NP		10.00	24.00	14.22	23.77	<50	<0.50	<0.50	<0.50	<0.50	<0.50	1.20	6.25	
7/23/2010	NP		10.00	24.00	15.36	22.63	<50	<0.50	<0.50	<0.50	<0.50	0.52	0.68	7.0	
2/10/2011	NP		10.00	24.00	14.54	23.45	<50	<0.50	<0.50	<0.50	<0.50	<0.50	0.52	6.8	
8/30/2011	NP		10.00	24.00	15.38	22.61	<50	<0.50	<0.50	<0.50	<0.50	<0.50	1.03	7.0	
<b>2/17/2012</b>	<b>P</b>		<b>10.00</b>	<b>24.00</b>	<b>15.66</b>	<b>22.33</b>	<b>&lt;50</b>	<b>&lt;0.50</b>	<b>&lt;0.50</b>	<b>&lt;0.50</b>	<b>&lt;0.50</b>	<b>&lt;0.50</b>	<b>0.96</b>	<b>7.06</b>	
<b>MW-5</b>															
6/26/2000	--	37.21	9.50	23.50	14.27	22.94	--	--	--	--	--	--	--	--	
7/20/2000	--		9.50	23.50	14.69	22.52	55	<0.5	<0.5	<0.5	<1.0	14,000	--	--	
9/19/2000	--		9.50	23.50	15.36	21.85	54	<0.5	<0.5	<0.5	<1.0	13,000	--	--	
12/21/2000	--		9.50	23.50	15.15	22.06	72.9	2.51	<0.5	<0.5	0.961	19,200/21,200	--	--	
3/13/2001	--		9.50	23.50	13.50	23.71	<500	<5	<5	<5	<5	15,900/20,000	--	--	



**Table 1. Summary of Groundwater Monitoring Data: Relative Water Elevations and Laboratory Analyses**  
**ARCO Service Station #2111, 1156 Davis St, San Leandro, CA**

Well ID and Date Monitored	P/NP	TOC (feet)	Top of Screen (ft bgs)	Bottom of Screen (ft bgs)	DTW (feet)	Water Level Elevation (feet)	Concentrations in µg/L						DO (mg/L)	pH	Footnote
							GRO/TPHg	Benzene	Toluene	Ethyl-Benzene	Total Xylenes	MTBE			
<b>MW-5 Cont.</b>															
9/18/2001	--	37.21	9.50	23.50	15.94	21.27	<10,000	<100	<100	<100	<1,000	22,000/20,000	--	--	
12/28/2001	--		9.50	23.50	13.45	23.76	<10,000	<100	<100	<100	<100	10,000/10,000	--	--	
3/14/2002	--		9.50	23.50	13.82	23.39	<5,000	<50	<50	<50	<50	7,100/7,700	--	--	
4/23/2002	--		9.50	23.50	13.25	23.96	<5,000	<50	<50	<50	<50	8,900	--	--	
7/17/2002	NP		9.50	23.50	15.27	21.94	7,900	<50	<50	<50	<50	13,000	7.5	7.5	d
10/9/2002	NP		9.50	23.50	16.02	21.19	2,400	<20	<20	<20	<20	7,300/7,500	6.7	6.7	e
1/13/2003	NP		9.50	23.50	13.20	24.01	6,400	<50	<50	<50	<50	8,900	6.8	6.8	e, k, j
04/07/03	NP		9.50	23.50	14.42	22.79	<10,000	<100	<100	<100	<100	3,700	6.8	6.8	
7/9/2003	--		9.50	23.50	15.01	22.20	11,000	<50	<50	<50	<50	6,500	6.9	6.9	
02/05/2004	NP	37.12	9.50	23.50	14.10	23.02	8,100	<50	<50	<50	<50	7,900	1.5	--	m
04/05/2004	NP		9.50	23.50	14.14	22.98	4,000	<25	<25	<25	<25	2,000	1.0	6.6	
07/13/2004	NP		9.50	23.50	15.37	21.75	<5,000	<50	<50	<50	<50	4,000	0.8	6.7	
11/04/2004	NP		9.50	23.50	15.53	21.59	7,400	<50	<50	<50	<50	6,300	3.5	6.7	
01/20/2005	NP		9.50	23.50	13.51	23.61	6,500	<50	<50	<50	<50	6,900	0.7	6.5	n
04/11/2005	NP		9.50	23.50	12.75	24.37	<5,000	<50	<50	<50	<50	2,600	0.5	7.0	
08/01/2005	NP		9.50	23.50	14.59	22.53	110	<1.0	<1.0	<1.0	<1.0	130	1.36	7.5	
10/21/2005	NP		9.50	23.50	15.57	21.55	<250	<2.5	<2.5	<2.5	<2.5	86	1.53	6.8	
01/18/2006	NP		9.50	23.50	12.60	24.52	<250	<2.5	<2.5	<2.5	<2.5	100	1.2	6.7	
04/14/2006	NP		9.50	23.50	11.74	25.38	310	<2.5	<2.5	<2.5	<2.5	240	0.93	6.6	
7/19/2006	NP		9.50	23.50	13.78	23.34	<50	<2.5	<2.5	<2.5	<2.5	84	1.2	6.6	
10/24/2006	P		9.50	23.50	14.95	22.17	61	<0.50	<0.50	<0.50	<0.50	17	--	6.69	
1/15/2007	P		9.50	23.50	14.63	22.49	73	<0.50	<0.50	<0.50	<0.50	36	2.8	6.73	
4/18/2007	NP		9.50	23.50	14.50	22.62	93	<2.5	<2.5	<2.5	<2.5	16	1.66	6.84	n, EBZ present in method blank
7/17/2007	NP		9.50	23.50	15.55	21.57	53	<2.5	<2.5	<2.5	<2.5	6.6	5.02	7.02	n
10/11/2007	NP		9.50	23.50	15.83	21.29	<50	<0.50	<0.50	<0.50	<0.50	4.8	2.92	7.23	
1/8/2008	NP		9.50	23.50	13.82	23.30	<50	<0.50	<0.50	<0.50	<0.50	5.6	1.80	6.91	
4/8/2008	NP		9.50	23.50	14.38	22.74	<50	<0.50	<0.50	<0.50	<0.50	8.0	1.14	6.76	
8/20/2008	NP		9.50	23.50	16.11	21.01	<50	<1.0	<1.0	<1.0	<1.0	3.6	1.65	6.86	
11/17/2008	NP		9.50	23.50	16.15	20.97	<50	<0.50	<0.50	<0.50	<0.50	1.3	0.66	6.93	
2/3/2009	NP		9.50	23.50	15.83	21.29	<50	<0.50	<0.50	<0.50	<0.50	<0.50	2.38	6.77	

**Table 1. Summary of Groundwater Monitoring Data: Relative Water Elevations and Laboratory Analyses**  
**ARCO Service Station #2111, 1156 Davis St, San Leandro, CA**

Well ID and Date Monitored	P/NP	TOC (feet)	Top of Screen (ft bgs)	Bottom of Screen (ft bgs)	DTW (feet)	Water Level Elevation (feet)	Concentrations in µg/L						DO (mg/L)	pH	Footnote
							GRO/TPHg	Benzene	Toluene	Ethyl-Benzene	Total Xylenes	MTBE			
<b>MW-5 Cont.</b>															
5/12/2009	NP	37.12	9.50	23.50	14.48	22.64	<50	<0.50	<0.50	<0.50	<0.50	2.5	0.41	6.83	
8/13/2009	NP		9.50	23.50	16.30	20.82	<50	<1.0	<1.0	<1.0	<1.0	1.3	0.78	7.06	u
2/18/2010	NP		9.50	23.50	13.95	23.17	<50	<0.50	<0.50	<0.50	<0.50	2.2	1.36	6.40	
7/23/2010	NP		9.50	23.50	14.98	22.14	<50	<0.50	<0.50	<0.50	<0.50	<0.50	0.75	7.2	
2/10/2011	NP		9.50	23.50	14.24	22.88	<50	<0.50	<0.50	<0.50	<0.50	0.73	0.83	6.7	
8/30/2011	NP		9.50	23.50	14.99	22.13	<50	<0.50	<0.50	<0.50	<0.50	1.9	1.64	8.2	
<b>2/17/2012</b>	<b>P</b>		<b>9.50</b>	<b>23.50</b>	<b>15.16</b>	<b>21.96</b>	<b>&lt;50</b>	<b>&lt;0.50</b>	<b>&lt;0.50</b>	<b>&lt;0.50</b>	<b>&lt;0.50</b>	<b>0.98</b>	<b>0.85</b>	<b>7.05</b>	
<b>MW-6</b>															
6/26/2000	--	37.11	10.00	25.00	13.46	23.65	--	--	--	--	--	--	--	--	
7/20/2000	--		10.00	25.00	13.94	23.17	<50	<0.5	<0.5	<0.5	<1.0	<3.0	--	--	
9/19/2000	--		10.00	25.00	14.41	22.70	<50	<0.5	<0.5	<0.5	<1.0	<3.0	--	--	
12/21/2000	--		10.00	25.00	14.53	22.58	<50	<0.5	<0.5	<0.5	<0.5	<2.5	--	--	
3/13/2001	--		10.00	25.00	12.67	24.44	<50	<0.5	<0.5	<0.5	<0.5	<2.5	--	--	
9/18/2001	--		10.00	25.00	15.42	21.69	<50	<0.5	<0.5	<0.5	<0.5	<2.5/<2.0	--	--	
12/28/2001	--		10.00	25.00	12.96	24.15	<50	<0.5	<0.5	<0.5	<0.5	12/<0.5	--	--	
3/14/2002	--		10.00	25.00	12.98	24.13	<50	<0.5	<0.5	<0.5	<0.5	<2.5	--	--	
4/23/2002	--		10.00	25.00	12.44	24.67	<50	<0.5	<0.5	<0.5	<0.5	3.1	--	--	
7/17/2002	NP		10.00	25.00	14.65	22.46	<50	<0.50	<0.50	<0.50	<0.50	<2.5	7.3	7.3	
10/9/2002	NP		10.00	25.00	15.51	21.60	<50	<0.50	<0.50	<0.50	<0.50	<2.5	7.1	7.1	
1/13/2003	NP		10.00	25.00	12.27	24.84	<50	<0.50	<0.50	<0.50	<0.50	<2.5	6.8	6.8	
04/07/03	NP		10.00	25.00	13.61	23.50	<50	<0.50	<0.50	<0.50	<0.50	<0.50	6.6	6.6	
7/9/2003	--		10.00	25.00	14.34	22.77	<50	<0.50	<0.50	<0.50	<0.50	<0.50	7	7.0	
02/05/2004	--		10.00	25.00	13.38	23.73	--	--	--	--	--	--	--	--	m
04/05/2004	--		10.00	25.00	13.31	23.80	--	--	--	--	--	--	--	--	
07/13/2004	NP		10.00	25.00	14.65	22.46	<50	<0.50	<0.50	<0.50	<0.50	<0.50	2.7	6.8	
11/04/2004	--		10.00	25.00	14.95	22.16	--	--	--	--	--	--	--	--	
01/20/2005	--		10.00	25.00	12.57	24.54	--	--	--	--	--	--	--	--	
04/11/2005	--		10.00	25.00	12.05	25.06	--	--	--	--	--	--	--	--	
08/01/2005	NP		10.00	25.00	13.79	23.32	<50	<0.50	<0.50	<0.50	<0.50	<0.50	1.15	7.6	
10/21/2005	--		10.00	25.00	14.60	22.51	--	--	--	--	--	--	--	--	

**Table 1. Summary of Groundwater Monitoring Data: Relative Water Elevations and Laboratory Analyses**  
**ARCO Service Station #2111, 1156 Davis St, San Leandro, CA**

Well ID and Date Monitored	P/NP	TOC (feet)	Top of Screen (ft bgs)	Bottom of Screen (ft bgs)	DTW (feet)	Water Level Elevation (feet)	Concentrations in µg/L						DO (mg/L)	pH	Footnote
							GRO/TPHg	Benzene	Toluene	Ethyl-Benzene	Total Xylenes	MTBE			
<b>MW-6 Cont.</b>															
01/18/2006	--	37.11	10.00	25.00	11.80	25.31	--	--	--	--	--	--	--	--	
04/14/2006	--		10.00	25.00	10.92	26.19	--	--	--	--	--	--	--	--	
7/19/2006	NP		10.00	25.00	12.92	24.19	<50	<0.50	<0.50	<0.50	<0.50	<0.50	1.3	6.9	
10/24/2006	--		10.00	25.00	14.23	22.88	--	--	--	--	--	--	--	--	
1/15/2007	--		10.00	25.00	13.80	23.31	--	--	--	--	--	--	--	--	
4/18/2007	--		10.00	25.00	13.67	23.44	--	--	--	--	--	--	--	--	
7/17/2007	NP		10.00	25.00	14.08	23.03	<50	<0.50	<0.50	<0.50	<0.50	<0.50	4.40	7.02	
10/11/2007	--		10.00	25.00	15.28	21.83	--	--	--	--	--	--	--	--	
1/8/2008	--		10.00	25.00	13.08	24.03	--	--	--	--	--	--	--	--	
4/8/2008	--		10.00	25.00	13.52	23.59	--	--	--	--	--	--	--	--	
8/20/2008	NP		10.00	25.00	15.59	21.52	<50	<0.50	<0.50	<0.50	<0.50	<0.50	1.66	6.83	
11/17/2008	--		10.00	25.00	15.61	21.50	--	--	--	--	--	--	--	--	
2/3/2009	--		10.00	25.00	15.23	21.88	--	--	--	--	--	--	--	--	
5/12/2009	--		10.00	25.00	14.09	23.02	--	--	--	--	--	--	--	--	
8/13/2009	NP		10.00	25.00	15.80	21.31	<50	<0.50	<0.50	<0.50	<0.50	<0.50	0.85	7.02	u
2/18/2010	--		10.00	25.00	12.96	24.15	--	--	--	--	--	--	--	--	
7/23/2010	NP		10.00	25.00	13.91	23.20	210	<0.50	<0.50	<0.50	<0.50	<0.50	0.65	6.73	
2/10/2011	--		10.00	25.00	13.15	23.96	--	--	--	--	--	--	--	--	
8/30/2011	NP		10.00	25.00	13.10	24.01	<50	<0.50	<0.50	<0.50	<0.50	<0.50	1.60	7.2	
<b>2/17/2012</b>	<b>--</b>		<b>10.00</b>	<b>25.00</b>	<b>14.46</b>	<b>22.65</b>	<b>--</b>	<b>--</b>	<b>--</b>	<b>--</b>	<b>--</b>	<b>--</b>	<b>--</b>	<b>--</b>	
<b>MW-7</b>															
6/26/2000	--	38.68	12.00	27.00	14.34	24.34	--	--	--	--	--	--	--	--	
7/20/2000	--		12.00	27.00	15.26	23.42	14,000	5.4	<0.5	2.8	5.9	71,000	--	--	
9/19/2000	--		12.00	27.00	15.70	22.98	8,400	420	38	470	220	5,600	--	--	
12/21/2000	--		12.00	27.00	16.02	22.66	--	--	--	--	--	--	--	--	
3/13/2001	--		12.00	27.00	14.18	24.50	<2,000	154	63	46.3	127	75,000/160,000	--	--	
9/18/2001	--		12.00	27.00	17.02	21.66	<100,000	1,900	<1,000	<1,000	2,800	90,000/370,000	--	--	
12/28/2001	--		12.00	27.00	14.81	23.87	<20,000	<200	<200	<200	<200	84,000/72,000	--	--	
3/14/2002	--		12.00	27.00	14.60	24.08	<50,000	<500	<500	<500	<500	85,000/85,000	--	--	
4/23/2002	--		12.00	27.00	13.94	24.74	<20,000	530	200	220	800	67,000	--	--	

**Table 1. Summary of Groundwater Monitoring Data: Relative Water Elevations and Laboratory Analyses**  
**ARCO Service Station #2111, 1156 Davis St, San Leandro, CA**

Well ID and Date Monitored	P/NP	TOC (feet)	Top of Screen (ft bgs)	Bottom of Screen (ft bgs)	DTW (feet)	Water Level Elevation (feet)	Concentrations in µg/L						DO (mg/L)	pH	Footnote
							GRO/TPHg	Benzene	Toluene	Ethyl-Benzene	Total Xylenes	MTBE			
<b>MW-7 Cont.</b>															
7/17/2002	NP	38.68	12.00	27.00	16.27	22.41	26,000	720	<250	<250	860	120,000	6.9	6.9	d
10/9/2002	NP		12.00	27.00	17.16	21.52	110,000	1,500	4,400	820	5,400	97,000/120,000	6.8	6.8	d
1/13/2003	NP		12.00	27.00	13.82	24.86	<50,000	<500	<500	<500	2,200	33,000	6.6	6.6	f
04/07/03	NP		12.00	27.00	14.52	24.16	<2,500	30	<25	<25	<25	710	7.0	7.0	
7/9/2003	--		12.00	27.00	15.97	22.71	66,000	<500	<500	<500	<500	36,000	6.7	6.7	
02/05/2004	NP	38.54	12.00	27.00	14.75	23.79	55,000	300	<250	<250	<250	34,000	1.0	6.7	m
04/05/2004	NP		12.00	27.00	14.63	23.91	62,000	520	<250	<250	380	37,000	1.0	6.7	
07/13/2004	NP		12.00	27.00	16.31	22.23	<100,000	<1,000	<1,000	<1,000	<1,000	56,000	0.7	6.7	
11/04/2004	--		12.00	27.00	16.46	22.08	70,000	<500	<500	<500	<500	71,000	2.0	6.6	
01/20/2005	NP		12.00	27.00	14.05	24.49	34,000	<250	<250	<250	<250	36,000	0.6	6.3	n
04/11/2005	NP		12.00	27.00	12.55	25.99	<2,500	46	<25	<25	<25	1,200	0.7	6.8	
08/01/2005	NP		12.00	27.00	15.11	23.43	<25,000	<250	<250	<250	<250	4,800	1.78	7.3	
10/21/2005	NP		12.00	27.00	15.65	22.89	14,000	350	<100	<100	110	12,000	1.41	6.6	p
01/18/2006	NP		12.00	27.00	12.60	25.94	16,000	310	<100	<100	110	13,000	0.87	6.7	
04/14/2006	NP		12.00	27.00	12.09	26.45	<10,000	<100	<100	<100	<100	4,700	0.88	6.9	
7/19/2006	NP		12.00	27.00	13.58	24.96	1,300	23	<10	18	26	1,600	1.1	6.8	q
10/24/2006	P		12.00	27.00	15.13	23.41	6,800	100	<5.0	16	15	14,000	--	6.93	
1/15/2007	P		12.00	27.00	14.43	24.11	2,500	<100	<100	<100	<100	3,900	2.12	7.44	n
4/18/2007	NP		12.00	27.00	14.30	24.24	3,000	50	<50	<50	<50	2,700	4.47	7.22	n
7/17/2007	NP		12.00	27.00	23.75	14.79	560	<25	<25	<25	<25	890	4.23	7.41	n
10/11/2007	NP		12.00	27.00	16.18	22.36	210	<2.5	<2.5	<2.5	<2.5	370	2.99	7.33	t (GRO)
1/8/2008	NP		12.00	27.00	13.90	24.64	5,100	45	<25	<25	<25	6,100	2.50	7.23	n
4/8/2008	NP		12.00	27.00	14.22	24.32	270	0.50	<0.50	1.2	0.66	1,200	1.67	7.17	
8/20/2008	NP		12.00	27.00	16.57	21.97	<50	<0.50	<0.50	<0.50	<0.50	39	2.12	7.04	
11/17/2008	NP		12.00	27.00	22.91	15.63	68	1.8	1.9	0.54	2.0	28	1.14	6.95	
2/3/2009	NP		12.00	27.00	17.86	20.68	<50	<0.50	<0.50	<0.50	<0.50	18	2.58	6.97	
5/12/2009	NP		12.00	27.00	15.36	23.18	110	2.0	<0.50	<0.50	2.9	390	0.72	7.14	
8/13/2009	NP		12.00	27.00	24.10	14.44	<50	<0.50	<0.50	<0.50	<0.50	21	0.84	7.11	u
2/18/2010	NP		12.00	27.00	14.21	24.33	190	<25	<25	<25	<25	1,300	1.52	7.06	v (GRO)
7/23/2010	NP		12.00	27.00	15.50	23.04	<50	<0.50	<0.50	<0.50	<0.50	1,000	0.57	6.89	v (GRO)

**Table 1. Summary of Groundwater Monitoring Data: Relative Water Elevations and Laboratory Analyses**  
**ARCO Service Station #2111, 1156 Davis St, San Leandro, CA**

Well ID and Date Monitored	P/NP	TOC (feet)	Top of Screen (ft bgs)	Bottom of Screen (ft bgs)	DTW (feet)	Water Level Elevation (feet)	Concentrations in µg/L						DO (mg/L)	pH	Footnote
							GRO/TPHg	Benzene	Toluene	Ethyl-Benzene	Total Xylenes	MTBE			
<b>MW-7 Cont.</b>															
2/10/2011	P	38.54	12.00	27.00	14.44	24.10	440	<25	<25	<25	<25	310	0.76	7.0	v (GRO)
8/30/2011	NP		12.00	27.00	15.10	23.44	480	<25	<25	<25	<25	180	0.80	6.9	w (GRO)
<b>2/17/2012</b>	<b>P</b>		<b>12.00</b>	<b>27.00</b>	<b>15.46</b>	<b>23.08</b>	<b>220</b>	<b>0.84</b>	<b>&lt;0.50</b>	<b>&lt;0.50</b>	<b>&lt;0.50</b>	<b>110</b>	<b>1.99</b>	<b>7.50</b>	<b>w (GRO)</b>
<b>MW-8</b>															
02/05/2004	P	38.91	--	--	15.61	23.30	3,600	<25	<25	<25	<25	1,900	6.9	6.8	m
04/05/2004	P		--	--	15.64	23.27	1,900	<10	<10	<10	<10	1,200	3.2	6.7	
07/13/2004	P		--	--	17.22	21.69	<1,000	<10	<10	<10	<10	760	1.6	6.7	
11/04/2004	P		--	--	17.19	21.72	960	<5.0	<5.0	<5.0	<5.0	820	1.8	6.7	
01/20/2005	P		--	--	15.25	23.66	<2,500	<25	<25	<25	<25	1,400	1.5	6.4	
04/11/2005	P		--	--	14.17	24.74	700	<5.0	<5.0	<5.0	<5.0	610	1.1	7.1	
08/01/2005	P		--	--	16.10	22.81	<1,000	<10	<10	<10	<10	900	2.58	7.7	
10/21/2005	P		--	--	17.18	21.73	530	<5.0	<5.0	<5.0	<5.0	490	1.4	6.7	n
01/18/2006	P		--	--	13.60	25.31	<500	<5.0	<5.0	<5.0	<5.0	500	2.28	6.6	
04/14/2006	P		--	--	12.36	26.55	<500	<5.0	<5.0	<5.0	<5.0	300	1.97	6.6	
7/19/2006	P		--	--	14.75	24.16	4,500	<25	<25	<25	<25	4,200	1.2	6.6	
10/24/2006	--		--	--	--	--	--	--	--	--	--	--	--	--	s
1/15/2007	P		--	--	15.67	23.24	<50	<0.50	<0.50	<0.50	<0.50	67	1.35	6.68	
4/18/2007	P		--	--	15.53	23.38	100	0.51	<0.50	<0.50	<0.50	130	1.49	6.86	n
7/17/2007	NP		--	--	16.76	22.15	63	<0.50	<0.50	<0.50	<0.50	96	1.85	6.97	n
10/11/2007	P		--	--	16.99	21.92	100	0.52	<0.50	<0.50	<0.50	130	1.67	7.18	
1/8/2008	P		--	--	14.83	24.08	51	<0.50	<0.50	<0.50	<0.50	49	1.30	6.88	n
4/8/2008	P		--	--	15.38	23.53	<50	<0.50	<0.50	<0.50	<0.50	32	1.60	6.77	
8/20/2008	P		--	--	17.80	21.11	<50	<0.50	<0.50	<0.50	<0.50	13	1.18	6.94	
11/17/2008	P		--	--	17.47	21.44	<50	<0.50	<0.50	<0.50	<0.50	14	3.74	6.63	
2/3/2009	P		--	--	16.96	21.95	<50	<0.50	<0.50	<0.50	<0.50	16	0.83	6.9	
5/12/2009	P		--	--	15.93	22.98	<50	<0.50	<0.50	<0.50	<0.50	30	0.31	6.90	
8/13/2009	P		--	--	17.50	21.41	<50	<0.50	<0.50	<0.50	<0.50	7.5	0.65	7.44	
2/18/2010	P		--	--	14.93	23.98	<50	<0.50	<0.50	<0.50	<0.50	12	0.64	6.62	
7/23/2010	P		--	--	16.02	22.89	<50	<0.50	<0.50	<0.50	<0.50	8.2	0.94	6.7	
2/10/2011	P		--	--	15.28	23.63	<50	<0.50	<0.50	<0.50	<0.50	4.5	1.08	6.8	

**Table 1. Summary of Groundwater Monitoring Data: Relative Water Elevations and Laboratory Analyses**  
**ARCO Service Station #2111, 1156 Davis St, San Leandro, CA**

Well ID and Date Monitored	P/NP	TOC (feet)	Top of Screen (ft bgs)	Bottom of Screen (ft bgs)	DTW (feet)	Water Level Elevation (feet)	Concentrations in µg/L						DO (mg/L)	pH	Footnote	
							GRO/TPHg	Benzene	Toluene	Ethyl-Benzene	Total Xylenes	MTBE				
<b>MW-8 Cont.</b>																
8/30/2011	P	38.91	--	--	16.08	22.83	<50	<0.50	<0.50	<0.50	<0.50	<0.50	3.6	0.86	6.8	
2/17/2012	P		--	--	<b>16.34</b>	<b>22.57</b>	<b>&lt;50</b>	<b>&lt;0.50</b>	<b>&lt;0.50</b>	<b>&lt;0.50</b>	<b>&lt;0.50</b>	<b>1.8</b>	<b>0.83</b>	<b>7.10</b>		

Symbols & Abbreviations:

-- = Not analyzed/applicable/measured/available  
< = Not detected at or above specified laboratory reporting limit  
DO = Dissolved oxygen  
DTW = Depth to water in ft bgs  
ft bgs = feet below ground surface  
ft MSL = feet above mean sea level  
GRO = Gasoline range organics  
GWE = Groundwater elevation in ft MSL  
mg/L = Milligrams per liter  
MTBE = Methyl tert-butyl ether  
NP = Well not purged prior to sampling  
P = Well purged prior to sampling  
TOC = Top of casing elevation in ft MSL  
TPH-g = Total petroleum hydrocarbons as gasoline  
µg/L = Micrograms per liter

Footnotes:

a = Product sheen noted  
b = Well was sampled after batch extraction event  
c = Chromatogram Pattern: Gasoline C6-C10 for GRO/TPH-g  
d = Hydrocarbon pattern was present in the requested fuel quantitation range but did not resemble the pattern of the requested fuel for GRO/TPH-g  
e = Discrete peak @C6-C7 for GRO/TPH-g  
f = This sample was analyzed beyond the EPA recommended holding time for TPH-g, benzene, toluene, ethylbenzene, and total xylenes (BTEX), and MTBE. The results may still be useful for their intended purpose  
g = Well not sampled due to the detection of free product (FP)  
h = GWE adjusted for FP: (thickness of FP x 0.8) + measured GWE  
j = The closing calibration for benzene and total xylenes was outside acceptance limits by 1%. This should be considered in evaluating the result. The average % difference for all analytes met the 15% requirement and the QC suggested that calibration linearity was not a factor  
k = The closing calibration was outside acceptance limits by 6%. This should be considered in evaluating the result. The average % difference for all analytes met the 15% requirement and the QC suggested that calibration linearity was not a factor  
l = Toluene and MTBE were not confirmed using a secondary column in accordance to client contract  
m = TOC elevations re-surveyed to NAVD '88 on February 23, 2004  
n = Hydrocarbon result for GRO partly due to indiv. peak(s) in quantitative range  
o = Light to moderate sheen  
p = Result for MTBE partly due to individual peak(s) in quant. range  
q = Gauged with tubing in well  
r = Calib. verif. is within method limits but outside contract limits  
s = Well inaccessible  
t = Initial analysis within holding time but required dilution  
u = Sample taken from VOA vial with air bubble > 6mm diameter  
v = Quantitation of unknown hydrocarbon(s) in sample based on gasoline  
w = Quantitated against gasoline

Notes:

Beginning with the second quarter 2003 sampling event (04/07/03), TPH-g, BTEX, and MTBE analyzed by EPA method 8260B. Prior to 04/07/03, TPH-g was analyzed by EPA method 8015 modified and MTBE was analyzed by EPA methods 8020/ 8260B

Beginning in the fourth quarter 2003, the laboratory modified the reported analyte list. TPH-g was changed to GRO. The resulting data may be impacted by the potential of non-TPH-g analytes within the requested fuel range resulting in a higher concentration being reported

Beginning in the second quarter 2004, the carbon range for GRO was changed from C6-C10 to C4-C12

Values for DO and pH were obtained through field measurements

GRO analysis was completed by EPA method 8260B (C4-C12) for samples collected from the time period April 2006 through February 4, 2008. The analysis for GRO was changed to EPA method 8015B (C6-C12) for samples collected from the time period February 5, 2008 through the present

The data within this table collected prior to April 2006 was provided to Broadbent & Associates, Inc. by Atlantic Richfield Company and their previous consultants. Broadbent & Associates, Inc. has not verified the accuracy of this information



**Table 2. Summary of Fuel Additives Analytical Data**  
**ARCO Service Station #2111, 1156 Davis St, San Leandro, CA**

Well ID and Date Monitored	Concentrations in µg/L								Footnote
	Ethanol	TBA	MTBE	DIPE	ETBE	TAME	1,2-DCA	EDB	
<b>MW-1</b>									
7/20/2000	--	--	2,100	--	--	--	--	--	
9/19/2000	--	--	1,500	--	--	--	--	--	
12/21/2000	--	--	1,080/1,060	--	--	--	--	--	
3/13/2001	--	--	1,430/1,370	--	--	--	--	--	
9/18/2001	--	--	810/1,100	--	--	--	--	--	
12/28/2001	--	--	1,200/1,100	--	--	--	--	--	
3/14/2002	--	--	34/40	--	--	--	--	--	
4/23/2002	--	--	30	--	--	--	--	--	
7/17/2002	--	--	29	--	--	--	--	--	
10/9/2002	--	--	290	--	--	--	--	--	
1/13/2003	--	--	300	--	--	--	--	--	
04/07/03	<100	<20	22	<0.50	<0.50	<0.50	--	--	
7/9/2003	<5,000	<1,000	690	<25	<25	<25	--	--	
02/05/2004	<5,000	<1,000	1,100	<25	<25	32	<25	<25	
04/05/2004	<5,000	<1,000	1,700	<25	<25	38	<25	<25	a
07/13/2004	<2,000	780	730	<10	<10	19	<10	<10	a
11/04/2004	<1,000	<200	380	<5.0	<5.0	12	<5.0	<5.0	
01/20/2005	<1,000	<200	570	<5.0	<5.0	17	<5.0	<5.0	a
04/11/2005	<5,000	<1,000	1,100	<25	<25	34	<25	<25	
08/01/2005	<2,000	<400	1,400	<10	<10	40	<10	<10	
10/21/2005	<5,000	<1,000	970	<25	<25	<25	<25	<25	
01/18/2006	<1,500	<100	330	<2.5	<2.5	9.7	<2.5	<2.5	
04/14/2006	<1,500	<100	310	<2.5	<2.5	9.3	<2.5	<2.5	
7/19/2006	<1,500	<100	180	<2.5	<2.5	3.2	<2.5	<2.5	
10/24/2006	<1,500	<100	360	<2.5	<2.5	10	<2.5	<2.5	
1/15/2007	<1,500	<100	220	<2.5	<2.5	6.8	<2.5	<2.5	
4/18/2007	<1,500	<100	150	<2.5	<2.5	<2.5	<2.5	<2.5	
7/17/2007	<600	<40	94	<1.0	<1.0	2.3	<1.0	<1.0	
10/11/2007	<300	<20	62	<0.50	<0.50	<0.50	<0.50	<0.50	
1/8/2008	<300	74	90	<0.50	<0.50	2.5	<0.50	<0.50	a
4/8/2008	<300	57	110	<0.50	<0.50	2.6	<0.50	<0.50	
8/20/2008	<300	<10	3.3	<0.50	<0.50	<0.50	<0.50	<0.50	

**Table 2. Summary of Fuel Additives Analytical Data**  
**ARCO Service Station #2111, 1156 Davis St, San Leandro, CA**

Well ID and Date Monitored	Concentrations in µg/L								Footnote
	Ethanol	TBA	MTBE	DIPE	ETBE	TAME	1,2-DCA	EDB	
<b>MW-1 Cont.</b>									
11/17/2008	<300	<10	21	<0.50	<0.50	0.52	<0.50	<0.50	
2/3/2009	<300	<10	16	<0.50	<0.50	<0.50	<0.50	<0.50	
5/12/2009	<300	<10	9.3	<0.50	<0.50	<0.50	<0.50	<0.50	
8/13/2009	<300	<10	5.5	<0.50	<0.50	<0.50	<0.50	<0.50	b
2/18/2010	<300	<10	1.4	<0.50	<0.50	<0.50	<0.50	<0.50	
7/23/2010	<300	<10	1.3	<0.50	<0.50	<0.50	<0.50	<0.50	
2/10/2011	<300	<10	1.1	<0.50	<0.50	<0.50	<0.50	<0.50	
8/30/2011	<300	<10	2.1	<0.50	<0.50	<0.50	<0.50	<0.50	
<b>2/17/2012</b>	<b>&lt;300</b>	<b>&lt;10</b>	<b>0.85</b>	<b>&lt;0.50</b>	<b>&lt;0.50</b>	<b>&lt;0.50</b>	<b>&lt;0.50</b>	<b>&lt;0.50</b>	
<b>MW-2</b>									
7/20/2000	--	--	13,000	--	--	--	--	--	
9/19/2000	--	--	19,000	--	--	--	--	--	
12/21/2000	--	--	54,300/89,200	--	--	--	--	--	
12/21/2000	--	--	22,400/24,700	--	--	--	--	--	
3/13/2001	--	--	91,700/76,000	--	--	--	--	--	
3/13/2001	--	--	3,590/3,260	--	--	--	--	--	
12/28/2001	--	--	9,300/8,800	--	--	--	--	--	
3/14/2002	--	--	990/960	--	--	--	--	--	
4/23/2002	--	--	8,500	--	--	--	--	--	
7/17/2002	--	--	19,000/0.4	--	--	--	--	--	
04/05/2004	<1,000	<200	750	<5.0	<5.0	<5.0	<5.0	<5.0	
07/13/2004	<10,000	12,000	5,800	<50	<50	<50	<50	<50	a
08/31/2004	--	--	--	--	--	--	--	--	a
01/20/2005	<10,000	<2,000	7,000	<50	<50	<50	<50	<50	a
04/11/2005	<10,000	<2,000	2,700	<50	<50	<50	<50	<50	
08/01/2005	<10,000	<2,000	2,700	<50	<50	<50	<50	<50	
01/18/2006	<30,000	<2,000	1,600	<50	<50	<50	<50	<50	
04/14/2006	<30,000	<2,000	2,100	<50	<50	<50	<50	<50	
7/19/2006	<6,000	<400	930	<10	<10	<10	<10	<10	
1/15/2007	<6,000	1,900	1,400	<10	<10	<10	<10	<10	
4/18/2007	<6,000	1,200	1,100	<10	<10	<10	<10	<10	

**Table 2. Summary of Fuel Additives Analytical Data**  
**ARCO Service Station #2111, 1156 Davis St, San Leandro, CA**

Well ID and Date Monitored	Concentrations in µg/L								Footnote
	Ethanol	TBA	MTBE	DIPE	ETBE	TAME	1,2-DCA	EDB	
<b>MW-2 Cont.</b>									
7/17/2007	<6,000	1,000	1,300	<10	<10	<10	<10	<10	
10/11/2007	<6,000	1,300	1,000	<10	<10	<10	<10	<10	
1/8/2008	<6,000	2,600	1,300	<10	<10	<10	<10	<10	a
4/8/2008	<300	970	690	<0.50	<0.50	3.3	<0.50	<0.50	
8/20/2008	<6,000	470	190	<10	<10	<10	<10	<10	
11/17/2008	<3,000	740	89	<5.0	<5.0	<5.0	<5.0	<5.0	
2/3/2009	<1,500	230	31	<2.5	<2.5	<2.5	<2.5	<2.5	
5/12/2009	<300	590	25	<0.50	<0.50	<0.50	<0.50	<0.50	
8/13/2009	<6,000	2,300	39	<10	<10	<10	<10	<10	b
2/18/2010	<3,000	1,000	<5.0	<5.0	<5.0	<5.0	<5.0	<5.0	
7/23/2010	<1,200	410	6.5	<2.0	<2.0	<2.0	<2.0	<2.0	
2/10/2011	<2400	2800	12	<4.0	<4.0	<4.0	<4.0	<4.0	
8/30/2011	<300	340	4.5	<0.50	<0.50	<0.50	<0.50	<0.50	
<b>2/17/2012</b>	<b>&lt;1,500</b>	<b>920</b>	<b>2.9</b>	<b>&lt;2.5</b>	<b>&lt;2.5</b>	<b>&lt;2.5</b>	<b>&lt;2.5</b>	<b>&lt;2.5</b>	
<b>MW-3</b>									
7/20/2000	--	--	130	--	--	--	--	--	
9/19/2000	--	--	160	--	--	--	--	--	
12/21/2000	--	--	143/125	--	--	--	--	--	
3/13/2001	--	--	126/122	--	--	--	--	--	
9/18/2001	--	--	110/75	--	--	--	--	--	
12/28/2001	--	--	90/63	--	--	--	--	--	
3/14/2002	--	--	100/88	--	--	--	--	--	
4/23/2002	--	--	77	--	--	--	--	--	
7/17/2002	--	--	47	--	--	--	--	--	
10/9/2002	--	--	26/29	--	--	--	--	--	
1/13/2003	--	--	59	--	--	--	--	--	
04/07/03	<100	<20	75	<0.50	<0.50	6.5	--	--	
7/9/2003	<100	<20	52	<0.50	<0.50	4.2	--	--	
02/05/2004	<100	<20	37	<0.50	<0.50	3.1	<0.50	<0.50	
04/05/2004	<100	<20	53	<0.50	<0.50	3.7	<0.50	<0.50	a
07/13/2004	<100	44	35	<0.50	<0.50	3.2	<0.50	<0.50	

**Table 2. Summary of Fuel Additives Analytical Data**  
**ARCO Service Station #2111, 1156 Davis St, San Leandro, CA**

Well ID and Date Monitored	Concentrations in µg/L								Footnote
	Ethanol	TBA	MTBE	DIPE	ETBE	TAME	1,2-DCA	EDB	
<b>MW-3 Cont.</b>									
11/04/2004	<100	<20	25	<0.50	<0.50	2.2	<0.50	<0.50	
01/20/2005	<100	<20	27	<0.50	<0.50	2.6	<0.50	<0.50	
04/11/2005	<100	<20	21	<0.50	<0.50	2.0	<0.50	<0.50	
08/01/2005	<100	<20	23	<0.50	<0.50	1.9	<0.50	<0.50	
10/21/2005	<100	<20	19	<0.50	<0.50	2.0	<0.50	<0.50	
01/18/2006	<300	<20	13	<0.50	<0.50	1.3	<0.50	<0.50	
04/14/2006	<300	<20	6.7	<0.50	<0.50	0.61	<0.50	<0.50	
7/19/2006	<300	<20	11	<0.50	<0.50	0.72	<0.50	<0.50	r
10/24/2006	<300	<20	33	<0.50	<0.50	2.8	<0.50	<0.50	
1/15/2007	<300	<20	29	<0.50	<0.50	2.9	<0.50	<0.50	
4/18/2007	<300	<20	9.5	<0.50	<0.50	0.90	<0.50	<0.50	
7/17/2007	<300	<20	19	<0.50	<0.50	1.5	<0.50	<0.50	
10/11/2007	<300	<20	5.3	<0.50	<0.50	<0.50	<0.50	<0.50	
1/8/2008	<300	<20	8.9	<0.50	<0.50	0.84	<0.50	<0.50	a
4/8/2008	<300	<10	<0.50	<0.50	<0.50	<0.50	<0.50	<0.50	
8/20/2008	<300	<10	<0.50	<0.50	<0.50	<0.50	<0.50	<0.50	
11/17/2008	<300	<10	3.6	<0.50	<0.50	<0.50	<0.50	<0.50	
2/3/2009	<300	<10	2.1	<0.50	<0.50	<0.50	<0.50	<0.50	
5/12/2009	<300	<10	2.1	<0.50	<0.50	<0.50	<0.50	<0.50	
8/13/2009	<300	<10	2.7	<0.50	<0.50	<0.50	<0.50	<0.50	
2/18/2010	<300	<10	0.59	<0.50	<0.50	<0.50	<0.50	<0.50	
7/23/2010	<300	14	0.85	<0.50	<0.50	<0.50	<0.50	<0.50	
2/10/2011	<300	<10	0.51	<0.50	<0.50	<0.50	<0.50	<0.50	
8/30/2011	<300	<10	<0.50	<0.50	<0.50	<0.50	<0.50	<0.50	
<b>2/17/2012</b>	<b>&lt;300</b>	<b>&lt;10</b>	<b>&lt;0.50</b>	<b>&lt;0.50</b>	<b>&lt;0.50</b>	<b>&lt;0.50</b>	<b>&lt;0.50</b>	<b>&lt;0.50</b>	
<b>MW-4</b>									
7/20/2000	--	--	51	--	--	--	--	--	
9/19/2000	--	--	60	--	--	--	--	--	
12/21/2000	--	--	46.3/48.6	--	--	--	--	--	
3/13/2001	--	--	53.7/50	--	--	--	--	--	
9/18/2001	--	--	25/26	--	--	--	--	--	

**Table 2. Summary of Fuel Additives Analytical Data**  
**ARCO Service Station #2111, 1156 Davis St, San Leandro, CA**

Well ID and Date Monitored	Concentrations in µg/L								Footnote
	Ethanol	TBA	MTBE	DIPE	ETBE	TAME	1,2-DCA	EDB	
<b>MW-4 Cont.</b>									
12/28/2001	--	--	15/11	--	--	--	--	--	
3/14/2002	--	--	31/28	--	--	--	--	--	
4/23/2002	--	--	42	--	--	--	--	--	
7/17/2002	--	--	16	--	--	--	--	--	
10/9/2002	--	--	20/23	--	--	--	--	--	
1/13/2003	--	--	22	--	--	--	--	--	
04/07/03	<100	<20	24	<0.50	<0.50	7.3	--	--	
7/9/2003	<100	<20	34	<0.50	<0.50	9.8	--	--	
02/05/2004	<100	<20	22	<0.50	<0.50	6.2	<0.50	<0.50	
04/05/2004	<100	<20	27	<0.50	<0.50	7.2	<0.50	<0.50	a
07/13/2004	<100	26	27	<0.50	<0.50	7.4	<0.50	<0.50	a
11/04/2004	<100	<20	19	<0.50	<0.50	5.1	<0.50	<0.50	
01/20/2005	<100	<20	18	<0.50	<0.50	5.2	<0.50	<0.50	
04/11/2005	<100	<20	14	<0.50	<0.50	4.0	<0.50	<0.50	
08/01/2005	<100	<20	18	<0.50	<0.50	3.9	<0.50	<0.50	
10/21/2005	<100	<20	15	<0.50	<0.50	4.6	<0.50	<0.50	
01/18/2006	<300	<20	8.9	<0.50	<0.50	2.5	<0.50	<0.50	
04/14/2006	<300	<20	4.2	<0.50	<0.50	1.3	<0.50	<0.50	
7/19/2006	<300	<20	3.4	<0.50	<0.50	0.69	<0.50	<0.50	r
10/24/2006	<300	<20	3.5	<0.50	<0.50	0.91	<0.50	<0.50	
1/15/2007	<300	<20	3.8	<0.50	<0.50	0.98	<0.50	<0.50	
4/18/2007	<300	<20	5.6	<0.50	<0.50	1.1	<0.50	<0.50	
7/17/2007	<300	<20	6.6	<0.50	<0.50	1.7	<0.50	<0.50	
10/11/2007	<300	<20	0.81	<0.50	<0.50	<0.50	<0.50	<0.50	
1/8/2008	<300	<20	1.2	<0.50	<0.50	<0.50	<0.50	<0.50	a
4/8/2008	<300	<10	1.7	<0.50	<0.50	<0.50	<0.50	<0.50	
8/20/2008	<300	<10	0.70	<0.50	<0.50	<0.50	<0.50	<0.50	
11/17/2008	<300	<10	0.73	<0.50	<0.50	<0.50	<0.50	<0.50	
2/3/2009	<300	<10	0.67	<0.50	<0.50	<0.50	<0.50	<0.50	
5/12/2009	<300	<10	0.62	<0.50	<0.50	<0.50	<0.50	<0.50	
8/13/2009	<300	<10	0.65	<0.50	<0.50	<0.50	<0.50	<0.50	b
2/18/2010	<300	<10	<0.50	<0.50	<0.50	<0.50	<0.50	<0.50	

**Table 2. Summary of Fuel Additives Analytical Data**  
**ARCO Service Station #2111, 1156 Davis St, San Leandro, CA**

Well ID and Date Monitored	Concentrations in µg/L								Footnote
	Ethanol	TBA	MTBE	DIPE	ETBE	TAME	1,2-DCA	EDB	
<b>MW-4 Cont.</b>									
7/23/2010	<300	<10	0.52	<0.50	<0.50	<0.50	<0.50	<0.50	
2/10/2011	<300	<10	<0.50	<0.50	<0.50	<0.50	<0.50	<0.50	
8/30/2011	<300	<10	<0.50	<0.50	<0.50	<0.50	<0.50	<0.50	
<b>2/17/2012</b>	<b>&lt;300</b>	<b>&lt;10</b>	<b>&lt;0.50</b>	<b>&lt;0.50</b>	<b>&lt;0.50</b>	<b>&lt;0.50</b>	<b>&lt;0.50</b>	<b>&lt;0.50</b>	
<b>MW-5</b>									
7/20/2000	--	--	14,000	--	--	--	--	--	
9/19/2000	--	--	13,000	--	--	--	--	--	
12/21/2000	--	--	19,200/21,200	--	--	--	--	--	
3/13/2001	--	--	15,900/20,000	--	--	--	--	--	
9/18/2001	--	--	22,000/20,000	--	--	--	--	--	
12/28/2001	--	--	10,000/10,000	--	--	--	--	--	
3/14/2002	--	--	7,100/7,700	--	--	--	--	--	
4/23/2002	--	--	8,900	--	--	--	--	--	
7/17/2002	--	--	13,000	--	--	--	--	--	
10/9/2002	--	--	7,300/7,500	--	--	--	--	--	
1/13/2003	--	--	8,900	--	--	--	--	--	
04/07/03	<20,000	<4,000	3,700	<100	<100	<100	--	--	
7/9/2003	<10,000	<2,000	6,500	<50	<50	<50	--	--	
02/05/2004	<10,000	<2,000	7,900	<50	<50	<50	<50	<50	a
04/05/2004	<5,000	<1,000	2,000	<25	<25	<25	<25	<25	a
07/13/2004	<10,000	3,200	4,000	<50	<50	<50	<50	<50	a
11/04/2004	<10,000	<2,000	6,300	<50	<50	<50	<50	<50	
01/20/2005	<10,000	<2,000	6,900	<50	<50	<50	<50	<50	a
04/11/2005	<10,000	3,600	2,600	<50	<50	<50	<50	<50	
08/01/2005	<200	1,600	130	<1.0	<1.0	<1.0	<1.0	<1.0	
10/21/2005	<500	1,400	86	<2.5	<2.5	<2.5	<2.5	<2.5	
01/18/2006	<1,500	2,200	100	<2.5	<2.5	<2.5	<2.5	<2.5	
04/14/2006	<1,500	2,100	240	<2.5	<2.5	<2.5	<2.5	<2.5	
7/19/2006	<1,500	2,800	84	<2.5	<2.5	<2.5	<2.5	<2.5	r
10/24/2006	<300	1,200	17	<0.50	<0.50	<0.50	<0.50	<0.50	a
1/15/2007	<300	990	36	<0.50	<0.50	<0.50	<0.50	<0.50	

**Table 2. Summary of Fuel Additives Analytical Data**  
**ARCO Service Station #2111, 1156 Davis St, San Leandro, CA**

Well ID and Date Monitored	Concentrations in µg/L								Footnote
	Ethanol	TBA	MTBE	DIPE	ETBE	TAME	1,2-DCA	EDB	
<b>MW-5 Cont.</b>									
4/18/2007	<1,500	2,000	16	<2.5	<2.5	<2.5	<2.5	<2.5	
7/17/2007	<1,500	1,100	6.6	<2.5	<2.5	<2.5	<2.5	<2.5	
10/11/2007	<300	750	4.8	<0.50	<0.50	<0.50	<0.50	<0.50	
1/8/2008	<300	220	5.6	<0.50	<0.50	<0.50	<0.50	<0.50	a
4/8/2008	<300	300	8.0	<0.50	<0.50	<0.50	<0.50	<0.50	
8/20/2008	<600	520	3.6	<1.0	<1.0	<1.0	<1.0	<1.0	
11/17/2008	<300	160	1.3	<0.50	<0.50	<0.50	<0.50	<0.50	
2/3/2009	<300	94	<0.50	<0.50	<0.50	<0.50	<0.50	<0.50	
5/12/2009	<300	29	2.5	<0.50	<0.50	<0.50	<0.50	<0.50	
8/13/2009	<600	180	1.3	<1.0	<1.0	<1.0	<1.0	<1.0	b
2/18/2010	<300	17	2.2	<0.50	<0.50	<0.50	<0.50	<0.50	
7/23/2010	<300	<10	<0.50	<0.50	<0.50	<0.50	<0.50	<0.50	
2/10/2011	<300	<10	0.73	<0.50	<0.50	<0.50	<0.50	<0.50	
8/30/2011	<300	<10	1.9	<0.50	<0.50	<0.50	<0.50	<0.50	
<b>2/17/2012</b>	<b>&lt;300</b>	<b>&lt;10</b>	<b>0.98</b>	<b>&lt;0.50</b>	<b>&lt;0.50</b>	<b>&lt;0.50</b>	<b>&lt;0.50</b>	<b>&lt;0.50</b>	
<b>MW-6</b>									
7/20/2000	--	--	<3.0	--	--	--	--	--	
9/19/2000	--	--	<3.0	--	--	--	--	--	
12/21/2000	--	--	<2.5	--	--	--	--	--	
3/13/2001	--	--	<2.5	--	--	--	--	--	
9/18/2001	--	--	<2.5/<2.0	--	--	--	--	--	
12/28/2001	--	--	12/<0.5	--	--	--	--	--	
3/14/2002	--	--	<2.5	--	--	--	--	--	
4/23/2002	--	--	3.1	--	--	--	--	--	
7/17/2002	--	--	<2.5	--	--	--	--	--	
10/9/2002	--	--	<2.5	--	--	--	--	--	
1/13/2003	--	--	<2.5	--	--	--	--	--	
04/07/03	<100	<20	<0.50	<0.50	<0.50	<0.50	--	--	
7/9/2003	<100	<20	<0.50	<0.50	<0.50	<0.50	--	--	
07/13/2004	<100	<20	<0.50	<0.50	<0.50	<0.50	<0.50	<0.50	a
08/01/2005	<100	<20	<0.50	<0.50	<0.50	<0.50	<0.50	<0.50	



**Table 2. Summary of Fuel Additives Analytical Data**  
**ARCO Service Station #2111, 1156 Davis St, San Leandro, CA**

Well ID and Date Monitored	Concentrations in µg/L								Footnote
	Ethanol	TBA	MTBE	DIPE	ETBE	TAME	1,2-DCA	EDB	
<b>MW-6 Cont.</b>									
7/19/2006	<300	<20	<0.50	<0.50	<0.50	<0.50	<0.50	<0.50	r
7/17/2007	<300	<20	<0.50	<0.50	<0.50	<0.50	<0.50	<0.50	
8/20/2008	<300	<10	<0.50	<0.50	<0.50	<0.50	<0.50	<0.50	
8/13/2009	<300	<10	<0.50	<0.50	<0.50	<0.50	<0.50	<0.50	b
7/23/2010	<300	15	<0.50	<0.50	<0.50	<0.50	<0.50	<0.50	
8/30/2011	<300	<10	<0.50	<0.50	<0.50	<0.50	<0.50	<0.50	
<b>MW-7</b>									
7/20/2000	--	--	71,000	--	--	--	--	--	
9/19/2000	--	--	5,600	--	--	--	--	--	
3/13/2001	--	--	75,000/160,000	--	--	--	--	--	
9/18/2001	--	--	90,000/370,000	--	--	--	--	--	
12/28/2001	--	--	84,000/72,000	--	--	--	--	--	
3/14/2002	--	--	85,000/85,000	--	--	--	--	--	
4/23/2002	--	--	67,000	--	--	--	--	--	
7/17/2002	--	--	120,000	--	--	--	--	--	
10/9/2002	--	--	7,000/120,000	--	--	--	--	--	
1/13/2003	--	--	33,000	--	--	--	--	--	
04/07/03	<5,000	<1,000	710	<25	<25	<25	--	--	
7/9/2003	<100,000	<20,000	36,000	<500	<500	<500	--	--	
02/05/2004	<50,000	<10,000	34,000	<250	<250	<250	<250	<250	
04/05/2004	<50,000	<10,000	37,000	<250	<250	<250	<250	<250	
07/13/2004	<200,000	<40,000	56,000	<1,000	<1,000	1,300	<1,000	<1,000	
11/04/2004	<100,000	<20,000	71,000	<500	<500	<500	<500	<500	
01/20/2005	<50,000	<10,000	36,000	<250	<250	<250	<250	<250	a
04/11/2005	<5,000	<1,000	1,200	<25	<25	<25	<25	<25	
08/01/2005	<50,000	<10,000	4,800	<250	<250	<250	<250	<250	
10/21/2005	<20,000	24,000	12,000	<100	<100	<100	<100	<100	
01/18/2006	<60,000	15,000	13,000	<100	<100	<100	<100	<100	
04/14/2006	<60,000	<4,000	4,700	<100	<100	<100	<100	<100	
7/19/2006	<6,000	720	1,600	<10	<10	<10	<10	<10	
10/24/2006	<3,000	10,000	14,000	<5.0	<5.0	31	<5.0	<5.0	a

**Table 2. Summary of Fuel Additives Analytical Data**  
**ARCO Service Station #2111, 1156 Davis St, San Leandro, CA**

Well ID and Date Monitored	Concentrations in µg/L								Footnote
	Ethanol	TBA	MTBE	DIPE	ETBE	TAME	1,2-DCA	EDB	
<b>MW-7 Cont.</b>									
1/15/2007	<60,000	9,300	3,900	<100	<100	<100	<100	<100	
4/18/2007	<30,000	<2,000	2,700	<50	<50	<50	<50	<50	
7/17/2007	<15,000	<1,000	890	<25	<25	<25	<25	<25	
10/11/2007	<1,500	150	370	<2.5	<2.5	<2.5	<2.5	<2.5	
1/8/2008	<15,000	1,400	6,100	<25	<25	32	<25	<25	
4/8/2008	<300	700	1,200	<0.50	<0.50	5.1	<0.50	<0.50	
8/20/2008	<300	34	39	<0.50	<0.50	<0.50	<0.50	<0.50	
11/17/2008	<300	44	28	<0.50	<0.50	<0.50	<0.50	<0.50	
2/3/2009	<300	66	18	<0.50	<0.50	<0.50	<0.50	<0.50	
5/12/2009	<300	75	390	<0.50	<0.50	1.2	<0.50	<0.50	
8/13/2009	<300	19	21	<0.50	<0.50	<0.50	<0.50	<0.50	b
2/18/2010	<15,000	2,300	1,300	<25	<25	<25	<25	<25	
7/23/2010	<300	7,800	1,000	<0.50	<0.50	3.6	<0.50	<0.50	
2/10/2011	<15,000	9900	310	<25	<25	<25	<25	<25	
8/30/2011	<15,000	9,500	180	<25	<25	<25	<25	<25	
<b>2/17/2012</b>	<b>&lt;300</b>	<b>12,000</b>	<b>110</b>	<b>&lt;0.50</b>	<b>&lt;0.50</b>	<b>&lt;0.50</b>	<b>&lt;0.50</b>	<b>&lt;0.50</b>	
<b>MW-8</b>									
02/05/2004	<5,000	<1,000	1,900	<25	<25	<25	<25	<25	
04/05/2004	<2,000	<400	1,200	<10	<10	12	<10	<10	a
07/13/2004	<2,000	770	760	<10	<10	<10	<10	<10	a
11/04/2004	<1,000	<200	820	<5.0	<5.0	9.6	<5.0	<5.0	
01/20/2005	<5,000	<1,000	1,400	<25	<25	<25	<25	<25	a
04/11/2005	<1,000	<200	610	<5.0	<5.0	8.1	<5.0	<5.0	
08/01/2005	<2,000	<400	900	<10	<10	<10	<10	<10	
10/21/2005	<1,000	<200	490	<5.0	<5.0	<5.0	<5.0	<5.0	
01/18/2006	<3,000	<200	500	<5.0	<5.0	5.2	<5.0	<5.0	
04/14/2006	<3,000	<200	300	<5.0	<5.0	<5.0	<5.0	<5.0	
7/19/2006	<15,000	<1,000	4,200	<25	<25	45	<25	<25	
1/15/2007	<300	52	67	<0.50	<0.50	0.88	<0.50	<0.50	
4/18/2007	<300	120	130	<0.50	<0.50	1.9	<0.50	<0.50	
7/17/2007	<300	110	96	<0.50	<0.50	1.2	<0.50	<0.50	

**Table 2. Summary of Fuel Additives Analytical Data**  
**ARCO Service Station #2111, 1156 Davis St, San Leandro, CA**

Well ID and Date Monitored	Concentrations in µg/L								Footnote
	Ethanol	TBA	MTBE	DIPE	ETBE	TAME	1,2-DCA	EDB	
<b>MW-8 Cont.</b>									
10/11/2007	<300	350	130	<0.50	<0.50	1.7	<0.50	<0.50	
1/8/2008	<300	59	49	<0.50	<0.50	0.80	<0.50	<0.50	
4/8/2008	<300	110	32	<0.50	<0.50	<0.50	<0.50	<0.50	
8/20/2008	<300	62	13	<0.50	<0.50	<0.50	<0.50	<0.50	
11/17/2008	<300	24	14	<0.50	<0.50	<0.50	<0.50	<0.50	
2/3/2009	<300	17	16	<0.50	<0.50	<0.50	<0.50	<0.50	
5/12/2009	<300	18	30	<0.50	<0.50	<0.50	<0.50	<0.50	
8/13/2009	<300	28	7.5	<0.50	<0.50	<0.50	<0.50	<0.50	
2/18/2010	<300	37	12	<0.50	<0.50	<0.50	<0.50	<0.50	
7/23/2010	<300	53	8.2	<0.50	<0.50	<0.50	<0.50	<0.50	
2/10/2011	<300	23	4.5	<0.50	<0.50	<0.50	<0.50	<0.50	
8/30/2011	<300	<10	3.6	<0.50	<0.50	<0.50	<0.50	<0.50	
<b>2/17/2012</b>	<b>&lt;300</b>	<b>&lt;10</b>	<b>1.8</b>	<b>&lt;0.50</b>	<b>&lt;0.50</b>	<b>&lt;0.50</b>	<b>&lt;0.50</b>	<b>&lt;0.50</b>	

Symbols & Abbreviations:

-- = Not analyzed/applicable/measured/available

< = Not detected at or above specified laboratory reporting limit

1,2-DCA = 1,2-Dichloroethane

DIPE = Diisopropyl ether

EDB = 1,2-Dibromoethane

ETBE = Ethyl tert-butyl ether

MTBE = Methyl tert-butyl ether

TAME = tert-Amyl methyl ether

TBA = tert-Butyl alcohol

µg/L = Micrograms per Liter

Footnotes:

a = The continuing calibration verification for ethanol was outside of client contractual acceptance limits. However, it was within method acceptance limits. The data should still be considered useful for its intended purpose

b = Sample taken from VOA vial with air bubble > 6mm diameter

Notes:

All volatile organic compounds analyzed using EPA Method 8260B

The data within this table collected prior to April 2006 was provided to Broadbent & Associates, Inc. by Atlantic Richfield Company and their previous consultants. Broadbent & Associates, Inc. has not verified the accuracy of this information

**Table 3. Historical Groundwater Gradient - Direction and Magnitude**  
**ARCO Service Station #2111, 1156 Davis St, San Leandro, CA**

<b>Date Measured</b>	<b>Approximate Gradient Direction</b>	<b>Approximate Gradient Magnitude (ft/ft)</b>
7/20/2000	West-Northwest	0.006
9/19/2000	West-Northwest	0.004
12/21/2000	West-Northwest	0.004
3/13/2001	West-Northwest	0.005
5/30/2001	West-Northwest	0.004
9/18/2001	West-Northwest	0.003
12/28/2001	West-Northwest	0.003
3/14/2002	West	0.004
4/23/2002	West	0.006
7/17/2002	West	0.003
10/9/2002	West	0.002
1/13/2003	Southwest	0.0043
4/7/2003	West-Northwest	0.009 to 0.011
7/9/2003	West-Northwest	0.004
10/1/2003	West	0.002
2/5/2004	West	0.004
4/5/2004	West-Southwest	0.004
7/13/2004	West-Southwest	0.003
11/4/2004	West	0.003
1/20/2005	West	0.009
4/11/2005	North to West	0.009 to 0.01
8/1/2005	West to Northwest	0.006 to 0.004
10/21/2005	West	0.008
1/18/2006	North and West	0.01
4/14/2006	South	0.008
7/19/2006	Northwest to Southwest	0.004 to 0.008
10/24/2006	West	0.003
1/15/2007	Southwest	0.004
4/18/2007	West	0.009
7/17/2007	Southeast	0.05
10/11/2007	West	0.01
1/8/2008	West	0.008
4/8/2008	West	0.006
8/20/2008	West	0.006
11/17/2008	South-Southeast	0.05
2/3/2009	South-Southeast	0.01
5/12/2009	North to West	0.004
8/13/2009	South	0.006
2/18/2010	West-Southwest	0.001
7/23/2010	West-Southwest	0.002
2/10/2011	West	0.002
8/30/2011	West	0.01

**Table 3. Historical Groundwater Gradient - Direction and Magnitude**  
**ARCO Service Station #2111, 1156 Davis St, San Leandro, CA**

<b>Date Measured</b>	<b>Approximate Gradient Direction</b>	<b>Approximate Gradient Magnitude (ft/ft)</b>
<b>2/17/2012</b>	<b>North to West</b>	<b>0.008</b>

Notes:

The data within this table collected prior to April 2006 was provided to Broadbent & Associates, Inc. by Atlantic Richfield Company and their previous consultants. Broadbent & Associates, Inc. has not verified the accuracy of this information

## APPENDIX C

### Soil Boring and Well Construction Logs





PROJECT: ARCO PRODUCTS COMPANY	LOCATION: 1158 Davis Street, San Leandro, Ca.
GSI PROJECT NO.: 7940.03	SURFACE ELEVATION:
DATE STARTED: 3/4/94	NL (ft. bgs): 20    DATE: 3/4/94    TIME: 10:38
DATE FINISHED: 3/4/94	NL (ft. bgs): 18    DATE: 3/4/94    TIME: 10:45
DRILLING METHOD: 8 in. Hollow Stem Auger	TOTAL DEPTH: 20 Feet
DRILLING COMPANY: Exploration GeoServices Inc.	GEOLOGIST: RDC

DEPTH feet	PTD (ppm)	BLOWS/FT. *	SAMPLE NUMBER	SAMPLE INT.	GRAPHIC LOG	SOIL CLASS	GEOLOGIC DESCRIPTION	REMARKS
0		6	B1-4.5			GW-GM	ASPHALT	Boring backfilled 18 to 20 feet with bentonite, surface to 18 feet with 10 sack cement/sand slurry with 5% bentonite.
5	0					ML	GRAVEL WITH SILT AND SAND (GW-GM) - brown (10YR 5/3), damp, 60% angular gravel, 30% medium grained sand, 10% silt.	
10	0.1	22	B1-10				SILT (ML) - very dark gray (10YR 3/1), damp, low plasticity, medium stiff, 55% silt, 40% clay, 5% fine grained sand.	
15	0	32	B1-15				SILT (ML) - very dark grayish brown (10YR 3/2), damp, low plasticity, very stiff, 55% silt, 45% clay.	
20	3.1	21	B1-20				AS ABOVE	
20							SILT (ML) - brown (10YR 5/3) with green mottling, very moist to wet, low plasticity, very stiff, 55% silt, 25% clay, 20% fine sand.	
20							Bottom of boring at 20 feet. 3/4/94	
25							(* = converted to equivalent standard penetration blows/ft.)	



GeoStrategies, Inc.

Log of Boring B-2

PROJECT: ARCO PRODUCTS COMPANY	LOCATION: 1158 Davis Street, San Leandro, Ca.
GSI PROJECT NO.: 7940.03	SURFACE ELEVATION:
DATE STARTED: 3/4/94	WL (ft. bgs): 20 DATE: 3/4/94 TIME: 11:30
DATE FINISHED: 3/4/94	WL (ft. bgs): 18.5 DATE: 3/4/94 TIME: 11:45
DRILLING METHOD: 8 in. Hollow Stem Auger	TOTAL DEPTH: 20 Feet
DRILLING COMPANY: Exploration GeoServices Inc.	GEOLOGIST: RDC

DEPTH feet	PTD (ppm)	BLOWS/FT. *	SAMPLE NUMBER	SAMPLE INT.	GRAPHIC LOG	SOIL CLASS	GEOLOGIC DESCRIPTION	REMARKS
						GW-GM	ASPHALT	
5	0	10	B2-5			ML	GRAVEL WITH SILT AND SAND (GW-GM) - brown (10YR 5/3), damp, 60% angular gravel, 30% medium sand, 10% silt.  SILT (ML) - very dark gray (10YR 3/1), damp, low plasticity, stiff, 65% silt, 25% clay, 10% fine sand.	Boring backfilled 18 to 20 feet with bentonite, surface to 18 feet with 10 sack cement/sand slurry with 5% bentonite.
10	0	24	B2-10				SILT (ML) - very dark grayish brown (10YR 3/2), damp, low plasticity, very stiff, 90% silt, 5% clay, 5% fine sand.	
15	0.7	40	B2-15				SILT (ML) - very dark gray (10YR 3/2), moist, low plasticity, hard, 65% silt, 25% clay, 10% fine sand.	
20	52 46	13	B2-20				▽ SILT (ML) - dark brown (10YR 4/3), low plasticity, stiff, 55% silt, 40% clay, 5% fine sand.	
25							Bottom of boring at 20 feet. 3/4/94  (* = converted to equivalent standard penetration blows/ft.)	
30								
35								

# WELL DETAILS



EMCON  
ASSOCIATES

PROJECT NUMBER 0805-127.01 BORING / WELL NO. MW-1  
 PROJECT NAME ARCO 2111 TOP OF CASING ELEV. 39.60  
 LOCATION 1156 Davis Street, San Leandro GROUND SURFACE ELEV. 38.84  
 WELL PERMIT NO. na DATUM M.S.L.  
 INSTALLATION DATE 7/12/95

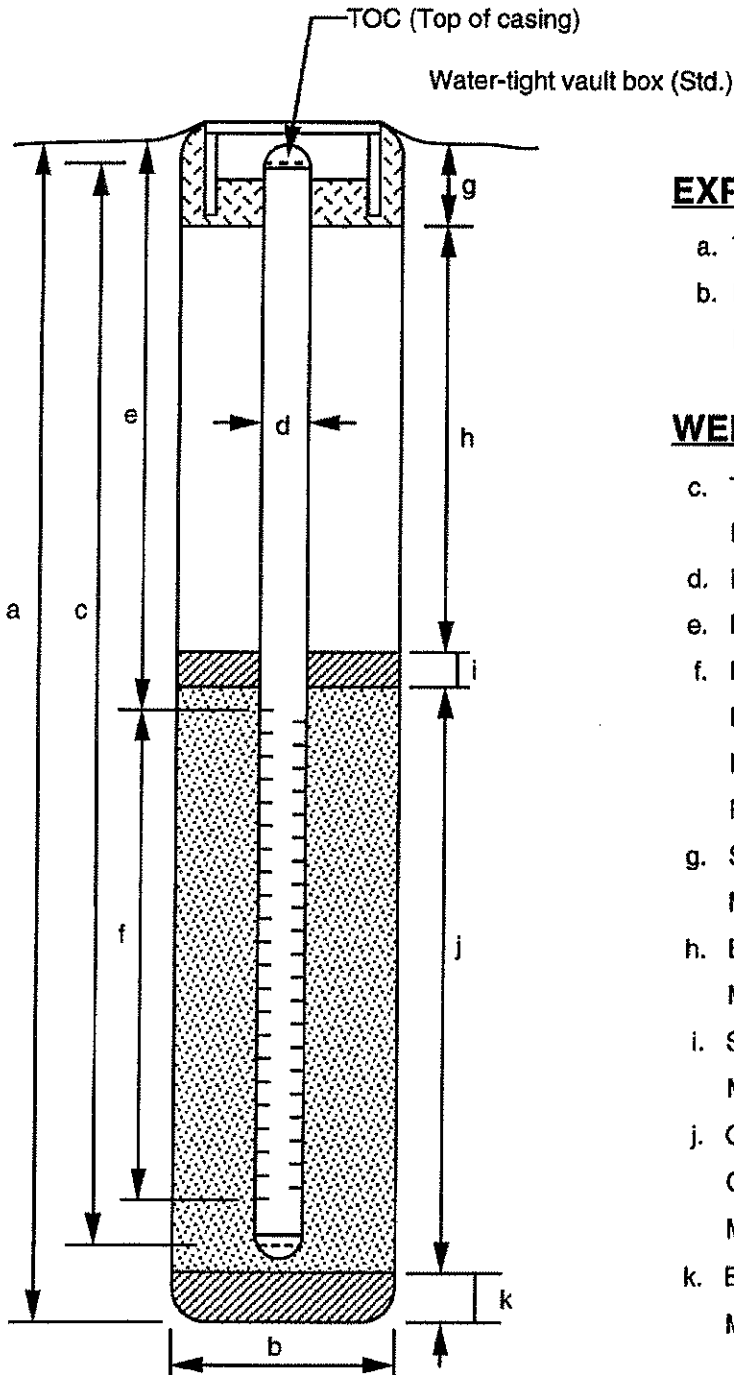

## EXPLORATORY BORING

a. Total depth 30.0 ft.  
 b. Diameter 10.0 in.  
 Drilling method Hollow Stem Auger

## WELL CONSTRUCTION

c. Total casing length na ft.  
 Material Schedule 40 PVC  
 d. Diameter 4.0 in.  
 e. Depth to top perforations 12.5 ft.  
 f. Perforated length 13.7 ft.  
 Perforated interval from 12.5 to 26.2 ft.  
 Perforation type Machine Slotted  
 Perforation size 0.020 inch  
 g. Surface seal 1.0 ft.  
 Material Concrete  
 h. Backfill 9.5 ft.  
 Material Cement  
 i. Seal 1.5 ft.  
 Material Bentonite  
 j. Gravel pack 16.5 ft.  
 Gravel pack interval from 10.5 to 27.0 ft.  
 Material 2/12 Sand  
 k. Bottom seal/fill 3.0 ft.  
 Material Bentonite

# LOG OF EXPLORATORY BORING

PROJECT NUMBER: 0805-127.001

BORING NO.: MW-1

















PROJECT NAME: ARCO Service Station 2111

PAGE: 1 of 2

BY: R. Davis

DATE: 7/12/95

SURFACE ELEVATION: 39.84 ft.

RECOVERY (ft/ft)	PENETRA- TION (blws/ft)	GROUND WATER LEVELS	DEPTH IN FEET	SAMPLES	LITHOGRAPHIC COLUMN	DESCRIPTION	WELL DETAIL
80%	0	22	5	■		ASPHALT	
						FILL - SANDY GRAVEL (GP).  @3.2': cobbles to 5".  CLAYEY GRAVEL (GC), dark brown (7.5YR, 4/4); 20-25% medium plasticity fines; 30% fine to coarse sand; 45-50% fine to coarse gravel to 1.5"; medium dense; damp; no product odor.	
						SILTY CLAY (CL), dark brown (10YR, 3/3); 95-100% low to medium plasticity fines; trace to 5% fine sand; stiff to very stiff; damp; no product odor.	
100%	0	27	10	■		@10.0-11.5': dark grayish brown (2.5Y, 4/2); increased silt content; trace dark brown organic fragments (0.5-2.0mm); very stiff; damp; no product odor.	
						@15.0-16.5': SILTY CLAY (CL) and CLAYEY SILT (ML)- Interbedded, 70/30: SILTY CLAY (CL), dark brown (10YR, 3/3); 95-100% low to medium plasticity fines; trace to 5% fine sand; stiff to very stiff; damp; no product odor.	
90%	0	29	15	■		CLAYEY SILT (ML), light olive brown (2.5Y, 5/4); 95-100% low plasticity fines; trace to 5% fine sand; very stiff to hard; damp; no product odor.	
		▽				@17.5': driller noted easier drilling in looser material.	
			20				

**REMARKS**

Boring drilled with 8" diameter hollow-stem augers and reamed with 10" diameter augers. Samples were taken using a 2" diameter modified-California split spoon sampler. Boring converted into a 4" diameter polyvinyl chloride (PVC) groundwater monitoring well. See explanation sheet for definition of symbols used in well detail and sample columns of this log. See explanation sheet for definition of symbols on this log.



**EMCON**  
ASSOCIATES

# LOG OF EXPLORATORY BORING

PROJECT NUMBER: 0805-127.001

BORING NO.: MW-1

PROJECT NAME: ARCO Service Station 2111

PAGE: 2 of 2

BY: R. Davis

DATE: 7/12/95

SURFACE ELEVATION: 39.84 ft.

RECOVERY (ft/ft)	PENETRATION (blws/ft)	GROUND WATER LEVELS	DEPTH IN FEET	SAMPLES	LITHOGRAPHIC COLUMN	DESCRIPTION	WELL DETAIL
100%	0	24		25	30	<p>CLAYEY SANDY SILT (ML), light olive brown (2.5Y, 5/4) with yellowish brown (10YR, 5/6) mottling; 85-90% low to medium plasticity fines; 10-15% fine to coarse sand; firm; wet; no product odor.</p> <p>@22': driller noted harder drilling in more competent material.</p>	25
60%	0	15		25	30	<p>@25.0-26.5': 5-10% fine sand; very stiff; damp to wet (moisture visible in voids); no odor.</p>	25
40%	0	8		30	30	<p>SILTY CLAY (CL), dark greyish brown (2.5Y, 4/2); 90-95% low- to medium-plasticity fines; 5-10% fine sand; soft to firm; very moist, wet in void spaces; no product odor.</p> <p>BORING TERMINATED AT 30.0 FEET BGS.</p>	25
			35				
			40				

**REMARKS**

Boring drilled with 8" diameter hollow-stem augers and reamed with 10" diameter augers. Samples were taken using a 2" diameter modified-California split spoon sampler. Boring converted into a 4" diameter polyvinyl chloride (PVC) groundwater monitoring well. See explanation sheet for definition of symbols used in well detail and sample columns of this log. See explanation sheet for definition of symbols on this log.



**EMCON**  
ASSOCIATES

# WELL DETAILS



**EMCON**  
ASSOCIATES

PROJECT NUMBER 0805-127.01 BORING / WELL NO. MW-2  
 PROJECT NAME ARCO 2111 TOP OF CASING ELEV. 37.99  
 LOCATION 1156 Davis Street, San Leandro GROUND SURFACE ELEV. 38.71  
 WELL PERMIT NO. na DATUM M.S.L.  
 INSTALLATION DATE 7/12/95

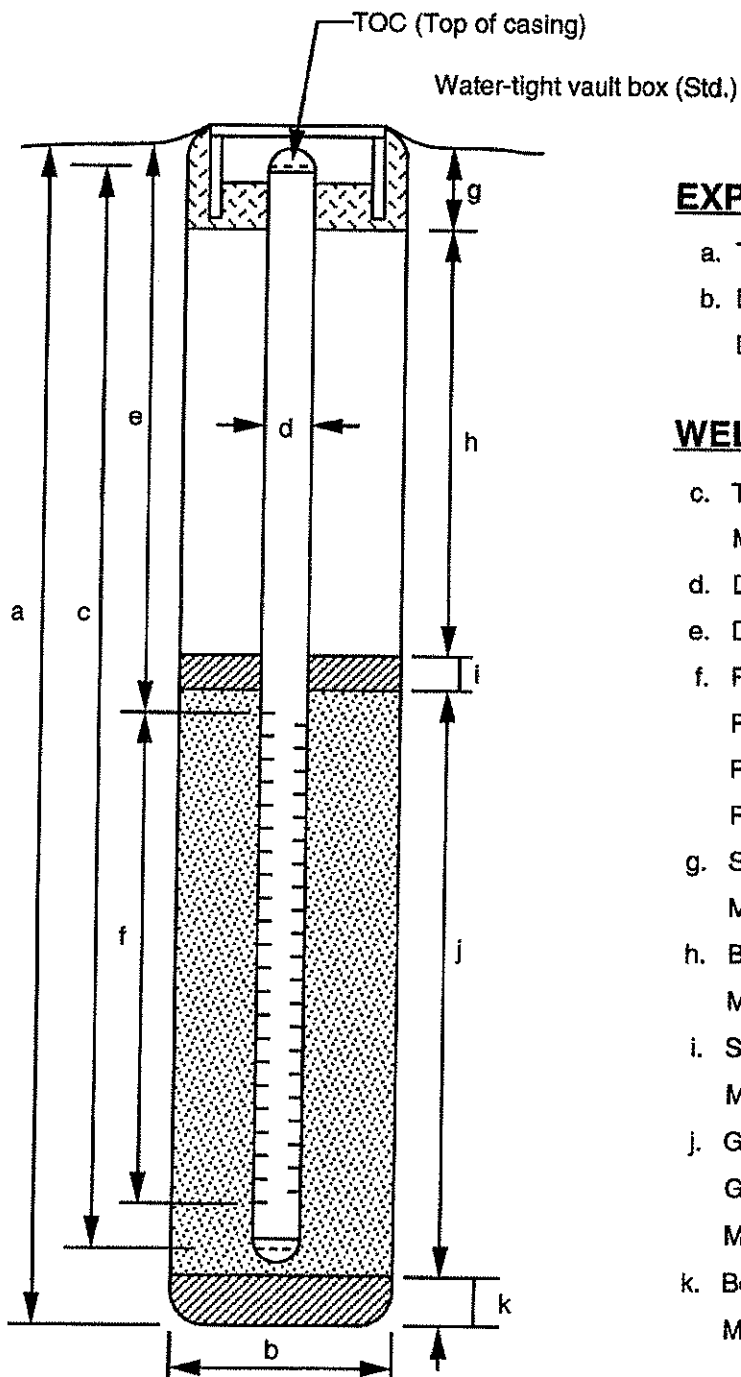

## EXPLORATORY BORING

a. Total depth 30.5 ft.  
 b. Diameter 10.0 in.  
 Drilling method Hollow Stem Auger

## WELL CONSTRUCTION

c. Total casing length na ft.  
 Material Schedule 40 PVC  
 d. Diameter 4.0 in.  
 e. Depth to top perforations 12.0 ft.  
 f. Perforated length 14.2 ft.  
 Perforated interval from 12.0 to 26.2 ft.  
 Perforation type Machine Slotted  
 Perforation size 0.020 inch  
 g. Surface seal 1.0 ft.  
 Material Concrete  
 h. Backfill 7.5 ft.  
 Material Cement  
 i. Seal 1.5 ft.  
 Material Bentonite  
 j. Gravel pack 17.0 ft.  
 Gravel pack interval from 10.0 to 27.0 ft.  
 Material 2/12 Sand  
 k. Bottom seal/fill 3.5 ft.  
 Material Bentonite & Native Slough

# LOG OF EXPLORATORY BORING

PROJECT NUMBER: 805-127.01

BORING NO.: MW-2

PROJECT NAME: ARCO Service Station 2111

PAGE: 1 of 2

BY: R. Davis

DATE: 7/12/85

SURFACE ELEVATION: 38.71 ft.

RECOVERY (ft/ft)	PENETRA- TION (blows/ft)	GROUND WATER LEVELS	DEPTH IN FEET	SAMPLES	LITHOGRAPHIC COLUMN	DESCRIPTION	WELL DETAIL
					ASPHALT		
					FILL - SANDY GRAVEL (GP).		
100%	0	18	5	5	CLAYEY SILT (ML), very dark grayish brown (2.5Y, 3/2); 85-90% low- to medium-plasticity fines; 10-15% fine to coarse sand; stiff to very stiff; damp; no odor.; @5.5': trace fine gravel.		
100%	0	20	10	10	SILTY CLAY (CL), dark brown (2.5Y, 4/2); low- to medium- plasticity fines; trace coarse sand and fine gravel; stiff to very stiff; damp; no product odor.		
100%	0	20	15	15	@15.0-17.5': very dark grayish brown (2.5Y, 3/2) with yellowish brown mottling; 90-100% low- to medium-plasticity fines; trace to 10% fine to coarse sand; very stiff; damp to moist; no product odor.		
100%	6.2	26	26	26	@18.0-19.5': as above with grayish mottling; low- to medium- plasticity fines, higher silt content than above; very stiff; moist to wet; product odor.		
100%	9.3	23	23	23			
			20				

**REMARKS**

Boring drilled with 8" diameter hollow-stem augers and reamed with 10" diameter augers. Samples were taken using a 2" diameter modified-California split spoon sampler. Boring converted into a 4" diameter polyvinyl chloride (PVC) groundwater monitoring well. See explanation sheet for definition of symbols used in well detail and sample columns of this log. See explanation sheet for definition of symbols on this log.



**EMCON**  
ASSOCIATES

# LOG OF EXPLORATORY BORING

PROJECT NUMBER: 805-127.01

BORING NO.: MW-2

PROJECT NAME: ARCO Service Station 2111

PAGE: 2 of 2

BY: R. Davis

DATE: 7/12/95

SURFACE ELEVATION: 38.71 ft.

RECOVERY (ft/ft)	PENETRATION (blows/ft)	GROUND WATER LEVELS	DEPTH IN FEET	SAMPLES	LITHOGRAPHIC COLUMN	DESCRIPTION	WELL DETAIL
100%	183	22				SILTY CLAY (CL), continued.	
90%	44	35				SANDY CLAY (CL), light olive brown (2.5Y, 5/4); 70% medium- plasticity fines; 30% fine to coarse sand; very stiff to hard; moist; no odor.	
25%	78	14					
30%		23	25			GRAVEL (GP), dark grayish brown (2.5Y, 4/2); 5-10% low- plasticity fines; 35% fine to coarse sand; 55-60% fine gravel; medium dense; wet; product odor. @25.0-27.2': 10% fines; 40% fine to coarse sand, f:m:c= 2:1:1; 50% fine to coarse gravel to 1.25"; wet; product odor.	
20%		13					
5%		16				@27.5-30.5': poor recovery of native material because of heaving sands inside augers.	
10%		19	30			CLAY to SANDY CLAY (CL), light olive brown (2.5Y, 5/4); 75-90% low- to medium-plasticity fines; 10-25% fine to coarse sand; trace fine gravel, rounded; stiff; wet; no product odor.	
						BORING TERMINATED AT 30.5 FEET BGS.	
			35				
			40				

**REMARKS**

Boring drilled with 8" diameter hollow-stem augers and reamed with 10" diameter augers. Samples were taken using a 2" diameter modified-California split spoon sampler. Boring converted into a 4" diameter polyvinyl chloride (PVC) groundwater monitoring well. See explanation sheet for definition of symbols used in well detail and sample columns of this log. See explanation sheet for definition of symbols on this log.





# WELL DETAILS



EMCON  
ASSOCIATES

PROJECT NUMBER 0805-127.01 BORING / WELL NO. MW-3  
 PROJECT NAME ARCO 2111 TOP OF CASING ELEV. 39.32  
 LOCATION 1156 Davis Street, San Leandro GROUND SURFACE ELEV. 40.01  
 WELL PERMIT NO. na DATUM M.S.L.  
 INSTALLATION DATE 7/13/95

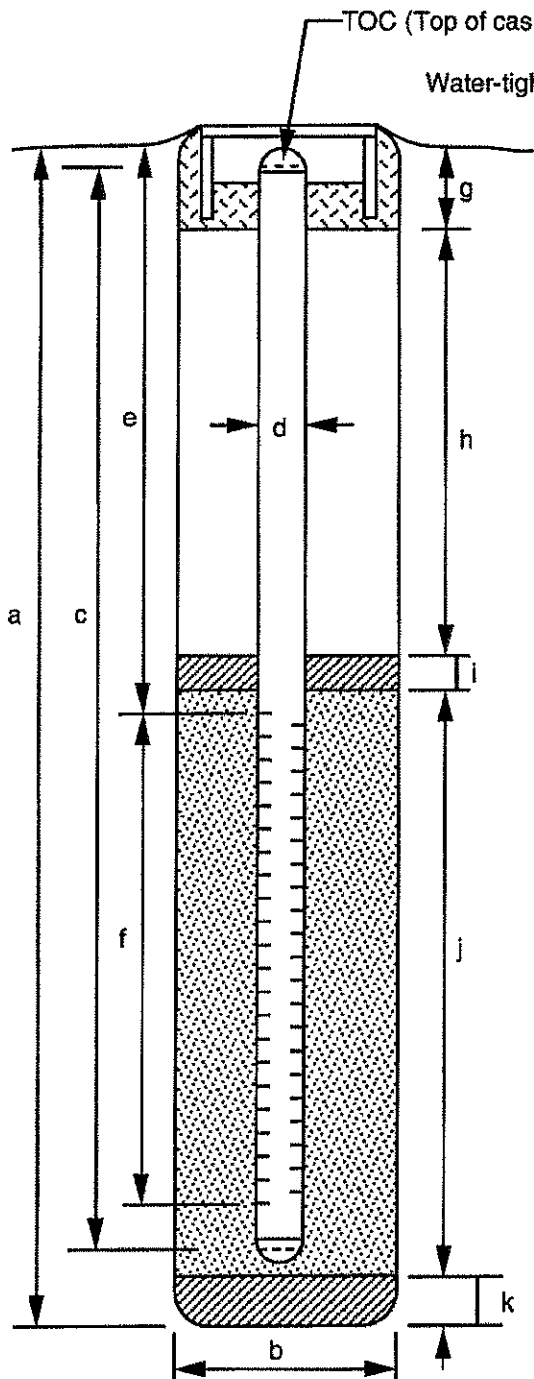

## EXPLORATORY BORING

a. Total depth 40.0 ft.  
 b. Diameter 10.0 in.  
 Drilling method Hollow Stem Auger

## WELL CONSTRUCTION

c. Total casing length na ft.  
 Material Schedule 40 PVC  
 d. Diameter 4.0 in.  
 e. Depth to top perforations 11.9 ft.  
 f. Perforated length 14.3 ft.  
 Perforated interval from 11.9 to 26.2 ft.  
 Perforation type Machine Slotted  
 Perforation size 0.020 inch  
 g. Surface seal 1.0 ft.  
 Material Concrete  
 h. Backfill 8.5 ft.  
 Material Cement  
 i. Seal 1.5 ft.  
 Material Bentonite  
 j. Gravel pack 16.0 ft.  
 Gravel pack interval from 11.0 to 27.0 ft.  
 Material 2/12 Sand  
 k. Bottom seal/fill 13.0 ft.  
 Material Bentonite

# LOG OF EXPLORATORY BORING

PROJECT NUMBER: 805-127.01

BORING NO.: MW-3

PROJECT NAME: ARCO Service Station 2111

PAGE: 1 of 3

BY: R. Davis

DATE: 7/12/95

SURFACE ELEVATION: 40.01 ft.

RECOVERY (ft/ft)	PENETRATION (blws/ft)	GROUND WATER LEVELS	DEPTH IN FEET	SAMPLES	LITHOGRAPHIC COLUMN	DESCRIPTION	WELL DETAIL
					ASPHALT		
					FILL - SANDY GRAVEL (GP)		
60%	0	27	5		SILTY CLAY (CL), very dark grayish brown (10YR, 3/2); 95-100% low- to medium-plasticity fines; trace to 5% fine sand; very stiff; damp; no odor.		
70%	6.0	21			@7.0': 10% fine to coarse sand; trace fine gravel.		
60%	0	32					
60%	0.9	26	10		@10.0-14.5': 95% medium-plasticity fines; 5% fine to medium sand; very stiff to hard; damp; no odor.		
100%	0	25					
100%	0	41					
60%	0	28	15		@14.5-15.5': mottled olive brown (2.5Y, 5/4) and dark olive gray (5Y, 3/2); moist; no odor.		
100%	0	25			CLAYEY SAND (SC) AND SANDY CLAY (CL) -Interbedded, 60/40:		
80%	0	33			CLAYEY SAND (SC), olive gray (5Y, 5/2); 40% low- to medium- plasticity fines; 60% fine to medium sand, f:m=3:1; medium dense; moist to wet; no odor.		
100%	0	18			SANDY CLAY (CL), olive gray (5Y, 5/2); 60-70% low- to medium- plasticity fines; 30-40% fine to medium sand; moist; reddish brown veins; no odor.		
			20		@16.7-20.0': 80-85% low- to medium-plasticity fines; 15-20% fine to coarse sand; stiff; moist; no odor.		

**REMARKS**

Boring drilled with 8" diameter hollow-stem augers and reamed with 10" diameter augers. Samples were taken using a 2" diameter modified-California split spoon sampler. Boring converted into a 4" diameter polyvinyl chloride (PVC) groundwater monitoring well. See explanation sheet for definition of symbols used in well detail and sample columns of this log. See explanation sheet for definition of symbols on this log.



# LOG OF EXPLORATORY BORING

PROJECT NUMBER: 805-127.01

BORING NO.: MW-3

PROJECT NAME: ARCO Service Station 2III

PAGE: 2 of 3

BY: R. Davis

DATE: 7/12/95

SURFACE ELEVATION: 40.01 ft.

RECOVERY (ft/ft)	PENETRA- TION (blws/ft)	GROUND WATER LEVELS	DEPTH IN FEET	SAMPLES	LITHOGRAPHIC COLUMN	DESCRIPTION	WELL DETAIL
100%		25					
90%	0	39				SANDY CLAY (CL), continued.	
60%	0	17				@20.0-23.0': very stiff; moist to wet (moisture visible in voids).	
50%	0	37	25				
90%	0	33					
90%		27				SANDY SILT (ML), yellowish brown (10YR, 5/4) with light brownish gray (2.5Y, 6/2) mottling; 40% low- to medium-plasticity fines; medium dense; wet; no odor.	
100%	0	16					
60%		20	30				
60%	0	26				SILTY CLAY (CL), yellowish brown (10YR, 5/4); 75-80% low- to medium-plasticity fines; 20-25% fine to medium sand, f:m=5:1; stiff; wet (moisture visible in voids and fractures); no odor.	
100%	0	30				CLAYEY SAND (SC), yellowish brown (10YR, 5/4) with light brownish gray (2.5Y, 6/2) mottling; 40% low- to medium- plasticity fines; medium dense; wet; no odor.	
100%	0	24	35				
100%		37				SILTY CLAY (CL), yellowish brown (10YR, 5/4); 75-80% low- to medium-plasticity fines; 20-25% fine to medium sand, f:m=5:1; stiff; wet (moisture visible in voids and fractures); no odor.	
100%		76				@34.5-40.0': trace coarse sand and fine gravel.	
100%	0	61	40				

**REMARKS**

Boring drilled with 8" diameter hollow-stem augers and reamed with 10" diameter augers. Samples were taken using a 2" diameter modified-California split spoon sampler. Boring converted into a 4" diameter polyvinyl chloride (PVC) groundwater monitoring well. See explanation sheet for definition of symbols used in well detail and sample columns of this log. See explanation sheet for definition of symbols on this log.



**EMCON**  
ASSOCIATES

# LOG OF EXPLORATORY BORING

PROJECT NUMBER: 805-127.01

BORING NO.: MW-3

PROJECT NAME: ARCO Service Station 2111

PAGE: 3 of 3

BY: R. Davis

DATE: 7/12/95

SURFACE ELEVATION: 40.01 ft.

RECOVERY (ft/ft)	PENETRA- TION (blws/ft)	GROUND WATER LEVELS	DEPTH IN FEET	SAMPLES	LITHOGRAPHIC COLUMN	DESCRIPTION	WELL DETAIL
			45		○	<p>SILTY GRAVEL (GM), light olive brown (2.5Y, 5/4); 10-20% low-plasticity fines; 30% fine to coarse sand; 50-60% fine to coarse gravel; dense; wet; no odor.</p> <p>BORING TERMINATED AT 40.5 FEET.</p>	
			50				
			55				
			60				



**EMCON**  
ASSOCIATES

**REMARKS**

Boring drilled with 8" diameter hollow-stem augers and reamed with 10" diameter augers. Samples were taken using a 2" diameter modified-California split spoon sampler. Boring converted into a 4" diameter polyvinyl chloride (PVC) groundwater monitoring well. See explanation sheet for definition of symbols used in well detail and sample columns of this log. See explanation sheet for definition of symbols on this log.

# WELL DETAILS



EMCON  
ASSOCIATES

PROJECT NUMBER 0805-127.01 BORING / WELL NO. MW-4  
 PROJECT NAME ARCO 2111 TOP OF CASING ELEV. 38.10  
 LOCATION 1156 Davis Street, San Leandro GROUND SURFACE ELEV. 38.88  
 WELL PERMIT NO. na DATUM M.S.L.  
 INSTALLATION DATE 7/13/95

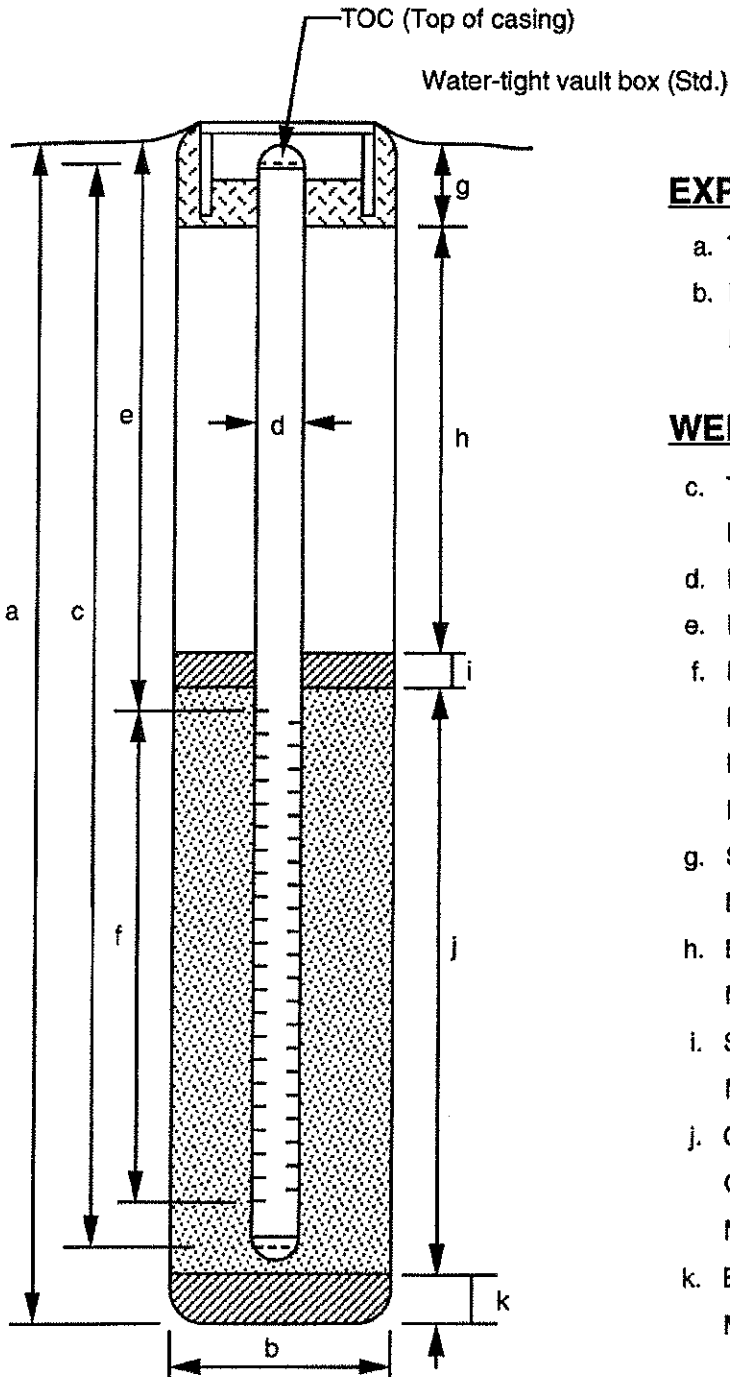

## EXPLORATORY BORING

a. Total depth 28.5 ft.  
 b. Diameter 10.0 in.  
 Drilling method Hollow Stem Auger

## WELL CONSTRUCTION

c. Total casing length na ft.  
 Material Schedule 40 PVC  
 d. Diameter 4.0 in.  
 e. Depth to top perforations 10.0 ft.  
 f. Perforated length 14.0 ft.  
 Perforated interval from 10.0 to 24.0 ft.  
 Perforation type Machine Slotted  
 Perforation size 0.020 inch  
 g. Surface seal 1.0 ft.  
 Material Concrete  
 h. Backfill 6.0 ft.  
 Material Cement  
 i. Seal 1.5 ft.  
 Material Bentonite  
 j. Gravel pack 16.5 ft.  
 Gravel pack interval from 8.5 to 25.0 ft.  
 Material 2/12 Sand  
 k. Bottom seal/fill 3.5 ft.  
 Material Native Slough

# LOG OF EXPLORATORY BORING

PROJECT NUMBER: 805-127.01

BORING NO.: MW-4

PROJECT NAME: ARCO Service Station 2111

PAGE: 1 of 2

BY: R. Davis

DATE: 7/13/95

SURFACE ELEVATION: 38.88 ft.

RECOVERY (ft/ft)	PENETRATION (blows/ft)	GROUND WATER LEVELS	DEPTH IN FEET	SAMPLES	LITHOGRAPHIC COLUMN	DESCRIPTION	WELL DETAIL
					ASPHALT		
					FILL, SANDY GRAVEL (GP).		
40%	0	16	5	█	CLAYEY GRAVEL (GC), very dark grayish brown (10YR, 3/2); 90-95% medium plasticity fines; 5-10% fine to medium sand; stiff; damp; no product odor.		
100%	0	20	10	█	@10.0-11.5': very stiff; trace calcium carbonate fragments in small voids (0.1-0.25"); damp; no product odor.		
100%	0	28	15	█	@15.0-16.5': mottled light olive brown (2.5Y, 5/4) and light gray (2.5Y, 7/2); rootholes and small fractures visible.		
			20		SANDY CLAY (CL), mottled light olive brown (2.5Y, 5/4) and dark yellowish brown (10YR, 4/4); 65% medium-plasticity fines; 25% fine to coarse sand, f:m:c=2:l:l; 10% fine to coarse gravel; stiff to very stiff; wet (moisture visible in voids); no product odor.		

**REMARKS**

Boring drilled with 8" diameter hollow-stem augers and reamed with 10" diameter augers. Samples were taken using a 2" diameter modified-California split spoon sampler. Boring converted into a 4" diameter polyvinyl chloride (PVC) groundwater monitoring well. See explanation sheet for definition of symbols used in well detail and sample columns of this log. See explanation sheet for definition of symbols on this log.



**EMCON**  
ASSOCIATES

# LOG OF EXPLORATORY BORING

PROJECT NUMBER: 805-127.01

BORING NO.: MW-4





PROJECT NAME: ARCO Service Station 2III

PAGE: 2 of 2

BY: R. Davis

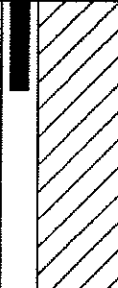
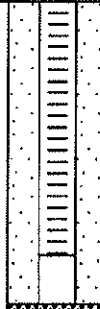
DATE: 7/13/95

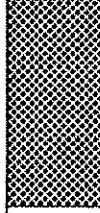
SURFACE ELEVATION: 38.88 ft.

RECOVERY (ft/ft)	PENETRATION (blows/ft)	GROUND WATER LEVELS	DEPTH IN FEET	SAMPLES	LITHOGRAPHIC COLUMN	DESCRIPTION	WELL DETAIL
100%	0		24			SANDY CLAY (CL), continued.	
90%	0		26			@25.0-27.7': 25% fine to medium sand; iron oxide staining; firm; wet; no product odor.; 70% medium-plasticity fines; 30% fine to coarse sand; very stiff; moist; no odor.	
60%			56			CLAYEY GRAVEL (GC) TO CLAYEY SAND (SC), light olive brown (2.5Y, 5/4); 10-20% medium plastic fines; 40-45% fine to coarse sand, f:m:c=1:2:4; 40-45% fine gravel; very dense; wet; no product odor.	
			30			BORING TERMINATED AT 28.5 FEET BGS.	
			35				
			40				

**REMARKS**

Boring drilled with 8" diameter hollow-stem augers and reamed with 10" diameter augers. Samples were taken using a 2" diameter modified-California split spoon sampler. Boring converted into a 4" diameter polyvinyl chloride (PVC) groundwater monitoring well. See explanation sheet for definition of symbols used in well detail and sample columns of this log. See explanation sheet for definition of symbols on this log.



# WELL DETAILS



EMCON

PROJECT NUMBER 20805-127.001

PROJECT NAME Arco Station #2111

COUNTY San Leandro

WELL PERMIT NO. 96126 (ZONE 7)

BORING/WELL NO. MW-5

TOP OF CASING ELEV. 37.21

GROUND SURFACE ELEV. 37.66

DATUM MSL

INSTALLATION DATE 3/1/96

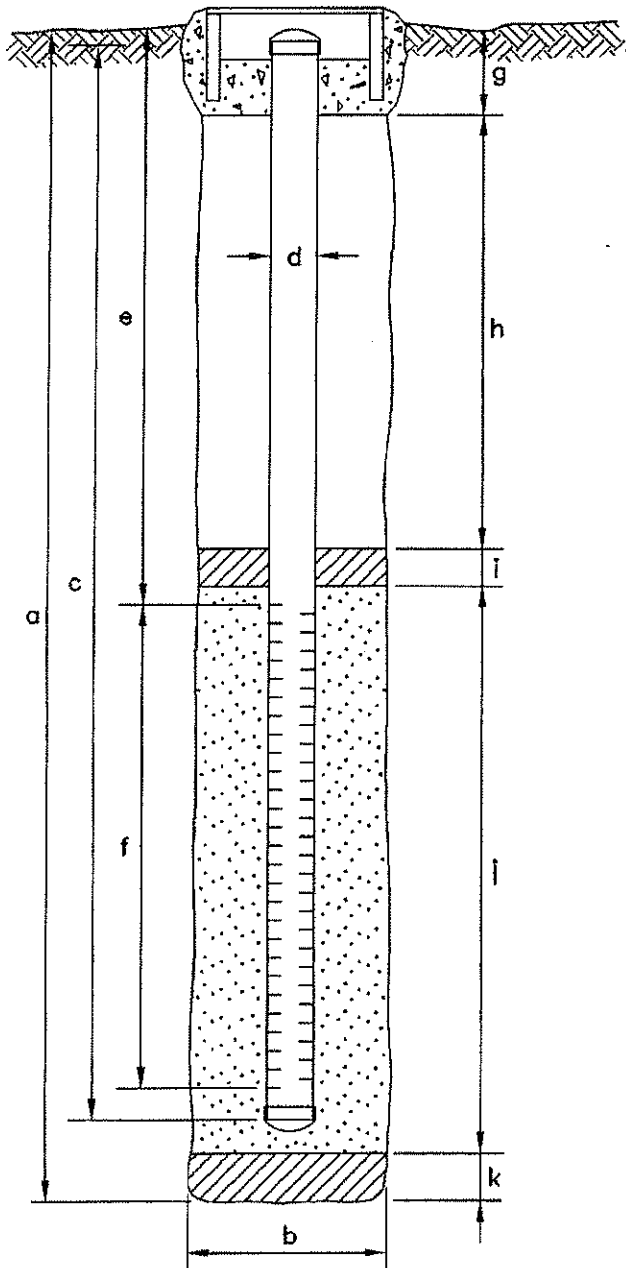

## EXPLORATORY BORING

- a. Total depth 30 ft.
- b. Diameter 8 in.
- Drilling method HOLLOW STEM AUGER

## WELL CONSTRUCTION

- c. Total casing length 24 ft.  
Material SCH 40 PVC
- d. Diameter 2 in.
- e. Depth to top perforations 9.4 ft.
- f. Perforated length 14.0 ft.  
Perforated interval from 9.4 to 23.4 ft.  
Perforation type MACHINE SLOTTED  
Perforation size 0.010 INCH
- g. Surface seal 0.5 ft.  
Seal material CONCRETE
- h. Backfill 6.5 ft.  
Backfill material CEMENT
- i. Seal 1.0 ft.  
Seal material BENTONITE
- j. Gravel pack 15.0 ft.  
Pack material #2/12 SAND
- k. Bottom seal 6.0 ft.  
Seal material BENTONITE



# LOG OF EXPLORATORY BORING

PROJECT NUMBER	20805-127.001	BORING NO.	MW-5
PROJECT NAME	Arco Service Station #2111, San Leandro, California	PAGE	1 OF 2
BY R. Davis	DATE 3/1/96	SURFACE ELEV.	37.66 ft.

PID Reading (ppm)	Sample Recovery (ft./ft.)	Penetration (Blows per 6")	GROUND WATER LEVELS	DEPTH IN FT.	SAMPLES	LITHO-GRAPHIC COLUMN	DESCRIPTION	WELL DETAIL
						ASPHALT.		
						ROADBASE FILL: CLAYEY GRAVEL, no product odor.		
0.0	1.5/1.5	4 15 20		5	5	SILTY CLAY (CL), dark grayish brown (10YR, 3/2); 100% low to medium-plasticity fines; trace fine sand; roots and rootholes common; hard; damp; no odor.		
0.0	1.5/1.5	7 13 19		10	10	@9-10.5': very dark grayish brown (10YR, 3/2); rootholes common; hard; damp; no hydrocarbon odor.		
0.0	1.5/1.5	5 11 12	▼	15	15	@14-15.5': light olive brown (2.5Y, 5/4) with trace black mottling; 90% low to medium-plasticity fines; 10% fine-grained sand; hard; moist; no hydrocarbon odor.		
			▼	17		@17': Water visible inside augers.		
0.0	1.5/1.5	15 18		20	20	@19-20.5': as above; grayish veins present; hard; wet; no hydrocarbon odor.		



**REMARKS**  
 Boring drilled to a depth of 30 feet below grade (fbg) by West Hazmat using 8" dia. hollow-stem auger equipment. Boring completed as a 2" dia. PVC groundwater monitoring well screened from 9 to 24 fbg. Groundwater was first encountered at 17 fbg and stabilized at 13 fbg.

# LOG OF EXPLORATORY BORING

PROJECT NUMBER	20805-127.001	BORING NO.	MW-5
PROJECT NAME	Arco Service Station #2111, San Leandro, California	PAGE	2 OF 2
BY	R. Davis	DATE	3/1/96
		SURFACE ELEV.	37.66 ft.

PID Reading (ppm)	Sample Recovery (ft./ft.)	Penetration (Blows per 6")	GROUND WATER LEVELS	DEPTH IN FT.	SAMPLES	LITHO-GRAPHIC COLUMN	DESCRIPTION	WELL DETAIL
		25					SILTY CLAY (CL), continued.	
0.0	1.5/1.5	4 4 8		25			@24-25.5': as above; no hydrocarbon odor.	
0.0	1.5/1.5	7 11 15		30			@28.5-30': as above; wet; no hydrocarbon odor.	
				30			<b>BORING TERMINATED AT 30 FBG.</b>	
				35				
				40				



**REMARKS**

Boring drilled to a depth of 30 feet below grade (fbg) by West Hazmat using 8" dia. hollow-stem auger equipment. Boring completed as a 2" dia. PVC groundwater monitoring well screened from 9 to 24 fbg. Groundwater was first encountered at 17 fbg and stabilized at 13 fbg.

# WELL DETAILS



EMCON

PROJECT NUMBER 20805-127.001

PROJECT NAME Arco Station #2111

COUNTY San Leandro

WELL PERMIT NO. 96126 (ZONE 7)

BORING/WELL NO. MW-6

TOP OF CASING ELEV. 37.11

GROUND SURFACE ELEV. 38.19

DATUM MSL

INSTALLATION DATE 3/1/96

## EXPLORATORY BORING

a. Total depth 27.5 ft.

b. Diameter 8 in.

Drilling method HOLLOW STEM AUGER

## WELL CONSTRUCTION

c. Total casing length 24 ft.

Material SCH 40 PVC

d. Diameter 2 in.

e. Depth to top perforations 10 ft.

f. Perforated length 15 ft.

Perforated interval from 10 to 25 ft.

Perforation type MACHINE SLOTTED

Perforation size 0.010 INCH

g. Surface seal 0.5 ft.

Seal material CONCRETE

h. Backfill 7.5 ft.

Backfill material CEMENT

i. Seal 1.0 ft.

Seal material BENTONITE

j. Gravel pack 16.0 ft.

Pack material #2/12 SAND

k. Bottom seal 2.5 ft.

Seal material NATIVE SLOUGH

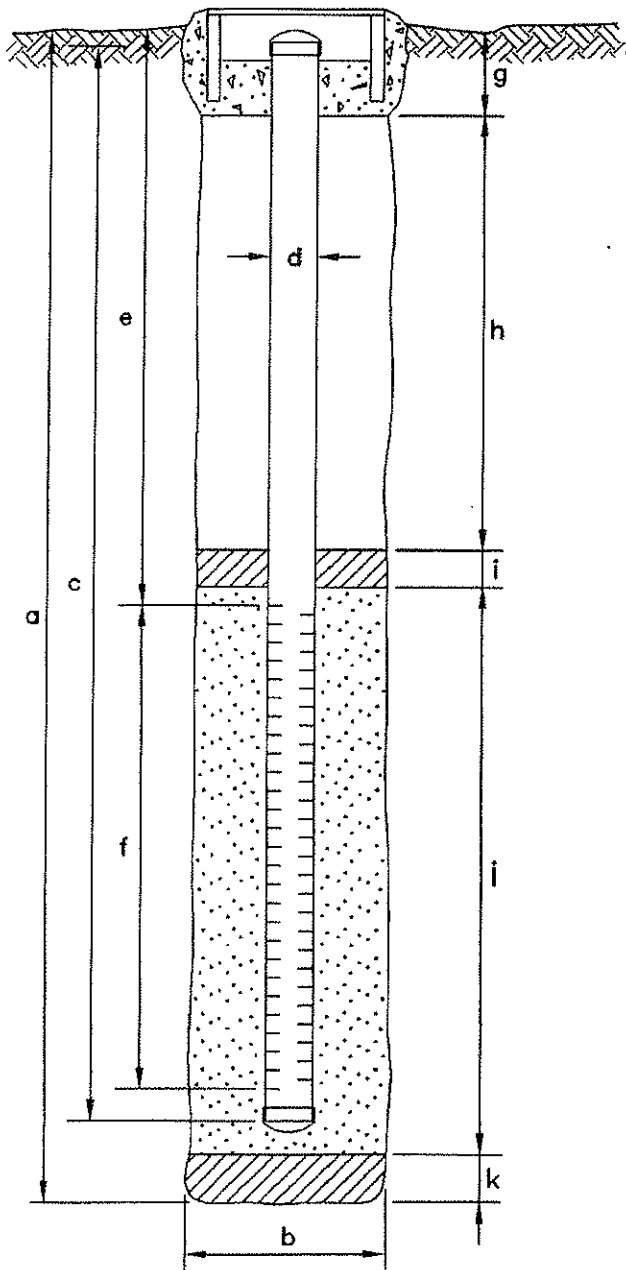

# LOG OF EXPLORATORY BORING

PROJECT NUMBER	20805-127.001	BORING NO.	MW-6
PROJECT NAME	Arco Service Station #2111, San Leandro, California	PAGE	1 OF 2
BY	R. Davis	DATE	3/1/96
		SURFACE ELEV.	38.19 ft.

PID Reading (ppm)	Sample Recovery (ft./ft.)	Penetration (Blows per 6")	GROUND WATER LEVELS	DEPTH IN FT.	SAMPLES	LITHO-GRAPHIC COLUMN	DESCRIPTION	WELL DETAIL
						ASPHALT.		
						ROADBASE FILL: CLAYEY GRAVEL (GC), no hydrocarbon odor.		
0.0	1.3/1.5	6 10 10		5			CLAY (CL), dark grayish brown (10YR, 3/2); 100% medium-plasticity fines; trace fine sand; very stiff; damp; no hydrocarbon odor.	
0.0	1.5/1.5	7 11 20		10			@9-10.5': as above; 10% fine gravel, angular; very stiff; damp; no hydrocarbon odor.	
0.0	1.5/1.5	6 11 12	▽	15			@14-15.5': light olive brown (2.5Y, 5/4) with trace black mottling; 100% low to medium-plasticity fines (high silt content); trace fine sand; very stiff; moist; no hydrocarbon odor.	
0.0	1.5/1.5	7 12 15	▽	16.5			@16.5-18': as above; wet; no product odor.	
0.0	1.4/1.5	8 9		20			@19-20.5': as above; trace black mottling; 10-20% fine to coarse-grained sand; no hydrocarbon odor.	



**REMARKS**  
 Boring drilled to a depth of 27.5 feet below grade (fbg) by West Hazmat using 8" dia. hollow-stem auger equipment. Boring completed as a 2" dia. PVC groundwater monitoring well screened from 10 to 25 fbg. Groundwater was first encountered at 16 fbg and stabilized at 14 fbg.

# LOG OF EXPLORATORY BORING

PROJECT NUMBER	20805-127.001	BORING NO.	MW-6
PROJECT NAME	Arco Service Station #2111, San Leandro, California	PAGE	2 OF 2
BY	R. Davis	DATE	3/1/96
		SURFACE ELEV.	38.19 ft.

PID Reading (ppm)	Sample Recovery (ft./ft.)	Penetration (Blows per 6")	GROUND WATER LEVELS	DEPTH IN FT.	SAMPLES	LITHO-GRAPHIC COLUMN	DESCRIPTION	WELL DETAIL
		13					CLAY (CL), continued.	
0.0	0.9/1.5	15 19 25					CLAYEY GRAVEL (GC), light olive brown (2.5Y, 5/4); 20-25% low to medium- plasticity fines; 20% fine to coarse-grained sand; 55-60% fine to coarse gravel (to 2" dia.); dense; wet; no hydrocarbon odor.	
0.0	1.0/1.5	25 28		25			@24.5-27.5': as above; no hydrocarbon odor.	
0.0	0.8/1.5	50/5.5" 10 25 45						
				30				
				35				
				40			BORING TERMINATED AT 27.5 FBG.	



**REMARKS**  
 Boring drilled to a depth of 27.5 feet below grade (fbg) by West Hazmat using 8" dia. hollow-stem auger equipment. Boring completed as a 2" dia. PVC groundwater monitoring well screened from 10 to 25 fbg. Groundwater was first encountered at 16 fbg and stabilized at 14 fbg.

# WELL DETAILS



EMCON

PROJECT NUMBER 20805-127.001  
 PROJECT NAME Arco Station #2111  
 COUNTY San Leandro  
 WELL PERMIT NO. 96126 (ZONE 7)

BORING/WELL NO. MW-7  
 TOP OF CASING ELEV. 38.68  
 GROUND SURFACE ELEV. 38.99  
 DATUM MSL  
 INSTALLATION DATE 2/29/96

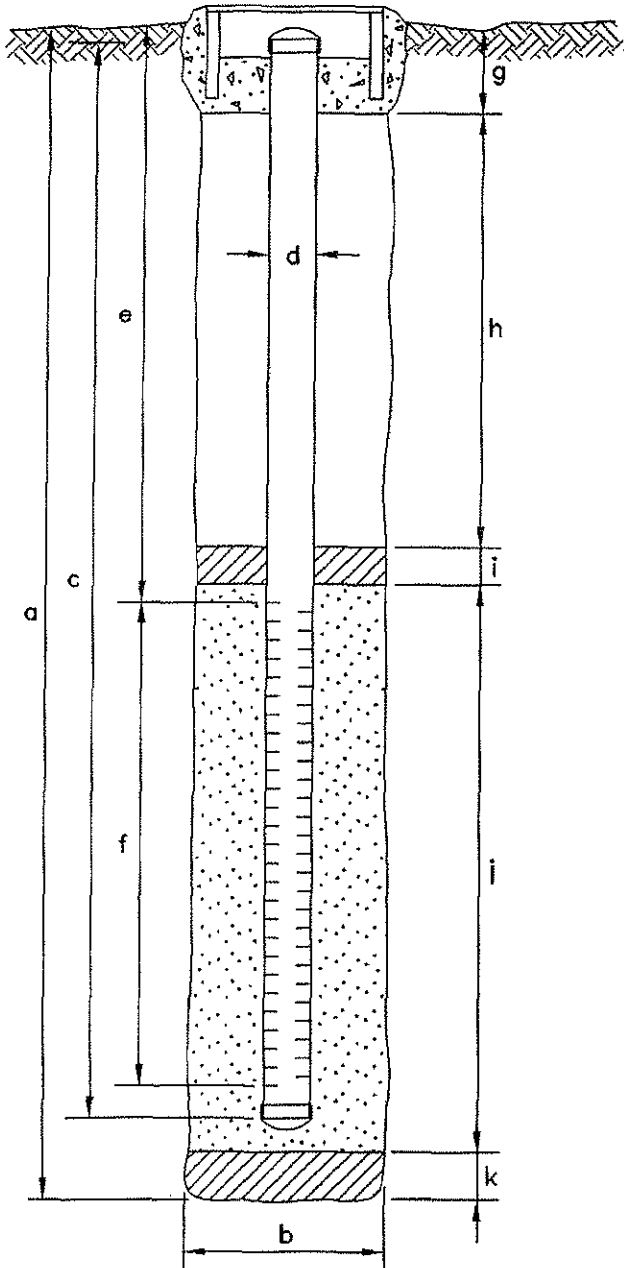

## EXPLORATORY BORING

- a. Total depth 33.5 ft.
- b. Diameter 10 in.
- Drilling method HOLLOW STEM AUGER

## WELL CONSTRUCTION

- c. Total casing length 27 ft.  
Material SCH 40 PVC
- d. Diameter 4 in.
- e. Depth to top perforations 12 ft.
- f. Perforated length 15 ft.  
Perforated interval from 12 to 27 ft.  
Perforation type MACHINE SLOTTED  
Perforation size 0.010 INCH
- g. Surface seal 0.5 ft.  
Seal material CONCRETE
- h. Backfill 9.0 ft.  
Backfill material CEMENT
- i. Seal 1.0 ft.  
Seal material BENTONITE
- j. Gravel pack 16.5 ft.  
Pack material #2/12 SAND
- k. Bottom seal 6.5 ft.  
Seal material NATIVE SLOUGH

# LOG OF EXPLORATORY BORING

PROJECT NUMBER	20805-127.001	BORING NO.	MW-7
PROJECT NAME	Arco Service Station #2111, San Leandro, California	PAGE	1 OF 2
BY R. Davis	DATE 2/29/96	SURFACE ELEV.	38.99 ft.

PID Reading (ppm)	Sample Recovery (ft./ft.)	Penetration (Blows per 6")	GROUND WATER LEVELS	DEPTH IN FT.	SAMPLES	LITHO-GRAPHIC COLUMN	DESCRIPTION	WELL DETAIL
						ASPHALT.		
						FILL: GRAVEL (GP) ROADBASE.		
						FILL: CLAYEY GRAVEL (GC), brown; damp; no hydrocarbon odor.		
2.8	1.0/1.5	16 20 26		5	5	SILTY CLAY (CL), dark grayish brown (10YR, 4/2); 85-90% low to medium-plasticity fines; 10-15% fine to coarse-grained sand; trace iron oxide staining; hard; damp; no hydrocarbon odor.		
7.9	1.2/1.5	5 8 18		10	10	@9.5-11': very dark grayish brown (10YR, 3/2); as above (high silt content); trace rootholes; very stiff; damp; no hydrocarbon odor.		
--	0/1.5	--			12	@12-13.5': no recovery.		
28.0	1.5/1.5	7 17		15	15	@14.5-15': as above; moist.		
34.0	1.5/1.5	8 18		15	15	@15-16': gray (5Y, 5/1) with yellowish brown (10YR, 5/4) mottling; rootholes common; hard; moist; hydrocarbon odor.		
77.0	1.0/1.5	9 12 20	▽		17	@17.5-19': grayish veins present; 90% low to medium-plasticity fines; 10% fine-grained sand; trace fine gravel; hard; wet; hydrocarbon odor.		
101.0	1.3/1.5	13 15			20			

**REMARKS**  
 Boring drilled to a depth of 33.5 feet below grade (fbg) by West Hazmat using 10" dia. hollow-stem auger equipment. Boring completed as a 4" dia. PVC groundwater monitoring well screened from 12 to 27 fbg. Groundwater was encountered at 17 fbg.



# LOG OF EXPLORATORY BORING

PROJECT NUMBER	20805-127.001	BORING NO.	MW-7
PROJECT NAME	Arco Service Station #2111, San Leandro, California	PAGE	2 OF 2
BY R. Davis	DATE 2/29/96	SURFACE ELEV.	38.99 ft.

PID Reading (ppm)	Sample Recovery (ft./ft.)	Penetration (Blows per 6")	GROUND WATER LEVELS	DEPTH IN FT.	SAMPLES	LITHO-GRAPHIC COLUMN	DESCRIPTION	WELL DETAIL
--	1.3/1.5	20					<p><b>SANDY CLAY (CL)</b>, yellowish brown (10YR, 5/4) with gray (5Y, 5/1) mottling; 65-75% low to medium-plasticity fines; 25-30% fine to coarse-grained sand; 5% fine gravel; very stiff; wet; hydrocarbon odor.</p> <p><b>CLAYEY SAND (SC)</b>, mottled olive brown (2.5Y, 4/4) to yellowish brown (10YR, 5/4); 25-30% low to medium-plasticity fines; 45-50% fine to coarse-grained sand; 25% fine to coarse gravel; dense; wet; hydrocarbon odor.                      @22-23.5': very dense; wet; hydrocarbon odor.                      @23.5-25': no recovery; very dense.</p> <p>From 25 to 32.5': Minimal recovery due to heaving sands.</p> <p><b>CLAY (CL)</b>, mottled yellowish brown (10YR, 5/4) to dark brown (10YR, 5/2); 85-95% medium-plasticity fines; 5-15% fine to coarse-grained sand; hard; wet; no hydrocarbon odor.</p> <p><b>BORING TERMINATED AT 33.5 FBG.</b></p>	
--	0.5/1.5	8						
--	0.5/1.5	15						
--	0.5/1.5	15						
--	0.2/1.5	20						
--	0.2/1.5	22						
--	0.2/1.5	30						
--	0.2/0.5	50/6"		25				
--	0.2/0.5	50/6"						
--	0.1/0.5	50/6"						
--	0.2/0.5	50/6"						
--	0.2/0.5	50/6"		30				
--	0.2/0.5	50/6"						
--	0.5/0.5	50/6"						
1.4	0.6/1.0	50						
		50						
				35				
				40				



**REMARKS**  
 Boring drilled to a depth of 33.5 feet below grade (fbg) by West Hazmat using 10" dia. hollow-stem auger equipment. Boring completed as a 4" dia. PVC groundwater monitoring well screened from 12 to 27 fbg. Groundwater was encountered at 17 fbg.



# WELL DETAILS



PROJECT NUMBER 20805-127.001  
 PROJECT NAME Arco Station #2111  
 COUNTY San Leandro  
 WELL PERMIT NO. 96126 (ZONE 7)

BORING/WELL NO. VW-1  
 TOP OF CASING ELEV. 38.94  
 GROUND SURFACE ELEV. 39.39  
 DATUM MSL  
 INSTALLATION DATE 2/29/96

## EXPLORATORY BORING

- a. Total depth 20 ft.  
 b. Diameter 10 in.  
 Drilling method HOLLOW STEM AUGER

## WELL CONSTRUCTION

- c. Total casing length 19.5 ft.  
 Material SCH 40 PVC  
 d. Diameter 4 in.  
 e. Depth to top perforations 5 ft.  
 f. Perforated length 15 ft.  
 Perforated interval from 5 to 20 ft.  
 Perforation type MACHINE SLOTTED  
 Perforation size 0.020 INCH  
 g. Surface seal 0.5 ft.  
 Seal material CONCRETE  
 h. Backfill 3.0 ft.  
 Backfill material CEMENT  
 i. Seal 1.5 ft.  
 Seal material BENTONITE  
 j. Gravel pack 15.0 ft.  
 Pack material #2/12 SAND  
 k. Bottom seal NA ft.  
 Seal material NA

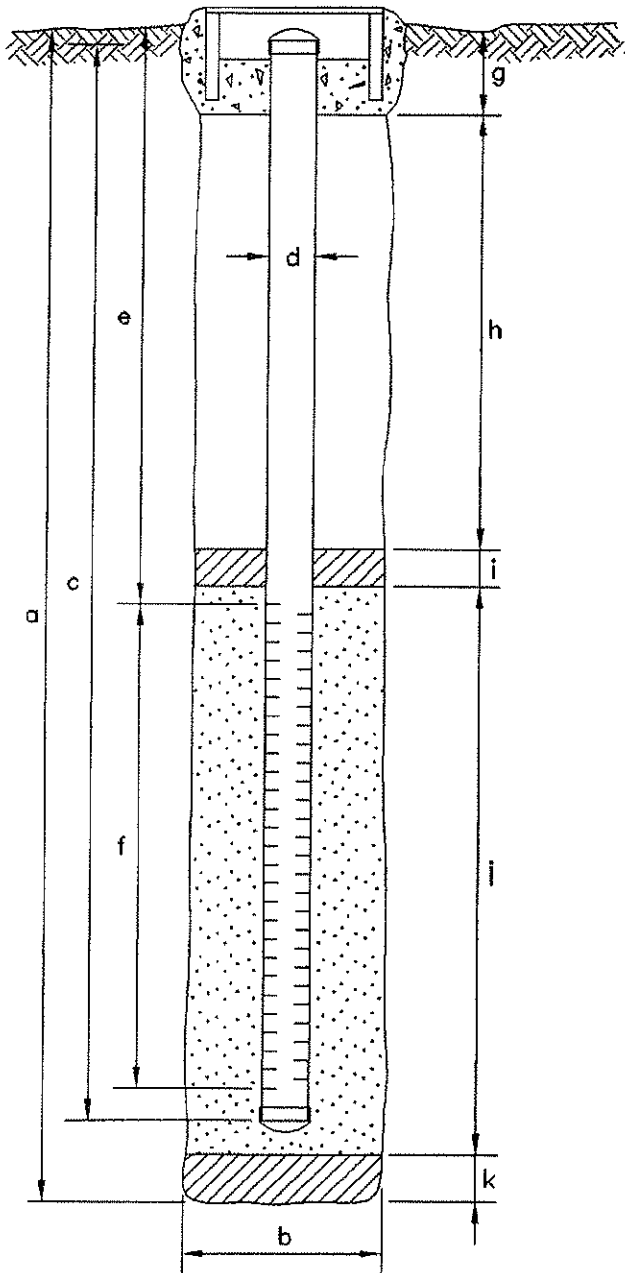

# LOG OF EXPLORATORY BORING

**PROJECT NUMBER** 20805-127.001 **BORING NO.** VW-1  
**PROJECT NAME** Arco Service Station #2111, San Leandro, California **PAGE** 1 OF 1  
**BY** R. Davis **DATE** 2/29/96 **SURFACE ELEV.** 39.39 ft.

PID Reading (ppm)	Sample Recovery (ft./ft.)	Penetration (Blows per 6")	GROUND WATER LEVELS	DEPTH IN FT.	SAMPLES	LITHO-GRAPHIC COLUMN	DESCRIPTION	WELL DETAIL
							<b>ASPHALT.</b> <b>ROADBASE FILL: GRAVEL (GP).</b>  <b>FILL: CLAYEY GRAVEL (GC),</b> light yellowish brown; no hydrocarbon odor.  <b>SILTY CLAY (CL),</b> dark grayish brown (10YR, 3/2); 95-100% low to medium-plasticity fines; trace to 5% fine-grained sand; occasional rootholes and orange mottling; hard; damp; no hydrocarbon odor.	
2.7	1.0/1.5	8 16 17		5				
2.2	1.2/1.5	10 11 16		10			@9.5-11': light olive brown (2.5Y, 5/4) with occasional dark brown mottling; rootholes present; very stiff; damp; no hydrocarbon odor.	
1.3	1.0/1.5	7 10 14					@12-13.5': mottled gray (5Y, 5/1) and light olive brown (2.5Y, 5/4); 90% low to medium-plasticity fines; 10% fine to medium-grained sand; rootholes present; very stiff; moist; hydrocarbon odor.	
5.3	1.2/1.5	9 10 12		15			@14.5-16': as above; moist; hydrocarbon odor.	
							@16': wet (moisture visible in voids); hydrocarbon odor.	
16.0	1.3/1.5	4 9 12					@17-18.5': as above; wet; hydrocarbon odor.	
210.0	1.3/1.5	7 7 17					@18.5-20': as above; 30% fine to coarse-grained sand; wet; hydrocarbon odor.	
				20			<b>BORING TERMINATED AT 20 FBG.</b>	



**REMARKS**  
 Boring drilled to a depth of 20 feet below grade (fbg) by West Hazmat using 10" dia. hollow-stem auger equipment. Boring completed as a 4" dia. PVC vapor extraction well screened from 5 to 15 fbg. Groundwater was encountered at 16 fbg.

# WELL DETAILS



EMCON

PROJECT NUMBER 20805-127.001  
 PROJECT NAME Arco Station #2111  
 COUNTY San Leandro  
 WELL PERMIT NO. 96126 (ZONE 7)

BORING/WELL NO. VW-2  
 TOP OF CASING ELEV. 38.28  
 GROUND SURFACE ELEV. 38.99  
 DATUM MSL  
 INSTALLATION DATE 2/29/96

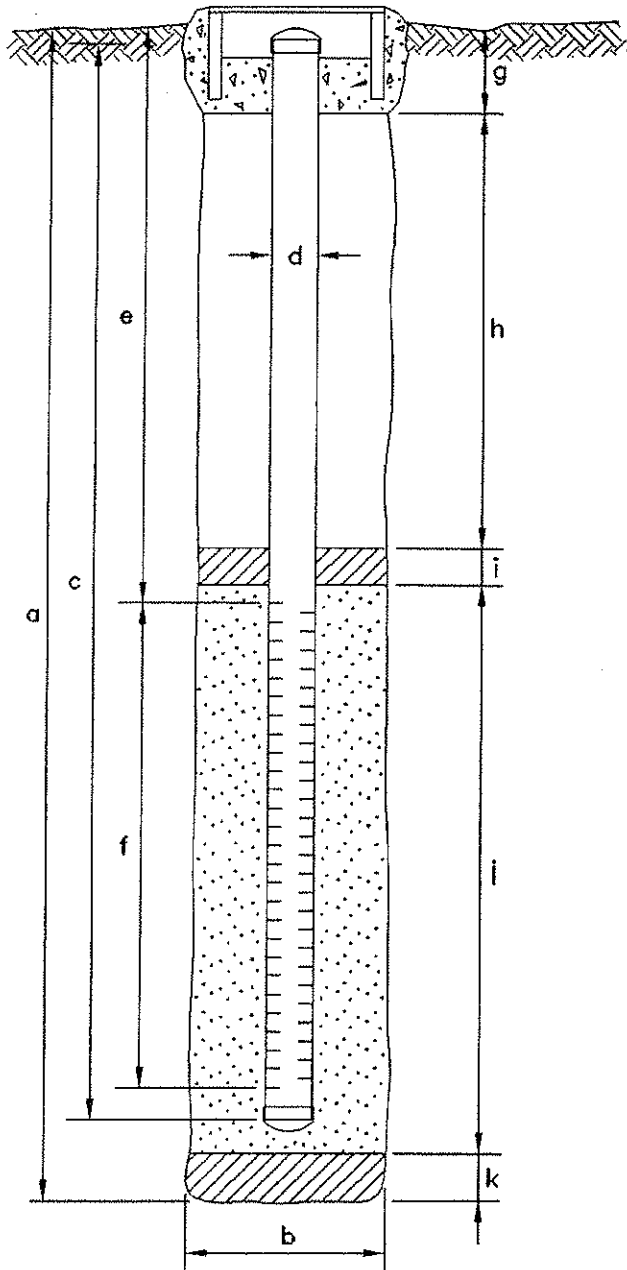

## EXPLORATORY BORING

- a. Total depth 20 ft.  
 b. Diameter 10 in.  
 Drilling method HOLLOW STEM AUGER

## WELL CONSTRUCTION

- c. Total casing length 19.5 ft.  
 Material SCH 40 PVC  
 d. Diameter 4 in.  
 e. Depth to top perforations 5 ft.  
 f. Perforated length 15 ft.  
 Perforated interval from 5 to 20 ft.  
 Perforation type MACHINE SLOTTED  
 Perforation size 0.020 INCH  
 g. Surface seal 0.5 ft.  
 Seal material CONCRETE  
 h. Backfill 3.5 ft.  
 Backfill material CEMENT  
 i. Seal 1.0 ft.  
 Seal material BENTONITE  
 j. Gravel pack 15.0 ft.  
 Pack material #2/12 SAND  
 k. Bottom seal NA ft.  
 Seal material NA

# LOG OF EXPLORATORY BORING

PROJECT NUMBER 20805-127.001

BORING NO. VW-2

PROJECT NAME Arco Service Station #2111, San Leandro, California

PAGE 1 OF 2

BY R. Davis DATE 2/29/96

SURFACE ELEV. 38.99 ft.

PID Reading (ppm)	Sample Recovery (ft./ft.)	Penetration (Blows per 6")	GROUND WATER LEVELS	DEPTH IN FT.	SAMPLES	LITHO-GRAPHIC COLUMN	DESCRIPTION	WELL DETAIL
						ASPHALT. ROADBASE FILL.		
0.4	1.0/1.5	15 22 30		5		FILL: SANDY SILTY CLAY (CL), dark grayish brown (10YR, 3/2).		
						SILTY CLAY (CL), light olive brown (2.5Y, 5/4) with grayish orange mottling; 90% low to medium-plasticity fines; 10% fine to medium-grained sand; hard; damp; no hydrocarbon odor.		
2.2	1.5/1.5	7 8 14		10		@9.5-11': dark grayish brown (10YR, 3/2); damp; no hydrocarbon odor.		
12.0	1.5/1.5	9 14 20				@12-13.5': as above; no hydrocarbon odor.		
74.0	1.2/1.5	7 17 18		15		@14.5-16': olive gray (2.5Y, 5/1); increasing silt content; rootholes present; moist; hydrocarbon odor.		
79.0	--	6 10 17						
159.0	--	6 12 17		20		SANDY CLAY (CL), mottled yellowish brown (10YR, 5/4) to light olive brown (2.5Y, 5/4); 75-80% low to medium-plasticity fines; 15-20% fine to coarse-grained sand; 5% fine gravel; very		

**REMARKS**

Boring drilled to a depth of 20 feet below grade (fbg) by West Hazmat using 10" dia. hollow-stem auger equipment. Boring completed as a 4" dia. PVC vapor extraction well screened from 5 to 20 fbg. Groundwater was encountered at 16 fbg.



**EMCON**

## LOG OF EXPLORATORY BORING

PROJECT NUMBER      20805-127.001

BORING NO.      VW-2

PROJECT NAME      Arco Service Station #2111, San Leandro, California

PAGE      2 OF 2

BY      R. Davis      DATE      2/29/96

SURFACE ELEV.      38.99 ft.

PID Reading (ppm)	Sample Recovery (ft./ft.)	Penetration (Blows per 6")	GROUND WATER LEVELS	DEPTH IN FT.	SAMPLES	LITHO-GRAPHIC COLUMN	DESCRIPTION	WELL DETAIL
				25			stiff; wet; hydrocarbon odor. <b>BORING TERMINATED AT 20 FBG.</b>	
				30				
				35				
				40				



**REMARKS**

Boring drilled to a depth of 20 feet below grade (fbg) by West Hazmat using 10" dia. hollow-stem auger equipment.  
 Boring completed as a 4" dia. PVC vapor extraction well screened from 5 to 20 fbg. Groundwater was encountered at 16 fbg.

**EMCON**

# WELL DETAILS



EMCON

PROJECT NUMBER 20805-127.001  
 PROJECT NAME Arco Station #2111  
 COUNTY San Leandro  
 WELL PERMIT NO. 96126 (ZONE 7)

BORING/WELL NO. VW-3  
 TOP OF CASING ELEV. 38.01  
 GROUND SURFACE ELEV. 38.71  
 DATUM MSL  
 INSTALLATION DATE 2/29/96

## EXPLORATORY BORING

- a. Total depth 20 ft.  
 b. Diameter 10 in.  
 Drilling method HOLLOW STEM AUGER

## WELL CONSTRUCTION

- c. Total casing length 19.5 ft.  
 Material SCH 40 PVC  
 d. Diameter 4 in.  
 e. Depth to top perforations 5 ft.  
 f. Perforated length 15 ft.  
 Perforated interval from 5 to 20 ft.  
 Perforation type MACHINE SLOTTED  
 Perforation size 0.020 INCH  
 g. Surface seal 0.5 ft.  
 Seal material CONCRETE  
 h. Backfill 3.0 ft.  
 Backfill material CEMENT  
 i. Seal 1.5 ft.  
 Seal material BENTONITE  
 j. Gravel pack 15.0 ft.  
 Pack material #2/12 SAND  
 k. Bottom seal NA ft.  
 Seal material NA

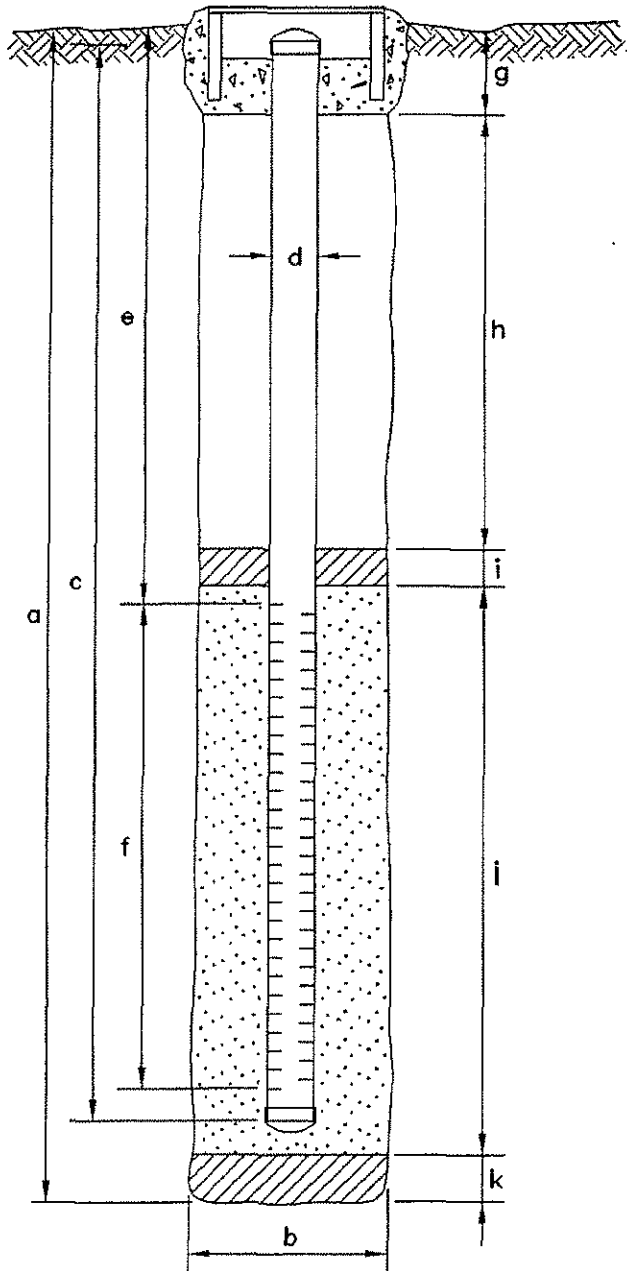

# LOG OF EXPLORATORY BORING

**PROJECT NUMBER** 20805-127.001 **BORING NO.** VW-3  
**PROJECT NAME** Arco Service Station #2111, San Leandro, California **PAGE** 1 OF 1  
**BY** R. Davis **DATE** 2/28/96 **SURFACE ELEV.** 38.71 ft.

PID Reading (ppm)	Sample Recovery (ft./ft.)	Penetration (Blows per 6")	GROUND WATER LEVELS	DEPTH IN FT.	LITHO-GRAPHIC COLUMN	DESCRIPTION	WELL DETAIL
					ASPHALT.		
					FILL MATERIAL.		
5.2	1.5/1.5	7 14 20		5	[Hatched Box]	CLAY (CL), dark grayish brown (10YR, 4/2); 90% medium-plasticity fines; 10% fine-grained sand; rootholes present; iron oxide staining in veins; damp; no hydrocarbon odor.	
6.6	1.5/1.5	7 17 20		10	[Hatched Box]	@9.5-11': very dark grayish brown (10YR, 3/2) with occasional gray and orange-brown (iron oxide) mottling; 90% low to medium-plasticity fines; 10% fine-grained sand; increasing silt content; hard; damp; no hydrocarbon odor.	
15.5	--	8 14 22	▽	15	[Hatched Box]	CLAYEY, SANDY SILT (ML), gray (5Y, 5/1); 80-85% low-plasticity fines; 15-20% fine-grained sand; hard; moist; hydrocarbon odor. @16': wet; hydrocarbon odor.	
2.2	--	6 9 11		20	[Hatched Box]	SILTY SANDY CLAY (CL), mottled yellowish brown (10YR, 5/4) to light olive brown (2.5Y, 5/4); 75-80% low to medium-plasticity fines; 15-20% fine to coarse-grained sand; 5% fine gravel; very stiff; wet; hydrocarbon odor. <b>BORING TERMINATED AT 20 FBG.</b>	



**REMARKS**  
 Boring drilled to a depth of 20 feet below grade (fbg) by West Hazmat using 10" dia. hollow-stem auger equipment.  
 Boring completed as a 4" dia. PVC vapor extraction well screened from 5 to 20 fbg. Groundwater was encountered at 16 fbg.

# WELL DETAILS



EMCON

PROJECT NUMBER 20805-127.001  
 PROJECT NAME Arco Station #2111  
 COUNTY San Leandro  
 WELL PERMIT NO. 96126 (ZONE 7)

BORING/WELL NO. VW-4  
 TOP OF CASING ELEV. 38.38  
 GROUND SURFACE ELEV. 39.23  
 DATUM MSL  
 INSTALLATION DATE 2/28/96

## EXPLORATORY BORING

- a. Total depth 20 ft.
- b. Diameter 10 in.
- Drilling method HOLLOW STEM AUGER

## WELL CONSTRUCTION

- c. Total casing length 19.5 ft.  
Material SCH 40 PVC
- d. Diameter 4 in.
- e. Depth to top perforations 6.5 ft.
- f. Perforated length 13 ft.  
Perforated interval from 6.5 to 19.5 ft.  
Perforation type MACHINE SLOTTED  
Perforation size 0.020 INCH
- g. Surface seal 0.5 ft.  
Seal material CONCRETE
- h. Backfill 4.5 ft.  
Backfill material CEMENT
- i. Seal 1.5 ft.  
Seal material BENTONITE CHIPS
- j. Gravel pack 13.5 ft.  
Pack material #2/12 SAND
- k. Bottom seal NA ft.  
Seal material NA

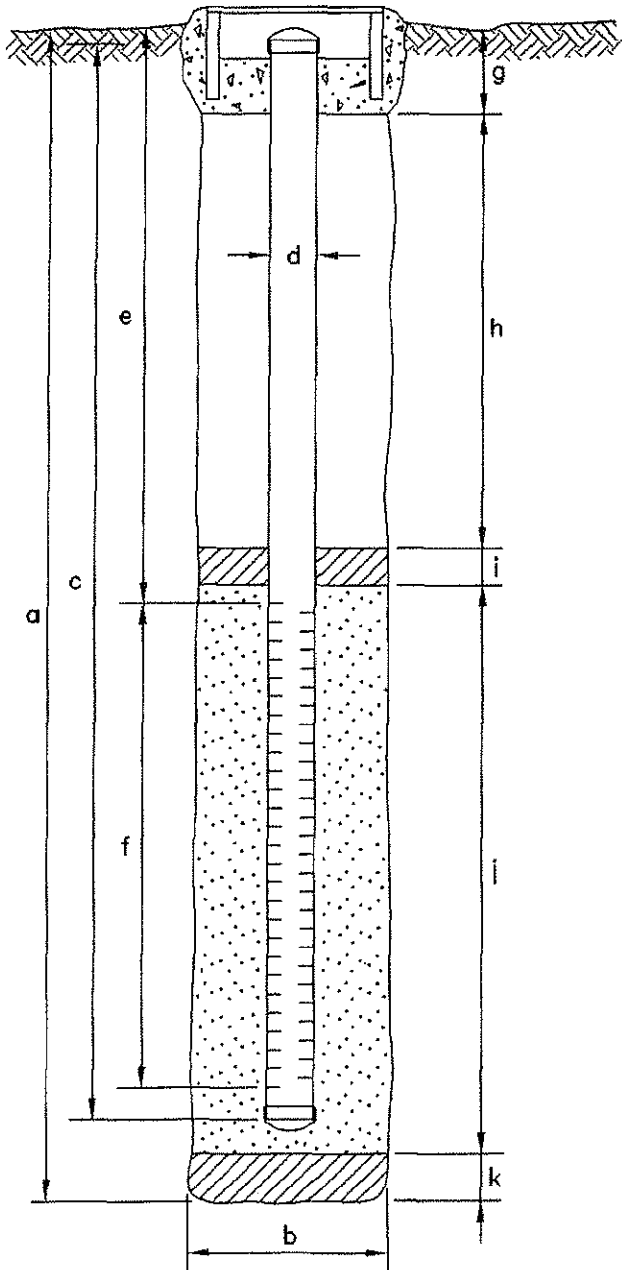



# LOG OF EXPLORATORY BORING

PROJECT NUMBER	20805-127.001	BORING NO.	VW-4
PROJECT NAME	Arco Service Station #2111, San Leandro, California	PAGE	1 OF 1
BY R. Davis	DATE 2/28/96	SURFACE ELEV.	39.23 ft.

PID Reading (ppm)	Sample Recovery (ft./ft.)	Penetration (Blows per 6")	GROUND WATER LEVELS	DEPTH IN FT.	SAMPLES	LITHO-GRAPHIC COLUMN	DESCRIPTION	WELL DETAIL
						ASPHALT. CONCRETE.		
0.5					X	FILL: SANDY CLAY (CL), brown; 70% medium-plasticity fines; 30% fine to coarse-grained sand; damp; no hydrocarbon odor.		
7.0	1.2/1.5	9 15 16		5	█	FILL: SILTY CLAY (CL), very dark gray (5Y, 3/1) with olive (5Y, 4/4) mottling; 95-100% medium-plasticity fines; trace to 5% fine-grained sand; very stiff; damp; hydrocarbon odor.		
23.1	0.8/1.5	22 25 29		10	█	FILL: CLAYEY SAND (SC), dark gray to yellowish brown; 30-40% medium-plasticity fines; 60-70% fine to coarse-grained sand; trace fine gravel; very dense; damp; hydrocarbon odor.		
92.3	1.2/1.5	6 9 15	▽	15	█	CLAYEY SAND (SC), very dark gray (5Y, 3/1); 30-35% medium-plasticity fines; 40-45% fine to coarse-grained sand; 25% fine gravel; medium dense; moist; hydrocarbon odor.  @15.5': wet (moisture in voids).		
281.0	1.5/1.5	9 12 16			█	SILTY CLAY (CL), light olive brown (2.5Y, 5/4); 90-95% low to medium-plasticity fines; trace to 5% fine-grained sand; 5% fine gravel; very stiff; wet; hydrocarbon odor.		
878.0	1.5/1.5	6 7 15			█	BORING TERMINATED AT 20 FBG.		



**REMARKS**  
 Boring drilled to a depth of 20 feet below grade (fbg) by West Hazmat using 10" dia. hollow-stem auger equipment.  
 Boring completed as a 4" dia. PVC vapor extraction well screened from 6.5 to 19.5 fbg. Groundwater was encountered at 15.5 fbg.

# Monitoring Well MW-8

DEPTH IN FEET	SAMPLING		
	TYPE OF SAMPLER	TPHg Concentration	MTBE Concentration
0			
5	S	<1000	6
10	S	<1000	6
15	S	2100	32
	S	150000	<500
20			
	S	<1000	1400
25			
	S	<1000	120
30			
	S	<1000	37
35			

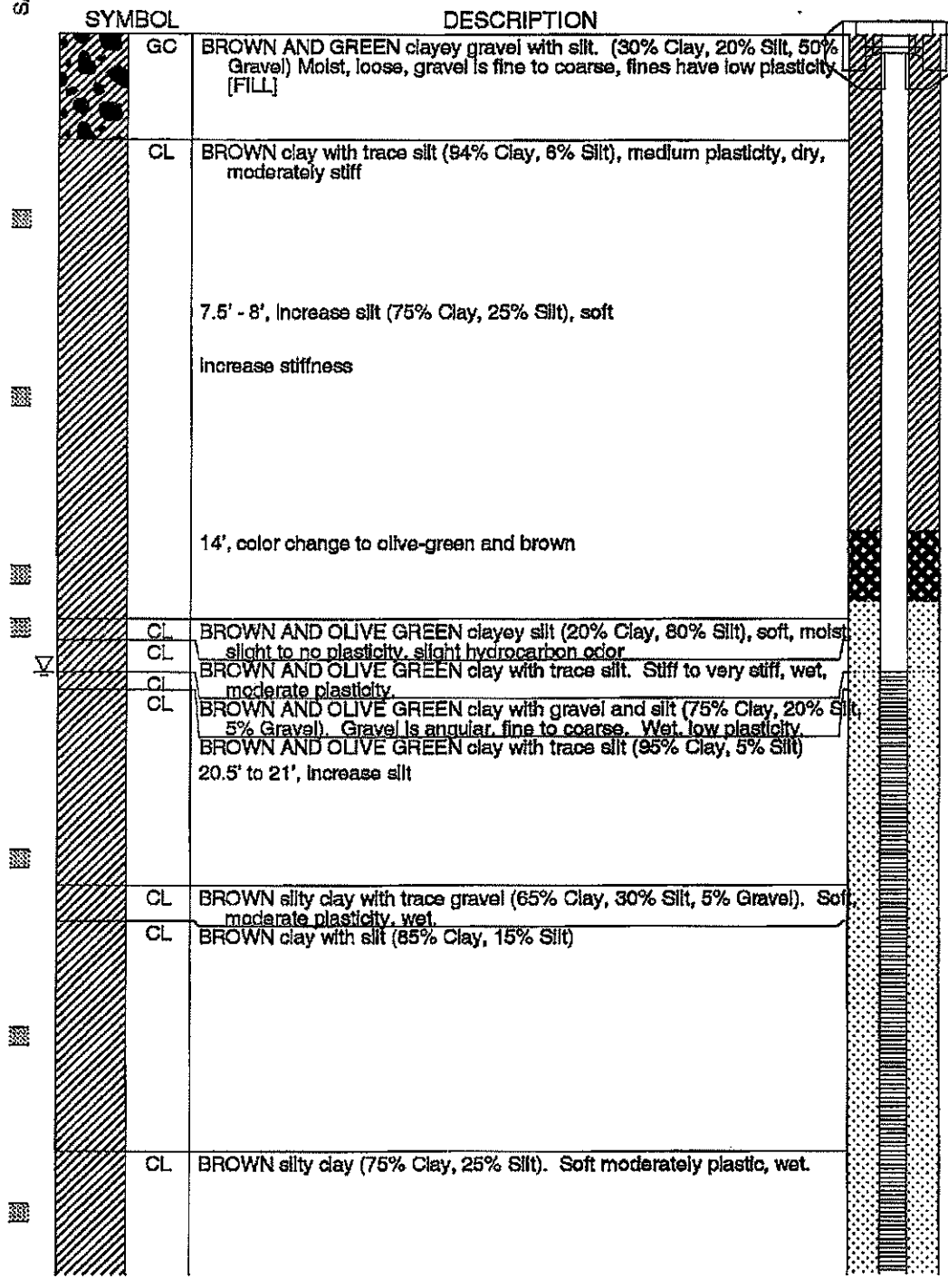

Continued Next Page

Job No: 38486093 Serial No.:	<b>URS</b>	<b>Log of Boring</b>
Date Completed: 11/26/03 Boring Depth: 38.0 ft.	Surface Elev: Coordinates:	Location: San Leandro, CA
Top of Casing Elev: ft. Casing Depth: 38.0 ft.	Casing Type: PVC Casing Diam: 2.0 in.	Screened Interval: 18-38 ft. Effective Interval: 18-38 ft.
		Slot Size: 0.020 in. Sand Pack: 2/12 Lonestar

# Monitoring Well

MW-8

DEPTH IN FEET	SAMPLING	
	TYPE OF SAMPLER	TPHg Concentration MTBE Concentration
35		
	S	<1000 27
40		
45		
50		
55		
60		
65		
70		

SAMPLES

SYMBOL	DESCRIPTION
 CL	BROWN clay with little silt (93% Clay, 7% Silt)

End of Boring at 38'

Note: Well was installed inside existing vault box, adjacent to existing 1" and 2" wells.



1333 Broadway, Suite 800  
Oakland, California 94612

**LOG OF BORING**

Borehole ID: SB-1

Total Depth: 37 feet

PROJECT INFORMATION		DRILLING INFORMATION	
Project: BP - Site #2111		Drilling Company: Gregg Drilling & Testing	
Site Location: 1156 Davis St., San Leandro, CA		Driller: Germaine/Jose	
Project Manager: Scott Robinson		Type of Drilling Rig: DP13 Geoprobe	
RG:		Drilling Method: Direct Push	
Geologist: Christopher Sheridan		Sampling Method: Continuous	
Job Number: 38486896		Date(s) Drilled: 3/20/04 - 3/21/04	

BORING INFORMATION			
Groundwater Depth (ft bgs): 20 feet	Boring Location: Davis St. Community Center parking lot		
Hand Auger Depth (ft bgs): 5.0 feet	Boring Diameter: 2-inch		
Coordinates: X-122.1692944 Y37.7223623	Boring Type: Exploratory		

Depth (ft bgs)	Symbol	Lithologic Description	USCS	PID (ppm)	Recovery	Sample ID / Comments
0		CLAY: DARK BROWN to BROWN silty clay with some gravel (55% clay, 30% silt, 15% gravel). Soft, low plasticity, damp, no odor.	CL	0		Hand auger to 5 feet bgs
2						
4		SILT: BROWN clayey silt (35% clay, 65% silt). Soft, no plasticity, damp.	ML	0		
6						
8		CLAY: DARK BROWN to BROWN silty clay (60% clay, 40% silt). Soft to moderately stiff, low plasticity, damp.	CL	0		
10		SILT: BROWN clayey silt (30% clay, 70% silt).	ML	0		
12		CLAY: DARK BROWN silty clay (65% clay, 35% silt). Moderately stiff, low plasticity, damp.	CL	0		
14		SILT: BROWN silt (100% silt). Soft, no plasticity, moist.	ML	0		
16		SAND: BROWN fine sand with little clay (10% clay, 90% sand). Poorly graded, loose, wet.	SP	0		
18		15', color change to LIGHT BROWN		0		
20		16', trace sand, moist		0		
22		GRAVELLY CLAY: (20.25') grades to..BROWN gravelley clay (70% clay, 30% gravel). Well graded, wet	CL	0		
24		CLAY: BROWN silty clay (70% clay, 35% silt). Moderately stiff, no plasticity, damp.	CL	0		
26		SAND: BROWN fine sand with little clay (10% clay, 90% sand). Poorly graded, loose, saturated.	SP	0		
28		CLAY: BROWN silty clay with trace fine to coarse sand (65% clay, 30% silt, 5% sand). Moderately stiff to stiff, no plasticity, damp to moist.	CL	0		
		slight increased fine to coarse sand. Soft, low plasticity, saturated.		0		

Depth (ft bgs)	Symbol	Lithologic Description	USCS	PID (ppm)	Recovery	Sample ID / Comments
30				0		
32		same silty clay.		0		
34		same silty clay.		0		
36		End of Boring at 37' bgs.		0		



1333 Broadway, Suite 800  
Oakland, California 94612

### LOG OF BORING

Borehole ID: SB-2

Total Depth: 40 feet

PROJECT INFORMATION		DRILLING INFORMATION	
Project: BP - Site #2111		Drilling Company: Gregg Drilling & Testing	
Site Location: 1156 Davis St, San Leandro, CA		Driller: Germaine/Jose	
Project Manager: Scott Robinson		Type of Drilling Rig: DP13 Geoprobe	
RG:		Drilling Method: Direct Push	
Geologist: Christopher Sheridan		Sampling Method: Continuous	
Job Number: 38486896		Date(s) Drilled: 3/21/04	
BORING INFORMATION			
Groundwater Depth (ft bgs): 21		Boring Location: ARCO #2111	
Hand Auger Depth (ft bgs): 5.0		Boring Diameter: 2-inch	
Coordinates: X-122.1686721 Y37.7217975		Boring Type: Exploratory	

Depth (ft bgs)	Symbol	Lithologic Description	USCS	PID (ppm)	Recovery	Sample ID / Comments
0		CLAY: BROWN silty clay with fine to coarse sand and some fine to coarse gravel (35% clay, 25% silt, 25% sand, 15% gravel). Soft, low to no plasticity, damp [FILL].	CL			Hand auger 0 to 5 feet bgs
2						
4						
6		CLAY: DARK BROWN to BROWN silty clay with trace fine to coarse sand (65% clay, 30% silt, 5% sand) Moderately stiff to stiff, low plasticity, damp.	CL	0		
8		same as above		0		
10				0		
12				0		
14		stiff same as above, some hydrocarbon staining and odor.		22		
16		increased staining.		150		
18				120		
20				268		
22		21'-22', soft, wet, hydrocarbon odor. 22.5', stiff		150		
24		GRAVEL: BROWN and OLIVE GRAY sandy gravel with silt (20% silt, 35% sand, 45% gravel). Well graded, moist to wet.	GM	0		
26		26.25' to 27', coarse sand grading to...				
28		GRAVEL: GRAY silty gravel with sand (30% silt, 25% sand, 45% gravel). Well graded, angular to sub-angular, moist to wet.	SMC	0		
		CLAY: BROWN clay with fine to coarse sand and silt (60% clay, 20% silt, 20% sand). Soft, low to moderate plasticity, wet.	CL			
			SW	0		

Depth (ft bgs)	Symbol	Lithologic Description	USCS	PID (ppm)	Recovery	Sample ID / Comments
30		silt, 20% sand). Soft, low to moderate plasticity, wet.	SW			
32		SAND: GRAY sand with gravel. Well graded, subangular, wet (75% sand 25% gravel).	CL	0		
34		CLAY: BROWN clay with fine to coarse sand (75% clay, 25% sand). Soft, moderate plasticity, saturated.	NR			
36		No recovery				
38						
40		GRAVEL: Gravelly sluff from above.	GM	0		End of Boring at 40' bgs at 1410 on 3/21/04



1333 Broadway, Suite 800  
Oakland, California 94612

### LOG OF BORING

Borehole ID: H-1

Total Depth: 40 feet



PROJECT INFORMATION	DRILLING INFORMATION
<b>Project:</b> BP - Site #2111	<b>Drilling Company:</b> Gregg Drilling & Testing
<b>Site Location:</b> 1156 Davis St., San Leandro, CA	<b>Driller:</b> Germaine/Jose
<b>Project Manager:</b> Scott Robinson	<b>Type of Drilling Rig:</b> DP13 Geoprobe
<b>RG:</b>	<b>Drilling Method:</b> Direct Push
<b>Geologist:</b> Christopher Sheridan	<b>Sampling Method:</b> Continuous
<b>Job Number:</b> 38486896	<b>Date(s) Drilled:</b> 3/21/04

### BORING INFORMATION

<b>Groundwater Depth (ft bgs):</b> 24.5	<b>Boring Location:</b> Davis St. Community Center driveway
<b>Hand Auger Depth (ft bgs):</b> 5.0	<b>Boring Diameter:</b> 2-inch
<b>Coordinates:</b> X-122.1688693 Y37.7216522	<b>Boring Type:</b> Exploratory

Depth (ft bgs)	Symbol	Lithologic Description	USCS	PID (ppm)	Recovery	Sample ID / Comments
0						Hand auger to 5' bgs.
2						
4						
6		SILT: BROWN clayey silt with some fine to coarse sand and trace gravel (35% clay, 40% silt, 20% sand, 5% gravel) [FILL].	ML	0		
8		CLAY: DARK BROWN silty clay with little fine to coarse sand (60% clay, 30% silt, 10% sand). Stiff, non plastic, damp, organics.	CL	0		
10				0		
12		No organics. Same as above		0		
14		Stiff		0		
16		Color change to BROWN		0		
18		Soft to moderately stiff, moderate plasticity		0		
20		Slight staining		6.6		
22		Same as above				
24				23		
26						
28		Same silty clay. Wet, slight sheen and hydrocarbon odor.				
		Same as above, saturated.		25		



Depth (ft bgs)	Symbol	Lithologic Description	USCS	PID (ppm)	Recovery	Sample ID / Comments
30 32 34 36 38 40		<p>SAND: BROWN clayey fine grained sand (30% clay, 70% sand). Poorly graded, subangular, saturated.</p> <p>CLAY: BROWN silty clay (70% clay, 30% silt). Soft to moderately stiff, low plasticity, moist, slight odor.</p> <p>Same as above</p> <p>End of Boring at 40' bgs at 1200 on 3/21/04</p>	SM CL	59 103 205 195 150 125		<p>Grab groundwater sample taken at 1200: H-1.</p>



1333 Broadway, Suite 800  
Oakland, California 94612

# LOG OF BORING



Borehole ID: H-2

Total Depth: 36 feet

PROJECT INFORMATION		DRILLING INFORMATION	
Project: BP - Site #2111		Drilling Company: Gregg Drilling & Testing	
Site Location: 1156 Davis St., San Leandro, CA		Driller: Germaine/Jose	
Project Manager: Scott Robinson		Type of Drilling Rig: DP13 Geoprobe	
RG:		Drilling Method: Direct Push	
Geologist: Mike Berwald/Chris Sheridan		Sampling Method: Continuous	
Job Number: 38486896		Date(s) Drilled: 3/21/04	

BORING INFORMATION			
Groundwater Depth (ft bgs): 17 feet	Boring Location: Davis St. Community Center driveway		
Hand Auger Depth (ft bgs): 5.0	Boring Diameter: 2-inch		
Coordinates: X-122.1690083 Y37.7218569	Boring Type: Exploratory		

Depth (ft bgs)	Symbol	Lithologic Description	USCS	PID (ppm)	Recovery	Sample ID / Comments
0		CLAY: DARK BROWN to BROWN clay with silt and fine to coarse gravel (50% clay, 25% silt, 25% gravel). Moderately stiff, low to moderate plasticity, damp.	CL			Hand auger to 5' bgs.
2						
4						
6		Trace silt and fine gravel. Organics, moist.				
8						
10						
12		Same as above, BROWN to GREEN BROWN.				
14				193		
16		Same as above, hydrocarbon odor and stain				
18		SAND: BROWN and OLIVE GRAY sand with fine to coarse gravel and trace silt (5% silt, 70% sand, 25% gravel). Well-graded, gravel is subangular to angular, wet.	SW			
20				70		
22		CLAY: BROWN and OLIVE GRAY silty clay with little fine to coarse sand and trace fine to coarse gravel (55% clay, 30% silt, 10% sand, 5% gravel). Moderately stiff, low plasticity, saturated.	CL			
24						
26		Trace silt, soft, wet, no staining/odor.				
28				130		
				3.3		
		Same as above.		1.1		
				0		

Depth (ft bgs)	Symbol	Lithologic Description	USCS	PID (ppm)	Recovery	Sample ID / Comments
 30 32 34 36		Slight sheen in sluff.  End of Boring at 36' bgs at 1050 on 3/21/04.		0  8.3 44		Grab groundwater sample taken at 1050: H-2



1333 Broadway, Suite 800  
Oakland, California 94612

**LOG OF BORING**

Borehole ID: H-3

Total Depth: 44 feet

PROJECT INFORMATION		DRILLING INFORMATION	
Project: BP - Site #2111		Drilling Company: Gregg Drilling & Testing	
Site Location: 1156 Davis St., San Leandro, CA		Driller: Germaine/Jose	
Project Manager: Scott Robinson		Type of Drilling Rig: DP13 Geoprobe	
RG:		Drilling Method: Direct Push	
Geologist: Christopher Sheridan		Sampling Method: Continuous	
Job Number: 38486896		Date(s) Drilled: 3/21/04	

BORING INFORMATION	
Groundwater Depth (ft bgs): 19 feet	Boring Location: Davis St. Community Center driveway
Hand Auger Depth (ft bgs): 5.0	Boring Diameter: 2-inch
Coordinates: X: -122.1691669 Y: 37.7221031	Boring Type: Exploratory

Depth (ft bgs)	Symbol	Lithologic Description	USCS	PID (ppm)	Recovery	Sample ID
0		SILT: DARK BROWN to BROWN silt with clay and some fine to coarse gravel (25% clay, 60% silt, 15% gravel. Loose, no plasticity, damp [FILL].	ML	0		Hand auger to 5' bgs.
2				0		
4				0		
6		No Recovery				
8						
10		No Recovery				
12		CLAY: DARK BROWN clay with trace silt and trace fine to coarse gravel (90% clay, 5% silt, 5% gravel). Soft, moderate to high plasticity, moist.	CL	0		Σ
14		Same clay				
15.75' - 16.25'		increased silt (65% clay, 30% silt, 5% gravel).				
16		Soft to moderately stiff				
18						
20		Color change to BROWN.				
22		Same as above, saturated.				
24						
26		Same as above.				
28						
30						

Depth (ft bgs)	Symbol	Lithologic Description	USCS	PIID (ppm)	Recovery	Sample ID
32		SAND: BROWN and GRAY clayey sand with little fine to coarse gravel (30% clay, 60% sand, 10% gravel). Well graded, subangular to subrounded sand and gravel, saturated.	SM	0		
34		CLAY: BROWN silty clay with fine to coarse sand (50% clay, 30% silt, 20% sand). Soft, moderate plasticity, wet.	CL	0		
36						
38						
40		SAND: BROWN fine sand (100% sand). Poorly graded.	SP	0		
42		42.5 - 43.5, stuff.				Use hammer past 40' bgs. Boring is stuffing.
44		GRAVEL: BROWN sandy gravel with little silt (10% silt 30% sand, 60% gravel). Well graded.	GM	0		End of Boring at 44' bgs at 0925 on 3/21/04.

Depth (ft bgs)	Symbol	Lithologic Description	USCS	PID (ppm)	Recovery	Sample ID / Comments
30				0		
32		SAND: BROWN and GRAY clayey sand with little fine to coarse gravel (30% clay, 60% sand, 10% gravel). Well graded, subangular to subrounded sand and gravel, saturated.	SC			
34		CLAY: BROWN silty clay with fine to coarse sand (50% clay, 30% silt, 20% sand). Soft, moderate plasticity, wet.	CL	0		
36						
38						
40		SAND: BROWN fine sand (100% sand). Poorly graded.	SP	0		Use hammer past 40' bgs. Boring is sluffing.
42		42.5 - 43.5, sluff.				
44		GRAVEL: BROWN sandy gravel with little silt (10% silt 30% sand, 60% gravel). Well graded.	GW	0		End of Boring at 44' bgs at 0925 on 3/21/04.



1333 Broadway, Suite 800  
Oakland, California 94612

**LOG OF BORING**



Borehole ID: H-4

Total Depth: 35 feet

PROJECT INFORMATION		DRILLING INFORMATION	
Project: BP - Site #2111		Drilling Company: Gregg Drilling & Testing	
Site Location: 1156 Davis St., San Leandro, CA		Driller: Germaine/Jose	
Project Manager: Scott Robinson		Type of Drilling Rig: DP13 Geoprobe	
RG:		Drilling Method: Direct Push	
Geologist: Christopher Sheridan		Sampling Method: Continuous	
Job Number: 38486896		Date(s) Drilled: 3/20/04	

BORING INFORMATION			
Groundwater Depth (ft bgs): 19.5	Boring Location: Davis St. Community Center parking lot		
Hand Auger Depth (ft bgs): 5.0	Boring Diameter: 2-inch		
Coordinates: X-122.1693232 Y37.7223485	Boring Type: Hydropunch		

Depth (ft bgs)	Symbol	Lithologic Description	USCS	PID (ppm)	Recovery	Sample ID / Comments
0		CLAY: DARK BROWN to BROWN silty clay with some gravel (55% clay, 30% silt, 15% gravel). Soft, low plasticity, damp, no odor.				Lithology from SB-1.
2						Hand auger 0' to 5' bgs.
4		SILT: BROWN clayey silt (35% clay, 65% silt). Soft, no plasticity, damp.				
6						
8		CLAY: DARK BROWN to BROWN silty clay (60% clay, 40% silt). Soft to moderately stiff, low plasticity, damp.				
10		SILT: BROWN clayey silt (30% clay, 70% silt).				
12		CLAY: DARK BROWN silty clay (65% clay, 35% silt). Moderately stiff, low plasticity, damp.				
14		SILT: BROWN silt (100% silt). Soft, no plasticity, moist.				
16		SAND: BROWN fine sand with little clay (10% clay, 90% sand). Poorly graded, loose, wet.				Screen 15' - 17' bgs- DRY
18		15:, color change to LIGHT BROWN 16:, trace sand, moist				Screen 19.5' - 20.5' bgs - DRY
20		GRAVELLY CLAY: (20.25') grades to..BROWN gravelly clay (70% clay, 30% gravel). Well graded, wet				Screen 20.5' - 21.5' bgs - DRY
22		CLAY: BROWN silty clay (70% clay, 35% silt). Moderately stiff, no plasticity, damp.				Screen 20' - 24' bgs - DRY
24		SAND: BROWN fine sand with little clay (10% clay, 90% sand). Poorly graded, loose, saturated.				
26		CLAY: BROWN silty clay with trace fine to coarse sand (65% clay, 30% silt, 5% sand). Moderately stiff to stiff, no plasticity, damp to moist.				
28		slight increased fine to coarse sand. Soft, low plasticity, saturated.				H-4-27 sampled at 1145. Screen 23' - 27' bgs.

Depth (ft bgs)	Symbol	Lithologic Description	USCS	PID (ppm)	Recovery	Sample ID / Comments
 30 32 34		same silty clay.  End of Boring at 35' bgs.				H-4-35 sampled at 1155. Screen 32' - 35' bgs.





1333 Broadway, Suite 800  
Oakland, California 94612

### LOG OF BORING

Borehole ID: H-5



Total Depth: 40 feet

PROJECT INFORMATION	DRILLING INFORMATION
Project: BP - Site #2111	Drilling Company: Gregg Drilling & Testing
Site Location: 1156 Davis St., San Leandro, CA	Driller: Germaine/Jose
Project Manager: Scott Robinson	Type of Drilling Rig: DP13 Geoprobe
RG:	Drilling Method: Direct Push
Geologist: Christopher Sheridan	Sampling Method: Continuous
Job Number: 38486896	Date(s) Drilled: 3/20/04 - 3/21/04

#### BORING INFORMATION

Groundwater Depth (ft bgs): 19.5	Boring Location: Davis St. Community Center parking lot
Hand Auger Depth (ft bgs): 5.0	Boring Diameter: 2-inch
Coordinates: X-122.1692432 Y37.7223855	Boring Type: Hydropunch

Depth (ft bgs)	Symbol	Lithologic Description	USCS	PID (ppm)	Recovery	Sample ID / Comments
0		CLAY: DARK BROWN to BROWN silty clay with some gravel (55% clay, 30% silt, 15% gravel). Soft, low plasticity, damp, no odor.	CL			Lithology from SB-1.
2						
4		SILT: BROWN clayey silt (35% clay, 65% silt). Soft, no plasticity, damp.	ML			Hand auger to 5' bgs.
6						
8		CLAY: DARK BROWN to BROWN silty clay (60% clay, 40% silt). Soft to moderately stiff, low plasticity, damp.	CL			
10		SILT: BROWN clayey silt (30% clay, 70% silt).	ML			
12		CLAY: DARK BROWN silty clay (65% clay, 35% silt). Moderately stiff, low plasticity, damp.	ML			
14		SILT: BROWN silt (100% silt). Soft, no plasticity, moist	CL			
16		SAND: BROWN fine sand with little clay (10% clay, 90% sand). Poorly graded, loose, wet.	ML			
18		15', color change to LIGHT BROWN 16', trace sand, moist				Screen 17' - 20' bgs - DRY
20		GRAVELLY CLAY: (20.25') grades to..BROWN gravelley clay (70% clay, 30% gravel). Well graded, wet	SP CL			
22		CLAY: BROWN silty clay (70% clay, 35% silt). Moderately stiff, no plasticity, damp.	SP			
24		SAND: BROWN fine sand with little clay (10% clay, 90% sand). Poorly graded, loose, saturated.	CL			Screen 19' - 23' bgs - DRY
26		CLAY: BROWN silty clay with trace fine to coarse sand (65% clay, 30% silt, 5% sand). Moderately stiff to stiff, no plasticity, damp to moist.				
28		slight increased fine to coarse sand. Soft, low plasticity, saturated.				H-5-27 sampled at 1530, 3/20/04. Screen 25' - 27' bgs.

Depth (ft bgs)	Symbol	Lithologic Description	USCS	PID (ppm)	Recovery	Sample ID / Comments
 30 32 34 36 38		same silty clay.  same silty clay.				H-5-35 sampled at 1540, 3/20/04. Screen 32' - 35' bgs
38 40		Not logged. End of Boring at 40' bgs.				H-5-40 sampled at 0710, 3/21/04. Screen 38' - 40' bgs.

APPENDIX D  
Geologic Cross-Sections

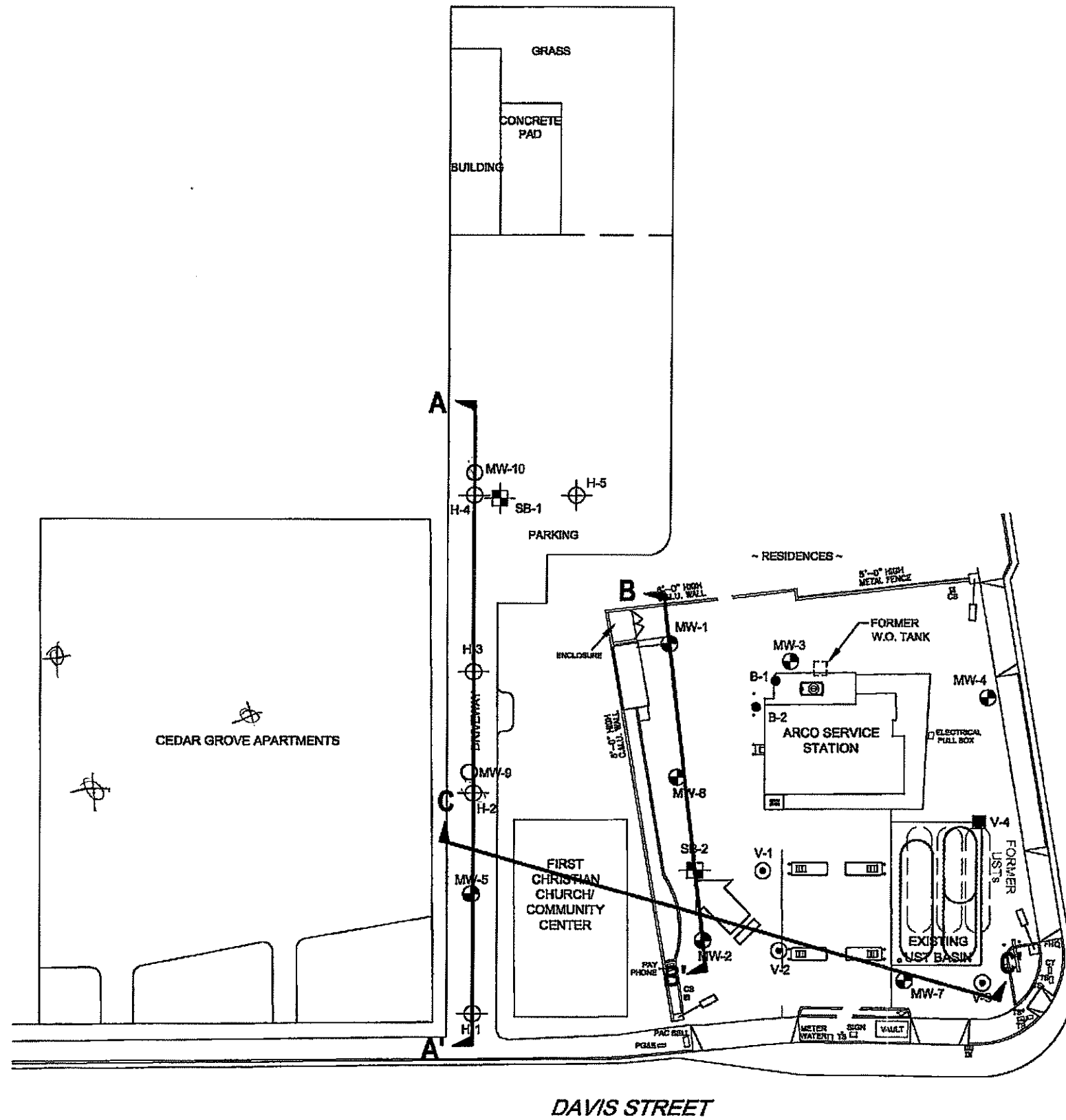

- LEGEND**
- PROPOSED MONITORING WELL LOCATION
  - ⊕ HYDROPUNCH LOCATION
  - ⊕ SOIL BORING LOCATION
  - ⊕ MONITORING WELL
  - ⊕ VAPOR EXTRACTION WELL
  - SOIL BORING
  - DESTROYED WELL
  - ← PREDOMINANT GROUNDWATER FLOW DIRECTION
  - A'—A' GEOLOGICAL CROSS SECTION LINE



NOTE: SITE MAP ADAPTED FROM DELTA ENVIRONMENTAL FIGURES. SITE DIMENSIONS AND FACILITY LOCATIONS NOT VERIFIED.

July 04, 2004 - 11:30am  
 Z:\csm\csm\1156 Davis Street\1156 Davis Street\1156 Davis Street.dwg

<b>URS</b>	Project No. 38486896	<b>SITE PLAN</b>	FIGURE <b>1</b>
	Arco Service Station #2111 1156 Davis Street San Leandro, California		







APPENDIX E

Field Methods



## **QUALITY ASSURANCE/QUALITY CONTROL FIELD METHODS –SOIL BORINGS**

Field methods discussed herein were implemented to provide for accuracy and reliability of field activities, data collection, sample collection, and handling. Discussion of these methods is provided below.

### **1.0 Soil Borings**

The following section describes the procedures for and equipment for advancing soil borings and collecting soil and groundwater samples for site investigation activities.

#### **1.1 Soil Boring Advancement**

The following section describes the procedures for advancing soil borings and collecting soil samples for site investigation activities. As soil boring may be advanced for one or more of the following:

- Soil sampling;
- Groundwater sampling;
- Soil lithologic logging and/or;
- In advance of well installation.

Soil sampling in advance of well installation is not covered in these field methods, since well installation activities are not planned during the current investigation. The following sections describe the various soil boring methods.

##### **1.1.1 Direct-Push Borings**

A direct-push rig is a compact, rubber track or truck mounted soil and groundwater recovery system. The direct-push system utilizes static force and hydraulically powered percussion to advance sampling tools into the soil minimizing disturbance to the ground surface, providing only a small diameter hole, and generating little to no cuttings. Samples are typically recovered at depth intervals of four to five feet.

Soil recovery from the direct-push sampling system consists of a hollow sample tube with a retractable drive point. The drive point is connected to a narrow piston rod that runs the length of the sample tube which is attached to a stop pin at the up-hole of the end tool. The tool is advanced to the desired depth, at which time the operator extends uses extension rods to lowered through the drive rods to unscrew the drive point-piston rod assemblage. The drive point may be drawn back a small distance to create a slight vacuum, thereby increasing sample recovery rates. With the drive-point loosened, the tool is then driven by the cutting shoe, a sharpened end on the edge of the open sample tube. The tube is advanced to the required depth to fill the open sample tube with unconsolidated material. When full, the entire assemblage is brought to the surface.

A dual-tube system consists of an outer drive casing and inner drive rods. The rods can be attached to either a drive point or a barrel sample with liners. In the drive point mode the tool is driven to the desired sampling depth where the drive point is withdrawn and replaced with the barrel sampler. The outer casing and sampler are then driven the length of the sample tube (three to five feet depending upon the equipment) at which point the sample tube is withdrawn. Continuous sampling can be carried out quickly using multiple samplers.

Any soil samples collected by direct-push will use the following procedure:

- The sampling location will be accessed by the direct-push rig and the drive hammer will be positioned to bore vertical holes;
- The drive rods will be equipped the inner sample sleeves to collect soil from the desired depths;
- The sampler will be driven into the ground using percussion;
- The desired sampling depth will be achieved by adding a series of drive rods;
- Soil will collect and compact in the sampling sleeve as the drive rods are advanced. Sand catcher devices will be fastened to sampling sleeves to retain loose soil, if necessary; and
- The soil sampling sleeves containing the desired samples will be retracted from the borehole.

Soil samples will be collected in a systematic approach, where there is a corresponding executing photoionization detector (PID) sample collected and value noted for each collected soil sample. The PID values are used to help determine which of the collected samples will be submitted to the laboratory for analytical analyses. In this approach, some of the soil samples collected will not be sent to the laboratory for analysis, but are collected and stored on ice until the hold time has expired.

#### 1.1.2 Cone Penetration Test (CPT) Borings

The cone penetration test (CPT) is a direct-push, in-situ testing method used to determine the geotechnical properties of soil and to delineate soil stratigraphy. The test method consists of pushing and instrumented cone tip first into the ground at a controlled rate (usually 2 centimeters per second). The resolution of the CPT in delineating stratigraphic layers is related to the size of the cone tip.

Metal rods equipped with a cone penetrometer (cone) are advanced into the subsurface. The parameters measure by the cone will be tip friction, sleeve friction, and pore pressure. The CPT will measure these in real time with depth, allowing for a vertical soil profile to be created based on these measurements. A log of these measurements will be continuously recorded by the subcontractor, and will be used to create a soil-type log.

Depth to groundwater measurements can be calculated using CPT technology using a pore dissipation test (PDT). A PDT is conducted when the cone is halted at specific intervals. The variation of the penetration pore pressure with time is measured behind the tip of the cone. These logs are created by the CPT subcontractor.

Soil samples are collected at depths specified by Broadbent, based on site-specific data and the soil-type log generated by the CPT activities. In a separate hole, the soil sampler is attached to drive rods and pushed, closed-ended, to the desired sampling depth and the drive rod is retracted a short distance to expose a small-diameter open-ended stainless steel sampling tube. The sample tube is then pushed to obtain the soil sample. The complete tube and push rod are retracted to the ground surface where the sample is retrieved. Additional soil samples can be collected by duplicating the soil sampling procedure at a greater depth in the same sample hole.

## 1.2 Grab-Groundwater Sampling

Groundwater samples from boreholes are collected using a Hydropunch™-type groundwater sampler. This type of sampler can be attached to rods for direct-push or CPT borings. This method uses the push or drive tool to reach the desired sampling depth. The sampler has a drive point, perforated section for sample intake, a chamber, and an adaptor for attachment to the drilling rod. As the unit is pushed through the soil, the sample intake tube is retained in the sample chamber, which prevents contaminated soil or groundwater from entering. When the desired sampling depth is reached, the sample chamber is withdrawn approximately 1.5 feet. The drive tip is held in place by soil friction. As the sample chamber is retracted, the drive tip pulls the perforated intake from inside the chamber and exposes it to the desired groundwater sampling interval. A small diameter plastic bailer is then advanced through the push rods to retrieve the water sample. Samples are then decanted into laboratory-supplied containers.

## 2.0 Decontamination

Reusable sampling equipment is cleaned using a solution of Alconox or other acceptable detergent, rinsed with tap water, and finally rinsed with distilled water prior to use in each well. Decontamination water is stored on-site in labeled steel drum(s) or other appropriate container(s) prior to disposal.

## 3.0 Sample Containers, Labeling, and Storage

Samples are collected in laboratory prepared containers with appropriate preservative (if preservative was required). Samples are properly labeled (site name, sample I.D., sampler initials, date, and time of collection) and stored chilled (refrigerator or ice chest with ice) until delivery to a certified laboratory, under chain of custody procedures.

## 4.0 Chain of Custody Record and Procedure

The field sampler is personally responsible for care and custody of the samples collected until they are properly transferred to another party. To document custody and transfer of samples, a Chain of Custody Record is prepared. The Chain of Custody Record provided identification of the samples corresponding to sample labels and specified analyses to be performed by the laboratory. The original Chain of Custody Record accompanies the shipment, and a copy of the record is stored in the project file. When the samples are transferred, the individual relinquishing and receiving the samples signs, dates, and notes the time of transfer on the record.

## 5.0 Field Records

Daily Report and data forms are completed by staff personnel to provide daily record of significant events, observations, and measurements. Field records are signed, dated, and stored in the project file.