



**ENVIRONMENTAL ENGINEERING, INC.**  
6620 Owens Drive, Suite A • Pleasanton, CA 94588  
TEL (925)734-6400 • FAX (925)734-6401  
www.somaenv.com

October 10, 2016

**RECEIVED**

By Alameda County Environmental Health 3:34 pm, Oct 14, 2016

Mr. Mark Detterman, PG, CEG  
Alameda County Health Care Services Agency  
1131 Harbor Bay Parkway, Suite 250  
Alameda, California 94502-6577

Subject: Freedom Food and Gas (Formerly Freedom ARCO Mini-Mart)  
Site Address: 15101 Freedom Avenue, San Leandro, California  
**STID 4473/RO0000473**

Dear Mr. Detterman:

SOMA's "Third Quarter 2016 Groundwater Monitoring and Remediation Progress Report" for the subject property has been uploaded to the State's GeoTracker database and Alameda County's FTP site for your review.

Thank you for your time in reviewing our report. Please do not hesitate to call me at (925) 734-6400, if you have questions or comments.

Sincerely,

Mansour Sepehr, Ph.D., PE  
Principal Hydrogeologist



cc: Mr. Mohammad Pazdel w/report enclosure

**Third Quarter 2016  
Groundwater Monitoring and  
Remediation Progress Report**

**Freedom Food and Gas  
15101 Freedom Avenue  
San Leandro, California**

**October 10, 2016**

**Project 2551/2553**

**Prepared for**

**Mr. Mohammad Pazdel  
1770 Pistacia Court  
Fairfield, California**



**ENVIRONMENTAL ENGINEERING, INC.**

6620 Owens Drive Suite A Pleasanton CA 94588 Ph: 925.734.6400 F: 925.734-6401 [www.somaenv.com](http://www.somaenv.com)

## PERJURY STATEMENT

Site Location: 15101 Freedom Avenue, San Leandro, California

"I declare under penalty of perjury, that the information and/or recommendations contained in the attached document or report is true and correct to the best of my knowledge".

A handwritten signature in cursive script that reads "M. Pazdel". The signature is written in black ink and is positioned above a horizontal line.

Mohammad Pazdel  
1770 Pistacia Court  
Fairfield, California 94533  
Responsible Party.

## CERTIFICATION

SOMA Environmental Engineering, Inc. has prepared this report on behalf of the responsible party, Mr. Mohammad Pazdel, for property located at 15101 Freedom Avenue, San Leandro, California, to comply with Alameda County Health Care Services requirements for the Third Quarter 2016 groundwater monitoring event.



---

Mansour Sepehr, PhD, PE  
Principal Hydrogeologist



# TABLE OF CONTENTS

CERTIFICATION .....	i
TABLE OF CONTENTS.....	ii
LIST OF FIGURES .....	iii
LIST OF TABLES.....	iii
LIST OF APPENDICES .....	iv
1. INTRODUCTION .....	1
1.1 Field Activities.....	1
1.2 Laboratory Analysis .....	2
2. RESULTS .....	2
2.1 Field Measurements, First WBZ Wells.....	2
2.2 Laboratory Analysis, First WBZ Wells.....	2
3. OPERATION OF TREATMENT SYSTEM.....	4
4. MULTI-PHASE EXTRACTION EVENTS .....	5
4.1 Soil Vapor Sampling and Analysis.....	6
4.2 Extraction Summary .....	7
4.3 Evaluation of Mass Removal Rate.....	7
5. CONCLUSIONS AND RECOMMENDATIONS.....	8
6. REPORT LIMITATIONS .....	8

## **LIST OF FIGURES**

- Figure 1: Site vicinity map
- Figure 2: Site Map Showing Locations of USTs, Fuel Dispensers, Soil Borings, Vapor Samples, and Groundwater Monitoring Wells
- Figure 3: Groundwater Elevation Contour Map in Feet, First WBZ, September 21, 2016
- Figure 4: Contour Map of TPH-g Concentrations in Groundwater, First WBZ, September 21, 2016
- Figure 5: Contour Map of Benzene Concentrations in Groundwater, First WBZ, September 21, 2016
- Figure 6: Contour Map of MtBE Concentrations in Groundwater, First WBZ, September 21, 2016
- Figure 7: Contour Map of TBA Concentrations and map of TAME and ETBE Concentrations in Groundwater, First WBZ, September 21, 2016
- Figure 8: Schematic Diagram of Groundwater Remediation System
- Figure 9: Cumulative Mass of VOCs Removed

## **LIST OF TABLES**

- Table 1: Historical Groundwater Elevation Data and Analytical Results
- Table 2: Historical Gasoline Oxygenates Results
- Table 3: Effluent Chemical Analytical Results and Operational History of Remediation System
- Table 4: Cumulative Masses of Petroleum Hydrocarbons Removed from the Groundwater Since Installation of the Treatment System
- Table 5: MPE Operational data August 2015
- Table 6: MPE Extraction Data and VOC Mass Removal rate
- Table 7: SVE Abatement and System Emissions

## **LIST OF APPENDICES**

- Appendix A: Standard Operating Procedures for Conducting Groundwater Monitoring Activities
- Appendix B: Elevations and Coordinates on Monitoring Wells, Field Measurements of Physical and Chemical Parameters of Groundwater Samples, and Groundwater Gradient Calculations
- Appendix C: Laboratory Reports and Chain of Custody Forms for the Third Quarter 2016 Monitoring Event and Post-MPE Sampling Event
- Appendix D: Laboratory Reports and Chain of Custody Forms for the Treatment System
- Appendix E: MPE Event Field Data Sheets and Encroachment Permit
- Appendix F: Laboratory Reports and Chain of Custody Forms for the MPE Event

# 1. INTRODUCTION

SOMA Environmental Engineering, Inc. (SOMA) has prepared this report on behalf of the responsible party, Mr. Mohammad Pazdel, for property located at 15101 Freedom Avenue, San Leandro, California. The site is located in an area of primarily residential properties and adjacent commercial areas (Figure 1). The property was formerly owned by Mr. Mohammad Pazdel. In late 2009, the property was sold to DDH, LLC, Assignee and in early 2010 it was sold to Mr. Mohammad Mashhoon. Under the new management, the site is currently operational with the business name “Freedom Food and Gas” (formerly “Freedom Arco Mini-Mart”).

This report summarizes results of the Third Quarter 2016 groundwater monitoring event conducted on September 21, 2016. It includes physical and chemical properties measured in the field and laboratory analysis results for each groundwater sample. It also presents the remediation progress report for Third Quarter 2016, which includes a summary of multi-phase extraction event and a status update of groundwater extraction and treatment system.

## 1.1 Field Activities

In September 2016, SOMA’s field crew conducted a groundwater monitoring event in accordance with procedures and guidelines of Alameda County Health Care Services (ACHCS) and the California Regional Water Quality Control Board (CRWQCB). Figure 2 shows well locations.

On September 21, 2016, the following wells were measured for depth to groundwater: five on-site monitoring wells (MW-1 to MW-5) and four off-site wells (MW-6, MW-7, MW-10 and MW-11) in the First water-bearing zone (WBZ); one extraction well (EX-1), and two MPE wells (MPE-1 and MPE-2). Additional field measurements and groundwater samples were collected from all First WBZ monitoring and remediation wells except EX-2. No sample could be retrieved from EX-2 due to the presence of a downhole pump inside the well. Free product (FP) was not observed in any well during this monitoring event. Properties measured include pH, temperature, and electrical conductivity (EC).

Groundwater monitoring of Second WBZ has been discontinued based on ACEH’s directive dated October 28, 2015. Therefore, MW-1D, MW-3D, and MW-4D were not measured for depth to water or sampled during this monitoring event.

A natural attenuation study was conducted during this event to determine whether petroleum hydrocarbons in groundwater are biodegrading. Dissolved oxygen (DO) and oxidation reduction potential (ORP) measurements were taken for all monitoring and MPE wells.



## 1.2 Laboratory Analysis

Curtis & Tompkins Laboratories, a California state-certified laboratory, analyzed groundwater samples for the following: total petroleum hydrocarbons as gasoline (TPH-g); benzene, toluene, ethylbenzene, total xylenes (collectively termed BTEX); methyl tertiary-butyl ether (MtBE); and gasoline oxygenates, ethanol and lead scavengers. Samples were prepared using EPA Method 5030B and analyzed using EPA Method 8260B.

## 2. RESULTS

Following are results of field measurements and laboratory analysis for the Third Quarter 2016 groundwater monitoring event.

### 2.1 Field Measurements, First WBZ Wells

Table 1 presents calculated groundwater elevations and depths to groundwater for each monitoring well. Depths to groundwater ranged from 14.05 feet in MW-11 to 23.53 feet in MW-1. As mentioned above in Section 1.1, no FP was observed in any First WBZ well. Appendix A includes the procedure for FP measurement.

Corresponding groundwater elevations ranged from 28.25 feet in MW-6 to 30.93 feet in MW-1 (Table 1).

Figure 3 displays the contour map of groundwater elevations. As illustrated, groundwater flows southwesterly, at a gradient of 0.008 feet/feet. No capture zone can be seen in the figure because the downhole pumps in the extraction wells (EX-1 and EX-2) has not been operating based on comments received from the UST Cleanup Fund. Groundwater gradient calculations are attached in Appendix B.

Field measurements recorded during this monitoring event are included in Appendix B.

### 2.2 Laboratory Analysis, First WBZ Wells

Appendix C includes the laboratory report and chain-of-custody form for this monitoring event.

Table 1 presents TPH-g, BTEX, and MtBE analysis results for the current and historical groundwater monitoring events.

TPH-g concentrations ranged from 75 µg/L in MW-11 to 12,000 µg/L in MW-3 and MPE-2. Since the previous monitoring event (Second Quarter 2016), TPH-g has increased in MW-1 through MW-5, MW-10R, EX-1, and MPE-1 and decreased in MW-6, MW-7, MW-11, and MPE-2.

Figure 4 displays the contour map of TPH-g concentrations in groundwater. As illustrated, the highest TPH-g impact is observed in the northeast section of the site in the vicinity of MW-3 and MPE-2.

The following BTEX concentrations were observed:

- Benzene was below laboratory-reporting limits in MW-2 and MW-11. Detectable benzene concentrations ranged from 0.73 µg/L in MW-5 to 630 µg/L in MPE-2.
- Toluene was detected in MW-1 and MW-7 at 0.57 µg/L and 0.63 µg/L, respectively and was below laboratory-reporting limits in all other wells.
- Ethylbenzene was below laboratory-reporting limits in MW-2 and MW-5 and was detected in concentrations ranging from 1.5 µg/L in MW-11 to 340 µg/L in MW-10R.
- Total xylenes were below laboratory-reporting limits in MW-2, MW-5, and MW-6. Detectable concentrations ranged from 0.62 µg/L in MW-1 to 432 µg/L in MW-10R.

Figure 5 displays the contour map of benzene in groundwater. The highest benzene impact is in the northeast corner of the site in the vicinity of MPE-2. Since the previous monitoring event (Second Quarter 2016), detectable benzene concentrations have increased in MW-1, MW-3, MW-4, MW-5, MW-7, MPE-1, and MPE-2 and decreased in MW-6 and EX-1.

MtBE was below the laboratory-reporting limit in MW-1, MW-2, MW-3, MW-6, MW-7, MW-10R, MW-11, EX-1 and MPE-2. Detectable MtBE ranged from 1.5 µg/L in MPE-1 to 35 µg/L in MW-4. Figure 6 displays the contour map of MtBE concentrations in groundwater. Since the previous monitoring event (Second Quarter 2016), MtBE has increased in MW-4, MW-5 and MPE-1, decreased in MW-1, MW-7, and MPE-2, and remained below laboratory-reporting limit in MW-2, MW-6, MW-10R, MW-11, and EX-1.

MW-3, MPE-1, and MPE-2 are the more impacted on-site wells where free-product has been observed in the past and MW-6 and MW-10R are the more impacted off-site wells. As shown in Table 1, since the previous monitoring event (Second Quarter 2016), detectable concentrations of TPH-g have MW-3 and MPE-1 and decreased in MW-6, MW-10R, and MPE-2; benzene has increased in MW-3, MPE-1, and MPE-2 and decreased in MW-6.

Since the reconstruction of MW-10R in April 2016, an MPE event was conducted (August 2016) utilizing this well. Consequently, TPH-g, ethylbenzene and total

xylenes have decreased significantly in this well. Laboratory report and chain-of-custody form are attached in Appendix C.

Table 2 shows analysis results for gasoline oxygenate and lead scavenger concentrations for the current as well as historical events.

The following gasoline oxygenate and lead scavenger concentrations were observed:

- In MW-2, MW-6, MW-7, MW-11, and EX-1 all gasoline oxygenates and lead scavengers were below laboratory-reporting limits.
- tertiary-butyl alcohol (TBA) was detected at concentrations ranging from 17 µg/L in MW-1 to 210 µg/L in MPE-2. Figure 7 shows the contour map of TBA concentrations in First WBZ wells. Since the previous monitoring event (Second Quarter 2016), TBA increased in MW-1, MW-3, and MPE-2 and decreased in MW-4. No comparison could be made for MW-10R due to high reporting limit and dilution during the previous monitoring event in June 2016.
- Methyl tertiary-amyl ether (TAME) was detected in MW-4, MW-5, and MPE-1 at 4.70 µg/L, 0.94 µg/L, and 1.10 µg/L, respectively and was below laboratory-reporting limit in other wells. Figure 7 shows the map of TAME concentrations in First WBZ wells. Since the previous monitoring event (Second Quarter 2016), TAME slightly increased in MW-4, MW-5, and MPE-1.
- Ethyl tertiary-butyl ether (ETBE) was detected in MW-4 at 2.0 µg/L and was below laboratory-reporting limit in other wells. Figure 7 shows the map of ETBE concentrations in First WBZ wells. Since the previous monitoring event (Second Quarter 2016), ETBE slightly decreased in MW-4.
- 1,2-dichloroethane (1,2-DCA), Isopropyl ether (DIPE), 1,2-dibromoethane (EDB), and ethanol were below laboratory-reporting limits in all groundwater samples. Analysis results for ethanol are shown in Appendix C.

### **3. OPERATION OF TREATMENT SYSTEM**

SOMA installed a groundwater treatment system at the site in December 2009. The system includes two extraction wells (EX-1 and EX-2), trenching containing influent and effluent lines and electrical conduits, and the treatment system compound. During system operation, extracted groundwater is pumped from extraction wells through underground piping to a fenced treatment compound, adjacent to the existing service station building.

In the treatment compound, groundwater is treated using granular activated carbon (GAC) and subsequently discharged to the sanitary sewer. Two GAC vessels are connected in series. The first unit (1,000 gallons) serves as the primary treatment unit, and the second (55 gallons) polishing drum provides an additional safety buffer prior to discharge. Effectiveness of the GAC units is monitored by collection and analysis of samples from the system discharge, including a sample collected from water that has passed only through the first GAC unit. When analytical results indicate that the first GAC unit is no longer effectively treating groundwater, the vessel will be removed from the treatment line and refurbished with new carbon. The polishing unit was replaced on June 16, 2014.

Since the system began discharging, approximately 3,973,478 gallons of groundwater have been treated and discharged at the site (as of September 22, 2016). Since March 7, 2016, the treatment system has not been operating actively. The treatment system was turned on on August 5, 2016 to process the water generated during the MPE event only and again on September 22, 2016 to process the purge water generated during this monitoring event. Both these times the extraction wells (EX-1 and EX-2) remained inoperative.

The treatment system operates under discharge permit issued by Oro Loma Sanitary District (OLSD) in May 2009. This discharge permit was most recently renewed in May 2014. Treated groundwater has been discharging to the OLSD sewer since December 9, 2009. Figure 8 shows the schematic diagram of the groundwater treatment system. Treatment system effluent is sampled each month of operation to comply with OLSD discharge permit requirements. Table 3 includes analytical results and operational history of the treatment system. As shown in Table 4, as of August 4, 2016, cumulative masses of TPH-g and BTEX extracted from groundwater were approximately 40.57 pounds, 1.52 pounds, 0.37 pounds, 1.00 pounds, and 5.17 pounds, respectively. As mentioned previously, the treatment system operated for a very short time during August and again in September 2016 to process the groundwater generated during the MPE and groundwater monitoring events. Therefore, effluent samples were collected once each month for discharge permit compliance. Appendix D includes the laboratory reports.

#### **4. MULTI-PHASE EXTRACTION EVENTS**

An MPE event was performed during the Third Quarter 2016 from August 2, through 5, 2016 utilizing reconstructed off-site well MW-10R. SOMA contacted the Alameda County Public Works Agency (ACPWA) to obtain encroachment permit so that groundwater from the extraction wells could be delivered to the onsite treatment system through hoses running across the street under traffic rated ramps. However, after several requests and discussions over the phone & email, the agency did not approve SOMA's proposal. Therefore, extracted

groundwater had to be contained on-site in a container and manually delivered to the site periodically. In addition, the MTS had to be parked in the median along Fairmont Drive since the ACPWA did not approve using traffic ramps. Appendix E includes the encroachment permit to park the truck in the median.

The MPE operation was performed using a self-contained mobile treatment system (MTS), equipped with an electrical generator, propane tank, liquid ring vacuum pump rated at 25-horsepower and 428-actual cubic feet per minute (acfm), electrical submersible pumps, air/water separator vessel, discharge hoses and traffic-rated hose ramps, downhole stingers, and a thermal oxidizer for vapor abatement. The oxidizer operates under a valid various locations BAAQMD permit. Both soil vapor and groundwater were extracted from the subsurface. Extracted groundwater was stored in 300 gallon tanks and then off-hauled to the site for pre-treatment purposes.

Physical and chemical parameters including applied vacuum, soil vapor extraction flow rates, oxidizer temperature, volume of groundwater extracted, VOC concentrations, and depth to groundwater in observation wells, were monitored, measured and recorded. VOC concentrations in the extracted soil vapor stream were continuously monitored using a photoionization detector (PID) calibrated to hexane. MPE operational data is presented in Table 5. Extraction data is presented in Table 6. Field data sheets are presented in Appendix E.

During this event a total of 711 gallons of groundwater was extracted, treated and discharged into the sanitary sewer system. The estimated groundwater extraction rate for the MPE event based on gallons extracted and elapsed time (Table 5) was 0.34 gpm.

#### **4.1 Soil Vapor Sampling and Analysis**

Representative samples were analyzed from the stack of the thermal oxidizer (effluent) to show compliance with the Bay Area Air Quality Management District (BAAQMD) permit. Influent soil vapor samples were collected through a sampling port located on the vacuum pump discharge manifold. Thermal oxidizer stack vapor samples were collected through a sampling port located at the top of the stack. The air samples were submitted under chain-of-custody documentation to Torrent Laboratory, Inc. and analyzed for TPH-g, BTEX, and MtBE using USEPA Analytical Method TO-15. Soil vapor analytical results and abatement efficiencies are presented in Table 7. Certified laboratory analytical reports and chain-of-custody documentation are included in Appendix F.

Soil vapor samples (one influent and one effluent) were collected on August 2, 2016, within the first 24 hours of operation (Table 7) as required by the BAAQMD permit.

## 4.2 Extraction Summary

The MPE event ran from 10:30 AM on August 2, 2016 to 3:00 PM on August 5, 2016. The total extraction time was 2,085 minutes or 34.75 hours.

Applied vacuum ranged from 25.5 to 26.4 inches of mercury, and vapor extraction flow rate ranged from 47 to 62 scfm (Tables 5 and 6). VOC concentrations in the extracted soil vapor stream ranged from 914 parts per million vapor (ppmv) as hexane to 2,405 ppmv (Table 5). During this MPE event, approximately 711 gallons of groundwater mixed with free product was removed.

## 4.3 Evaluation of Mass Removal Rate

The total number of the MPE operational days was 1.45 days. The estimated mass of volatile organic compounds (VOCs) removed from soil vapor extraction and VOC mass removal rate was 47 lbs at 32.6 lbs/day (Table 6).

The overall estimated total mass of VOCs extracted by previous and the current MPE events is 3,629 pounds. This includes the following:

Event	Mass Removed (pounds)
November 2007 (Pilot Test)	106
October 2009	243
November 2009	72
December 2009	97
February 2010	17
March 2010	11
June 2010	30
August 2010	30
October 2010	79
April 2011	27
August 2011	94
May 2013	300
August 2013	841
October 2013	790
September 2014	565
November 2015	280
August 2016	47

Figure 9 shows the cumulative extracted mass of VOCs during different MPE events at the site. A post-MPE groundwater sample was obtained from the remediation well MW-10R to evaluate the performance of MPE event. Laboratory report and chain-of-custody form are attached in Appendix C.

## 5. CONCLUSIONS AND RECOMMENDATIONS

Third Quarter 2016 groundwater monitoring and MPE events results are summarized below.

- No FP was observed during this monitoring event.
- Groundwater flows southwesterly across the site in First WBZ. The downhole pumps in the extraction wells (EX-1 and EX-2) have been offline since March 7, 2016 based on comments received from the UST Cleanup Fund.
- The highest TPH-g and benzene concentrations were observed in the northeast section of the site in the vicinity of MW-3 and MPE-2.
- Since the previous monitoring event (Second Quarter 2016), TPH-g has increased in MW-1 through MW-5, MW-10R, EX-1, and MPE-1 and decreased in MW-6, MW-7, MW-11, and MPE-2; detectable benzene concentrations have increased in MW-1, MW-3, MW-4, MW-5, MW-7, MW-10R, MPE-1, and MPE-2 and decreased in MW-6 and EX-1.
- An MPE event was conducted from August 2 to August 5, 2016 utilizing off-site well MW-10R. During this event approximately 47 lbs of VOCs and 711 gallons of groundwater mixed with free-product was removed from this well. The total mass of hydrocarbon removed by MPE operations (as of August 2016) at the site is estimated to be 3,629 pounds. Results of the groundwater samples collected from MW-10R and Third Quarter 2016 groundwater monitoring event show the effectiveness of MPE operation at the site.

Based on results of the Third Quarter 2016 groundwater monitoring event and the recent MPE event, SOMA recommends that this site be evaluated for closure under the LTCP (Low Threat Case Closure Policy) criteria.

## 6. REPORT LIMITATIONS

This report is the summary of work done by SOMA, including observations and descriptions of site conditions. It includes analysis results produced by Curtis & Tompkins Laboratories for the current groundwater monitoring event. Quantities and locations of wells were selected to provide the required information, but may not be representative of entire site conditions. All conclusions and recommendations are based on laboratory analysis results. Conclusions beyond those specifically stated in this document should not be inferred from this report.

SOMA warrants that services were provided in accordance with generally accepted practices in the environmental engineering and consulting field at the time of this sampling.

# Figures



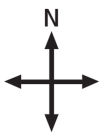

approximate scale in feet



Figure 1: Site vicinity map.

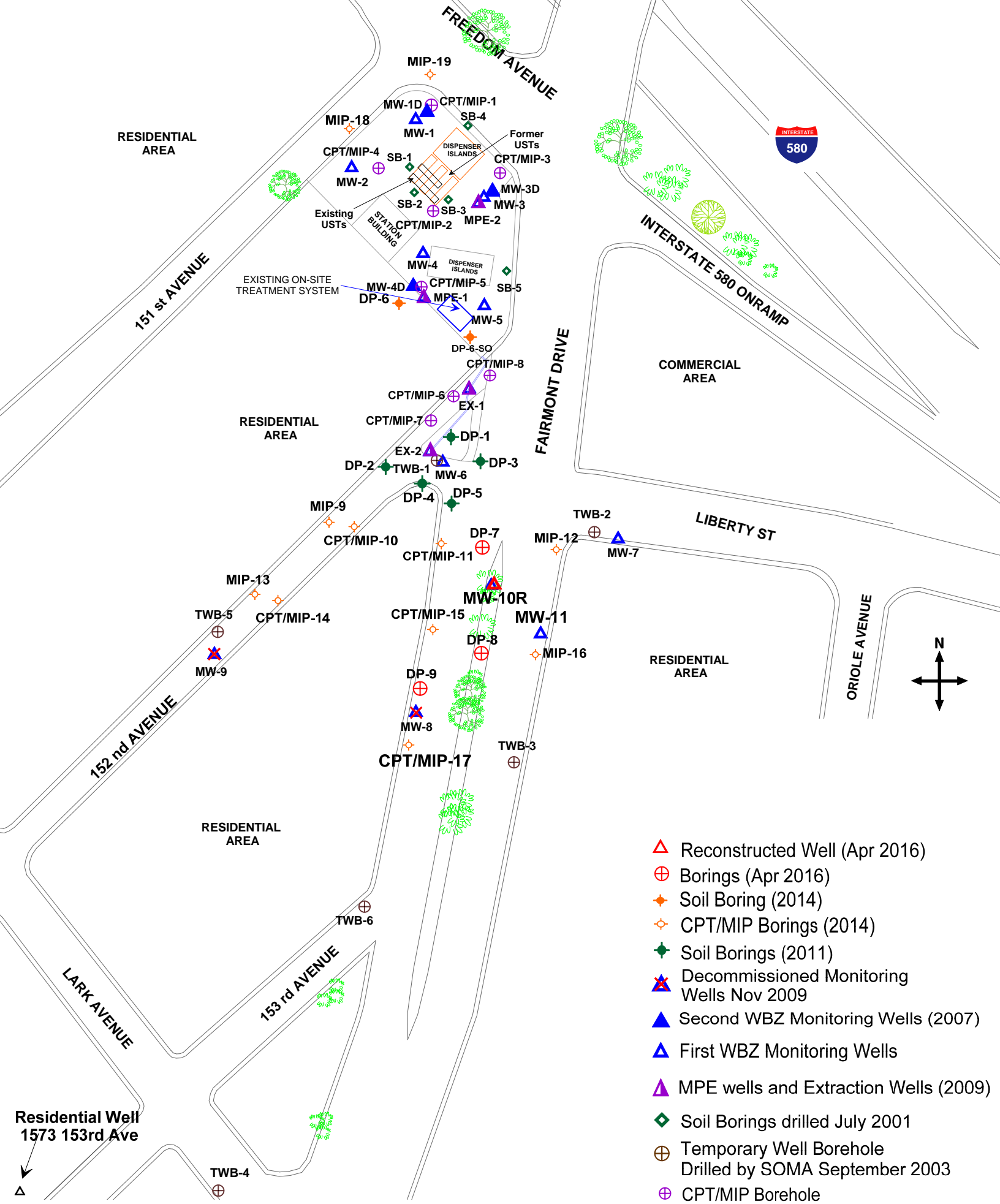

Residential Well  
1573 153rd Ave

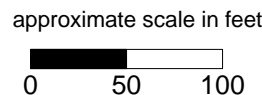
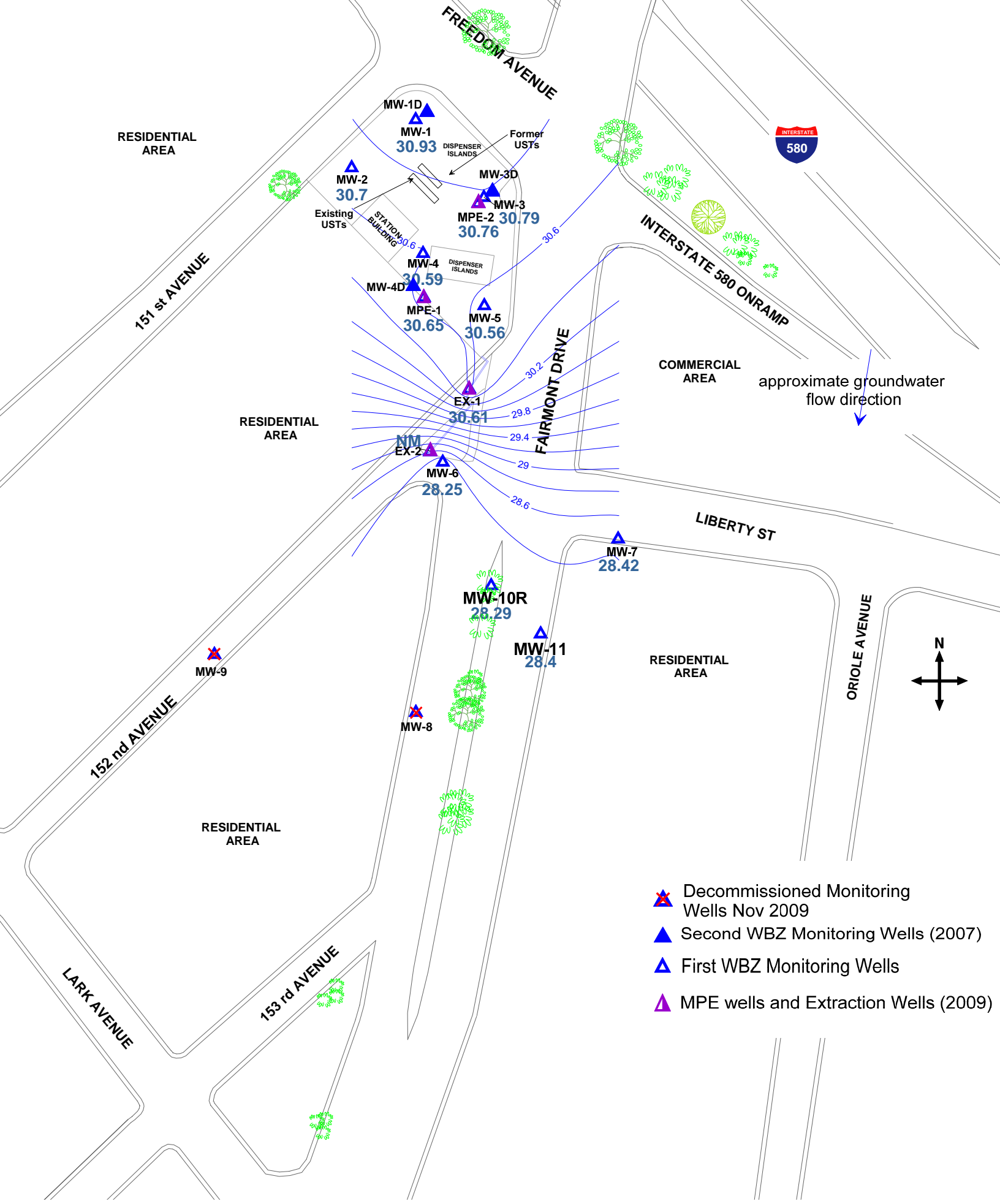

Figure 2: Site Map Showing Locations of USTs, Fuel Dispensers, Soil Borings, Vapor Samples, and Groundwater Monitoring Wells





approximate scale in feet  
 0 50 100

Figure 3: Groundwater Elevation Contour Map in Feet, First WBZ, September 21, 2016





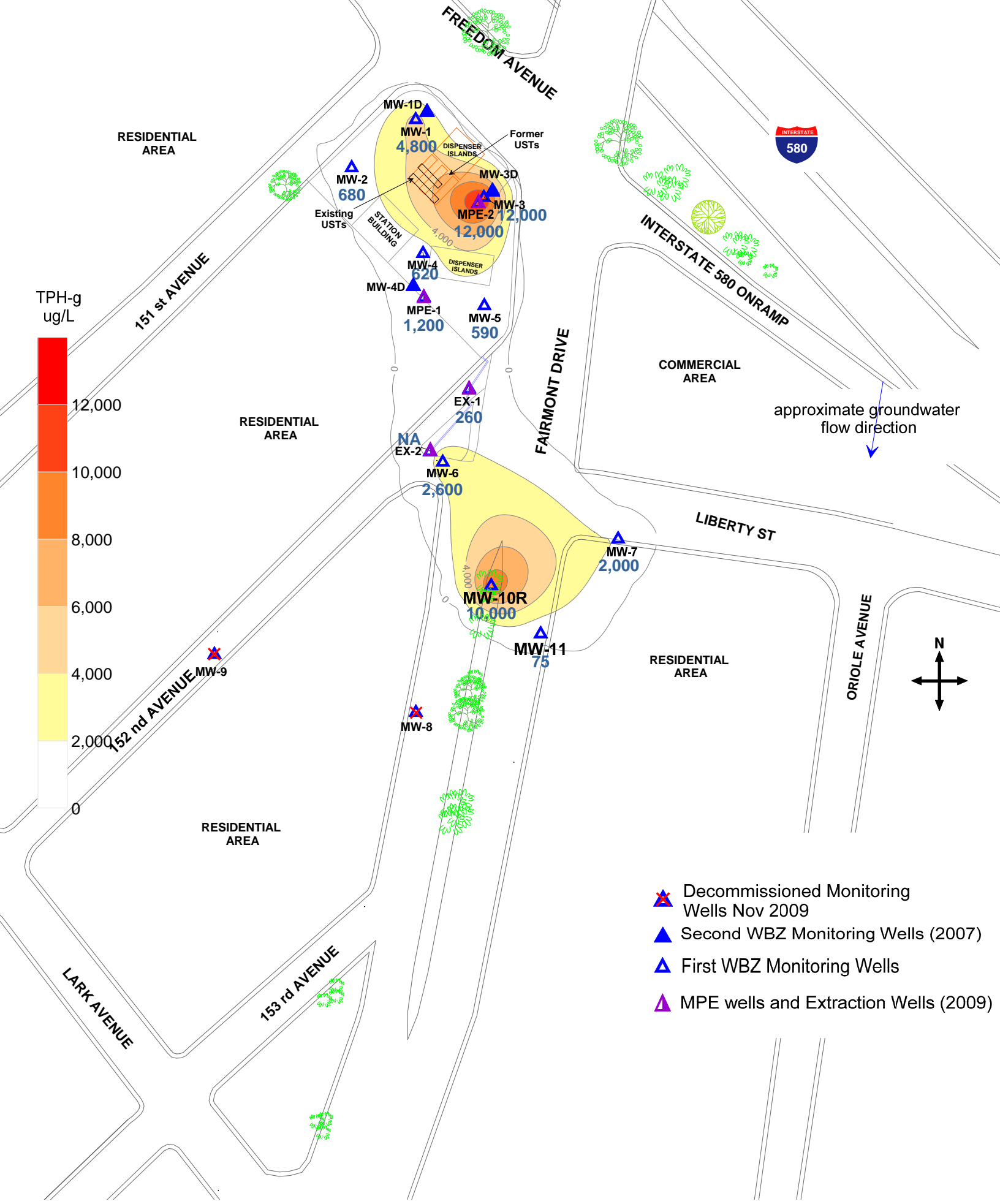

Figure 4: Contour Map of TPH-g Concentrations in Groundwater, First WBZ, September 21, 2016

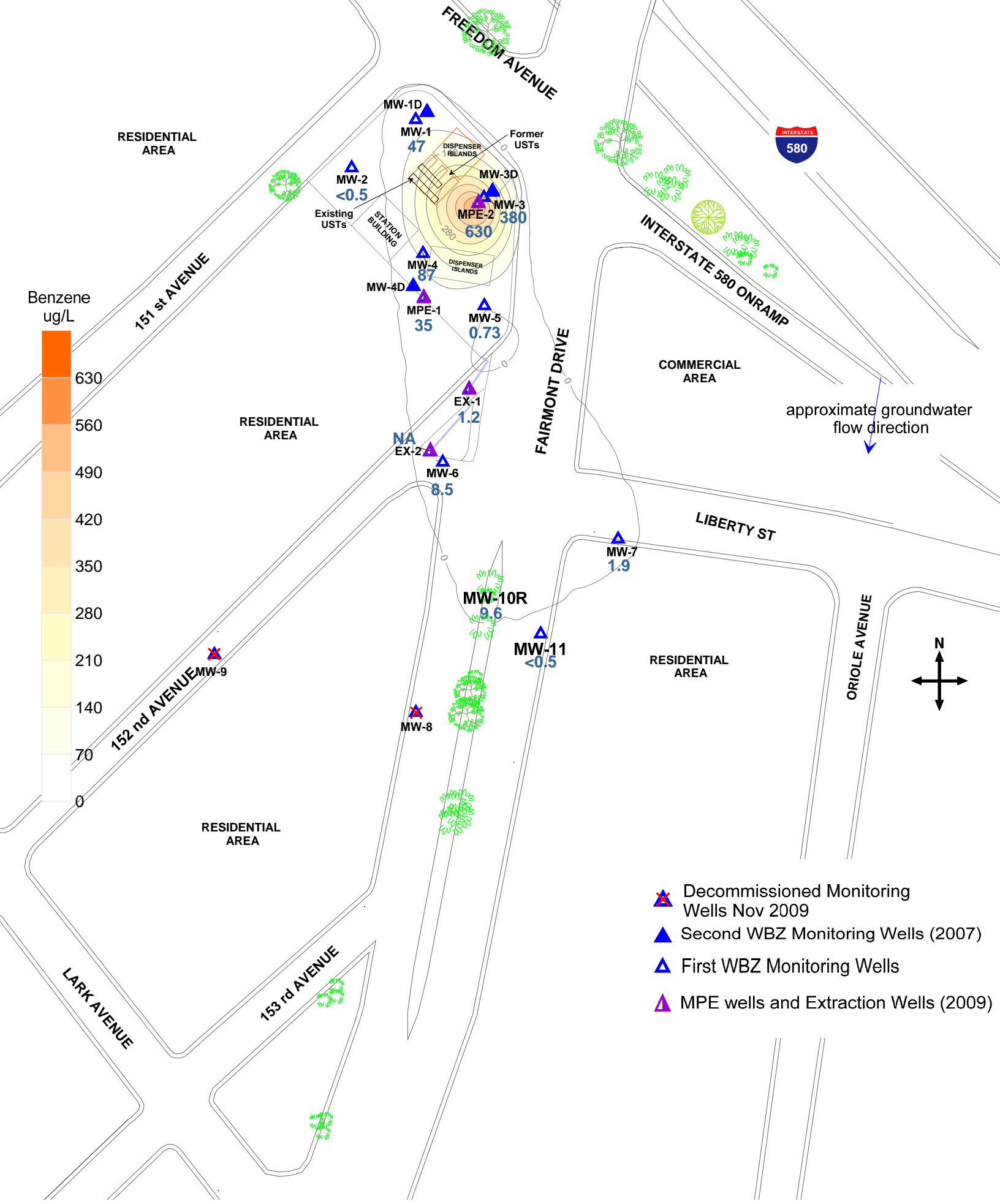

Figure 5: Contour Map of benzene Concentrations in Groundwater, First WBZ, September 21, 2016

approximate scale in feet  
 0 50 100

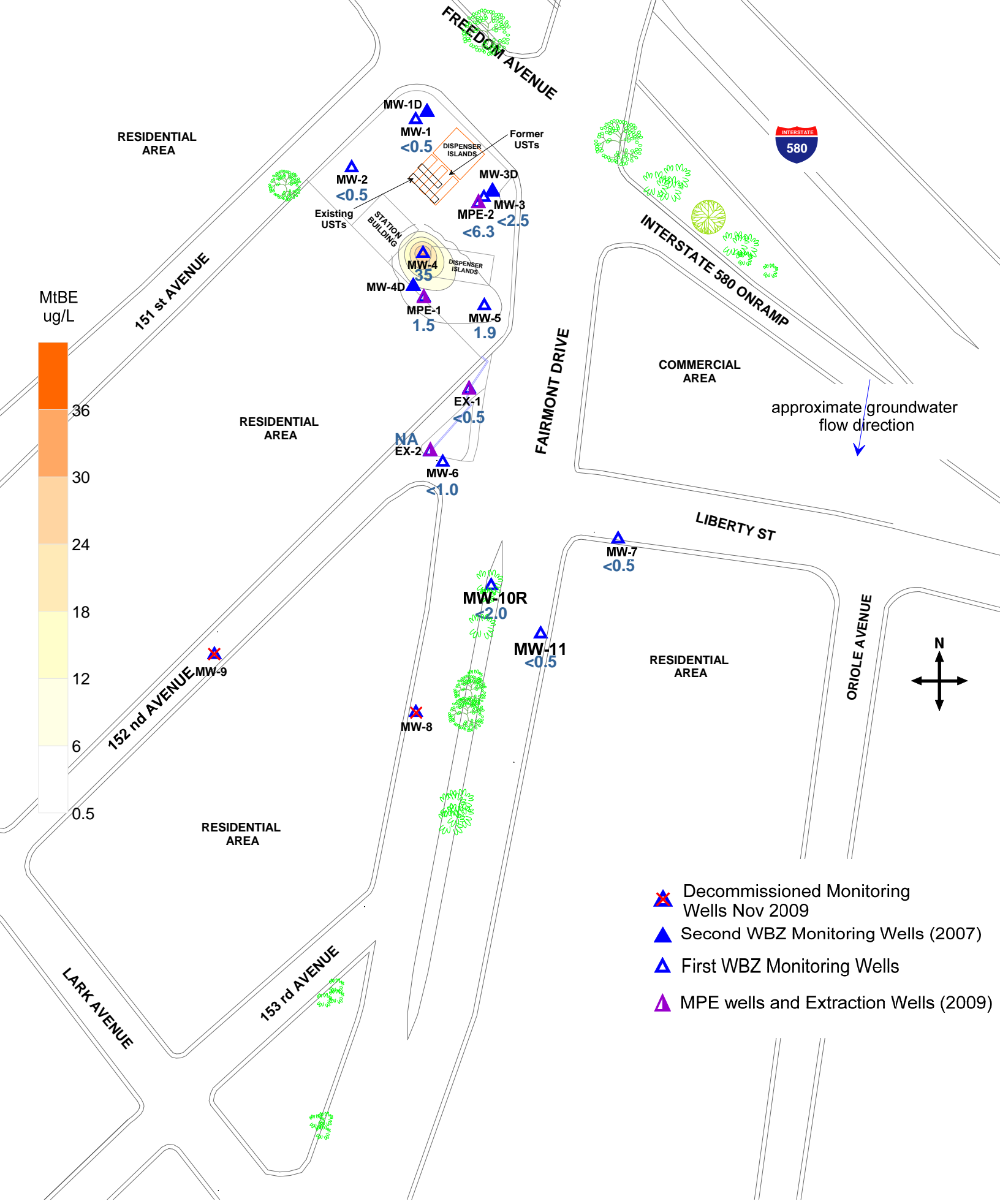

Figure 6: Contour Map of MtBE Concentrations in Groundwater, First WBZ, September 21, 2016

approximate scale in feet  
 0 50 100

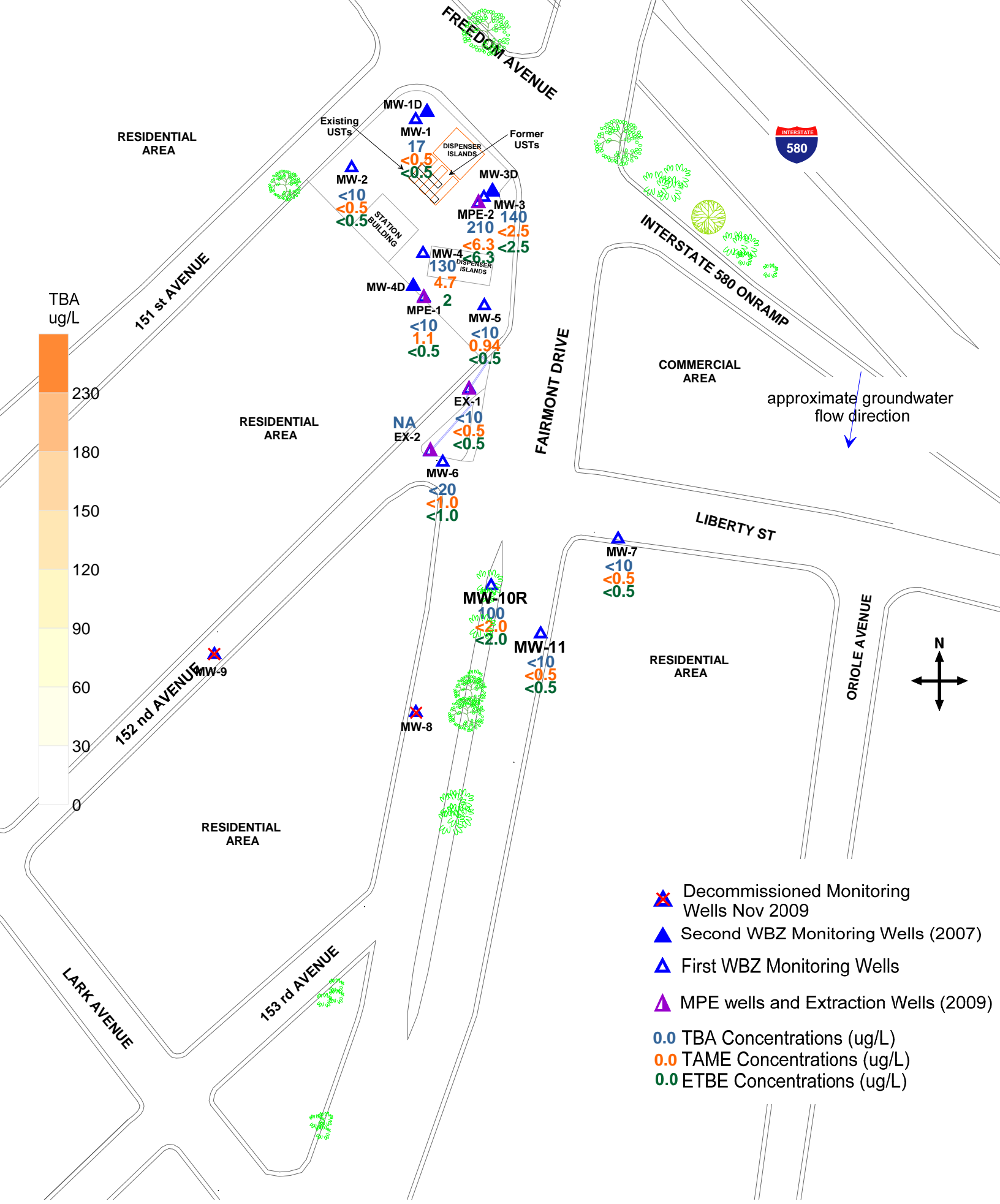
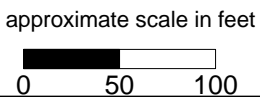

Figure 7: Contour Map of TBA Concentrations and Map of TAME and ETBE Concentrations in Groundwater, September 21, 2016



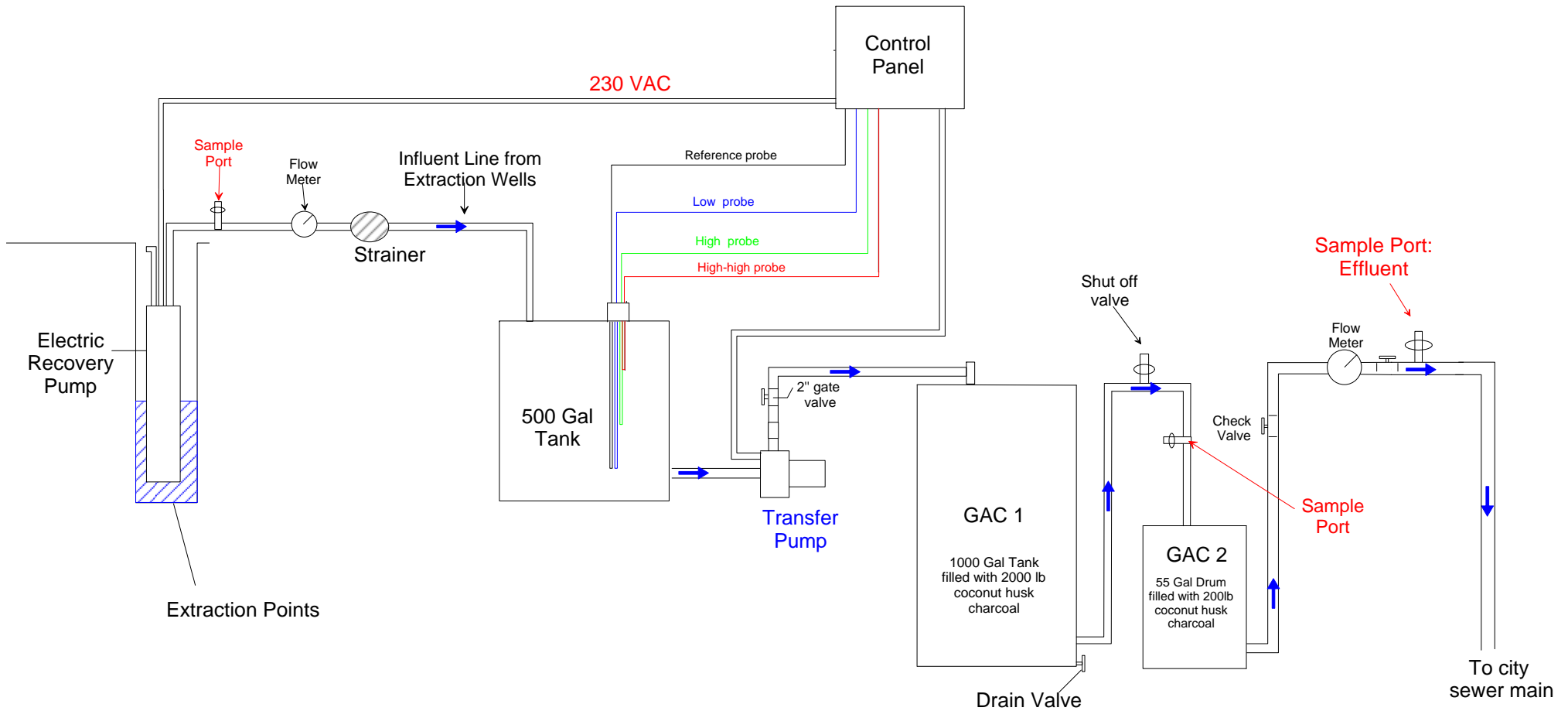
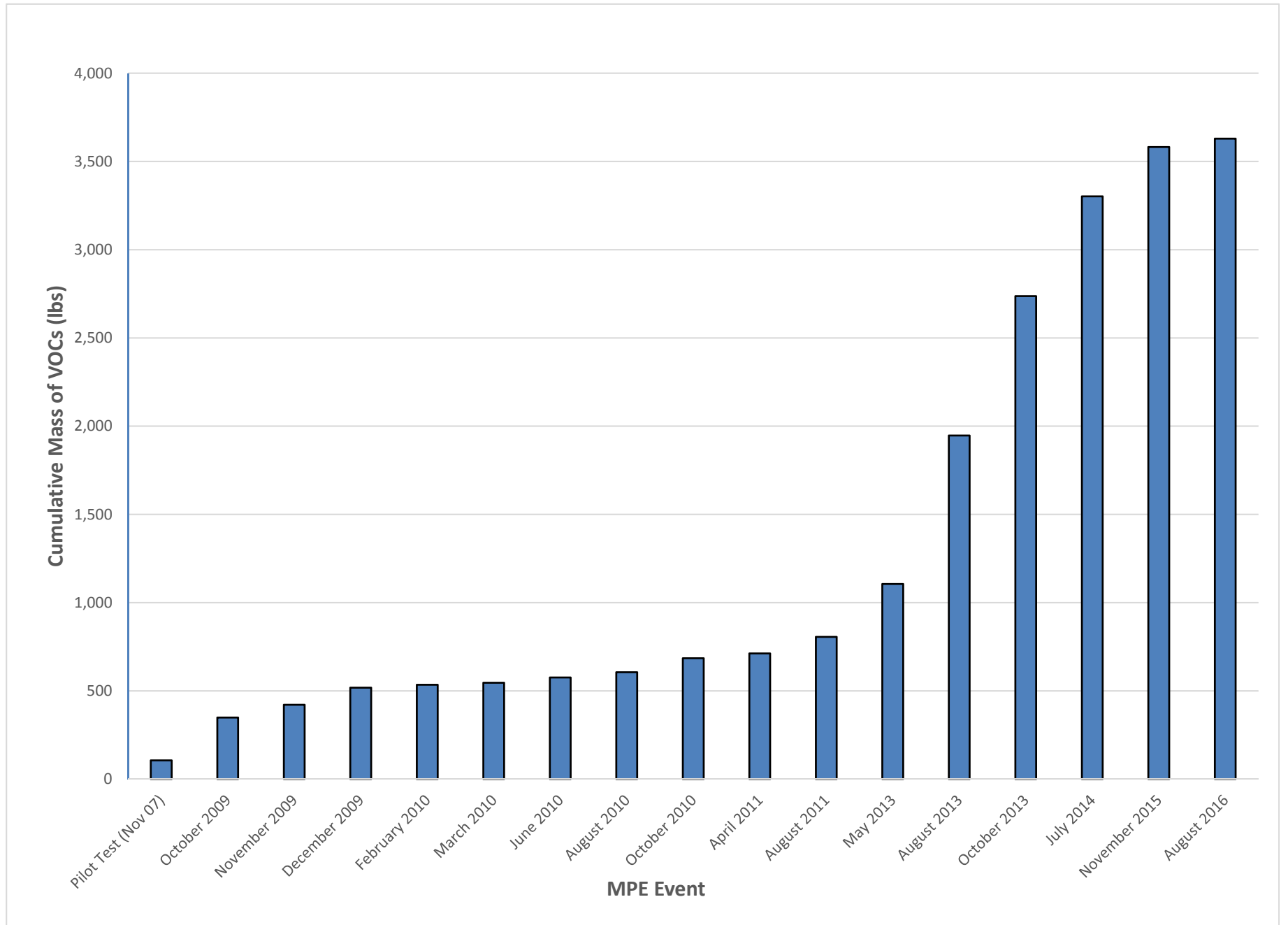

Figure 8: Schematic diagram of Groundwater Remediation System





**Figure 9: Cumulative Mass of VOCs Removed**

# Tables

**Table 1**  
**Historical Groundwater Elevation Data and Analytical Results**  
15101 Freedom Avenue, San Leandro, CA

Monitoring Well	Date	Casing Elevation <sup>1</sup> (feet)	Depth to Groundwater (feet)	Free-Product (feet)/ Sheen (Y/N)	Groundwater Elevation (feet)	TPH-g (µg/L)	Benzene (µg/L)	Toluene (µg/L)	Ethyl-benzene (µg/L)	Total Xylenes (µg/L)	MtBE 8260B <sup>2</sup> (µg/L)
1st WBZ											
MW-1	5/10/2002	51.71	22.85	-	28.86	5,700	360	4.5	340	450	2
	8/8/2002	51.71	23.31	-	28.40	9,100	590	2.6	830	362	<1.3
	11/8/2002	51.71	23.58	-	28.13	7,900	570	3.1	680	392	< 1.0
	2/21/2003	51.71	22.62	-	29.09	2,900	160	1.6 C	170	211	<0.5
	5/28/2003	51.71	22.43	-	29.28	1,700	55	<0.5	90	115	2.00
	8/12/2003	51.71	21.30	-	30.41	2,600	2.5	<0.5	190	130	<0.5
	10/9/2003	51.71	23.49	-	28.22	9,200	560.0	2.7 C	670	648	<1.0
	1/15/2004	51.71	22.43	-	29.28	5,500	190	<1.0	220	124.4	<0.5
	5/25/2004	51.71	22.94	-	28.77	8,000	400	1.50	420	393	3.40
	9/21/2004	54.46	23.49	-	30.97	9,300	580	9.30	690	683	4.60
	12/14/2004	54.46	23.01	-	31.45	7,360	337	<4.3	731	633	<4.3
	3/11/2005	54.46	21.48	-	32.98	2,510	45.2	<0.5	23.2	39.63	2.80
	6/15/2005	54.46	22.42	-	32.04	1,690	36.3	<2.0	59.5	28.73	2.01
	8/26/2005	54.46	23.00	-	31.46	7,310	318	<8.60	475	316	5.15
	11/11/2005	54.46	21.40	-	33.06	9,640	341	<8.6	467	329.7	6.04
	2/9/2006	54.46	21.81	-	32.65	775	14	<2.0	12.6	10.32	4.01
	5/9/2006	54.46	21.68	-	32.78	444	7.80	<2.0	12.1	6.31	1.75
	8/10/2006	54.46	22.79	-	31.67	5,090	324	<8.60	108	59.9	8.24
	10/26/2006	54.46	23.19	-	31.27	6,950	556	<4.0	190	136.09	8.61
	1/25/2007	54.46	22.82	-	31.64	2,640	196	<2.0	105	25.5	7.92
4/26/2007	54.46	22.67	-	31.79	861	95.5	<2.0	17	6.36	4.00	
7/25/2007	54.46	23.25	-	31.21	4,520	412	<4.0	182	77.9	7.48	
10/23/2007	54.46	23.42	-	31.04	3,900	117	<2.0	87.1	23.87	4.54	

**Table 1**  
**Historical Groundwater Elevation Data and Analytical Results**  
15101 Freedom Avenue, San Leandro, CA

Monitoring Well	Date	Casing Elevation <sup>1</sup> (feet)	Depth to Groundwater (feet)	Free-Product (feet)/ Sheen (Y/N)	Groundwater Elevation (feet)	TPH-g (µg/L)	Benzene (µg/L)	Toluene (µg/L)	Ethyl-benzene (µg/L)	Total Xylenes (µg/L)	MtBE 8260B <sup>2</sup> (µg/L)
MW-1 cont.	1/22/2008	54.46	22.59	-	31.87	2,260	81.3	<2.0	17.5	<2.0	4.23
	4/16/2008	54.46	22.89	-	31.57	2,320	248	<2.0	54.1	37.3	<0.5
	7/3/2008	54.46	23.33	-	31.13	5,240	414	<2.0	168	94	6.56
	10/15/2008	54.46	23.76	-	30.70	4,500 <sup>Y</sup>	260	<1.0	150	130	3.40
	1/7/2009	54.46	23.25	-	31.21	4,800	140	<1.3	48	32	1.70
	4/14/2009	54.46	22.52	-	31.94	1,800 <sup>Y</sup>	78	<0.5	35	18	2.50
	8/27/2009	54.46	23.6	-	30.86	4,500	330	<2.0	97	42	4.60
	12/2/2009	54.46	23.43	-	31.03	3,800 <sup>Y</sup>	250	<2.0	110	25	2.50
	3/17/2010	54.46	22.32	-	32.14	1,100	33	<0.50	46	18	1.70
	6/3/2010	54.46	22.88	-	31.58	10,000	330	4.3	680	841.5	5.20
	9/2/2010	54.46	23.28	-	31.18	8,900	440	<5.0	510	310	<5.0
	12/2/2010	54.46	23.21	-	31.25	7,400	250	<3.1	390	180	<3.1
	3/4/2011	54.46	21.95	N	32.51	2,400	67	<0.5	45	8.4	2.20
	5/20/2011	54.46	22.8	N	31.66	9,500	260	6.2	970	480	<3.6
	9/9/2011	54.46	22.81	N	31.65	6,400	220	<1.3	380	160	2.30
	12/2/2011	54.46	21.97	N	32.49	4,700 <sup>x</sup>	96	<1.7	310	200	<3.3
	3/2/2012	54.46	22.82	N	31.64	6,800	320	<2.5	430	120	<2.5
	6/7/2012	54.46	22.92	N	31.54	5,600	130	<2.5	360	160	2.9
	9/21/2012	54.46	23.56	N	30.90	8,000	300	<2.5	410	340	2.6
	12/14/2012	54.46	22.77	N	31.69	5,900	130	<2.5	320	97	<2.5
3/28/2013	54.46	23.15	N	31.31	5,100	230	<2.5	280	48	3.6	
6/11/2013	54.46	23.48	N	30.98	6,800	200	<2.5	300	120	<2.5	
9/17/2013	54.46	23.84	N	30.62	7,500	120	<2.5	410	260	<2.5	
12/6/2013	54.46	24.16	N	30.30	5,300	71	<1.7	240	84	<1.7	

**Table 1**  
**Historical Groundwater Elevation Data and Analytical Results**  
15101 Freedom Avenue, San Leandro, CA

Monitoring Well	Date	Casing Elevation <sup>1</sup> (feet)	Depth to Groundwater (feet)	Free-Product (feet)/ Sheen (Y/N)	Groundwater Elevation (feet)	TPH-g (µg/L)	Benzene (µg/L)	Toluene (µg/L)	Ethyl-benzene (µg/L)	Total Xylenes (µg/L)	MtBE 8260B <sup>2</sup> (µg/L)	
MW-1 cont.	3/13/2014	54.46	23.47	N	30.99	2,800	16	<0.5	74	15	1.4	
	6/6/2014	54.46	23.46	N	31.00	5,000	47	<0.5	240	58	0.9	
	9/23/2014	54.46	24.49	N	29.97	6,700	44	<1.7	200	71	<1.7	
	12/23/2014	54.46	21.52	N	32.94	730	2.2	<0.5	0.84	<0.5	<0.5	
	3/20/2015	54.46	22.83	N	31.63	1,200	8.6	1.9	17	<0.5	0.59	
	6/4/2015	54.46	23.22	N	31.24	5,100	23	<0.71	110	3.6	0.73	
	9/11/2015	54.46	23.76	N	30.70	4,200	3.3	<1.7	18	<1.7	<1.7	
	12/28/2015	54.46	23.39	N	31.07	590	<0.5	<0.5	1.4	0.55	<0.5	
	3/23/2016	54.46	21.38	N	33.08	98	<0.5	<0.5	<0.5	<0.5	<0.5	
	6/15/2016	54.46	21.41	N	33.05	1,300	37	<0.5	99	9.3	0.79	
	<b>9/21/2016</b>	<b>54.46</b>	<b>23.53</b>	<b>N</b>	<b>30.93</b>	<b>4,800</b>	<b>47</b>	<b>0.57</b>	<b>74</b>	<b>0.62</b>	<b>&lt;0.5</b>	
	MW-2	5/10/2002	49.66	22.83	-	26.83 *	3,100	67	8	250	215	56
8/8/2002		49.66	21.41	-	28.25	2,700	4.6	<0.5	310	140	<0.5	
11/8/2002		49.66	21.79	-	27.87	3,400	4.6	< 0.5	310	160	< 0.5	
2/21/2003		49.66	20.51	-	29.15	890	1.7 C	0.80 C	68	38.92 C	<0.5	
5/28/2003		49.66	20.33	-	29.33	2,700	5.2 C	<0.5	120	140	1.2	
8/12/2003		49.66	23.18	-	26.48*	8,500	640	<2.5	560	659	<0.8	
10/9/2003		49.66	21.71	-	27.95	3100 H	4.3 C	<0.5	210	160	<0.5	
1/15/2004		49.66	20.31	-	29.35	660 H	1.5 C	<0.5	8.9	25	<0.5	
5/25/2004		49.66	21.09	-	28.57	4,500	5.1 C	<0.5	190	230	0.70	
9/21/2004		52.41	21.71	-	30.70	370	0.76 C	<0.5	25	16	0.50	
12/14/2004		52.41	21.20	-	31.21	880	1.0	<0.5	66	52	<0.5	
3/11/2005		52.41	19.15	-	33.26	564	<0.5	<0.5	21	11.9	<0.5	
6/15/2005		52.41	20.30	-	32.11	2,040	1.2	<2.0	78.2	22	<0.5	
8/26/2005		52.41	20.97	-	31.44	1,500	0.930	<2.00	87.6	21	0.86	
11/11/2005		52.41	25.30	-	27.11	2,140	1.08	<2.0	104	29	0.79	
2/9/2006		52.41	19.41	-	33.00	1,410	<0.5	<2.0	99.6	21.4	0.72	
5/9/2006	52.41	19.41	-	33.00	1,100	<0.5	<2.0	86.5	17	<0.5		
8/10/2006	52.41	20.8	-	31.61	3,180	2.87	<2.0	88.9	24.8	<0.50		
10/26/2006	52.41	21.22	-	31.19	1,200	<0.5	<2.0	23.5	4.79	0.6		

**Table 1**  
**Historical Groundwater Elevation Data and Analytical Results**  
15101 Freedom Avenue, San Leandro, CA

Monitoring Well	Date	Casing Elevation <sup>1</sup> (feet)	Depth to Groundwater (feet)	Free-Product (feet)/ Sheen (Y/N)	Groundwater Elevation (feet)	TPH-g (µg/L)	Benzene (µg/L)	Toluene (µg/L)	Ethyl-benzene (µg/L)	Total Xylenes (µg/L)	MtBE 8260B <sup>2</sup> (µg/L)
MW-2 cont.	1/25/2007	52.41	20.89	-	31.52	623	0.64	<2.0	42.4	4.37	0.66
	4/26/2007	52.41	20.65	-	31.76	169	<0.5	<2.0	15.2	2.3	<0.5
	7/25/2007	52.41	21.43	-	30.98	276	0.78	<2.0	22.1	4.04	<0.5
	10/23/2007	52.41	21.59	-	30.82	535	<0.5	<2.0	18	5.11	<0.5
	1/22/2008	52.31	20.45	-	31.86	132	<0.5	<2.0	12.2	<2.0	<0.5
	4/15/2008	52.41	20.89	-	31.52	852	<0.5	<2.0	27.2	4.78	<0.5
	7/2/2008	52.41	21.5	-	30.91	98.3	<0.5	<2.0	2.76	<2.0	<0.5
	10/15/2008	52.41	22.06	-	30.35	1,400 <sup>Y</sup>	<0.5	<0.5	60	17	<0.5
	1/7/2009	52.41	21.35	-	31.06	93	<0.5	<0.5	2.1	0.74	<0.5
	4/13/2009	52.41	20.52	-	31.89	480 <sup>Y</sup>	<0.5	<0.5	20	5.5	<0.5
	8/27/2009	52.41	21.85	-	30.56	130	<0.5	<0.5	2.5	0.61	<0.5
	12/1/2009	52.41	21.59	-	30.82	760 <sup>Y</sup>	<0.5	<0.5	14	1.5	<0.5
	3/17/2010	52.41	20.11	-	32.30	480	<0.5	<0.5	30	6.9	<0.5
	6/3/2010	52.41	21	-	31.41	690	<0.5	<0.5	14	2.6	<0.5
	9/2/2010	52.41	21.42	-	30.99	470	<0.5	<0.5	7.6	1	<0.5
	12/2/2010	52.41	21.44	-	30.97	470	<0.5	<0.5	7.6	3.3	<0.5
	3/4/2011	52.41	19.65	N	32.76	240	<0.5	<0.5	6.6	0.8	<0.5
	5/20/2011	52.41	20.75	N	31.66	310	<0.5	<0.5	4.8	<0.5	<0.5
	9/9/2011	52.41	21.05	N	31.36	1,000	<0.5	<0.5	12	0.76	<0.5
	12/2/2011	52.41	20.14	N	32.27	900 <sup>x</sup>	<2.9	<1.7	14	1.9	<3.3
3/2/2012	52.41	19.98	N	32.43	880	<0.5	<0.5	5.3	0.58	<0.5	
6/7/2012	52.41	21.04	N	31.37	720	<0.5	<0.5	7.9	0.79	<0.5	
9/21/2012	52.41	21.78	N	30.63	1,400	<0.5	<0.5	11	<0.5	<0.5	
12/14/2012	52.41	20.71	N	31.70	760	<0.5	<0.5	10	1.5	<0.5	

**Table 1**  
**Historical Groundwater Elevation Data and Analytical Results**  
15101 Freedom Avenue, San Leandro, CA

Monitoring Well	Date	Casing Elevation <sup>1</sup> (feet)	Depth to Groundwater (feet)	Free-Product (feet)/ Sheen (Y/N)	Groundwater Elevation (feet)	TPH-g (µg/L)	Benzene (µg/L)	Toluene (µg/L)	Ethyl- benzene (µg/L)	Total Xylenes (µg/L)	MtBE 8260B <sup>2</sup> (µg/L)
MW-2 cont.	3/28/2013	52.41	21.24	N	31.17	890	<0.5	<0.5	4.3	<0.5	<0.5
	6/11/2013	52.41	21.67	N	30.74	510	150	<0.5	15	12.3	3.1
	9/16/2013	52.41	22.15	N	30.26	210	<0.5	<0.5	1.1	<0.5	<0.5
	12/6/2013	52.41	22.52	N	29.89	290	1.4	<0.5	1.1	<0.5	<0.5
	3/13/2014	52.41	21.56	N	30.85	190	<0.5	<0.5	<0.5	<0.5	<0.5
	6/6/2014	52.41	21.7	N	30.71	97	<0.5	<0.5	<0.5	<0.5	<0.5
	9/23/2014	52.41	22.95	N	29.46	80	<0.5	<0.5	<0.5	<0.5	<0.5
	12/23/2014	52.41	18.91	N	33.50	140	<0.5	0.7	1.8	<0.5	<0.5
	3/20/2015	52.41	20.76	N	31.65	380	<0.5	0.8	0.86	<0.5	<0.5
	6/4/2015	52.41	21.3	N	31.11	700	<0.5	<0.5	0.72	<0.5	<0.5
	9/11/2015	52.41	21.95	N	30.46	1,900	<1.0	<1.0	2.3	<1.0	<1.0
	12/28/2015	52.41	21.38	N	31.03	170	<0.5	<0.5	0.51	<0.5	<0.5
	3/23/2016	52.41	18.88	N	33.53	170	<0.5	<0.5	<0.5	<0.5	<0.5
	6/15/2016	52.41	18.91	N	33.50	380	<0.5	<0.5	<0.5	<0.5	<0.5
	<b>9/21/2016</b>	<b>52.41</b>	<b>21.71</b>	<b>N</b>	<b>30.70</b>	<b>680</b>	<b>&lt;0.5</b>	<b>&lt;0.5</b>	<b>&lt;0.5</b>	<b>&lt;0.5</b>	<b>&lt;0.5</b>
	MW-3	5/10/2002	51.16	22.28	-	28.88	44,000	6,000	900	1,500	6,200
8/8/2002		51.16	22.88	-	28.28	40,000	5,800	1,100	1,600	6,500	1,300
11/8/2002		51.16	23.19	-	27.97	47,000	5,300	1,200	2,200	8,600	1,000
2/21/2003		51.16	22.02	-	29.14	39,000	5,500	1,500	2,000	8,600	1,300
5/28/2003		51.16	21.89	-	29.27	52,000	7,300	3,000	2,800	12,700	2,100
8/12/2003		51.16	22.66	-	28.50	31,000	6,100	860	1,500	6,900	1,200
10/9/2003		51.16	23.06	-	28.10	41,000	6,100	1,100	2,200	10,200	960
1/15/2004		51.16	21.85	-	29.31	51,000	4,100	1,100	2,000	8,400	590
5/25/2004		51.16	22.55	-	28.61	65,000	4,300	1,300	2,500	10,500	720
9/21/2004		53.91	23.08	-	30.83	42,000	4,900	890	2,200	8,700	480
12/14/2004		53.91	22.52	-	31.39	35,151	4,066	972	2,942	13,032	491
3/11/2005		53.91	20.90	-	33.01	42,600	3,040	1,100	1,530	6,670	968
6/15/2005		53.91	21.85	-	32.06	84,100	5,110	2,160	3,030	8,800	2,670
8/26/2005		53.91	22.49	-	31.42	43,500	3,630	1,080	2,500	6,830	1,440
11/11/2005		53.91	22.81	-	31.10	47,700	4,240	520	2,170	6,320	1,390

**Table 1**  
**Historical Groundwater Elevation Data and Analytical Results**  
15101 Freedom Avenue, San Leandro, CA

Monitoring Well	Date	Casing Elevation <sup>1</sup> (feet)	Depth to Groundwater (feet)	Free-Product (feet)/ Sheen (Y/N)	Groundwater Elevation (feet)	TPH-g (µg/L)	Benzene (µg/L)	Toluene (µg/L)	Ethyl-benzene (µg/L)	Total Xylenes (µg/L)	MtBE 8260B <sup>2</sup> (µg/L)
MW-3 cont.	2/9/2006	53.91	21.12	-	32.79	44,500	5,070	1360	1,920	4,840	3,280
	5/9/2006	53.91	21.09	-	32.82	48,100	2,510	1,140	1,950	5,030	2,210
	8/10/2006	53.91	22.26	-	31.65	42,100	3,450	869	1,760	5,650	3,570
	10/26/2006	53.91	22.73	-	31.18	33,400	4,800	331	1,170	3,510	4,790
	1/25/2007	53.91	22.34	-	31.57	19,300	4,820	167	1,540	3,740	3,430
	4/26/2007	53.91	22.24	-	31.67	30,700	2,350	158	1,470	4,320	1,330
	7/25/2007	53.91	22.83	-	31.08	34,900	5,400	364	2,080	6,360	1,980
	10/23/2007	53.91	23.01	-	30.9	22,600	4,070	<86	1,120	3,095	970
	1/22/2008	53.96	22.04	-	31.92	22,100	1,280	453	1,330	3,520	490
	4/16/2008	53.91	22.4	-	31.51	20,700	2,790	182	860	3,389	263
	7/3/2008	53.91	22.9	-	31.01	48,500	3,760	346	3,130	12,980	573
	10/16/2008	53.91	23.36	-	30.55	50,000	3,900	300	3,100	11,000	460
	1/8/2009	53.91	22.82	-	31.09	54,000	2,600	180	2,500	8,800	220
	4/13/2009	53.91	22.06	-	31.85	49,000	2,900	170	2,100	8,100	490
	8/27/2009	53.91	23.11	-	30.80	43,000	2,500	160	1,900	7,000	210
	12/2/2009	53.91	23.00	-	30.91	30,000	2,100	180	1,600	5,600	91
	3/17/2010	53.91	21.90	-	32.01	24,000	970	81	1,100	3,700	38
	6/3/2010	53.91	22.49	-	31.42	31,000	1,200	110	1,300	4,400	34
	9/2/2010	53.91	22.76	-	31.15	26,000	1,100	81	1,200	3,810	26
	12/2/2010	53.91	22.86	-	31.05	18,000	830	47	780	2,360	14
3/4/2011	53.91	21.44	N	32.47	18,000	410	32	850	2,480	16	
5/20/2011	53.91	22.36	N	31.55	12,000	710	24	620	1,460	11	
9/9/2011	53.91	22.44	N	31.47	11,000	1,100	26	580	1,430	7.8	
12/2/2011	53.91	21.60	N	32.31	5,100 <sup>x</sup>	280	12	370	740	<1.7	



**Table 1**  
**Historical Groundwater Elevation Data and Analytical Results**  
15101 Freedom Avenue, San Leandro, CA

Monitoring Well	Date	Casing Elevation <sup>1</sup> (feet)	Depth to Groundwater (feet)	Free-Product (feet)/ Sheen (Y/N)	Groundwater Elevation (feet)	TPH-g (µg/L)	Benzene (µg/L)	Toluene (µg/L)	Ethyl- benzene (µg/L)	Total Xylenes (µg/L)	MtBE 8260B <sup>2</sup> (µg/L)	
MW-3 cont.	3/2/2012	53.91	22.39	N	31.52	13,000	440	23	690	1,570	<5.0	
	6/7/2012	53.91	22.50	N	31.41	9,000	290	9.3	520	900	<5.0	
	9/21/2012	53.91	23.17	N	30.74	12,000	710	26	630	1,230	8.2	
	12/14/2012	53.91	22.32	Y	31.59	8,500	350	8.7	550	1,003	<5	
	3/28/2013	53.91	22.69	Y	31.22	9,300	790	8.2	760	974	8.7	
	6/11/2013	53.91	23.06	Y	30.85	14,000	700	26	860	1,630	6.1	
	9/17/2013	53.91	23.41	Y	30.50	28,000	570	37	1,800	3,560	<10	
	12/6/2013	53.91	23.76	Y	30.15	23,000	360	26	1,700	3,330	<10	
	3/12/2014	53.91	23.13	22.98	30.88	FP	FP	FP	FP	FP	FP	FP
	6/5/2014	53.91	23.08	23.06	30.84	FP	FP	FP	FP	FP	FP	FP
	9/23/2014	53.91	24.16	Y	29.75	41,000	230	84	1,000	4,500	<10	
	12/23/2014	53.91	20.83	N	33.08	13,000	64	28	250	1,250	<3.6	
	3/20/2015	53.91	22.32	Y	31.59	18,000	140	24	730	1,870	<3.6	
	6/4/2015	53.91	22.77	Y	31.14	32,000	200	17	680	1,820	<6.3	
	9/11/2015	53.91	23.31	Y	30.60	24,000	260	<6.3	380	1,144	<6.3	
	12/29/2015	53.91	22.95	Y	30.96	13,000	74	<5.0	220	628	<5.0	
	3/24/2016	53.91	20.75	Y	33.16	7,600	180	2	130	263	3.2	
6/16/2016	53.91	20.78	Y	33.13	10,000	98	2.6	250	507	1.7		
<b>9/21/2016</b>	<b>53.91</b>	<b>23.12</b>	<b>N</b>	<b>30.79</b>	<b>12,000</b>	<b>380</b>	<b>&lt;2.5</b>	<b>250</b>	<b>424</b>	<b>&lt;2.5</b>		
MW-4	5/10/2002	50.54	21.78	-	28.76	880	25	1.0C	110	52	12,000	
	8/8/2002	50.54	22.50	-	28.04	3,800	70	<5.0	300	115	4,800	
	11/8/2002	50.54	22.81	-	27.73	5,100	150	10	460	258	2,400	
	2/21/2003	50.54	21.48	-	29.06	3,200	98	66	220	360	6,600	
	5/28/2003	50.54	21.24	-	29.30	6,200	140	46	200	790	2,300	
	8/12/2003	50.54	22.32	-	28.22	7,500	180	57	220	1450	1,900	
	10/9/2003	50.54	22.74	-	27.80	5,800	250	32	300	970	7,800	
	1/15/2004	50.54	21.19	-	29.35	5,900	270	17 C	150	640	7,300	
	5/25/2004	50.54	22.03	-	28.51	9,100	210	51	200	1190	1800	
	9/21/2004	53.31	22.76	-	30.55	5,200	290	12	370	600	7300	
	12/14/2004	53.31	21.99	-	31.32	8,937	538	114	416	2379	5021	

**Table 1**  
**Historical Groundwater Elevation Data and Analytical Results**  
**15101 Freedom Avenue, San Leandro, CA**

Monitoring Well	Date	Casing Elevation <sup>1</sup> (feet)	Depth to Groundwater (feet)	Free-Product (feet)/ Sheen (Y/N)	Groundwater Elevation (feet)	TPH-g (µg/L)	Benzene (µg/L)	Toluene (µg/L)	Ethyl-benzene (µg/L)	Total Xylenes (µg/L)	MtBE 8260B <sup>2</sup> (µg/L)
MW-4 cont.	3/11/2005	53.31	20.01	-	33.30	12,300	225	39.6	80.1	1465	3870
	6/15/2005	53.31	21.25	-	32.06	7,690	114	32.6	77.1	555	1150
	8/26/2005	53.31	22.03	-	31.28	8,850	175	24.6	150	851	1380
	11/11/2005	53.31	22.43	-	30.88	9,990	356	<43	196	700	3,640
	2/9/2006	53.31	20.31	-	33.00	6,850	205	<43	67.2	255.2	5,120
	5/9/2006	53.31	20.33	-	32.98	1,290	18.1	<8.6	12.9	25.87	799
	8/10/2006	53.31	21.74	-	31.57	7,830	118	<8.60	25.3	174.6	919
	10/26/2006	53.31	22.29	-	31.02	1,540	81.9	<43	96	46.4	3,610
	1/25/2007	53.31	21.86	-	31.45	4,370	163	<8.6	85.1	269.1	1,050
	4/26/2007	53.31	21.63	-	31.68	4,380	140	<8.6	67	276.8	576
	7/25/2007	53.31	22.49	-	30.82	4,970	220	<8.60	198	241.5	1,040
	10/23/2007	53.31	22.69	-	30.62	4,200	267	<8.6	147	155.5	1,220
	1/22/2008	53.36	21.39	-	31.97	2,180	133	<22.0	43.1	32.2	1,800
	4/15/2008	53.31	21.9	-	31.41	4,240	90.4	<22.0	107	380	674
	7/2/2008	53.31	22.55	-	30.76	2,300	193	<22.0	212	183	4,050
	10/16/2008	53.31	23.13	-	30.18	8,900	320	3.7	430	1,160	450
	1/8/2009	53.31	22.42	-	30.89	19,000	430	44	590	3,380	440
	4/13/2009	53.31	21.51	-	31.80	21,000	400	38	450	2,880	330
	8/27/2009	53.31	22.94	-	30.37	16,000	960	64	560	2,120	290
	12/2/2009	53.31	22.36	-	30.95	4,400	480	6	170	640	110
3/17/2010	53.31	21.39	-	31.92	14,000	260	6	230	1,220	93	
6/3/2010	53.31	22.23	-	31.08	18,000	240	4	310	770	41	
9/2/2010	53.31	22.51	-	30.80	1,800	800	<3.6	150	25	33	
12/2/2010	53.31	22.71	-	30.60	3,800	1,500	<10	200	115	29	

**Table 1**  
**Historical Groundwater Elevation Data and Analytical Results**  
15101 Freedom Avenue, San Leandro, CA

Monitoring Well	Date	Casing Elevation <sup>1</sup> (feet)	Depth to Groundwater (feet)	Free-Product (feet)/ Sheen (Y/N)	Groundwater Elevation (feet)	TPH-g (µg/L)	Benzene (µg/L)	Toluene (µg/L)	Ethyl-benzene (µg/L)	Total Xylenes (µg/L)	MtBE 8260B <sup>2</sup> (µg/L)
MW-4 cont.	3/3/2011	53.31	20.64	N	32.67	2,400	28	<0.71	28	17	3
	5/19/2011	53.31	21.84	N	31.47	1,800	27	<0.5	29	11.2	4.8
	9/8/2011	53.31	22.11	N	31.20	3,600	300	2.6	270	68.5	59
	12/1/2011	53.31	21.38	N	31.93	1,400 <sup>x</sup>	370	<0.84	110	30.6	110
	3/2/2012	53.31	22.02	N	31.29	3,100	780	<2.0	150	59.6	50
	6/7/2012	53.31	22.24	N	31.07	2,000	290	<2.5	66	23	29
	9/21/2012	53.31	22.87	N	30.44	2,900	820	<2.5	75	17	72
	12/14/2012	53.31	21.84	N	31.47	840	48	<0.5	14	4.5	2.5
	3/28/2013	53.31	22.24	N	31.07	790	650	<5.0	26	<5.0	15
	6/11/2013	53.31	22.71	N	30.60	1,100	860	<5.0	64	<5.0	35
	9/17/2013	53.31	23.23	N	30.08	<1,000	1,300	<10	22	<10	44
	12/6/2013	53.31	23.6	N	29.71	2,300	3,300	<10	78	199	42
	3/13/2014	53.31	22.6	N	30.71	<630	600	<6.3	7.0	21	6.8
	6/6/2014	53.31	22.97	N	30.34	<630	710	<6.3	21	<6.3	17.0
	9/23/2014	53.31	24.22	N	29.09	<630	1,100	<6.3	10	6.6	7.5
	12/23/2014	53.31	19.78	N	33.53	<50	0.95	<0.5	<0.5	<0.5	<0.5
	3/20/2015	53.31	21.75	N	31.56	56	1.8	<0.5	2.00	<0.5	8.7
	6/4/2015	53.31	22.29	N	31.02	210	35	<0.5	4.10	0.54	12
	9/11/2015	53.31	23.02	N	30.29	1,200	140	1.1	7.30	19	39
	12/29/2015	53.31	24.5	N	28.81	440	91	<0.5	0.84	0.74	17
3/23/2016	53.31	19.81	N	33.50	62	12	<0.5	<0.5	<0.5	7.4	
6/16/2016	53.31	19.84	N	33.47	120	18	0.75	0.53	<0.5	4.1	
<b>9/21/2016</b>	<b>53.31</b>	<b>22.72</b>		<b>N</b>	<b>30.59</b>	<b>620</b>	<b>87</b>	<b>&lt;0.5</b>	<b>5</b>	<b>9.90</b>	<b>35</b>
MW-5	5/10/2002	47.79	19.02	-	28.77	25,000	1,000	1200	1,100	3,060	1,800
	8/8/2002	47.79	19.80	-	27.99	18,000	1,000	660	950	1,720	1,500
	11/8/2002	47.79	20.14	-	27.65	16,000	1,300	380	930	1,550	1,200
	2/21/2003	47.79	18.70	-	29.09	12,000	390	71	770	1,100	860
	5/28/2003	47.79	18.52	-	29.27	9,100	210	31	560	790	600
	8/12/2003	47.79	19.54	-	28.25	12,000	660	75	660	1,110	1,000
	10/9/2003	47.79	20.06	-	27.73	15,000	1,000	130	1,000	1,430	1,700

**Table 1**  
**Historical Groundwater Elevation Data and Analytical Results**  
**15101 Freedom Avenue, San Leandro, CA**

Monitoring Well	Date	Casing Elevation <sup>1</sup> (feet)	Depth to Groundwater (feet)	Free-Product (feet)/ Sheen (Y/N)	Groundwater Elevation (feet)	TPH-g (µg/L)	Benzene (µg/L)	Toluene (µg/L)	Ethyl-benzene (µg/L)	Total Xylenes (µg/L)	MtBE 8260B <sup>2</sup> (µg/L)
MW-5 cont.	1/15/2004	47.79	18.42	-	29.37	9,900	450 C	16	500	431	1,100
	5/25/2004	47.79	19.30	-	28.49	9,200	380	24	490	536	720
	9/21/2004	50.53	20.15	-	30.38	10,000	980	71	560	770	1200
	12/14/2004	50.53	19.30	-	31.23	10,502	587	64	1040	1133	1015
	3/11/2005	50.53	17.20	-	33.33	8,390	407	<5.5	83	42.5	1530
	6/15/2005	50.53	18.54	-	31.99	9,350	147	18.3	435	146.2	573
	8/26/2005	50.53	19.31	-	31.22	9,500	261	<22	726	321.3	749
	11/11/2005	50.53	19.75	-	30.78	10,000	443	41.5	527	278.5	1,430
	2/9/2006	50.53	17.58	-	32.95	7,640	237	<22	187	50.2	2,050
	5/9/2006	50.53	17.54	-	32.99	8,360	111	<8.6	300	75.84	566
	8/10/2006	50.53	19.02	-	31.51	16,100	250	<22	455	187.4	1,590
	10/26/2006	50.53	19.61	-	30.92	10,100	430	<22	375	192.6	3,060
	1/25/2007	50.53	19.19	-	31.34	3,960	340	<22	323	150.1	1,740
	4/26/2007	50.53	18.89	-	31.64	4,590	187	<8.6	307	116.5	861
	7/25/2007	50.53	19.81	-	30.72	6,490	419	21.8	413	223.2	913
	10/23/2007	50.53	19.98	-	30.55	6,120	550	11	284	141.4	433
	1/22/2008	50.18	18.69	-	31.49	9,810	572	22	574	184.1	126
	4/15/2008	50.18	19.16	-	31.02	8,890	335	15.1	477	397.5	136
	7/3/2008	50.53	19.88	-	30.65	13,100	949	34.4	875	825.5	176
	10/16/2008	50.53	20.45	-	30.08	11,000	870	25	820	668	160
1/8/2009	50.53	19.72	-	30.81	12,000	490	21	690	456	76	
4/13/2009	50.53	18.81	-	31.72	9,000 <sup>Y</sup>	200	11	390	198	44	
8/27/2009	50.53	21.30	-	29.23	7,400	610	15	320	185	66	
12/2/2009	50.53	20.00	-	30.53	8,400 <sup>Y</sup>	400	12	540	296	45	

**Table 1**  
**Historical Groundwater Elevation Data and Analytical Results**  
15101 Freedom Avenue, San Leandro, CA

Monitoring Well	Date	Casing Elevation <sup>1</sup> (feet)	Depth to Groundwater (feet)	Free-Product (feet)/ Sheen (Y/N)	Groundwater Elevation (feet)	TPH-g (µg/L)	Benzene (µg/L)	Toluene (µg/L)	Ethyl- benzene (µg/L)	Total Xylenes (µg/L)	MtBE 8260B <sup>2</sup> (µg/L)
MW-5 cont.	3/17/2010	50.53	18.73	-	31.80	4,800	120	8.7	120	107	14
	6/4/2010	50.53	19.60	-	30.93	7,200	160	5.7	190	149.2	24
Pre-MPE	9/2/2010	50.53	19.82	-	30.71	9,200	110	12	270	318	35
	12/2/2010	50.53	20.10	-	30.43	9,100	170	6.7	350	442	23
	3/4/2011	50.53	18.00	N	32.53	2,600	18	0.62	54	18.1	3
	5/20/2011	50.53	19.18	N	31.35	4,000	91	8.5	110	106	33
	8/4/2011	50.53	NM	-	NC	3,000	23	0.95	92	43.7	5.4
	9/9/2011	50.53	19.41	N	31.12	4,200	120	2.8	140	61.1	22
	12/2/2011	50.53	18.59	N	31.94	6,900 <sup>x</sup>	96	12	220	104	32
	3/2/2012	50.53	19.30	N	31.23	5,400	43	1.8	110	85	7
	6/7/2012	50.53	19.45	N	31.08	3,700	32	<1.0	100	59	4.4
	9/21/2012	50.53	20.17	N	30.36	3,900	68	1.5	140	88.5	9.8
	12/14/2012	50.53	19.12	N	31.41	3,100	48	6.7	100	62.3	5.2
	3/28/2013	50.53	19.47	N	31.06	1,900	30	<1.0	59	48.4	4.5
	6/11/2013	50.53	20.03	N	30.50	2,900	22	3.9	110	131	3.0
	9/17/2013	50.53	20.54	N	29.99	4,200	55	7.9	180	229	5.2
	12/6/2013	50.53	20.86	N	29.67	3,600	35	2.1	160	241	2.5
	3/13/2014	50.53	19.91	N	30.62	2,100	23	<1.0	130	73	1.4
	6/6/2014	50.53	20.27	N	30.26	1,700	8.2	0.56	63	40.2	0.75
	9/23/2014	50.53	21.61	N	28.92	1,700	38	0.52	45	29.8	1.60
	12/23/2014	50.53	17.12	N	33.41	<50	<0.5	<0.5	<0.5	<0.5	<0.5
	3/20/2015	50.53	18.91	N	31.62	130	<0.5	<0.5	4.5	3.4	<0.5
6/4/2015	50.53	19.49	N	31.04	340	0.7	<0.5	4	3.7	<0.5	
9/11/2015	50.53	20.29	N	30.24	1,300	3.1	<0.5	13	13	<0.5	
12/29/2015	50.53	19.89	N	30.64	260	1.5	<0.5	1.1	0.89	<0.5	
3/23/2016	50.53	17.07	N	33.46	300	<0.5	<0.5	<0.5	<0.5	<0.5	
6/16/2016	50.53	17.10	N	33.43	520	0.68	<0.5	<0.5	<0.5	<0.5	
<b>9/21/2016</b>	<b>50.53</b>	<b>19.97</b>	<b>N</b>	<b>30.56</b>	<b>590</b>	<b>0.73</b>	<b>&lt;0.5</b>	<b>&lt;0.5</b>	<b>&lt;0.5</b>	<b>&lt;0.5</b>	<b>1.90</b>
<b>MW-6</b>	9/21/2004	45.82	17.64	-	28.18	34,000	150	130	2200	8100	0.6
	12/14/2004	45.82	15.75	-	30.07	5,161	137	7	436	1136	<5.5

**Table 1**  
**Historical Groundwater Elevation Data and Analytical Results**  
15101 Freedom Avenue, San Leandro, CA

Monitoring Well	Date	Casing Elevation <sup>1</sup> (feet)	Depth to Groundwater (feet)	Free-Product (feet)/ Sheen (Y/N)	Groundwater Elevation (feet)	TPH-g (µg/L)	Benzene (µg/L)	Toluene (µg/L)	Ethyl-benzene (µg/L)	Total Xylenes (µg/L)	MtBE 8260B <sup>2</sup> (µg/L)
MW-6 cont.	3/11/2005	45.82	13.80	-	32.02	6,040	125	3.22	260	722.1	4.94
	6/15/2005	45.82	14.78	-	31.04	5,590	44.3	6.60	272	382	5.85
	8/26/2005	45.82	15.91	-	29.91	6,130	99	<8.6	378	492.9	5.66
	11/11/2005	45.82	16.55	-	29.27	11,400	101	<8.6	645	834.7	4.33
	2/9/2006	45.82	13.92	-	31.90	2,790	32.3	<8.6	131	131.22	7.30
	5/9/2006	45.82	13.95	-	31.87	3,730	25	<2.0	213	207.82	5.87
	8/10/2006	45.82	15.28	-	30.54	4,800	41.9	<2.0	201	189	10.4
	10/26/2006	45.82	16.11	-	29.71	6,080	37.4	<2.0	116	183	9.78
	1/25/2007	45.82	15.76	-	30.06	3,220	25.2	<2.0	219	174	14.7
	4/26/2007	45.82	15.18	-	30.64	3,110	28	<2.0	165	138.47	14.6
	7/25/2007	45.82	16.82	-	29.00	4,960	54.1	<2.0	199	255.87	8.05
	10/23/2007	45.82	16.91	-	28.91	9,610	64.3	<2.0	188	302.6	5.81
	1/21/2008	45.82	15.36	-	30.46	3,290	33	<2.0	149	131.31	3.86
	4/15/2008	45.82	15.73	-	30.09	2,070	10.8	<2.0	51.1	67	<0.5
	7/2/2008	45.82	16.9	-	28.92	7,900	42.4	<2.0	194	296	3.58
	10/15/2008	45.82	17.21	-	28.61	18,000 <sup>Y</sup>	42	1.4	320	673	1.7
	1/7/2009	45.82	17.08	-	28.74	13,000	47	<3.1	210	425	<3.1
	4/13/2009	45.82	15.52	-	30.30	7,200 <sup>Y</sup>	26	<1.3	170	312.6	2.6
	8/26/2009	45.82	17.82	-	28.00	10,000 <sup>Y</sup>	25	<2.0	130	294	2.2
	12/1/2009	45.82	17.34	-	28.48	11,000 <sup>Y</sup>	31	6.1	220	539	<2.0
3/16/2010	45.82	14.81	-	31.01	31,000	63	140	970	4,200	64	
6/3/2010	45.82	15.72	-	30.10	27,000	22	67	840	3,100	32	
9/1/2010	45.82	16.86	-	28.96	33,000	24	34	1,100	3,780	12	
12/2/2010	45.82	16.98	-	28.84	70,000	32	55	1,700	5,670	18	

**Table 1**  
**Historical Groundwater Elevation Data and Analytical Results**  
15101 Freedom Avenue, San Leandro, CA

Monitoring Well	Date	Casing Elevation <sup>1</sup> (feet)	Depth to Groundwater (feet)	Free-Product (feet)/ Sheen (Y/N)	Groundwater Elevation (feet)	TPH-g (µg/L)	Benzene (µg/L)	Toluene (µg/L)	Ethyl-benzene (µg/L)	Total Xylenes (µg/L)	MtBE 8260B <sup>2</sup> (µg/L)
MW-6 cont.	3/3/2011	45.82	14.35	Y	31.47	7,000	18	<2.5	97	237	11
	5/20/2011	45.82	14.95	Y	30.87	14,000	14	<2.5	300	823	7.2
	9/8/2011	45.82	16.14	Y	29.68	23,000	28	<2.5	360	812	3.4
	12/1/2011	45.82	16.17	16.15	29.66	FP	FP	FP	FP	FP	FP
	3/2/2012	45.82	16.11	Y	29.71	14,000	23	<4.2	400	694.4	<4.2
	6/6/2012	45.82	16.31	Y	29.51	9,200	12	<1.7	210	320	<1.7
	9/20/2012*	45.82	17.36	17.32	28.49	FP	FP	FP	FP	FP	FP
	12/13/2012	45.82	15.46	Y	30.36	13,000	22	<0.71	83	62.8	5.1
	3/27/2013	45.82	16.3	Y	29.52	7,400	27	<1.3	190	221.8	<1.3
	6/10/2013	45.82	17.37	Y	28.45	12,000	20	<2.5	280	230	<2.5
	9/16/2013	45.82	18.11	18.06	27.74	FP	FP	FP	FP	FP	FP
	12/5/2013	45.82	18.75	Y	27.07	18,000	220	330	460	2,030	6.1
	3/12/2014	45.82	17	Y	28.82	8,900	42	5.4	290	760	<2.5
	6/5/2014	45.82	18.15	Y	27.67	9,600	29	<2.5	370	295	<2.5
	9/22/2014	45.82	19.33	Y	26.49	31,000	140	140	1,600	3,590	4.3
	12/22/2014	45.82	13.43	Y	32.39	2,700	20	<0.5	70	55.4	0.63
	3/19/2015	45.82	16.1	N	29.72	2,900	8.2	<0.5	48	3.6	<0.5
	6/3/2015	45.82	17.21	N	28.61	4,600	13	<0.5	53	3.4	<0.5
	9/10/2015	45.82	18.25	N	27.57	4,200	8.8	<5.0	27	<5.0	<5.0
	12/28/2015	45.82	16.64	N	29.18	4,600	27	<1.0	160	24	<1.0
3/24/2016	45.82	14.35	N	31.47	700	3.4	<0.5	4.4	2.64	<0.5	
6/16/2016	45.82	14.38	N	31.44	2,900	9.7	<0.5	18	17	<0.5	
<b>9/21/2016</b>	<b>45.82</b>	<b>17.57</b>	<b>N</b>	<b>28.25</b>	<b>2,600</b>	<b>8.5</b>	<b>&lt;1.0</b>	<b>1.9</b>	<b>&lt;1.0</b>	<b>&lt;1.0</b>	
MW-7	9/21/2004	44.74	15.21	-	29.53	2,900	<0.5	<0.5	52	61	8.1
	12/14/2004	44.74	13.90	-	30.84	<50	1.6	<0.5	29	58	6.0
	3/11/2005	44.74	11.46	-	33.28	2,230	<2.5	<2.5	39.4	51.4	12.4
	6/15/2005	44.74	12.97	-	31.77	2,940	0.85	<2.0	50.6	31.9	13.7
	8/26/2005	44.74	14.10	-	30.64	2,310	<0.50	<2.0	55.7	29.6	4.01
	11/11/2005	44.74	14.59	-	30.15	3,030	<0.5	<2.0	66.5	42.3	9.76

**Table 1**  
**Historical Groundwater Elevation Data and Analytical Results**  
15101 Freedom Avenue, San Leandro, CA

Monitoring Well	Date	Casing Elevation <sup>1</sup> (feet)	Depth to Groundwater (feet)	Free-Product (feet)/ Sheen (Y/N)	Groundwater Elevation (feet)	TPH-g (µg/L)	Benzene (µg/L)	Toluene (µg/L)	Ethyl-benzene (µg/L)	Total Xylenes (µg/L)	MtBE 8260B <sup>2</sup> (µg/L)
MW-7 cont.	2/9/2006	44.74	NM	-	NM	NA	NA	NA	NA	NA	NA
	5/9/2006	44.74	12.02	-	32.72	1,400	<0.5	<2.0	19.8	12.4	2.30
	8/10/2006	44.74	13.72	-	31.02	604	<0.50	<2.0	6.2	4.63	1.42
	10/26/2006	44.74	14.38	-	30.36	1350	<0.50	<2.0	16.6	10.8	1.87
	1/25/2007	44.74	13.93	-	30.81	340	<0.5	<2.0	6.84	2.44	1.63
	4/26/2007	44.74	14.44	-	30.30	552	<0.5	<2.0	11.4	6.11	4.12
	7/25/2007	44.74	14.79	-	29.95	1,230	<0.5	<2.0	27	19.24	3.2
	10/23/2007	44.74	14.88	-	29.86	1,730	0.67	<2.0	20.7	17.31	8.44
	1/21/2008	44.74	13.34	-	31.40	610	1.15	<2.0	8.4	4.34	17.2
	4/15/2008	44.74	13.91	-	30.83	1,460	<0.5	<2.0	15.9	19.7	17.3
	7/2/2008	44.74	14.87	-	29.87	1,450	<0.5	<2.0	11	6.8	22.1
	10/15/2008	44.74	15.68	-	29.06	1,900 <sup>Y</sup>	0.56	1.2	27	39.5	55
	1/7/2009	44.74	14.72	-	30.02	2,700	1.2	2.9	11	25	39
	4/13/2009	44.74	13.54	-	31.20	2,300 <sup>Y</sup>	<0.5	<0.5	15	6.3	63
	8/26/2009	44.74	15.84	-	28.90	2,700 <sup>Y</sup>	<0.5	<0.5	48	53	140
	12/1/2009	44.74	15.03	-	29.71	1,800 <sup>Y</sup>	<0.5	<0.5	22	15	120
	3/16/2010	44.74	12.56	-	32.18	1,100	<0.5	<0.5	3.2	1.4	65
	6/3/2010	44.74	13.80	-	30.94	740	<0.5	<0.5	1.8	0.62	28
	9/1/2010	44.74	14.84	-	29.90	1,200	<0.5	<0.5	10	3.2	29
	12/2/2010	44.74	14.74	-	30.00	1,400	<0.5	<0.5	8	0.74	21
	3/3/2011	44.74	13.31	-	31.43	1,000	<0.5	<0.5	1.8	<0.5	16
	5/19/2011	44.74	13.43	N	31.31	810	<0.5	<0.5	2.2	0.79	7.8
	9/8/2011	44.74	14.38	N	30.36	1,000	<0.5	<0.5	8.3	2.9	5.4
12/1/2011	44.74	13.57	N	31.17	1,500 <sup>x</sup>	<0.33	<0.19	12	5.7	13	
3/2/2012	44.74	14.16	N	30.58	1,000	<0.5	<0.5	4	1.1	5.1	
6/6/2012	44.74	14.00	N	30.74	780	<0.5	<0.5	2.9	1.0	2.6	
9/20/2012	44.74	15.26	N	29.48	1,200	<0.5	<0.5	4.3	0.92	2.7	
12/13/2012	44.74	13.34	N	31.40	1,100	<0.5	<0.5	0.99	<0.5	3.4	



**Table 1**  
**Historical Groundwater Elevation Data and Analytical Results**  
15101 Freedom Avenue, San Leandro, CA

Monitoring Well	Date	Casing Elevation <sup>1</sup> (feet)	Depth to Groundwater (feet)	Free-Product (feet)/ Sheen (Y/N)	Groundwater Elevation (feet)	TPH-g (µg/L)	Benzene (µg/L)	Toluene (µg/L)	Ethyl-benzene (µg/L)	Total Xylenes (µg/L)	MtBE 8260B <sup>2</sup> (µg/L)
MW-7 cont.	3/27/2013	44.74	14.30	N	30.44	680	<0.5	<0.5	1.8	<0.5	4.2
	6/10/2013	44.74	15.06	N	29.68	890	<0.5	<0.5	2.6	<0.5	2.3
	9/16/2013	44.74	15.78	N	28.96	1,400	<0.5	<0.5	7.9	2.7	4.1
	12/5/2013	44.74	16.21	N	28.53	1,800	<0.5	<0.5	8	3.1	5.7
	3/12/2014	44.74	14.56	N	30.18	920	<0.5	<0.5	3.7	1.5	4.6
	6/5/2014	44.74	15.18	N	29.56	1,600	<0.5	<0.5	11	3.0	5.7
	9/22/2014	44.74	16.63	N	28.11	1,900	<0.5	<0.5	9.6	3.5	5.3
	12/22/2014	44.74	11.37	N	33.37	320	<0.5	<0.5	2.2	2.3	1.7
	3/19/2015	44.74	13.82	N	30.92	1,400	<0.5	<0.5	4.6	2.0	4.7
	6/3/2015	44.74	14.53	N	30.21	2,000	<0.5	<0.5	12	5.4	4.4
	9/10/2015	44.74	15.62	N	29.12	2,200	<1.7	<1.7	9.9	1.7	4.0
	12/28/2015	44.74	14.75	N	29.99	2,500	<0.5	<0.5	5.2	4.0	3.1
	3/24/2016	44.74	11.46	N	33.28	1,800	<0.5	<0.5	1.7	<0.5	3.1
	6/16/2016	44.74	11.49	N	33.25	2,400	<0.5	<0.5	2.3	<0.5	1.4
	<b>9/21/2016</b>	<b>44.74</b>	<b>16.32</b>	<b>N</b>	<b>28.42</b>	<b>2,000</b>	<b>1.9</b>	<b>0.63</b>	<b>11</b>	<b>12.1</b>	<b>&lt;0.5</b>
	MW-8	9/21/2004	41.14	12.98	-	28.16	<50	<0.5	<0.5	<0.5	<0.5
12/14/2004		41.14	11.22	-	29.92	<50	<0.5	<0.5	<0.5	<1.0	<0.5
3/11/2005		41.14	NM	-	NM	NA	NA	NA	NA	NA	NA
6/15/2005		41.14	10.46	-	30.68	<200	0.53	<2.0	<0.5	<1.0	<0.5
8/26/2005		41.14	11.53	-	29.61	<50	<0.50	<2.0	<0.50	<1.0	<0.50
11/11/2005		41.14	11.92	-	29.22	<50	<0.5	<2.0	1.36	1.8	<0.5
2/9/2006		41.14	9.74	-	31.40	<50	<0.50	<2.0	<0.50	<1.0	<0.50
5/9/2006		41.14	9.90	-	31.24	<50	<0.50	<2.0	<0.50	<1.0	<0.50
8/10/2006		41.14	10.9	-	30.24	<50	<0.50	<2.0	<0.50	<1.0	<0.50
10/26/2006		41.14	11.68	-	29.46	<50	<0.50	<2.0	3.37	<1.0	<0.50
1/25/2007		41.14	11.44	-	29.70	<50	<0.5	<2.0	<0.5	<2.0	<0.5
4/26/2007		41.14	10.81	-	30.33	<50	<0.5	<2.0	4.29	<2.0	<0.5
7/25/2007		41.14	12.31	-	28.83	<50	<0.5	<2.0	4.39	<2.0	<0.5
10/23/2007	41.14	12.37	-	28.77	<50	<0.5	<2.0	4.31	<2.0	<0.5	

**Table 1**  
**Historical Groundwater Elevation Data and Analytical Results**  
 15101 Freedom Avenue, San Leandro, CA

Monitoring Well	Date	Casing Elevation <sup>1</sup> (feet)	Depth to Groundwater (feet)	Free-Product (feet)/ Sheen (Y/N)	Groundwater Elevation (feet)	TPH-g (µg/L)	Benzene (µg/L)	Toluene (µg/L)	Ethyl- benzene (µg/L)	Total Xylenes (µg/L)	MtBE 8260B <sup>2</sup> (µg/L)
MW-8 cont.	1/21/2008	41.14	11.02	-	30.12	<50	<0.5	<2.0	<0.5	<2.0	<0.5
	4/15/2008	41.14	11.44	-	29.70	<50	<0.5	<2.0	<0.5	<2.0	<0.5
	7/2/2008	41.14	12.39	-	28.75	94.8	<0.5	<2.0	1	<2.0	<0.5
	10/15/2008	41.14	13.42	-	27.72	<50	<0.5	<0.5	<0.5	<0.5	<0.5
	1/7/2009	41.14	12.50	-	28.64	<50	<0.5	<0.5	<0.5	0.6	<0.5
	4/13/2009	41.14	11.23	-	29.91	<50	<0.5	<0.5	<0.5	<0.5	<0.5
	8/27/2009	41.14	13.24	-	27.90	<50	<0.5	<0.5	<0.5	<0.5	<0.5
<b>Well Decommissioned 11/13/2009</b>											
MW-9	9/21/2004	40.26	12.18	-	28.08	<50	<0.5	<0.5	<0.5	<0.5	<0.5
	12/14/2004	40.26	10.91	-	29.35	<50	<0.5	<0.5	<0.5	<1.0	<0.5
	3/11/2005	40.26	10.52	-	29.74	<200	<0.5	<0.5	<0.5	<1.0	<0.5
	6/15/2005	40.26	14.73	-	25.53	<200	<0.5	<2.0	<0.5	<1.0	<0.5
	8/26/2005	40.26	10.59	-	29.67	<50	<0.50	<2.0	<0.50	<1.0	<0.50
	11/11/2005	40.26	11.25	-	29.01	<50	<0.5	<2.0	<0.5	<1.0	<0.5
	2/9/2006	40.26	10.05	-	30.21	<50	<0.50	<2.0	<0.50	<1.0	<0.50
	5/9/2006	40.26	9.06	-	31.20	<50	<0.50	<2.0	<0.50	<1.0	<0.50
	8/10/2006	40.26	10.01	-	30.25	<50	<0.50	<2.0	<0.50	<1.0	<0.50
	10/26/2006	40.26	10.81	-	29.45	<50	<0.50	<2.0	<0.50	<1.0	<0.50
	1/25/2007	40.26	10.67	-	29.59	<50	<0.5	<2.0	<0.5	<2.0	<0.5
	4/26/2007	40.26	10.05	-	30.21	<50	<0.5	<2.0	<0.5	<2.0	<0.5
	7/25/2007	40.26	11.44	-	28.82	<50	<0.5	<2.0	<0.5	<2.0	<0.5
	10/23/2007	40.26	11.59	-	28.67	<50	<0.5	<2.0	<0.5	<2.0	<0.5
	1/21/2008	40.26	10.37	-	29.89	<50	<0.5	<2.0	<0.5	<2.0	<0.5
4/15/2008	40.26	10.56	-	29.70	<50	<0.5	<2.0	<0.5	<2.0	<0.5	
7/2/2008	40.26	11.95	-	28.31	161	<0.5	<2.0	2.15	<2.0	<0.5	
10/15/2008	40.26	12.64	-	27.62	<50	<0.5	<0.5	<0.5	<0.5	<0.5	

**Table 1**  
**Historical Groundwater Elevation Data and Analytical Results**  
 15101 Freedom Avenue, San Leandro, CA

Monitoring Well	Date	Casing Elevation <sup>1</sup> (feet)	Depth to Groundwater (feet)	Free-Product (feet)/ Sheen (Y/N)	Groundwater Elevation (feet)	TPH-g (µg/L)	Benzene (µg/L)	Toluene (µg/L)	Ethyl- benzene (µg/L)	Total Xylenes (µg/L)	MtBE 8260B <sup>2</sup> (µg/L)
MW-9 cont.	1/7/2009	40.26	11.75	-	28.51	<50	<0.5	<0.5	<0.5	<0.5	<0.5
	4/13/2009	40.26	10.89	-	29.37	<50	<0.5	<0.5	<0.5	<0.5	<0.5
	8/26/2009	40.26	12.50	-	27.76	<50	<0.5	<0.5	<0.5	<0.5	<0.5
<b>Well Decommissioned 11/13/2009</b>											
MW-10	9/22/2014	44.66	17.84	N	26.82	23,000	<10	<10	1200	2,610	<10
	12/22/2014	44.66	12.33	N	32.33	6,000	<2.5	<2.5	390	802	<2.5
	3/19/2015	44.66	15.01	N	29.65	3,500	<1.0	<1.0	130	279	<1.0
	6/3/2015	44.66	15.81	N	28.85	24,000	<5.0	<5.0	870	1,358	<5.0
	9/10/2015	44.66	17.03	N	27.63	28,000	<10	<10	1,200	2,173	<10
	12/28/2015	44.66	15.18	N	29.48	22,000	<10	<10	930	1,737	<10
MW-10R Post MPE	3/24/2016	44.66	13.1	N	31.56	22,000	<5	<5	620	1,038	<5
	6/15/2016	45.13	13.6	N	31.53	28,000	<10	<10	720	1,454	<10
	<b>8/8/2016</b>	<b>45.13</b>	<b>NA</b>	<b>N</b>	<b>NA</b>	<b>8,100</b>	<b>&lt;4.2</b>	<b>&lt;4.2</b>	<b>150</b>	<b>267.1</b>	<b>&lt;4.2</b>
	<b>9/21/2016</b>	<b>45.13</b>	<b>16.84</b>	<b>N</b>	<b>28.29</b>	<b>10,000</b>	<b>9.6</b>	<b>&lt;2.0</b>	<b>340</b>	<b>432</b>	<b>&lt;2.0</b>
MW-11	9/22/2014	42.45	15.52	N	26.93	2,100	<0.5	<0.5	2.7	4.5	<0.5
	12/22/2014	42.45	10.08	N	32.37	310	<0.5	<0.5	1.8	2.7	<0.5
	3/19/2015	42.45	12.77	N	29.68	870	<0.5	<0.5	1.4	2.2	<0.5
	6/3/2015	42.45	13.5	N	28.95	330	<0.5	<0.5	2.0	3.1	<0.5
	9/10/2015	42.45	14.79	N	27.66	78	<0.5	<0.5	<0.5	<0.5	<0.5
	12/28/2015	42.45	13.07	N	29.38	170	<0.5	<0.5	3.0	4.2	<0.5
	3/23/2016	42.45	10.48	N	31.97	110	<0.5	<0.5	<0.5	<0.5	<0.5
	6/16/2016	42.45	10.51	N	31.94	100	<0.5	<0.5	<0.5	<0.5	<0.5
	<b>9/21/2016</b>	<b>42.45</b>	<b>14.05</b>	<b>N</b>	<b>28.40</b>	<b>75</b>	<b>&lt;0.5</b>	<b>&lt;0.5</b>	<b>1.5</b>	<b>1.7</b>	<b>&lt;0.5</b>
<b>Extraction Wells</b>											
EX-1	12/2/2009	47.36	17.02	-	30.34	2,900	120	4	64	410	25
	3/16/2010	47.36	19.08	-	28.28	2,200	150	18	94	326	210
	6/3/2010	47.36	17.02	-	30.34	3,600	180	6.3	150	428	83
	9/1/2010	47.36	16.88	-	30.48	550	6.5	0.5	6.9	31.7	38
	12/2/2010	47.36	19.84	-	27.52	<200	3.1	<2.0	<2.0	<2.0	210

**Table 1**  
**Historical Groundwater Elevation Data and Analytical Results**  
15101 Freedom Avenue, San Leandro, CA

Monitoring Well	Date	Casing Elevation <sup>1</sup> (feet)	Depth to Groundwater (feet)	Free-Product (feet)/ Sheen (Y/N)	Groundwater Elevation (feet)	TPH-g (µg/L)	Benzene (µg/L)	Toluene (µg/L)	Ethyl- benzene (µg/L)	Total Xylenes (µg/L)	MtBE 8260B <sup>2</sup> (µg/L)
EX-1 cont.	3/3/2011	47.36	14.96	N	32.4	530	51	0.94	15	31.3	110
	5/19/2011	47.36	16.12	N	31.24	370	42	<0.71	7.6	17.2	110
	9/8/2011	47.36	16.47	N	30.89	110	5	<0.5	2.2	6.4	12
	12/1/2011	47.36	16.1	N	31.26	780 <sup>x</sup>	91	3	29	85	150
	3/2/2012	47.36	16.35	N	31.01	140	6	<0.5	3.5	8	14
	6/6/2012	47.36	24.76	N	22.6	250	22	<0.5	4.7	20	71
	9/20/2012	47.36	17.26	N	30.1	95	24	<0.5	<0.5	2.61	36
	12/13/2012	47.36	16.55	N	30.81	1,000	73	2.3	47	110	48
	3/27/2013	47.36	16.15	N	31.21	69	4.1	<0.5	3.3	10	1.8
	6/10/2013	47.36	24.25	N	23.11	340	37	<0.5	5.9	15.1	62
	9/16/2013	47.36	22.54	N	24.82	97	14	<0.5	<0.5	<0.5	65
	12/5/2013	47.36	22.53	N	24.83	390	42	2.5	9.8	32.6	76
	3/12/2014	47.36	21.15	N	26.21	250	12	<0.5	4.7	17.2	40
	6/5/2014	47.36	21.31	N	26.05	1,700	70	11	92	208	40
	9/22/2014	47.36	21.15	N	26.21	1,500	23	1.3	73	161	51
	12/22/2014	47.36	19.74	N	27.62	530	8.6	<0.5	3.2	29.3	11
	3/19/2015	47.36	15.59	N	31.77	<50	1.2	<0.5	<0.5	1.0	<0.5
	6/3/2015	47.36	22.89	N	24.47	770	31	<0.5	8.2	17.1	22
	9/10/2015	47.36	22.57	N	24.79	<50	0.66	<0.5	<0.5	1.53	<0.5
	12/28/2015	47.36	22.7	N	24.66	400	27	<0.5	4.6	10.9	21
3/24/2016	47.36	13.45	N	33.91	57	3.9	<0.5	<0.5	<0.5	3.5	
6/15/2016	47.36	13.83	N	33.53	140	9.1	<0.5	<0.5	<0.5	<0.5	
<b>9/21/2016</b>	<b>47.36</b>	<b>16.75</b>	<b>N</b>	<b>30.61</b>	<b>260</b>	<b>1.2</b>	<b>&lt;0.5</b>	<b>5.3</b>	<b>1.7</b>	<b>&lt;0.5</b>	
EX-2	12/2/2009	45.96	17.56	-	28.4	7,100 <sup>y</sup>	9.3	3.2	440	770	<3.1
	3/16/2010	45.96	19.65	-	26.31	13,000	600	360	770	2,250	15
	6/3/2010	45.96	17.10	-	28.86	16,000	590	400	700	2,500	9.5
	9/1/2010	45.96	16.99	-	28.97	6,100	230	74	200	890	11
	12/2/2010	45.96	20.87	-	25.09	14,000	510	270	640	2,170	15

**Table 1**  
**Historical Groundwater Elevation Data and Analytical Results**  
 15101 Freedom Avenue, San Leandro, CA

Monitoring Well	Date	Casing Elevation <sup>1</sup> (feet)	Depth to Groundwater (feet)	Free-Product (feet)/ Sheen (Y/N)	Groundwater Elevation (feet)	TPH-g (µg/L)	Benzene (µg/L)	Toluene (µg/L)	Ethyl-benzene (µg/L)	Total Xylenes (µg/L)	MtBE 8260B <sup>2</sup> (µg/L)
EX-2 cont.	3/3/2011	45.96	14.61	N	31.35	8,600	340	52	460	1,350	13
	5/19/2011	45.96	15.08	N	30.88	7,500	260	65	390	1,080	11
	9/8/2011	45.96	16.34	N	29.62	3,400	190	28	160	451	5.4
	12/1/2011	45.96	22.60	N	23.36	9,900 <sup>x</sup>	630	200	690	1,760	<3.3
	3/2/2012	45.96	16.48	N	29.48	5,000	220	25	200	600	7.1
	6/6/2012	45.96	18.90	N	27.06	6,900	290	97	310	790	5.2
	9/20/2012	45.96	17.49	N	28.47	1,800	170	14	62	204	5.0
	12/13/2012	45.96	15.96	N	30	7,300	490	180	610	1,290	5.2
	3/27/2013	45.96	16.59	N	29.37	2,200	130	9.6	100	288	4.3
	6/10/2013	45.96	23.11	N	22.85	2,600	190	20	100	248	6.8
	9/20/2013	45.96	23.11	N	22.85	3,900	210	37	170	450	6.3
	12/5/2013	45.96	23.28	N	22.68	3,700	160	46	110	394	7.2
	3/12/2014	45.96	22.04	N	23.92	3,700	100	9.8	220	498	5.7
	6/5/2014	45.96	23.41	N	22.55	4,400	120	37	280	590	5.4
	9/22/2014	45.96	23.20	N	22.76	2,200	63	8.8	88	240	7.1
	12/22/2014	45.96	20.22	N	25.74	1,600	42	4.2	94	148	6.0
	3/19/2015	45.96	16.46	N	29.50	890	42	<0.5	54	10.5	<0.5
	6/3/2015	45.96	21.06	N	24.90	4,700	100	8.7	120	311	1.9
	9/10/2015	45.96	21.15	N	24.81	670	8.1	<1.0	13	27.4	<1.0
12/28/2015	45.96	20.75	N	25.21	3,500	46	6	120	266	4.5	
3/24/2016	45.96	13.97	N	31.99	1,500	22	0.86	42	75	1.7	
6/15/2016	45.96	14.00	-	31.96	NA	NA	NA	NA	NA	NA	
<b>MPE Wells</b>											
MPE-1	12/1/2009	51.96	21.41	-	30.55	NA	NA	NA	NA	NA	NA
	3/16/2010	51.96	20.22	-	31.74	NA	NA	NA	NA	NA	NA
	6/3/2010	51.96	21.18	-	30.78	NA	NA	NA	NA	NA	NA
	9/1/2010	51.96	21.25	-	30.71	NA	NA	NA	NA	NA	NA
	12/2/2010	51.96	21.64	-	30.32	NA	NA	NA	NA	NA	NA

**Table 1**  
**Historical Groundwater Elevation Data and Analytical Results**  
**15101 Freedom Avenue, San Leandro, CA**

Monitoring Well	Date	Casing Elevation <sup>1</sup> (feet)	Depth to Groundwater (feet)	Free-Product (feet)/ Sheen (Y/N)	Groundwater Elevation (feet)	TPH-g (µg/L)	Benzene (µg/L)	Toluene (µg/L)	Ethyl- benzene (µg/L)	Total Xylenes (µg/L)	MtBE 8260B <sup>2</sup> (µg/L)	
MPE-1 cont.	3/3/2011	51.96	19.33	-	32.63	NA	NA	NA	NA	NA	NA	
	5/19/2011	51.96	20.6	-	31.36	NA	NA	NA	NA	NA	NA	
	Pre-MPE	8/4/2011	51.96	NM	-	NC	49,000	210	100	840	7,070	45
		9/8/2011	51.96	20.83	-	31.13	NA	NA	NA	NA	NA	NA
	Post-MPE	9/26/2011	51.96	20.94	Y	31.02	62,000	6,300	3,700	1,800	9,400	1,200
		12/2/2011	51.96	20.14	Y	31.82	56,000	9,000	7,700	2,200	10,800	2,600
		3/2/2012	51.96	20.73	Y	31.23	97,000	11,000	11,000	2,600	12,600	2,700
		6/6/2012	51.96	20.96	Y	31.00	78,000	4,500	4,900	2,300	10,700	750
		9/20/2012	51.96	21.58	Y	30.38	89,000	8,600	9,200	3,400	14,800	1,900
		12/14/2012	51.96	20.57	Y	31.39	98,000	7,400	9,600	2,900	13,300	1,300
		3/27/2013	51.96	20.91	Y	31.05	61,000	6,600	4,500	2,200	9,400	1,500
		6/10/2013	51.96	21.47	Y	30.49	42,000	1,900	980	630	4,400	670
		9/17/2013	51.96	21.98	Y	29.98	45,000	2,400	1,400	1,200	8,000	150
		12/6/2013	51.96	22.41	Y	29.55	27,000	1,600	220	990	5,000	110
	3/13/2014	51.96	21.33	Y	30.63	67,000	1,800	3,500	1,800	10,100	170	
		6/5/2014	51.96	21.89	21.8	30.13	FP	FP	FP	FP	FP	FP
		9/23/2014	51.96	23.12	Y	28.84	12,000	380	31	100	1,630	39
		12/23/2014	51.96	18.3	Y	33.66	3,100	23	24	23	220	<1.0
	3/20/2015	51.96	20.14	Y	31.82	9,700	58	43	77	1,000	<2.5	
		6/4/2015	51.96	21.00	Y	30.96	14,000	110	49	66	620	10
9/11/2015		51.96	21.77	Y	30.19	9,600	590	150	83	590	50	
12/29/2015		51.96	21.13	Y	30.83	3,100	24	11	8.2	237	0.88	
3/24/2016	51.96	18.22	N	33.74	98	<0.5	<0.5	<0.5	0.79	<0.5		
6/16/2016	51.96	18.45	Y	33.51	310	8.6	<0.5	1.2	16.10	0.68		
<b>9/21/2016</b>	<b>51.96</b>	<b>21.31</b>	<b>N</b>	<b>30.65</b>	<b>1,200</b>	<b>35</b>	<b>&lt;0.5</b>	<b>3.2</b>	<b>6.10</b>	<b>1.50</b>		
MPE-2	12/1/2009	53.72	22.87	-	30.85	NA	NA	NA	NA	NA	NA	
	3/16/2010	53.72	21.7	-	32.02	NA	NA	NA	NA	NA	NA	
	6/3/2010	53.72	22.35	-	31.37	NA	NA	NA	NA	NA	NA	
	9/1/2010	53.72	23.7	-	30.02	NA	NA	NA	NA	NA	NA	
	12/2/2010	53.72	22.7	-	31.02	NA	NA	NA	NA	NA	NA	

**Table 1**  
**Historical Groundwater Elevation Data and Analytical Results**  
**15101 Freedom Avenue, San Leandro, CA**

Monitoring Well	Date	Casing Elevation <sup>1</sup> (feet)	Depth to Groundwater (feet)	Free-Product (feet)/ Sheen (Y/N)	Groundwater Elevation (feet)	TPH-g (µg/L)	Benzene (µg/L)	Toluene (µg/L)	Ethyl- benzene (µg/L)	Total Xylenes (µg/L)	MtBE 8260B <sup>2</sup> (µg/L)
MPE-2 cont.	3/3/2011	53.72	21.25	-	32.47	NA	NA	NA	NA	NA	NA
	5/19/2011	53.72	22.19	-	31.53	NA	NA	NA	NA	NA	NA
Pre-MPE	8/4/2011	53.72	NM	-	NC	46,000	2,100	80	1,900	5,300	75
	9/8/2011	53.72	22.31	-	31.41	NA	NA	NA	NA	NA	NA
Post-MPE	9/26/2011	53.72	22.38	N	31.34	37,000	1,800	33	1,700	2,760	<17
	12/2/2011	53.72	21.44	N	32.28	26,000	1,600	43	1,800	3,370	<17
	3/2/2012	53.72	22.24	N	31.48	36,000	1,100	19	1,700	2,970	<17
	6/7/2012	53.72	22.35	N	31.37	33,000	1,800	27	1,600	2,700	29
	9/21/2012	53.72	23.03	N	30.69	31,000	1,700	13	1,900	2,747	14
	12/14/2012	53.72	22.17	N	31.55	31,000	1,700	20	1,800	2,490	16
	3/28/2013	53.72	22.53	N	31.19	20,000	2,200	<20	1,300	960	<20
	6/11/2013	53.72	22.9	N	30.82	26,000	920	<13	1,500	1,352	<13
	9/17/2013	53.72	23.29	N	30.43	23,000	680	15	1,400	1,059	<13
	12/5/2013	53.72	23.73	23.61	30.07	FP	FP	FP	FP	FP	FP
	3/12/2014	53.72	22.89	22.85	30.86	FP	FP	FP	FP	FP	FP
	6/5/2014	53.72	22.96	22.94	30.77	FP	FP	FP	FP	FP	FP
	9/23/2014	53.72	24.05	Y	29.67	22,000	550	340	760	2,760	<6.3
	12/23/2014	53.72	20.65	N	33.07	12,000	430	77	420	1,670	4.6
	3/20/2015	53.72	22.16	Y	31.56	14,000	670	21	630	1,150	6.9
	6/4/2015	53.72	22.6	Y	31.12	27,000	730	6.5	930	1,343	6.9
9/11/2015	53.72	23.15	Y	30.57	21,000	1,000	<7.1	1,200	760	9.3	
12/29/2015	53.72	22.86	Y	30.86	16,000	220	10	210	990	<6.3	
3/24/2016	53.72	20.55	Y	33.17	9,500	960	<6.3	180	370	11	
6/16/2016	53.72	20.58	Y	33.14	13,000	570	<5.0	350	351	7	
	<b>9/21/2016</b>	<b>53.72</b>	<b>22.96</b>	<b>N</b>	<b>30.76</b>	<b>12,000</b>	<b>630</b>	<b>&lt;6.3</b>	<b>300</b>	<b>190</b>	<b>&lt;6.3</b>
<b>2nd WBZ</b>											
MW-1D	1/3/2008	54.42		-	-	<50	<0.50	<2.0	<0.50	<2.0	<0.50
	1/22/2008	54.42	22.85	-	31.57	<50	<0.50	<2.0	<0.50	<2.0	<0.50
	4/16/2008	54.42	23.10	-	31.32	<50	<0.5	<2.0	<0.5	<2.0	<0.5
	7/3/2008	54.42	23.44	-	30.98	75.9	<0.5	<2.0	0.54	<2.0	<0.5
	10/15/2008	54.42	23.82	-	30.60	120	1.6	<0.5	2.8	3.6	<0.5

**Table 1**  
**Historical Groundwater Elevation Data and Analytical Results**  
15101 Freedom Avenue, San Leandro, CA

Monitoring Well	Date	Casing Elevation <sup>1</sup> (feet)	Depth to Groundwater (feet)	Free-Product (feet)/ Sheen (Y/N)	Groundwater Elevation (feet)	TPH-g (µg/L)	Benzene (µg/L)	Toluene (µg/L)	Ethyl-benzene (µg/L)	Total Xylenes (µg/L)	MtBE 8260B <sup>2</sup> (µg/L)
MW-1D cont.	1/8/2009	54.42	23.44	-	30.98	<50	<0.5	<0.5	<0.5	<0.5	<0.5
	4/14/2009	54.42	23.06	-	31.36	<50	<0.5	<0.5	<0.5	<0.5	<0.5
	8/26/2009	54.42	23.73	-	30.69	<50	<0.5	<0.5	<0.5	<0.5	<0.5
	12/1/2009	54.42	23.59	-	30.83	330 <sup>Y</sup>	<0.5	<0.5	1.3	2.2	<0.5
	3/16/2010	54.42	22.60	-	31.82	<50	<0.5	<0.5	<0.5	<0.5	<0.5
	6/4/2010	54.42	23.10	-	31.32	<50	<0.5	<0.5	<0.5	<0.5	<0.5
	9/1/2010	54.42	23.51	-	30.91	<50	<0.5	<0.5	0.52	1.8	<0.5
	12/3/2010	54.42	23.41	-	31.01	61	<0.5	<0.5	1.0	3.73	<0.5
	3/3/2011	54.42	22.27	N	32.15	<50	<0.5	<0.5	<0.5	<0.5	<0.5
	5/19/2011	54.42	22.89	N	31.53	<50	<0.5	<0.5	<0.5	<0.5	<0.5
	9/8/2011	54.42	23.08	N	31.34	220	<0.5	<0.5	0.6	1.4	<0.5
	12/1/2011	54.42	22.26	N	32.16	<22	<0.33	<0.19	<0.15	<0.20	<0.38
	3/2/2012	54.42	23.01	N	31.41	<50	<0.5	<0.5	<0.5	<0.5	<0.5
	6/6/2012	54.42	23.18	N	31.24	<50	<0.5	<0.5	<0.5	<0.5	<0.5
	9/20/2012	54.42	23.76	N	30.66	<50	<0.5	<0.5	<0.5	<0.5	<0.5
	12/13/2012	54.42	23.04	N	31.38	<50	<0.5	<0.5	<0.5	<0.5	<0.5
	3/27/2013	54.42	23.34	N	31.08	<50	<0.5	<0.5	<0.5	<0.5	<0.5
	6/10/2013	54.42	23.69	N	30.73	110	<0.5	<0.5	0.55	<0.5	<0.5
	9/16/2013	54.42	24.02	N	30.40	<50	<0.5	<0.5	<0.5	<0.5	<0.5
	12/5/2013	54.42	24.31	N	30.11	<50	<0.5	<0.5	<0.5	1.3	<0.5
	3/12/2014	54.42	23.68	N	30.74	<50	<0.5	<0.5	<0.5	<0.5	<0.5
	6/5/2014	54.42	23.68	N	30.74	<50	<0.5	<0.5	<0.5	<0.5	<0.5
	9/22/2014	54.42	24.65	N	29.77	<50	<0.5	<0.5	<0.5	0.88	<0.5
	12/23/2014	54.42	21.84	N	32.58	<50	<0.5	<0.5	<0.5	<0.5	<0.5
	3/19/2015	54.42	23.04	N	31.38	<50	<0.5	<0.5	<0.5	<0.5	<0.5
	6/3/2015	54.42	23.43	N	30.99	<50	<0.5	<0.5	<0.5	<0.5	<0.5
9/10/2015	54.42	23.91	N	30.51	<50	<0.5	<0.5	<0.5	<0.5	<0.5	



**Table 1**  
**Historical Groundwater Elevation Data and Analytical Results**  
15101 Freedom Avenue, San Leandro, CA

Monitoring Well	Date	Casing Elevation <sup>1</sup> (feet)	Depth to Groundwater (feet)	Free-Product (feet)/ Sheen (Y/N)	Groundwater Elevation (feet)	TPH-g (µg/L)	Benzene (µg/L)	Toluene (µg/L)	Ethyl-benzene (µg/L)	Total Xylenes (µg/L)	MtBE 8260B <sup>2</sup> (µg/L)
MW-3D	1/3/2008	54.10		-	-	<50	<0.50	<2.0	<0.50	<2.0	87.6
	1/22/2008	54.10	22.31	-	31.79	<50	<0.50	<2.0	<0.50	<2.0	88.3
	4/16/2008	54.10	22.64	-	31.46	<50	<0.5	<2.0	<0.5	<2.0	71.1
	7/3/2008	54.10	23.17	-	30.93	<50	<0.5	<2.0	<0.5	<2.0	67.4
	10/16/2008	54.10	23.62	-	30.48	<50	<0.5	<0.5	<0.5	<0.5	37
	1/8/2009	54.10	23.07	-	31.03	<50	<0.5	<0.5	<0.5	<0.5	29
	4/14/2009	54.10	22.36	-	31.74	<50	<0.5	<0.5	<0.5	<0.5	44
	8/26/2009	54.10	23.41	-	30.69	<50	<0.5	<0.5	<0.5	<0.5	20
	12/1/2009	54.10	23.27	-	30.83	110 Y	<0.5	<0.5	<0.5	0.52	24
	3/16/2010	54.10	22.10	-	32.00	<50	<0.5	<0.5	<0.5	<0.5	7.1
	6/4/2010	54.10	22.70	-	31.40	<50	<0.5	<0.5	<0.5	<0.5	17
	9/1/2010	54.10	23.09	-	31.01	78	<0.5	<0.5	1.1	4.71	24
	12/3/2010	54.10	22.90	-	31.20	<50	<0.5	<0.5	0.56	1.4	13
	3/3/2011	54.10	21.66	N	32.44	<50	1.3	<0.5	<0.5	0.59	14
	5/19/2011	54.10	22.61	N	31.49	<50	<0.5	<0.5	<0.5	<0.5	5.2
	9/8/2011	54.10	22.68	N	31.42	69	<0.5	<0.5	<0.5	0.62	4.8
	12/1/2011	54.10	22.86	N	31.24	<22	<0.33	<0.19	<0.15	<0.20	10
	3/2/2012	54.10	22.60	N	31.50	<50	<0.5	<0.5	<0.5	<0.5	4.2
	6/6/2012	54.10	22.77	N	31.33	<50	<0.5	<0.5	<0.5	<0.5	4.8
	9/20/2012	54.10	23.42	N	30.68	<50	<0.5	<0.5	<0.5	<0.5	5.1
	12/13/2012	54.10	22.57	N	31.53	<50	<0.5	<0.5	<0.5	<0.5	4.4
	3/27/2013	54.10	22.87	N	31.23	<50	<0.5	<0.5	<0.5	<0.5	4.4
	6/10/2013	54.10	23.27	N	30.83	<50	<0.5	<0.5	<0.5	<0.5	3.5
	9/16/2013	54.10	23.65	N	30.45	<50	<0.5	<0.5	<0.5	<0.5	2.1
	12/5/2013	54.10	23.97	N	30.13	<50	<0.5	<0.5	<0.5	0.53	1.6
	3/13/2014	54.10	23.22	N	30.88	130	<0.5	2.9	2.5	16.6	0.97
6/5/2014	54.10	23.33	N	30.77	<50	<0.5	<0.5	<0.5	0.77	1.5	
9/22/2014	54.10	24.40	N	29.70	<50	<0.5	<0.5	<0.5	<0.5	0.96	
12/23/2014	54.10	21.09	N	33.01	<50	<0.5	<0.5	<0.5	<0.5	1	

**Table 1**  
**Historical Groundwater Elevation Data and Analytical Results**  
 15101 Freedom Avenue, San Leandro, CA

Monitoring Well	Date	Casing Elevation <sup>1</sup> (feet)	Depth to Groundwater (feet)	Free-Product (feet)/ Sheen (Y/N)	Groundwater Elevation (feet)	TPH-g (µg/L)	Benzene (µg/L)	Toluene (µg/L)	Ethyl-benzene (µg/L)	Total Xylenes (µg/L)	MtBE 8260B <sup>2</sup> (µg/L)
MW-3D cont.	3/19/2015	54.10	22.50	N	31.60	<50	<0.5	<0.5	<0.5	<0.5	1.6
	6/3/2015	54.10	22.85	N	31.25	<50	<0.5	<0.5	<0.5	<0.5	1.6
	9/10/2015	54.10	23.53	N	30.57	<50	<0.5	<0.5	<0.5	<0.5	1.4
MW-4D	1/4/2008	53.12		-	-	<50	<0.50	<2.0	<0.50	<2.0	<0.50
	1/22/2008	53.12	21.11	-	32.01	91.5	18.7	<2.0	7.08	11.42	219
	4/15/2008	53.12	21.67	-	31.45	<50	<0.5	<2.0	<0.5	<2.0	27
	7/3/2008	53.12	22.39	-	30.73	<50	<0.5	<2.0	<0.5	<2.0	6.27
	10/16/2008	53.12	22.98	-	30.14	<50	<0.5	<0.5	<0.5	<0.5	1.9
	1/8/2009	53.12	22.25	-	30.87	<50	<0.5	<0.5	<0.5	<0.5	2
	4/14/2009	53.12	21.34	-	31.78	<50	<0.5	<0.5	<0.5	<0.5	2.2
	8/27/2009	53.12	22.79	-	30.33	<50	<0.5	<0.5	<0.5	<0.5	2.2
	12/1/2009	53.12	22.49	-	30.63	120 <sup>Y</sup>	<0.5	<0.5	1.4	2.3	2.3
	3/16/2010	53.12	21.02	-	32.10	<50	<0.5	<0.5	<0.5	<0.5	0.65
	6/4/2010	53.12	21.93	-	31.19	<50	<0.5	<0.5	<0.5	<0.5	1.1
	9/1/2010	53.12	23.32	-	29.80	<50	<0.5	<0.5	0.85	3.76	2.2
	12/3/2010	53.12	22.46	-	30.66	<50	<0.5	<0.5	<0.5	0.67	<0.5
	3/3/2011	53.12	20.45	N	32.67	<50	<0.5	<0.5	<0.5	<0.5	0.58
	5/19/2011	53.12	21.57	N	31.55	<50	<0.5	<0.5	<0.5	<0.5	<0.5
	9/8/2011	53.12	21.92	N	31.20	59	<0.5	<0.5	<0.5	0.51	1.7
	12/1/2011	53.12	21.19	N	31.93	<22	<0.33	<0.19	<0.15	<0.20	4.2
	3/2/2012	53.12	21.8	N	31.32	<50	<0.5	<0.5	0.85	1.2	2.7
	6/6/2012	53.12	22.00	N	31.12	<50	<0.5	<0.5	<0.5	<0.5	1.3
	9/20/2012	53.12	22.67	N	30.45	<50	<0.5	<0.5	<0.5	<0.5	1.6
12/13/2012	53.12	21.55	N	31.57	<50	<0.5	<0.5	<0.5	<0.5	0.94	
3/27/2013	53.12	21.98	N	31.14	<50	<0.5	<0.5	<0.5	<0.5	2.1	
6/10/2013	53.12	22.55	N	30.57	<50	<0.5	<0.5	<0.5	<0.5	1.7	
9/16/2013	53.12	23.05	N	30.07	<50	<0.5	<0.5	<0.5	<0.5	4.6	
12/6/2013	53.12	23.43	N	29.69	<50	<0.5	<0.5	<0.5	<0.5	3.4	

**Table 1**  
**Historical Groundwater Elevation Data and Analytical Results**  
**15101 Freedom Avenue, San Leandro, CA**

Monitoring Well	Date	Casing Elevation <sup>1</sup> (feet)	Depth to Groundwater (feet)	Free-Product (feet)/ Sheen (Y/N)	Groundwater Elevation (feet)	TPH-g (µg/L)	Benzene (µg/L)	Toluene (µg/L)	Ethyl-benzene (µg/L)	Total Xylenes (µg/L)	MtBE 8260B <sup>2</sup> (µg/L)
MW-4D cont.	3/13/2014	53.12	22.38	N	30.74	<50	<0.5	<0.5	<0.5	<0.5	4.0
	6/6/2014	53.12	22.78	N	30.34	<50	<0.5	<0.5	<0.5	<0.5	1.8
	9/23/2014	53.12	24.05	N	29.07	<50	<0.5	<0.5	<0.5	<0.5	<0.5
	12/23/2014	53.12	19.66	N	33.46	<50	<0.5	<0.5	<0.5	<0.5	<0.5
	3/19/2015	53.12	21.54	N	31.58	<50	<0.5	<0.5	<0.5	<0.5	<0.5
	6/3/2015	53.12	22.10	N	31.02	75	<0.5	<0.5	<0.5	<0.5	<0.5
	9/10/2015	53.12	22.89	N	30.23	<50	<0.5	<0.5	<0.5	<0.5	<0.5
1573 153 RD	1/3/2008	NS	NM	-	NC	<50	<0.5	<2.0	<0.5	<2.0	<0.5
	7/2/2008	NS	NM	-	NC	<50	<0.5	<2.0	<0.5	<2.0	<0.5
	10/16/2008	NS	NM	-	NC	<50	<0.5	<0.5	<0.5	<0.5	<0.5
<b>Equipment Blanks</b>											
EB-PMP	1/21/2008	-	-	-	-	<50	<0.50	<2.0	<0.50	<2.0	<0.50
EB-PRB	1/21/2008	-	-	-	-	<50	<0.50	<2.0	<0.50	<2.0	<0.50
EB-PMP2	1/22/2008	-	-	-	-	<50	<0.50	<2.0	<0.50	<2.0	<0.50
EB-PRB2	1/22/2008	-	-	-	-	<50	<0.50	<2.0	<0.50	<2.0	<0.50
ESL (ug/L)	-	-	-	-	-	100	1	40	13	20	5

Notes:

The first time SOMA monitored this Site was in May 2002.

\*: Due to minimal recharge rates in well MW-2, the groundwater elevation recorded on these dates did not match the overall site conditions, May 2002 & August 2003.

NC: Not Calculated

<sup>1</sup>: Top of casing elevations were surveyed to a datum of 67.07 M.S.L by Kier & Wright Civil Engineers & Land Surveyors on May 7, 2002.

On October 11, 2004, the site was re-surveyed by Harrington Surveys, Inc. of Walnut Creek, CA to a datum of California Coordinate System, Zone 3, NAD 83.

<sup>2</sup> MtBE analyzed by EPA Method 8021B, and confirmed by EPA Method 8260B.

<: Not detected above the laboratory reporting limit.

Y: Sample exhibits chromatographic pattern which does not resemble standard

<sup>c</sup> Presence confirmed, but confirmation concentration differed by more than a factor of two.

C: Presence confirmed, but RPD between columns exceeds 40%.

H: Heavier hydrocarbons contributed to the quantitation.

x: Does not match pattern of reference Gasoline Standard. Hydrocarbons in the range of C5-C12 quantified as gasoline (possibly aged gasoline)

NA: Not Analyzed. Well MW-8 was inaccessible during the First Quarter 2005, car was parked over well.  
Not Analyzed. Well MW-7 was inaccessible during the First Quarter 2006, car was parked over well.

NM: Not Measured. Well MW-8 was inaccessible during the First Quarter 2005, car was parked over well.  
Not Measured. Well MW-7 was inaccessible during the First Quarter 2006, car was parked over well.

The first time SOMA monitored wells MW-6 to MW-9 was in September 2004.

EB-PMP/EB-PRB: Equipment Blanks for Pump and Probe

ESL: Environmental Screening Levels per CRWQCB SFBay Region (Revised February 2016)

Tier 1 ESL (Groundwater Screening Levels (groundwater is a drinking water resource)

**Table 1**  
**Historical Groundwater Elevation Data and Analytical Results**  
**15101 Freedom Avenue, San Leandro, CA**

Monitoring Well	Date	Casing Elevation <sup>1</sup> (feet)	Depth to Groundwater (feet)	Free-Product (feet)/ Sheen (Y/N)	Groundwater Elevation (feet)	TPH-g (µg/L)	Benzene (µg/L)	Toluene (µg/L)	Ethyl-benzene (µg/L)	Total Xylenes (µg/L)	MtBE 8260B <sup>2</sup> (µg/L)
-----------------	------	---	--------------------------------	--	---------------------------------	-----------------	-------------------	-------------------	-------------------------	-------------------------	--------------------------------------

MW-8 and MW-9 were decommissioned November 13, 2009

FP: Groundwater not sampled due to presence of free-product

Groundwater elevation corrected upon presence of FP as follows:

Corrected depth to groundwater is equal to (measured depth)- 0.68(free product thickness)

The correction factor is derived by the following: specific gravity of gas at 20 °C is 0.68, then specific gravity is multiplied by the thickness of free product

**Table 2**  
**Historical Gasoline Oxygenates Results**  
**15101 Freedom Avenue, San Leandro, CA**

Monitoring Well	Date	TBA (µg/L)	DIPE (µg/L)	ETBE (µg/L)	TAME (µg/L)	1,2-DCA (µg/L)	EDB (µg/L)
<b>1st WBZ</b>							
MW-1	8/8/2002	78	<1.3	<1.3	<1.3	NA	NA
	11/1/2002	42	< 1.0	< 1.0	< 1.0	NA	NA
	2/21/2003	47	<0.5	<0.5	<0.5	NA	NA
	5/28/2003	25	<0.5	<0.5	<0.5	NA	NA
	8/12/2003	<10	<0.5	<0.5	<0.5	NA	NA
	10/9/2003	70	<1.0	<1.0	<1.0	NA	NA
	1/15/2004	55	<0.5	<0.5	<0.5	NA	NA
	5/25/2004	62	<0.7	<0.7	<0.7	NA	NA
	9/21/2004	<10	<0.5	<0.5	<0.5	NA	NA
	12/14/2004	<21.5	<4.3	<4.3	<17.2	NA	NA
	3/11/2005	81	<0.5	<0.5	<2.0	NA	NA
	6/15/2005	<10	<0.5	<0.5	<2.0	NA	NA
	8/26/2005	68.9	<2.15	<2.15	<8.6	NA	NA
	11/11/2005	46	<2.15	<2.15	<8.6	NA	NA
	2/9/2006	11.3	<0.5	<0.5	<2.0	NA	NA
	5/9/2006	<10	<0.5	<0.5	<2.0	0.51	<0.5
	8/10/2006	<43	<2.15	<2.15	<8.60	3.37	<2.15
	10/26/2006	39.4	<1.0	<1.0	<4.0	2.92	<1.0
	1/25/2007	41.4	<0.5	<0.5	<2.0	1.36	<0.5
	4/26/2007	39.6	<0.5	<0.5	<2.0	<0.5	<0.5
	7/25/2007	46.5	<1.0	<1.0	<4.0	<1.0	<1.0
	10/23/2007	53.7	<0.5	<0.5	<2.0	<0.5	<0.5
	1/22/2008	23.8	<0.5	<0.5	<2.16	<0.5	<0.5
	4/16/2008	8.36	<0.5	<0.5	<2.0	164	<0.5
	7/3/2008	30.5	<0.5	<0.5	<2.0	1.08	<0.5
	10/15/2008	<20	<1.0	<1.0	<1.0	<1.0	<1.0
	1/7/2009	<25	<1.3	<1.3	<1.3	<1.3	<1.3
	4/14/2009	15	<0.5	<0.5	<0.5	<0.5	<0.5
	8/27/2009	<40	<2.0	<2.0	<2.0	<2.0	<2.0
	12/2/2009	<40	<2.0	<2.0	<2.0	<2.0	<2.0
	3/17/2010	<10	<0.5	<0.5	<0.5	<0.5	<0.5
	6/3/2010	26	<0.5	<0.5	<0.5	<0.5	<0.5
	9/2/2010	<100	<5.0	<5.0	<5.0	<5.0	<5.0
	12/2/2010	<63	<3.1	<3.1	<3.1	<3.1	<3.1
	3/4/2011	40	<0.5	<0.5	<0.5	<0.5	<0.5
	5/20/2011	<71	<3.6	<3.6	<3.6	<3.6	<3.6
	9/9/2011	33	<1.3	<1.3	<1.3	<1.3	<1.3
	12/2/2011	49	<3.2	<3.5	<3.5	<2.8	<1.7
	3/2/2012	<50	<2.5	<2.5	<2.5	<2.5	<2.5
	6/7/2012	<50	<2.5	<2.5	<2.5	<2.5	<2.5
9/21/2012	<50	<2.5	<2.5	<2.5	<2.5	<2.5	
12/14/2012	<50	<2.5	<2.5	<2.5	<2.5	<2.5	
3/28/2013	<50	<2.5	<2.5	<2.5	<2.5	<2.5	
6/11/2013	<50	<2.5	<2.5	<2.5	<2.5	<2.5	
9/17/2013	<50	<2.5	<2.5	<2.5	<2.5	<2.5	
12/6/2013	<33	<1.7	<1.7	<1.7	<1.7	<1.7	
3/13/2014	<10	<0.5	<0.5	<0.5	<0.5	<0.5	
6/6/2014	<10	<0.5	<0.5	<0.5	<0.5	<0.5	
9/23/2014	<33	<1.7	<1.7	<1.7	<1.7	<1.7	
12/23/2014	4.7 J	<0.5	<0.5	<0.5	<0.5	<0.5	
3/20/2015	11	<0.5	<0.5	<0.5	<0.5	<0.5	
6/4/2015	14 J	<0.71	<0.71	<0.71	<0.71	<0.71	
9/11/2015	<33	<1.7	<1.7	<1.7	<1.7	<1.7	
12/2/2015	<10	<0.5	<0.5	<0.5	<0.5	<0.5	
3/23/2016	<10	<0.5	<0.5	<0.5	<0.5	<0.5	
6/15/2016	<10	<0.5	<0.5	<0.5	<0.5	<0.5	
9/21/2016	17	<0.5	<0.5	<0.5	<0.5	<0.5	
MW-2	8/8/2002	21	<0.5	<0.5	<0.5	NA	NA
	11/1/2002	15	<0.5	<0.5	<0.5	NA	NA
	2/21/2003	12	<0.5	<0.5	<0.5	NA	NA
	5/28/2003	31	<0.5	<0.5	<0.5	NA	NA
	8/12/2003	69	<0.8	<0.8	<0.8	NA	NA
	10/9/2003	12	<0.5	<0.5	<0.5	NA	NA

**Table 2**  
**Historical Gasoline Oxygenates Results**  
**15101 Freedom Avenue, San Leandro, CA**

Monitoring Well	Date	TBA (µg/L)	DIPE (µg/L)	ETBE (µg/L)	TAME (µg/L)	1,2-DCA (µg/L)	EDB (µg/L)
MW-2 cont.	1/15/2004	<10	<0.5	<0.5	<0.5	NA	NA
	5/25/2004	14	<0.5	<0.5	<0.5	NA	NA
	9/21/2004	<10	<0.5	<0.5	<0.5	NA	NA
	12/14/2004	<2.5	<0.5	<0.5	<2.0	NA	NA
	3/11/2005	<2.5	<0.5	<0.5	<2.0	NA	NA
	6/15/2005	<10	<0.5	<0.5	<2.0	NA	NA
	8/26/2005	<10	<0.5	<0.5	<2.0	NA	NA
	11/11/2005	<10	<0.5	<0.5	<2.0	NA	NA
	2/9/2006	<10	<0.5	<0.5	<2.0	NA	NA
	5/9/2006	<10	<0.5	<0.5	<2.0	<0.5	<0.5
	8/10/2006	<10	<0.5	<0.5	<2.0	<0.5	<0.5
	10/26/2006	<10	<0.5	<0.5	<2.0	<0.5	<0.5
	1/25/2007	<2.0	<0.5	<0.5	<2.0	<0.5	<0.5
	4/26/2007	<2.0	<0.5	<0.5	<2.0	<0.5	<0.5
	7/25/2007	<2.0	<0.5	<0.5	<2.0	<0.5	<0.5
	10/23/2007	<2.0	<0.5	<0.5	<2.0	<0.5	<0.5
	1/22/2008	<2.0	<0.5	<0.5	<2.0	<0.5	<0.5
	4/15/2008	<2.0	<0.5	<0.5	<2.0	2.44	<0.5
	7/2/2008	<2.0	<0.5	<0.5	<2.0	<0.5	<0.5
	10/15/2008	<10	<0.5	<0.5	<0.5	<0.5	<0.5
	1/7/2009	<10	<0.5	<0.5	<0.5	<0.5	<0.5
	4/13/2009	<10	<0.5	<0.5	<0.5	<0.5	<0.5
	8/27/2009	<10	<0.5	<0.5	<0.5	<0.5	<0.5
	12/1/2009	<10	<0.5	<0.5	<0.5	<0.5	<0.5
	3/17/2010	<10	<0.5	<0.5	<0.5	<0.5	<0.5
	6/3/2010	<10	<0.5	<0.5	<0.5	<0.5	<0.5
	9/2/2010	<10	<0.5	<0.5	<0.5	<0.5	<0.5
	12/2/2010	<10	<0.5	<0.5	<0.5	<0.5	<0.5
	3/4/2011	<10	<0.5	<0.5	<0.5	<0.5	<0.5
	5/20/2011	<10	<0.5	<0.5	<0.5	<0.5	<0.5
	9/9/2011	<10	<0.5	<0.5	<0.5	<0.5	<0.5
	12/2/2011	<13	<3.2	<3.5	<2.8	<2.4	<1.7
	3/2/2012	<10	<0.5	<0.5	<0.5	<0.5	<0.5
	6/7/2012	<10	<0.5	<0.5	<0.5	<0.5	<0.5
	9/21/2012	<10	<0.5	<0.5	<0.5	<0.5	<0.5
	12/14/2012	<10	<0.5	<0.5	<0.5	<0.5	<0.5
	3/28/2013	<10	<0.5	<0.5	<0.5	<0.5	<0.5
	6/11/2013	150	<0.5	1.6	<0.5	<0.5	<0.5
	9/16/2013	<10	<0.5	<0.5	<0.5	<0.5	<0.5
	12/6/2013	<10	<0.5	<0.5	<0.5	<0.5	<0.5
	3/13/2014	<10	<0.5	<0.5	<0.5	<0.5	<0.5
6/6/2014	<10	<0.5	<0.5	<0.5	<0.5	<0.5	
9/23/2014	<10	<0.5	<0.5	<0.5	<0.5	<0.5	
12/23/2014	<10	<0.5	<0.5	<0.5	<0.5	<0.5	
3/20/2015	<10	<0.5	<0.5	<0.5	<0.5	<0.5	
6/4/2015	<1.7	<0.5	<0.5	<0.5	<0.5	<0.5	
9/11/2015	<20	<1.0	<1.0	<1.0	<1.0	<1.0	
12/2/2015	<10	<0.5	<0.5	<0.5	<0.5	<0.5	
3/23/2016	<10	<0.5	<0.5	<0.5	<0.5	<0.5	
6/15/2016	<10	<0.5	<0.5	<0.5	<0.5	<0.5	
9/21/2016	<10	<0.5	<0.5	<0.5	<0.5	<0.5	
MW-3	8/8/2002	<330	<8.3	<8.3	330	NA	NA
	11/1/2002	85	< 1.3	<1.3	220	NA	NA
	2/21/2003	140	<5.0	<5.0	320	NA	NA
	5/28/2003	520	<10	<10	530	NA	NA
	8/12/2003	180	<4.2	<4.2	270	NA	NA
	10/9/2003	<170	<8.3	<8.3	200	NA	NA
	1/15/2004	<100	<5.0	<5.0	150	NA	NA
	5/25/2004	<100	<5.0	<5.0	270	NA	NA
	9/21/2004	<140	<7.1	<7.1	110	NA	NA
	12/14/2004	<100	<20	<20	154	NA	NA
	3/11/2005	<215	<43	<43	256	NA	NA
	6/15/2005	<215	<10.8	<10.8	374	NA	NA
	8/26/2005	699	<21.5	<21.5	277	NA	NA
11/11/2005	<430	<21.5	<21.5	171	NA	NA	

**Table 2**  
**Historical Gasoline Oxygenates Results**  
**15101 Freedom Avenue, San Leandro, CA**

Monitoring Well	Date	TBA (µg/L)	DIPE (µg/L)	ETBE (µg/L)	TAME (µg/L)	1,2-DCA (µg/L)	EDB (µg/L)
MW-3 cont.	2/9/2006	<430	<21.5	<21.5	620	NA	NA
	5/9/2006	367	<10.8	<10.8	594	<10.8	<10.8
	8/10/2006	365	<10.8	<10.8	727	<10.8	<10.8
	10/26/2006	591	<10.8	<10.8	899	<10.8	<10.8
	1/25/2007	711	<10.8	<10.8	768	<10.8	<10.8
	4/26/2007	690	<10.8	<10.8	369	<10.8	<10.8
	7/25/2007	1,340	<10.8	<10.8	565	<10.8	<10.8
	10/23/2007	1,050	<21.5	<21.5	301	<21.5	<21.5
	1/22/2008	373	<10.8	<10.8	170	<0.5	<0.5
	4/16/2008	881	<5.50	<5.50	<22.0	1,850	12.1
	7/3/2008	426	<10.8	<10.8	124	<10.8	<10.8
	10/16/2008	<400	<20	<20	<20	<20	<20
	1/8/2009	<500	<25	<25	<25	<25	<25
	4/13/2009	<500	<25	<25	<25	<25	<25
	8/27/2009	<500	<25	<25	<25	<25	<25
	12/2/2009	270	<13	<13	<13	<13	<13
	3/17/2010	<250	<13	<13	<13	<13	<13
	6/3/2010	<250	<13	<13	<13	<13	<13
	9/2/2010	<250	<13	<13	<13	<13	<13
	12/2/2010	<130	<6.3	<6.3	<6.3	<6.3	<6.3
	3/4/2011	<170	<8.3	<8.3	<8.3	<8.3	<8.3
	5/20/2011	<130	<6.3	<6.3	<6.3	<6.3	<6.3
	9/9/2011	<140	<7.1	<7.1	<7.1	<7.1	<7.1
	12/2/2011	<6.6	<1.6	<1.7	<1.4	<1.2	<0.86
	3/2/2012	<100	<5.0	<5.0	<5.0	<5.0	<5.0
	6/7/2012	<100	<5.0	<5.0	<5.0	<5.0	<5.0
	9/21/2012	<100	<5.0	<5.0	<5.0	<5.0	<5.0
	12/14/2012	<100	<5.0	<5.0	<5.0	<5.0	<5.0
	3/28/2013	<100	<5.0	<5.0	<5.0	<5.0	<5.0
	6/11/2013	<100	<5.0	<5.0	<5.0	<5.0	<5.0
	9/17/2013	<200	<10	<10	<10	<10	<10
	12/6/2013	<200	<10	<10	<10	<10	<10
	3/12/2014	FP	FP	FP	FP	FP	FP
	6/5/2014	FP	FP	FP	FP	FP	FP
	9/23/2014	<200	<10	<10	<10	<10	<10
	12/23/2014	<71	<3.6	<3.6	<3.6	<3.6	<3.6
	3/20/2015	29 J	<3.6	<3.6	<3.6	<3.6	<3.6
	6/4/2015	<17	<6.3	<6.3	<6.3	<6.3	<6.3
	9/11/2015	<130	<6.3	<6.3	<6.3	<6.3	<6.3
	12/29/2015	<100	<5	<5	<5	<5	<5
3/24/2016	60	<1.3	<1.3	<1.3	<1.3	<1.3	
6/16/2016	38	<0.5	<0.5	<0.5	<0.5	<0.5	
9/21/2016	140	<2.5	<2.5	<2.5	<2.5	<2.5	
MW-4	8/8/2002	1500	<17	<17	18	NA	NA
	11/1/2002	580	< 5.0	6	13	NA	NA
	2/21/2003	1600	<20	22	<20	NA	NA
	5/28/2003	690	<8.3	<8.3	17	NA	NA
	8/12/2003	550	<7.1	7.3	18	NA	NA
	10/9/2003	1400	<31	50	<31	NA	NA
	1/15/2004	1,300	<20	25	21	NA	NA
	5/25/2004	560	<8.3	<8.3	24	NA	NA
	9/21/2004	1,300	<50	<50	<50	NA	NA
	12/14/2004	826	<10.75	21	49	NA	NA
	3/11/2005	1,110	<10.8	12.1	<43	NA	NA
	6/15/2005	<110	<5.5	<5.5	22.9	NA	NA
	8/26/2005	902	<5.50	<5.50	37.4	NA	NA
	11/11/2005	884	<10.8	<10.8	<43	NA	NA
	2/9/2006	769	<10.8	16.4	45.6	NA	NA
	5/9/2006	405	<2.15	2.95	31.3	<2.15	<2.15
	8/10/2006	306	<2.15	<2.15	35.3	<2.15	<2.15
	10/26/2006	3430	<10.8	13.8	<43	<10.8	<10.8
	1/25/2007	822	<2.15	2.4	28	2.25	<2.15
	4/26/2007	556	<2.15	2.28	29.2	<2.15	<2.15
	7/25/2007	1,860	<2.15	9.94	24	<2.15	<2.15
	10/23/2007	3,400	<2.15	18.4	25.9	<2.15	<2.15

**Table 2**  
**Historical Gasoline Oxygenates Results**  
**15101 Freedom Avenue, San Leandro, CA**

Monitoring Well	Date	TBA (µg/L)	DIPE (µg/L)	ETBE (µg/L)	TAME (µg/L)	1,2-DCA (µg/L)	EDB (µg/L)
MW-4 cont.	1/22/2008	2,580	<5.50	64.7	<22	<0.5	<0.5
	4/15/2008	1,100	<5.50	11.7	<22	39.9	<5.50
	7/2/2008	8,720	<5.50	75.2	<22	<5.50	<5.50
	10/16/2008	700	<3.6	4.2	37	5.4	<3.6
	1/8/2009	1,500	<3.6	9.9	41	3.6	<3.6
	4/13/2009	1,100	<8.3	<8.3	28	<8.3	<8.3
	8/27/2009	4,900	<5.0	24	<5.0	<5.0	<5.0
	12/2/2009	6,800	<5.0	69	<5.0	<5.0	<5.0
	3/17/2010	1,900	<3.6	18	<3.6	<3.6	<3.6
	6/3/2010	930	<3.6	7.7	<3.6	<3.6	<3.6
	9/2/2010	7,200	<3.6	57	<3.6	<3.6	<3.6
	12/2/2010	3,800	<10	30	<10	<10	<10
	3/3/2011	410	<0.71	3.2	<0.71	<0.71	<0.71
	5/19/2011	130	<0.5	1.4	<0.5	<0.5	<0.5
	9/8/2011	380	<0.5	3.5	<0.5	1.1	<0.5
	12/1/2011	790	<1.6	5.4	8.2	<1.2	<0.86
	3/2/2012	920	<2.0	5.9	24	<2.0	<2.0
	6/7/2012	1,000	<2.5	13	<2.5	<2.5	<2.5
	9/21/2012	1,300	<2.5	14	<2.5	<2.5	<2.5
	12/14/2012	36	<0.5	0.65	<0.5	<0.5	<0.5
	3/28/2013	2,500	<5.0	29	<5.0	<5.0	<5.0
	6/11/2013	890	<5.0	12	<5.0	<5.0	<5.0
	9/17/2013	1,100	<10	<10	<10	<10	<10
	12/6/2013	1,500	<10	<10	<10	<10	<10
	3/13/2014	190	<6.3	<6.3	<6.3	<6.3	<6.3
	6/6/2014	360	<6.3	<6.3	<6.3	<6.3	<6.3
	9/23/2014	1,100	<6.3	6.3	<6.3	<6.3	<6.3
	12/23/2014	8.1 J	<0.5	<0.5	<0.5	<0.5	<0.5
	3/20/2015	29	<0.5	<0.5	<0.5	<0.5	<0.5
	6/4/2015	62	<0.5	0.62	<0.5	<0.5	<0.5
	9/11/2015	82	<1.0	<1.0	<1.0	<1.0	<1.0
	12/29/2015	32	<0.5	<0.5	1.4	<0.5	<0.5
3/23/2016	14	<0.5	<0.5	0.88	<0.5	<0.5	
6/16/2016	230	<0.5	4.7	<0.5	<0.5	<0.5	
9/21/2016	130	<0.5	2.0	4.7	<0.5	<0.5	
MW-5	8/8/2002	<250	<6.3	<6.3	510	NA	NA
	11/1/2002	66	< 2.0	< 2.0	560	NA	NA
	2/21/2003	<63	<3.1	<3.1	280	NA	NA
	5/28/2003	<33	<1.7	<1.7	110	NA	NA
	8/12/2003	130	<3.6	<3.6	270	NA	NA
	10/9/2003	<100	<5.0	<5.0	740	NA	NA
	1/15/2004	<63	<3.1	<3.1	300	NA	NA
	5/25/2004	<100	<5.0	<5.0	210	NA	NA
	9/21/2004	<130	<6.3	<6.3	550	NA	NA
	12/14/2004	40	<5.5	<5.5	444	NA	NA
	3/11/2005	88.8	<5.5	<5.5	448	NA	NA
	6/15/2005	<43	<2.15	<2.15	88.1	NA	NA
	8/26/2005	274	<5.50	<5.50	195	NA	NA
	11/11/2005	192	<5.50	<5.50	360	NA	NA
	2/9/2006	218	<5.50	<5.50	523	NA	NA
	5/9/2006	91.8	<2.15	<2.15	163	<2.15	<2.15
	8/10/2006	138	<5.50	<5.50	342	<5.50	<5.50
	10/26/2006	322	<5.50	<5.50	712	<5.50	<5.50
	1/25/2007	878	<5.50	<5.50	552	<5.50	<5.50
	4/26/2007	708	<2.15	<2.15	310	<2.15	<2.15
	7/25/2007	1,020	<2.15	<2.15	356	<2.15	<2.15
	10/23/2007	1,510	<2.15	<2.15	181	<2.15	<2.15
	1/22/2008	470	<0.5	4.56	62.1	<0.5	<0.5
	4/15/2008	566	<1.0	<1.0	29.6	231	5.66
	7/3/2008	2,320	<2.15	<2.15	53.3	<2.15	<2.15
	10/16/2008	990	<5.0	<5.0	82	<5.0	<5.0
1/8/2009	360	<6.3	<6.3	51	<6.3	<6.3	
4/13/2009	280	<3.1	<3.1	<3.1	<3.1	<3.1	
8/27/2009	1,300	<5.0	<5.0	<5.0	<5.0	<5.0	
12/2/2009	320	<5.0	<5.0	25	<5.0	<5.0	



**Table 2**  
**Historical Gasoline Oxygenates Results**  
**15101 Freedom Avenue, San Leandro, CA**

Monitoring Well	Date	TBA (µg/L)	DIPE (µg/L)	ETBE (µg/L)	TAME (µg/L)	1,2-DCA (µg/L)	EDB (µg/L)
MW-5 cont.	3/17/2010	570	<1.0	<1.0	<1.0	<1.0	<1.0
	6/4/2010	340	<1.0	<1.0	<1.0	<1.0	<1.0
	9/2/2010	320	<2.5	<2.5	13	<2.5	<2.5
	12/2/2010	200	<3.1	<3.1	<3.1	<3.1	<3.1
Pre- MPE	3/4/2011	180	<0.5	<0.5	<0.5	<0.5	<0.5
	5/20/2011	480	<1.0	<1.0	<1.0	<1.0	<1.0
	8/4/2011	110	<0.71	<0.71	2.6	<0.71	<0.71
	9/9/2011	260	<1.0	<1.0	11	<1.0	<1.0
	12/2/2011	95	<3.2	<3.5	14	<2.4	<1.7
	3/2/2012	59	<1.0	<1.0	4.1	<1.0	<1.0
	6/7/2012	22	<1.0	<1.0	2.8	<1.0	<1.0
	9/21/2012	66	<1.0	<1.0	<1.0	<1.0	<1.0
	12/14/2012	<20	<1.0	<1.0	4.2	<1.0	<1.0
	3/28/2013	<20	<1.0	<1.0	<1.0	<1.0	<1.0
	6/11/2013	<20	<1.0	<1.0	2.5	<1.0	<1.0
	9/17/2013	20	<1.0	<1.0	5.7	<1.0	<1.0
	12/6/2013	<20	<1.0	<1.0	3.9	<1.0	<1.0
	3/13/2014	<20	<1.0	<1.0	2.2	<1.0	<1.0
	6/6/2014	<10	<0.5	<0.5	0.81	<0.5	<0.5
	9/23/2014	<10	<0.5	<0.5	<0.5	<0.5	<0.5
	12/23/2014	<10	<0.5	<0.5	<0.5	<0.5	<0.5
	3/20/2015	3.1 J	<0.5	<0.5	<0.5	<0.5	<0.5
	6/4/2015	<1.3	<0.5	<0.5	<0.5	<0.5	<0.5
9/11/2015	<10	<0.5	<0.5	<0.5	<0.5	<0.5	
12/29/2015	<10	<0.5	<0.5	<0.5	<0.5	<0.5	
3/23/2016	19	<0.5	<0.5	<0.5	<0.5	<0.5	
6/16/2016	<10	<0.5	<0.5	<0.5	<0.5	<0.5	
9/21/2016	<10	<0.5	<0.5	0.94	<0.5	<0.5	
MW-6	9/21/2004	<10	<0.5	<0.5	<0.5	NA	NA
	12/14/2004	<5.5	<5.5	<5.5	<22	NA	NA
	3/11/2005	2.54	<0.5	<0.5	<2.0	NA	NA
	6/15/2005	<20	<1.0	<1.0	<4.0	NA	NA
	8/26/2005	<43	<2.15	<2.15	<8.6	NA	NA
	11/11/2005	<43	<2.15	<2.15	<8.6	NA	NA
	2/9/2006	<43	<2.15	<2.15	<8.6	NA	NA
	5/9/2006	<10	<0.5	<0.5	<2.0	<0.5	<0.5
	8/10/2006	<10	<0.5	<0.5	<2.0	<0.5	<0.5
	10/26/2006	<10	<0.5	<0.5	<2.0	<0.5	<0.5
	1/25/2007	<2.0	<0.5	<0.5	<2.0	<0.5	<0.5
	4/26/2007	7.21	<0.5	<0.5	<2.0	<0.5	<0.5
	7/25/2007	5.66	<0.5	<0.5	<2.0	<0.5	<0.5
	10/23/2007	6.68	<0.5	<0.5	<2.0	<0.5	<0.5
	1/21/2008	13.9	<0.5	<0.5	<2.0	<0.5	<0.5
	4/15/2008	<2.0	<0.5	<0.5	<2.0	6.78	1.49
	7/2/2008	4.54	<0.5	<0.5	<2.0	<0.5	<0.5
	10/15/2008	<10	<0.5	<0.5	<0.5	<0.5	<0.5
	1/7/2009	<63	<3.1	<3.1	<3.1	<3.1	<3.1
	4/13/2009	<25	<1.3	<1.3	<1.3	<1.3	<1.3
	8/26/2009	<40	<2.0	<2.0	<2.0	<2.0	<2.0
	12/1/2009	<40	<2.0	<2.0	<2.0	<2.0	<2.0
	3/16/2010	<40	<2.0	<2.0	<2.0	<2.0	<2.0
	6/3/2010	<40	<2.0	<2.0	<2.0	<2.0	<2.0
	9/1/2010	<200	<10	<10	<10	<10	<10
	12/2/2010	<330	<17	<17	<17	<17	<17
	3/3/2011	<50	<2.5	<2.5	<2.5	<2.5	<2.5
	5/20/2011	<50	<2.5	<2.5	<2.5	<2.5	<2.5
	9/8/2011	<50	<2.5	<2.5	<2.5	<2.5	<2.5
	12/1/2011	NA	NA	NA	NA	NA	NA
3/2/2012	<83	<4.2	<4.2	<4.2	<4.2	<4.2	
6/6/2012	<33	<1.7	<1.7	<1.7	<1.7	<1.7	
9/20/2012	NA	NA	NA	NA	NA	NA	
12/13/2012	29	<0.71	<0.71	<0.71	<0.71	<0.71	
3/27/2013	<25	<1.3	<1.3	<1.3	<1.3	<1.3	
6/10/2013	<50	<2.5	<2.5	<2.5	<2.5	<2.5	
9/16/2013	FP	FP	FP	FP	FP	FP	
12/5/2013	270	<2.5	<2.5	<2.5	<2.5	<2.5	

**Table 2**  
**Historical Gasoline Oxygenates Results**  
**15101 Freedom Avenue, San Leandro, CA**

Monitoring Well	Date	TBA (µg/L)	DIPE (µg/L)	ETBE (µg/L)	TAME (µg/L)	1,2-DCA (µg/L)	EDB (µg/L)
MW-6 cont.	3/12/2014	<50	<2.5	<2.5	<2.5	<2.5	<2.5
	6/5/2014	<50	<2.5	<2.5	<2.5	<2.5	<2.5
	9/22/2014	160	<2.5	<2.5	<2.5	<2.5	<2.5
	12/22/2014	13 J	<0.5	<0.5	<0.5	<0.5	<0.5
	3/19/2015	4.1 J	<0.5	<0.5	<0.5	<0.5	<0.5
	6/3/2015	<1.3	<0.5	<0.5	<0.5	<0.5	<0.5
	9/10/2015	<100	<5.0	<5.0	<5.0	<5.0	<5.0
	12/28/2015	<20	<1.0	<1.0	<1.0	<1.0	<1.0
	3/24/2016	<10	<0.5	<0.5	<0.5	<0.5	<0.5
	6/16/2016	<10	<0.5	<0.5	<0.5	<0.5	<0.5
	9/21/2016	<20	<1.0	<1.0	<1.0	<1.0	<1.0
	MW-7	9/21/2004	<10	<0.5	<0.5	1.5	NA
12/14/2004		<2.5	<0.5	<0.5	<2.0	NA	NA
3/11/2005		<12.5	<2.5	<2.5	<10	NA	NA
6/15/2005		<10	<0.5	<0.5	2.23	NA	NA
8/26/2005		<10	<0.5	<0.5	<2.0	NA	NA
11/11/2005		<10	<0.5	<0.5	<2.0	NA	NA
2/9/2006		NA	NA	NA	NA	NA	NA
5/9/2006		<10	<0.5	<0.5	<2.0	<0.5	<0.5
8/10/2006		<10	<0.5	<0.5	<2.0	<0.5	<0.5
10/26/2006		<10	<0.5	<0.5	<2.0	<0.5	<0.5
1/25/2007		<2.0	<0.5	<0.5	<2.0	<0.5	<0.5
4/26/2007		<2.0	<0.5	<0.5	<2.0	<0.5	<0.5
7/25/2007		<2.0	<0.5	<0.5	<2.0	<0.5	<0.5
10/23/2007		6.49	<0.5	<0.5	2.58	<0.5	<0.5
1/21/2008		<2.0	<0.5	<0.5	6.01	<0.5	<0.5
4/15/2008		8.8	<0.5	<0.5	<2.0	<0.5	1.26
7/2/2008		<2.0	<0.5	<0.5	<2.0	<0.5	<0.5
10/15/2008		<10	<0.5	<0.5	14	<0.5	<0.5
1/7/2009		<10	<0.5	<0.5	11	<0.5	<0.5
4/13/2009		<10	<0.5	<0.5	16	<0.5	<0.5
8/26/2009		<33	<0.5	<0.5	33	<0.5	<0.5
12/1/2009		<10	<0.5	<0.5	30	<0.5	<0.5
3/16/2010		11	<0.5	<0.5	<0.5	<0.5	<0.5
6/3/2010		20	<0.5	<0.5	7.1	<0.5	<0.5
9/1/2010		47	<0.5	<0.5	7.2	<0.5	<0.5
12/2/2010		22	<0.5	<0.5	4.9	<0.5	<0.5
3/4/2011		14	<0.5	<0.5	4.0	<0.5	<0.5
5/19/2011		<10	<0.5	<0.5	2.1	<0.5	<0.5
9/8/2011		<10	<0.5	<0.5	1.6	<0.5	<0.5
12/1/2011		15	<0.36	<0.40	2.4	<0.28	<0.19
3/2/2012		<10	<0.5	<0.5	0.82	<0.5	<0.5
6/6/2012		<10	<0.5	<0.5	<0.5	<0.5	<0.5
9/20/2012		<10	<0.5	<0.5	<0.5	<0.5	<0.5
12/13/2012		<10	<0.5	<0.5	<0.5	<0.5	<0.5
3/27/2013		<10	<0.5	<0.5	<0.5	<0.5	<0.5
6/10/2013		<10	<0.5	<0.5	<0.5	<0.5	<0.5
9/16/2013		<10	<0.5	<0.5	<0.5	<0.5	<0.5
12/5/2013		<10	<0.5	<0.5	0.73	<0.5	<0.5
3/12/2014		<10	<0.5	<0.5	0.64	<0.5	<0.5
6/5/2014		<10	<0.5	<0.5	0.76	<0.5	<0.5
9/22/2014		<10	<0.5	<0.5	<0.5	<0.5	<0.5
12/22/2014		<10	<0.5	<0.5	<0.5	<0.5	<0.5
3/19/2015	3.0 J	<0.5	<0.5	0.68	<0.5	<0.5	
6/3/2015	<1.3	<0.5	<0.5	<0.5	<0.5	<0.5	
9/10/2015	<33	<1.7	<1.7	<1.7	<1.7	<1.7	
12/28/2015	<10	<0.5	<0.5	<0.5	<0.5	<0.5	
3/24/2016	<10	<0.5	<0.5	<0.5	<0.5	<0.5	
6/16/2016	<10	<0.5	<0.5	<0.5	<0.5	<0.5	
9/21/2016	<10	<0.5	<0.5	<0.5	<0.5	<0.5	
MW-8	9/21/2004	<10	<0.5	<0.5	<0.5	NA	NA
	12/14/2004	<2.5	<0.5	<0.5	<2.0	NA	NA
	3/11/2005	NA	NA	NA	NA	NA	NA
	6/15/2005	<10	<0.5	<0.5	<2.0	NA	NA
	8/26/2005	<10	<0.5	<0.5	<2.0	NA	NA
	11/11/2005	<10	<0.5	<0.5	<2.0	NA	NA

**Table 2**  
**Historical Gasoline Oxygenates Results**  
**15101 Freedom Avenue, San Leandro, CA**

Monitoring Well	Date	TBA (µg/L)	DIPE (µg/L)	ETBE (µg/L)	TAME (µg/L)	1,2-DCA (µg/L)	EDB (µg/L)
MW-8 cont.	2/9/2006	<10	<0.5	<0.5	<2.0	NA	NA
	5/9/2006	<10	<0.5	<0.5	<2.0	<0.5	<0.5
	8/10/2006	<10	<0.5	<0.5	<2.0	<0.5	<0.5
	10/26/2006	<10	<0.5	<0.5	<2.0	<0.5	<0.5
	1/25/2007	<2.0	<0.5	<0.5	<2.0	<0.5	<0.5
	4/26/2007	<2.0	<0.5	<0.5	<2.0	<0.5	<0.5
	7/25/2007	<2.0	<0.5	<0.5	<2.0	<0.5	<0.5
	10/23/2007	<2.0	<0.5	<0.5	<2.0	<0.5	<0.5
	1/21/2008	<2.0	<0.5	<0.5	<2.0	<0.5	<0.5
	4/15/2008	<2.0	<0.5	<0.5	<2.0	<0.5	<0.5
	7/2/2008	<2.0	<0.5	<0.5	<2.0	<0.5	<0.5
	10/15/2008	<10	<0.5	<0.5	<0.5	<0.5	<0.5
	1/7/2009	<10	<0.5	<0.5	<0.5	<0.5	<0.5
	4/13/2009	<10	<0.5	<0.5	<0.5	<0.5	<0.5
	8/27/2009	<10	<0.5	<0.5	<0.5	<0.5	<0.5
	Well Decommissioned 11/13/2009						
MW-9	9/21/2004	<10	<0.5	<0.5	<0.5	NA	NA
	12/14/2004	<2.5	<0.5	<0.5	<2.0	NA	NA
	3/11/2005	<2.5	<0.5	<0.5	<2.0	NA	NA
	6/15/2005	<10	<0.5	<0.5	<2.0	NA	NA
	8/26/2005	<10	<0.5	<0.5	<2.0	NA	NA
	11/11/2005	<10	<0.5	<0.5	<2.0	NA	NA
	2/9/2006	<10	<0.5	<0.5	<2.0	NA	NA
	5/9/2006	<10	<0.5	<0.5	<2.0	2.8	<0.5
	8/10/2006	<10	<0.5	<0.5	<2.0	1.83	<0.5
	10/26/2006	<10	<0.5	<0.5	<2.0	3.07	<0.5
	1/25/2007	<2.0	<0.5	<0.5	<2.0	2.92	<0.5
	4/26/2007	<2.0	<0.5	<0.5	<2.0	<0.5	<0.5
	7/25/2007	<2.0	<0.5	<0.5	<2.0	<0.5	<0.5
	10/23/2007	<2.0	<0.5	<0.5	<2.0	<0.5	<0.5
	1/21/2008	<2.0	<0.5	<0.5	<2.0	1.18	<0.5
	4/15/2008	<2.0	<0.5	<0.5	<2.0	<0.5	<0.5
	7/2/2008	<2.0	<0.5	<0.5	<2.0	2.07	<0.5
	10/15/2008	<10	<0.5	<0.5	<0.5	1.5	<0.5
	1/7/2009	<10	<0.5	<0.5	<0.5	1.4	<0.5
	4/13/2009	<10	<0.5	<0.5	<0.5	0.97	<0.5
8/26/2009	<10	<0.5	<0.5	<0.5	2.6	<0.5	
Well Decommissioned 11/13/2009							
MW-10	9/22/2014	<200	<10	<10	<10	<10	<10
	12/22/2014	30 J	<2.5	<2.5	<2.5	<2.5	<2.5
	3/19/2015	85	<1.0	<1.0	<1.0	<1.0	<1.0
	6/3/2015	170 J	<5.0	<5.0	<5.0	<5.0	<5.0
	9/10/2015	<200	<10	<10	<10	<10	<10
	12/28/2015	<200	<10	<10	<10	<10	<10
	3/24/2016	140	<5	<5	<5	<5	<5
MW-10R	6/15/2016	<200	<10	<10	<10	<10	<10
	8/8/2016	91	<4.2	<4.2	<4.2	<4.2	<4.2
	9/21/2016	100	<2.0	<2.0	<2.0	<2.0	<2.0
MW-11	9/22/2014	69	<0.5	<0.5	<0.5	<0.5	<0.5
	12/22/2014	15	<0.5	<0.5	<0.5	<0.5	<0.5
	3/19/2015	3.5 J	<0.5	<0.5	<0.5	<0.5	<0.5
	6/3/2015	<2.1	<0.5	<0.5	<0.5	<0.5	<0.5
	9/10/2015	<10	<0.5	<0.5	<0.5	<0.5	<0.5
	12/28/2015	<10	<0.5	<0.5	<0.5	<0.5	<0.5
	3/23/2016	<10	<0.5	<0.5	<0.5	<0.5	<0.5
	6/16/2016	<10	<0.5	<0.5	<0.5	<0.5	<0.5
9/21/2016	<10	<0.5	<0.5	<0.5	<0.5	<0.5	
EX-1	12/2/2009	150	<1.3	<1.3	<1.3	<1.3	<1.3
	3/16/2010	980	<1.3	2.4	27	<1.3	<1.3
	6/3/2010	570	<1.3	1.9	<1.3	<1.3	<1.3
	9/1/2010	470	<0.5	1.4	2	<0.5	<0.5
	12/2/2010	1,300	<2.0	3.6	15	<2.0	<2.0

**Table 2**  
**Historical Gasoline Oxygenates Results**  
**15101 Freedom Avenue, San Leandro, CA**

Monitoring Well	Date	TBA (µg/L)	DIPE (µg/L)	ETBE (µg/L)	TAME (µg/L)	1,2-DCA (µg/L)	EDB (µg/L)
EX-1 cont.	3/3/2011	690	<0.71	2.5	12	<0.71	<0.71
	5/19/2011	370	<0.71	1.9	13	<0.71	<0.71
	9/8/2011	32	<0.5	<0.5	0.53	<0.5	<0.5
	12/1/2011	1,200	<1.6	8.3	6.8	<1.2	<0.86
	3/2/2012	31	<0.5	<0.5	<0.5	<0.5	<0.5
	6/6/2012	390	<0.5	2.9	4.8	0.57	<0.5
	9/20/2012	170	<0.5	1.5	<0.5	<0.5	<0.5
	12/13/2012	210	<0.5	2.7	5.2	<0.5	<0.5
	3/27/2013	<10	<0.5	<0.5	<0.5	<0.5	<0.5
	6/10/2013	280	<0.5	4.0	1.6	<0.5	<0.5
	9/16/2013	450	<0.5	2.4	1.9	<0.5	<0.5
	12/5/2013	230	<0.5	1.7	5.5	<0.5	<0.5
	3/12/2014	48	<0.5	0.77	3.1	<0.5	<0.5
	6/5/2014	70	<0.5	1.1	3.9	0.69	<0.5
	9/22/2014	96	<0.5	0.94	5.6	<0.5	<0.5
	12/22/2014	91	<0.5	0.84	<0.5	<0.5	<0.5
	3/19/2015	<10	<0.5	<0.5	<0.5	<0.5	<0.5
	6/3/2015	35	<0.5	1.4	<0.5	<0.5	<0.5
	9/10/2015	<10	<0.5	<0.5	<0.5	<0.5	<0.5
	12/28/2015	38	<0.5	0.7	2.4	<0.5	<0.5
3/24/2016	<10	<0.5	<0.5	<0.5	<0.5	<0.5	
6/15/2016	<10	<0.5	<0.5	<0.5	<0.5	<0.5	
9/21/2016	<10	<0.5	<0.5	<0.5	<0.5	<0.5	
<b>EX-2</b>							
	12/2/2009	<63	<3.1	<3.1	<3.1	<3.1	<3.1
	3/16/2010	<100	<5.0	<5.0	<5.0	<5.0	<5.0
	6/3/2010	<100	<5.0	<5.0	<5.0	<5.0	<5.0
	9/1/2010	<50	<2.5	<2.5	<2.5	<2.5	<2.5
	12/2/2010	<100	<5.0	<5.0	<5.0	<5.0	<5.0
	3/3/2011	<100	<5.0	<5.0	<5.0	<5.0	<5.0
	5/19/2011	<100	<5.0	<5.0	<5.0	<5.0	<5.0
	9/8/2011	<25	<1.3	<1.3	<1.3	<1.3	<1.3
	12/1/2011	74	<3.2	<3.5	<2.8	<2.4	<1.7
	3/2/2012	<25	<1.3	<1.3	<1.3	<1.3	<1.3
	6/6/2012	<33	<1.7	<1.7	<1.7	<1.7	<1.7
	9/20/2012	<33	<1.7	<1.7	<1.7	<1.7	<1.7
	12/13/2012	<71	<3.6	<3.6	<3.6	<3.6	<3.6
	3/27/2013	<20	<1.0	<1.0	<1.0	<1.0	<1.0
	6/10/2013	32	<1.0	<1.0	<1.0	<1.0	<1.0
	9/20/2013	<20	<1.0	<1.0	<1.0	1.4	<1.0
	12/5/2013	30	<1.0	<1.0	<1.0	1.2	<1.0
	3/12/2014	<40	<2.0	<2.0	<2.0	<2.0	<2.0
	6/5/2014	<40	<2.0	<2.0	<2.0	<2.0	<2.0
	9/22/2014	<10	<0.5	<0.5	<0.5	1.1	<0.5
	12/22/2014	37	<0.5	<0.5	<0.5	0.8	<0.5
	3/19/2015	<10	<0.5	<0.5	<0.5	<0.5	<0.5
	6/3/2015	17 J	<1.0	<1.0	<1.0	<1.0	<1.0
	9/10/2015	<20	<1.0	<1.0	<1.0	<1.0	<1.0
	12/28/2015	<20	<1.0	<1.0	<1.0	<1.0	<1.0
	3/24/2016	<10	<0.5	<0.5	<0.5	<0.5	<0.5
<b>MPE Wells</b>							
MPE-1	8/4/2011	<500	<25	<25	<25	<25	<25
	9/26/2011	<500	<25	<25	600	<25	<25
	12/2/2011	830	<32	<35	750	<24	<17
	3/2/2012	<710	<36	<36	1,200	<36	<36
	6/6/2012	<630	<31	<31	430	<31	<31
	9/20/2012	<1,300	<63	<63	1,200	<63	<63
	12/14/2012	<1,300	<63	<63	940	<63	<63
	3/27/2013	<710	<36	<36	890	<36	<36
	6/10/2013	660	<13	<13	380	<13	<13
	9/17/2013	1,400	<13	<13	<13	<13	<13
	12/6/2013	1,500	<20	<20	30	<20	<20
	3/13/2014	1,100	<20	<20	160	<20	<20
	6/5/2014	FP	FP	FP	FP	FP	FP
	9/23/2014	420	<3.6	3.7	24	<3.6	<3.6
12/23/2014	<20	<1.0	<1.0	<1.0	<1.0	<1.0	

**Table 2**  
**Historical Gasoline Oxygenates Results**  
**15101 Freedom Avenue, San Leandro, CA**

Monitoring Well	Date	TBA (µg/L)	DIPE (µg/L)	ETBE (µg/L)	TAME (µg/L)	1,2-DCA (µg/L)	EDB (µg/L)
MPE-1 cont.	3/20/2015	<50	<2.5	<2.5	<2.5	<2.5	<2.5
	6/4/2015	<13	<5.0	<5.0	9.2	<5.0	<5.0
	9/11/2015	<100	<5.0	<5.0	85	<5.0	<5.0
	12/29/2015	<10	<0.5	<0.5	1.6	<0.5	<0.5
	3/24/2016	<10	<0.5	<0.5	<0.5	<0.5	<0.5
	6/16/2016	<10	<0.5	<0.5	0.67	<0.5	<0.5
	9/21/2016	<10	<0.5	<0.5	1.10	<0.5	<0.5
<b>2nd WBZ</b>							
MPE-2	8/4/2011	<330	<17	<17	<17	<17	<17
	9/26/2011	<330	<17	<17	<17	<17	<17
	12/2/2011	<66	<16	<17	<14	<12	<8.6
	3/2/2012	<330	<17	<17	<17	<17	<17
	6/7/2012	<250	<13	<13	<13	<13	<13
	9/21/2012	<250	<13	<13	<13	<13	<13
	12/14/2012	<250	<13	<13	<13	<13	<13
	3/28/2013	<400	<20	<20	<20	<20	<20
	6/11/2013	<250	<13	<13	<13	<13	<13
	9/17/2013	<250	<13	<13	<13	<13	<13
	12/5/2013	FP	FP	FP	FP	FP	FP
	3/12/2014	FP	FP	FP	FP	FP	FP
	6/5/2014	FP	FP	FP	FP	FP	FP
	9/23/2014	<130	<6.3	<6.3	<6.3	<6.3	<6.3
	12/23/2014	23 J	<4.2	<4.2	<4.2	<4.2	<4.2
	3/20/2015	57 J	<4.2	<4.2	5.2	<4.2	<4.2
	6/4/2015	66 J	<5.0	<5.0	<5.0	<5.0	<5.0
	9/11/2015	<140	<7.1	<7.1	<7.1	<7.1	<7.1
	12/29/2015	<130	<6.3	<6.3	<6.3	<6.3	<6.3
	3/24/2016	250	<6.3	<6.3	<6.3	<6.3	<6.3
6/16/2016	130	<5.0	<5.0	<5.0	<5.0	<5.0	
9/21/2016	210	<6.3	<6.3	<6.3	<6.3	<6.3	
<b>2nd WBZ</b>							
MW-1D	1/3/2008	111	<0.5	<0.5	<2.0	NA	NA
	1/22/2008	12.9	<0.5	<0.5	<2.0	<0.5	<0.5
	4/16/2008	<2.0	<0.5	<0.5	<2.0	<0.5	<0.5
	7/3/2008	<2.0	<0.5	<0.5	<2.0	<0.5	<0.5
	10/15/2008	<10	<0.5	<0.5	<0.5	<0.5	<0.5
	1/8/2009	<10	<0.5	<0.5	<0.5	<0.5	<0.5
	4/14/2009	<10	<0.5	<0.5	<0.5	<0.5	<0.5
	8/26/2009	<10	<0.5	<0.5	<0.5	<0.5	<0.5
	12/1/2009	<10	<0.5	<0.5	<0.5	<0.5	<0.5
	3/16/2010	<10	<0.5	<0.5	<0.5	<0.5	<0.5
	6/4/2010	<10	<0.5	<0.5	<0.5	<0.5	<0.5
	9/1/2010	<10	<0.5	<0.5	<0.5	<0.5	<0.5
	12/3/2010	<10	<0.5	<0.5	<0.5	<0.5	<0.5
	3/3/2011	<10	<0.5	<0.5	<0.5	<0.5	<0.5
	5/19/2011	<10	<0.5	<0.5	<0.5	<0.5	<0.5
	9/8/2011	<10	<0.5	<0.5	<0.5	<0.5	<0.5
	12/1/2011	<1.5	<0.36	<0.40	<0.32	<0.28	<0.19
	3/2/2012	<10	<0.5	<0.5	<0.5	<0.5	<0.5
	6/6/2012	<10	<0.5	<0.5	<0.5	<0.5	<0.5
	9/20/2012	<10	<0.5	<0.5	<0.5	<0.5	<0.5
	12/13/2012	<10	<0.5	<0.5	<0.5	<0.5	<0.5
	3/27/2013	<10	<0.5	<0.5	<0.5	<0.5	<0.5
	6/10/2013	<10	<0.5	<0.5	<0.5	<0.5	<0.5
	9/16/2013	<10	<0.5	<0.5	<0.5	<0.5	<0.5
	12/5/2013	<10	<0.5	<0.5	<0.5	<0.5	<0.5
	3/12/2014	<10	<0.5	<0.5	<0.5	<0.5	<0.5
	6/5/2014	<10	<0.5	<0.5	<0.5	<0.5	<0.5
	9/22/2014	<10	<0.5	<0.5	<0.5	<0.5	<0.5
	12/23/2014	<10	<0.5	<0.5	<0.5	<0.5	<0.5
	3/19/2015	<10	<0.5	<0.5	<0.5	<0.5	<0.5
6/3/2015	<2.1	<0.5	<0.5	<0.5	<0.5	<0.5	
9/10/2015	<10	<0.5	<0.5	<0.5	<0.5	<0.5	

**Table 2**  
**Historical Gasoline Oxygenates Results**  
**15101 Freedom Avenue, San Leandro, CA**

Monitoring Well	Date	TBA (µg/L)	DIPE (µg/L)	ETBE (µg/L)	TAME (µg/L)	1,2-DCA (µg/L)	EDB (µg/L)
MW-3D	1/3/2008	37.3	<0.5	3.12	15.3	NA	NA
	1/22/2008	15.6	<0.5	3.1	15.3	<0.5	<0.5
	4/16/2008	17.7	<0.5	<0.5	<2.0	<0.5	<0.5
	7/3/2008	<2.0	<0.5	<0.5	7.45	<0.5	<0.5
	10/16/2008	<10	<0.5	<0.5	4.7	<0.5	<0.5
	1/8/2009	<10	<0.5	<0.5	3.4	<0.5	<0.5
	4/14/2009	<10	<0.5	<0.5	5	<0.5	<0.5
	8/26/2009	<10	<0.5	<0.5	1.6	<0.5	<0.5
	12/1/2009	<10	<0.5	<0.5	2.2	<0.5	<0.5
	3/16/2010	<10	<0.5	<0.5	0.65	<0.5	<0.5
	6/4/2010	<10	<0.5	<0.5	1.8	<0.5	<0.5
	9/1/2010	<10	<0.5	<0.5	<0.5	<0.5	<0.5
	12/3/2010	<10	<0.5	<0.5	0.93	<0.5	<0.5
	3/3/2011	<10	<0.5	<0.5	1.0	<0.5	<0.5
	5/19/2011	<10	<0.5	<0.5	<0.5	<0.5	<0.5
	9/8/2011	<10	<0.5	<0.5	<0.5	<0.5	<0.5
	12/1/2011	<1.5	<0.36	<0.40	0.52	<0.28	<0.19
	3/2/2012	<10	<0.5	<0.5	<0.5	<0.5	<0.5
	6/6/2012	<10	<0.5	<0.5	<0.5	<0.5	<0.5
	9/20/2012	<10	<0.5	<0.5	<0.5	<0.5	<0.5
	12/13/2012	<10	<0.5	<0.5	<0.5	<0.5	<0.5
	3/27/2013	<10	<0.5	<0.5	<0.5	<0.5	<0.5
	6/10/2013	<10	<0.5	<0.5	<0.5	<0.5	<0.5
	9/16/2013	<10	<0.5	<0.5	<0.5	<0.5	<0.5
	12/5/2013	<10	<0.5	<0.5	<0.5	<0.5	<0.5
	3/13/2014	<10	<0.5	<0.5	<0.5	<0.5	<0.5
	6/5/2014	<10	<0.5	<0.5	<0.5	<0.5	<0.5
	9/22/2014	<10	<0.5	<0.5	<0.5	<0.5	<0.5
	12/23/2014	<10	<0.5	<0.5	<0.5	<0.5	<0.5
	3/19/2015	<10	<0.5	<0.5	<0.5	<0.5	<0.5
	6/3/2015	<2.1	<0.5	<0.5	<0.5	<0.5	<0.5
	9/10/2015	<10	<0.5	<0.5	<0.5	<0.5	<0.5
MW-4D	1/4/2008	25	<0.5	<0.5	<2.0	NA	NA
	1/22/2008	124	<0.5	4.9	3.32	<0.5	<0.5
	4/15/2008	25.7	<0.5	<0.5	<2.0	<0.5	<0.5
	7/3/2008	3.38	<0.5	<0.5	<2.0	<0.5	<0.5
	10/16/2008	<10	<0.5	<0.5	<0.5	<0.5	<0.5
	1/8/2009	<10	<0.5	<0.5	<0.5	<0.5	<0.5
	4/14/2009	<10	<0.5	<0.5	<0.5	<0.5	<0.5
	8/27/2009	<10	<0.5	<0.5	<0.5	<0.5	<0.5
	12/1/2009	<10	<0.5	<0.5	<0.5	<0.5	<0.5
	3/16/2010	<10	<0.5	<0.5	<0.5	<0.5	<0.5
	6/4/2010	<10	<0.5	<0.5	<0.5	<0.5	<0.5
	9/1/2010	<10	<0.5	<0.5	<0.5	<0.5	<0.5
	12/3/2010	<10	<0.5	<0.5	<0.5	<0.5	<0.5
	3/3/2011	<10	<0.5	<0.5	<0.5	<0.5	<0.5
	5/19/2011	<10	<0.5	<0.5	<0.5	<0.5	<0.5
	9/8/2011	<10	<0.5	<0.5	<0.5	<0.5	<0.5
	12/1/2011	<1.5	<0.36	<0.40	<0.32	<0.28	<0.19
	3/2/2012	<10	<0.5	<0.5	<0.5	<0.5	<0.5
	6/6/2012	<10	<0.5	<0.5	<0.5	<0.5	<0.5
	9/20/2012	<10	<0.5	<0.5	<0.5	<0.5	<0.5
	12/13/2012	<10	<0.5	<0.5	<0.5	<0.5	<0.5
	3/27/2013	<10	<0.5	<0.5	<0.5	<0.5	<0.5
	6/10/2013	<10	<0.5	<0.5	<0.5	<0.5	<0.5
	9/16/2013	<10	<0.5	<0.5	<0.5	<0.5	<0.5
	12/6/2013	<10	<0.5	<0.5	<0.5	<0.5	<0.5
	3/13/2014	<10	<0.5	<0.5	<0.5	<0.5	<0.5
	6/6/2014	<10	<0.5	<0.5	<0.5	<0.5	<0.5
	9/23/2014	<10	<0.5	<0.5	<0.5	<0.5	<0.5
	12/23/2014	<10	<0.5	<0.5	<0.5	<0.5	<0.5
	3/19/2015	<10	<0.5	<0.5	<0.5	<0.5	<0.5
	6/3/2015	4.8 J	<0.5	<0.5	<0.5	<0.5	<0.5
	9/10/2015	<10	<0.5	<0.5	<0.5	<0.5	<0.5

**Table 2**  
**Historical Gasoline Oxygenates Results**  
**15101 Freedom Avenue, San Leandro, CA**

Monitoring Well	Date	TBA (µg/L)	DIPE (µg/L)	ETBE (µg/L)	TAME (µg/L)	1,2-DCA (µg/L)	EDB (µg/L)
1573 153 RD	1/3/2008	21	<0.5	<0.5	<2.0	<0.5	<2.0
	7/2/2008	<2.0	<0.5	<0.5	<2.0	<0.5	<0.5
	10/16/2008	<10	<0.5	<0.5	<0.5	<0.5	<0.5
EB-PMP	1/21/2008	<2.0	<0.5	<0.5	<2.0	<0.5	<0.5
EB-PRB	1/21/2008	<2.0	<0.5	<0.5	<2.0	<0.5	<0.5
EB-PMP2	1/22/2008	<2.0	<0.5	<0.5	<2.0	<0.5	<0.5
EB-PRB2	1/22/2008	<2.0	<0.5	<0.5	<2.0	<0.5	<0.5
ESL		12	NE	NE	NE	0.5	0.05

Notes:  
August 8, 2002 was the first time that samples were analyzed for Gasoline Oxygenates  
<: Not detected above the laboratory reporting limit.  
NA: Not Analyzed. Well MW-8 was inaccessible during the 1Q05 & well MW-7 (1Q06) car was parked over each well.  
NE: Not Established  
TBA: tert-Butyl Alcohol  
DIPE: Isopropyl Ether  
ETBE: Ethyl tert-Butyl Ether  
TAME: Methyl tert-Amyl Ether  
ESL: Environmental Screening Levels per CRWQCB SFBay Region (Revised February 2016)  
Tier 1 ESL (Groundwater Screening Levels (groundwater is a drinking water resource)  
MW-8 and MW-9 were decommissioned November 13, 2009  
FP: Groundwater not sampled due to presence of free-product in MW-6

**Table 3**  
**Effluent Chemical Analytical Results**  
**and Operational History of Remediation System**  
15101 Freedom Ave, San Leandro, CA

Date	Volume (gallons)	TPH-g (µg/L)	TPH-d (µg/L)	TPH-mo (µg/L)	Benzene (µg/L)	Toluene (µg/L)	Ethylbenzene (µg/L)	Total Xylenes (µg/L)	COD (mg/L)	TSS (mg/L)	pH
<b>2009</b>											
8-Oct-2009	15,351	<50	120 <sup>Y</sup>	NA	NA	NA	NA	NA	NA	NA	NA
19-Nov-2009	8,287	<50	<50	<300	<0.5	<0.5	<0.5	<0.5	<10	<5	7.7
9-Dec-2009	0	Installation of GWETS									
16-Dec-2009	20,000	<50	<50	<300	<0.5	0.65 C	<0.5	0.84 C	<10	<5	7.4
<b>2010</b>											
18-Jan-2010	215,453	<50	<50	<300	<0.5	<0.5	<0.5	<0.5	<10	<5	7.4
15-Feb-2010	297,560	<50	<50	<300	<0.5	<0.5	<0.5	<0.5	11	<5	6.7
15-Mar-2010	475,245	<50	<50	<300	<0.5	<0.5	<0.5	<0.5	<10	<5.0	6.5
19-Apr-2010	621,180	<50	<50	<300	<0.5	<0.5	<0.5	<0.5	<10	8	6.6
17-May-2010	705,770	<50	<50	<300	<0.5	<0.5	<0.5	<0.5	<10	8	6.7
16-Jun-2010	825,200	<50	<50	<300	<0.5	<0.5	<0.5	<0.5	17	9	6.8
19-Jul-2010	910,652	<50	<50	<300	<0.5	<0.5	<0.5	<0.5	<10	8	6.6
16-Aug-2010	939,935	<50	<50	<300	<0.5	<0.5	<0.5	<0.5	<10	6	6.6
28-Sep-2010	970,450	<50	<50	<300	<0.5	<0.5	<0.5	<0.5	<10	10	6.8
26-Oct-2010	1,013,700	<50	<50	<300	<0.5	<0.5	<0.5	<0.5	<10	<5	7.2
15-Nov-2010	1,052,591	<50	<50	<300	<0.5	<0.5	<0.5	<0.5	<10	<5	6.5
7-Dec-2010	1,100,492	<50	<50	<300	<0.5	<0.5	<0.5	<0.5	<10	6	6.6
<b>2011</b>											
11-Jan-2011	1,179,075	<50	<50	<300	<0.5	<0.5	<0.5	<0.5	12	6	6.6
10-Feb-2011	1,249,569	<50	<50	<300	<0.5	<0.5	<0.5	<0.5	<10	<5	6.6
14-Mar-2011	1,336,784	<50	<50	<300	<0.5	<0.5	<0.5	<0.5	<10	<5	6.5
11-Apr-2011	1,364,272	<50	<50	<300	<0.5	<0.5	<0.5	<0.5	<10	6	6.5
10-May-2011	1,466,472	<50	<50	<300	<0.5	<0.5	<0.5	<0.5	12	7	6.6
7-Jun-2011	1,532,263	<50	<50	<300	<0.5	<0.5	<0.5	<0.5	<10	6	6.6



**Table 3**  
**Effluent Chemical Analytical Results**  
**and Operational History of Remediation System**  
15101 Freedom Ave, San Leandro, CA

Date	Volume (gallons)	TPH-g (µg/L)	TPH-d (µg/L)	TPH-mo (µg/L)	Benzene (µg/L)	Toluene (µg/L)	Ethylbenzene (µg/L)	Total Xylenes (µg/L)	COD (mg/L)	TSS (mg/L)	pH
28-Jul-2011	1,573,295	<50	<50	<300	<0.5	<0.5	<0.5	<0.5	<10	5	6.3
25-Aug-2011	1,613,935	77	<50	<300	<0.5	<0.5	<0.5	<0.5	<10	<5	7.1
23-Sep-2011	1,631,273	<50	<50	<300	<0.5	<0.5	<0.5	<0.5	<10	<5	6.7
27-Oct-2011	1,642,277	<50	<50	<300	<0.5	<0.5	<0.5	<0.5	<10	7	7.1
18-Nov-2011	1,676,170	<50	<50	<300	<0.5	<0.5	<0.5	<0.5	<10	<5	7.8
1-Dec-2011	1,694,889	<50	<50	<300	<0.5	<0.5	<0.5	<0.5	<10	<5	6.97
<b>2012</b>											
19-Jan-2012	1,715,163	<50	<50	<300	<0.5	<0.5	<0.5	<0.5	<10	<5	7.02
23-Feb-2012	1,794,185	<50	<50	<300	<0.5	<0.5	<0.5	<0.5	<10	<5	6.98
20-Mar-2012	1,803,832	<50	<50	<300	<0.5	<0.5	<0.5	<0.5	<10	7	7.02
17-Apr-2012	1,876,439	<50	<50	<300	<0.5	<0.5	<0.5	<0.5	NA	NA	6.95
29-May-2012	1,900,111	<50	<50	<300	<0.5	<0.5	<0.5	<0.5	NA	NA	6.89
11-Jun-2012	1,914,130	<50	<50	<300	<0.5	<0.5	<0.5	<0.5	NA	NA	7.1
12-Jul-2012	1,943,456	<50	<50	<300	<0.5	<0.5	<0.5	<0.5	NA	NA	7.3
17-Aug-2012	1,955,438	<50	<52	<310	<0.5	<0.5	<0.5	<0.5	NA	NA	7.04
17-Sep-2012	1,979,852	<50	<54	<330	<0.5	<0.5	<0.5	<0.5	NA	NA	7.02
23-Oct-2012	1,989,022	<50	<49	<290	<0.5	<0.5	<0.5	<0.5	NA	NA	6.95
12-Nov-2012	1,995,170	<50	<50	<300	<0.5	<0.5	<0.5	<0.5	NA	NA	6.90
4-Dec-2012	2,024,040	<50	<49	<290	<0.5	<0.5	<0.5	<0.5	NA	NA	6.86
<b>2013</b>											
7-Jan-2013	2,099,002	<50	<50	<300	<0.5	<0.5	<0.5	<0.5	NA	NA	7.01
14-Feb-2013	2,186,595	<50	<50	<300	<0.5	<0.5	<0.5	<0.5	NA	NA	7.08
14-Mar-2013	2,193,121	<50	<50	<300	<0.5	<0.5	<0.5	<0.5	NA	NA	6.98
12-Apr-2013	2,198,793	<50	<50	<300	<0.5	<0.5	<0.5	<0.5	NA	NA	6.83
10-Jun-2013	2,273,686	<50	<58	<350	<0.5	<0.5	<0.5	<0.5	NA	NA	6.91

**Table 3**  
**Effluent Chemical Analytical Results**  
**and Operational History of Remediation System**  
15101 Freedom Ave, San Leandro, CA

Date	Volume (gallons)	TPH-g (µg/L)	TPH-d (µg/L)	TPH-mo (µg/L)	Benzene (µg/L)	Toluene (µg/L)	Ethylbenzene (µg/L)	Total Xylenes (µg/L)	COD (mg/L)	TSS (mg/L)	pH
5-Jul-2013	2,282,444	<50	<49	<290	<0.5	<0.5	<0.5	<0.5	NA	NA	6.87
15-Aug-2013	2,403,250	<50	<50	<300	<0.5	<0.5	<0.5	<0.5	NA	NA	6.64
24-Sep-2013	2,449,583	<50	<50	<300	<0.5	<0.5	<0.5	<0.5	NA	NA	6.59
28-Oct-2013	2,551,538	<50	<50	<300	<0.5	<0.5	<0.5	<0.5	NA	NA	6.71
14-Nov-2013	2,665,016	<50	<49	<290	<0.5	<0.5	<0.5	<0.5	NA	NA	6.53
6-Dec-2013	2,770,675	<50	<49	<290	<0.5	<0.5	<0.5	<0.5	NA	NA	6.44
<b>2014</b>											
9-Jan-2014	2,884,292	<50	<50	<300	<0.5	<0.5	<0.5	<0.5	NA	NA	6.49
18-Feb-2014	2,953,173	<50	<50	<300	<0.5	<0.5	<0.5	<0.5	NA	NA	6.66
14-Mar-2014	2,977,698	<50	<50	<300	<0.5	<0.5	<0.5	<0.5	NA	NA	6.58
17-Apr-2014	3,035,679	89 Y	<50	<300	<0.5	<0.5	<0.5	<0.5	NA	NA	6.60
15-May-2014	3,054,723	<50	<50	<300	<0.5	<0.5	<0.5	<0.5	NA	NA	6.19
16-Jun-2014	55-Gallon polishing drum replaced due to leak										
17-Jun-2014	3,070,826	<50	<49	<290	<0.5	<0.5	<0.5	<0.5	NA	NA	6.74
21-Jul-2014	3,136,493	<50	<50	<300	<0.5	<0.5	<0.5	<0.5	NA	NA	6.92
13-Aug-2014	3,229,086	<50	<49	<290	<0.5	<0.5	<0.5	<0.5	NA	NA	6.50
9-Sep-2014	3,360,607	<50	<49	<290	<0.5	<0.5	<0.5	<0.5	NA	NA	6.44
13-Oct-2014	3,431,247	<50	<49	<290	<0.5	<0.5	<0.5	<0.5	NA	NA	6.39
18-Nov-2014	3,504,809	<50	<50	<300	<0.5	<0.5	<0.5	<0.5	NA	NA	6.51
8-Dec-2014	3,544,218	<50	<50	<300	<0.5	<0.5	<0.5	<0.5	NA	NA	6.65
<b>2015</b>											
13-Jan-2015	3,560,504	<50	<50	<300	<0.5	<0.5	<0.5	<0.5	NA	NA	6.44
9-Feb-2015	3,560,780	<50	<50	<300	<0.5	<0.5	<0.5	<0.5	NA	NA	6.22
20-Mar-2015	3,560,801	<50	<50	<300	<0.5	<0.5	<0.5	<0.5	NA	NA	6.38
15-Apr-2015	3,575,395	<50	<50	<300	<0.5	<0.5	<0.5	<0.5	NA	NA	6.40
21-May-2015	3,577,714	<50	<50	<300	<0.5	<0.5	<0.5	<0.5	NA	NA	6.29
4-Jun-2015	3,580,407	<50	<50	<300	<0.5	<0.5	<0.5	<0.5	NA	NA	6.66
14-Jul-2015	3,629,420	<50	<50	<300	<0.5	<0.5	<0.5	<0.5	NA	NA	6.34
18-Aug-2015	3,672,646	<50	<50	<300	<0.5	<0.5	<0.5	<0.5	NA	NA	6.21
23-Sep-2015	3,708,165	<50	<50	<300	<0.5	<0.5	<0.5	<0.5	NA	NA	6.32

**Table 3**  
**Effluent Chemical Analytical Results**  
**and Operational History of Remediation System**  
15101 Freedom Ave, San Leandro, CA

Date	Volume (gallons)	TPH-g (µg/L)	TPH-d (µg/L)	TPH-mo (µg/L)	Benzene (µg/L)	Toluene (µg/L)	Ethylbenzene (µg/L)	Total Xylenes (µg/L)	COD (mg/L)	TSS (mg/L)	pH
27-Oct-2015	3,753,333	<50	<50	<300	<0.5	<0.5	<0.5	<0.5	NA	NA	6.50
19-Nov-2015	3,782,192	<50	<50	<300	<0.5	<0.5	<0.5	<0.5	NA	NA	6.43
14-Dec-2015	3,829,993	<50	<50	<300	<0.5	<0.5	<0.5	<0.5	NA	NA	6.63
<b>2016</b>											
12-Jan-2016	3,863,743	<50	<51	<310	<0.5	<0.5	<0.5	<0.5	NA	NA	6.39
5-Feb-2016	3,917,264	<50	<50	<300	<0.5	<0.5	<0.5	<0.5	NA	NA	6.32
7-Mar-2016	3,972,753	<50	<50	<300	<0.5	<0.5	<0.5	<0.5	NA	NA	6.82
4-Aug-2016	3,973,465	<50	<50	<300	<0.5	<0.5	<0.5	<0.5	NA	NA	<b>6.55</b>
<b>22-Sep-2016</b>	<b>3,973,478</b>	<b>&lt;50</b>	<b>61 Y</b>	<b>&lt;300</b>	<b>&lt;0.5</b>	<b>&lt;0.5</b>	<b>&lt;0.5</b>	<b>&lt;0.5</b>	<b>NA</b>	<b>NA</b>	<b>6.51</b>

Note:  
NA: Not Available/Not Applicable  
< : Less than Laboratory-reporting limit  
Y: Sample exhibits chromatographic pattern which does not resemble standard  
In October and November 2009 discharge occurred only during MPE events  
GWETS and totalizer installed in December 2009.  
Week # 1 sampling conducted on Oct 8, 2009  
C: Presence confirmed, but RPD between column exceeds 40%  
Volume discharged during the October 2009 MPE event was 18,669 gallons  
Volume discharged during the November 2009 MPE event was 10,507 gallons  
Volume discharged during the December 2009 MPE event was 20,298 gallons  
Volume discharged during the February 2010 MPE event was 6,339 gallons  
Volume discharged during the March 2010 MPE event was 3,810 gallons  
Volume discharged during the June 2010 MPE event was 15,600 gallons  
Volume discharged during the August 2010 MPE event was 1,421 gallons  
Volume discharged during the October 2010 MPE event was 13,282 gallons  
SOMA ceased COD and TSS testing based on a request from OLSA dated April 5, 2012

**Table 4**  
**Cumulative Masses of Petroleum Hydrocarbons Removed from**  
**the Groundwater Since Installation of the Treatment System**  
15101 Freedom Ave, San Leandro, CA

Date	Volume (gallons)	Influent Concentration (µg/L)					Mass removed (pounds)				
		TPH-g	Benzene	Toluene	Ethyl- benzene	Total Xylenes	TPH-g	Benzene	Toluene	Ethyl- benzene	Total Xylenes
<b>2009</b>											
9-Dec-2009	0	Installation of GWETS, began discharging treated groundwater to site sewer main									
<b>2010</b>											
18-Jan-2010	215,453	1,900	79	32.00	2.4	260	3.41	0.14	0.06	0.00	0.47
19-Apr-2010	621,180	2,100	75	28	56	332	10.50	0.40	0.15	0.19	1.59
19-Jul-2010	910,652	56 <sup>Y</sup>	<0.5	<0.5	<0.5	<0.5	10.64	0.40	0.15	0.19	1.59
26-Oct-2010	1,013,700	2,600	200	25	68	405	12.87	0.57	0.17	0.25	1.94
<b>2011</b>											
11-Jan-2011	1,179,075	1,700	80	19	50	295	15.21	0.68	0.20	0.32	2.34
11-Apr-2011	1,364,272	1,200	41	3.3	23	185	17.06	0.75	0.20	0.36	2.63
28-Jul-2011	1,573,295	540	21	2.8	5.4	49	18.00	0.78	0.21	0.37	2.71
27-Oct-2011	1,642,277	<50	1.50	<0.5	<0.5	2.9	18.00	0.78	0.21	0.37	2.71
<b>2012</b>											
19-Jan-2012	1,715,163	110 <sup>Y</sup>	<0.5	<0.5	<0.5	<0.5	18.07	0.78	0.21	0.37	2.71
17-Apr-2012	1,876,439	1,100	60	6.8	24	161	19.54	0.87	0.22	0.40	2.93
12-Jul-2012	1,943,456	320	30	1.6	15	34	19.72	0.88	0.22	0.41	2.95
23-Oct-2012	1,989,022	1,400 <sup>Y</sup>	130	12	42	153	20.25	0.93	0.22	0.42	3.01
<b>2013</b>											
7-Jan-2013	2,099,002	1,500	66	9.8	37	228	21.63	0.99	0.23	0.46	3.22
12-Apr-2013	2,198,793	1,600	110	3.8	64	131	22.96	1.08	0.24	0.51	3.32
5-Jul-2013	2,282,444	680	71	1.8	22	33.9	23.43	1.13	0.24	0.52	3.35
28-Oct-2013	2,551,538	4,900	88	49	150	583	34.41	1.33	0.35	0.86	4.65
<b>2014</b>											
9-Jan-2014	2,884,292	590	17	4.1	9.1	68	36.04	1.38	0.36	0.89	4.84
17-Apr-2014	3,035,679	650	19	0.67	16	50.1	36.86	1.40	0.36	0.91	4.91
21-Jul-2014	3,136,493	1,000	54	1.70	35	71.1	37.70	1.45	0.36	0.94	4.97
13-Oct-2014	3,431,247	370	6.50	0.75	6.30	41	38.61	1.46	0.36	0.95	5.07
<b>2015</b>											
13-Jan-2015	3,560,504	550	21	<0.5	23	19	39.20	1.48	0.36	0.98	5.09
15-Apr-2015	3,575,395	1,300	46	3.30	52	136	39.36	1.49	0.36	0.98	5.10
14-Jul-2015	3,629,420	1,000	31	4.90	24	94	39.81	1.50	0.37	0.99	5.15
27-Oct-2015	3,753,333	420	9.50	0.73	3	24	40.24	1.51	0.37	1.00	5.17
<b>2016</b>											
12-Jan-2016	3,863,743	79	2.20	<0.5	<0.5	<0.5	40.32	1.52	0.37	1.00	5.17
<b>4-Aug-2016</b>	<b>3,973,465</b>	<b>280</b>	<b>0.60</b>	<b>3.00</b>	<b>2.40</b>	<b>12.70</b>	<b>40.57</b>	<b>1.52</b>	<b>0.37</b>	<b>1.00</b>	<b>5.17</b>

Notes:

<: Below laboratory-reporting limit

Y: sample exhibits chromatographic pattern which does not resemble standard

**Table 5**

**MPE Operational Data  
August 2016**

**15101 Freedom Ave,  
San Leandro, California**

DATE	TIME	PID (ppmv)	OXIDIZER TEMPERATURE (°F)	TOTAL VACUUM (In of Hg)	STINGER VACUUM (In of Hg)	VAPOR FLOW RATE (scfm)	VAPOR DILUTION (scfm)	WELL FLOW (scfm)	GROUND WATER TOTALIZER (gallons)	COMMENTS
8/2/2016	1030								0	begin extraction from MW-10R
	1100	187	1,400	26.3	22.4	49	12	37		
	1200	182	1,401	26.3	22.4	49	12	37		Effluent = 0
	1300	180	1,400	26.3	22.5	49	12	37		
	1400	177	1,402	26.4	22.5	47	12	35		
	1500	169	1,400	26.4	22.5	47	12	35		
	1600	161	1,400	26.4	22.5	47	12	35		
8/3/2016	1700	153	1,400	26.4	22.5	47	12	35		Shut down
	700	142	1,401	26.4	22.5	47	12	35		Restart
	800	137	1,400	26.4	22.5	47	12	35		
	900	130	1,400	26.4	22.5	47	12	35		
	1000	122	1,400	26.4	22.5	47	12	35		
	1100	117	1,402	26.5	22.6	46	12	34		
	1200	112	1,400	26.5	22.6	46	12	34		
	1300	107	1,401	26.5	22.6	46	12	34		
	1400	102	1,400	26.5	22.6	46	12	34		
	1500	95	1,402	26.5	22.6	46	12	34		
8/4/2016	1600	87	1,400	26.5	22.5	46	12	34		
	1700	82	1,401	26.5	22.6	46	12	34		Shut down
	700	87	1,401	26.2	21.8	50	12	38	415	Restart
	800	82	1,400	26.2	21.8	50	12	38		
	900	77	1,400	26.2	21.8	50	12	38		
	1000	73	1,400	26.1	21.7	52	12	40		
	1100	70	1,402	26.1	21.7	52	12	40		
	1200	68	1,400	26.1	21.7	52	12	40		
	1300	64	1,400	26.1	21.9	52	12	40		
	1400	61	1,402	26.1	21.9	52	12	40		
	1500	57	1,400	26.1	21.9	52	12	40		
	1600	52	1,401	26.2	21.8	50	12	38		
	1700	55	1,400	26.2	21.8	50	12	38		Shut down
8/5/2016	700	67	1,402	25.8	22.4	57	12	45		Restart
	800	54	1,400	25.8	22.4	57	12	45		

**Table 5**

**MPE Operational Data  
August 2016**

**15101 Freedom Ave,  
San Leandro, California**

DATE	TIME	PID (ppmv)	OXIDIZER TEMPERATURE (°F)	TOTAL VACUUM (In of Hg)	STINGER VACUUM (In of Hg)	VAPOR FLOW RATE (scfm)	VAPOR DILUTION (scfm)	WELL FLOW (scfm)	GROUND WATER TOTALIZER (gallons)	COMMENTS
	900	50	1,400	25.8	22.3	57	12	45		
	1000	48	1,400	25.9	22.3	55	12	43		
	1100	45	1,401	25.9	22.3	55	12	43		
	1200	43	1,400	25.9	22.5	55	12	43		
	1300	49	1,400	25.9	22.5	55	12	43		
	1400	40	1,401	25.9	22.5	55	12	43		
	1500	37	1,400	25.8	22.5	57	12	45	711	End Extraction, system shut down

**Groundwater extracted = 711 gallons = 0.34 gpm**

**Time of extraction = 2,085 minutes = 34.75 hours = 1.45 days**

**Notes**

- ppmv parts per million vapor
- In of Hg inches of mercury
- °F degrees Fahrenheit
- scfm standard cubic feet per minute
- PID photo-ionization detector (onboard gas analyzer)

**Table 6**

**MPE Extraction Data and VOC Mass Removal Rate**

**August 2016**

15101 Freedom Ave,  
San Leandro, California

WELL	COMMENT	DATE	CLOCK TIME	INCREMENTAL	ELAPSED	Air Flow Rate, Q			PID		MASS REMOVAL				
				TIME	TIME	SCFM	ft <sup>3</sup> of extracted air	Moles of extracted air	ppmv as hexane	VOC mole %	lb VOC mass removal as hexane	lbs/min	lbs/day		
				minutes	minutes										
MW-10R	START	8/2/2016	1030	0	0										
			1100	30	30	49	1,466	3.868	187	0.0002	0.062	0.002	3		
			1200	60	90	49	2,932	7.737	182	0.0002	0.121	0.002	3		
			1300	60	150	49	2,932	7.737	180	0.0002	0.120	0.002	3		
			1400	60	210	47	2,837	7.486	177	0.0002	0.114	0.002	3		
			1500	45	255	47	2,128	5.614	169	0.0002	0.082	0.002	3		
	PAUSE START	8/3/2016	1600	60	315	47	2,837	7.486	161	0.0002	0.104	0.002	2		
			1700	60	375	47	2,837	7.486	153	0.0002	0.099	0.002	2		
			700	30	405	47	1,419	3.743	142	0.0001	0.046	0.002	2		
			800	60	465	47	2,837	7.486	137	0.0001	0.088	0.001	2		
			900	60	525	47	2,837	7.486	130	0.0001	0.084	0.001	2		
			1000	60	585	47	2,837	7.486	122	0.0001	0.079	0.001	2		
			1100	60	645	46	2,742	7.235	117	0.0001	0.073	0.001	2		
			1200	60	705	46	2,742	7.235	112	0.0001	0.070	0.001	2		
			1300	60	765	46	2,742	7.235	107	0.0001	0.067	0.001	2		
			1400	30	795	46	1,371	3.617	102	0.0001	0.032	0.001	2		
			1500	60	855	46	2,742	7.235	95	0.0001	0.059	0.001	1		
			1600	60	915	46	2,742	7.235	87	0.0001	0.054	0.001	1		
			1700	60	975	46	2,742	7.235	82	0.0001	0.051	0.001	1		
			PAUSE START	8/4/2016	700	15	990	50	757	1.997	87	0.0001	0.015	0.001	1
					800	60	1,050	50	3,028	7.988	82	0.0001	0.056	0.001	1
					900	60	1,110	50	3,028	7.988	77	0.0001	0.053	0.001	1
					1000	60	1,170	52	3,123	8.239	73	0.0001	0.052	0.001	1
					1100	60	1,230	52	3,123	8.239	70	0.0001	0.050	0.001	1
	1200	60			1,290	52	3,123	8.239	68	0.0001	0.048	0.001	1		
	1300	60			1,350	52	3,123	8.239	64	0.0001	0.045	0.001	1		
	1400	60			1,410	52	3,123	8.239	61	0.0001	0.043	0.001	1		
	1500	60			1,470	52	3,123	8.239	57	0.0001	0.040	0.001	1		
	1600	60			1,530	50	3,028	7.988	52	0.0001	0.036	0.001	1		
	1700	60			1,590	50	3,028	7.988	55	0.0001	0.038	0.001	1		
	PAUSE START	8/5/2016			700	15	1,605	57	852	2.248	67	0.0001	0.013	0.001	1
800			60	1,665	57	3,408	8.993	54	0.0001	0.042	0.001	1			

**Table 6**

**MPE Extraction Data and VOC Mass Removal Rate**

**August 2016**  
 15101 Freedom Ave,  
 San Leandro, California

WELL	COMMENT	DATE	CLOCK TIME	INCREMENTAL TIME	ELAPSED TIME	Air Flow Rate, Q			PID		MASS REMOVAL		
						SCFM	ft <sup>3</sup> of extracted air	Moles of extracted air	ppmv as hexane	VOC mole %	lb VOC mass removal as hexane	lbs/min	lbs/day
			900	60	1,725	57	3,408	8.993	50	0.0001	0.039	0.001	1
			1000	60	1,785	55	3,313	8.742	48	0.0000	0.036	0.001	1
			1100	60	1,845	55	3,313	8.742	45	0.0000	0.034	0.001	1
			1200	60	1,905	55	3,313	8.742	43	0.0000	0.032	0.001	1
			1300	60	1,965	55	3,313	8.742	49	0.0000	0.037	0.001	1
			1400	60	2,025	55	3,313	8.742	40	0.0000	0.030	0.001	1
	<b>STOP</b>		1500	60	2,085	57	3,408	8.993	37	0.0000	0.029	0.000	1
	<b>TOTAL MEDIAN</b>				<b>2,085</b>	<b>50</b>	<b>104,968</b>	<b>277</b>	<b>82</b>	<b>0.0001</b>	<b>2.17</b>	<b>0.001</b>	<b>1.50</b>

Notes

Q volumetric flow rate  
 SCFM standard cubic feet per minute  
 ft<sup>3</sup> cubic feet per minute  
 VOC volatile organic compounds  
 PID photo-ionization detector  
 ppmv parts per million vapor

**DERIVATION OF MASS REMOVAL RATE**

ppmv as hexane/1,000,000 = VOC mole %  
 $\text{ft}^3 \text{ of extracted air} / (379 \text{ ft}^3 \text{ air/lb-mole air}) = \text{moles of extracted air}$   
 $(\text{moles of extracted air})(\text{VOC mole \%})(86.2 \text{ lb/lb-mole hexane}) = \text{lbs of VOC removed as hexane}$   
 $(\text{lbs of VOC mass removed as hexane})(\text{elapsed time}) = \text{lbs/min of VOC removed as hexane}$   
 $(\text{lbs/min of VOC removed as hexane})(60 \text{ min/1 hour})(24 \text{ hours/1 day}) = \text{lbs/day of VOC removed as hexane}$



**Table 7**

**SVE Abatement and System Emissions  
August 2016 MPE Event**

15101 Freedom Ave,  
San Leandro, California

Extraction Well	Vapor Sample ID	Onboard Analyzer		Collection Date/Time	USEPA TO-3 MODIFIED	USEPA TO-15 MODIFIED				Q (SCFM)	Average Emission Rate (lbs/day) (TPHg/B/T/X)	Total Test time (minutes/days)	Total Emissions (lbs) (TPHg/B/T/X)
		Date/Time	Reading (measured as hexane)		TPHg (ug/m <sup>3</sup> )	Benzene (ug/m <sup>3</sup> )	Toluene (ug/m <sup>3</sup> )	Ethyl benzene (ug/m <sup>3</sup> )	Total Xylenes (ug/m <sup>3</sup> )				
MW-10R	Effluent	8/2/16 @ 1500	0	8/2/16 @ 1540	656	18	4.50	<2.2	2.30	47	0.003/ 0.00008/ 0.00002/ 0.00001	2,085/ 1.45	0.004/ 0.00011/ 0.00003/ 0.000014
	Influent		169	8/2/16 @ 1550	14,438	<19	82	1,400	2,860				
<b>REMOVAL EFFICIENCIES</b>					95.5%	NA	94.5%	100.0%	99.9%	<b>TOTAL EMISSIONS (LBS)</b>		<b>0.00415</b>	

**Notes**

SCFM standard cubic feet per minute  
 lbs/day pounds per day  
 ug/m<sup>3</sup> micrograms per cubic meter

< not detected at or above laboratory detection limit

**DERIVATION OF MASS REMOVAL RATE**

$$\begin{aligned}
 (\text{ug/m}^3) & [(1\text{mg}/1000\text{ug}) (1\text{m}^3/1000 \text{L})] = \text{mg/L} \\
 (\text{mg/L}) (28.32 \text{ L}/1 \text{ ft}^3) ((\text{Q}) \text{ ft}^3/\text{min}) & = \text{mg/min} \\
 (\text{mg/min})(1\text{g}/1000\text{mg})(1\text{kg}/1000\text{g})(60\text{min}/1\text{hr})(24\text{hr}/1\text{day}) & = \text{kg/day} \\
 (\text{kg/day})(2.2\text{lbs}/1\text{kg}) & = \text{lbs/day}
 \end{aligned}$$

**DERIVATION OF TOTAL MASS REMOVED**

$$\begin{aligned}
 \text{Total time of test} & = \text{days} \\
 (\text{mass removal rate} [\text{lbs/day}])(\text{total time of test} [\text{days}]) & = \text{Total Removed (lbs)}
 \end{aligned}$$

**DERIVATION OF REMOVAL EFFICIENCIES**

$$1 - [\text{STACK sample concentration (lab)}/\text{Influent sample concentration(lab)}]$$

# Appendix A

## Standard Operating Procedures for Conducting Groundwater Monitoring Activities

# **Standard Operating Procedures for Conducting Groundwater Monitoring Activities**

## **Water Level and Free-Product Measurements**

Prior to measurement of groundwater depth at each well, equalization with the surrounding aquifer must be achieved. Initially, the well cap is removed and the pressure is allowed to dissipate, creating a more stable water table level within the well. After about 10-15 minutes, once the water level in the well stabilizes, the depth to groundwater is measured from the top of the casing to the nearest 0.01 foot using an electric sounder.

For free-product (FP) measurement, an oil-water interface probe is used. When the probe is lowered into the FP, the oil/water light and beeper are continuously on at which point a reading for depth to FP is noted. The probe is lowered further into the well until the water signal is given (light flashes and beeps intermittently). Then the probe is carefully raised until the FP signal is given and the reading is noted. This gives the depth to interface of product and water.

## **Purging and Field Measurements**

Prior to sample collection, each well is purged using a battery-operated, 2-inch-diameter pump (Model ES-60 DC). During purging, groundwater is measured for parameters such as dissolved oxygen (DO), pH, temperature, electrical conductivity (EC), and oxygen-reduction potential (ORP) using a Hanna HI-9828 multi-parameter instrument. Turbidity is measured using a Hanna HI-98703 portable turbidimeter. The equipment is calibrated at the site using standard solutions and procedures provided by the manufacturer.

The pH of groundwater has an effect on the activity of microbial populations in the groundwater. The groundwater temperature affects the metabolic activity of bacteria. The groundwater EC is directly related to the concentration of total dissolved solids (TDS) in solution.

There is a strong correlation between the turbidity level and the biological oxygen demand of natural water bodies. The main purpose for checking the turbidity level is to provide a general overview of the extent of the suspended solids in the groundwater.

ORP is the measure of the potential for an oxidation or reduction process to occur. In the oxidation process, a molecule or ion loses one or several electrons. In the reduction process, a molecule or ion gains one or several electrons. The unit of the redox potential is the volt or millivolt. The most important redox reaction in petroleum-contaminated groundwater is the oxidation of petroleum hydrocarbons in the presence of bacteria and free molecular oxygen. Because the solubility of O<sub>2</sub> in water is low (9 mg/L at 25 °C and 11 mg/L at 5 °C), and

because the rate of O<sub>2</sub> replenishment in subsurface environments is limited, DO can be entirely consumed when the oxidation of only a small amount of petroleum hydrocarbons occurs.

Oxidation of petroleum hydrocarbons can still occur when all the dissolved O<sub>2</sub> in the groundwater is consumed; however, the oxidizing agents (i.e., the constituents that undergo reduction) now become NO<sub>3</sub><sup>-</sup>, MnO<sub>2</sub>, Fe (OH)<sub>3</sub>, SO<sub>4</sub><sup>2-</sup> and others (Freeze and Cherry, 1979). As these oxidizing agents are consumed, the groundwater environment becomes more and more reduced. If the process advances far enough, the environment may become so strongly reduced that the petroleum hydrocarbons undergo anaerobic degradation, resulting in the production of methane and carbon dioxide. The concept of oxidation and reduction in terms of changes in oxidation states is illustrated below.

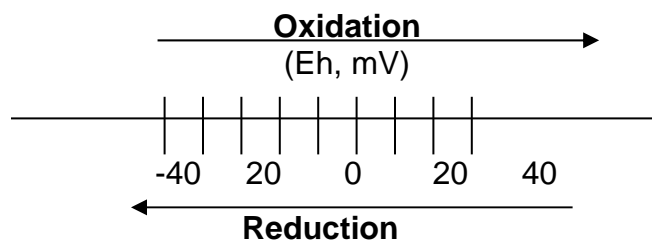

Purging of wells continues until the parameters for DO, pH, temperature, EC, turbidity, and redox stabilize, or three casing volumes are purged.

Once stabilization occurs, the groundwater samples are also tested on-site for ferrous iron (Fe<sup>+2</sup>), nitrate (NO<sub>3</sub><sup>-</sup>), and sulfate (SO<sub>4</sub><sup>-2</sup>) concentrations.

Fe<sup>+2</sup>, NO<sub>3</sub><sup>-</sup>, and SO<sub>4</sub><sup>-2</sup> are measured colorimetrically using the Hach Colorimeter Model 890, a microprocessor-controlled photometer suitable for colorimetric testing in the laboratory or the field. The required reagents for each specific test are provided in AccuVac ampuls.

## Sampling

For sampling purposes, after purging a disposable polyethylene bailer is used to collect sufficient samples from each monitoring well for laboratory analyses. Groundwater samples are transferred into 40-mL VOA vials and preserved with hydrochloric acid. The vials are sealed to prevent air bubbles from developing within the headspace. For TPH-d analysis, groundwater samples are collected using 1-L, amber, non-preserved glass containers. Samples are placed in an ice-filled cooler and maintained at 4°C. A chain of custody form for all samples is prepared to accompany the samples, which are promptly delivered to a California state-certified analytical laboratory.

# Appendix B

Elevations and Coordinates on Monitoring Wells, Field Measurements of Physical and Chemical Parameters of Groundwater Samples, and Groundwater Gradient Calculations

**Harrington Surveys Inc.**  
**Land Surveying & Mapping**

2278 Larkey Lane, Walnut Creek, Ca. 94596 Phone (925)935-7228 Fax (925)935-5118  
Cel (925)788-7359 E-Mail (ben5132@pacbell.net)

Soma Environmental Engineering  
2680 Bishop Dr. # 203  
San Ramon, Ca. 94583

Oct. 14, 2004

Attn: Elena Manzo  
Job # 2445

Ref: 15101 Freedom Ave, San Leandro, Ca.

**HORIZONTAL CONTROL, NAD 88:**

Survey based on California Coordinate System, Zone 3, NAD 83.

CHABOT "B", NORTH 2,087,731.02 EAST 6,094,039.23 sft. LAT. N37°43'02.71762"  
W122°07'00.46339", NAVD 88, ELEV. 134.957.

CHABOT "A", NORTH 2,088,584.99 EAST 6,093,351.39 sft. LAT. N37°43'11.04190"  
W122°07'09.20691", NAVD 88, ELEV. 492.08.

**VERTICAL CONTROL, NAVD 88:**

NGS 1974, STATION K 1256, NAVD 88 ELEV. 58.50.  
PID # HT1871

GPS: TRIMBLE 5800, LEICA TCA 1800, 1" HORZ. & VERT.

EPOCH DATE 1998.5

OBSERVATION: EPOCH=180.

FIELD SURVEY: OCT. 11, 2004.

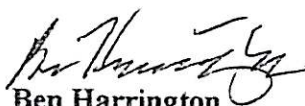
  
Ben Harrington  
PLS 5132











DATE: 1/08/2008  
 JOB NUMBER 0208101  
 DATE OF SURVEY 1/03/08  
 INSTRUMENT LIECA SR520

TABLE OF ELEVATIONS & COORDINATES  
 ON MONITORING WELLS  
 SOMA ENVIRONMENTAL, PROJECT 15101 FREEDOM DRIVE - SAN LEANDRO

WELL ID#	NORTHING (ft.) LATITUDE	EASTING (ft.) LONGITUDE	ELEVATION (ft.)	DESCRIPTION
MW-1D	2084371.23	6092127.90	54.42	MW-1D NOTCH
	37.708104856	122.123200912	54.94	MW-1D RIM
	37° 42' 29.1" N	122° 07' 23" W	54.74	PAVEMENT
MW-3D	2084303.98	6092183.53	54.10	MW-3D NOTCH
	37.707922851	122.123004590	54.56	MW-3D RIM
	37° 42' 28.5" N	122° 07' 22" W	54.47	PAVEMENT
MW-4D	2084222.77	6092116.37	53.12	MW-4D NOTCH
	37.707696648	122.123231858	53.37	MW-4D RIM
	37° 42' 27.7" N	122° 07' 23" W	53.39	PAVEMENT

BENCH MARK: NGS BENCH MARK NO. HT1871

3.0 KM (1.85 MI) NORTH FROM SAM LORENZO. 1.85 MILES NORTH ALONG INTERSTATE HIGHWAY 580 FROM THE JUNCTION OF STATE HIGHWAY 238 IN SAN LORENZO, IN THE WEST CORNER OF THE CROSSING OF 150TH AVENUE, IN TOP OF THE CONCRETE BRIDGE DECK, 15.5 FEET NORTHWEST OF THE SOUTHWEST BOUND LANES OF THE AVENUE, 10.9 FEET NORTHEAST OF THE SOUTH CORNER OF THE SOUTHWEST END OF THE NORTHWEST CONCRETE GUARDRAIL, 0.7 FOOT NORTHEAST OF THE SOUTHWEST EDGE OF THE DECK, 0.9 FOOT SOUTHEAST OF THE NORTHWEST CONCRETE GUARDRAIL, AND ABOUT LEVEL WITH THE HIGHWAY.

ELEVATION = 58.50 NAVD 88 DATUM

HORIZONTAL AND VERTICAL CONTROL BASED ON HARRINGTON SURVEY DATED 10-12-2004

FD CHABOT A, CALIFORNIA STATE PLAIN COORDINATE SYSTEM, NAD 83, ZONE 3. NORTH 2,088,584.99 EAST 6,093,351.39. LAT N 37°43'11.04190" LONG W 122°07'09.20691", ELEVATION 492.08 NAVD 88.

FD CHABOT B, CALIFORNIA STATE PLAIN COORDINATE SYSTEM, NAD 83, ZONE 3. NORTH 2,087,731.02 EAST 6,094,039.23. . LAT N 37°43'02.71762" LONG W 122°07'00.46339", ELEVATION 442.77 NAVD 88.

DATE: 12/11/2009

JOB# 09039

**TABLE OF ELEVATIONS & COORDINATES  
ON MONITORING WELLS**

SOMA ENVIRONMENTAL ENGINEERING  
15101 FREEDOM AVENUE  
SAN LEANDRO, CA 94579

WELL ID #	NORTHING (FT.) / LATITUDE (D.DEG.)	EASTING (FT.) / LONGITUDE (D.DEG.)	ELEVATION (FT.)	DESCRIPTION
EX-1	2084135.454	6092163.720	47.36	4" PVC NOTCH NORTH SIDE
	37.707459134	122.123062972	47.61	SET PUNCH NORTH SIDE RIM
			47.60	PAVEMENT NORTH SIDE
EX-2	2084082.018	6092130.224	45.96	4" PVC NOTCH NORTH SIDE
	37.707310806	122.123175540	47.04	SET PUNCH NORTH SIDE RIM
			47.00	CONCRETE NORTH SIDE
MPE-1	2084213.168	6092125.258	51.96	4" PVC NOTCH NORTH SIDE
	37.707670702	122.123200567	52.49	SET PUNCH NORTH SIDE RIM
			52.51	CONCRETE NORTH SIDE
MPE-2	2084293.133	6092171.374	53.72	4" PVC NOTCH NORTH SIDE
	37.707892479	122.123045970	54.29	SET PUNCH NORTH SIDE RIM
			54.27	PAVEMENT NORTH SIDE

**HORIZONTAL AND VERTICAL CONTROL**

SURVEY BASED ON PREVIOUS SURVEY BY HARRINGTON SURVEY INC. DATED: 2/21/2008  
COORDINATE VALUES ARE BASED ON THE CALIFORNIA COORDINATE SYSTEM, ZONE 3, NAD83.  
ELEVATIONS ARE NAVD 88 DATUM.

**MW-2, PUNCH**

NORTHING 2,084323.44, EASTING 6,092063.77, ELEVATION 52.92

**MW-4 PUNCH**

NORTHING 2,084250.55, EASTING 6,092124.46, ELEVATION 53.74

EQUIPMENT USED: TRIMBLE S6

**Edgis Land Surveying**  
Land Surveying and mapping  
1374 Garland Avenue, Clovis, CA 93612  
Phone (559) 906-3554 Fax (559) 292-0560  
email: edgis@aol.com



*[Handwritten Signature]* 1 of 1









































# EPA On-line Tools for Site Assessment Calculation

## Hydraulic Gradient -- Magnitude and Direction

**Gradient Calculation** from fitting a plane to as many as thirty points

$$\begin{aligned}
 a x_1 + b y_1 + c &= h_1 \\
 a x_2 + b y_2 + c &= h_2 \\
 a x_3 + b y_3 + c &= h_3 \\
 &\dots \\
 a x_{30} + b y_{30} + c &= h_{30}
 \end{aligned}$$

where  $(x_i, y_i)$  are the coordinates of the well and  $h_i$  is the head

$i = 1, 2, 3, \dots, 30$

The coefficients  $a$ ,  $b$ , and  $c$  are calculated by a least-squares fitting of the the data to a plane

The gradient is calculated from the square root of  $(a^2 + b^2)$  and the angle from the arctangent of  $a/b$  or  $b/a$  depending on the quadrant

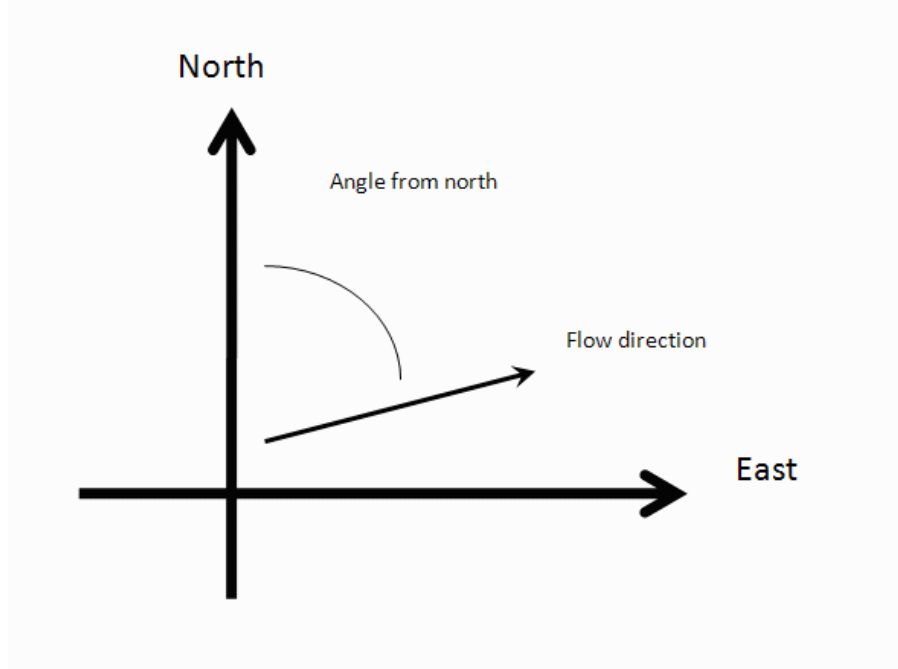

### Inputs

Example Data Set 1	Example Data Set 2	Calculate	Clear
Save Data	Recall Data	Go Back	
Site Name	15101 Freedom Ave, San L		
Date	September 21, 2016	Current Date	
Calculation basis	Head		
Coordinates	ft		
I.D.	x-coordinate	y-coordinate	head ft
1) MW-1	6092119.016	2084364.691	30.93
2) MW-2	6092063.978	2084323.224	30.70
3) MW-3	6092176.317	2084298.343	30.79
4) MW-4	6092124.294	2084251.598	30.59
5) MW-5	6092177.071	2084206.361	30.56
6) MW-6	6092140.881	2084072.911	28.25
7) MW-7	6092290.918	2084008.071	28.42
8) MW-10	6092182.374	2083967.53	28.29
9) MW-11	6092224.568	2083926.493	28.4
10) EX-1	6092163.5	2084133.982	30.61
11) MPE-1	6092125.048	2084212.393	30.65
12) MPE-2	6092171.793	2084292.312	30.76
13)			
14)			
15)			
16)			

17)				
18)				
19)				
20)				
21)				
22)				
23)				
24)				
25)				
26)				
27)				
28)				
29)				
30)				

**Results**

Number of Points Used in Calculation	12
Max. Difference Between Head Values	0.8169
Gradient Magnitude (i)	0.007562
Flow direction as degrees from North (positive y axis)	188.8
Coefficient of Determination ( $R^2$ )	0.826

WCMS

Last updated on 2/23/2016

# Appendix C

Laboratory Reports and Chain of Custody Forms  
for the Third Quarter 2016 Monitoring Event  
and Post-MPE Sampling Event



Curtis & Tompkins, Ltd., Analytical Laboratories, Since 1878

2323 Fifth Street, Berkeley, CA 94710, Phone (510) 486-0900

Laboratory Job Number 281306
ANALYTICAL REPORT

SOMA Environmental Engineering Inc.
6620 Owens Dr.
Pleasanton, CA 94588

Project : 2551
Location : 15101 Freedom Avenue San Leandro
Level : II

Table with 2 columns: Sample ID, Lab ID. Rows include MW-1 through MW-11, EX-1, MPE-1, MPE-2.

This data package has been reviewed for technical correctness and completeness. Release of this data has been authorized by the Laboratory Manager or the Manager's designee, as verified by the following signature. The results contained in this report meet all requirements of NELAC and pertain only to those samples which were submitted for analysis. This report may be reproduced only in its entirety.

Signature: [Handwritten Signature]
Tracy Babjar
Project Manager
tracy.babjar@ctberk.com
(510) 204-2226

Date: 09/29/2016

### CASE NARRATIVE

Laboratory number: 281306  
Client: SOMA Environmental Engineering Inc.  
Project: 2551  
Location: 15101 Freedom Avenue San Leandro  
Request Date: 09/22/16  
Samples Received: 09/22/16

This data package contains sample and QC results for twelve water samples, requested for the above referenced project on 09/22/16. The samples were received cold and intact.

**Volatile Organics by GC/MS (EPA 8260B):**

MW-6 (lab # 281306-006) was diluted due to high non-target analytes. No other analytical problems were encountered.





**COOLER RECEIPT CHECKLIST**



Curtis & Tompkins, Ltd.

Login # 281306 Date Received 9/22/16 Number of coolers 1  
 Client SCMA Project 2551

Date Opened 9/22 By (print) DTN (sign) [Signature]  
 Date Logged in ↓ By (print) ↓ (sign) [Signature]  
 Date Labeled ↓ By (print) ↓ (sign) [Signature]

1. Did cooler come with a shipping slip (airbill, etc) YES ~~NO~~  
 Shipping info \_\_\_\_\_

2A. Were custody seals present? ....  YES (circle) on cooler on samples  NO  
 How many \_\_\_\_\_ Name \_\_\_\_\_ Date \_\_\_\_\_

2B. Were custody seals intact upon arrival? \_\_\_\_\_ YES NO N/A

3. Were custody papers dry and intact when received? \_\_\_\_\_ YES NO

4. Were custody papers filled out properly (ink, signed, etc)? \_\_\_\_\_ YES NO

5. Is the project identifiable from custody papers? (If so fill out top of form) YES NO

6. Indicate the packing in cooler: (if other, describe) \_\_\_\_\_

- Bubble Wrap  Foam blocks  Bags  None
- Cloth material  Cardboard  Styrofoam  Paper towels

7. Temperature documentation: \* Notify PM if temperature exceeds 6°C

Type of ice used:  Wet  Blue/Gel  None Temp(°C) 1.5

Temperature blank(s) included?  Thermometer# \_\_\_\_\_  IR Gun# A

Samples received on ice directly from the field. Cooling process had begun

8. Were Method 5035 sampling containers present? \_\_\_\_\_ YES NO

If YES, what time were they transferred to freezer? \_\_\_\_\_

9. Did all bottles arrive unbroken/unopened? \_\_\_\_\_ YES NO

10. Are there any missing / extra samples? \_\_\_\_\_ YES ~~NO~~ DTN

11. Are samples in the appropriate containers for indicated tests? \_\_\_\_\_ YES NO

12. Are sample labels present, in good condition and complete? \_\_\_\_\_ YES NO

13. Do the sample labels agree with custody papers? \_\_\_\_\_ YES NO

14. Was sufficient amount of sample sent for tests requested? \_\_\_\_\_ YES NO

15. Are the samples appropriately preserved? \_\_\_\_\_ YES NO N/A

16. Did you check preservatives for all bottles for each sample? \_\_\_\_\_ YES NO N/A

17. Did you document your preservative check? (pH strip lot# \_\_\_\_\_ ) YES NO N/A

18. Did you change the hold time in LIMS for unpreserved VOAs? \_\_\_\_\_ YES NO N/A

19. Did you change the hold time in LIMS for preserved terracores? \_\_\_\_\_ YES NO N/A

20. Are bubbles > 6mm absent in VOA samples? \_\_\_\_\_ YES NO N/A

21. Was the client contacted concerning this sample delivery? \_\_\_\_\_ YES NO

If YES, Who was called? \_\_\_\_\_ By \_\_\_\_\_ Date: \_\_\_\_\_

**COMMENTS**

10. Did not receive any containers for sample w/ ID "EX-2"

20. 2/3 VOAs received w/ bubble > 6mm for sample 9

3/3

11

2, 4, 5, 7, 10, 11, 12



Client Sample ID : MW-5

Laboratory Sample ID :

281306-005

Analyte	Result	Flags	RL	Units	Basis	IDF	Method	Prep Method
Gasoline C7-C12	590		50	ug/L	As Recd	1.000	EPA 8260B	EPA 5030B
Methyl tert-Amyl Ether (TAME)	0.94		0.50	ug/L	As Recd	1.000	EPA 8260B	EPA 5030B
MTBE	1.9		0.50	ug/L	As Recd	1.000	EPA 8260B	EPA 5030B
Benzene	0.73		0.50	ug/L	As Recd	1.000	EPA 8260B	EPA 5030B

Client Sample ID : MW-6

Laboratory Sample ID :

281306-006

Analyte	Result	Flags	RL	Units	Basis	IDF	Method	Prep Method
Gasoline C7-C12	2,600		100	ug/L	As Recd	2.000	EPA 8260B	EPA 5030B
Benzene	8.5		1.0	ug/L	As Recd	2.000	EPA 8260B	EPA 5030B
Ethylbenzene	1.9		1.0	ug/L	As Recd	2.000	EPA 8260B	EPA 5030B

Client Sample ID : MW-7

Laboratory Sample ID :

281306-007

Analyte	Result	Flags	RL	Units	Basis	IDF	Method	Prep Method
Gasoline C7-C12	2,000		50	ug/L	As Recd	1.000	EPA 8260B	EPA 5030B
Benzene	1.9		0.50	ug/L	As Recd	1.000	EPA 8260B	EPA 5030B
Toluene	0.63		0.50	ug/L	As Recd	1.000	EPA 8260B	EPA 5030B
Ethylbenzene	11		0.50	ug/L	As Recd	1.000	EPA 8260B	EPA 5030B
m,p-Xylenes	11		0.50	ug/L	As Recd	1.000	EPA 8260B	EPA 5030B
o-Xylene	1.1		0.50	ug/L	As Recd	1.000	EPA 8260B	EPA 5030B

Client Sample ID : MW-10R

Laboratory Sample ID :

281306-008

Analyte	Result	Flags	RL	Units	Basis	IDF	Method	Prep Method
Gasoline C7-C12	10,000		200	ug/L	As Recd	4.000	EPA 8260B	EPA 5030B
tert-Butyl Alcohol (TBA)	100		40	ug/L	As Recd	4.000	EPA 8260B	EPA 5030B
Benzene	9.6		2.0	ug/L	As Recd	4.000	EPA 8260B	EPA 5030B
Ethylbenzene	340		2.0	ug/L	As Recd	4.000	EPA 8260B	EPA 5030B
m,p-Xylenes	410		2.0	ug/L	As Recd	4.000	EPA 8260B	EPA 5030B
o-Xylene	22		2.0	ug/L	As Recd	4.000	EPA 8260B	EPA 5030B

Client Sample ID : MW-11

Laboratory Sample ID :

281306-009

Analyte	Result	Flags	RL	Units	Basis	IDF	Method	Prep Method
Gasoline C7-C12	75		50	ug/L	As Recd	1.000	EPA 8260B	EPA 5030B
Ethylbenzene	1.5		0.50	ug/L	As Recd	1.000	EPA 8260B	EPA 5030B
m,p-Xylenes	1.7		0.50	ug/L	As Recd	1.000	EPA 8260B	EPA 5030B

Client Sample ID : EX-1

Laboratory Sample ID :

281306-010

Analyte	Result	Flags	RL	Units	Basis	IDF	Method	Prep Method
Gasoline C7-C12	260		50	ug/L	As Recd	1.000	EPA 8260B	EPA 5030B
Benzene	1.2		0.50	ug/L	As Recd	1.000	EPA 8260B	EPA 5030B
Ethylbenzene	5.3		0.50	ug/L	As Recd	1.000	EPA 8260B	EPA 5030B
m,p-Xylenes	1.7		0.50	ug/L	As Recd	1.000	EPA 8260B	EPA 5030B

Client Sample ID : MPE-1

Laboratory Sample ID :

281306-011

Analyte	Result	Flags	RL	Units	Basis	IDF	Method	Prep Method
Gasoline C7-C12	1,200		50	ug/L	As Recd	1.000	EPA 8260B	EPA 5030B
Methyl tert-Amyl Ether (TAME)	1.1		0.50	ug/L	As Recd	1.000	EPA 8260B	EPA 5030B
MTBE	1.5		0.50	ug/L	As Recd	1.000	EPA 8260B	EPA 5030B
Benzene	35		0.50	ug/L	As Recd	1.000	EPA 8260B	EPA 5030B
Ethylbenzene	3.2		0.50	ug/L	As Recd	1.000	EPA 8260B	EPA 5030B
m,p-Xylenes	2.7		0.50	ug/L	As Recd	1.000	EPA 8260B	EPA 5030B
o-Xylene	3.4		0.50	ug/L	As Recd	1.000	EPA 8260B	EPA 5030B

Client Sample ID : MPE-2

Laboratory Sample ID :

281306-012

Analyte	Result	Flags	RL	Units	Basis	IDF	Method	Prep Method
Gasoline C7-C12	12,000		630	ug/L	As Recd	12.50	EPA 8260B	EPA 5030B
tert-Butyl Alcohol (TBA)	210		130	ug/L	As Recd	12.50	EPA 8260B	EPA 5030B
Benzene	630		6.3	ug/L	As Recd	12.50	EPA 8260B	EPA 5030B
Ethylbenzene	300		6.3	ug/L	As Recd	12.50	EPA 8260B	EPA 5030B
m,p-Xylenes	190		6.3	ug/L	As Recd	12.50	EPA 8260B	EPA 5030B

### Purgeable Organics by GC/MS

Lab #: 281306	Location: 15101 Freedom Avenue San Leandro
Client: SOMA Environmental Engineering Inc.	Prep: EPA 5030B
Project#: 2551	Analysis: EPA 8260B
Field ID: MW-1	Units: ug/L
Lab ID: 281306-001	Sampled: 09/21/16
Matrix: Water	Received: 09/22/16

Analyte	Result	RL	Diln Fac	Batch#	Analyzed
Gasoline C7-C12	4,800	170	3.333	239460	09/25/16
tert-Butyl Alcohol (TBA)	17	10	1.000	239438	09/23/16
Isopropyl Ether (DIPE)	ND	0.50	1.000	239438	09/23/16
Ethyl tert-Butyl Ether (ETBE)	ND	0.50	1.000	239438	09/23/16
Methyl tert-Amyl Ether (TAME)	ND	0.50	1.000	239438	09/23/16
Ethanol	ND	1,000	1.000	239438	09/23/16
MTBE	ND	0.50	1.000	239438	09/23/16
1,2-Dichloroethane	ND	0.50	1.000	239438	09/23/16
Benzene	47	0.50	1.000	239438	09/23/16
Toluene	0.57	0.50	1.000	239438	09/23/16
1,2-Dibromoethane	ND	0.50	1.000	239438	09/23/16
Ethylbenzene	74	0.50	1.000	239438	09/23/16
m,p-Xylenes	0.62	0.50	1.000	239438	09/23/16
o-Xylene	ND	0.50	1.000	239438	09/23/16

Surrogate	%REC	Limits	Diln Fac	Batch#	Analyzed
Dibromofluoromethane	108	80-128	1.000	239438	09/23/16
1,2-Dichloroethane-d4	79	75-139	1.000	239438	09/23/16
Toluene-d8	93	80-120	1.000	239438	09/23/16
Bromofluorobenzene	101	80-120	1.000	239438	09/23/16

ND= Not Detected  
 RL= Reporting Limit

### Purgeable Organics by GC/MS

Lab #: 281306	Location: 15101 Freedom Avenue San Leandro
Client: SOMA Environmental Engineering Inc.	Prep: EPA 5030B
Project#: 2551	Analysis: EPA 8260B
Field ID: MW-2	Batch#: 239530
Lab ID: 281306-002	Sampled: 09/21/16
Matrix: Water	Received: 09/22/16
Units: ug/L	Analyzed: 09/27/16
Diln Fac: 1.000	

Analyte	Result	RL
Gasoline C7-C12	680	50
tert-Butyl Alcohol (TBA)	ND	10
Isopropyl Ether (DIPE)	ND	0.50
Ethyl tert-Butyl Ether (ETBE)	ND	0.50
Methyl tert-Amyl Ether (TAME)	ND	0.50
Ethanol	ND	1,000
MTBE	ND	0.50
1,2-Dichloroethane	ND	0.50
Benzene	ND	0.50
Toluene	ND	0.50
1,2-Dibromoethane	ND	0.50
Ethylbenzene	ND	0.50
m,p-Xylenes	ND	0.50
o-Xylene	ND	0.50

Surrogate	%REC	Limits
Dibromofluoromethane	95	80-128
1,2-Dichloroethane-d4	103	75-139
Toluene-d8	97	80-120
Bromofluorobenzene	94	80-120

ND= Not Detected  
 RL= Reporting Limit

### Purgeable Organics by GC/MS

Lab #: 281306	Location: 15101 Freedom Avenue San Leandro
Client: SOMA Environmental Engineering Inc.	Prep: EPA 5030B
Project#: 2551	Analysis: EPA 8260B
Field ID: MW-3	Batch#: 239460
Lab ID: 281306-003	Sampled: 09/21/16
Matrix: Water	Received: 09/22/16
Units: ug/L	Analyzed: 09/25/16
Diln Fac: 5.000	

Analyte	Result	RL
Gasoline C7-C12	12,000	250
tert-Butyl Alcohol (TBA)	140	50
Isopropyl Ether (DIPE)	ND	2.5
Ethyl tert-Butyl Ether (ETBE)	ND	2.5
Methyl tert-Amyl Ether (TAME)	ND	2.5
Ethanol	ND	5,000
MTBE	ND	2.5
1,2-Dichloroethane	ND	2.5
Benzene	380	2.5
Toluene	ND	2.5
1,2-Dibromoethane	ND	2.5
Ethylbenzene	250	2.5
m,p-Xylenes	410	2.5
o-Xylene	14	2.5

Surrogate	%REC	Limits
Dibromofluoromethane	115	80-128
1,2-Dichloroethane-d4	88	75-139
Toluene-d8	88	80-120
Bromofluorobenzene	98	80-120

ND= Not Detected  
 RL= Reporting Limit

### Purgeable Organics by GC/MS

Lab #: 281306	Location: 15101 Freedom Avenue San Leandro
Client: SOMA Environmental Engineering Inc.	Prep: EPA 5030B
Project#: 2551	Analysis: EPA 8260B
Field ID: MW-4	Batch#: 239438
Lab ID: 281306-004	Sampled: 09/21/16
Matrix: Water	Received: 09/22/16
Units: ug/L	Analyzed: 09/23/16
Diln Fac: 1.000	

Analyte	Result	RL
Gasoline C7-C12	620	50
tert-Butyl Alcohol (TBA)	130	10
Isopropyl Ether (DIPE)	ND	0.50
Ethyl tert-Butyl Ether (ETBE)	2.0	0.50
Methyl tert-Amyl Ether (TAME)	4.7	0.50
Ethanol	ND	1,000
MTBE	35	0.50
1,2-Dichloroethane	ND	0.50
Benzene	87	0.50
Toluene	ND	0.50
1,2-Dibromoethane	ND	0.50
Ethylbenzene	5.0	0.50
m,p-Xylenes	9.9	0.50
o-Xylene	ND	0.50

Surrogate	%REC	Limits
Dibromofluoromethane	110	80-128
1,2-Dichloroethane-d4	86	75-139
Toluene-d8	92	80-120
Bromofluorobenzene	99	80-120

ND= Not Detected  
 RL= Reporting Limit



### Purgeable Organics by GC/MS

Lab #: 281306	Location: 15101 Freedom Avenue San Leandro
Client: SOMA Environmental Engineering Inc.	Prep: EPA 5030B
Project#: 2551	Analysis: EPA 8260B
Field ID: MW-5	Batch#: 239438
Lab ID: 281306-005	Sampled: 09/21/16
Matrix: Water	Received: 09/22/16
Units: ug/L	Analyzed: 09/23/16
Diln Fac: 1.000	

Analyte	Result	RL
Gasoline C7-C12	590	50
tert-Butyl Alcohol (TBA)	ND	10
Isopropyl Ether (DIPE)	ND	0.50
Ethyl tert-Butyl Ether (ETBE)	ND	0.50
Methyl tert-Amyl Ether (TAME)	0.94	0.50
Ethanol	ND	1,000
MTBE	1.9	0.50
1,2-Dichloroethane	ND	0.50
Benzene	0.73	0.50
Toluene	ND	0.50
1,2-Dibromoethane	ND	0.50
Ethylbenzene	ND	0.50
m,p-Xylenes	ND	0.50
o-Xylene	ND	0.50

Surrogate	%REC	Limits
Dibromofluoromethane	109	80-128
1,2-Dichloroethane-d4	86	75-139
Toluene-d8	90	80-120
Bromofluorobenzene	100	80-120

ND= Not Detected  
 RL= Reporting Limit

### Purgeable Organics by GC/MS

Lab #: 281306	Location: 15101 Freedom Avenue San Leandro
Client: SOMA Environmental Engineering Inc.	Prep: EPA 5030B
Project#: 2551	Analysis: EPA 8260B
Field ID: MW-6	Batch#: 239438
Lab ID: 281306-006	Sampled: 09/21/16
Matrix: Water	Received: 09/22/16
Units: ug/L	Analyzed: 09/23/16
Diln Fac: 2.000	

Analyte	Result	RL
Gasoline C7-C12	2,600	100
tert-Butyl Alcohol (TBA)	ND	20
Isopropyl Ether (DIPE)	ND	1.0
Ethyl tert-Butyl Ether (ETBE)	ND	1.0
Methyl tert-Amyl Ether (TAME)	ND	1.0
Ethanol	ND	2,000
MTBE	ND	1.0
1,2-Dichloroethane	ND	1.0
Benzene	8.5	1.0
Toluene	ND	1.0
1,2-Dibromoethane	ND	1.0
Ethylbenzene	1.9	1.0
m,p-Xylenes	ND	1.0
o-Xylene	ND	1.0

Surrogate	%REC	Limits
Dibromofluoromethane	108	80-128
1,2-Dichloroethane-d4	88	75-139
Toluene-d8	92	80-120
Bromofluorobenzene	96	80-120

ND= Not Detected  
 RL= Reporting Limit

### Purgeable Organics by GC/MS

Lab #: 281306	Location: 15101 Freedom Avenue San Leandro
Client: SOMA Environmental Engineering Inc.	Prep: EPA 5030B
Project#: 2551	Analysis: EPA 8260B
Field ID: MW-7	Batch#: 239438
Lab ID: 281306-007	Sampled: 09/21/16
Matrix: Water	Received: 09/22/16
Units: ug/L	Analyzed: 09/23/16
Diln Fac: 1.000	

Analyte	Result	RL
Gasoline C7-C12	2,000	50
tert-Butyl Alcohol (TBA)	ND	10
Isopropyl Ether (DIPE)	ND	0.50
Ethyl tert-Butyl Ether (ETBE)	ND	0.50
Methyl tert-Amyl Ether (TAME)	ND	0.50
Ethanol	ND	1,000
MTBE	ND	0.50
1,2-Dichloroethane	ND	0.50
Benzene	1.9	0.50
Toluene	0.63	0.50
1,2-Dibromoethane	ND	0.50
Ethylbenzene	11	0.50
m,p-Xylenes	11	0.50
o-Xylene	1.1	0.50

Surrogate	%REC	Limits
Dibromofluoromethane	109	80-128
1,2-Dichloroethane-d4	85	75-139
Toluene-d8	91	80-120
Bromofluorobenzene	95	80-120

ND= Not Detected  
 RL= Reporting Limit

### Purgeable Organics by GC/MS

Lab #: 281306	Location: 15101 Freedom Avenue San Leandro
Client: SOMA Environmental Engineering Inc.	Prep: EPA 5030B
Project#: 2551	Analysis: EPA 8260B
Field ID: MW-10R	Batch#: 239460
Lab ID: 281306-008	Sampled: 09/21/16
Matrix: Water	Received: 09/22/16
Units: ug/L	Analyzed: 09/25/16
Diln Fac: 4.000	

Analyte	Result	RL
Gasoline C7-C12	10,000	200
tert-Butyl Alcohol (TBA)	100	40
Isopropyl Ether (DIPE)	ND	2.0
Ethyl tert-Butyl Ether (ETBE)	ND	2.0
Methyl tert-Amyl Ether (TAME)	ND	2.0
Ethanol	ND	4,000
MTBE	ND	2.0
1,2-Dichloroethane	ND	2.0
Benzene	9.6	2.0
Toluene	ND	2.0
1,2-Dibromoethane	ND	2.0
Ethylbenzene	340	2.0
m,p-Xylenes	410	2.0
o-Xylene	22	2.0

Surrogate	%REC	Limits
Dibromofluoromethane	116	80-128
1,2-Dichloroethane-d4	88	75-139
Toluene-d8	88	80-120
Bromofluorobenzene	98	80-120

ND= Not Detected  
 RL= Reporting Limit

### Purgeable Organics by GC/MS

Lab #: 281306	Location: 15101 Freedom Avenue San Leandro
Client: SOMA Environmental Engineering Inc.	Prep: EPA 5030B
Project#: 2551	Analysis: EPA 8260B
Field ID: MW-11	Batch#: 239438
Lab ID: 281306-009	Sampled: 09/21/16
Matrix: Water	Received: 09/22/16
Units: ug/L	Analyzed: 09/23/16
Diln Fac: 1.000	

Analyte	Result	RL
Gasoline C7-C12	75	50
tert-Butyl Alcohol (TBA)	ND	10
Isopropyl Ether (DIPE)	ND	0.50
Ethyl tert-Butyl Ether (ETBE)	ND	0.50
Methyl tert-Amyl Ether (TAME)	ND	0.50
Ethanol	ND	1,000
MTBE	ND	0.50
1,2-Dichloroethane	ND	0.50
Benzene	ND	0.50
Toluene	ND	0.50
1,2-Dibromoethane	ND	0.50
Ethylbenzene	1.5	0.50
m,p-Xylenes	1.7	0.50
o-Xylene	ND	0.50

Surrogate	%REC	Limits
Dibromofluoromethane	109	80-128
1,2-Dichloroethane-d4	87	75-139
Toluene-d8	89	80-120
Bromofluorobenzene	96	80-120

ND= Not Detected  
 RL= Reporting Limit

### Purgeable Organics by GC/MS

Lab #: 281306	Location: 15101 Freedom Avenue San Leandro
Client: SOMA Environmental Engineering Inc.	Prep: EPA 5030B
Project#: 2551	Analysis: EPA 8260B
Field ID: EX-1	Batch#: 239438
Lab ID: 281306-010	Sampled: 09/21/16
Matrix: Water	Received: 09/22/16
Units: ug/L	Analyzed: 09/23/16
Diln Fac: 1.000	

Analyte	Result	RL
Gasoline C7-C12	260	50
tert-Butyl Alcohol (TBA)	ND	10
Isopropyl Ether (DIPE)	ND	0.50
Ethyl tert-Butyl Ether (ETBE)	ND	0.50
Methyl tert-Amyl Ether (TAME)	ND	0.50
Ethanol	ND	1,000
MTBE	ND	0.50
1,2-Dichloroethane	ND	0.50
Benzene	1.2	0.50
Toluene	ND	0.50
1,2-Dibromoethane	ND	0.50
Ethylbenzene	5.3	0.50
m,p-Xylenes	1.7	0.50
o-Xylene	ND	0.50

Surrogate	%REC	Limits
Dibromofluoromethane	108	80-128
1,2-Dichloroethane-d4	89	75-139
Toluene-d8	94	80-120
Bromofluorobenzene	99	80-120

ND= Not Detected  
 RL= Reporting Limit

### Purgeable Organics by GC/MS

Lab #: 281306	Location: 15101 Freedom Avenue San Leandro
Client: SOMA Environmental Engineering Inc.	Prep: EPA 5030B
Project#: 2551	Analysis: EPA 8260B
Field ID: MPE-1	Batch#: 239460
Lab ID: 281306-011	Sampled: 09/21/16
Matrix: Water	Received: 09/22/16
Units: ug/L	Analyzed: 09/24/16
Diln Fac: 1.000	

Analyte	Result	RL
Gasoline C7-C12	1,200	50
tert-Butyl Alcohol (TBA)	ND	10
Isopropyl Ether (DIPE)	ND	0.50
Ethyl tert-Butyl Ether (ETBE)	ND	0.50
Methyl tert-Amyl Ether (TAME)	1.1	0.50
Ethanol	ND	1,000
MTBE	1.5	0.50
1,2-Dichloroethane	ND	0.50
Benzene	35	0.50
Toluene	ND	0.50
1,2-Dibromoethane	ND	0.50
Ethylbenzene	3.2	0.50
m,p-Xylenes	2.7	0.50
o-Xylene	3.4	0.50

Surrogate	%REC	Limits
Dibromofluoromethane	116	80-128
1,2-Dichloroethane-d4	89	75-139
Toluene-d8	88	80-120
Bromofluorobenzene	96	80-120

ND= Not Detected  
 RL= Reporting Limit

### Purgeable Organics by GC/MS

Lab #: 281306	Location: 15101 Freedom Avenue San Leandro
Client: SOMA Environmental Engineering Inc.	Prep: EPA 5030B
Project#: 2551	Analysis: EPA 8260B
Field ID: MPE-2	Batch#: 239438
Lab ID: 281306-012	Sampled: 09/21/16
Matrix: Water	Received: 09/22/16
Units: ug/L	Analyzed: 09/23/16
Diln Fac: 12.50	

Analyte	Result	RL
Gasoline C7-C12	12,000	630
tert-Butyl Alcohol (TBA)	210	130
Isopropyl Ether (DIPE)	ND	6.3
Ethyl tert-Butyl Ether (ETBE)	ND	6.3
Methyl tert-Amyl Ether (TAME)	ND	6.3
Ethanol	ND	13,000
MTBE	ND	6.3
1,2-Dichloroethane	ND	6.3
Benzene	630	6.3
Toluene	ND	6.3
1,2-Dibromoethane	ND	6.3
Ethylbenzene	300	6.3
m,p-Xylenes	190	6.3
o-Xylene	ND	6.3

Surrogate	%REC	Limits
Dibromofluoromethane	109	80-128
1,2-Dichloroethane-d4	88	75-139
Toluene-d8	92	80-120
Bromofluorobenzene	96	80-120

ND= Not Detected  
 RL= Reporting Limit



**Batch QC Report**

Purgeable Organics by GC/MS			
Lab #:	281306	Location:	15101 Freedom Avenue San Leandro
Client:	SOMA Environmental Engineering Inc.	Prep:	EPA 5030B
Project#:	2551	Analysis:	EPA 8260B
Matrix:	Water	Batch#:	239438
Units:	ug/L	Analyzed:	09/23/16
Diln Fac:	1.000		

Type: BS Lab ID: QC852860

Analyte	Spiked	Result	%REC	Limits
tert-Butyl Alcohol (TBA)	62.50	54.96	88	32-155
Isopropyl Ether (DIPE)	12.50	12.01	96	57-128
Ethyl tert-Butyl Ether (ETBE)	12.50	13.43	107	62-120
Methyl tert-Amyl Ether (TAME)	12.50	12.06	96	69-120
MTBE	12.50	12.57	101	65-120
1,2-Dichloroethane	12.50	11.83	95	74-133
Benzene	12.50	12.06	96	80-123
Toluene	12.50	11.68	93	80-121
1,2-Dibromoethane	12.50	11.13	89	80-120
Ethylbenzene	12.50	11.42	91	80-123
m,p-Xylenes	25.00	23.70	95	80-126
o-Xylene	12.50	11.61	93	80-126

Surrogate	%REC	Limits
Dibromofluoromethane	108	80-128
1,2-Dichloroethane-d4	86	75-139
Toluene-d8	93	80-120
Bromofluorobenzene	98	80-120

Type: BSD Lab ID: QC852861

Analyte	Spiked	Result	%REC	Limits	RPD	Lim
tert-Butyl Alcohol (TBA)	62.50	55.30	88	32-155	1	33
Isopropyl Ether (DIPE)	12.50	13.01	104	57-128	8	20
Ethyl tert-Butyl Ether (ETBE)	12.50	13.89	111	62-120	3	20
Methyl tert-Amyl Ether (TAME)	12.50	12.55	100	69-120	4	20
MTBE	12.50	12.96	104	65-120	3	22
1,2-Dichloroethane	12.50	11.93	95	74-133	1	20
Benzene	12.50	13.52	108	80-123	11	20
Toluene	12.50	12.36	99	80-121	6	20
1,2-Dibromoethane	12.50	11.30	90	80-120	1	20
Ethylbenzene	12.50	12.44	100	80-123	8	21
m,p-Xylenes	25.00	25.23	101	80-126	6	21
o-Xylene	12.50	12.79	102	80-126	10	20

Surrogate	%REC	Limits
Dibromofluoromethane	108	80-128
1,2-Dichloroethane-d4	88	75-139
Toluene-d8	93	80-120
Bromofluorobenzene	96	80-120

RPD= Relative Percent Difference

**Batch QC Report**

<b>Purgeable Organics by GC/MS</b>		
Lab #:	281306	Location: 15101 Freedom Avenue San Leandro
Client:	SOMA Environmental Engineering Inc.	Prep: EPA 5030B
Project#:	2551	Analysis: EPA 8260B
Type:	BLANK	Diln Fac: 1.000
Lab ID:	QC852862	Batch#: 239438
Matrix:	Water	Analyzed: 09/23/16
Units:	ug/L	

<b>Analyte</b>	<b>Result</b>	<b>RL</b>
Gasoline C7-C12	ND	50
tert-Butyl Alcohol (TBA)	ND	10
Isopropyl Ether (DIPE)	ND	0.50
Ethyl tert-Butyl Ether (ETBE)	ND	0.50
Methyl tert-Amyl Ether (TAME)	ND	0.50
Ethanol	ND	1,000
MTBE	ND	0.50
1,2-Dichloroethane	ND	0.50
Benzene	ND	0.50
Toluene	ND	0.50
1,2-Dibromoethane	ND	0.50
Ethylbenzene	ND	0.50
m,p-Xylenes	ND	0.50
o-Xylene	ND	0.50

<b>Surrogate</b>	<b>%REC</b>	<b>Limits</b>
Dibromofluoromethane	109	80-128
1,2-Dichloroethane-d4	87	75-139
Toluene-d8	93	80-120
Bromofluorobenzene	101	80-120

ND= Not Detected  
 RL= Reporting Limit

## Batch QC Report

Purgeable Organics by GC/MS			
Lab #:	281306	Location:	15101 Freedom Avenue San Leandro
Client:	SOMA Environmental Engineering Inc.	Prep:	EPA 5030B
Project#:	2551	Analysis:	EPA 8260B
Matrix:	Water	Batch#:	239438
Units:	ug/L	Analyzed:	09/23/16
Diln Fac:	1.000		

Type: BS Lab ID: QC852863

Analyte	Spiked	Result	%REC	Limits
Gasoline C7-C12	1,000	1,018	102	76-120

Surrogate	%REC	Limits
Dibromofluoromethane	109	80-128
1,2-Dichloroethane-d4	88	75-139
Toluene-d8	92	80-120
Bromofluorobenzene	101	80-120

Type: BSD Lab ID: QC852864

Analyte	Spiked	Result	%REC	Limits	RPD	Lim
Gasoline C7-C12	1,000	929.2	93	76-120	9	20

Surrogate	%REC	Limits
Dibromofluoromethane	108	80-128
1,2-Dichloroethane-d4	85	75-139
Toluene-d8	93	80-120
Bromofluorobenzene	98	80-120

RPD= Relative Percent Difference

**Batch QC Report**

Purgeable Organics by GC/MS			
Lab #:	281306	Location:	15101 Freedom Avenue San Leandro
Client:	SOMA Environmental Engineering Inc.	Prep:	EPA 5030B
Project#:	2551	Analysis:	EPA 8260B
Matrix:	Water	Batch#:	239460
Units:	ug/L	Analyzed:	09/24/16
Diln Fac:	1.000		

Type: BS Lab ID: QC852951

Analyte	Spiked	Result	%REC	Limits
tert-Butyl Alcohol (TBA)	62.50	60.00	96	32-155
Isopropyl Ether (DIPE)	12.50	12.65	101	57-128
Ethyl tert-Butyl Ether (ETBE)	12.50	13.32	107	62-120
Methyl tert-Amyl Ether (TAME)	12.50	12.03	96	69-120
MTBE	12.50	12.93	103	65-120
1,2-Dichloroethane	12.50	11.59	93	74-133
Benzene	12.50	13.15	105	80-123
Toluene	12.50	12.28	98	80-121
1,2-Dibromoethane	12.50	11.26	90	80-120
Ethylbenzene	12.50	12.46	100	80-123
m,p-Xylenes	25.00	25.53	102	80-126
o-Xylene	12.50	12.33	99	80-126

Surrogate	%REC	Limits
Dibromofluoromethane	111	80-128
1,2-Dichloroethane-d4	84	75-139
Toluene-d8	91	80-120
Bromofluorobenzene	97	80-120

Type: BSD Lab ID: QC852952

Analyte	Spiked	Result	%REC	Limits	RPD	Lim
tert-Butyl Alcohol (TBA)	62.50	60.27	96	32-155	0	33
Isopropyl Ether (DIPE)	12.50	12.92	103	57-128	2	20
Ethyl tert-Butyl Ether (ETBE)	12.50	13.98	112	62-120	5	20
Methyl tert-Amyl Ether (TAME)	12.50	12.57	101	69-120	4	20
MTBE	12.50	13.09	105	65-120	1	22
1,2-Dichloroethane	12.50	12.27	98	74-133	6	20
Benzene	12.50	13.13	105	80-123	0	20
Toluene	12.50	11.97	96	80-121	3	20
1,2-Dibromoethane	12.50	11.45	92	80-120	2	20
Ethylbenzene	12.50	12.27	98	80-123	1	21
m,p-Xylenes	25.00	24.94	100	80-126	2	21
o-Xylene	12.50	12.47	100	80-126	1	20

Surrogate	%REC	Limits
Dibromofluoromethane	110	80-128
1,2-Dichloroethane-d4	85	75-139
Toluene-d8	87	80-120
Bromofluorobenzene	97	80-120

RPD= Relative Percent Difference

**Batch QC Report**

<b>Purgeable Organics by GC/MS</b>		
Lab #:	281306	Location: 15101 Freedom Avenue San Leandro
Client:	SOMA Environmental Engineering Inc.	Prep: EPA 5030B
Project#:	2551	Analysis: EPA 8260B
Type:	BLANK	Diln Fac: 1.000
Lab ID:	QC852953	Batch#: 239460
Matrix:	Water	Analyzed: 09/24/16
Units:	ug/L	

<b>Analyte</b>	<b>Result</b>	<b>RL</b>
Gasoline C7-C12	ND	50
tert-Butyl Alcohol (TBA)	ND	10
Isopropyl Ether (DIPE)	ND	0.50
Ethyl tert-Butyl Ether (ETBE)	ND	0.50
Methyl tert-Amyl Ether (TAME)	ND	0.50
Ethanol	ND	1,000
MTBE	ND	0.50
1,2-Dichloroethane	ND	0.50
Benzene	ND	0.50
Toluene	ND	0.50
1,2-Dibromoethane	ND	0.50
Ethylbenzene	ND	0.50
m,p-Xylenes	ND	0.50
o-Xylene	ND	0.50

<b>Surrogate</b>	<b>%REC</b>	<b>Limits</b>
Dibromofluoromethane	113	80-128
1,2-Dichloroethane-d4	85	75-139
Toluene-d8	91	80-120
Bromofluorobenzene	100	80-120

ND= Not Detected  
 RL= Reporting Limit

## Batch QC Report

Purgeable Organics by GC/MS			
Lab #:	281306	Location:	15101 Freedom Avenue San Leandro
Client:	SOMA Environmental Engineering Inc.	Prep:	EPA 5030B
Project#:	2551	Analysis:	EPA 8260B
Matrix:	Water	Batch#:	239460
Units:	ug/L	Analyzed:	09/24/16
Diln Fac:	1.000		

Type: BS Lab ID: QC852954

Analyte	Spiked	Result	%REC	Limits
Gasoline C7-C12	1,000	1,023	102	76-120

Surrogate	%REC	Limits
Dibromofluoromethane	111	80-128
1,2-Dichloroethane-d4	89	75-139
Toluene-d8	86	80-120
Bromofluorobenzene	101	80-120

Type: BSD Lab ID: QC852955

Analyte	Spiked	Result	%REC	Limits	RPD	Lim
Gasoline C7-C12	1,000	975.7	98	76-120	5	20

Surrogate	%REC	Limits
Dibromofluoromethane	112	80-128
1,2-Dichloroethane-d4	86	75-139
Toluene-d8	90	80-120
Bromofluorobenzene	99	80-120

RPD= Relative Percent Difference

**Batch QC Report**

Purgeable Organics by GC/MS			
Lab #:	281306	Location:	15101 Freedom Avenue San Leandro
Client:	SOMA Environmental Engineering Inc.	Prep:	EPA 5030B
Project#:	2551	Analysis:	EPA 8260B
Matrix:	Water	Batch#:	239530
Units:	ug/L	Analyzed:	09/27/16
Diln Fac:	1.000		

Type: BS Lab ID: QC853215

Analyte	Spiked	Result	%REC	Limits
tert-Butyl Alcohol (TBA)	62.50	49.85	80	32-155
Isopropyl Ether (DIPE)	12.50	11.15	89	57-128
Ethyl tert-Butyl Ether (ETBE)	12.50	11.72	94	62-120
Methyl tert-Amyl Ether (TAME)	12.50	11.93	95	69-120
MTBE	12.50	10.34	83	65-120
1,2-Dichloroethane	12.50	13.77	110	74-133
Benzene	12.50	12.98	104	80-123
Toluene	12.50	12.23	98	80-121
1,2-Dibromoethane	12.50	10.14	81	80-120
Ethylbenzene	12.50	12.84	103	80-123
m,p-Xylenes	25.00	24.95	100	80-126
o-Xylene	12.50	12.69	101	80-126

Surrogate	%REC	Limits
Dibromofluoromethane	96	80-128
1,2-Dichloroethane-d4	111	75-139
Toluene-d8	96	80-120
Bromofluorobenzene	92	80-120

Type: BSD Lab ID: QC853216

Analyte	Spiked	Result	%REC	Limits	RPD	Lim
tert-Butyl Alcohol (TBA)	62.50	51.45	82	32-155	3	33
Isopropyl Ether (DIPE)	12.50	11.22	90	57-128	1	20
Ethyl tert-Butyl Ether (ETBE)	12.50	11.62	93	62-120	1	20
Methyl tert-Amyl Ether (TAME)	12.50	11.96	96	69-120	0	20
MTBE	12.50	10.72	86	65-120	4	22
1,2-Dichloroethane	12.50	13.47	108	74-133	2	20
Benzene	12.50	12.64	101	80-123	3	20
Toluene	12.50	11.88	95	80-121	3	20
1,2-Dibromoethane	12.50	10.48	84	80-120	3	20
Ethylbenzene	12.50	12.30	98	80-123	4	21
m,p-Xylenes	25.00	23.70	95	80-126	5	21
o-Xylene	12.50	11.67	93	80-126	8	20

Surrogate	%REC	Limits
Dibromofluoromethane	97	80-128
1,2-Dichloroethane-d4	106	75-139
Toluene-d8	95	80-120
Bromofluorobenzene	92	80-120

RPD= Relative Percent Difference

## Batch QC Report

Purgeable Organics by GC/MS		
Lab #:	281306	Location: 15101 Freedom Avenue San Leandro
Client:	SOMA Environmental Engineering Inc.	Prep: EPA 5030B
Project#:	2551	Analysis: EPA 8260B
Type:	BLANK	Diln Fac: 1.000
Lab ID:	QC853217	Batch#: 239530
Matrix:	Water	Analyzed: 09/27/16
Units:	ug/L	

Analyte	Result	RL
Gasoline C7-C12	ND	50
tert-Butyl Alcohol (TBA)	ND	10
Isopropyl Ether (DIPE)	ND	0.50
Ethyl tert-Butyl Ether (ETBE)	ND	0.50
Methyl tert-Amyl Ether (TAME)	ND	0.50
Ethanol	ND	1,000
MTBE	ND	0.50
1,2-Dichloroethane	ND	0.50
Benzene	ND	0.50
Toluene	ND	0.50
1,2-Dibromoethane	ND	0.50
Ethylbenzene	ND	0.50
m,p-Xylenes	ND	0.50
o-Xylene	ND	0.50

Surrogate	%REC	Limits
Dibromofluoromethane	95	80-128
1,2-Dichloroethane-d4	99	75-139
Toluene-d8	95	80-120
Bromofluorobenzene	94	80-120

ND= Not Detected

RL= Reporting Limit



## Batch QC Report

Purgeable Organics by GC/MS			
Lab #:	281306	Location:	15101 Freedom Avenue San Leandro
Client:	SOMA Environmental Engineering Inc.	Prep:	EPA 5030B
Project#:	2551	Analysis:	EPA 8260B
Matrix:	Water	Batch#:	239530
Units:	ug/L	Analyzed:	09/27/16
Diln Fac:	1.000		

Type: BS Lab ID: QC853243

Analyte	Spiked	Result	%REC	Limits
Gasoline C7-C12	1,000	1,128	113	76-120

Surrogate	%REC	Limits
Dibromofluoromethane	96	80-128
1,2-Dichloroethane-d4	108	75-139
Toluene-d8	96	80-120
Bromofluorobenzene	94	80-120

Type: BSD Lab ID: QC853244

Analyte	Spiked	Result	%REC	Limits	RPD	Lim
Gasoline C7-C12	1,000	1,071	107	76-120	5	20

Surrogate	%REC	Limits
Dibromofluoromethane	95	80-128
1,2-Dichloroethane-d4	101	75-139
Toluene-d8	97	80-120
Bromofluorobenzene	94	80-120

RPD= Relative Percent Difference

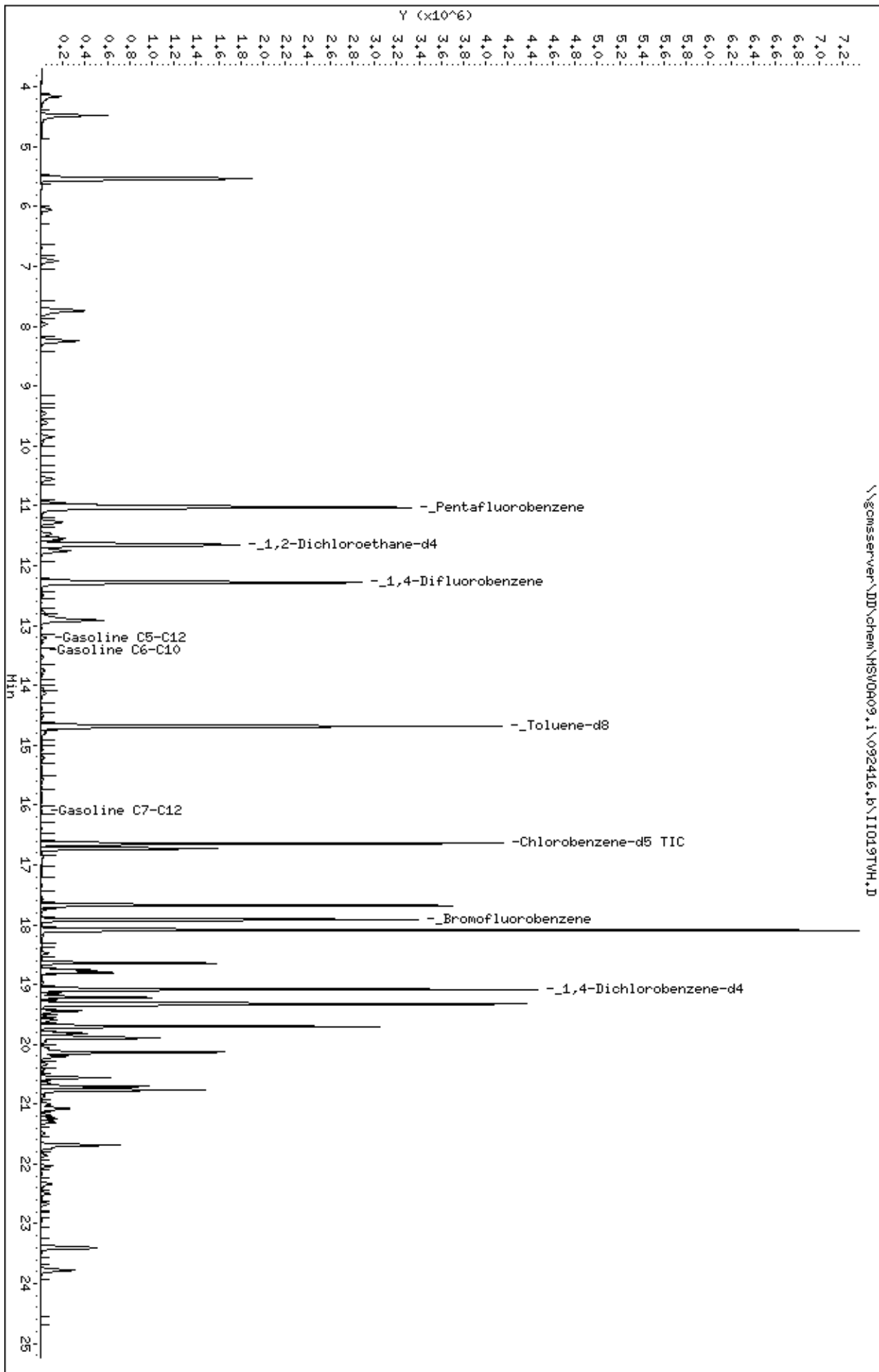



Quantitation Report (QT Reviewed)

Data Path : G:\msvoa09\092416\  
 Data File : IIO20.D  
 Acq On : 25 Sep 2016 12:34 am  
 Operator : VOC  
 Sample : s,281306-003  
 Misc : 239460,10/50  
 ALS Vial : 20 Sample Multiplier: 1

Quant Time: Sep 28 15:30:54 2016  
 Quant Method : C:\msdchem\1\METHODS\8260X09W.M  
 Quant Title : MSVOA09 MSVOA WATER  
 QLast Update : Fri Sep 02 13:27:42 2016  
 Response via : Initial Calibration

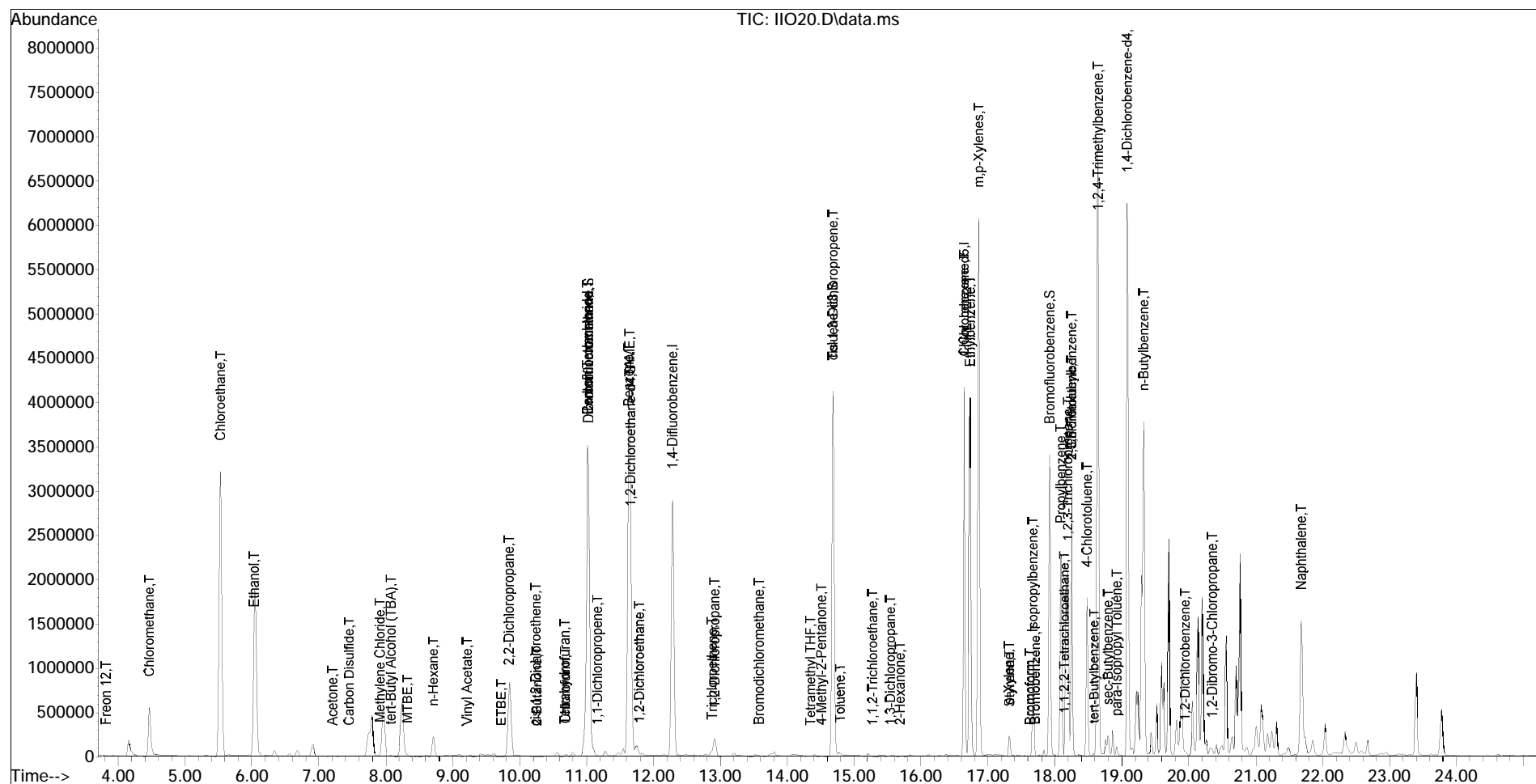

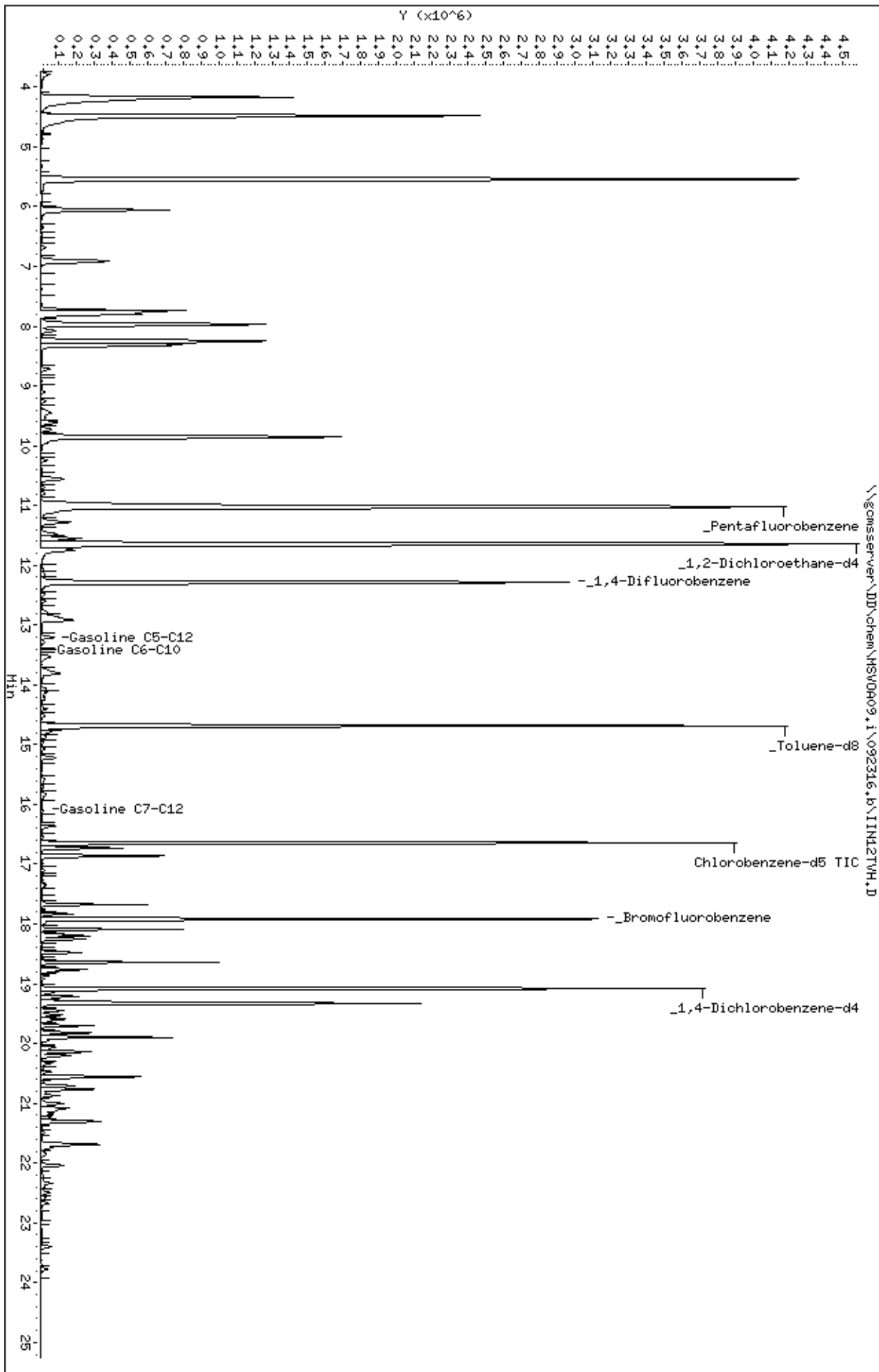

Column phase:

Operator: WDC  
Column diameter: 2.00

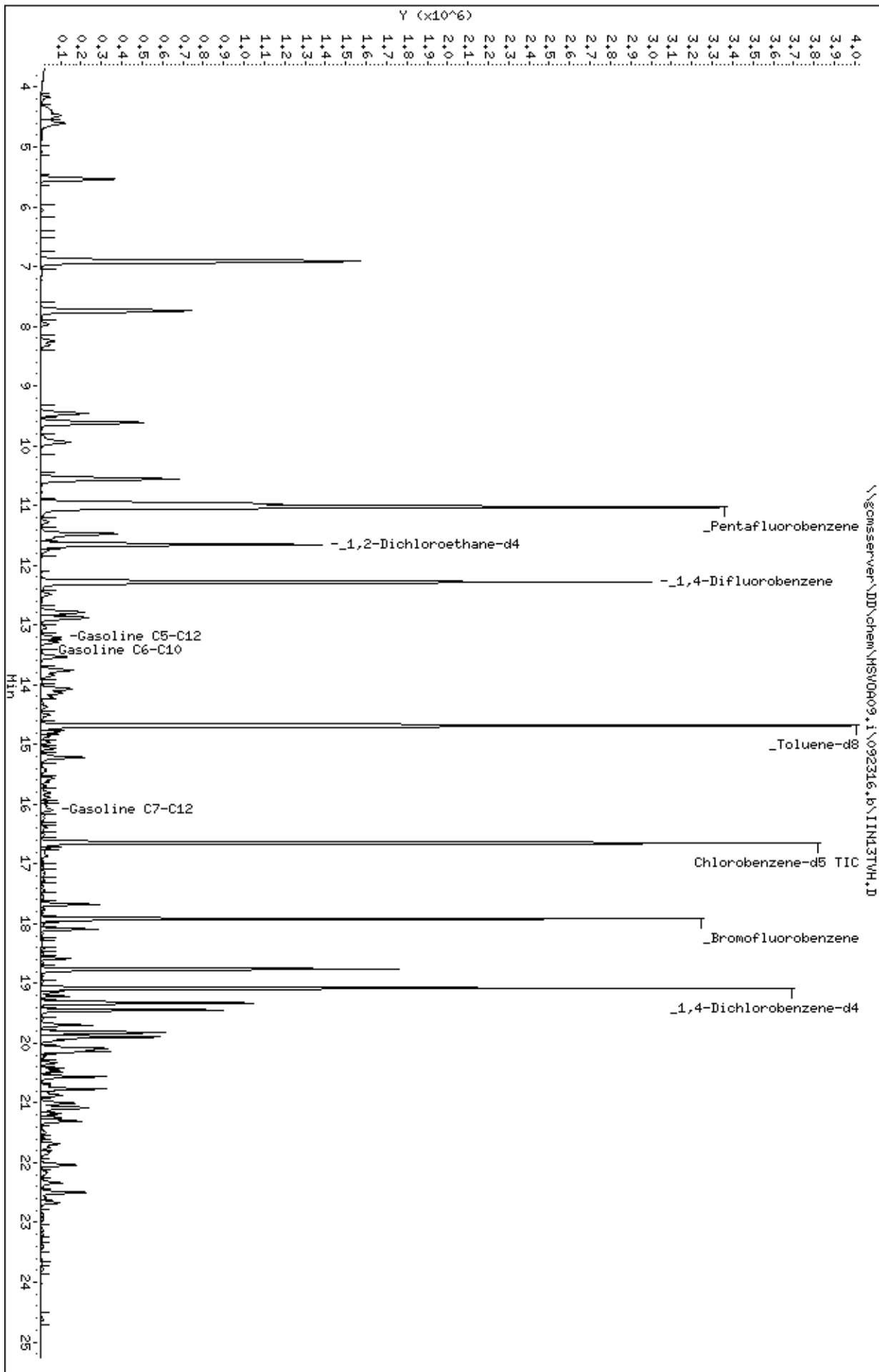

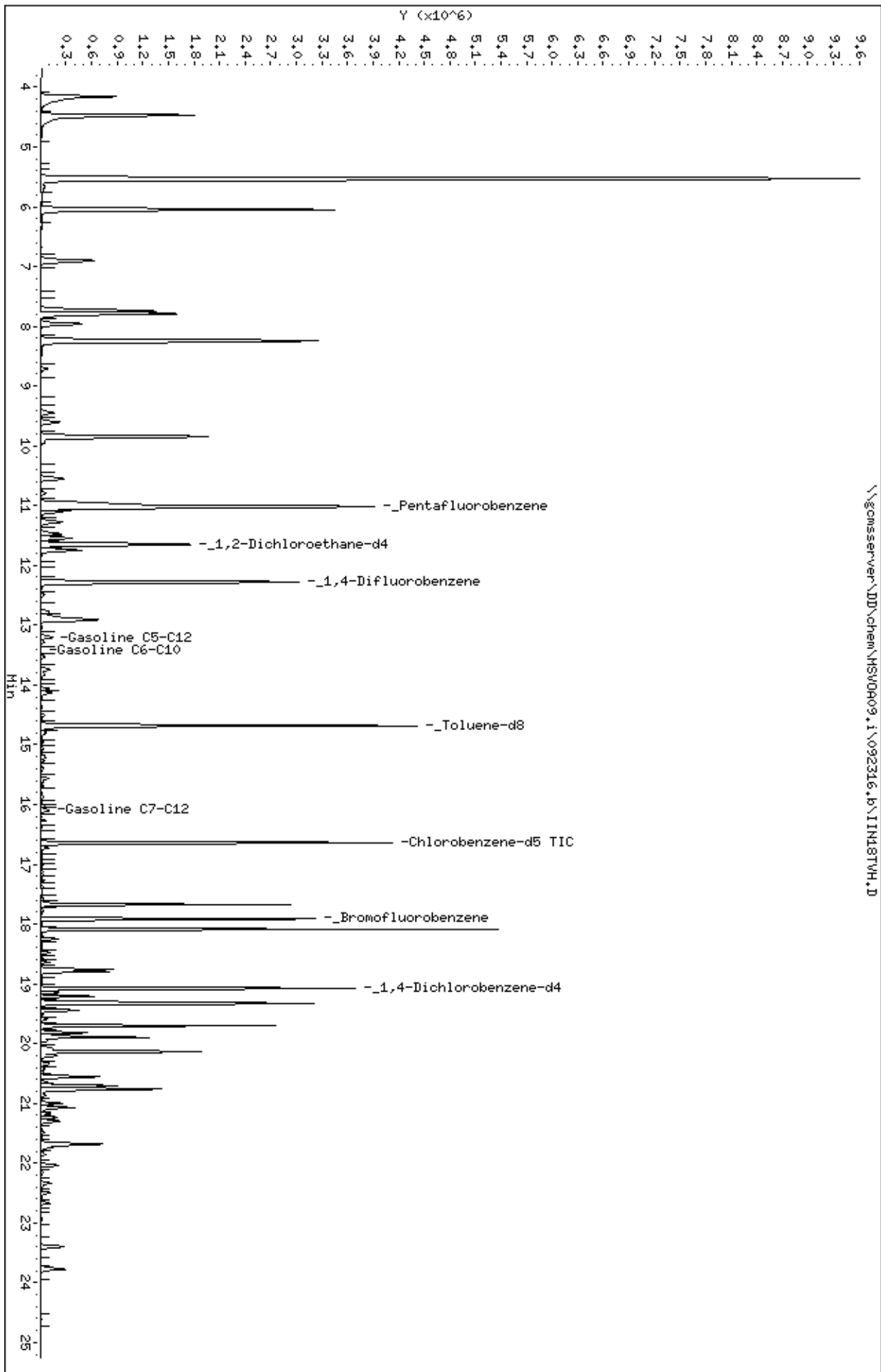

Quantitation Report (QT Reviewed)

Data Path : G:\msvoa09\092316\  
 Data File : IIN14.D  
 Acq On : 23 Sep 2016 7:09 pm  
 Operator : VOC  
 Sample : s,281306-007  
 Misc : 239438,1/1  
 ALS Vial : 14 Sample Multiplier: 1

Quant Time: Sep 28 15:22:19 2016  
 Quant Method : G:\msvoa09\092316\8260X09W.M  
 Quant Title : MSVOA09 MSVOA WATER  
 QLast Update : Wed Sep 07 16:43:19 2016  
 Response via : Initial Calibration

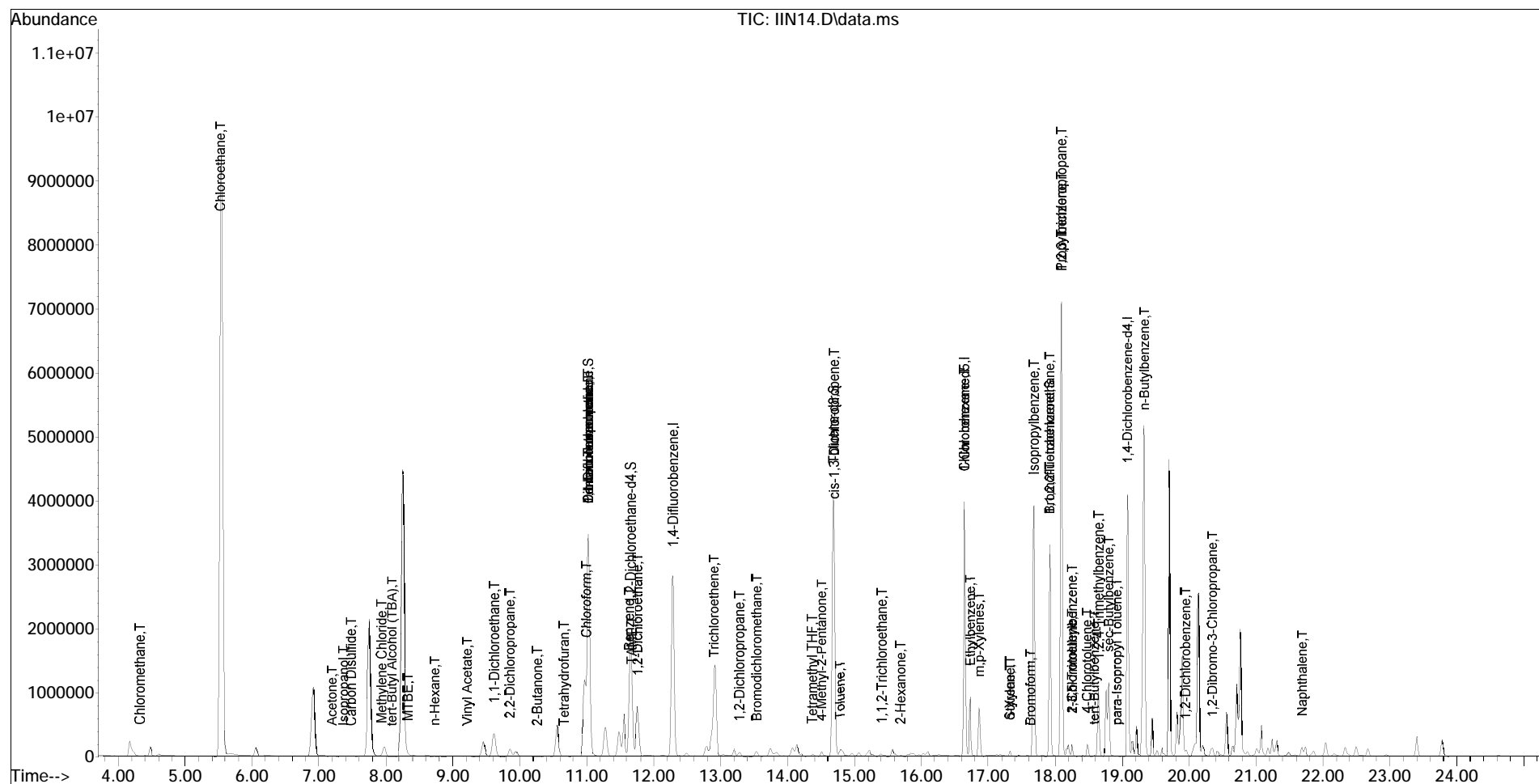



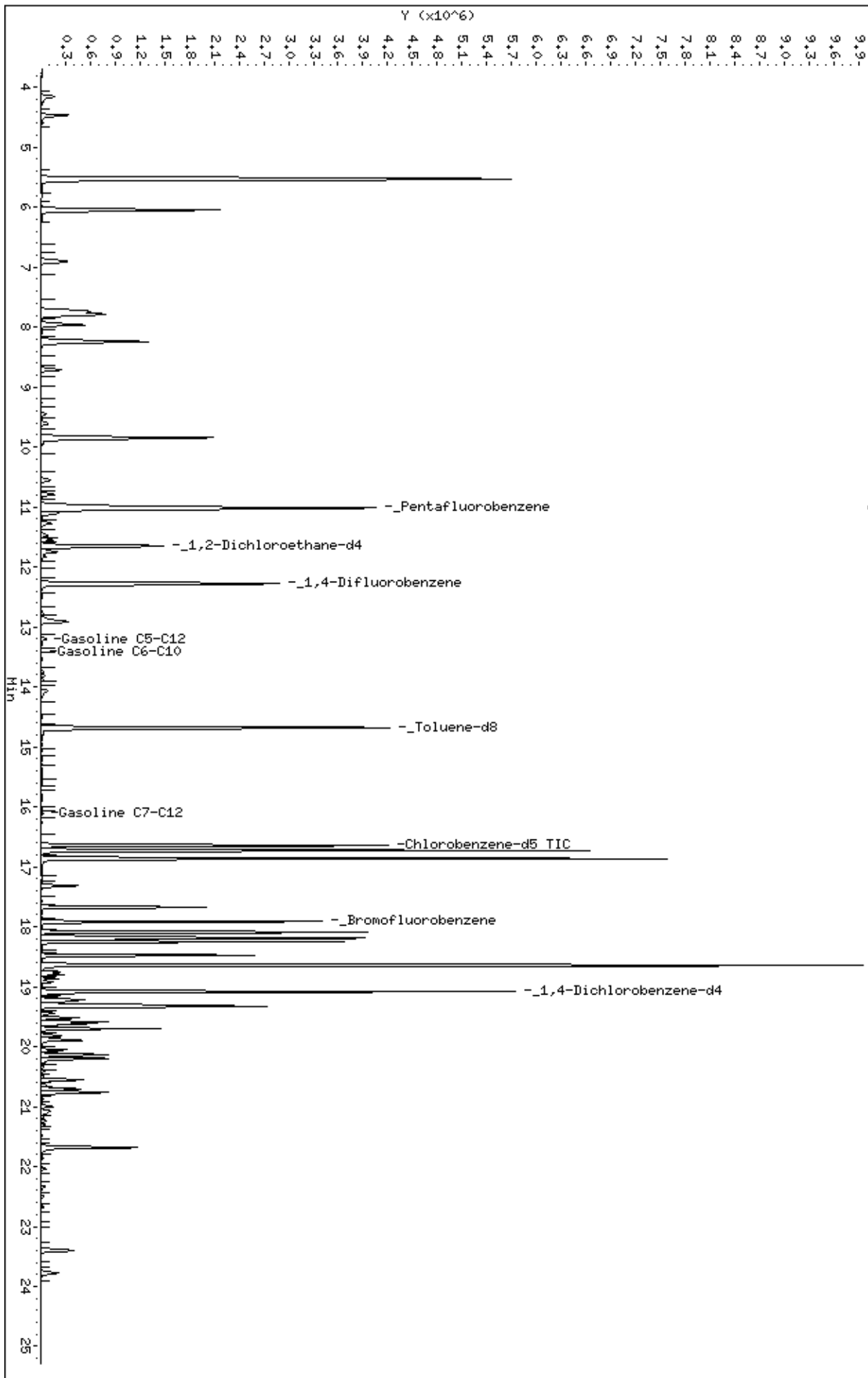

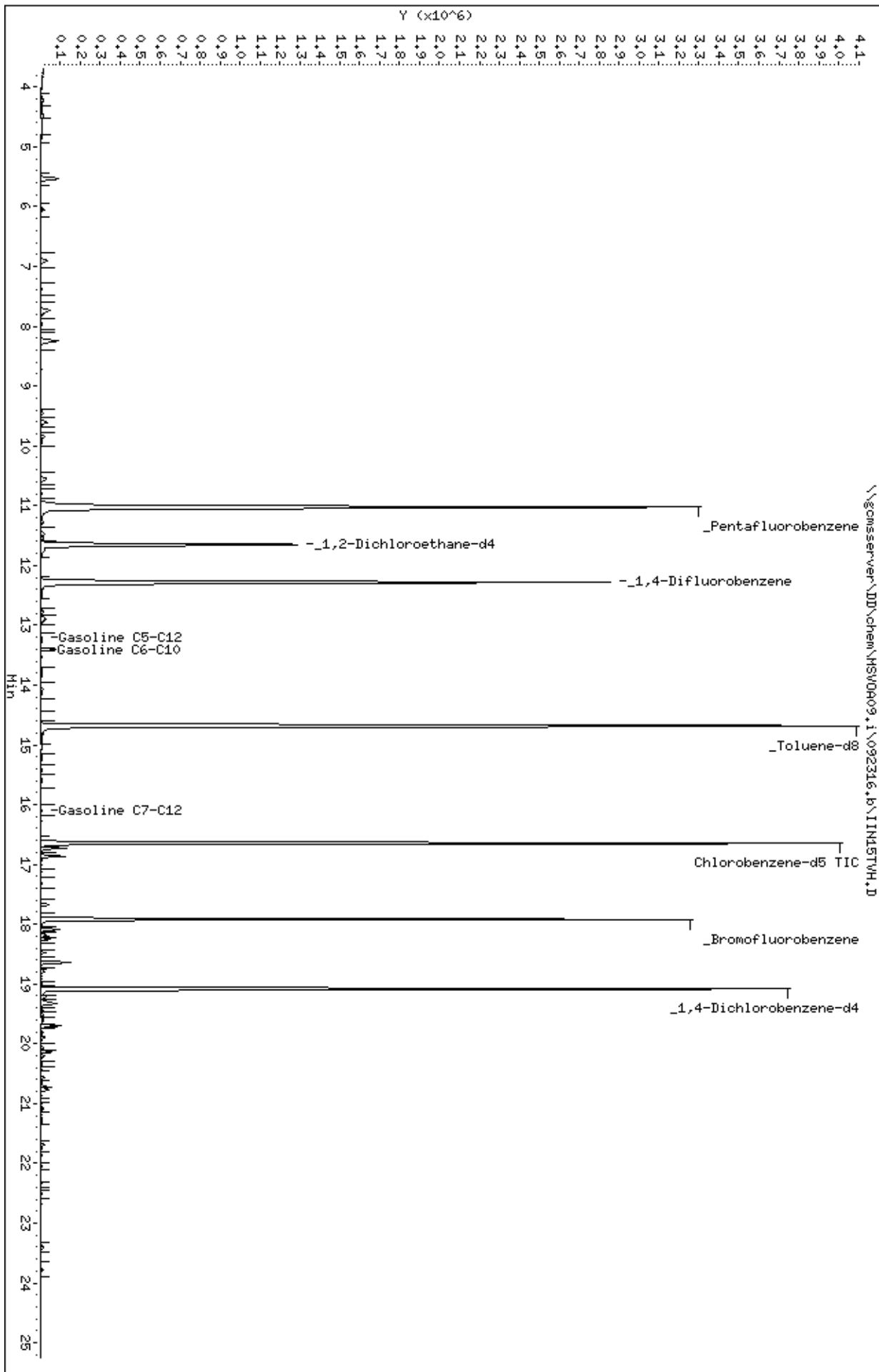

Column phase:

Operator: WDC  
Column diameter: 2.00

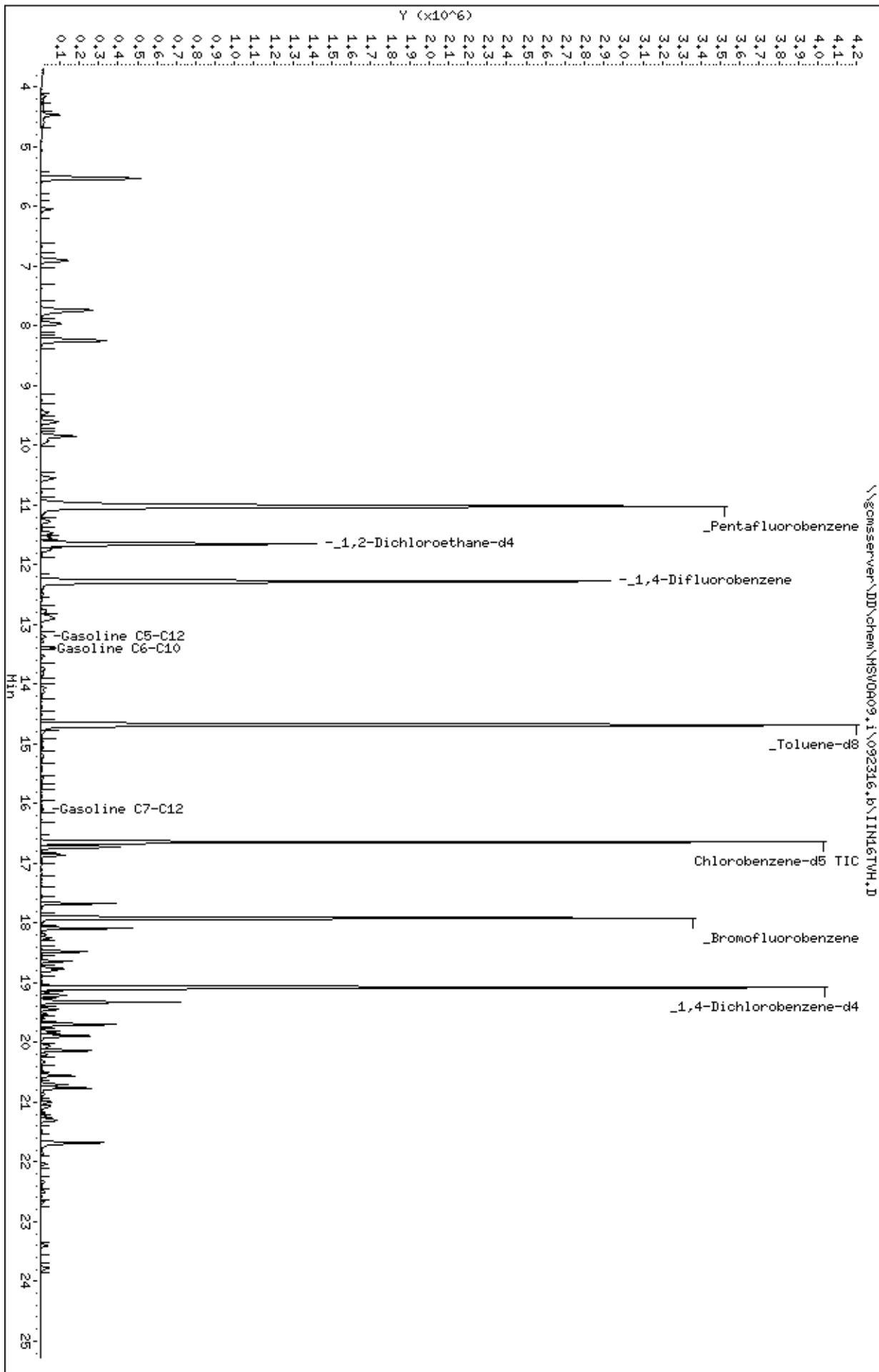

Quantitation Report (QT Reviewed)

Data Path : G:\msvoa09\092416\  
 Data File : IIO18.D  
 Acq On : 24 Sep 2016 11:25 pm  
 Operator : VOC  
 Sample : s,281327-011  
 Misc : 239460,1/1  
 ALS Vial : 18 Sample Multiplier: 1

Quant Time: Sep 26 11:06:46 2016  
 Quant Method : C:\msdchem\1\METHODS\8260X09W.M  
 Quant Title : MSVOA09 MSVOA WATER  
 QLast Update : Fri Sep 02 13:27:42 2016  
 Response via : Initial Calibration

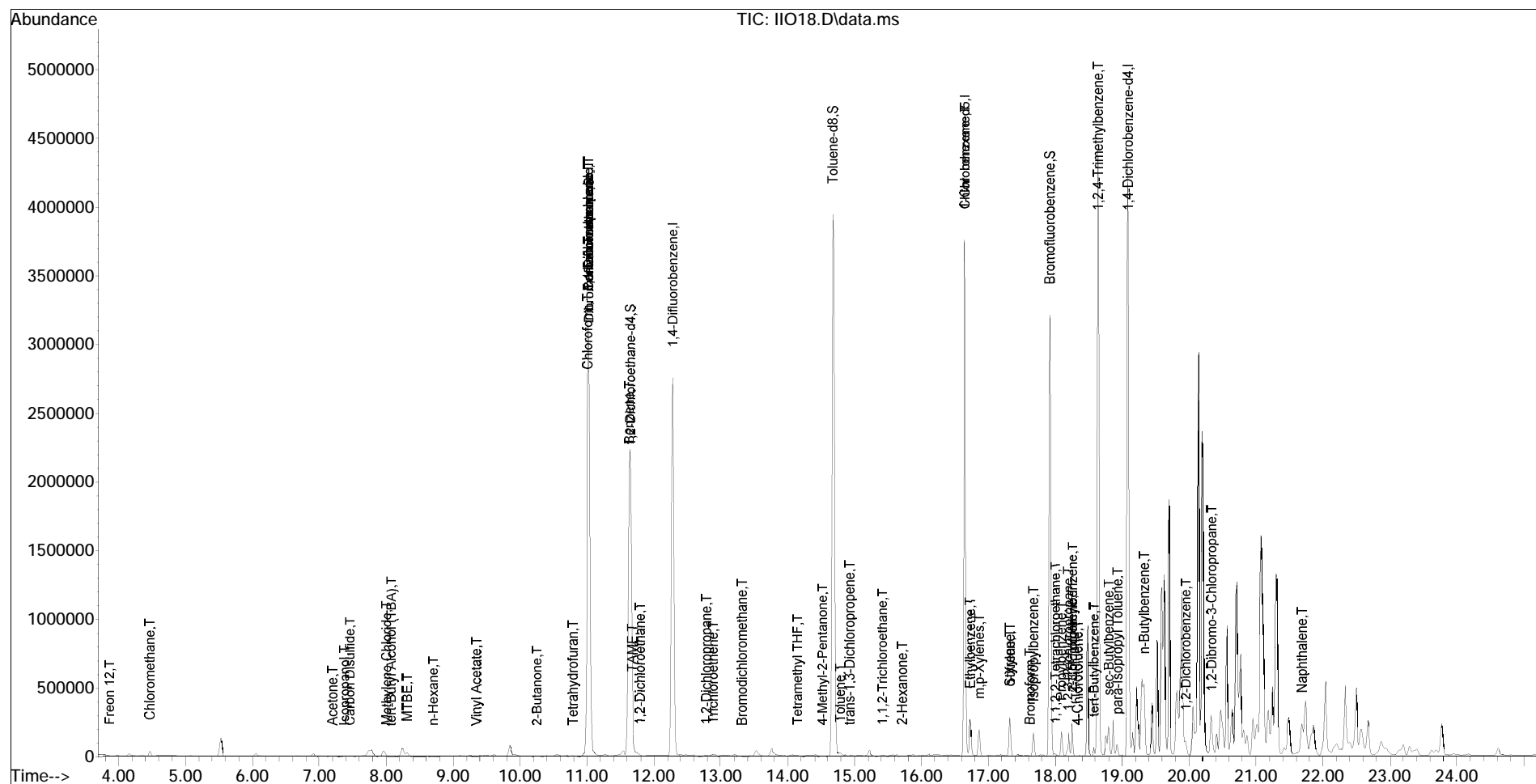

Quantitation Report (QT Reviewed)

Data Path : G:\msvoa09\092316\  
 Data File : IIN21.D  
 Acq On : 23 Sep 2016 11:11 pm  
 Operator : VOC  
 Sample : s,281306-012  
 Misc : 239438,4/50  
 ALS Vial : 21 Sample Multiplier: 1

Quant Time: Sep 28 15:23:00 2016  
 Quant Method : G:\msvoa09\092316\8260X09W.M  
 Quant Title : MSVOA09 MSVOA WATER  
 QLast Update : Wed Sep 07 16:43:19 2016  
 Response via : Initial Calibration

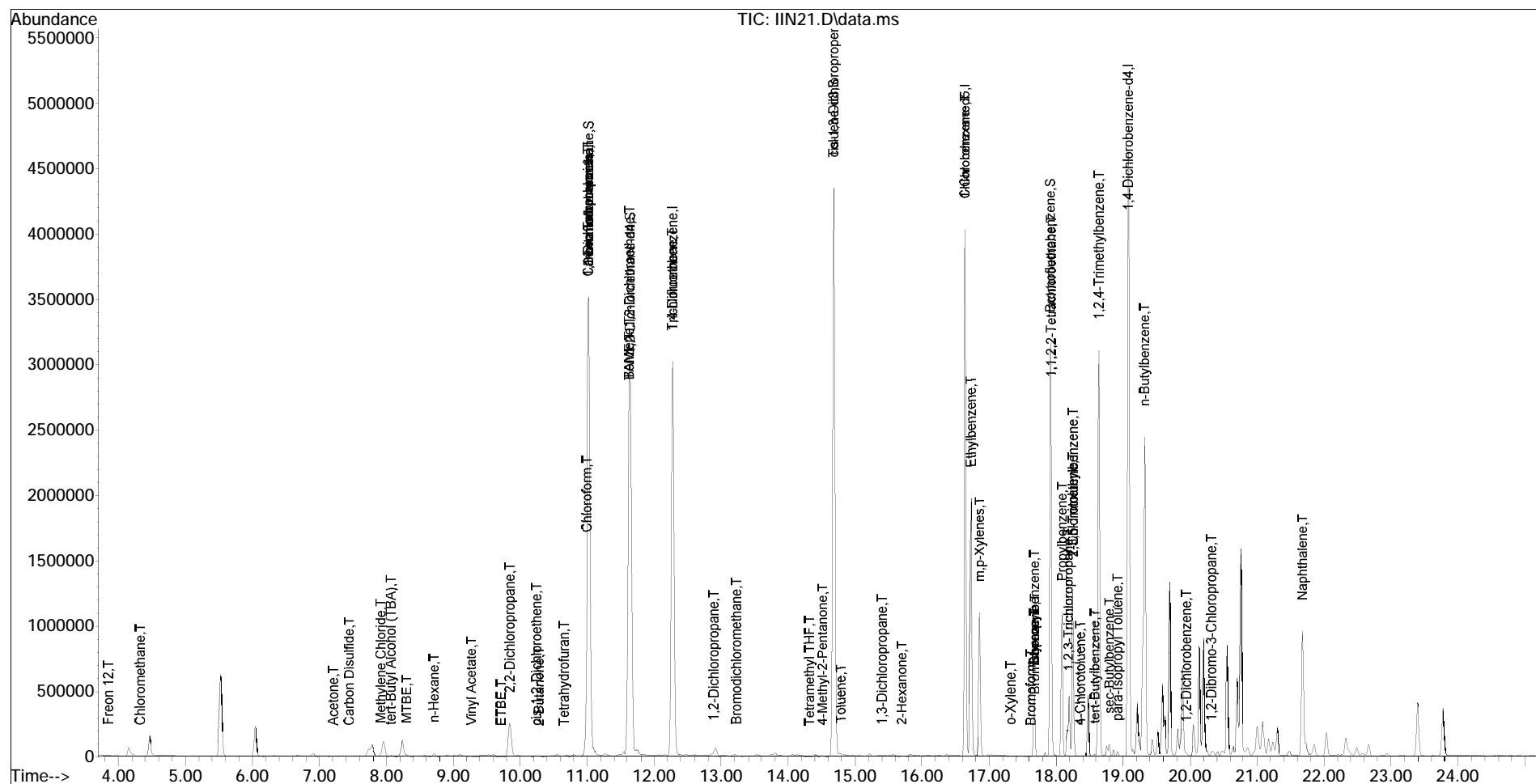

Data File: \\gcmserver\DD\chem\HSV0908.i\092716.b\HIR08TWH.D  
Date: 27-SEP-2016 11:06  
Client ID:  
Sample Info: cov/bs,qc853243,239530,530291,.01/100  
Column phase:

Instrument: HSV0908.i  
Operator: WDC  
Column diameter: 2.00

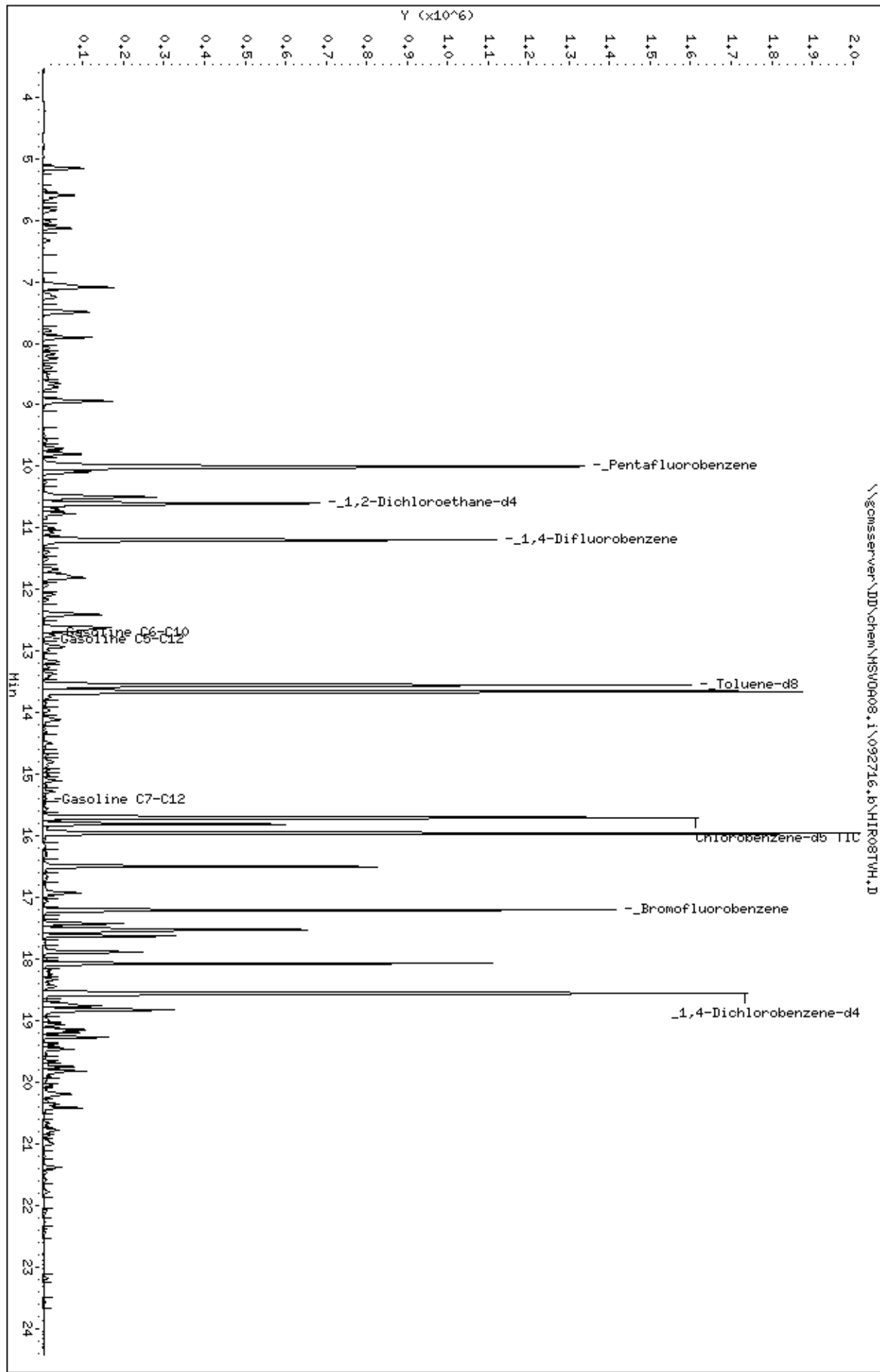



Curtis & Tompkins, Ltd., Analytical Laboratories, Since 1878

2323 Fifth Street, Berkeley, CA 94710, Phone (510) 486-0900

**Laboratory Job Number 279414  
ANALYTICAL REPORT**

SOMA Environmental Engineering Inc.  
6620 Owens Dr.  
Pleasanton, CA 94588

Project : 2556  
Location : 15101 Freedom Ave, San Leandro  
Level : II

Sample ID  
MW-10R

Lab ID  
279414-001

This data package has been reviewed for technical correctness and completeness. Release of this data has been authorized by the Laboratory Manager or the Manager's designee, as verified by the following signature. The results contained in this report meet all requirements of NELAC and pertain only to those samples which were submitted for analysis. This report may be reproduced only in its entirety.

Signature: \_\_\_\_\_

Tracy Babjar  
Project Manager  
tracy.babjar@ctberk.com  
(510) 204-2226

Date: 08/12/2016

CA ELAP# 2896, NELAP# 4044-001

**CASE NARRATIVE**

Laboratory number: 279414  
Client: SOMA Environmental Engineering Inc.  
Project: 2556  
Location: 15101 Freedom Ave, San Leandro  
Request Date: 08/08/16  
Samples Received: 08/08/16

This data package contains sample and QC results for one water sample, requested for the above referenced project on 08/08/16. The sample was received cold and intact.

**Volatile Organics by GC/MS (EPA 8260B):**

MW-10R (lab # 279414-001) was diluted due to high non-target analytes. No other analytical problems were encountered.





**COOLER RECEIPT CHECKLIST**



Curtis & Tompkins, Ltd.

Login # 279414 Date Received 8/8/12 Number of coolers 1  
 Client SGMA Environmental Project 15101 Freedom Ave., San Leandro  
 Date Opened 8/8 By (print) SL (sign) [Signature]  
 Date Logged in ↓ By (print) ↓ (sign) ↓  
 Date Labelled ↓ By (print) ↓ (sign) ↓

1. Did cooler come with a shipping slip (airbill, etc) \_\_\_\_\_ YES  NO  
 Shipping info \_\_\_\_\_

2A. Were custody seals present? ....  YES (circle) on cooler on samples  NO  
 How many \_\_\_\_\_ Name \_\_\_\_\_ Date \_\_\_\_\_

2B. Were custody seals intact upon arrival? \_\_\_\_\_ YES NO  N/A

3. Were custody papers dry and intact when received? \_\_\_\_\_ YES NO  N/A

4. Were custody papers filled out properly (ink, signed, etc)? \_\_\_\_\_ YES NO

5. Is the project identifiable from custody papers? (If so fill out top of form) \_\_\_\_\_ YES NO

6. Indicate the packing in cooler: (if other, describe) \_\_\_\_\_

- Bubble Wrap
- Foam blocks
- Bags
- None
- Cloth material
- Cardboard
- Styrofoam
- Paper towels

7. Temperature documentation: \* Notify PM if temperature exceeds 6°C

Type of ice used:  Wet  Blue/Gel  None Temp(°C) 8.7°

Temperature blank(s) included?  Thermometer# \_\_\_\_\_  IR Gun# B

Samples received on ice directly from the field. Cooling process had begun

8. Were Method 5035 sampling containers present? \_\_\_\_\_ YES  NO  
 If YES, what time were they transferred to freezer? \_\_\_\_\_

9. Did all bottles arrive unbroken/unopened? \_\_\_\_\_ YES NO

10. Are there any missing / extra samples? \_\_\_\_\_ YES NO

11. Are samples in the appropriate containers for indicated tests? \_\_\_\_\_ YES  NO

12. Are sample labels present, in good condition and complete? \_\_\_\_\_ YES NO

13. Do the sample labels agree with custody papers? \_\_\_\_\_ YES NO

14. Was sufficient amount of sample sent for tests requested? \_\_\_\_\_ YES NO

15. Are the samples appropriately preserved? \_\_\_\_\_ YES NO  N/A

16. Did you check preservatives for all bottles for each sample? \_\_\_\_\_ YES NO  N/A

17. Did you document your preservative check? (pH strip lot# \_\_\_\_\_) YES NO  N/A

18. Did you change the hold time in LIMS for unpreserved VOAs? \_\_\_\_\_ YES NO  N/A

19. Did you change the hold time in LIMS for preserved terracores? \_\_\_\_\_ YES NO  N/A

20. Are bubbles > 6mm absent in VOA samples? \_\_\_\_\_ YES NO  N/A

21. Was the client contacted concerning this sample delivery? \_\_\_\_\_ YES  NO

If YES, Who was called? \_\_\_\_\_ By \_\_\_\_\_ Date: \_\_\_\_\_

COMMENTS \_\_\_\_\_  
 \_\_\_\_\_  
 \_\_\_\_\_  
 \_\_\_\_\_  
 \_\_\_\_\_

## Detections Summary for 279414

Results for any subcontracted analyses are not included in this summary.

Client : SOMA Environmental Engineering Inc.  
 Project : 2556  
 Location : 15101 Freedom Ave, San Leandro

Client Sample ID : MW-10R

Laboratory Sample ID :

279414-001

Analyte	Result	Flags	RL	Units	Basis	IDF	Method	Prep Method
Gasoline C7-C12	8,100		420	ug/L	As Recd	8.333	EPA 8260B	EPA 5030B
tert-Butyl Alcohol (TBA)	91		83	ug/L	As Recd	8.333	EPA 8260B	EPA 5030B
Ethylbenzene	150		4.2	ug/L	As Recd	8.333	EPA 8260B	EPA 5030B
m,p-Xylenes	260		4.2	ug/L	As Recd	8.333	EPA 8260B	EPA 5030B
o-Xylene	7.1		4.2	ug/L	As Recd	8.333	EPA 8260B	EPA 5030B

### Purgeable Organics by GC/MS

Lab #: 279414	Location: 15101 Freedom Ave, San Leandro
Client: SOMA Environmental Engineering Inc.	Prep: EPA 5030B
Project#: 2556	Analysis: EPA 8260B
Field ID: MW-10R	Batch#: 237896
Lab ID: 279414-001	Sampled: 08/08/16
Matrix: Water	Received: 08/08/16
Units: ug/L	Analyzed: 08/11/16
Diln Fac: 8.333	

Analyte	Result	RL
Gasoline C7-C12	8,100	420
tert-Butyl Alcohol (TBA)	91	83
Isopropyl Ether (DIPE)	ND	4.2
Ethyl tert-Butyl Ether (ETBE)	ND	4.2
Methyl tert-Amyl Ether (TAME)	ND	4.2
Ethanol	ND	8,300
MTBE	ND	4.2
1,2-Dichloroethane	ND	4.2
Benzene	ND	4.2
Toluene	ND	4.2
1,2-Dibromoethane	ND	4.2
Ethylbenzene	150	4.2
m,p-Xylenes	260	4.2
o-Xylene	7.1	4.2

Surrogate	%REC	Limits
Dibromofluoromethane	103	80-128
1,2-Dichloroethane-d4	109	75-139
Toluene-d8	98	80-120
Bromofluorobenzene	99	80-120

ND= Not Detected  
 RL= Reporting Limit

**Batch QC Report**

Purgeable Organics by GC/MS			
Lab #:	279414	Location:	15101 Freedom Ave, San Leandro
Client:	SOMA Environmental Engineering Inc.	Prep:	EPA 5030B
Project#:	2556	Analysis:	EPA 8260B
Matrix:	Water	Batch#:	237896
Units:	ug/L	Analyzed:	08/10/16
Diln Fac:	1.000		

Type: BS Lab ID: QC846680

Analyte	Spiked	Result	%REC	Limits
tert-Butyl Alcohol (TBA)	62.50	62.60	100	32-155
Isopropyl Ether (DIPE)	12.50	11.92	95	57-128
Ethyl tert-Butyl Ether (ETBE)	12.50	12.67	101	62-120
Methyl tert-Amyl Ether (TAME)	12.50	12.16	97	69-120
MTBE	12.50	11.37	91	65-120
1,2-Dichloroethane	12.50	12.45	100	74-133
Benzene	12.50	13.82	111	80-123
Toluene	12.50	12.70	102	80-121
1,2-Dibromoethane	12.50	11.92	95	80-120
Ethylbenzene	12.50	13.59	109	80-123
m,p-Xylenes	25.00	26.31	105	80-126
o-Xylene	12.50	12.66	101	80-126

Surrogate	%REC	Limits
Dibromofluoromethane	102	80-128
1,2-Dichloroethane-d4	99	75-139
Toluene-d8	97	80-120
Bromofluorobenzene	98	80-120

Type: BSD Lab ID: QC846681

Analyte	Spiked	Result	%REC	Limits	RPD	Lim
tert-Butyl Alcohol (TBA)	62.50	62.08	99	32-155	1	33
Isopropyl Ether (DIPE)	12.50	11.32	91	57-128	5	20
Ethyl tert-Butyl Ether (ETBE)	12.50	11.28	90	62-120	12	20
Methyl tert-Amyl Ether (TAME)	12.50	11.62	93	69-120	4	20
MTBE	12.50	11.38	91	65-120	0	22
1,2-Dichloroethane	12.50	11.59	93	74-133	7	20
Benzene	12.50	12.19	98	80-123	13	20
Toluene	12.50	12.17	97	80-121	4	20
1,2-Dibromoethane	12.50	11.43	91	80-120	4	20
Ethylbenzene	12.50	12.54	100	80-123	8	21
m,p-Xylenes	25.00	24.34	97	80-126	8	21
o-Xylene	12.50	12.08	97	80-126	5	20

Surrogate	%REC	Limits
Dibromofluoromethane	102	80-128
1,2-Dichloroethane-d4	99	75-139
Toluene-d8	98	80-120
Bromofluorobenzene	98	80-120

RPD= Relative Percent Difference

**Batch QC Report**

Purgeable Organics by GC/MS		
Lab #:	279414	Location: 15101 Freedom Ave, San Leandro
Client:	SOMA Environmental Engineering Inc.	Prep: EPA 5030B
Project#:	2556	Analysis: EPA 8260B
Type:	BLANK	Diln Fac: 1.000
Lab ID:	QC846682	Batch#: 237896
Matrix:	Water	Analyzed: 08/10/16
Units:	ug/L	

Analyte	Result	RL
Gasoline C7-C12	ND	50
tert-Butyl Alcohol (TBA)	ND	10
Isopropyl Ether (DIPE)	ND	0.50
Ethyl tert-Butyl Ether (ETBE)	ND	0.50
Methyl tert-Amyl Ether (TAME)	ND	0.50
Ethanol	ND	1,000
MTBE	ND	0.50
1,2-Dichloroethane	ND	0.50
Benzene	ND	0.50
Toluene	ND	0.50
1,2-Dibromoethane	ND	0.50
Ethylbenzene	ND	0.50
m,p-Xylenes	ND	0.50
o-Xylene	ND	0.50

Surrogate	%REC	Limits
Dibromofluoromethane	101	80-128
1,2-Dichloroethane-d4	98	75-139
Toluene-d8	99	80-120
Bromofluorobenzene	98	80-120

ND= Not Detected  
 RL= Reporting Limit

## Batch QC Report

Purgeable Organics by GC/MS			
Lab #:	279414	Location:	15101 Freedom Ave, San Leandro
Client:	SOMA Environmental Engineering Inc.	Prep:	EPA 5030B
Project#:	2556	Analysis:	EPA 8260B
Matrix:	Water	Batch#:	237896
Units:	ug/L	Analyzed:	08/10/16
Diln Fac:	1.000		

Type: BS Lab ID: QC846732

Analyte	Spiked	Result	%REC	Limits
Gasoline C7-C12	1,000	1,127	113	76-120

Surrogate	%REC	Limits
Dibromofluoromethane	103	80-128
1,2-Dichloroethane-d4	97	75-139
Toluene-d8	98	80-120
Bromofluorobenzene	99	80-120

Type: BSD Lab ID: QC846733

Analyte	Spiked	Result	%REC	Limits	RPD	Lim
Gasoline C7-C12	1,000	1,020	102	76-120	10	20

Surrogate	%REC	Limits
Dibromofluoromethane	100	80-128
1,2-Dichloroethane-d4	98	75-139
Toluene-d8	98	80-120
Bromofluorobenzene	96	80-120

RPD= Relative Percent Difference

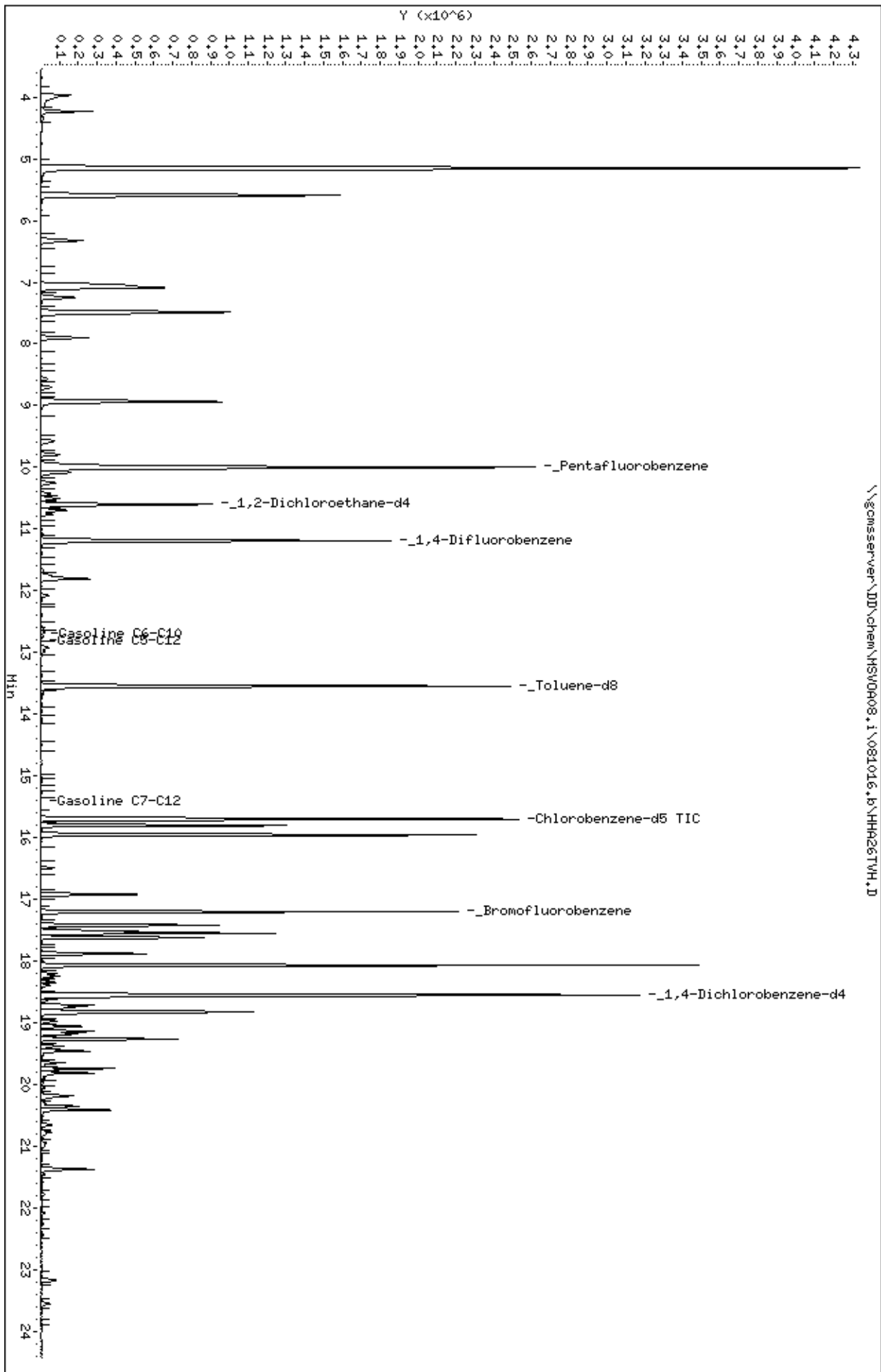



Data File: \\gcmserver\DD\chem\HSV0908.i\081016.b\HH10TVH.D

Date: 10-06-2016 15:00

Client ID:

Sample Info: bs, q0846732, 237896, s30291, 0, 01/100

Column phase:

Instrument: HSV0908.i

Operator: WDC

Column diameter: 2.00

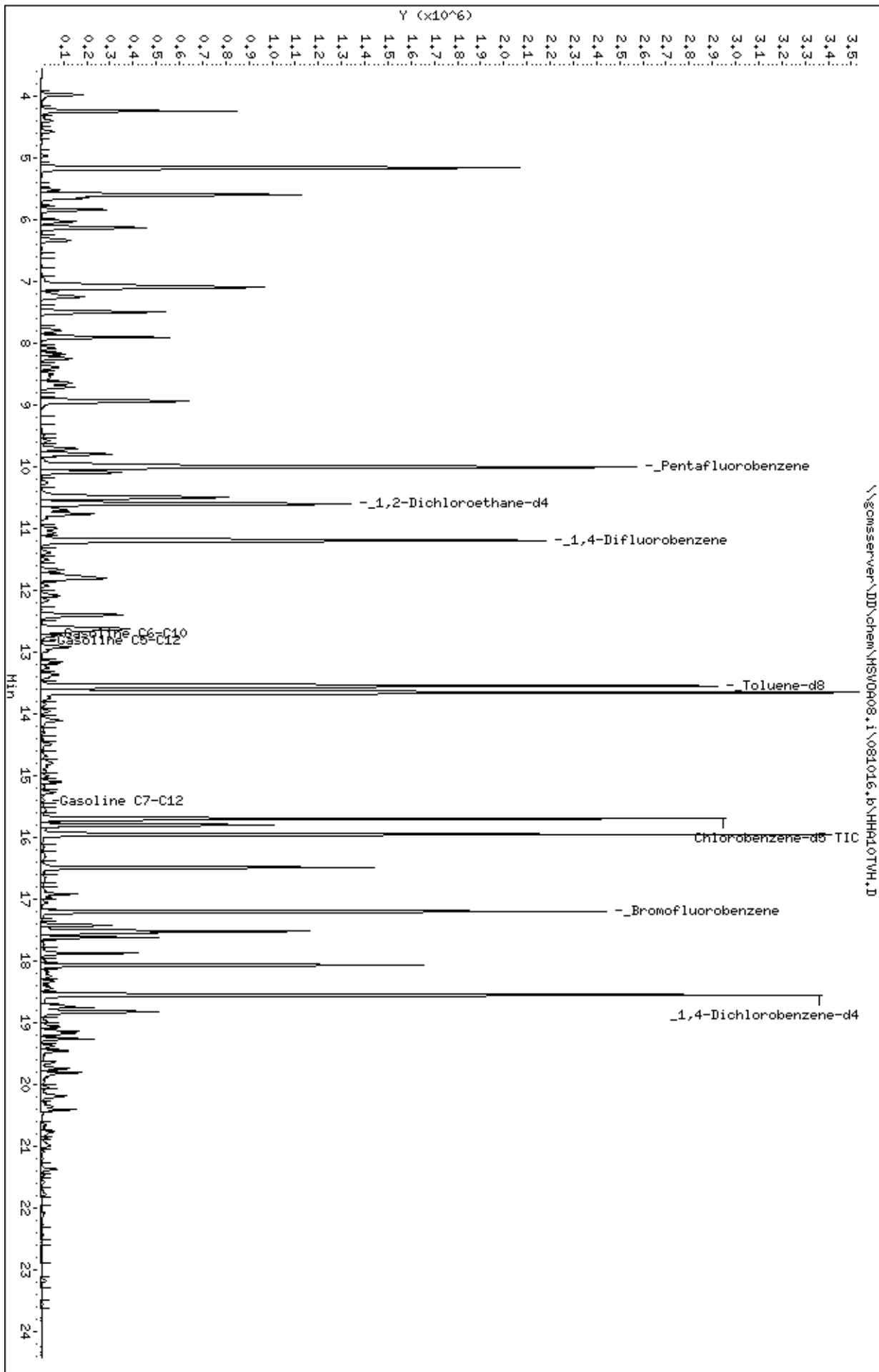

# Appendix D

## Laboratory Reports and Chain of Custody Forms for the Treatment System



Curtis & Tompkins, Ltd., Analytical Laboratories, Since 1878

2323 Fifth Street, Berkeley, CA 94710, Phone (510) 486-0900

**Laboratory Job Number 279357  
ANALYTICAL REPORT**

SOMA Environmental Engineering Inc.  
6620 Owens Dr.  
Pleasanton, CA 94588

Project : 2556  
Location : 15101 Freedom Ave, San Leandro  
Level : II

<u>Sample ID</u>	<u>Lab ID</u>
EFFLUENT	279357-001
INFLUENT	279357-002

This data package has been reviewed for technical correctness and completeness. Release of this data has been authorized by the Laboratory Manager or the Manager's designee, as verified by the following signature. The results contained in this report meet all requirements of NELAC and pertain only to those samples which were submitted for analysis. This report may be reproduced only in its entirety.

Signature: \_\_\_\_\_

Date: 08/16/2016

Will Rice  
Project Manager  
will.rice@ctberk.com

CA ELAP# 2896, NELAP# 4044-001

### CASE NARRATIVE

Laboratory number: 279357  
Client: SOMA Environmental Engineering Inc.  
Project: 2556  
Location: 15101 Freedom Ave, San Leandro  
Request Date: 08/04/16  
Samples Received: 08/04/16

This data package contains sample and QC results for two water samples, requested for the above referenced project on 08/04/16. The samples were received cold and intact.

**TPH-Purgeables and/or BTXE by GC (EPA 8015B and EPA 8021B):**

No analytical problems were encountered.

**TPH-Extractables by GC (EPA 8015B):**

High surrogate recovery was observed for o-terphenyl in EFFLUENT (lab # 279357-001); no target analytes were detected in the sample. No other analytical problems were encountered.



COOLER RECEIPT CHECKLIST

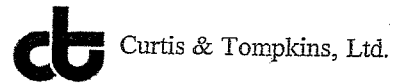

Login # 279357 Date Received 8/14/16 Number of coolers 1  
 Client SCMA Project 15101 Freedom Ave, San Leandro

Date Opened 8/14 By (print) SC (sign) [Signature]  
 Date Logged in 8/15 By (print) [Signature] (sign) [Signature]  
 Date Labelled ↓ By (print) ↓ (sign) ↓

1. Did cooler come with a shipping slip (airbill, etc) \_\_\_\_\_ YES  NO  
 Shipping info \_\_\_\_\_

2A. Were custody seals present? ....  YES (circle) on cooler on samples  NO  
 How many \_\_\_\_\_ Name \_\_\_\_\_ Date \_\_\_\_\_

2B. Were custody seals intact upon arrival? \_\_\_\_\_ YES NO  N/A

3. Were custody papers dry and intact when received?  YES NO

4. Were custody papers filled out properly (ink, signed, etc)?  YES NO

5. Is the project identifiable from custody papers? (If so fill out top of form)  YES NO

6. Indicate the packing in cooler: (if other, describe) \_\_\_\_\_

- Bubble Wrap  Foam blocks  Bags  None
- Cloth material  Cardboard  Styrofoam  Paper towels

7. Temperature documentation: \* Notify PM if temperature exceeds 6°C

Type of ice used:  Wet  Blue/Gel  None Temp(°C) 5.3

Temperature blank(s) included?  Thermometer# \_\_\_\_\_  IR Gun# A

Samples received on ice directly from the field. Cooling process had begun

8. Were Method 5035 sampling containers present? \_\_\_\_\_ YES NO  
 If YES, what time were they transferred to freezer? \_\_\_\_\_

9. Did all bottles arrive unbroken/unopened? \_\_\_\_\_ YES NO

10. Are there any missing / extra samples? \_\_\_\_\_ YES NO

11. Are samples in the appropriate containers for indicated tests? \_\_\_\_\_ YES NO

12. Are sample labels present, in good condition and complete? \_\_\_\_\_ YES NO

13. Do the sample labels agree with custody papers?  YES  NO

14. Was sufficient amount of sample sent for tests requested? \_\_\_\_\_ YES NO

15. Are the samples appropriately preserved? \_\_\_\_\_ YES NO  N/A

16. Did you check preservatives for all bottles for each sample? \_\_\_\_\_ YES NO  N/A

17. Did you document your preservative check? (pH strip lot# \_\_\_\_\_ ) YES NO  N/A

18. Did you change the hold time in LIMS for unpreserved VOAs? \_\_\_\_\_ YES NO  N/A

19. Did you change the hold time in LIMS for preserved terracores? \_\_\_\_\_ YES NO  N/A

20. Are bubbles > 6mm absent in VOA samples? \_\_\_\_\_ YES  NO  N/A

21. Was the client contacted concerning this sample delivery? \_\_\_\_\_ YES NO

If YES, Who was called? \_\_\_\_\_ By \_\_\_\_\_ Date: \_\_\_\_\_

COMMENTS 13.) COC says there are 2 500ml Ambers for sample 1; however, 1 250ml Amber is labeled for "influent" (sample 2)

20.) Bubbles > 6mm present in 1/6 VOAs for sample 1.

Detections Summary for 279357

Results for any subcontracted analyses are not included in this summary.

Client : SOMA Environmental Engineering Inc.  
 Project : 2556  
 Location : 15101 Freedom Ave, San Leandro

Client Sample ID : EFFLUENT                      Laboratory Sample ID :                      279357-001

No Detections

Client Sample ID : INFLUENT                      Laboratory Sample ID :                      279357-002

Analyte	Result	Flags	RL	Units	Basis	IDF	Method	Prep Method
Gasoline C7-C12	280		50	ug/L	As Recd	1.000	EPA 8015B	EPA 5030B
Benzene	0.60	C	0.50	ug/L	As Recd	1.000	EPA 8021B	EPA 5030B
Toluene	3.0		0.50	ug/L	As Recd	1.000	EPA 8021B	EPA 5030B
Ethylbenzene	2.4		0.50	ug/L	As Recd	1.000	EPA 8021B	EPA 5030B
m,p-Xylenes	10		0.50	ug/L	As Recd	1.000	EPA 8021B	EPA 5030B
o-Xylene	2.7		0.50	ug/L	As Recd	1.000	EPA 8021B	EPA 5030B

C = Presence confirmed, but RPD between columns exceeds 40%

**Curtis & Tompkins Laboratories Analytical Report**

Lab #: 279357	Location: 15101 Freedom Ave, San Leandro
Client: SOMA Environmental Engineering Inc.	Prep: EPA 5030B
Project#: 2556	
Matrix: Water	Batch#: 238074
Units: ug/L	Sampled: 08/04/16
Diln Fac: 1.000	Received: 08/04/16

Field ID: EFFLUENT                      Lab ID: 279357-001  
 Type: SAMPLE                              Analyzed: 08/16/16

Analyte	Result	RL	Analysis
Gasoline C7-C12	ND	50	EPA 8015B
Benzene	ND	0.50	EPA 8021B
Toluene	ND	0.50	EPA 8021B
Ethylbenzene	ND	0.50	EPA 8021B
m,p-Xylenes	ND	0.50	EPA 8021B
o-Xylene	ND	0.50	EPA 8021B

Surrogate	%REC	Limits	Analysis
Bromofluorobenzene (FID)	114	80-132	EPA 8015B
Bromofluorobenzene (PID)	104	71-141	EPA 8021B

Field ID: INFLUENT                      Lab ID: 279357-002  
 Type: SAMPLE                              Analyzed: 08/16/16

Analyte	Result	RL	Analysis
Gasoline C7-C12	280	50	EPA 8015B
Benzene	0.60 C	0.50	EPA 8021B
Toluene	3.0	0.50	EPA 8021B
Ethylbenzene	2.4	0.50	EPA 8021B
m,p-Xylenes	10	0.50	EPA 8021B
o-Xylene	2.7	0.50	EPA 8021B

Surrogate	%REC	Limits	Analysis
Bromofluorobenzene (FID)	113	80-132	EPA 8015B
Bromofluorobenzene (PID)	106	71-141	EPA 8021B

Type: BLANK                                      Analyzed: 08/15/16  
 Lab ID: QC847402

Analyte	Result	RL	Analysis
Gasoline C7-C12	ND	50	EPA 8015B
Benzene	ND	0.50	EPA 8021B
Toluene	ND	0.50	EPA 8021B
Ethylbenzene	ND	0.50	EPA 8021B
m,p-Xylenes	ND	0.50	EPA 8021B
o-Xylene	ND	0.50	EPA 8021B

Surrogate	%REC	Limits	Analysis
Bromofluorobenzene (FID)	107	80-132	EPA 8015B
Bromofluorobenzene (PID)	100	71-141	EPA 8021B

C= Presence confirmed, but RPD between columns exceeds 40%  
 ND= Not Detected  
 RL= Reporting Limit



Batch QC Report

**Curtis & Tompkins Laboratories Analytical Report**

Lab #:	279357	Location:	15101 Freedom Ave, San Leandro
Client:	SOMA Environmental Engineering Inc.	Prep:	EPA 5030B
Project#:	2556	Analysis:	EPA 8015B
Field ID:	ZZZZZZZZZZ	Batch#:	238074
MSS Lab ID:	279662-002	Sampled:	08/12/16
Matrix:	Water	Received:	08/12/16
Units:	ug/L	Analyzed:	08/15/16
Diln Fac:	1.000		

Type: MS Lab ID: QC847403

Analyte	MSS Result	Spiked	Result	%REC	Limits
Gasoline C7-C12	197.1	2,000	2,149	98	76-120

Surrogate	%REC	Limits
Bromofluorobenzene (FID)	117	80-132

Type: MSD Lab ID: QC847404

Analyte	Spiked	Result	%REC	Limits	RPD	Lim
Gasoline C7-C12	2,000	2,004	90	76-120	7	20

Surrogate	%REC	Limits
Bromofluorobenzene (FID)	112	80-132

RPD= Relative Percent Difference

**Batch QC Report**
**Curtis & Tompkins Laboratories Analytical Report**

Lab #:	279357	Location:	15101 Freedom Ave, San Leandro
Client:	SOMA Environmental Engineering Inc.	Prep:	EPA 5030B
Project#:	2556	Analysis:	EPA 8021B
Matrix:	Water	Diln Fac:	1.000
Units:	ug/L	Batch#:	238074

Type: BS Analyzed: 08/15/16  
 Lab ID: QC847443

Analyte	Spiked	Result	%REC	Limits
Benzene	20.00	19.77	99	80-120
Toluene	20.00	17.54	88	80-120
Ethylbenzene	20.00	18.47	92	80-120
m,p-Xylenes	20.00	18.19	91	80-120
o-Xylene	20.00	18.39	92	80-120

Surrogate	%REC	Limits
Bromofluorobenzene (PID)	100	71-141

Type: BSD Analyzed: 08/16/16  
 Lab ID: QC847444

Analyte	Spiked	Result	%REC	Limits	RPD	Lim
Benzene	30.00	29.93	100	80-120	1	20
Toluene	30.00	26.53	88	80-120	1	20
Ethylbenzene	30.00	26.68	89	80-120	4	20
m,p-Xylenes	30.00	26.27	88	80-120	4	20
o-Xylene	30.00	26.83	89	80-120	3	20

Surrogate	%REC	Limits
Bromofluorobenzene (PID)	100	71-141

RPD= Relative Percent Difference

## Batch QC Report

**Curtis & Tompkins Laboratories Analytical Report**

Lab #:	279357	Location:	15101 Freedom Ave, San Leandro	
Client:	SOMA Environmental Engineering Inc.	Prep:	EPA 5030B	
Project#:	2556	Analysis:	EPA 8015B	
Type:	LCS	Diln Fac:	1.000	
Lab ID:	QC847545	Batch#:	238074	
Matrix:	Water	Analyzed:	08/16/16	
Units:	ug/L			

Analyte	Spiked	Result	%REC	Limits
Gasoline C7-C12	2,000	1,911	96	80-120

Surrogate	%REC	Limits
Bromofluorobenzene (FID)	118	80-132

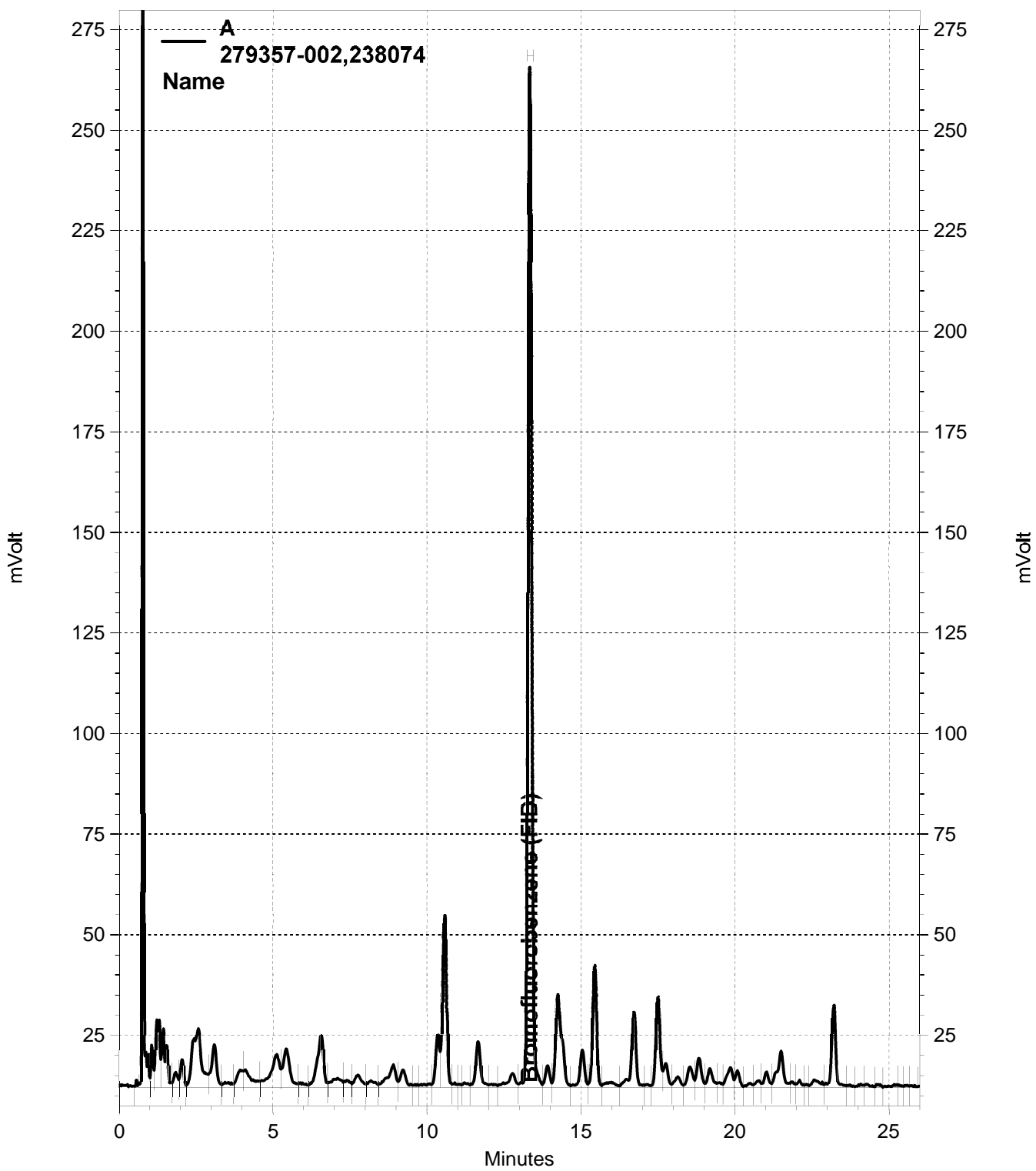

\\Lims\gdrive\ezchrom\Projects\GC05\Data\228-035, A

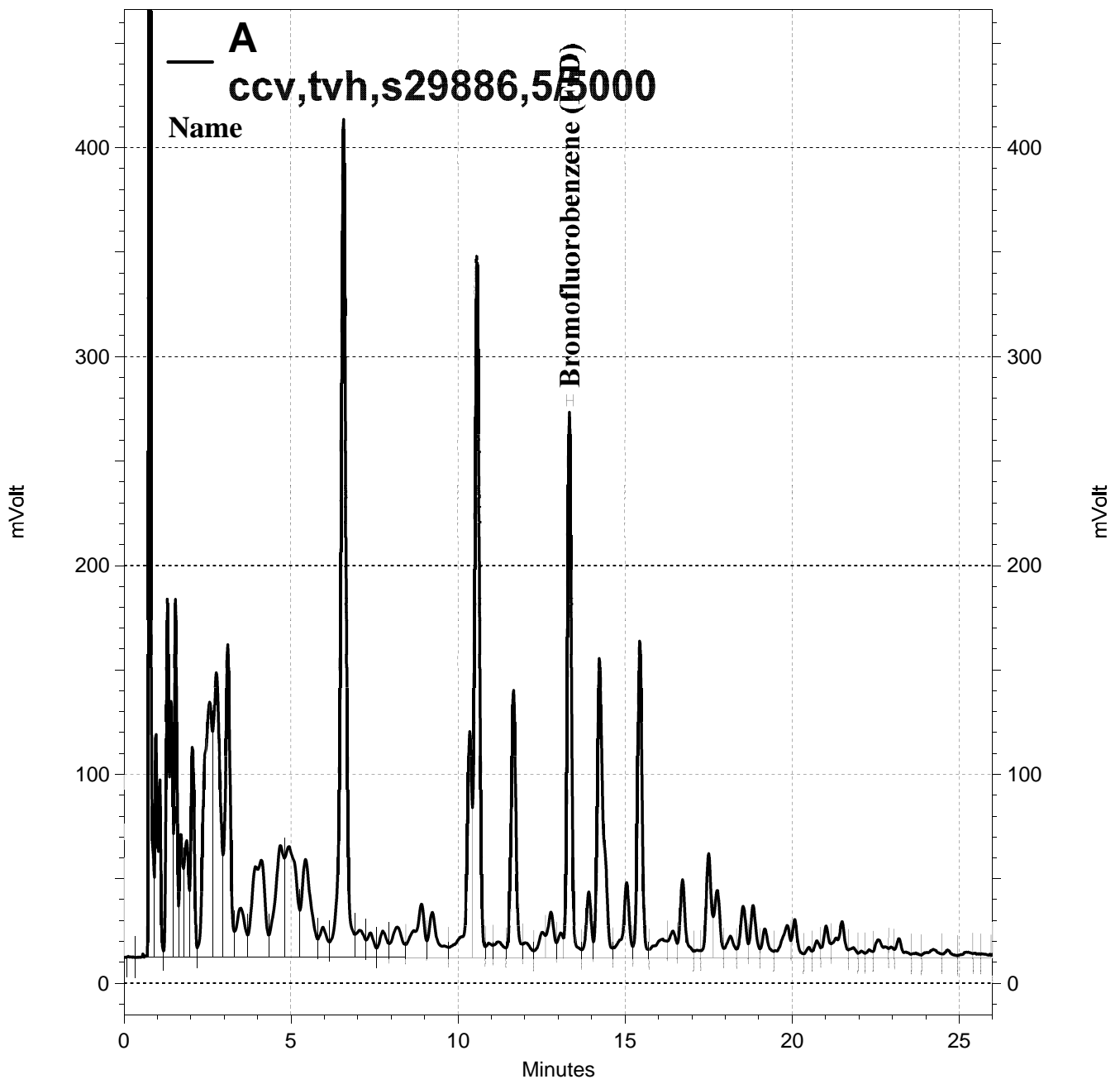

— \\Lims\gdrive\ezchrom\Projects\GC05\Data\228-017, A

Total Extractable Hydrocarbons			
Lab #:	279357	Location:	15101 Freedom Ave, San Leandro
Client:	SOMA Environmental Engineering Inc.	Prep:	EPA 3520C
Project#:	2556	Analysis:	EPA 8015B
Field ID:	EFFLUENT	Batch#:	237806
Matrix:	Water	Sampled:	08/04/16
Units:	ug/L	Received:	08/04/16
Diln Fac:	1.000	Prepared:	08/08/16

Type: SAMPLE Analyzed: 08/10/16  
 Lab ID: 279357-001

Analyte	Result	RL
Diesel C10-C24	ND	50
Motor Oil C24-C36	ND	300

Surrogate	%REC	Limits
o-Terphenyl	155 *	67-136

Type: BLANK Analyzed: 08/09/16  
 Lab ID: QC846316

Analyte	Result	RL
Diesel C10-C24	ND	50
Motor Oil C24-C36	ND	300

Surrogate	%REC	Limits
o-Terphenyl	98	67-136

\*= Value outside of QC limits; see narrative  
 ND= Not Detected  
 RL= Reporting Limit

## Batch QC Report

Total Extractable Hydrocarbons				
Lab #:	279357	Location:	15101 Freedom Ave, San Leandro	
Client:	SOMA Environmental Engineering Inc.	Prep:	EPA 3520C	
Project#:	2556	Analysis:	EPA 8015B	
Type:	LCS	Diln Fac:	1.000	
Lab ID:	QC846317	Batch#:	237806	
Matrix:	Water	Prepared:	08/08/16	
Units:	ug/L	Analyzed:	08/10/16	

Cleanup Method: EPA 3630C

Analyte	Spiked	Result	%REC	Limits
Diesel C10-C24	2,500	2,441	98	60-121

Surrogate	%REC	Limits
o-Terphenyl	120	67-136

## Batch QC Report

Total Extractable Hydrocarbons			
Lab #:	279357	Location:	15101 Freedom Ave, San Leandro
Client:	SOMA Environmental Engineering Inc.	Prep:	EPA 3520C
Project#:	2556	Analysis:	EPA 8015B
Field ID:	ZZZZZZZZZZ	Batch#:	237806
MSS Lab ID:	279359-010	Sampled:	08/04/16
Matrix:	Water	Received:	08/04/16
Units:	ug/L	Prepared:	08/08/16
Diln Fac:	1.000	Analyzed:	08/10/16

Type: MS Lab ID: QC846318

Analyte	MSS Result	Spiked	Result	%REC	Limits
Diesel C10-C24	19.64	2,500	2,391	95	55-122

Surrogate	%REC	Limits
o-Terphenyl	114	67-136

Type: MSD Lab ID: QC846319

Analyte	Spiked	Result	%REC	Limits	RPD	Lim
Diesel C10-C24	2,500	2,236	89	55-122	7	53

Surrogate	%REC	Limits
o-Terphenyl	112	67-136

RPD= Relative Percent Difference





Curtis & Tompkins, Ltd., Analytical Laboratories, Since 1878

2323 Fifth Street, Berkeley, CA 94710, Phone (510) 486-0900

**Laboratory Job Number 281308  
ANALYTICAL REPORT**

SOMA Environmental Engineering Inc.  
6620 Owens Dr.  
Pleasanton, CA 94588

Project : 2553  
Location : 15101 Freedom Ave. San Leandro  
Level : II

Sample ID  
EFFLUENT

Lab ID  
281308-001

This data package has been reviewed for technical correctness and completeness. Release of this data has been authorized by the Laboratory Manager or the Manager's designee, as verified by the following signature. The results contained in this report meet all requirements of NELAC and pertain only to those samples which were submitted for analysis. This report may be reproduced only in its entirety.

Signature: \_\_\_\_\_

Tracy Babjar  
Project Manager  
tracy.babjar@ctberk.com  
(510) 204-2226

Date: 10/03/2016

CA ELAP# 2896, NELAP# 4044-001

### CASE NARRATIVE

Laboratory number: 281308  
Client: SOMA Environmental Engineering Inc.  
Project: 2553  
Location: 15101 Freedom Ave. San Leandro  
Request Date: 09/22/16  
Samples Received: 09/22/16

This data package contains sample and QC results for one water sample, requested for the above referenced project on 09/22/16. The sample was received intact.

**TPH-Purgeables and/or BTXE by GC (EPA 8015B and EPA 8021B):**

No analytical problems were encountered.

**TPH-Extractables by GC (EPA 8015B):**

No analytical problems were encountered.



COOLER RECEIPT CHECKLIST



Curtis & Tompkins, Ltd.

Login # 281308 Date Received 9/22/06 Number of coolers 1
Client SOMA Project 2553

Date Opened 9/22 By (print) DTN (sign) [signature]
Date Logged in [down arrow] By (print) [down arrow] (sign) [signature]
Date Labeled [down arrow] By (print) [down arrow] (sign) [signature]

1. Did cooler come with a shipping slip (airbill, etc) YES NO
Shipping info

2A. Were custody seals present? .... YES (circle) on cooler on samples NO
How many Name Date

2B. Were custody seals intact upon arrival? YES NO N/A

3. Were custody papers dry and intact when received? YES NO

4. Were custody papers filled out properly (ink, signed, etc)? YES NO

5. Is the project identifiable from custody papers? (If so fill out top of form) YES NO

6. Indicate the packing in cooler: (if other, describe)
Bubble Wrap Foam blocks Bags None
Cloth material Cardboard Styrofoam Paper towels

7. Temperature documentation: \* Notify PM if temperature exceeds 6°C

Type of ice used: Wet Blue/Gel None Temp(°C) 1.5

Temperature blank(s) included? Thermometer# IR Gun# A

Samples received on ice directly from the field. Cooling process had begun

8. Were Method 5035 sampling containers present? YES NO

If YES, what time were they transferred to freezer?

9. Did all bottles arrive unbroken/unopened? YES NO

10. Are there any missing / extra samples? YES NO

11. Are samples in the appropriate containers for indicated tests? YES NO

12. Are sample labels present, in good condition and complete? YES NO

13. Do the sample labels agree with custody papers? YES NO

14. Was sufficient amount of sample sent for tests requested? YES NO

15. Are the samples appropriately preserved? YES NO N/A

16. Did you check preservatives for all bottles for each sample? YES NO N/A

17. Did you document your preservative check? (pH strip lot# ) YES NO N/A

18. Did you change the hold time in LIMS for unpreserved VOAs? YES NO N/A

19. Did you change the hold time in LIMS for preserved terracores? YES NO N/A

20. Are bubbles > 6mm absent in VOA samples? YES NO N/A

21. Was the client contacted concerning this sample delivery? YES NO

If YES, Who was called? By Date:

COMMENTS

Multiple horizontal lines for handwritten comments.

Detections Summary for 281308

Results for any subcontracted analyses are not included in this summary.

Client : SOMA Environmental Engineering Inc.  
 Project : 2553  
 Location : 15101 Freedom Ave. San Leandro

Client Sample ID : EFFLUENT                      Laboratory Sample ID :                      281308-001

Analyte	Result	Flags	RL	Units	Basis	IDF	Method	Prep Method
Diesel C10-C24	61	Y	50	ug/L	As Recd	1.000	EPA 8015B	EPA 3520C

Y = Sample exhibits chromatographic pattern which does not resemble standard



## Batch QC Report

**Curtis & Tompkins Laboratories Analytical Report**

Lab #:	281308	Location:	15101 Freedom Ave. San Leandro	
Client:	SOMA Environmental Engineering Inc.	Prep:	EPA 5030B	
Project#:	2553	Analysis:	EPA 8015B	
Type:	LCS	Diln Fac:	1.000	
Lab ID:	QC852883	Batch#:	239443	
Matrix:	Water	Analyzed:	09/23/16	
Units:	ug/L			

Analyte	Spiked	Result	%REC	Limits
Gasoline C7-C12	1,000	1,080	108	80-120

Surrogate	%REC	Limits
Bromofluorobenzene (FID)	103	80-132

Batch QC Report

**Curtis & Tompkins Laboratories Analytical Report**

Lab #:	281308	Location:	15101 Freedom Ave. San Leandro
Client:	SOMA Environmental Engineering Inc.	Prep:	EPA 5030B
Project#:	2553	Analysis:	EPA 8015B
Field ID:	ZZZZZZZZZZ	Batch#:	239443
MSS Lab ID:	281320-001	Sampled:	09/22/16
Matrix:	Water	Received:	09/22/16
Units:	ug/L	Analyzed:	09/23/16
Diln Fac:	1.000		

Type: MS Lab ID: QC852884

Analyte	MSS Result	Spiked	Result	%REC	Limits
Gasoline C7-C12	<12.82	2,000	2,011	101	76-120

Surrogate	%REC	Limits
Bromofluorobenzene (FID)	127	80-132

Type: MSD Lab ID: QC852885

Analyte	Spiked	Result	%REC	Limits	RPD	Lim
Gasoline C7-C12	2,000	2,007	100	76-120	0	20

Surrogate	%REC	Limits
Bromofluorobenzene (FID)	117	80-132

RPD= Relative Percent Difference



**Batch QC Report**
**Curtis & Tompkins Laboratories Analytical Report**

Lab #:	281308	Location:	15101 Freedom Ave. San Leandro
Client:	SOMA Environmental Engineering Inc.	Prep:	EPA 5030B
Project#:	2553	Analysis:	EPA 8021B
Matrix:	Water	Batch#:	239443
Units:	ug/L	Analyzed:	09/23/16
Diln Fac:	1.000		

Type: BS Lab ID: QC852914

Analyte	Spiked	Result	%REC	Limits
Benzene	10.00	11.19	112	80-120
Toluene	10.00	10.90	109	80-120
Ethylbenzene	10.00	11.16	112	80-120
m,p-Xylenes	10.00	10.77	108	80-120
o-Xylene	10.00	10.96	110	80-120

Surrogate	%REC	Limits
Bromofluorobenzene (PID)	98	71-141

Type: BSD Lab ID: QC852915

Analyte	Spiked	Result	%REC	Limits	RPD	Lim
Benzene	10.00	11.21	112	80-120	0	20
Toluene	10.00	11.01	110	80-120	1	20
Ethylbenzene	10.00	10.88	109	80-120	3	20
m,p-Xylenes	10.00	10.91	109	80-120	1	20
o-Xylene	10.00	10.84	108	80-120	1	20

Surrogate	%REC	Limits
Bromofluorobenzene (PID)	95	71-141

RPD= Relative Percent Difference

Total Extractable Hydrocarbons			
Lab #:	281308	Location:	15101 Freedom Ave. San Leandro
Client:	SOMA Environmental Engineering Inc.	Prep:	EPA 3520C
Project#:	2553	Analysis:	EPA 8015B
Field ID:	EFFLUENT	Batch#:	239409
Matrix:	Water	Sampled:	09/22/16
Units:	ug/L	Received:	09/22/16
Diln Fac:	1.000		

Type: SAMPLE Prepared: 09/23/16  
 Lab ID: 281308-001 Analyzed: 09/26/16

Analyte	Result	RL
Diesel C10-C24	61 Y	50
Motor Oil C24-C36	ND	300

Surrogate	%REC	Limits
o-Terphenyl	109	67-136

Type: BLANK Prepared: 09/22/16  
 Lab ID: QC852753 Analyzed: 09/23/16

Analyte	Result	RL
Diesel C10-C24	ND	50
Motor Oil C24-C36	ND	300

Surrogate	%REC	Limits
o-Terphenyl	132	67-136

Y= Sample exhibits chromatographic pattern which does not resemble standard  
 ND= Not Detected  
 RL= Reporting Limit

## Batch QC Report

Total Extractable Hydrocarbons			
Lab #:	281308	Location:	15101 Freedom Ave. San Leandro
Client:	SOMA Environmental Engineering Inc.	Prep:	EPA 3520C
Project#:	2553	Analysis:	EPA 8015B
Matrix:	Water	Batch#:	239409
Units:	ug/L	Prepared:	09/22/16
Diln Fac:	1.000	Analyzed:	09/23/16

Type: BS Cleanup Method: EPA 3630C  
 Lab ID: QC852754

Analyte	Spiked	Result	%REC	Limits
Diesel C10-C24	2,500	1,822	73	60-121

Surrogate	%REC	Limits
o-Terphenyl	79	67-136

Type: BSD Cleanup Method: EPA 3630C  
 Lab ID: QC852755

Analyte	Spiked	Result	%REC	Limits	RPD	Lim
Diesel C10-C24	2,500	1,997	80	60-121	9	32

  

Surrogate	%REC	Limits
o-Terphenyl	85	67-136

RPD= Relative Percent Difference

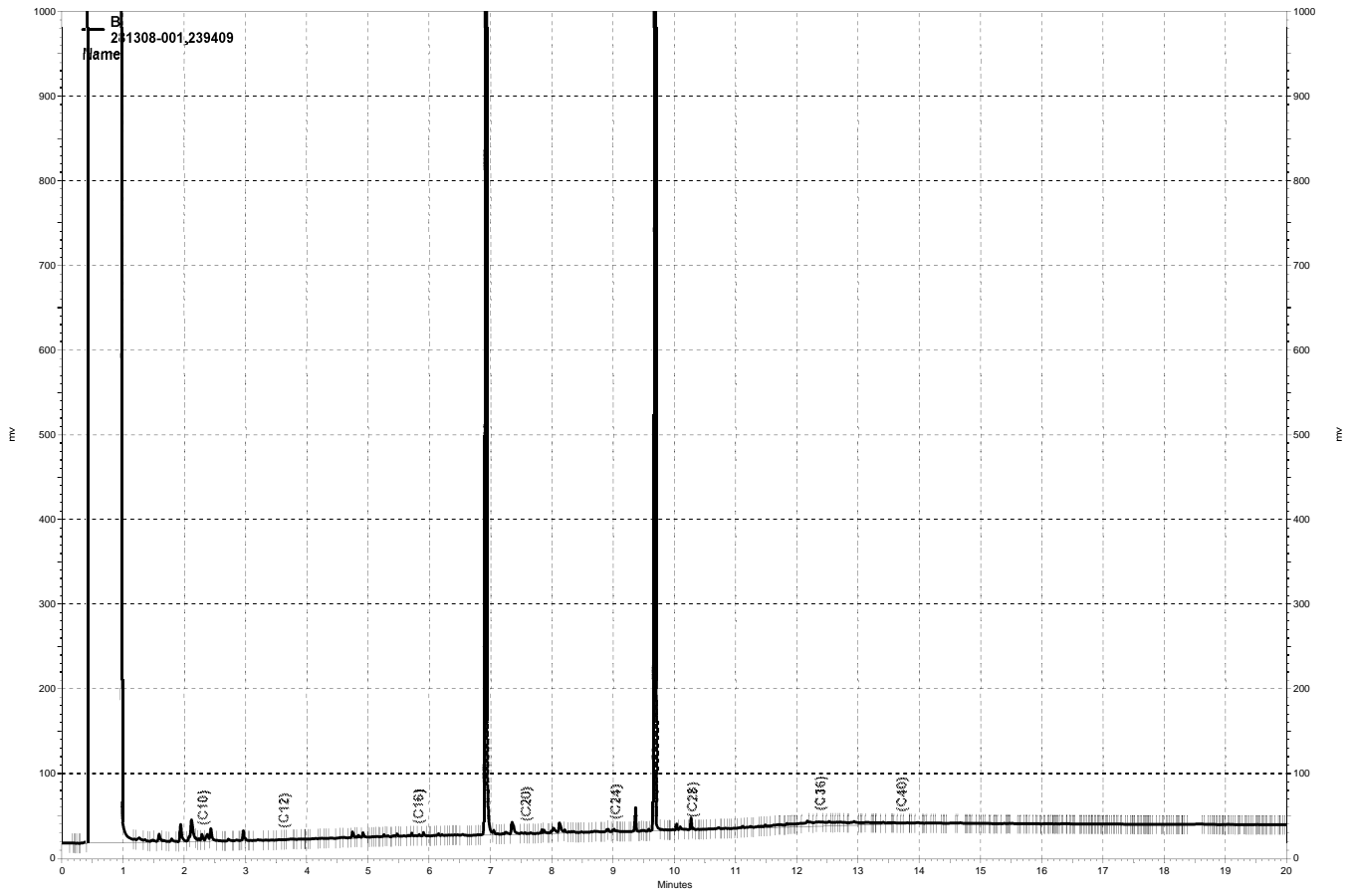

\\kraken\gdrive\ezchrom\Projects\GC15B\Data\270B033, B

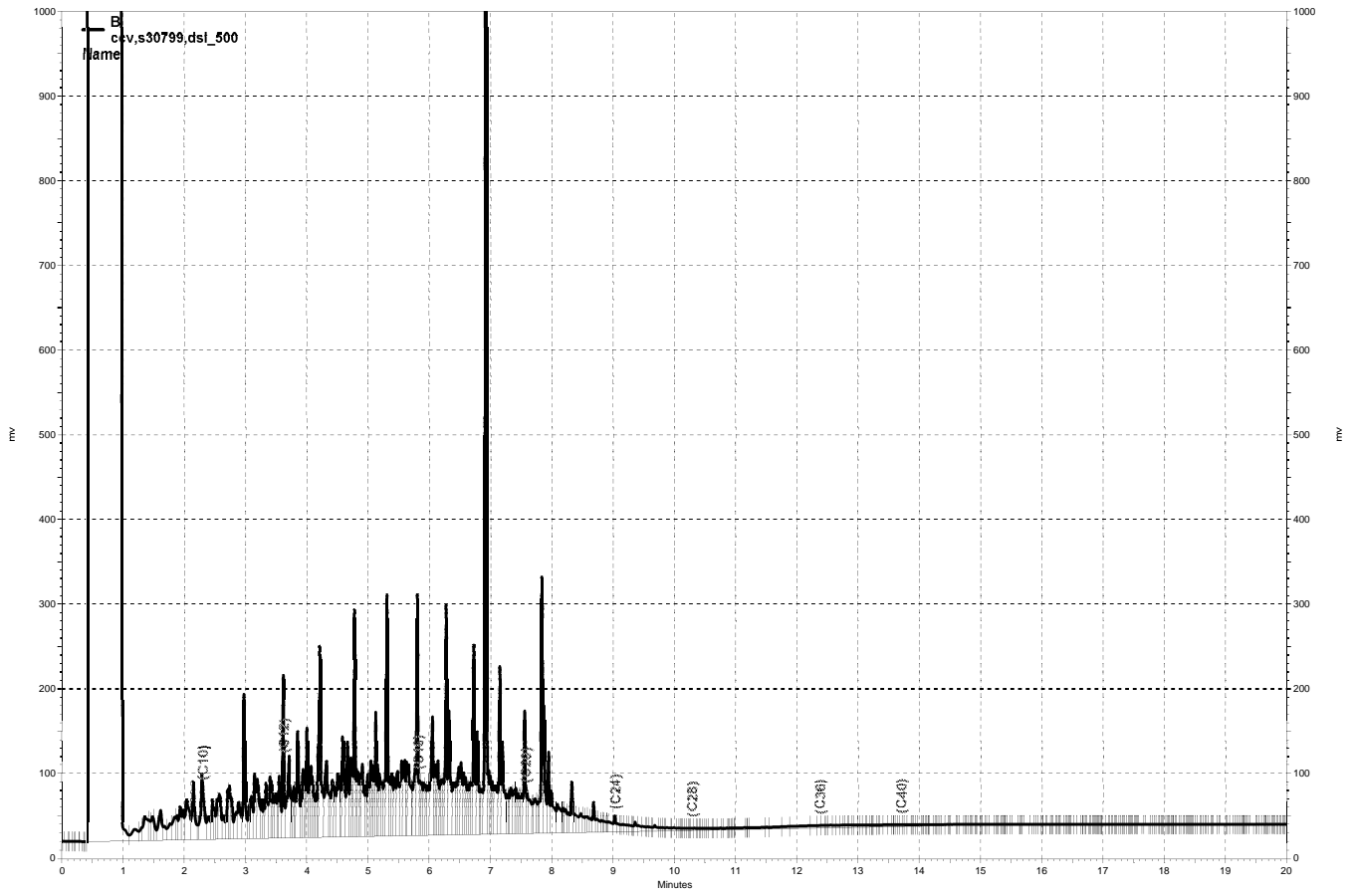

— \\kraken\gdrive\ezchrom\Projects\GC15B\Data\270B026, B

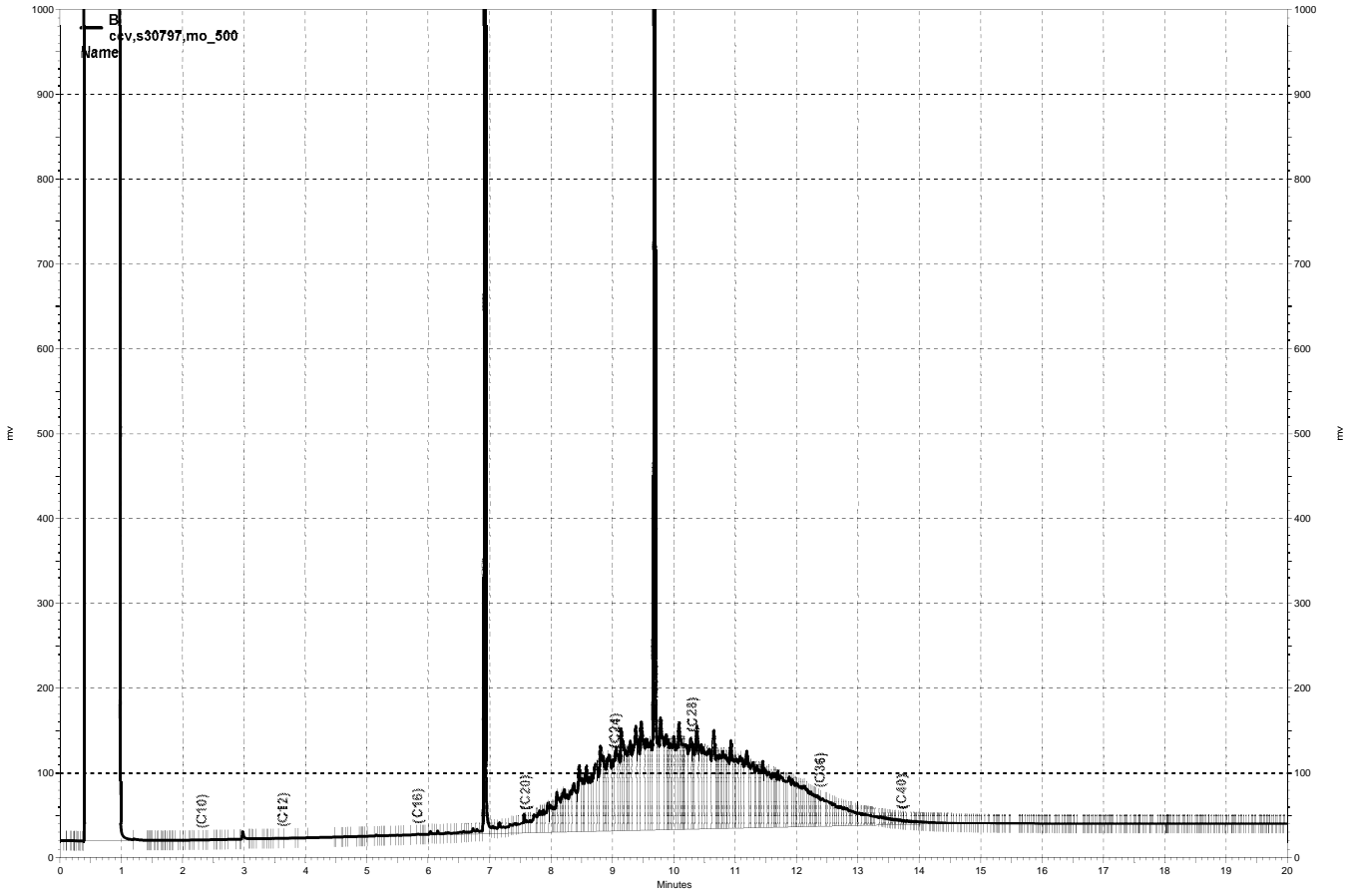

— \\kraken\gdrive\ezchrom\Projects\GC15B\Data\270B025, B

# Appendix E

## MPE Event Field Data Sheets and Encroachment Permit



**ENVIRONMENTAL ENGINEERING, INC.**  
 5620 Owens Drive, Suite A • Pleasanton, CA 94588  
 TEL (925)734-6400 • FAX (925)734-6401

SITE: 15101 Freedom Ave, San Leandro  
 ADDRESS: 15101 Freedom Ave, San Leandro  
 PROJECT #: 2556

**MTS OPERATIONAL DATA**

DATE	TIME	OXIDIZER TEMPERATURE (F)	PUMP/AIR TEMPERATURE (F)	STINGER VACUUM (IN-Hg)	PUMP VACUUM (IN-Hg)	TOTAL FLOW (SCFM)	DILUTION FLOW (SCFM)	HOURS OF OPERATION (HOURS)	INFLUENT CONCENTRATION (PPMV)	WATER TOTALIZER
8/2/2016	1030	Start Extraction @MW-10R								
8/2/2016	1100	1400	190	22.4	26.3	49	12	37	187	0
	1200	1401	192	22.4	26.3	49	12	37	182	
	1300	1400	195	22.5	26.3	49	12	37	180	
	1400	1402	196	22.5	26.4	47	12	35	177	
	1500	1400	197	22.5	26.4	47	12	35	169	
	1600	1400	198	22.5	26.4	47	12	35	161	
	1700	1400	198	22.5	26.4	47	12	35	153	
	1745	Shut down								
8/3/2016	645	Restart								
	700	1401	190	22.5	26.4	47	12	35	142	
	800	1400	193	22.5	26.4	47	12	35	137	
	900	1400	194	22.5	26.4	47	12	35	130	
	1000	1400	195	22.5	26.4	47	12	35	122	
	1100	1402	195	22.6	26.5	46	12	34	117	
	1200	1400	196	22.6	26.5	46	12	34	112	
	1300	1401	196	22.6	26.5	46	12	34	107	
	1400	1400	197	22.6	26.5	46	12	34	102	
	1500	1402	197	22.6	26.5	46	12	34	95	
	1600	1400	197	22.5	26.5	46	12	34	87	





**ENVIRONMENTAL ENGINEERING, INC.**  
 5620 Owens Drive, Suite A • Pleasanton, CA 94588  
 TEL (925)734-6400 • FAX (925)734-6401

SITE: 15101 Freedom Ave, San Leandro  
 ADDRESS: 15101 Freedom Ave, San Leandro  
 PROJECT #: 2556

**MTS OPERATIONAL DATA**

DATE	TIME	OXIDIZER TEMPERATURE (F)	PUMP/AIR TEMPERATURE (F)	STINGER VACUUM (IN-Hg)	PUMP VACUUM (IN-Hg)	TOTAL FLOW (SCFM)	DILUTION FLOW (SCFM)	HOURS OF OPERATION (HOURS)	INFLUENT CONCENTRATION (PPMV)	WATER TOTALIZER
	1700	1401	198	22.6	26.5	46	12	34	82	
		Shut down								
8/4/2016	645	Restart								
	700	1401	191	21.8	26.2	50	12	38	87	415
	800	1400	192	21.8	26.2	50	12	38	82	
	900	1400	194	21.8	26.2	50	12	38	77	
	1000	1400	194	21.7	26.1	52	12	40	73	
	1100	1402	195	21.7	26.1	52	12	40	70	
	1200	1400	196	21.7	26.1	52	12	40	68	
	1300	1400	197	21.9	26.1	52	12	40	64	
	1400	1402	197	21.9	26.1	52	12	40	61	
	1500	1400	198	21.9	26.1	52	12	40	57	
	1600	1401	198	21.8	26.2	50	12	38	52	
	1700	1400	197	21.8	26.2	50	12	38	55	
		Shut down								
8/5/2016	645	Restart								
	700	1402	191	22.4	25.8	57	12	45	67	
	800	1400	193	22.4	25.8	57	12	45	54	
	900	1400	194	22.3	25.8	57	12	45	50	
	1000	1400	195	22.3	25.9	55	12	43	48	



ENVIRONMENTAL ENGINEERING, INC.  
5620 Owens Drive, Suite A • Pleasanton, CA 94588  
TEL (925)734-6400 • FAX (925)734-6401

SITE: 15101 Freedom Ave, San Leandro  
ADDRESS: 15101 Freedom Ave, San Leandro  
PROJECT #: 2556

MTS OPERATIONAL DATA

DATE	TIME	OXIDIZER TEMPERATURE (F)	PUMP/AIR TEMPERATURE (F)	STINGER VACUUM (IN-Hg)	PUMP VACUUM (IN-Hg)	TOTAL FLOW (SCFM)	DILUTION FLOW (SCFM)	HOURS OF OPERATION (HOURS)	INFLUENT CONCENTRATION (PPMV)	WATER TOTALIZER
	1100	1401	197	22.3	25.9	55	12	43	45	
	1200	1400	197	22.5	25.9	55	12	43	43	
	1300	1400	198	22.5	25.9	55	12	43	49	
	1400	1401	198	22.5	25.9	55	12	43	40	
	1500	1400	198	22.5	25.8	57	12	45	37	711
		End Extraction, system shut down								



Public Works Agency  
Alameda County

# Roadway Encroachment Permit

Work Order # 80001

Permit # R16LD16207

Permit Issuance Date 7/29/2016

Permit Expiration Date 7/29/2017

**Name & Address of Property Owner:**

Mohammad Pazdel  
1770 Pistacia Court  
Fairfield, CA 94533

**Phone Number:**

**Job Site Address:**

15101 Freedom Ave  
San Leandro, CA 94578

**Name & Address of Applicant/Contractor:**

Soma Environmental Engineering, Inc., Ruchi  
Mathur  
6620 Owens Drive, A  
Pleasanton, CA 94588

**Phone Number:** 925-734-6400 Fax: 925-734-6401

**The permittee intends to perform the following work scope:**

Applicant is permitted to park a truck (Mobile Treatment System) in the median to conduct remediation the monitoring well located in the center divider of Fairmont Dr.  
Truck/tank and hoses must be contained within the median at all times and traffic will not be impacted at any time.

**All work and/or access shall be performed in accordance with the attached General Provisions and the following Special Provisions:**

[Empty box for Special Provisions]

Bond Type:	Bond Value:	Deposit:	Permit Fee:
	\$0.00	\$0.00	\$549.00

By:  Alameda County	Work Completed (Date): _____ Inspector: _____
--	--

I agree to comply with all of the terms and conditions of this Permit, including any Special Provisions specified above.

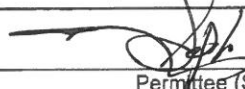
 Permittee (Signature)	7/29/16 Date
--	-----------------

Call (510) 670 - 5450, at least 24hr. in advance of starting work, to schedule an inspection.  
If the work is within 500' of a traffic signal or in proximity to a streetlight pole, call (510) 670 - 5537 at least 48 hr. in advance to verify the location of County conduits and detector loops.

**THIS PERMIT IS INCOMPLETE WITHOUT THE ATTACHED GENERAL PROVISIONS**

# Appendix F

## Laboratory Reports and Chain of Custody Forms for the MPE Event



Curtis & Tompkins, Ltd., Analytical Laboratories, Since 1878

2323 Fifth Street, Berkeley, CA 94710, Phone (510) 486-0900

**Laboratory Job Number 279244**  
**ANALYTICAL REPORT**

SOMA Environmental Engineering Inc.  
6620 Owens Dr.  
Pleasanton, CA 94588

Project : 2556  
Location : 15101 Freedom Ave, San Leandro  
Level : II

Sample ID

EFF MPE  
INF MPE

Lab ID

279244-001  
279244-002

This data package has been reviewed for technical correctness and completeness. Release of this data has been authorized by the Laboratory Manager or the Manager's designee, as verified by the following signature. The results contained in this report meet all requirements of NELAC and pertain only to those samples which were submitted for analysis. This report may be reproduced only in its entirety.

Signature: \_\_\_\_\_

Mike Dahlquist  
Project Manager  
mike.dahlquist@ctberk.com

Date: 08/05/2016

CA ELAP# 2896, NELAP# 4044-001

### CASE NARRATIVE

Laboratory number: 279244  
Client: SOMA Environmental Engineering Inc.  
Project: 2556  
Location: 15101 Freedom Ave, San Leandro  
Request Date: 08/02/16  
Samples Received: 08/02/16

This data package contains sample and QC results for two air samples, requested for the above referenced project on 08/02/16. The samples were received cold and intact.

**Volatile Organics in Air by MS (EPA TO-15):**

No analytical problems were encountered.

**Volatile Organics in Air GC (EPA TO-3):**

No analytical problems were encountered.



COOLER RECEIPT CHECKLIST



Login # 279244 Date Received 8/2/16 Number of coolers 0
Client SOMA Project 15101 Freedom Ave.
Date Opened 8/2/16 By (print) [Signature] (sign) [Signature]
Date Logged in [Signature] By (print) [Signature] (sign) [Signature]

- 1. Did cooler come with a shipping slip (airbill, etc) YES NO
Shipping info
2A. Were custody seals present? ... YES (circle) on cooler on samples NO
How many Name Date
2B. Were custody seals intact upon arrival? YES NO N/A
3. Were custody papers dry and intact when received? YES NO
4. Were custody papers filled out properly (ink, signed, etc)? YES NO
5. Is the project identifiable from custody papers? (If so fill out top of form) YES NO
6. Indicate the packing in cooler: (if other, describe)
Bubble Wrap Foam blocks Bags None
Cloth material Cardboard Styrofoam Paper towels
7. Temperature documentation: \* Notify PM if temperature exceeds 6°C
Type of ice used: Wet Blue/Gel None Temp(°C)
Samples Received on ice & cold without a temperature blank
Samples received on ice directly from the field. Cooling process had begun
8. Were Method 5035 sampling containers present? YES NO
If YES, what time were they transferred to freezer?
9. Did all bottles arrive unbroken/unopened? YES NO
10. Are there any missing / extra samples? YES NO
11. Are samples in the appropriate containers for indicated tests? YES NO
12. Are sample labels present, in good condition and complete? YES NO
13. Do the sample labels agree with custody papers? YES NO
14. Was sufficient amount of sample sent for tests requested? YES NO
15. Are the samples appropriately preserved? YES NO N/A
16. Did you check preservatives for all bottles for each sample? YES NO N/A
17. Did you document your preservative check? YES NO N/A
18. Did you change the hold time in LIMS for unpreserved VOAs? YES NO N/A
19. Did you change the hold time in LIMS for preserved terracores? YES NO N/A
20. Are bubbles > 6mm absent in VOA samples? YES NO N/A
21. Was the client contacted concerning this sample delivery? YES NO
If YES, Who was called? By Date:

COMMENTS



## Detections Summary for 279244

Results for any subcontracted analyses are not included in this summary.

Client : SOMA Environmental Engineering Inc.  
 Project : 2556  
 Location : 15101 Freedom Ave, San Leandro

Client Sample ID : EFF MPE                      Laboratory Sample ID :                      279244-001

Analyte	Result	Flags	RL	MDL	Units	Basis	IDF	Method	Prep Method
Benzene	5.8		0.50		ppbv	As Recd	1.000	EPA TO-15	METHOD
Toluene	1.2		0.50		ppbv	As Recd	1.000	EPA TO-15	METHOD
m,p-Xylenes	0.52		0.50		ppbv	As Recd	1.000	EPA TO-15	METHOD
Gasoline Range Organics C6-C12	150		50	5.6	ppbv	As Recd	1.000	EPA TO-3	METHOD

Client Sample ID : INF MPE                      Laboratory Sample ID :                      279244-002

Analyte	Result	Flags	RL	MDL	Units	Basis	IDF	Method	Prep Method
Toluene	22		6.0		ppbv	As Recd	12.00	EPA TO-15	METHOD
Ethylbenzene	330		6.0		ppbv	As Recd	12.00	EPA TO-15	METHOD
m,p-Xylenes	540		6.0		ppbv	As Recd	12.00	EPA TO-15	METHOD
o-Xylene	110		6.0		ppbv	As Recd	12.00	EPA TO-15	METHOD
Gasoline Range Organics C6-C12	3,300		50	5.6	ppbv	As Recd	1.000	EPA TO-3	METHOD

**Curtis & Tompkins Laboratories Analytical Report**

Lab #: 279244	Location: 15101 Freedom Ave, San Leandro
Client: SOMA Environmental Engineering Inc.	Prep: METHOD
Project#: 2556	Analysis: EPA TO-15
Matrix: Air	Sampled: 08/02/16
Units (V): ppbv	Received: 08/02/16
Units (M): ug/m3	

Field ID: EFF MPE Diln Fac: 1.000  
 Type: SAMPLE Batch#: 237691  
 Lab ID: 279244-001 Analyzed: 08/04/16

Analyte	Result (V)	RL	Result (M)	RL
MTBE	ND	0.50	ND	1.8
Benzene	5.8	0.50	18	1.6
Toluene	1.2	0.50	4.5	1.9
Ethylbenzene	ND	0.50	ND	2.2
m,p-Xylenes	0.52	0.50	2.3	2.2
o-Xylene	ND	0.50	ND	2.2

Surrogate	%REC	Limits
Bromofluorobenzene	109	80-121

Field ID: INF MPE Diln Fac: 12.00  
 Type: SAMPLE Batch#: 237599  
 Lab ID: 279244-002 Analyzed: 08/03/16

Analyte	Result (V)	RL	Result (M)	RL
MTBE	ND	6.0	ND	22
Benzene	ND	6.0	ND	19
Toluene	22	6.0	82	23
Ethylbenzene	330	6.0	1,400	26
m,p-Xylenes	540	6.0	2,400	26
o-Xylene	110	6.0	460	26

Surrogate	%REC	Limits
Bromofluorobenzene	92	80-121

ND= Not Detected

RL= Reporting Limit

Result M= Result in mass units

Result V= Result in volume units



**Batch QC Report**
**Curtis & Tompkins Laboratories Analytical Report**

Lab #:	279244	Location:	15101 Freedom Ave, San Leandro
Client:	SOMA Environmental Engineering Inc.	Prep:	METHOD
Project#:	2556	Analysis:	EPA TO-15
Matrix:	Air	Batch#:	237599
Units (V):	ppbv	Analyzed:	08/02/16
Diln Fac:	1.000		

Type: BS Lab ID: QC845481

Analyte	Spiked	Result (V)	%REC	Limits
MTBE	5.000	5.751	115	70-130
Benzene	5.000	5.151	103	70-130
Toluene	5.000	5.775	116	70-130
Ethylbenzene	5.000	5.760	115	70-130
m,p-Xylenes	10.00	12.48	125	70-130
o-Xylene	5.000	6.363	127	70-130

Surrogate	%REC	Limits
Bromofluorobenzene	98	70-130

Type: BSD Lab ID: QC845482

Analyte	Spiked	Result (V)	%REC	Limits	RPD	Lim
MTBE	5.000	5.917	118	70-130	3	25
Benzene	5.000	5.064	101	70-130	2	25
Toluene	5.000	5.559	111	70-130	4	25
Ethylbenzene	5.000	5.712	114	70-130	1	25
m,p-Xylenes	10.00	12.19	122	70-130	2	25
o-Xylene	5.000	6.191	124	70-130	3	25

Surrogate	%REC	Limits
Bromofluorobenzene	96	70-130

RPD= Relative Percent Difference  
 Result V= Result in volume units

## Batch QC Report

**Curtis & Tompkins Laboratories Analytical Report**

Lab #:	279244	Location:	15101 Freedom Ave, San Leandro
Client:	SOMA Environmental Engineering Inc.	Prep:	METHOD
Project#:	2556	Analysis:	EPA TO-15
Matrix:	Air	Batch#:	237691
Units (V):	ppbv	Analyzed:	08/04/16
Diln Fac:	1.000		

Type: BS Lab ID: QC845859

Analyte	Spiked	Result (V)	%REC	Limits
MTBE	10.00	10.15	101	70-130
Benzene	10.00	8.601	86	70-130
Toluene	10.00	8.778	88	70-130
Ethylbenzene	10.00	8.264	83	70-130
m,p-Xylenes	20.00	17.04	85	70-130
o-Xylene	10.00	8.662	87	70-130

Surrogate	%REC	Limits
Bromofluorobenzene	98	70-130

Type: BSD Lab ID: QC845860

Analyte	Spiked	Result (V)	%REC	Limits	RPD	Lim
MTBE	10.00	9.912	99	70-130	2	25
Benzene	10.00	8.800	88	70-130	2	25
Toluene	10.00	9.004	90	70-130	3	25
Ethylbenzene	10.00	8.512	85	70-130	3	25
m,p-Xylenes	20.00	17.20	86	70-130	1	25
o-Xylene	10.00	8.548	85	70-130	1	25

Surrogate	%REC	Limits
Bromofluorobenzene	99	70-130

RPD= Relative Percent Difference

Result V= Result in volume units

**Curtis & Tompkins Laboratories Analytical Report**

Lab #:	279244	Location:	15101 Freedom Ave, San Leandro
Client:	SOMA Environmental Engineering Inc.	Prep:	METHOD
Project#:	2556	Analysis:	EPA TO-3
Analyte:	Gasoline Range Organics C6-C12	Batch#:	237608
Matrix:	Air	Sampled:	08/02/16
Units:	ppbv	Received:	08/02/16
Diln Fac:	1.000	Analyzed:	08/02/16

Field ID	Type	Lab ID	Result	RL	MDL
EFF MPE	SAMPLE	279244-001	150	50	5.6
INF MPE	SAMPLE	279244-002	3,300	50	5.6
	BLANK	QC845521	ND	50	5.6

ND= Not Detected  
 RL= Reporting Limit  
 MDL= Method Detection Limit

## Batch QC Report

**Curtis & Tompkins Laboratories Analytical Report**

Lab #:	279244	Location:	15101 Freedom Ave, San Leandro
Client:	SOMA Environmental Engineering Inc.	Prep:	METHOD
Project#:	2556	Analysis:	EPA TO-3
Analyte:	Gasoline Range Organics C6-C12	Diln Fac:	1.000
Matrix:	Air	Batch#:	237608
Units:	ppbv	Analyzed:	08/02/16

Type	Lab ID	Spiked	Result	%REC	Limits	RPD	Lim
BS	QC845519	2,100	2,228	106	70-130		
BSD	QC845520	2,100	2,180	104	70-130	2	25

RPD= Relative Percent Difference

# GRO by TO-3

Sample ID: 279244-001,237608  
 Data File: c:\varianws\data\080216\215\_004.run  
 Sample List: c:\varianws\080216b.smp  
 Method: c:\varianws\to3\_103114.mth  
 Acquisition Date: 08/02/2016 17:06:12  
 Calculation Date: 08/02/2016 17:18:14  
 Instrument ID: MSAIR03 Operator: aa1  
 Injection Notes: 1x  
 Multiplier: 1.000 Divisor: 1.000

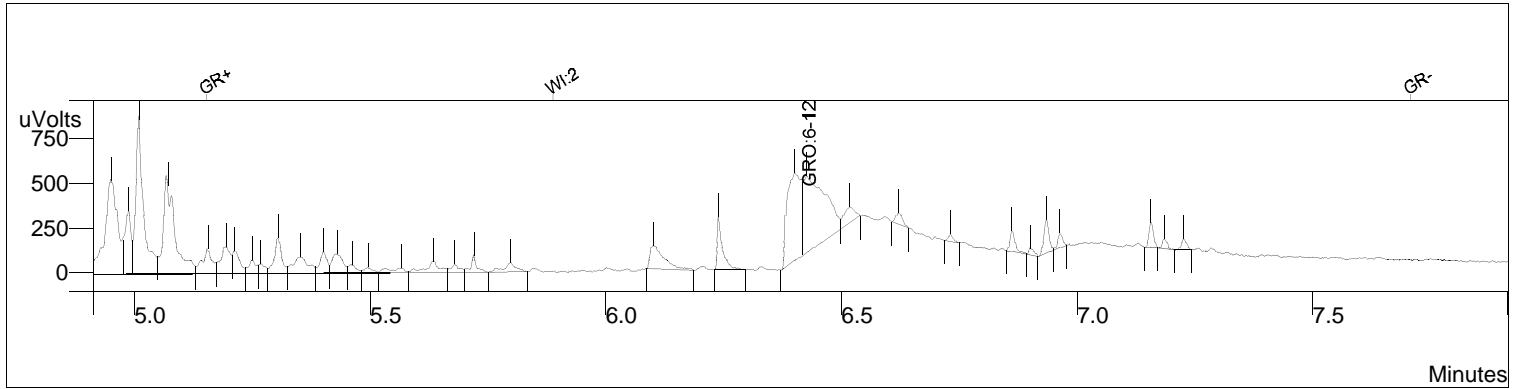

Channel: Front = FID RESULTS

#	RT (min)	Peak Name	Area	Result (ppbv)
1	6.431	GRO:6-12	5505	148.184
<b>Totals</b>			<b>5505</b>	<b>148.184</b>

**Integration Parameters**

Initial Tangent %: 0  
 Initial Peak Width (sec): 4  
 Initial Peak Reject Value: 50.000  
 Initial S/N Ratio: 5

**Data Handling Time Events**

Time (min)	Event
0.009	II on
4.801	II off
5.155	GR on
5.889	WI 2.0 sec
7.708	GR off
9.029	WI 4.0 sec
9.145	WI 2.0 sec



# GRO by TO-3

Sample ID: 279244-002,237608  
Data File: c:\varianws\data\080216\215\_005.run  
Sample List: c:\varianws\080216b.smp  
Method: c:\varianws\to3\_103114.mth  
Acquisition Date: 08/02/2016 17:20:52  
Calculation Date: 08/02/2016 17:32:54  
Instrument ID: MSAIR03 Operator: aa1  
Injection Notes: 1x  
Multiplier: 1.000 Divisor: 1.000

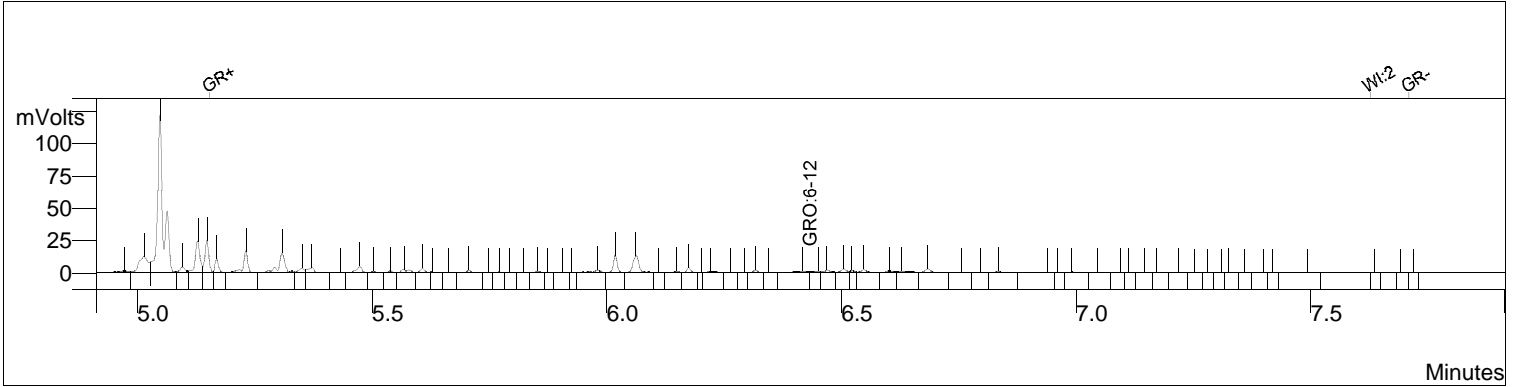

Channel: Front = FID RESULTS

#	RT (min)	Peak Name	Area	Result (ppbv)
1	6.431	GRO:6-12	123449	3322.983
		<b>Totals</b>	<b>123449</b>	<b>3322.983</b>

**Integration Parameters**

Initial Tangent %: 0  
Initial Peak Width (sec): 4  
Initial Peak Reject Value: 50.000  
Initial S/N Ratio: 5

**Data Handling Time Events**

Time (min) Event  
-----  
0.009 II on  
4.801 II off  
5.155 GR on  
7.625 WI 2.0 sec  
7.708 GR off

# GRO by TO-3

Sample ID: ccv/bs,qc845519  
 Data File: c:\varianws\data\080216\215\_001.run  
 Sample List: c:\varianws\080216.smp  
 Method: c:\varianws\to3\_103114.mth  
 Acquisition Date: 08/02/2016 12:26:40  
 Calculation Date: 08/02/2016 12:38:42  
 Instrument ID: MSAIR03 Operator: aa1  
 Injection Notes: 237608,s30511,1x  
 Multiplier: 1.000 Divisor: 1.000

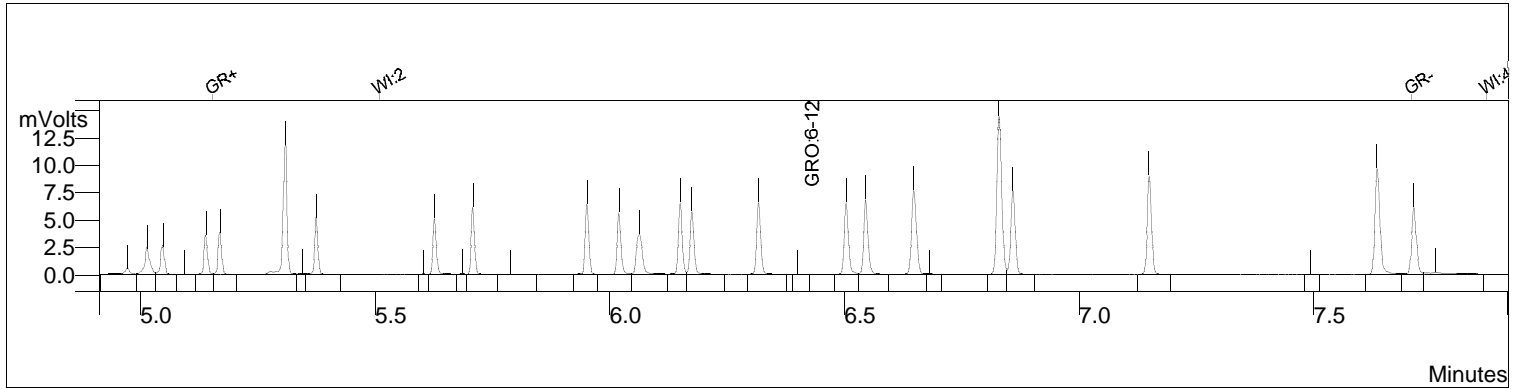

Channel: Front = FID RESULTS

#	RT (min)	Peak Name	Area	Result (ppbv)
1	6.431	GRO:6-12	82763	2227.793
<b>Totals</b>			<b>82763</b>	<b>2227.793</b>

**Integration Parameters**

Initial Tangent %: 0  
 Initial Peak Width (sec): 4  
 Initial Peak Reject Value: 50.000  
 Initial S/N Ratio: 5

**Data Handling Time Events**

Time (min)	Event
0.009	II on
4.801	II off
5.155	GR on
5.511	WI 2.0 sec
7.708	GR off
7.867	WI 4.0 sec
10.216	WI 2.0 sec