

**RECEIVED**

By Alameda County Environmental Health at 2:52 pm, Jun 27, 2014



**ENVIRONMENTAL ENGINEERING, INC.**  
6620 Owens Drive, Suite A • Pleasanton, CA 94588  
TEL (925)734-6400 • FAX (925)734-6401  
www.somaenv.com

June 27, 2014

Mr. Mark Detterman  
Alameda County Health Care Services Agency  
1131 Harbor Bay Parkway, Suite 250  
Alameda, California 94502-6577

Subject: Freedom Food and Gas (Formerly Freedom ARCO Mini-Mart)  
Site Address: 15101 Freedom Avenue, San Leandro, California  
**STID 4473/RO0000473**

Dear Mr. Detterman:

SOMA's "Second Quarter 2014 Groundwater Monitoring and Remediation Progress Report" for the subject property has been uploaded to the State's GeoTracker database and Alameda County's FTP site for your review.

Thank you for your time in reviewing our report. Please do not hesitate to call me at (925) 734-6400, if you have questions or comments.

Sincerely,

A handwritten signature in black ink, appearing to read 'Mansour Sepehr', written over a white background.

Mansour Sepehr, Ph.D., PE  
Principal Hydrogeologist



cc: Mr. Mohammad Pazdel w/report enclosure

**Second Quarter 2014  
Groundwater Monitoring and  
Remediation Progress Report**

**Freedom Food and Gas  
15101 Freedom Avenue  
San Leandro, California**

**June 27, 2014**

**Project 2551/2553**

**Prepared for**

**Mr. Mohammad Pazdel  
1770 Pistacia Court  
Fairfield, California**



**ENVIRONMENTAL ENGINEERING, INC.**

6620 Owens Drive Suite A Pleasanton CA 94588 Ph: 925.734.6400 F: 925.734-6401 [www.somaenv.com](http://www.somaenv.com)

## PERJURY STATEMENT

Site Location: 15101 Freedom Avenue, San Leandro, California

"I declare under penalty of perjury, that the information and/or recommendations contained in the attached document or report is true and correct to the best of my knowledge".

A handwritten signature in cursive script, reading "M. Pazdel", written over a horizontal line.

Mohammad Pazdel  
1770 Pistacia Court  
Fairfield, California 94533  
Responsible Party

## CERTIFICATION

SOMA Environmental Engineering, Inc. has prepared this report on behalf of the responsible party, Mr. Mohammad Pazdel, for property located at 15101 Freedom Avenue, San Leandro, California, to comply with Alameda County Health Care Services requirements for the Second Quarter 2014 groundwater monitoring event.



Mansour Sepehr, PhD, PE  
Principal Hydrogeologist



# TABLE OF CONTENTS

CERTIFICATION .....	i
TABLE OF CONTENTS.....	ii
LIST OF FIGURES .....	iii
LIST OF TABLES.....	iii
LIST OF APPENDICES .....	iv
1. INTRODUCTION .....	1
1.1 Field Activities.....	1
1.2 Laboratory Analysis .....	2
2. RESULTS .....	2
2.1 Field Measurements, First WBZ Wells.....	2
2.2 Laboratory Analysis, First WBZ Wells.....	3
2.3 Field Measurements, Second WBZ Wells .....	4
2.4 Laboratory Analysis for Second WBZ Wells .....	5
3. OPERATION OF TREATMENT SYSTEM.....	6
4. MULTI-PHASE EXTRACTION EVENTS .....	6
5. RESIDENTIAL WELL .....	7
6. CONCLUSIONS AND RECOMMENDATIONS.....	7
7. REPORT LIMITATIONS .....	8

## **LIST OF FIGURES**

- Figure 1: Site vicinity map
- Figure 2: Site Map Showing Locations of USTs, Fuel Dispensers, Soil Borings, and Groundwater Monitoring Wells
- Figure 3: Groundwater Elevation Contour Map in Feet, First WBZ, June 5, 2014
- Figure 4: Contour Map of TPH-g Concentrations in Groundwater, First WBZ, June 5 and 6, 2014
- Figure 5: Contour Map of Benzene Concentrations in Groundwater, First WBZ, June 5 and 6, 2014
- Figure 6: Contour Map of MtBE Concentrations in Groundwater, First WBZ, June 5 and 6, 2014
- Figure 7: Map Showing TBA, ETBE, TAME, and 1,2-DCA Concentrations in Groundwater, First WBZ, June 5 and 6, 2014
- Figure 8: Groundwater Elevation Contour Map in Feet, Second WBZ, June 5, 2014
- Figure 9: Map Showing MtBE Concentrations in Groundwater, Second WBZ, June 5 and 6, 2014
- Figure 10: Schematic diagram of Groundwater Remediation System
- Figure 11: Cumulative mass of VOCs removed

## **LIST OF TABLES**

- Table 1: Historical Groundwater Elevation Data and Analytical Results
- Table 2: Historical Gasoline Oxygenates Results
- Table 3: Effluent Chemical Analytical Results and Operational History of Remediation System
- Table 4: Cumulative Masses of Petroleum Hydrocarbons Removed from the Groundwater Since Installation of the Treatment System

## **LIST OF APPENDICES**

- Appendix A: Standard Operating Procedures for Conducting Groundwater Monitoring Activities
- Appendix B: Table of Elevations and Coordinates on Monitoring Wells, Field Measurements of Physical, Chemical, and Natural Attenuation Parameters of Groundwater Samples, and Groundwater Gradient Calculations
- Appendix C: Laboratory Reports and Chain of Custody Forms for the Second Quarter 2014 Monitoring Event
- Appendix D: Laboratory Reports and Chain of Custody Forms for the Treatment System

# 1. INTRODUCTION

SOMA Environmental Engineering, Inc. (SOMA) has prepared this report on behalf of the responsible party, Mr. Mohammad Pazdel, for property located at 15101 Freedom Avenue, San Leandro, California. The site is located in an area of primarily residential properties and adjacent commercial areas (Figure 1). The property was formerly owned by Mr. Mohammad Pazdel. In late 2009, the property was sold to DDH, LLC, Assignee and in early 2010 it was sold to Mr. Mohammad Mashhoon. Under the new management, the site is currently operational with the business name “Freedom Food and Gas” (formerly “Freedom Arco Mini-Mart”).

This report summarizes results of the Second Quarter 2014 groundwater monitoring event conducted on June 5 and 6, 2014. It includes physical and chemical properties measured in the field and laboratory analysis results for each groundwater sample. It also presents the remediation progress report for Second Quarter 2014, which includes operation of a groundwater extraction and treatment system.

## 1.1 Field Activities

In June 2014, SOMA’s field crew conducted a groundwater monitoring event in accordance with procedures and guidelines of Alameda County Health Care Services (ACHCS) and the California Regional Water Quality Control Board (CRWQCB). Figure 2 shows well locations.

On June 5, 2014, the following wells were measured for depth to groundwater: five on-site monitoring wells (MW-1 to MW-5) and two off-site wells (MW-6 and MW-7) in the First water-bearing zone (WBZ); two extraction wells (EX-1 and EX-2), two MPE wells (MPE-1 and MPE-2), and three on-site monitoring wells (MW-1D, MW-3D, and MW-4D) in the Second WBZ. On June 5 and 6, 2014, additional field measurements and groundwater samples were collected from all monitoring and MPE wells, except MW-3, MPE-1, and MPE-2 which were not sampled due to the presence of Free-Product (FP). Grab groundwater samples were also collected from extraction wells EX-1 and EX-2. Properties measured include pH, temperature, and electrical conductivity (EC).

A natural attenuation study was conducted during this event to determine whether petroleum hydrocarbons in groundwater are biodegrading. Dissolved oxygen (DO) and oxidation reduction potential (ORP) measurements were taken for all monitoring and MPE wells.



## 1.2 Laboratory Analysis

Curtis & Tompkins Laboratories, a California state-certified laboratory, analyzed groundwater samples for the following: total petroleum hydrocarbons as gasoline (TPH-g); benzene, toluene, ethylbenzene, total xylenes (collectively termed BTEX); methyl tertiary-butyl ether (MtBE); and gasoline oxygenates, ethanol and lead scavengers. Samples were prepared using EPA Method 5030B and analyzed using EPA Method 8260B.

## 2. RESULTS

Following are results of field measurements and laboratory analysis for the Second Quarter 2014 groundwater monitoring event.

### 2.1 Field Measurements, First WBZ Wells

Table 1 presents calculated groundwater elevations and depths to groundwater for each monitoring well. Depths to groundwater ranged from 15.18 feet in MW-7 to 23.46 feet in MW-1. FP was observed in MW-3, MPE-1, and MPE-2 at a thickness of 0.02 feet, 0.09 feet, and 0.02 feet, respectively. Appendix A includes the procedure for FP measurement.

Corresponding groundwater elevations ranged from 27.67 feet in MW-6 to 31.00 feet in MW-1. Groundwater elevations at extraction wells EX-1 and EX-2 were 26.05 feet and 22.55 feet, respectively. Groundwater elevations in MW-3, MPE-1, and MPE-2 were corrected for the presence of FP (Table 1).

Figure 3 displays the contour map of groundwater elevations. As illustrated, groundwater flows towards extraction wells, at a gradient of 0.035 feet/feet. Since the previous monitoring event (First Quarter 2014) the gradient has increased. Groundwater gradient calculations are attached in Appendix B.

Upon equalization with the surrounding aquifer at each well location, when the purge cycle was terminated, DO in the First WBZ ranged from 0.76 mg/L in MW-5 to 3.87 mg/L in MW-7. ORP showed positive redox potentials in all tested wells. Positive redox potentials are more energetically favorable in utilizing electron acceptors during chemical reactions. This promotes the removal of organic mass from the contaminated groundwater by indigenous bacteria in the subsurface during the release of the transfer of electrons.

Field measurements taken during this monitoring event are included in Appendix B (Table A).

## 2.2 Laboratory Analysis, First WBZ Wells

Appendix C includes the laboratory report and chain-of-custody form for this monitoring event.

Table 1 presents TPH-g, BTEX, and MtBE analysis results for the current and historical groundwater monitoring events.

TPH-g was below laboratory-reporting limit in MW-4 and was detected at concentrations ranging from 97 µg/L in MW-2 to 9,600 µg/L in MW-6. As mentioned above (Section 1.1), MW-3, MPE-1, and MPE-2 were not sampled due to the presence of FP. Since the previous monitoring event (First Quarter 2014), TPH-g increased in MW-1, MW-6, MW-7, EX-1, and EX-2 and decreased in MW-2 and MW-5.

It is to be noted that no comparison could be made for MW-3, MPE-1, and MPE-2 due to the presence of FP.

Figure 4 displays the contour map of TPH-g concentrations in groundwater. As illustrated, the highest TPH-g impact is to the southeast of the site and in the vicinity of MW-6.

The following BTEX concentrations were observed:

- FP was observed in MW-3, MPE-1, and MPE-2 at a thickness of 0.02 feet, 0.09 feet, and 0.02 feet, respectively. Appendix A includes the procedure for FP measurement.
- Benzene was below laboratory-reporting limits in MW-2 and MW-7. Detectable benzene concentrations ranged from 8.2 µg/L in MW-5 to 710 µg/L in MW-4.
- Toluene was below laboratory-reporting limits in MW-1, MW-2, MW-4, MW-6, and MW-7. Detectable toluene concentrations ranged from 0.56 µg/L in MW-5 to 37 µg/L in EX-2.
- Ethylbenzene was below laboratory-reporting limit in MW-2 and was detected in concentrations ranging from 11 µg/L in MW-7 to 370 µg/L in MW-6.
- Total xylenes were below laboratory-reporting limits in MW-2 and MW-4. Detectable concentrations ranged from 3.0 µg/L in MW-7 to 590 µg/L in EX-2.

Figure 5 displays the contour map of benzene in groundwater. The highest benzene impact is in the southern section of the site near dispenser islands. Since the previous monitoring event (First Quarter 2014), benzene has increased in MW-1, MW-4, EX-1, and EX-2 and decreased in MW-5 and MW-6.

MtBE was below the laboratory-reporting limit in MW-2 and MW-6. Detectable MtBE ranged from 0.75 µg/L in MW-5 to 40 µg/L in EX-1. Figure 6 displays the contour map of MtBE concentrations in groundwater. The highest MtBE impact is to the south of the site and in the vicinity of extraction well EX-1. Since the previous monitoring event (First Quarter 2014), MtBE has increased in MW-4 and MW-7, decreased in MW-1, MW-5, and EX-2, and remained the same in EX-1.

As shown in Table 1, TPH-g and ethylbenzene increased while benzene, toluene, and total xylenes decreased in more impacted well MW-6 where free-product has been observed in the past, since the previous monitoring event (First Quarter 2014) while no comparison could be made for MW-3, MPE-1, and MPE-2 due to the presence of FP.

Table 2 shows analysis results for gasoline oxygenate and lead scavenger concentrations for the current as well as historical events.

The following gasoline oxygenate and lead scavenger concentrations were observed:

- In MW-1, MW-2, MW-6, and EX-2 all gasoline oxygenates and lead scavengers were below laboratory-reporting limits.
- Tertiary-butyl alcohol (TBA) was detected in MW-4 and EX-1 at 360 µg/L and 70 µg/L, respectively. Figure 7 shows the map of TBA concentrations in First WBZ wells. Since the previous monitoring event (First Quarter 2014), TBA increased in MW-4 and EX-1.
- Methyl tertiary-amyl ether (TAME) was detected in MW-5 at 0.81 µg/L, in MW-7 at 0.76 µg/L, and in EX-1 at 3.9 µg/L, and was below the laboratory-reporting limit in remaining wells. Figure 7 displays the map of TAME concentrations in First WBZ wells.
- Ethyl tertiary-butyl ether (ETBE) was detected in EX-1 at 1.10 µg/L, and was below laboratory-reporting limits in remaining wells. Figure 7 displays the map of ETBE concentrations in First WBZ wells.
- 1,2-dichloroethane (1,2-DCA) was detected in EX-1 at 0.69 µg/L and was below laboratory-reporting limit in remaining wells. Figure 7 displays the map of 1,2-DCA concentrations in First WBZ wells.
- Isopropyl ether (DIPE), 1,2-dibromoethane (EDB), and ethanol were below laboratory-reporting limits in all groundwater samples. Analysis results for ethanol are shown in Appendix C.

### **2.3 Field Measurements, Second WBZ Wells**

Table 1 presents calculated groundwater elevations and depths to groundwater for each Second WBZ monitoring well. Depths to groundwater ranged from 22.78

feet in MW-4D to 23.68 feet in MW-1D. Corresponding groundwater elevations ranged from 30.34 feet in MW-4D to 30.77 feet in MW-3D.

Figure 8 displays the contour map of groundwater elevations in the Second WBZ. Groundwater flows southwesterly at a gradient of 0.0043 feet/feet. The groundwater gradient has increased since the previous monitoring event (First Quarter 2014) and the flow direction has changed from northwesterly to southwesterly. Groundwater gradient calculations are attached in Appendix B.

Upon equalization with the surrounding aquifer at each well location, when the purge cycle was terminated, DO in the Second WBZ ranged from 1.37 mg/L in MW-1D to 1.81 mg/L in MW-4D. ORP showed positive redox potentials in all second WBZ wells. Positive redox potentials are more energetically favorable in utilizing electron acceptors during chemical reactions. This promotes the removal of organic mass from the contaminated groundwater by indigenous bacteria in the subsurface during the release of the transfer of electrons.

Field measurements taken during this monitoring event are included in Appendix B.

## **2.4 Laboratory Analysis for Second WBZ Wells**

Appendix C includes the laboratory report and chain-of-custody form for this monitoring event.

Table 1 presents TPH-g, BTEX, and MtBE analysis results for the current and historical groundwater monitoring events.

TPH-g was below laboratory-reporting limit in all Second WBZ wells. TPH-g has decreased in MW-3D since the previous monitoring event (First Quarter 2014).

The following BTEX concentrations were observed:

- All BTEX analytes were below laboratory-reporting limits in MW-1D and MW-4D.
- In MW-3D, benzene, toluene, and ethylbenzene were below laboratory-reporting limits, and total xylenes were detected at 0.77 µg/L, respectively. Since the previous monitoring event (First Quarter 2014), toluene, ethylbenzene, and total xylenes have decreased in this well.

MtBE was below the laboratory-reporting limit in MW-1D and was detected in MW-3D and MW-4D at 1.5 µg/L and 1.8 µg/L, respectively. Since the previous monitoring event (First Quarter 2014), MtBE has increased in MW-3D and decreased in MW-4D. Figure 9 shows the map of MtBE concentrations in Second WBZ.

Table 2 shows analysis results for gasoline oxygenate and lead scavenger concentrations for the current as well as historical events.

All gasoline oxygenate, lead scavenger, and ethanol concentrations were below laboratory-reporting limits in Second WBZ wells.

### **3. OPERATION OF TREATMENT SYSTEM**

SOMA installed a groundwater treatment system at the site in December 2009. The system includes two extraction wells (EX-1 and EX-2), trenching containing influent and effluent lines and electrical conduits, and the treatment system compound. During system operation, extracted groundwater is pumped from extraction wells through underground piping to a fenced treatment compound, adjacent to the existing service station building.

In the treatment compound, groundwater is treated using granular activated carbon (GAC) and subsequently discharged to the sanitary sewer. Two GAC vessels are connected in series. The first unit (1,000 gallons) serves as the primary treatment unit, and the second (55 gallons) polishing drum provides an additional safety buffer prior to discharge. Effectiveness of the GAC units is monitored by collection and analysis of samples from the system discharge, including a sample collected from water that has passed only through the first GAC unit. When analytical results indicate that the first GAC unit is no longer effectively treating groundwater, the vessel will be removed from the treatment line and refurbished with new carbon. The polishing unit was replaced on June 16, 2014 because this drum was leaking at the base.

Since the system began discharging, approximately 3,074,736 gallons of groundwater have been treated and discharged at the site (as of June 23, 2014).

The treatment system operates under discharge permit issued by Oro Loma Sanitary District (OLSD) in May 2009. This discharge permit was most recently renewed in May 2012. Treated groundwater has been discharging to the OLSD sewer since December 9, 2009. Figure 10 shows the schematic diagram of the groundwater treatment system. Treatment system effluent is sampled monthly to comply with OLSD discharge permit requirements. Table 3 includes analytical results and operational history of the treatment system. As shown in Table 4, as of April 17, 2014, cumulative masses of TPH-g and BTEX extracted from groundwater were approximately 36.86 pounds, 1.40 pounds, 0.36 pounds, 0.91 pounds, and 4.91 pounds, respectively. Appendix D includes laboratory analytical results.

### **4. MULTI-PHASE EXTRACTION EVENTS**

No MPE events were performed during Second Quarter 2014. The overall estimated total mass of VOCs extracted by previous MPE events is 2,737

pounds. This includes the following: 106 pounds, November 2007 pilot test; 243 pounds, October 2009 event; 72 pounds, November 2009 event; 97 pounds, December 2009 event; 17 pounds, February 2010 event; 11 pounds, March 2010 event; 30 pounds, June 2010 event; 30 pounds, August 2010 event; 79 pounds, October 2010 event; 27 pounds, April 2011 event; 94 pounds, August 2011 event; 300 pounds, May 2013 event; 841 pounds, August 2013 event; and 790 pounds, October 2013 event.

Figure 11 shows the extracted mass of VOCs during different MPE events at the site.

## **5. RESIDENTIAL WELL**

During the investigation of January 2008, a groundwater sample was obtained from residential well located at 1573 153<sup>rd</sup> Avenue. At that time TBA was detected in this well at 21 µg/L. Subsequently, groundwater samples were collected from this well during July 2008 and October 2008 with results showing that all contaminants of concern (including TBA) were below laboratory-reporting limits. SOMA also contacted the owner of this well in April 2013 in attempt of collecting another groundwater sample. In response, the well owner informed SOMA that the pump in his well is broken and that there is no way to extract groundwater water from the well.

Prior to this monitoring event, SOMA sent another letter to the owner requesting access to personally inspect this well and attempt to retrieve a groundwater sample. However, no response was received.

## **6. CONCLUSIONS AND RECOMMENDATIONS**

Second Quarter 2014 groundwater monitoring and previous MPE events results are summarized below.

- FP was observed in MW-3, MPE-1, and MPE-2 at a thickness of 0.02 feet, 0.09 feet, and 0.02 feet, respectively.
- Groundwater flows towards extraction wells in the First WBZ and southwesterly in the Second WBZ.
- The highest TPH-g and MtBE concentrations were observed to the south of the site in MW-6 and EX-1, respectively. Highest benzene concentration was observed in the southern section of the site in MW-4. FP was observed in MW-3 and extraction wells MPE-1 and MPE-2.
- Since the previous monitoring event (First Quarter 2014), TPH-g and ethylbenzene increased while benzene, toluene, and total xylenes

decreased in more impacted well MW-6 while no comparison could be made for MW-3, MPE-1, and MPE-2 due to the presence of FP.

- In the Second WBZ, since the previous monitoring event (First Quarter 2014), TPH-g, toluene, ethylbenzene, and total xylenes decreased in MW-MW-3D; MtBE increased in MW-3D and decreased in MW-4D.
- The total mass of hydrocarbon removed by MPE operations (as of November 2013) is estimated to be 2,737 pounds.
- SOMA was unable to inspect the residential well located at 1573 153<sup>rd</sup> Avenue because there has been no response from the owner. This well was reported as inactive by the owner in April 2013.

Based on results of this monitoring event and previous MPE events, SOMA recommends the following action items:

- Continue quarterly groundwater monitoring to increase understanding of seasonal variations in groundwater quality conditions.
- Due to increased effectiveness of MPE operation during October-November 2013 event and the presence of FP in MW-3, MPE-1, and MPE-2, SOMA proposes additional MPE operation for mitigating the chemical source areas around these wells.

Based on ACHCS' request dated May 23, 2014, SOMA has submitted a work plan for installation of three off-site groundwater monitoring wells, conducting additional MPE events, and additional vapor sampling beneath the house on the neighboring property. Upon receipt of approval from ACHCS, SOMA will schedule the field activities.

## **7. REPORT LIMITATIONS**

This report is the summary of work done by SOMA, including observations and descriptions of site conditions. It includes analysis results produced by Curtis & Tompkins Laboratories for the current groundwater monitoring event. Quantities and locations of wells were selected to provide the required information, but may not be representative of entire site conditions. All conclusions and recommendations are based on laboratory analysis results. Conclusions beyond those specifically stated in this document should not be inferred from this report.

SOMA warrants that services were provided in accordance with generally accepted practices in the environmental engineering and consulting field at the time of this sampling.

# Figures



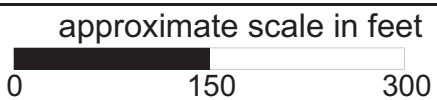
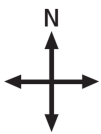
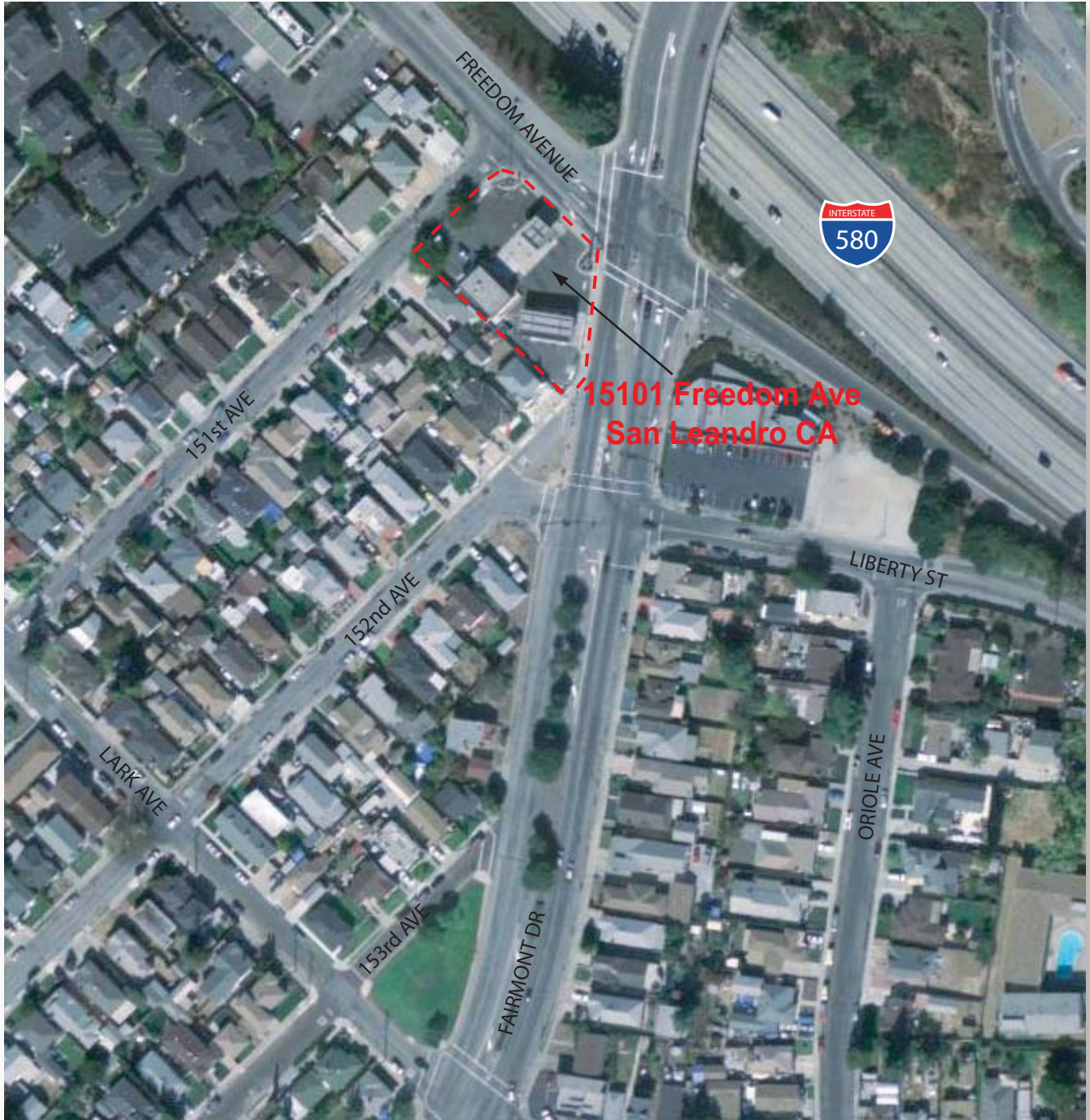

Figure 1: Site vicinity map.

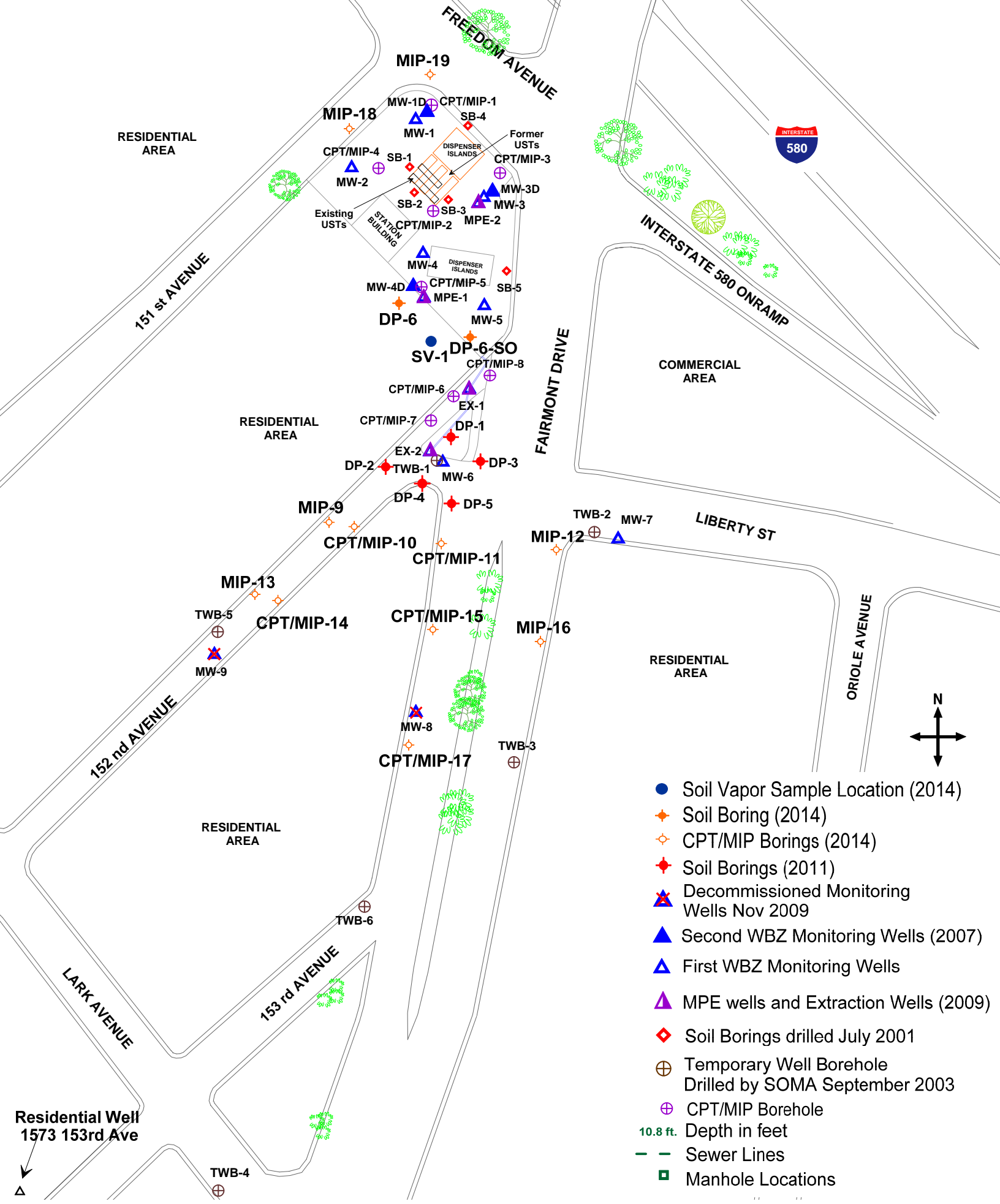
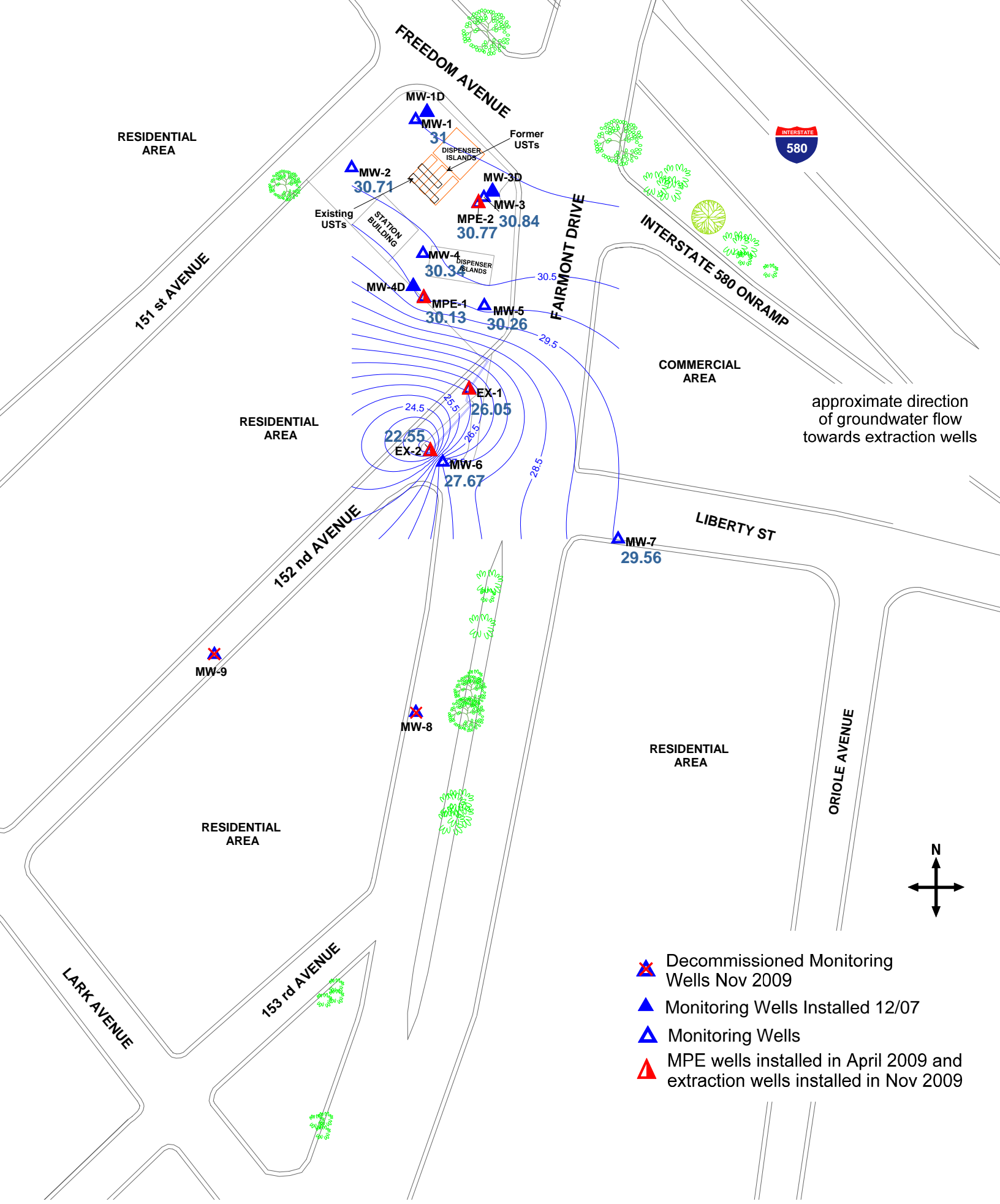





Figure 2: Site Map Showing Locations of USTs, Fuel Dispensers, Soil Borings, and Groundwater Monitoring Wells



-  Decommissioned Monitoring Wells Nov 2009
-  Monitoring Wells Installed 12/07
-  Monitoring Wells
-  MPE wells installed in April 2009 and extraction wells installed in Nov 2009



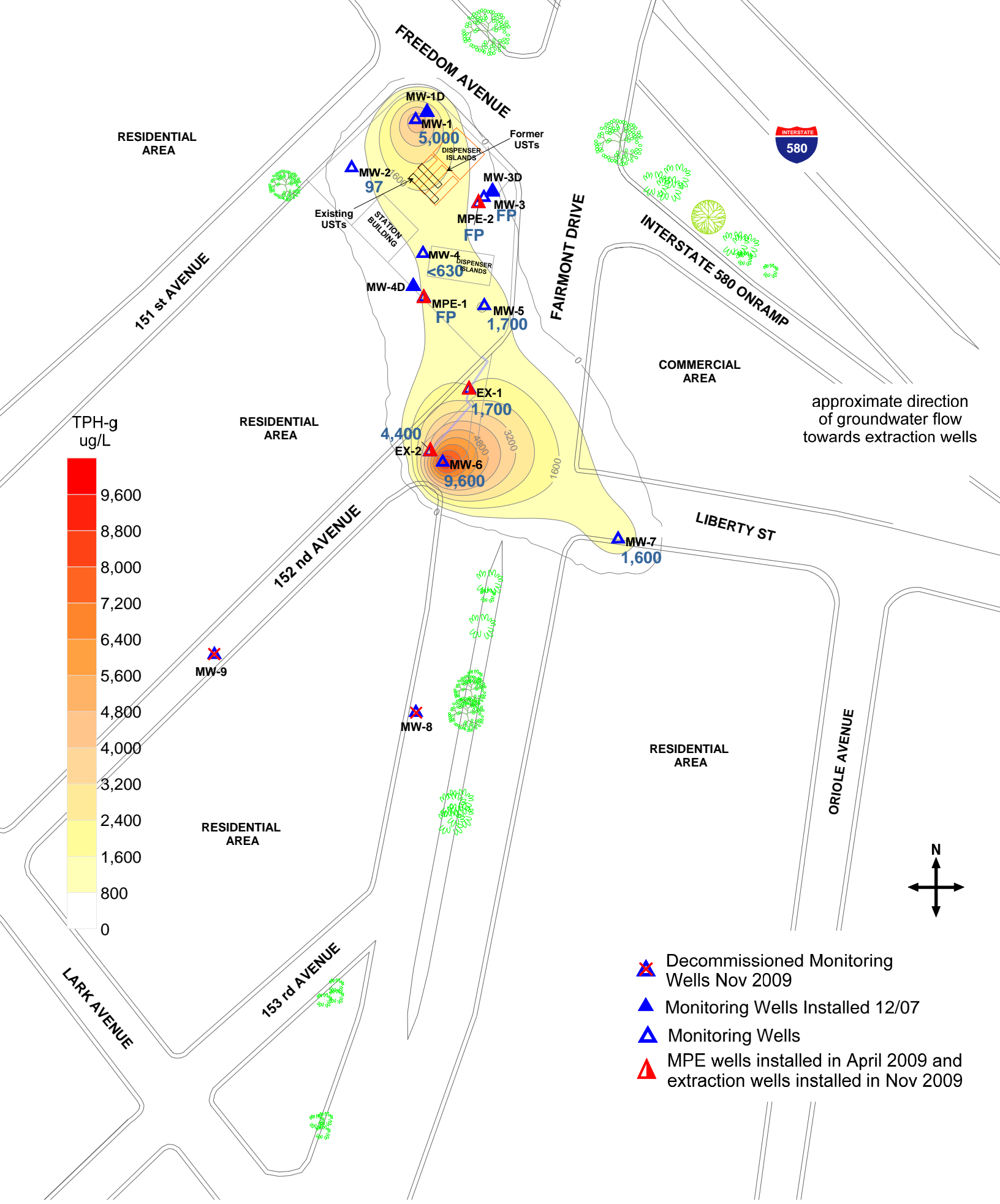

approximate scale in feet

0 50 100

Figure 3: Groundwater Elevation Contour Map in Feet, First WBZ, June 5, 2014



approximate direction of groundwater flow towards extraction wells

-  Decommissioned Monitoring Wells Nov 2009
-  Monitoring Wells Installed 12/07
-  Monitoring Wells
-  MPE wells installed in April 2009 and extraction wells installed in Nov 2009

approximate scale in feet  
 0 50 100

Figure 4: Contour Map of TPH-g Concentrations in Groundwater, First WBZ, June 5 and 6, 2014



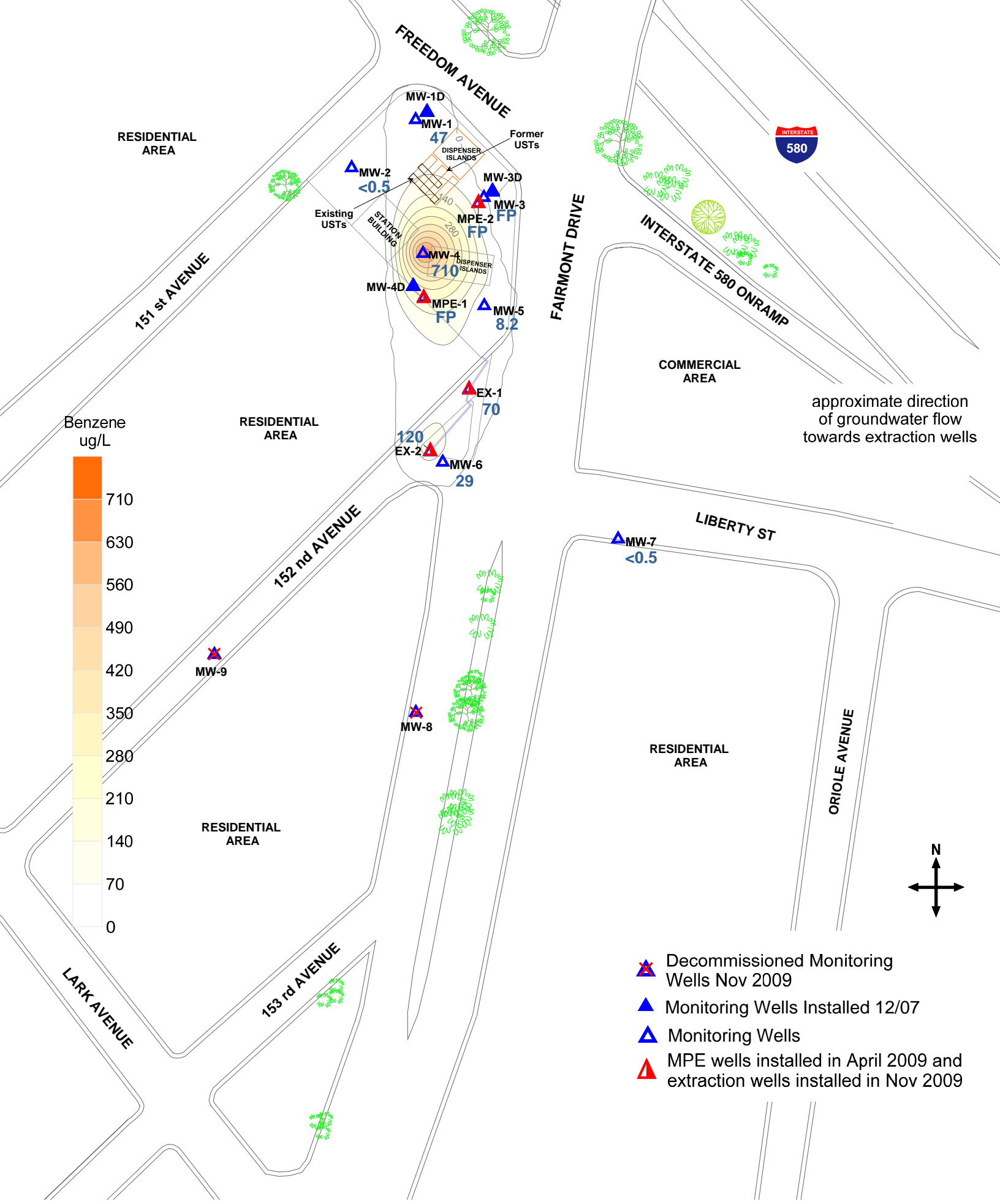
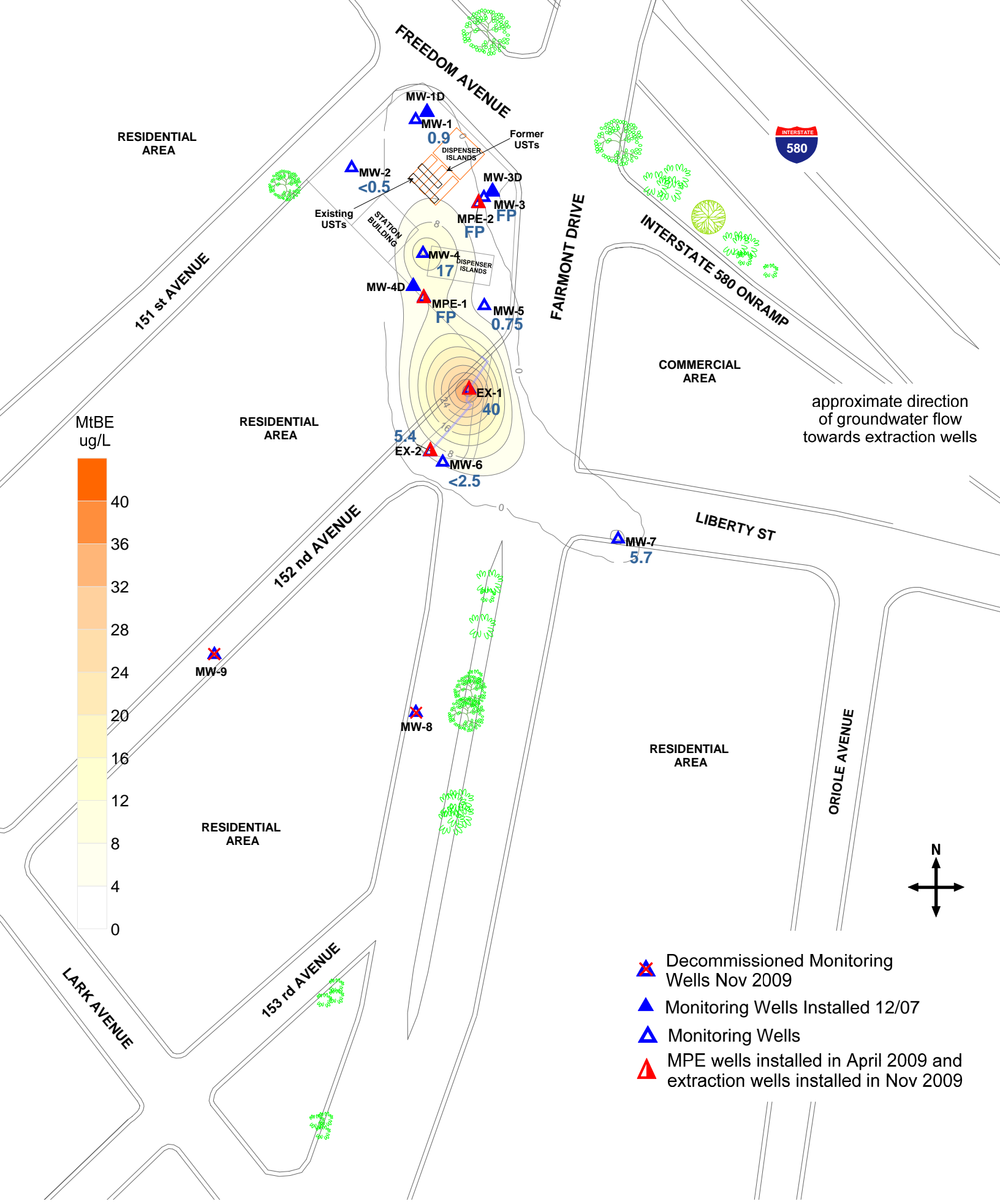

Figure 5: Contour Map of Benzene Concentrations in Groundwater, First WBZ, June 5 and 6, 2014

approximate scale in feet  
 0 50 100



approximate scale in feet

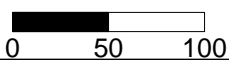

Figure 6: Contour Map of MtBE Concentrations in Groundwater, First WBZ, June 5 and 6, 2014

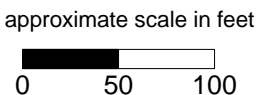
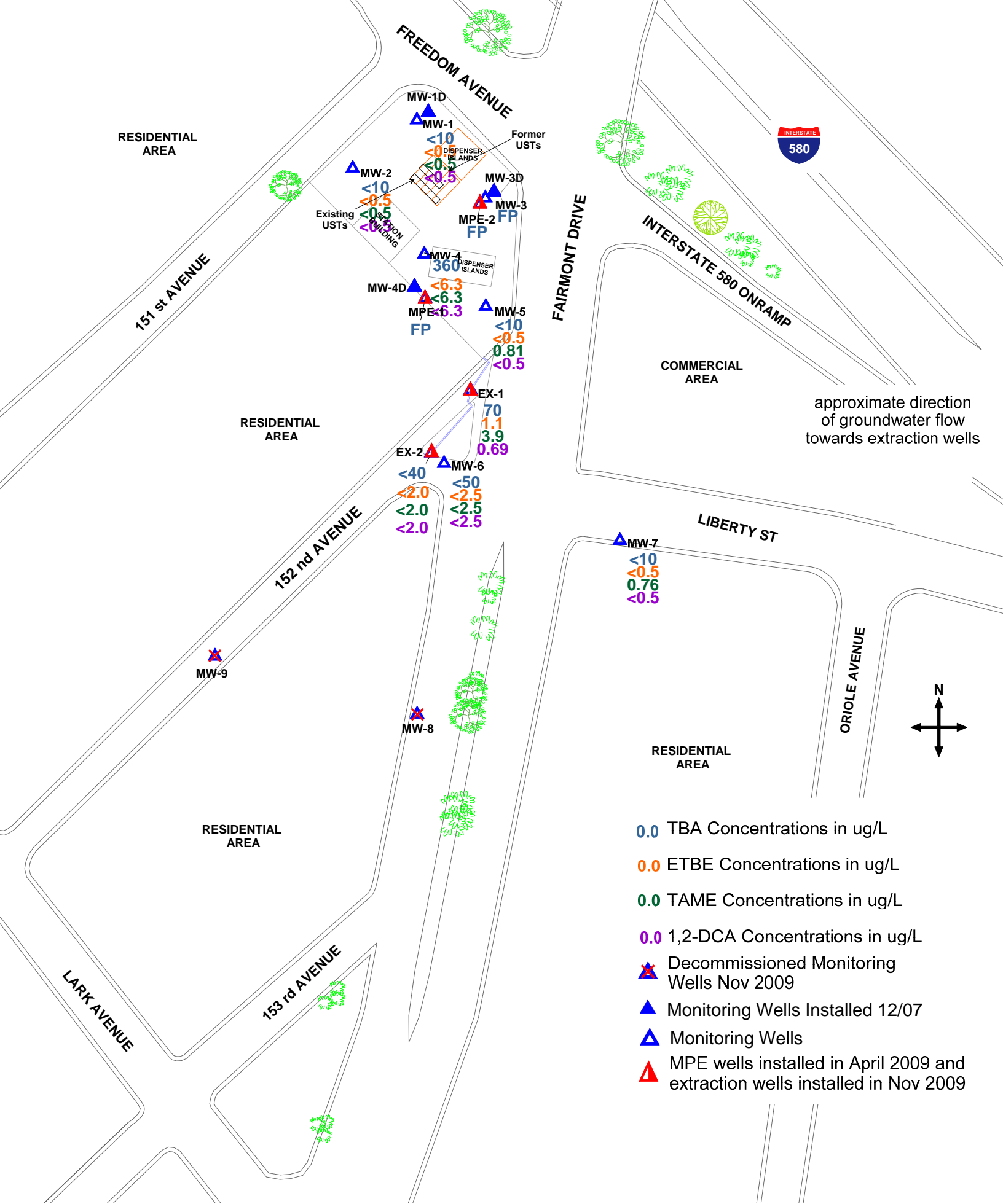

Figure 7: Map Showing TBA, ETBE, TAME, and 1,2-DCA Concentrations in Groundwater, First WBZ, June 5 and 6, 2014



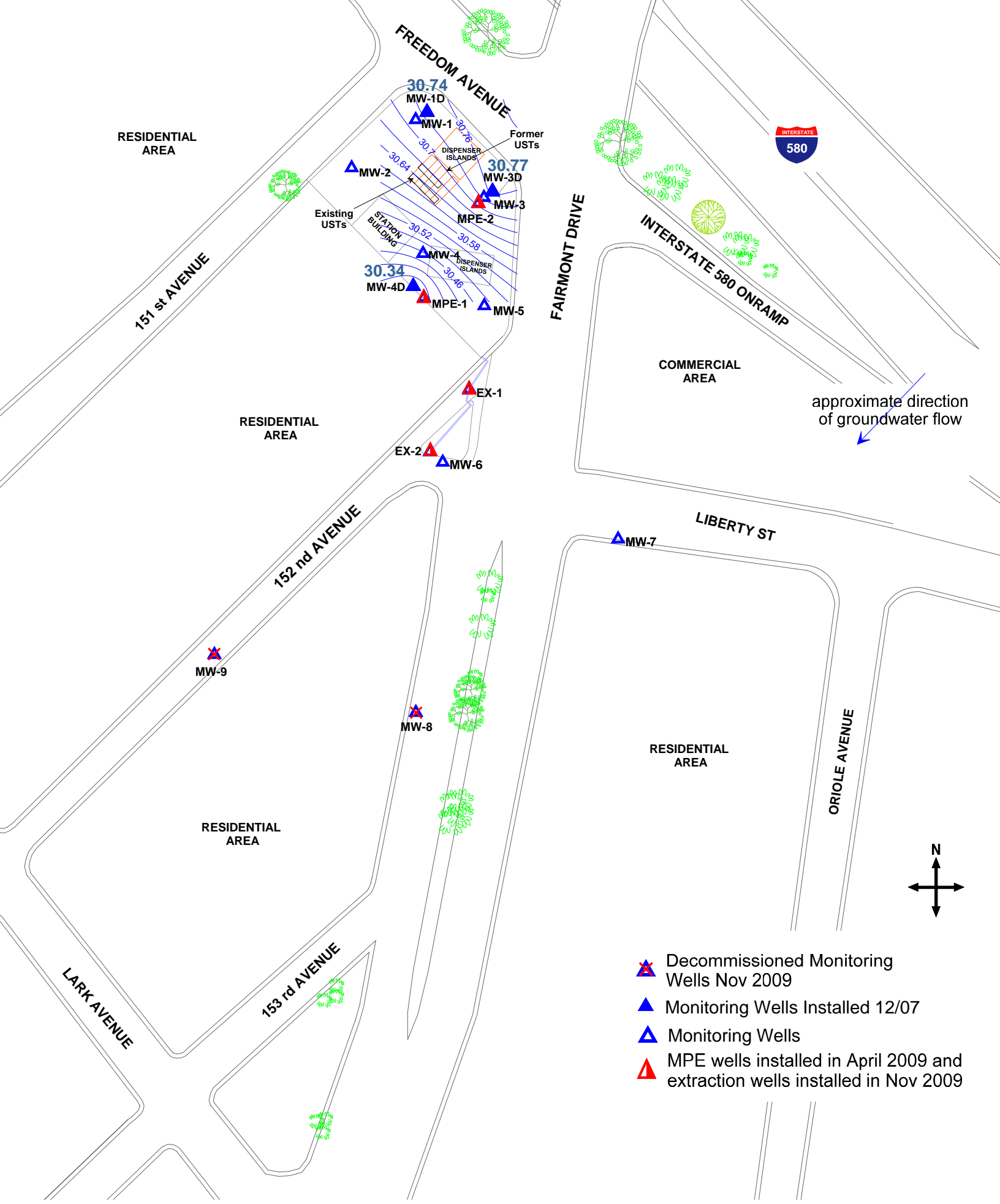

Figure 8: Groundwater Elevation Contour Map in Feet, Second WBZ, June 5, 2014



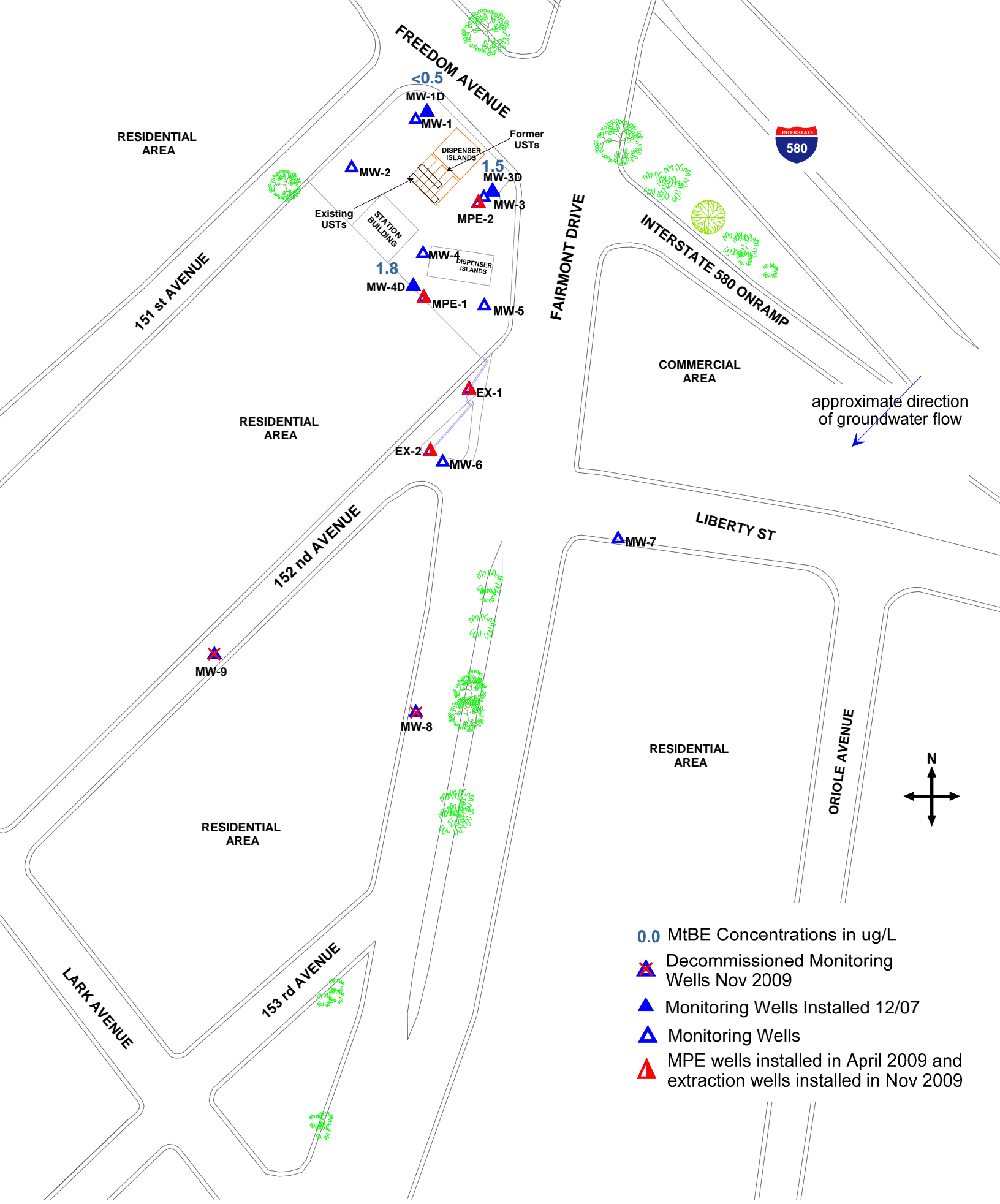

Figure 9: Map Showing MtBE Concentrations in Groundwater, Second WBZ, June 5 and 6, 2014

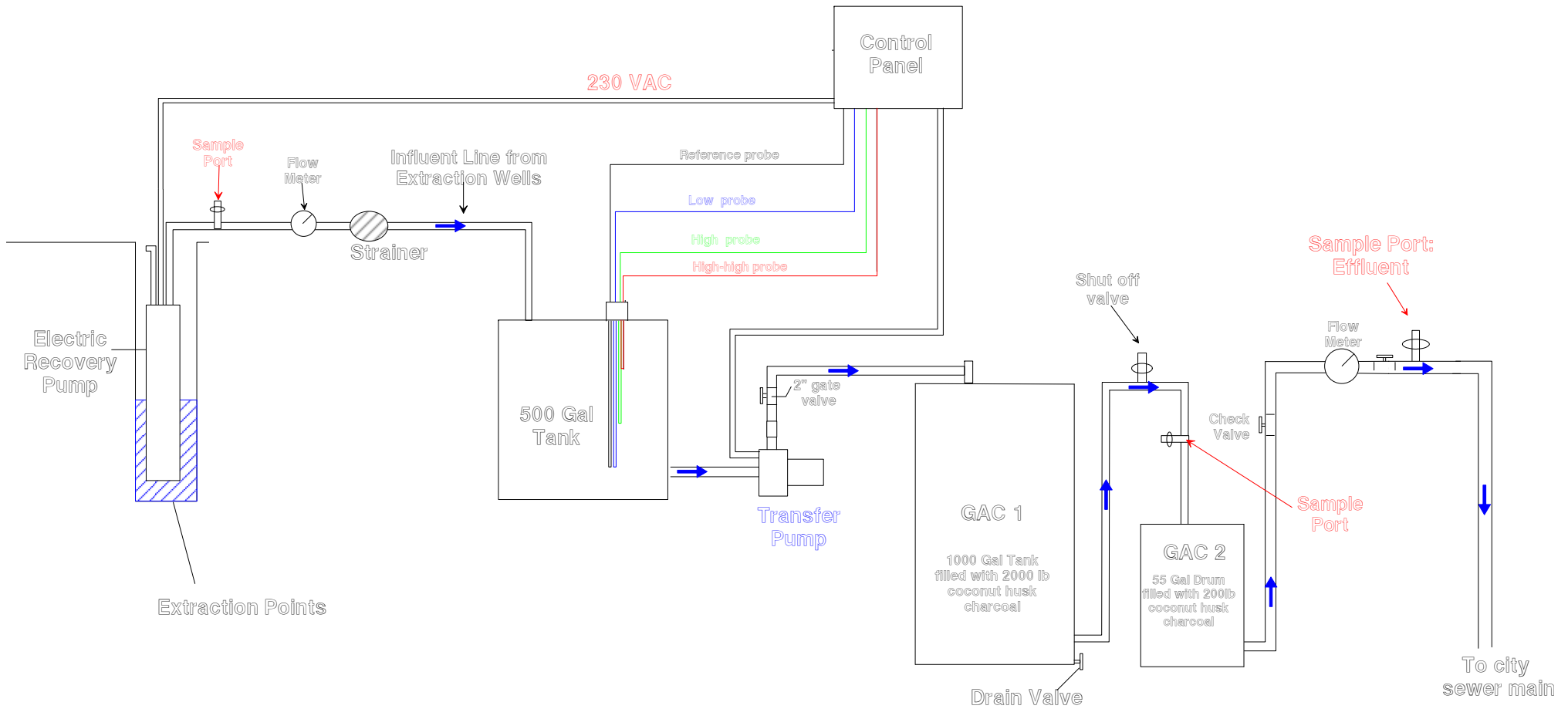

Figure 10: Schematic diagram of Groundwater Remediation System

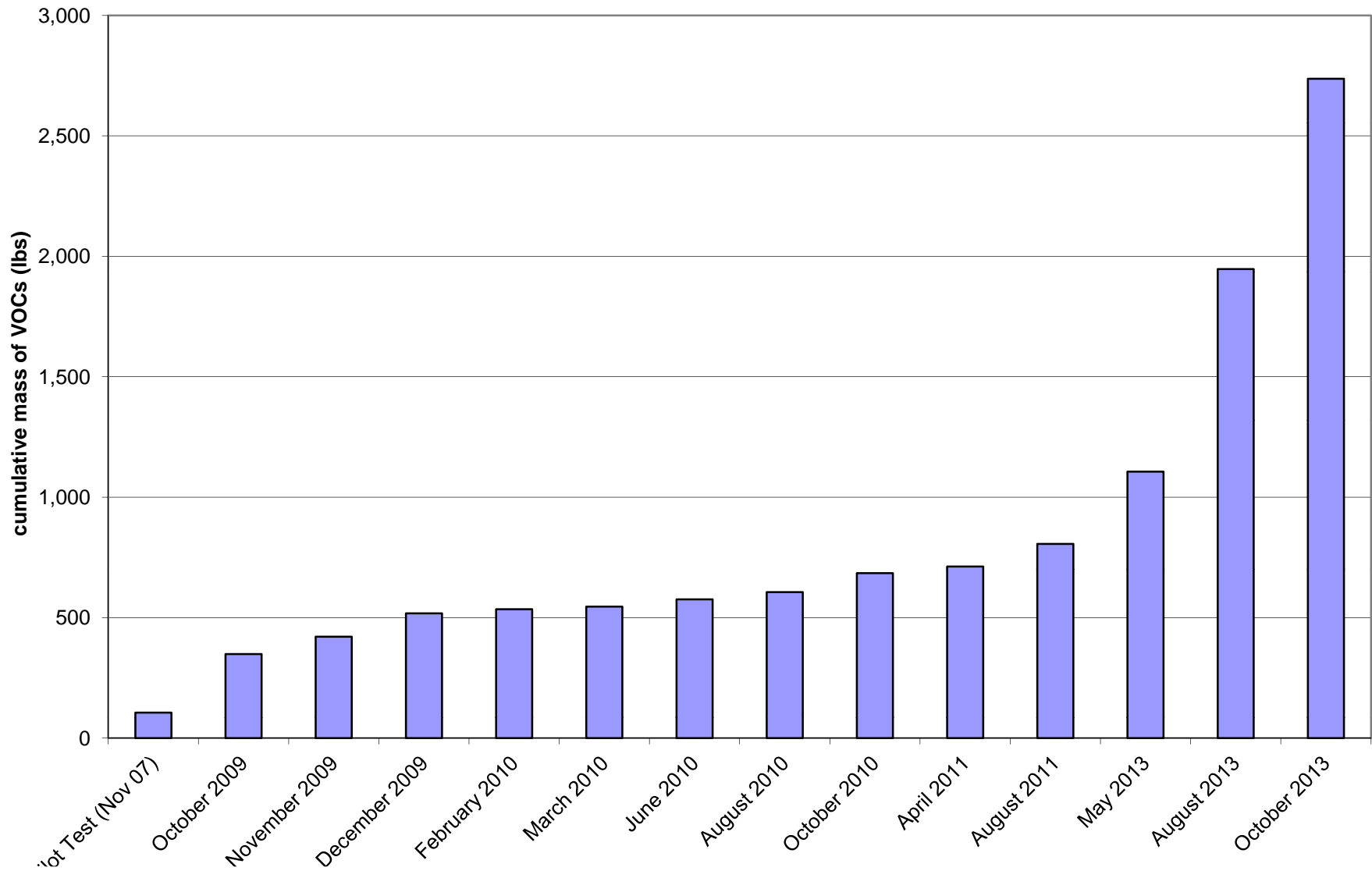

Figure 11: Cumulative mass of VOCs removed

# Tables

**Table 1**  
**Historical Groundwater Elevation Data and Analytical Results**  
**15101 Freedom Avenue, San Leandro, CA**

Monitoring Well	Date	Casing Elevation <sup>1</sup> (feet)	Depth to Groundwater (feet)	Free-Product (feet)/ Sheen (Y/N)	Groundwater Elevation (feet)	TPH-g (µg/L)	Benzene (µg/L)	Toluene (µg/L)	Ethyl-benzene (µg/L)	Total Xylenes (µg/L)	MtBE 8260B <sup>2</sup> (µg/L)
<b>1st WBZ</b>											
<b>MW-1</b>	5/10/2002	51.71	22.85	-	28.86	5,700	360	4.5	340	450	2
	8/8/2002	51.71	23.31	-	28.40	9,100	590	2.6	830	362	<1.3
	11/8/2002	51.71	23.58	-	28.13	7,900	570	3.1	680	392	< 1.0
	2/21/2003	51.71	22.62	-	29.09	2,900	160	1.6 C	170	211	<0.5
	5/28/2003	51.71	22.43	-	29.28	1,700	55	<0.5	90	115	2.00
	8/12/2003	51.71	21.30	-	30.41	2,600	2.5	<0.5	190	130	<0.5
	10/9/2003	51.71	23.49	-	28.22	9,200	560.0	2.7 C	670	648	<1.0
	1/15/2004	51.71	22.43	-	29.28	5,500	190	<1.0	220	124.4	<0.5
	5/25/2004	51.71	22.94	-	28.77	8,000	400	1.50	420	393	3.40
	9/21/2004	54.46	23.49	-	30.97	9,300	580	9.30	690	683	4.60
	12/14/2004	54.46	23.01	-	31.45	7,360	337	<4.3	731	633	<4.3
	3/11/2005	54.46	21.48	-	32.98	2,510	45.2	<0.5	23.2	39.63	2.80
	6/15/2005	54.46	22.42	-	32.04	1,690	36.3	<2.0	59.5	28.73	2.01
	8/26/2005	54.46	23.00	-	31.46	7,310	318	<8.60	475	316	5.15
	11/11/2005	54.46	21.40	-	33.06	9,640	341	<8.6	467	329.7	6.04
	2/9/2006	54.46	21.81	-	32.65	775	14	<2.0	12.6	10.32	4.01
	5/9/2006	54.46	21.68	-	32.78	444	7.80	<2.0	12.1	6.31	1.75
	8/10/2006	54.46	22.79	-	31.67	5,090	324	<8.60	108	59.9	8.24
	10/26/2006	54.46	23.19	-	31.27	6,950	556	<4.0	190	136.09	8.61
	1/25/2007	54.46	22.82	-	31.64	2,640	196	<2.0	105	25.5	7.92
	4/26/2007	54.46	22.67	-	31.79	861	95.5	<2.0	17	6.36	4.00
	7/25/2007	54.46	23.25	-	31.21	4,520	412	<4.0	182	77.9	7.48
10/23/2007	54.46	23.42	-	31.04	3,900	117	<2.0	87.1	23.87	4.54	
1/22/2008	54.46	22.59	-	31.87	2,260	81.3	<2.0	17.5	<2.0	4.23	
4/16/2008	54.46	22.89	-	31.57	2,320	248	<2.0	54.1	37.3	<0.5	
7/3/2008	54.46	23.33	-	31.13	5,240	414	<2.0	168	94	6.56	
10/15/2008	54.46	23.76	-	30.70	4,500 <sup>Y</sup>	260	<1.0	150	130	3.40	
1/7/2009	54.46	23.25	-	31.21	4,800	140	<1.3	48	32	1.70	
4/14/2009	54.46	22.52	-	31.94	1,800 <sup>Y</sup>	78	<0.5	35	18	2.50	
8/27/2009	54.46	23.6	-	30.86	4,500	330	<2.0	97	42	4.60	
12/2/2009	54.46	23.43	-	31.03	3,800 <sup>Y</sup>	250	<2.0	110	25	2.50	

**Table 1**  
**Historical Groundwater Elevation Data and Analytical Results**  
**15101 Freedom Avenue, San Leandro, CA**

Monitoring Well	Date	Casing Elevation <sup>1</sup> (feet)	Depth to Groundwater (feet)	Free-Product (feet)/ Sheen (Y/N)	Groundwater Elevation (feet)	TPH-g (µg/L)	Benzene (µg/L)	Toluene (µg/L)	Ethyl-benzene (µg/L)	Total Xylenes (µg/L)	MtBE 8260B <sup>2</sup> (µg/L)
MW-1 cont	3/17/2010	54.46	22.32	-	32.14	1,100	33	<0.50	46	18	1.70
	6/3/2010	54.46	22.88	-	31.58	10,000	330	4.3	680	841.5	5.20
	9/2/2010	54.46	23.28	-	31.18	8,900	440	<5.0	510	310	<5.0
	12/2/2010	54.46	23.21	-	31.25	7,400	250	<3.1	390	180	<3.1
	3/4/2011	54.46	21.95	N	32.51	2,400	67	<0.5	45	8.4	2.20
	5/20/2011	54.46	22.8	N	31.66	9,500	260	6.2	970	480	<3.6
	9/9/2011	54.46	22.81	N	31.65	6,400	220	<1.3	380	160	2.30
	12/2/2011	54.46	21.97	N	32.49	4,700 <sup>x</sup>	96	<1.7	310	200	<3.3
	3/2/2012	54.46	22.82	N	31.64	6,800	320	<2.5	430	120	<2.5
	6/7/2012	54.46	22.92	N	31.54	5,600	130	<2.5	360	160	2.9
	9/21/2012	54.46	23.56	N	30.90	8,000	300	<2.5	410	340	2.6
	12/14/2012	54.46	22.77	N	31.69	5,900	130	<2.5	320	97	<2.5
	3/28/2013	54.46	23.15	N	31.31	5,100	230	<2.5	280	48	3.6
	6/11/2013	54.46	23.48	N	30.98	6,800	200	<2.5	300	120	<2.5
	9/17/2013	54.46	23.84	N	30.62	7,500	120	<2.5	410	260	<2.5
	12/6/2013	54.46	24.16	N	30.30	5,300	71	<1.7	240	84	<1.7
	3/13/2014	54.46	23.47	N	30.99	2,800	16	<0.5	74	15	1.4
	<b>6/6/2014</b>	<b>54.46</b>	<b>23.46</b>	<b>N</b>	<b>31.00</b>	<b>5,000</b>	<b>47</b>	<b>&lt;0.5</b>	<b>240</b>	<b>58</b>	<b>0.9</b>
	MW-2	5/10/2002	49.66	22.83	-	26.83 <sup>*</sup>	3,100	67	8	250	215
8/8/2002		49.66	21.41	-	28.25	2,700	4.6	<0.5	310	140	<0.5
11/8/2002		49.66	21.79	-	27.87	3,400	4.6	< 0.5	310	160	< 0.5
2/21/2003		49.66	20.51	-	29.15	890	1.7 C	0.80 C	68	38.92 C	<0.5
5/28/2003		49.66	20.33	-	29.33	2,700	5.2 C	<0.5	120	140	1.2
8/12/2003		49.66	23.18	-	26.48 <sup>*</sup>	8,500	640	<2.5	560	659	<0.8
10/9/2003		49.66	21.71	-	27.95	3100 H	4.3 C	<0.5	210	160	<0.5
1/15/2004		49.66	20.31	-	29.35	660 H	1.5 C	<0.5	8.9	25	<0.5
5/25/2004		49.66	21.09	-	28.57	4,500	5.1 C	<0.5	190	230	0.70
9/21/2004		52.41	21.71	-	30.70	370	0.76 C	<0.5	25	16	0.50
12/14/2004		52.41	21.20	-	31.21	880	1.0	<0.5	66	52	<0.5

**Table 1**  
**Historical Groundwater Elevation Data and Analytical Results**  
**15101 Freedom Avenue, San Leandro, CA**

Monitoring Well	Date	Casing Elevation <sup>1</sup> (feet)	Depth to Groundwater (feet)	Free-Product (feet)/ Sheen (Y/N)	Groundwater Elevation (feet)	TPH-g (µg/L)	Benzene (µg/L)	Toluene (µg/L)	Ethylbenzene (µg/L)	Total Xylenes (µg/L)	MtBE 8260B <sup>2</sup> (µg/L)
MW-2 cont.	3/11/2005	52.41	19.15	-	33.26	564	<0.5	<0.5	21	11.9	<0.5
	6/15/2005	52.41	20.30	-	32.11	2,040	1.2	<2.0	78.2	22	<0.5
	8/26/2005	52.41	20.97	-	31.44	1,500	0.930	<2.00	87.6	21	0.86
	11/11/2005	52.41	25.30	-	27.11	2,140	1.08	<2.0	104	29	0.79
	2/9/2006	52.41	19.41	-	33.00	1,410	<0.5	<2.0	99.6	21.4	0.72
	5/9/2006	52.41	19.41	-	33.00	1,100	<0.5	<2.0	86.5	17	<0.5
	8/10/2006	52.41	20.8	-	31.61	3,180	2.87	<2.0	88.9	24.8	<0.50
	10/26/2006	52.41	21.22	-	31.19	1,200	<0.5	<2.0	23.5	4.79	0.6
	1/25/2007	52.41	20.89	-	31.52	623	0.64	<2.0	42.4	4.37	0.66
	4/26/2007	52.41	20.65	-	31.76	169	<0.5	<2.0	15.2	2.3	<0.5
	7/25/2007	52.41	21.43	-	30.98	276	0.78	<2.0	22.1	4.04	<0.5
	10/23/2007	52.41	21.59	-	30.82	535	<0.5	<2.0	18	5.11	<0.5
	1/22/2008	52.31	20.45	-	31.86	132	<0.5	<2.0	12.2	<2.0	<0.5
	4/15/2008	52.41	20.89	-	31.52	852	<0.5	<2.0	27.2	4.78	<0.5
	7/2/2008	52.41	21.5	-	30.91	98.3	<0.5	<2.0	2.76	<2.0	<0.5
	10/15/2008	52.41	22.06	-	30.35	1,400 <sup>Y</sup>	<0.5	<0.5	60	17	<0.5
	1/7/2009	52.41	21.35	-	31.06	93	<0.5	<0.5	2.1	0.74	<0.5
	4/13/2009	52.41	20.52	-	31.89	480 <sup>Y</sup>	<0.5	<0.5	20	5.5	<0.5
	8/27/2009	52.41	21.85	-	30.56	130	<0.5	<0.5	2.5	0.61	<0.5
	12/1/2009	52.41	21.59	-	30.82	760 <sup>Y</sup>	<0.5	<0.5	14	1.5	<0.5
	3/17/2010	52.41	20.11	-	32.30	480	<0.5	<0.5	30	6.9	<0.5
	6/3/2010	52.41	21	-	31.41	690	<0.5	<0.5	14	2.6	<0.5
	9/2/2010	52.41	21.42	-	30.99	470	<0.5	<0.5	7.6	1	<0.5
12/2/2010	52.41	21.44	-	30.97	470	<0.5	<0.5	7.6	3.3	<0.5	
3/4/2011	52.41	19.65	N	32.76	240	<0.5	<0.5	6.6	0.8	<0.5	
5/20/2011	52.41	20.75	N	31.66	310	<0.5	<0.5	4.8	<0.5	<0.5	
9/9/2011	52.41	21.05	N	31.36	1,000	<0.5	<0.5	12	0.76	<0.5	
12/2/2011	52.41	20.14	N	32.27	900 <sup>X</sup>	<2.9	<1.7	14	1.9	<3.3	

**Table 1**  
**Historical Groundwater Elevation Data and Analytical Results**  
**15101 Freedom Avenue, San Leandro, CA**

Monitoring Well	Date	Casing Elevation <sup>1</sup> (feet)	Depth to Groundwater (feet)	Free-Product (feet)/ Sheen (Y/N)	Groundwater Elevation (feet)	TPH-g (µg/L)	Benzene (µg/L)	Toluene (µg/L)	Ethyl-benzene (µg/L)	Total Xylenes (µg/L)	MtBE 8260B <sup>2</sup> (µg/L)	
MW-2 cont.	3/2/2012	52.41	19.98	N	32.43	880	<0.5	<0.5	5.3	0.58	<0.5	
	6/7/2012	52.41	21.04	N	31.37	720	<0.5	<0.5	7.9	0.79	<0.5	
	9/21/2012	52.41	21.78	N	30.63	1,400	<0.5	<0.5	11	<0.5	<0.5	
	12/14/2012	52.41	20.71	N	31.70	760	<0.5	<0.5	10	1.5	<0.5	
	3/28/2013	52.41	21.24	N	31.17	890	<0.5	<0.5	4.3	<0.5	<0.5	
	6/11/2013	52.41	21.67	N	30.74	510	150	<0.5	15	12.3	3.1	
	9/16/2013	52.41	22.15	N	30.26	210	<0.5	<0.5	1.1	<0.5	<0.5	
	12/6/2013	52.41	22.52	N	29.89	290	1.4	<0.5	1.1	<0.5	<0.5	
	3/13/2014	52.41	21.56	N	30.85	190	<0.5	<0.5	<0.5	<0.5	<0.5	
	6/6/2014	52.41	21.7	N	30.71	97	<0.5	<0.5	<0.5	<0.5	<0.5	
	<b>Summary Row</b>											
	MW-3	5/10/2002	51.16	22.28	-	28.88	44,000	6,000	900	1,500	6,200	2,400
		8/8/2002	51.16	22.88	-	28.28	40,000	5,800	1,100	1,600	6,500	1,300
11/8/2002		51.16	23.19	-	27.97	47,000	5,300	1,200	2,200	8,600	1,000	
2/21/2003		51.16	22.02	-	29.14	39,000	5,500	1,500	2,000	8,600	1,300	
5/28/2003		51.16	21.89	-	29.27	52,000	7,300	3,000	2,800	12,700	2,100	
8/12/2003		51.16	22.66	-	28.50	31,000	6,100	860	1,500	6,900	1,200	
10/9/2003		51.16	23.06	-	28.10	41,000	6,100	1,100	2,200	10,200	960	
1/15/2004		51.16	21.85	-	29.31	51,000	4,100	1,100	2,000	8,400	590	
5/25/2004		51.16	22.55	-	28.61	65,000	4,300	1,300	2,500	10,500	720	
9/21/2004		53.91	23.08	-	30.83	42,000	4,900	890	2,200	8,700	480	
12/14/2004		53.91	22.52	-	31.39	35,151	4,066	972	2,942	13,032	491	
3/11/2005		53.91	20.90	-	33.01	42,600	3,040	1,100	1,530	6,670	968	
6/15/2005		53.91	21.85	-	32.06	84,100	5,110	2,160	3,030	8,800	2,670	
8/26/2005		53.91	22.49	-	31.42	43,500	3,630	1,080	2,500	6,830	1,440	
11/11/2005		53.91	22.81	-	31.10	47,700	4,240	520	2,170	6,320	1,390	
2/9/2006		53.91	21.12	-	32.79	44,500	5,070	1360	1,920	4,840	3,280	
5/9/2006		53.91	21.09	-	32.82	48,100	2,510	1,140	1,950	5,030	2,210	
8/10/2006	53.91	22.26	-	31.65	42,100	3,450	869	1,760	5,650	3,570		
10/26/2006	53.91	22.73	-	31.18	33,400	4,800	331	1,170	3,510	4,790		



**Table 1**  
**Historical Groundwater Elevation Data and Analytical Results**  
**15101 Freedom Avenue, San Leandro, CA**

Monitoring Well	Date	Casing Elevation <sup>1</sup> (feet)	Depth to Groundwater (feet)	Free-Product (feet)/ Sheen (Y/N)	Groundwater Elevation (feet)	TPH-g (µg/L)	Benzene (µg/L)	Toluene (µg/L)	Ethyl-benzene (µg/L)	Total Xylenes (µg/L)	MtBE 8260B <sup>2</sup> (µg/L)
MW-3 cont.	1/25/2007	53.91	22.34	-	31.57	19,300	4,820	167	1,540	3,740	3,430
	4/26/2007	53.91	22.24	-	31.67	30,700	2,350	158	1,470	4,320	1,330
	7/25/2007	53.91	22.83	-	31.08	34,900	5,400	364	2,080	6,360	1,980
	10/23/2007	53.91	23.01	-	30.9	22,600	4,070	<86	1,120	3,095	970
	1/22/2008	53.96	22.04	-	31.92	22,100	1,280	453	1,330	3,520	490
	4/16/2008	53.91	22.4	-	31.51	20,700	2,790	182	860	3,389	263
	7/3/2008	53.91	22.9	-	31.01	48,500	3,760	346	3,130	12,980	573
	10/16/2008	53.91	23.36	-	30.55	50,000	3,900	300	3,100	11,000	460
	1/8/2009	53.91	22.82	-	31.09	54,000	2,600	180	2,500	8,800	220
	4/13/2009	53.91	22.06	-	31.85	49,000	2,900	170	2,100	8,100	490
	8/27/2009	53.91	23.11	-	30.80	43,000	2,500	160	1,900	7,000	210
	12/2/2009	53.91	23.00	-	30.91	30,000	2,100	180	1,600	5,600	91
	3/17/2010	53.91	21.90	-	32.01	24,000	970	81	1,100	3,700	38
	6/3/2010	53.91	22.49	-	31.42	31,000	1,200	110	1,300	4,400	34
	9/2/2010	53.91	22.76	-	31.15	26,000	1,100	81	1,200	3,810	26
	12/2/2010	53.91	22.86	-	31.05	18,000	830	47	780	2,360	14
	3/4/2011	53.91	21.44	N	32.47	18,000	410	32	850	2,480	16
	5/20/2011	53.91	22.36	N	31.55	12,000	710	24	620	1,460	11
	9/9/2011	53.91	22.44	N	31.47	11,000	1,100	26	580	1,430	7.8
	12/2/2011	53.91	21.60	N	32.31	5,100 <sup>x</sup>	280	12	370	740	<1.7
	3/2/2012	53.91	22.39	N	31.52	13,000	440	23	690	1,570	<5.0
	6/7/2012	53.91	22.50	N	31.41	9,000	290	9.3	520	900	<5.0
	9/21/2012	53.91	23.17	N	30.74	12,000	710	26	630	1,230	8.2
12/14/2012	53.91	22.32	Y	31.59	8,500	350	8.7	550	1,003	<5	
3/28/2013	53.91	22.69	Y	31.22	9,300	790	8.2	760	974	8.7	
6/11/2013	53.91	23.06	Y	30.85	14,000	700	26	860	1,630	6.1	
9/17/2013	53.91	23.41	Y	30.50	28,000	570	37	1,800	3,560	<10	
12/6/2013	53.91	23.76	Y	30.15	23,000	360	26	1,700	3,330	<10	
3/12/2014	53.91	23.13	22.98	30.88	FP	FP	FP	FP	FP	FP	
6/5/2014	53.91	23.08	23.06	30.84	FP	FP	FP	FP	FP	FP	
MW-4	5/10/2002	50.54	21.78	-	28.76	880	25	1.0C	110	52	12,000
	8/8/2002	50.54	22.50	-	28.04	3,800	70	<5.0	300	115	4,800
	11/8/2002	50.54	22.81	-	27.73	5,100	150	10	460	258	2,400

**Table 1**  
**Historical Groundwater Elevation Data and Analytical Results**  
**15101 Freedom Avenue, San Leandro, CA**

Monitoring Well	Date	Casing Elevation <sup>1</sup> (feet)	Depth to Groundwater (feet)	Free-Product (feet)/ Sheen (Y/N)	Groundwater Elevation (feet)	TPH-g (µg/L)	Benzene (µg/L)	Toluene (µg/L)	Ethyl-benzene (µg/L)	Total Xylenes (µg/L)	MtBE 8260B <sup>2</sup> (µg/L)
MW-4 cont.	2/21/2003	50.54	21.48	-	29.06	3,200	98	66	220	360	6,600
	5/28/2003	50.54	21.24	-	29.30	6,200	140	46	200	790	2,300
	8/12/2003	50.54	22.32	-	28.22	7,500	180	57	220	1450	1,900
	10/9/2003	50.54	22.74	-	27.80	5,800	250	32	300	970	7,800
	1/15/2004	50.54	21.19	-	29.35	5,900	270	17 C	150	640	7,300
	5/25/2004	50.54	22.03	-	28.51	9,100	210	51	200	1190	1800
	9/21/2004	53.31	22.76	-	30.55	5,200	290	12	370	600	7300
	12/14/2004	53.31	21.99	-	31.32	8,937	538	114	416	2379	5021
	3/11/2005	53.31	20.01	-	33.30	12,300	225	39.6	80.1	1465	3870
	6/15/2005	53.31	21.25	-	32.06	7,690	114	32.6	77.1	555	1150
	8/26/2005	53.31	22.03	-	31.28	8,850	175	24.6	150	851	1380
	11/11/2005	53.31	22.43	-	30.88	9,990	356	<43	196	700	3,640
	2/9/2006	53.31	20.31	-	33.00	6,850	205	<43	67.2	255.2	5,120
	5/9/2006	53.31	20.33	-	32.98	1,290	18.1	<8.6	12.9	25.87	799
	8/10/2006	53.31	21.74	-	31.57	7,830	118	<8.60	25.3	174.6	919
	10/26/2006	53.31	22.29	-	31.02	1,540	81.9	<43	96	46.4	3,610
	1/25/2007	53.31	21.86	-	31.45	4,370	163	<8.6	85.1	269.1	1,050
	4/26/2007	53.31	21.63	-	31.68	4,380	140	<8.6	67	276.8	576
	7/25/2007	53.31	22.49	-	30.82	4,970	220	<8.60	198	241.5	1,040
	10/23/2007	53.31	22.69	-	30.62	4,200	267	<8.6	147	155.5	1,220
	1/22/2008	53.36	21.39	-	31.97	2,180	133	<22.0	43.1	32.2	1,800
	4/15/2008	53.31	21.9	-	31.41	4,240	90.4	<22.0	107	380	674
	7/2/2008	53.31	22.55	-	30.76	2,300	193	<22.0	212	183	4,050
10/16/2008	53.31	23.13	-	30.18	8,900	320	3.7	430	1,160	450	
1/8/2009	53.31	22.42	-	30.89	19,000	430	44	590	3,380	440	
4/13/2009	53.31	21.51	-	31.80	21,000	400	38	450	2,880	330	
8/27/2009	53.31	22.94	-	30.37	16,000	960	64	560	2,120	290	
12/2/2009	53.31	22.36	-	30.95	4,400	480	6	170	640	110	

**Table 1**  
**Historical Groundwater Elevation Data and Analytical Results**  
**15101 Freedom Avenue, San Leandro, CA**

Monitoring Well	Date	Casing Elevation <sup>1</sup> (feet)	Depth to Groundwater (feet)	Free-Product (feet)/ Sheen (Y/N)	Groundwater Elevation (feet)	TPH-g (µg/L)	Benzene (µg/L)	Toluene (µg/L)	Ethyl-benzene (µg/L)	Total Xylenes (µg/L)	MtBE 8260B <sup>2</sup> (µg/L)
<b>MW-4 cont.</b>	3/17/2010	53.31	21.39	-	31.92	14,000	260	6	230	1,220	93
	6/3/2010	53.31	22.23	-	31.08	18,000	240	4	310	770	41
	9/2/2010	53.31	22.51	-	30.80	1,800	800	<3.6	150	25	33
	12/2/2010	53.31	22.71	-	30.60	3,800	1,500	<10	200	115	29
	3/3/2011	53.31	20.64	N	32.67	2,400	28	<0.71	28	17	3
	5/19/2011	53.31	21.84	N	31.47	1,800	27	<0.5	29	11.2	4.8
	9/8/2011	53.31	22.11	N	31.20	3,600	300	2.6	270	68.5	59
	12/1/2011	53.31	21.38	N	31.93	1,400 <sup>x</sup>	370	<0.84	110	30.6	110
	3/2/2012	53.31	22.02	N	31.29	3,100	780	<2.0	150	59.6	50
	6/7/2012	53.31	22.24	N	31.07	2,000	290	<2.5	66	23	29
	9/21/2012	53.31	22.87	N	30.44	2,900	820	<2.5	75	17	72
	12/14/2012	53.31	21.84	N	31.47	840	48	<0.5	14	4.5	2.5
	3/28/2013	53.31	22.24	N	31.07	790	650	<5.0	26	<5.0	15
	6/11/2013	53.31	22.71	N	30.60	1,100	860	<5.0	64	<5.0	35
	9/17/2013	53.31	23.23	N	30.08	<1,000	1,300	<10	22	<10	44
	12/6/2013	53.31	23.6	N	29.71	2,300	3,300	<10	78	199	42
	3/13/2014	53.31	22.6	N	30.71	<630	600	<6.3	7.0	21	6.8
	<b>6/6/2014</b>	<b>53.31</b>	<b>22.97</b>	<b>N</b>	<b>30.34</b>	<b>&lt;630</b>	<b>710</b>	<b>&lt;6.3</b>	<b>21</b>	<b>&lt;6.3</b>	<b>17.0</b>
	<b>MW-5</b>	5/10/2002	47.79	19.02	-	28.77	25,000	1,000	1200	1,100	3,060
8/8/2002		47.79	19.80	-	27.99	18,000	1,000	660	950	1,720	1,500
11/8/2002		47.79	20.14	-	27.65	16,000	1,300	380	930	1,550	1,200
2/21/2003		47.79	18.70	-	29.09	12,000	390	71	770	1,100	860
5/28/2003		47.79	18.52	-	29.27	9,100	210	31	560	790	600
8/12/2003		47.79	19.54	-	28.25	12,000	660	75	660	1,110	1,000
10/9/2003		47.79	20.06	-	27.73	15,000	1,000	130	1,000	1,430	1,700
1/15/2004		47.79	18.42	-	29.37	9,900	450 C	16	500	431	1,100
5/25/2004		47.79	19.30	-	28.49	9,200	380	24	490	536	720
9/21/2004		50.53	20.15	-	30.38	10,000	980	71	560	770	1200
12/14/2004		50.53	19.30	-	31.23	10,502	587	64	1040	1133	1015
3/11/2005		50.53	17.20	-	33.33	8,390	407	<5.5	83	42.5	1530
6/15/2005		50.53	18.54	-	31.99	9,350	147	18.3	435	146.2	573
8/26/2005		50.53	19.31	-	31.22	9,500	261	<22	726	321.3	749
11/11/2005		50.53	19.75	-	30.78	10,000	443	41.5	527	278.5	1,430

**Table 1**  
**Historical Groundwater Elevation Data and Analytical Results**  
**15101 Freedom Avenue, San Leandro, CA**

Monitoring Well	Date	Casing Elevation <sup>1</sup> (feet)	Depth to Groundwater (feet)	Free-Product (feet)/ Sheen (Y/N)	Groundwater Elevation (feet)	TPH-g (µg/L)	Benzene (µg/L)	Toluene (µg/L)	Ethylbenzene (µg/L)	Total Xylenes (µg/L)	MtBE 8260B <sup>2</sup> (µg/L)
MW-5 cont.	2/9/2006	50.53	17.58	-	32.95	7,640	237	<22	187	50.2	2,050
	5/9/2006	50.53	17.54	-	32.99	8,360	111	<8.6	300	75.84	566
	8/10/2006	50.53	19.02	-	31.51	16,100	250	<22	455	187.4	1,590
	10/26/2006	50.53	19.61	-	30.92	10,100	430	<22	375	192.6	3,060
	1/25/2007	50.53	19.19	-	31.34	3,960	340	<22	323	150.1	1,740
	4/26/2007	50.53	18.89	-	31.64	4,590	187	<8.6	307	116.5	861
	7/25/2007	50.53	19.81	-	30.72	6,490	419	21.8	413	223.2	913
	10/23/2007	50.53	19.98	-	30.55	6,120	550	11	284	141.4	433
	1/22/2008	50.18	18.69	-	31.49	9,810	572	22	574	184.1	126
	4/15/2008	50.18	19.16	-	31.02	8,890	335	15.1	477	397.5	136
	7/3/2008	50.53	19.88	-	30.65	13,100	949	34.4	875	825.5	176
	10/16/2008	50.53	20.45	-	30.08	11,000	870	25	820	668	160
	1/8/2009	50.53	19.72	-	30.81	12,000	490	21	690	456	76
	4/13/2009	50.53	18.81	-	31.72	9,000 <sup>Y</sup>	200	11	390	198	44
	8/27/2009	50.53	21.30	-	29.23	7,400	610	15	320	185	66
	12/2/2009	50.53	20.00	-	30.53	8,400 <sup>Y</sup>	400	12	540	296	45
Pre-MPE	3/17/2010	50.53	18.73	-	31.80	4,800	120	8.7	120	107	14
	6/4/2010	50.53	19.60	-	30.93	7,200	160	5.7	190	149.2	24
	9/2/2010	50.53	19.82	-	30.71	9,200	110	12	270	318	35
	12/2/2010	50.53	20.10	-	30.43	9,100	170	6.7	350	442	23
	3/4/2011	50.53	18.00	N	32.53	2,600	18	0.62	54	18.1	3
	5/20/2011	50.53	19.18	N	31.35	4,000	91	8.5	110	106	33
	8/4/2011	50.53	NM	-	NC	3,000	23	0.95	92	43.7	5.4
	9/9/2011	50.53	19.41	N	31.12	4,200	120	2.8	140	61.1	22
	12/2/2011	50.53	18.59	N	31.94	6,900 <sup>X</sup>	96	12	220	104	32
	3/2/2012	50.53	19.30	N	31.23	5,400	43	1.8	110	85	7
	6/7/2012	50.53	19.45	N	31.08	3,700	32	<1.0	100	59	4.4
	9/21/2012	50.53	20.17	N	30.36	3,900	68	1.5	140	88.5	9.8
	12/14/2012	50.53	19.12	N	31.41	3,100	48	6.7	100	62.3	5.2
	3/28/2013	50.53	19.47	N	31.06	1,900	30	<1.0	59	48.4	4.5
	6/11/2013	50.53	20.03	N	30.50	2,900	22	3.9	110	131	3.0
	9/17/2013	50.53	20.54	N	29.99	4,200	55	7.9	180	229	5.2
	12/6/2013	50.53	20.86	N	29.67	3,600	35	2.1	160	241	2.5
	3/13/2014	50.53	19.91	N	30.62	2,100	23	<1.0	130	73	1.4
	<b>6/6/2014</b>	<b>50.53</b>	<b>20.27</b>	<b>N</b>	<b>30.26</b>	<b>1,700</b>	<b>8.2</b>	<b>0.56</b>	<b>63</b>	<b>40.2</b>	<b>0.75</b>

**Table 1**  
**Historical Groundwater Elevation Data and Analytical Results**  
**15101 Freedom Avenue, San Leandro, CA**

Monitoring Well	Date	Casing Elevation <sup>1</sup> (feet)	Depth to Groundwater (feet)	Free-Product (feet)/ Sheen (Y/N)	Groundwater Elevation (feet)	TPH-g (µg/L)	Benzene (µg/L)	Toluene (µg/L)	Ethyl-benzene (µg/L)	Total Xylenes (µg/L)	MtBE 8260B <sup>2</sup> (µg/L)
MW-6	9/21/2004	45.82	17.64	-	28.18	34,000	150	130	2200	8100	0.6
	12/14/2004	45.82	15.75	-	30.07	5,161	137	7	436	1136	<5.5
	3/11/2005	45.82	13.80	-	32.02	6,040	125	3.22	260	722.1	4.94
	6/15/2005	45.82	14.78	-	31.04	5,590	44.3	6.60	272	382	5.85
	8/26/2005	45.82	15.91	-	29.91	6,130	99	<8.6	378	492.9	5.66
	11/11/2005	45.82	16.55	-	29.27	11,400	101	<8.6	645	834.7	4.33
	2/9/2006	45.82	13.92	-	31.90	2,790	32.3	<8.6	131	131.22	7.30
	5/9/2006	45.82	13.95	-	31.87	3,730	25	<2.0	213	207.82	5.87
	8/10/2006	45.82	15.28	-	30.54	4,800	41.9	<2.0	201	189	10.4
	10/26/2006	45.82	16.11	-	29.71	6,080	37.4	<2.0	116	183	9.78
	1/25/2007	45.82	15.76	-	30.06	3,220	25.2	<2.0	219	174	14.7
	4/26/2007	45.82	15.18	-	30.64	3,110	28	<2.0	165	138.47	14.6
	7/25/2007	45.82	16.82	-	29.00	4,960	54.1	<2.0	199	255.87	8.05
	10/23/2007	45.82	16.91	-	28.91	9,610	64.3	<2.0	188	302.6	5.81
	1/21/2008	45.82	15.36	-	30.46	3,290	33	<2.0	149	131.31	3.86
	4/15/2008	45.82	15.73	-	30.09	2,070	10.8	<2.0	51.1	67	<0.5
	7/2/2008	45.82	16.9	-	28.92	7,900	42.4	<2.0	194	296	3.58
	10/15/2008	45.82	17.21	-	28.61	18,000 <sup>Y</sup>	42	1.4	320	673	1.7
	1/7/2009	45.82	17.08	-	28.74	13,000	47	<3.1	210	425	<3.1
	4/13/2009	45.82	15.52	-	30.30	7,200 <sup>Y</sup>	26	<1.3	170	312.6	2.6
8/26/2009	45.82	17.82	-	28.00	10,000 <sup>Y</sup>	25	<2.0	130	294	2.2	
12/1/2009	45.82	17.34	-	28.48	11,000 <sup>Y</sup>	31	6.1	220	539	<2.0	
3/16/2010	45.82	14.81	-	31.01	31,000	63	140	970	4,200	64	
6/3/2010	45.82	15.72	-	30.10	27,000	22	67	840	3,100	32	
9/1/2010	45.82	16.86	-	28.96	33,000	24	34	1,100	3,780	12	
12/2/2010	45.82	16.98	-	28.84	70,000	32	55	1,700	5,670	18	

**Table 1**  
**Historical Groundwater Elevation Data and Analytical Results**  
**15101 Freedom Avenue, San Leandro, CA**

Monitoring Well	Date	Casing Elevation <sup>1</sup> (feet)	Depth to Groundwater (feet)	Free-Product (feet)/ Sheen (Y/N)	Groundwater Elevation (feet)	TPH-g (µg/L)	Benzene (µg/L)	Toluene (µg/L)	Ethyl-benzene (µg/L)	Total Xylenes (µg/L)	MtBE 8260B <sup>2</sup> (µg/L)
MW-6 cont.	3/3/2011	45.82	14.35	Y	31.47	7,000	18	<2.5	97	237	11
	5/20/2011	45.82	14.95	Y	30.87	14,000	14	<2.5	300	823	7.2
	9/8/2011	45.82	16.14	Y	29.68	23,000	28	<2.5	360	812	3.4
	12/1/2011	45.82	16.17	16.15	29.66	FP	FP	FP	FP	FP	FP
	3/2/2012	45.82	16.11	Y	29.71	14,000	23	<4.2	400	694.4	<4.2
	6/6/2012	45.82	16.31	Y	29.51	9,200	12	<1.7	210	320	<1.7
	9/20/2012*	45.82	17.36	17.32	28.49	FP	FP	FP	FP	FP	FP
	12/13/2012	45.82	15.46	Y	30.36	13,000	22	<0.71	83	62.8	5.1
	3/27/2013	45.82	16.3	Y	29.52	7,400	27	<1.3	190	221.8	<1.3
	6/10/2013	45.82	17.37	Y	28.45	12,000	20	<2.5	280	230	<2.5
	9/16/2013	45.82	18.11	18.06	27.74	FP	FP	FP	FP	FP	FP
	12/5/2013	45.82	18.75	Y	27.07	18,000	220	330	460	2,030	6.1
	3/12/2014	45.82	17	Y	28.82	8,900	42	5.4	290	760	<2.5
	6/5/2014	45.82	18.15	Y	27.67	9,600	29	<2.5	370	295	<2.5
MW-7	9/21/2004	44.74	15.21	-	29.53	2,900	<0.5	<0.5	52	61	8.1
	12/14/2004	44.74	13.90	-	30.84	<50	1.6	<0.5	29	58	6.0
	3/11/2005	44.74	11.46	-	33.28	2,230	<2.5	<2.5	39.4	51.4	12.4
	6/15/2005	44.74	12.97	-	31.77	2,940	0.85	<2.0	50.6	31.9	13.7
	8/26/2005	44.74	14.10	-	30.64	2,310	<0.50	<2.0	55.7	29.6	4.01
	11/11/2005	44.74	14.59	-	30.15	3,030	<0.5	<2.0	66.5	42.3	9.76
	2/9/2006	44.74	NM	-	NM	NA	NA	NA	NA	NA	NA
	5/9/2006	44.74	12.02	-	32.72	1,400	<0.5	<2.0	19.8	12.4	2.30
	8/10/2006	44.74	13.72	-	31.02	604	<0.50	<2.0	6.2	4.63	1.42
	10/26/2006	44.74	14.38	-	30.36	1350	<0.50	<2.0	16.6	10.8	1.87
	1/25/2007	44.74	13.93	-	30.81	340	<0.5	<2.0	6.84	2.44	1.63
	4/26/2007	44.74	14.44	-	30.30	552	<0.5	<2.0	11.4	6.11	4.12
	7/25/2007	44.74	14.79	-	29.95	1,230	<0.5	<2.0	27	19.24	3.2
	10/23/2007	44.74	14.88	-	29.86	1,730	0.67	<2.0	20.7	17.31	8.44
	1/21/2008	44.74	13.34	-	31.40	610	1.15	<2.0	8.4	4.34	17.2
4/15/2008	44.74	13.91	-	30.83	1,460	<0.5	<2.0	15.9	19.7	17.3	
7/2/2008	44.74	14.87	-	29.87	1,450	<0.5	<2.0	11	6.8	22.1	
10/15/2008	44.74	15.68	-	29.06	1,900 <sup>Y</sup>	0.56	1.2	27	39.5	55	

**Table 1**  
**Historical Groundwater Elevation Data and Analytical Results**  
**15101 Freedom Avenue, San Leandro, CA**

Monitoring Well	Date	Casing Elevation <sup>1</sup> (feet)	Depth to Groundwater (feet)	Free-Product (feet)/ Sheen (Y/N)	Groundwater Elevation (feet)	TPH-g (µg/L)	Benzene (µg/L)	Toluene (µg/L)	Ethyl-benzene (µg/L)	Total Xylenes (µg/L)	MtBE 8260B <sup>2</sup> (µg/L)
<b>MW-7 cont.</b>	1/7/2009	44.74	14.72	-	30.02	2,700	1.2	2.9	11	25	39
	4/13/2009	44.74	13.54	-	31.20	2,300 <sup>Y</sup>	<0.5	<0.5	15	6.3	63
	8/26/2009	44.74	15.84	-	28.90	2,700 <sup>Y</sup>	<0.5	<0.5	48	53	140
	12/1/2009	44.74	15.03	-	29.71	1,800 <sup>Y</sup>	<0.5	<0.5	22	15	120
	3/16/2010	44.74	12.56	-	32.18	1,100	<0.5	<0.5	3.2	1.4	65
	6/3/2010	44.74	13.80	-	30.94	740	<0.5	<0.5	1.8	0.62	28
	9/1/2010	44.74	14.84	-	29.90	1,200	<0.5	<0.5	10	3.2	29
	12/2/2010	44.74	14.74	-	30.00	1,400	<0.5	<0.5	8	0.74	21
	3/3/2011	44.74	13.31	N	31.43	1,000	<0.5	<0.5	1.8	<0.5	16
	5/19/2011	44.74	13.43	N	31.31	810	<0.5	<0.5	2.2	0.79	7.8
	9/8/2011	44.74	14.38	N	30.36	1,000	<0.5	<0.5	8.3	2.9	5.4
	12/1/2011	44.74	13.57	N	31.17	1,500 <sup>X</sup>	<0.33	<0.19	12	5.7	13
	3/2/2012	44.74	14.16	N	30.58	1,000	<0.5	<0.5	4	1.1	5.1
	6/6/2012	44.74	14.00	N	30.74	780	<0.5	<0.5	2.9	1.0	2.6
	9/20/2012	44.74	15.26	N	29.48	1,200	<0.5	<0.5	4.3	0.92	2.7
	12/13/2012	44.74	13.34	N	31.40	1,100	<0.5	<0.5	0.99	<0.5	3.4
	3/27/2013	44.74	14.30	N	30.44	680	<0.5	<0.5	1.8	<0.5	4.2
	6/10/2013	44.74	15.06	N	29.68	890	<0.5	<0.5	2.6	<0.5	2.3
	9/16/2013	44.74	15.78	N	28.96	1,400	<0.5	<0.5	7.9	2.7	4.1
	12/5/2013	44.74	16.21	N	28.53	1,800	<0.5	<0.5	8	3.1	5.7
3/12/2014	44.74	14.56	N	30.18	920	<0.5	<0.5	3.7	1.5	4.6	
<b>6/5/2014</b>	<b>44.74</b>	<b>15.18</b>	<b>N</b>	<b>29.56</b>	<b>1,600</b>	<b>&lt;0.5</b>	<b>&lt;0.5</b>	<b>11</b>	<b>3.0</b>	<b>5.7</b>	
<b>MW-8</b>	9/21/2004	41.14	12.98	-	28.16	<50	<0.5	<0.5	<0.5	<0.5	<0.5
	12/14/2004	41.14	11.22	-	29.92	<50	<0.5	<0.5	<0.5	<1.0	<0.5
	3/11/2005	41.14	NM	-	NM	NA	NA	NA	NA	NA	NA
	6/15/2005	41.14	10.46	-	30.68	<200	0.53	<2.0	<0.5	<1.0	<0.5
	8/26/2005	41.14	11.53	-	29.61	<50	<0.50	<2.0	<0.50	<1.0	<0.50
	11/11/2005	41.14	11.92	-	29.22	<50	<0.5	<2.0	1.36	1.8	<0.5
	2/9/2006	41.14	9.74	-	31.40	<50	<0.50	<2.0	<0.50	<1.0	<0.50
	5/9/2006	41.14	9.90	-	31.24	<50	<0.50	<2.0	<0.50	<1.0	<0.50
	8/10/2006	41.14	10.9	-	30.24	<50	<0.50	<2.0	<0.50	<1.0	<0.50
	10/26/2006	41.14	11.68	-	29.46	<50	<0.50	<2.0	3.37	<1.0	<0.50

**Table 1**  
**Historical Groundwater Elevation Data and Analytical Results**  
**15101 Freedom Avenue, San Leandro, CA**

Monitoring Well	Date	Casing Elevation <sup>1</sup> (feet)	Depth to Groundwater (feet)	Free-Product (feet)/ Sheen (Y/N)	Groundwater Elevation (feet)	TPH-g (µg/L)	Benzene (µg/L)	Toluene (µg/L)	Ethyl-benzene (µg/L)	Total Xylenes (µg/L)	MtBE 8260B <sup>2</sup> (µg/L)	
MW-8 cont.	1/25/2007	41.14	11.44	-	29.70	<50	<0.5	<2.0	<0.5	<2.0	<0.5	
	4/26/2007	41.14	10.81	-	30.33	<50	<0.5	<2.0	4.29	<2.0	<0.5	
	7/25/2007	41.14	12.31	-	28.83	<50	<0.5	<2.0	4.39	<2.0	<0.5	
	10/23/2007	41.14	12.37	-	28.77	<50	<0.5	<2.0	4.31	<2.0	<0.5	
	1/21/2008	41.14	11.02	-	30.12	<50	<0.5	<2.0	<0.5	<2.0	<0.5	
	4/15/2008	41.14	11.44	-	29.70	<50	<0.5	<2.0	<0.5	<2.0	<0.5	
	7/2/2008	41.14	12.39	-	28.75	94.8	<0.5	<2.0	1	<2.0	<0.5	
	10/15/2008	41.14	13.42	-	27.72	<50	<0.5	<0.5	<0.5	<0.5	<0.5	
	1/7/2009	41.14	12.50	-	28.64	<50	<0.5	<0.5	<0.5	0.6	<0.5	
	4/13/2009	41.14	11.23	-	29.91	<50	<0.5	<0.5	<0.5	<0.5	<0.5	
	8/27/2009	41.14	13.24	-	27.90	<50	<0.5	<0.5	<0.5	<0.5	<0.5	
	Well Decommissioned 11/13/2009											
	MW-9	9/21/2004	40.26	12.18	-	28.08	<50	<0.5	<0.5	<0.5	<0.5	<0.5
12/14/2004		40.26	10.91	-	29.35	<50	<0.5	<0.5	<0.5	<1.0	<0.5	
3/11/2005		40.26	10.52	-	29.74	<200	<0.5	<0.5	<0.5	<1.0	<0.5	
6/15/2005		40.26	14.73	-	25.53	<200	<0.5	<2.0	<0.5	<1.0	<0.5	
8/26/2005		40.26	10.59	-	29.67	<50	<0.50	<2.0	<0.50	<1.0	<0.50	
11/11/2005		40.26	11.25	-	29.01	<50	<0.5	<2.0	<0.5	<1.0	<0.5	
2/9/2006		40.26	10.05	-	30.21	<50	<0.50	<2.0	<0.50	<1.0	<0.50	
5/9/2006		40.26	9.06	-	31.20	<50	<0.50	<2.0	<0.50	<1.0	<0.50	
8/10/2006		40.26	10.01	-	30.25	<50	<0.50	<2.0	<0.50	<1.0	<0.50	
10/26/2006		40.26	10.81	-	29.45	<50	<0.50	<2.0	<0.50	<1.0	<0.50	
1/25/2007		40.26	10.67	-	29.59	<50	<0.5	<2.0	<0.5	<2.0	<0.5	
4/26/2007		40.26	10.05	-	30.21	<50	<0.5	<2.0	<0.5	<2.0	<0.5	
7/25/2007		40.26	11.44	-	28.82	<50	<0.5	<2.0	<0.5	<2.0	<0.5	
10/23/2007		40.26	11.59	-	28.67	<50	<0.5	<2.0	<0.5	<2.0	<0.5	
1/21/2008		40.26	10.37	-	29.89	<50	<0.5	<2.0	<0.5	<2.0	<0.5	
4/15/2008		40.26	10.56	-	29.70	<50	<0.5	<2.0	<0.5	<2.0	<0.5	
7/2/2008	40.26	11.95	-	28.31	161	<0.5	<2.0	2.15	<2.0	<0.5		
10/15/2008	40.26	12.64	-	27.62	<50	<0.5	<0.5	<0.5	<0.5	<0.5		



**Table 1**  
**Historical Groundwater Elevation Data and Analytical Results**  
**15101 Freedom Avenue, San Leandro, CA**

Monitoring Well	Date	Casing Elevation <sup>1</sup> (feet)	Depth to Groundwater (feet)	Free-Product (feet)/ Sheen (Y/N)	Groundwater Elevation (feet)	TPH-g (µg/L)	Benzene (µg/L)	Toluene (µg/L)	Ethylbenzene (µg/L)	Total Xylenes (µg/L)	MtBE 8260B <sup>2</sup> (µg/L)
MW-9 cont.	1/7/2009	40.26	11.75	-	28.51	<50	<0.5	<0.5	<0.5	<0.5	<0.5
	4/13/2009	40.26	10.89	-	29.37	<50	<0.5	<0.5	<0.5	<0.5	<0.5
	8/26/2009	40.26	12.50	-	27.76	<50	<0.5	<0.5	<0.5	<0.5	<0.5
<b>Well Decommissioned 11/13/2009</b>											
<b>Extraction Wells</b>											
EX-1	12/2/2009	47.36	17.02	-	30.34	2,900	120	4	64	410	25
	3/16/2010	47.36	19.08	-	28.28	2,200	150	18	94	326	210
	6/3/2010	47.36	17.02	-	30.34	3,600	180	6.3	150	428	83
	9/1/2010	47.36	16.88	-	30.48	550	6.5	0.5	6.9	31.7	38
	12/2/2010	47.36	19.84	-	27.52	<200	3.1	<2.0	<2.0	<2.0	210
	3/3/2011	47.36	14.96	N	32.4	530	51	0.94	15	31.3	110
	5/19/2011	47.36	16.12	N	31.24	370	42	<0.71	7.6	17.2	110
	9/8/2011	47.36	16.47	N	30.89	110	5	<0.5	2.2	6.4	12
	12/1/2011	47.36	16.1	N	31.26	780 <sup>x</sup>	91	3	29	85	150
	3/2/2012	47.36	16.35	N	31.01	140	6	<0.5	3.5	8	14
	6/6/2012	47.36	24.76	N	22.6	250	22	<0.5	4.7	20	71
	9/20/2012	47.36	17.26	N	30.1	95	24	<0.5	<0.5	2.61	36
	12/13/2012	47.36	16.55	N	30.81	1,000	73	2.3	47	110	48
	3/27/2013	47.36	16.15	N	31.21	69	4.1	<0.5	3.3	10	1.8
	6/10/2013	47.36	24.25	N	23.11	340	37	<0.5	5.9	15.1	62
9/16/2013	47.36	22.54	N	24.82	97	14	<0.5	<0.5	<0.5	65	
12/5/2013	47.36	22.53	N	24.83	390	42	2.5	9.8	32.6	76	
3/12/2014	47.36	21.15	N	26.21	250	12	<0.5	4.7	17.2	40	
<b>6/5/2014</b>	<b>47.36</b>	<b>21.31</b>	<b>N</b>	<b>26.05</b>	<b>1,700</b>	<b>70</b>	<b>11</b>	<b>92</b>	<b>208</b>	<b>40</b>	
EX-2	12/2/2009	45.96	17.56	-	28.4	7,100 <sup>Y</sup>	9.3	3.2	440	770	<3.1
	3/16/2010	45.96	19.65	-	26.31	13,000	600	360	770	2,250	15
	6/3/2010	45.96	17.10	-	28.86	16,000	590	400	700	2,500	9.5
	9/1/2010	45.96	16.99	-	28.97	6,100	230	74	200	890	11
	12/2/2010	45.96	20.87	-	25.09	14,000	510	270	640	2,170	15
	3/3/2011	45.96	14.61	N	31.35	8,600	340	52	460	1,350	13
	5/19/2011	45.96	15.08	N	30.88	7,500	260	65	390	1,080	11
	9/8/2011	45.96	16.34	N	29.62	3,400	190	28	160	451	5.4
	12/1/2011	45.96	22.60	N	23.36	9,900 <sup>x</sup>	630	200	690	1,760	<3.3

**Table 1**  
**Historical Groundwater Elevation Data and Analytical Results**  
**15101 Freedom Avenue, San Leandro, CA**

Monitoring Well	Date	Casing Elevation <sup>1</sup> (feet)	Depth to Groundwater (feet)	Free-Product (feet)/ Sheen (Y/N)	Groundwater Elevation (feet)	TPH-g (µg/L)	Benzene (µg/L)	Toluene (µg/L)	Ethyl-benzene (µg/L)	Total Xylenes (µg/L)	MtBE 8260B <sup>2</sup> (µg/L)	
EX-2 cont.	3/2/2012	45.96	16.48	N	29.48	5,000	220	25	200	600	7.1	
	6/6/2012	45.96	18.90	N	27.06	6,900	290	97	310	790	5.2	
	9/20/2012	45.96	17.49	N	28.47	1,800	170	14	62	204	5.0	
	12/13/2012	45.96	15.96	N	30	7,300	490	180	610	1,290	5.2	
	3/27/2013	45.96	16.59	N	29.37	2,200	130	9.6	100	288	4.3	
	6/10/2013	45.96	23.11	N	22.85	2,600	190	20	100	248	6.8	
	9/20/2013	45.96	23.11	N	22.85	3,900	210	37	170	450	6.3	
	12/5/2013	45.96	23.28	N	22.68	3,700	160	46	110	394	7.2	
	3/12/2014	45.96	22.04	N	23.92	3,700	100	9.8	220	498	5.7	
	6/5/2014	45.96	23.41	N	22.55	4,400	120	37	280	590	5.4	
	<b>MPE Wells</b>											
	MPE-1	12/1/2009	51.96	21.41	-	30.55	NA	NA	NA	NA	NA	NA
		3/16/2010	51.96	20.22	-	31.74	NA	NA	NA	NA	NA	NA
6/3/2010		51.96	21.18	-	30.78	NA	NA	NA	NA	NA	NA	
9/1/2010		51.96	21.25	-	30.71	NA	NA	NA	NA	NA	NA	
12/2/2010		51.96	21.64	-	30.32	NA	NA	NA	NA	NA	NA	
Pre-MPE	3/3/2011	51.96	19.33	-	32.63	NA	NA	NA	NA	NA	NA	
	5/19/2011	51.96	20.6	-	31.36	NA	NA	NA	NA	NA	NA	
	8/4/2011	51.96	NM	-	NC	49,000	210	100	840	7,070	45	
Post-MPE	9/8/2011	51.96	20.83	-	31.13	NA	NA	NA	NA	NA	NA	
	9/26/2011	51.96	20.94	Y	31.02	62,000	6,300	3,700	1,800	9,400	1,200	
	12/2/2011	51.96	20.14	Y	31.82	56,000	9,000	7,700	2,200	10,800	2,600	
	3/2/2012	51.96	20.73	Y	31.23	97,000	11,000	11,000	2,600	12,600	2,700	
	6/6/2012	51.96	20.96	Y	31.00	78,000	4,500	4,900	2,300	10,700	750	
	9/20/2012	51.96	21.58	Y	30.38	89,000	8,600	9,200	3,400	14,800	1,900	
	12/14/2012	51.96	20.57	Y	31.39	98,000	7,400	9,600	2,900	13,300	1,300	
	3/27/2013	51.96	20.91	Y	31.05	61,000	6,600	4,500	2,200	9,400	1,500	
	6/10/2013	51.96	21.47	Y	30.49	42,000	1,900	980	630	4,400	670	
	9/17/2013	51.96	21.98	Y	29.98	45,000	2,400	1,400	1,200	8,000	150	
12/6/2013	51.96	22.41	Y	29.55	27,000	1,600	220	990	5,000	110		
3/13/2014	51.96	21.33	Y	30.63	67,000	1,800	3,500	1,800	10,100	170		
6/5/2014	51.96	21.89	21.8	30.13	FP	FP	FP	FP	FP	FP		
<b>MPE-2</b>												
MPE-2	12/1/2009	53.72	22.87	-	30.85	NA	NA	NA	NA	NA	NA	

**Table 1**  
**Historical Groundwater Elevation Data and Analytical Results**  
**15101 Freedom Avenue, San Leandro, CA**

Monitoring Well	Date	Casing Elevation <sup>1</sup> (feet)	Depth to Groundwater (feet)	Free-Product (feet)/ Sheen (Y/N)	Groundwater Elevation (feet)	TPH-g (µg/L)	Benzene (µg/L)	Toluene (µg/L)	Ethyl-benzene (µg/L)	Total Xylenes (µg/L)	MtBE 8260B <sup>2</sup> (µg/L)	
MPE-2 cont.	3/16/2010	53.72	21.7	-	32.02	NA	NA	NA	NA	NA	NA	
	6/3/2010	53.72	22.35	-	31.37	NA	NA	NA	NA	NA	NA	
	9/1/2010	53.72	23.7	-	30.02	NA	NA	NA	NA	NA	NA	
	12/2/2010	53.72	22.7	-	31.02	NA	NA	NA	NA	NA	NA	
	Pre-MPE	3/3/2011	53.72	21.25	-	32.47	NA	NA	NA	NA	NA	NA
		5/19/2011	53.72	22.19	-	31.53	NA	NA	NA	NA	NA	NA
		8/4/2011	53.72	NM	-	NC	46,000	2,100	80	1,900	5,300	75
	Post-MPE	9/8/2011	53.72	22.31	-	31.41	NA	NA	NA	NA	NA	NA
		9/26/2011	53.72	22.38	N	31.34	37,000	1,800	33	1,700	2,760	<17
		12/2/2011	53.72	21.44	N	32.28	26,000	1,600	43	1,800	3,370	<17
		3/2/2012	53.72	22.24	N	31.48	36,000	1,100	19	1,700	2,970	<17
		6/7/2012	53.72	22.35	N	31.37	33,000	1,800	27	1,600	2,700	29
		9/21/2012	53.72	23.03	N	30.69	31,000	1,700	13	1,900	2,747	14
		12/14/2012	53.72	22.17	N	31.55	31,000	1,700	20	1,800	2,490	16
		3/28/2013	53.72	22.53	N	31.19	20,000	2,200	<20	1,300	960	<20
		6/11/2013	53.72	22.9	N	30.82	26,000	920	<13	1,500	1,352	<13
		9/17/2013	53.72	23.29	N	30.43	23,000	680	15	1,400	1,059	<13
	12/5/2013	53.72	23.73	23.61	30.07	FP	FP	FP	FP	FP	FP	
	3/12/2014	53.72	22.89	22.85	30.86	FP	FP	FP	FP	FP	FP	
6/5/2014	53.72	22.96	22.94	30.77	FP	FP	FP	FP	FP	FP		
<b>2nd WBZ</b>												
MW-1D	1/3/2008	54.42		-	-	<50	<0.50	<2.0	<0.50	<2.0	<0.50	
	1/22/2008	54.42	22.85	-	31.57	<50	<0.50	<2.0	<0.50	<2.0	<0.50	
	4/16/2008	54.42	23.10	-	31.32	<50	<0.5	<2.0	<0.5	<2.0	<0.5	
	7/3/2008	54.42	23.44	-	30.98	75.9	<0.5	<2.0	0.54	<2.0	<0.5	
	10/15/2008	54.42	23.82	-	30.60	120	1.6	<0.5	2.8	3.6	<0.5	
	1/8/2009	54.42	23.44	-	30.98	<50	<0.5	<0.5	<0.5	<0.5	<0.5	
	4/14/2009	54.42	23.06	-	31.36	<50	<0.5	<0.5	<0.5	<0.5	<0.5	
	8/26/2009	54.42	23.73	-	30.69	<50	<0.5	<0.5	<0.5	<0.5	<0.5	
	12/1/2009	54.42	23.59	-	30.83	330 <sup>Y</sup>	<0.5	<0.5	1.3	2.2	<0.5	
	3/16/2010	54.42	22.60	-	31.82	<50	<0.5	<0.5	<0.5	<0.5	<0.5	
	6/4/2010	54.42	23.10	-	31.32	<50	<0.5	<0.5	<0.5	<0.5	<0.5	
	9/1/2010	54.42	23.51	-	30.91	<50	<0.5	<0.5	0.52	1.8	<0.5	
	12/3/2010	54.42	23.41	-	31.01	61	<0.5	<0.5	1.0	3.73	<0.5	

**Table 1**  
**Historical Groundwater Elevation Data and Analytical Results**  
15101 Freedom Avenue, San Leandro, CA

Monitoring Well	Date	Casing Elevation <sup>1</sup> (feet)	Depth to Groundwater (feet)	Free-Product (feet)/ Sheen (Y/N)	Groundwater Elevation (feet)	TPH-g (µg/L)	Benzene (µg/L)	Toluene (µg/L)	Ethyl-benzene (µg/L)	Total Xylenes (µg/L)	MtBE 8260B <sup>2</sup> (µg/L)
MW-1D cont.	3/3/2011	54.42	22.27	N	32.15	<50	<0.5	<0.5	<0.5	<0.5	<0.5
	5/19/2011	54.42	22.89	N	31.53	<50	<0.5	<0.5	<0.5	<0.5	<0.5
	9/8/2011	54.42	23.08	N	31.34	220	<0.5	<0.5	0.6	1.4	<0.5
	12/1/2011	54.42	22.26	N	32.16	<22	<0.33	<0.19	<0.15	<0.20	<0.38
	3/2/2012	54.42	23.01	N	31.41	<50	<0.5	<0.5	<0.5	<0.5	<0.5
	6/6/2012	54.42	23.18	N	31.24	<50	<0.5	<0.5	<0.5	<0.5	<0.5
	9/20/2012	54.42	23.76	N	30.66	<50	<0.5	<0.5	<0.5	<0.5	<0.5
	12/13/2012	54.42	23.04	N	31.38	<50	<0.5	<0.5	<0.5	<0.5	<0.5
	3/27/2013	54.42	23.34	N	31.08	<50	<0.5	<0.5	<0.5	<0.5	<0.5
	6/10/2013	54.42	23.69	N	30.73	110	<0.5	<0.5	0.55	<0.5	<0.5
	9/16/2013	54.42	24.02	N	30.40	<50	<0.5	<0.5	<0.5	<0.5	<0.5
	12/5/2013	54.42	24.31	N	30.11	<50	<0.5	<0.5	<0.5	1.3	<0.5
	3/12/2014	54.42	23.68	N	30.74	<50	<0.5	<0.5	<0.5	<0.5	<0.5
	<b>6/5/2014</b>	<b>54.42</b>	<b>23.68</b>	<b>N</b>	<b>30.74</b>	<b>&lt;50</b>	<b>&lt;0.5</b>	<b>&lt;0.5</b>	<b>&lt;0.5</b>	<b>&lt;0.5</b>	<b>&lt;0.5</b>
MW-3D	1/3/2008	54.10		-	-	<50	<0.50	<2.0	<0.50	<2.0	87.6
	1/22/2008	54.10	22.31	-	31.79	<50	<0.50	<2.0	<0.50	<2.0	88.3
	4/16/2008	54.10	22.64	-	31.46	<50	<0.5	<2.0	<0.5	<2.0	71.1
	7/3/2008	54.10	23.17	-	30.93	<50	<0.5	<2.0	<0.5	<2.0	67.4
	10/16/2008	54.10	23.62	-	30.48	<50	<0.5	<0.5	<0.5	<0.5	37
	1/8/2009	54.10	23.07	-	31.03	<50	<0.5	<0.5	<0.5	<0.5	29
	4/14/2009	54.10	22.36	-	31.74	<50	<0.5	<0.5	<0.5	<0.5	44
	8/26/2009	54.10	23.41	-	30.69	<50	<0.5	<0.5	<0.5	<0.5	20
	12/1/2009	54.10	23.27	-	30.83	110 Y	<0.5	<0.5	<0.5	0.52	24
	3/16/2010	54.10	22.10	-	32.00	<50	<0.5	<0.5	<0.5	<0.5	7.1
	6/4/2010	54.10	22.70	-	31.40	<50	<0.5	<0.5	<0.5	<0.5	17
	9/1/2010	54.10	23.09	-	31.01	78	<0.5	<0.5	1.1	4.71	24
	12/3/2010	54.10	22.90	-	31.20	<50	<0.5	<0.5	0.56	1.4	13
	3/3/2011	54.10	21.66	N	32.44	<50	1.3	<0.5	<0.5	0.59	14
	5/19/2011	54.10	22.61	N	31.49	<50	<0.5	<0.5	<0.5	<0.5	5.2
	9/8/2011	54.10	22.68	N	31.42	69	<0.5	<0.5	<0.5	0.62	4.8
	12/1/2011	54.10	22.86	N	31.24	<22	<0.33	<0.19	<0.15	<0.20	10
	3/2/2012	54.10	22.60	N	31.50	<50	<0.5	<0.5	<0.5	<0.5	4.2
	6/6/2012	54.10	22.77	N	31.33	<50	<0.5	<0.5	<0.5	<0.5	4.8
	9/20/2012	54.10	23.42	N	30.68	<50	<0.5	<0.5	<0.5	<0.5	5.1
12/13/2012	54.10	22.57	N	31.53	<50	<0.5	<0.5	<0.5	<0.5	4.4	

**Table 1**  
**Historical Groundwater Elevation Data and Analytical Results**  
**15101 Freedom Avenue, San Leandro, CA**

Monitoring Well	Date	Casing Elevation <sup>1</sup> (feet)	Depth to Groundwater (feet)	Free-Product (feet)/ Sheen (Y/N)	Groundwater Elevation (feet)	TPH-g (µg/L)	Benzene (µg/L)	Toluene (µg/L)	Ethyl-benzene (µg/L)	Total Xylenes (µg/L)	MtBE 8260B <sup>2</sup> (µg/L)
MW-3D cont.	3/27/2013	54.10	22.87	N	31.23	<50	<0.5	<0.5	<0.5	<0.5	4.4
	6/10/2013	54.10	23.27	N	30.83	<50	<0.5	<0.5	<0.5	<0.5	3.5
	9/16/2013	54.10	23.65	N	30.45	<50	<0.5	<0.5	<0.5	<0.5	2.1
	12/5/2013	54.10	23.97	N	30.13	<50	<0.5	<0.5	<0.5	0.53	1.6
	3/13/2014	54.10	23.22	N	30.88	130	<0.5	2.9	2.5	16.6	0.97
	<b>6/5/2014</b>	<b>54.10</b>	<b>23.33</b>	<b>N</b>	<b>30.77</b>	<b>&lt;50</b>	<b>&lt;0.5</b>	<b>&lt;0.5</b>	<b>&lt;0.5</b>	<b>0.77</b>	<b>1.5</b>
MW-4D	1/4/2008	53.12		-	-	<50	<0.50	<2.0	<0.50	<2.0	<0.50
	1/22/2008	53.12	21.11	-	32.01	91.5	18.7	<2.0	7.08	11.42	219
	4/15/2008	53.12	21.67	-	31.45	<50	<0.5	<2.0	<0.5	<2.0	27
	7/3/2008	53.12	22.39	-	30.73	<50	<0.5	<2.0	<0.5	<2.0	6.27
	10/16/2008	53.12	22.98	-	30.14	<50	<0.5	<0.5	<0.5	<0.5	1.9
	1/8/2009	53.12	22.25	-	30.87	<50	<0.5	<0.5	<0.5	<0.5	2
	4/14/2009	53.12	21.34	-	31.78	<50	<0.5	<0.5	<0.5	<0.5	2.2
	8/27/2009	53.12	22.79	-	30.33	<50	<0.5	<0.5	<0.5	<0.5	2.2
	12/1/2009	53.12	22.49	-	30.63	120 <sup>Y</sup>	<0.5	<0.5	1.4	2.3	2.3
	3/16/2010	53.12	21.02	-	32.10	<50	<0.5	<0.5	<0.5	<0.5	0.65
	6/4/2010	53.12	21.93	-	31.19	<50	<0.5	<0.5	<0.5	<0.5	1.1
	9/1/2010	53.12	23.32	-	29.80	<50	<0.5	<0.5	0.85	3.76	2.2
	12/3/2010	53.12	22.46	-	30.66	<50	<0.5	<0.5	<0.5	0.67	<0.5
	3/3/2011	53.12	20.45	N	32.67	<50	<0.5	<0.5	<0.5	<0.5	0.58
	5/19/2011	53.12	21.57	N	31.55	<50	<0.5	<0.5	<0.5	<0.5	<0.5
	9/8/2011	53.12	21.92	N	31.20	59	<0.5	<0.5	<0.5	0.51	1.7
	12/1/2011	53.12	21.19	N	31.93	<22	<0.33	<0.19	<0.15	<0.20	4.2
	3/2/2012	53.12	21.8	N	31.32	<50	<0.5	<0.5	0.85	1.2	2.7
	6/6/2012	53.12	22.00	N	31.12	<50	<0.5	<0.5	<0.5	<0.5	1.3
	9/20/2012	53.12	22.67	N	30.45	<50	<0.5	<0.5	<0.5	<0.5	1.6
	12/13/2012	53.12	21.55	N	31.57	<50	<0.5	<0.5	<0.5	<0.5	0.94
	3/27/2013	53.12	21.98	N	31.14	<50	<0.5	<0.5	<0.5	<0.5	2.1
	6/10/2013	53.12	22.55	N	30.57	<50	<0.5	<0.5	<0.5	<0.5	1.7
9/16/2013	53.12	23.05	N	30.07	<50	<0.5	<0.5	<0.5	<0.5	4.6	
12/6/2013	53.12	23.43	N	29.69	<50	<0.5	<0.5	<0.5	<0.5	3.4	
3/13/2014	53.12	22.38	N	30.74	<50	<0.5	<0.5	<0.5	<0.5	4.0	
<b>6/6/2014</b>	<b>53.12</b>	<b>22.78</b>	<b>N</b>	<b>30.34</b>	<b>&lt;50</b>	<b>&lt;0.5</b>	<b>&lt;0.5</b>	<b>&lt;0.5</b>	<b>&lt;0.5</b>	<b>1.8</b>	

**Table 1**  
**Historical Groundwater Elevation Data and Analytical Results**  
**15101 Freedom Avenue, San Leandro, CA**

Monitoring Well	Date	Casing Elevation <sup>1</sup> (feet)	Depth to Groundwater (feet)	Free-Product (feet)/ Sheen (Y/N)	Groundwater Elevation (feet)	TPH-g (µg/L)	Benzene (µg/L)	Toluene (µg/L)	Ethyl-benzene (µg/L)	Total Xylenes (µg/L)	MtBE 8260B <sup>2</sup> (µg/L)
1573 153 RD	1/3/2008	NS	NM	-	NC	<50	<0.5	<2.0	<0.5	<2.0	<0.5
	7/2/2008	NS	NM	-	NC	<50	<0.5	<2.0	<0.5	<2.0	<0.5
	10/16/2008	NS	NM	-	NC	<50	<0.5	<0.5	<0.5	<0.5	<0.5
<b>Equipment Blanks</b>											
EB-PMP	1/21/2008	-	-	-	-	<50	<0.50	<2.0	<0.50	<2.0	<0.50
EB-PRB	1/21/2008	-	-	-	-	<50	<0.50	<2.0	<0.50	<2.0	<0.50
EB-PMP2	1/22/2008	-	-	-	-	<50	<0.50	<2.0	<0.50	<2.0	<0.50
EB-PRB2	1/22/2008	-	-	-	-	<50	<0.50	<2.0	<0.50	<2.0	<0.50
ESL (ug/L)	-	-	-	-	-	100	1	40	30	20	5

Notes:

The first time SOMA monitored this Site was in May 2002.

\*: Due to minimal recharge rates in well MW-2, the groundwater elevation recorded on these dates did not match the overall site conditions, May 2002 & August 2003.

NC: Not Calculated

<sup>1</sup>: Top of casing elevations were surveyed to a datum of 67.07 M.S.L by Kier & Wright Civil Engineers & Land Surveyors on May 7, 2002.

On October 11, 2004, the site was re-surveyed by Harrington Surveys, Inc. of Walnut Creek, CA to a datum of California Coordinate System, Zone 3, NAD 83.

<sup>2</sup> MtBE analyzed by EPA Method 8021B, and confirmed by EPA Method 8260B.

<: Not detected above the laboratory reporting limit.

Y: Sample exhibits chromatographic pattern which does not resemble standard

<sup>c</sup> Presence confirmed, but confirmation concentration differed by more than a factor of two.

C: Presence confirmed, but RPD between columns exceeds 40%.

H: Heavier hydrocarbons contributed to the quantitation.

x: Does not match pattern of reference Gasoline Standard. Hydrocarbons in the range of C5-C12 quantified as gasoline (possibly aged gasoline)

NA: Not Analyzed. Well MW-8 was inaccessible during the First Quarter 2005, car was parked over well.  
 Not Analyzed. Well MW-7 was inaccessible during the First Quarter 2006, car was parked over well.

NM: Not Measured. Well MW-8 was inaccessible during the First Quarter 2005, car was parked over well.  
 Not Measured. Well MW-7 was inaccessible during the First Quarter 2006, car was parked over well.

The first time SOMA monitored wells MW-6 to MW-9 was in September 2004.

EB-PMP/EB-PRB: Equipment Blanks for Pump and Probe

ESL: Environmental Screening Levels per CRWQCB SFBay Region Interim Final Nov. 2007 (Revised May 2008);  
 Table F-1a, Groundwater Screening Levels (groundwater is a current or potential drinking water resource)

MW-8 and MW-9 were decommissioned November 13, 2009

FP: Groundwater not sampled due to presence of free-product  
 Groundwater elevation corrected upon presence of FP as follows:  
 Corrected depth to groundwater is equal to (measured depth)- 0.68/(free product thickness)  
 The correction factor is derived by the following: specific gravity of gas at 20 °C is 0.68, then specific gravity is multiplied by the thickness of free product

**Table 2**  
**Historical Gasoline Oxygenates Results**  
**15101 Freedom Avenue, San Leandro, CA**

Monitoring Well	Date	TBA (µg/L)	DIPE (µg/L)	ETBE (µg/L)	TAME (µg/L)	1,2-DCA (µg/L)	EDB (µg/L)
<b>1st WBZ</b>							
<b>MW-1</b>	8/8/2002	78	<1.3	<1.3	<1.3	NA	NA
	11/1/2002	42	< 1.0	< 1.0	< 1.0	NA	NA
	2/21/2003	47	<0.5	<0.5	<0.5	NA	NA
	5/28/2003	25	<0.5	<0.5	<0.5	NA	NA
	8/12/2003	<10	<0.5	<0.5	<0.5	NA	NA
	10/9/2003	70	<1.0	<1.0	<1.0	NA	NA
	1/15/2004	55	<0.5	<0.5	<0.5	NA	NA
	5/25/2004	62	<0.7	<0.7	<0.7	NA	NA
	9/21/2004	<10	<0.5	<0.5	<0.5	NA	NA
	12/14/2004	<21.5	<4.3	<4.3	<17.2	NA	NA
	3/11/2005	81	<0.5	<0.5	<2.0	NA	NA
	6/15/2005	<10	<0.5	<0.5	<2.0	NA	NA
	8/26/2005	68.9	<2.15	<2.15	<8.6	NA	NA
	11/11/2005	46	<2.15	<2.15	<8.6	NA	NA
	2/9/2006	11.3	<0.5	<0.5	<2.0	NA	NA
	5/9/2006	<10	<0.5	<0.5	<2.0	0.51	<0.5
	8/10/2006	<43	<2.15	<2.15	<8.60	3.37	<2.15
	10/26/2006	39.4	<1.0	<1.0	<4.0	2.92	<1.0
	1/25/2007	41.4	<0.5	<0.5	<2.0	1.36	<0.5
	4/26/2007	39.6	<0.5	<0.5	<2.0	<0.5	<0.5
	7/25/2007	46.5	<1.0	<1.0	<4.0	<1.0	<1.0
	10/23/2007	53.7	<0.5	<0.5	<2.0	<0.5	<0.5
	1/22/2008	23.8	<0.5	<0.5	2.16	<0.5	<0.5
	4/16/2008	8.36	<0.5	<0.5	<2.0	164	<0.5
	7/3/2008	30.5	<0.5	<0.5	<2.0	1.08	<0.5
	10/15/2008	<20	<1.0	<1.0	<1.0	<1.0	<1.0
	1/7/2009	<25	<1.3	<1.3	<1.3	<1.3	<1.3
	4/14/2009	15	<0.5	<0.5	<0.5	<0.5	<0.5
	8/27/2009	<40	<2.0	<2.0	<2.0	<2.0	<2.0
	12/2/2009	<40	<2.0	<2.0	<2.0	<2.0	<2.0
	3/17/2010	<10	<0.5	<0.5	<0.5	<0.5	<0.5
	6/3/2010	26	<0.5	<0.5	<0.5	<0.5	<0.5
	9/2/2010	<100	<5.0	<5.0	<5.0	<5.0	<5.0
	12/2/2010	<63	<3.1	<3.1	<3.1	<3.1	<3.1
3/4/2011	40	<0.5	<0.5	<0.5	<0.5	<0.5	
5/20/2011	<71	<3.6	<3.6	<3.6	<3.6	<3.6	
9/9/2011	33	<1.3	<1.3	<1.3	<1.3	<1.3	
12/2/2011	49	<3.2	<3.5	<2.8	<2.4	<1.7	
3/2/2012	<50	<2.5	<2.5	<2.5	<2.5	<2.5	
6/7/2012	<50	<2.5	<2.5	<2.5	<2.5	<2.5	
9/21/2012	<50	<2.5	<2.5	<2.5	<2.5	<2.5	
12/14/2012	<50	<2.5	<2.5	<2.5	<2.5	<2.5	
3/28/2013	<50	<2.5	<2.5	<2.5	<2.5	<2.5	
6/11/2013	<50	<2.5	<2.5	<2.5	<2.5	<2.5	
9/17/2013	<50	<2.5	<2.5	<2.5	<2.5	<2.5	
12/6/2013	<33	<1.7	<1.7	<1.7	<1.7	<1.7	
3/13/2014	<10	<0.5	<0.5	<0.5	<0.5	<0.5	
<b>6/6/2014</b>	<b>&lt;10</b>	<b>&lt;0.5</b>	<b>&lt;0.5</b>	<b>&lt;0.5</b>	<b>&lt;0.5</b>	<b>&lt;0.5</b>	
<b>MW-2</b>	8/8/2002	21	<0.5	<0.5	<0.5	NA	NA
	11/1/2002	15	<0.5	<0.5	<0.5	NA	NA
	2/21/2003	12	<0.5	<0.5	<0.5	NA	NA
	5/28/2003	31	<0.5	<0.5	<0.5	NA	NA
	8/12/2003	69	<0.8	<0.8	<0.8	NA	NA
	10/9/2003	12	<0.5	<0.5	<0.5	NA	NA
	1/15/2004	<10	<0.5	<0.5	<0.5	NA	NA
	5/25/2004	14	<0.5	<0.5	<0.5	NA	NA
	9/21/2004	<10	<0.5	<0.5	<0.5	NA	NA
	12/14/2004	<2.5	<0.5	<0.5	<2.0	NA	NA

**Table 2**  
**Historical Gasoline Oxygenates Results**  
**15101 Freedom Avenue, San Leandro, CA**

Monitoring Well	Date	TBA (µg/L)	DIPE (µg/L)	ETBE (µg/L)	TAME (µg/L)	1,2-DCA (µg/L)	EDB (µg/L)
MW-2 cont.	3/11/2005	<2.5	<0.5	<0.5	<2.0	NA	NA
	6/15/2005	<10	<0.5	<0.5	<2.0	NA	NA
	8/26/2005	<10	<0.5	<0.5	<2.0	NA	NA
	11/11/2005	<10	<0.5	<0.5	<2.0	NA	NA
	2/9/2006	<10	<0.5	<0.5	<2.0	NA	NA
	5/9/2006	<10	<0.5	<0.5	<2.0	<0.5	<0.5
	8/10/2006	<10	<0.5	<0.5	<2.0	<0.5	<0.5
	10/26/2006	<10	<0.5	<0.5	<2.0	<0.5	<0.5
	1/25/2007	<2.0	<0.5	<0.5	<2.0	<0.5	<0.5
	4/26/2007	<2.0	<0.5	<0.5	<2.0	<0.5	<0.5
	7/25/2007	<2.0	<0.5	<0.5	<2.0	<0.5	<0.5
	10/23/2007	<2.0	<0.5	<0.5	<2.0	<0.5	<0.5
	1/22/2008	<2.0	<0.5	<0.5	<2.0	<0.5	<0.5
	4/15/2008	<2.0	<0.5	<0.5	<2.0	2.44	<0.5
	7/2/2008	<2.0	<0.5	<0.5	<2.0	<0.5	<0.5
	10/15/2008	<10	<0.5	<0.5	<0.5	<0.5	<0.5
	1/7/2009	<10	<0.5	<0.5	<0.5	<0.5	<0.5
	4/13/2009	<10	<0.5	<0.5	<0.5	<0.5	<0.5
	8/27/2009	<10	<0.5	<0.5	<0.5	<0.5	<0.5
	12/1/2009	<10	<0.5	<0.5	<0.5	<0.5	<0.5
	3/17/2010	<10	<0.5	<0.5	<0.5	<0.5	<0.5
	6/3/2010	<10	<0.5	<0.5	<0.5	<0.5	<0.5
	9/2/2010	<10	<0.5	<0.5	<0.5	<0.5	<0.5
	12/2/2010	<10	<0.5	<0.5	<0.5	<0.5	<0.5
	3/4/2011	<10	<0.5	<0.5	<0.5	<0.5	<0.5
	5/20/2011	<10	<0.5	<0.5	<0.5	<0.5	<0.5
	9/9/2011	<10	<0.5	<0.5	<0.5	<0.5	<0.5
	12/2/2011	<13	<3.2	<3.5	<2.8	<2.4	<1.7
	3/2/2012	<10	<0.5	<0.5	<0.5	<0.5	<0.5
	6/7/2012	<10	<0.5	<0.5	<0.5	<0.5	<0.5
	9/21/2012	<10	<0.5	<0.5	<0.5	<0.5	<0.5
	12/14/2012	<10	<0.5	<0.5	<0.5	<0.5	<0.5
	3/28/2013	<10	<0.5	<0.5	<0.5	<0.5	<0.5
	6/11/2013	150	<0.5	1.6	<0.5	<0.5	<0.5
	9/16/2013	<10	<0.5	<0.5	<0.5	<0.5	<0.5
	12/6/2013	<10	<0.5	<0.5	<0.5	<0.5	<0.5
3/13/2014	<10	<0.5	<0.5	<0.5	<0.5	<0.5	
6/6/2014	<10	<0.5	<0.5	<0.5	<0.5	<0.5	
MW-3	8/8/2002	<330	<8.3	<8.3	330	NA	NA
	11/1/2002	85	< 1.3	<1.3	220	NA	NA
	2/21/2003	140	<5.0	<5.0	320	NA	NA
	5/28/2003	520	<10	<10	530	NA	NA
	8/12/2003	180	<4.2	<4.2	270	NA	NA
	10/9/2003	<170	<8.3	<8.3	200	NA	NA
	1/15/2004	<100	<5.0	<5.0	150	NA	NA
	5/25/2004	<100	<5.0	<5.0	270	NA	NA
	9/21/2004	<140	<7.1	<7.1	110	NA	NA
	12/14/2004	<100	<20	<20	154	NA	NA
	3/11/2005	<215	<43	<43	256	NA	NA
	6/15/2005	<215	<10.8	<10.8	374	NA	NA
	8/26/2005	699	<21.5	<21.5	277	NA	NA
	11/11/2005	<430	<21.5	<21.5	171	NA	NA
	2/9/2006	<430	<21.5	<21.5	620	NA	NA
	5/9/2006	367	<10.8	<10.8	594	<10.8	<10.8
	8/10/2006	365	<10.8	<10.8	727	<10.8	<10.8
	10/26/2006	591	<10.8	<10.8	899	<10.8	<10.8
	1/25/2007	711	<10.8	<10.8	768	<10.8	<10.8
	4/26/2007	690	<10.8	<10.8	369	<10.8	<10.8
7/25/2007	1,340	<10.8	<10.8	565	<10.8	<10.8	
10/23/2007	1,050	<21.5	<21.5	301	<21.5	<21.5	
1/22/2008	373	<10.8	<10.8	170	<0.5	<0.5	
4/16/2008	881	<5.50	<5.50	<22.0	1,850	12.1	
7/3/2008	426	<10.8	<10.8	124	<10.8	<10.8	
10/16/2008	<400	<20	<20	<20	<20	<20	



**Table 2**  
**Historical Gasoline Oxygenates Results**  
**15101 Freedom Avenue, San Leandro, CA**

Monitoring Well	Date	TBA (µg/L)	DIPE (µg/L)	ETBE (µg/L)	TAME (µg/L)	1,2-DCA (µg/L)	EDB (µg/L)
MW-3 cont.	1/8/2009	<500	<25	<25	<25	<25	<25
	4/13/2009	<500	<25	<25	<25	<25	<25
	8/27/2009	<500	<25	<25	<25	<25	<25
	12/2/2009	270	<13	<13	<13	<13	<13
	3/17/2010	<250	<13	<13	<13	<13	<13
	6/3/2010	<250	<13	<13	<13	<13	<13
	9/2/2010	<250	<13	<13	<13	<13	<13
	12/2/2010	<130	<6.3	<6.3	<6.3	<6.3	<6.3
	3/4/2011	<170	<8.3	<8.3	<8.3	<8.3	<8.3
	5/20/2011	<130	<6.3	<6.3	<6.3	<6.3	<6.3
	9/9/2011	<140	<7.1	<7.1	<7.1	<7.1	<7.1
	12/2/2011	<6.6	<1.6	<1.7	<1.4	<1.2	<0.86
	3/2/2012	<100	<5.0	<5.0	<5.0	<5.0	<5.0
	6/7/2012	<100	<5.0	<5.0	<5.0	<5.0	<5.0
	9/21/2012	<100	<5.0	<5.0	<5.0	<5.0	<5.0
	12/14/2012	<100	<5.0	<5.0	<5.0	<5.0	<5.0
	3/28/2013	<100	<5.0	<5.0	<5.0	<5.0	<5.0
	6/11/2013	<100	<5.0	<5.0	<5.0	<5.0	<5.0
	9/17/2013	<200	<10	<10	<10	<10	<10
	12/6/2013	<200	<10	<10	<10	<10	<10
3/12/2014	FP	FP	FP	FP	FP	FP	
6/5/2014	FP	FP	FP	FP	FP	FP	
MW-4	8/8/2002	1500	<17	<17	18	NA	NA
	11/1/2002	580	< 5.0	6	13	NA	NA
	2/21/2003	1600	<20	22	<20	NA	NA
	5/28/2003	690	<8.3	<8.3	17	NA	NA
	8/12/2003	550	<7.1	7.3	18	NA	NA
	10/9/2003	1400	<31	50	<31	NA	NA
	1/15/2004	1,300	<20	25	21	NA	NA
	5/25/2004	560	<8.3	<8.3	24	NA	NA
	9/21/2004	1,300	<50	<50	<50	NA	NA
	12/14/2004	826	<10.75	21	49	NA	NA
	3/11/2005	1,110	<10.8	12.1	<43	NA	NA
	6/15/2005	<110	<5.5	<5.5	22.9	NA	NA
	8/26/2005	902	<5.50	<5.50	37.4	NA	NA
	11/11/2005	884	<10.8	<10.8	<43	NA	NA
	2/9/2006	769	<10.8	16.4	45.6	NA	NA
	5/9/2006	405	<2.15	2.95	31.3	<2.15	<2.15
	8/10/2006	306	<2.15	<2.15	35.3	<2.15	<2.15
	10/26/2006	3430	<10.8	13.8	<43	<10.8	<10.8
	1/25/2007	822	<2.15	2.4	28	2.25	<2.15
	4/26/2007	556	<2.15	2.28	29.2	<2.15	<2.15
	7/25/2007	1,860	<2.15	9.94	24	<2.15	<2.15
	10/23/2007	3,400	<2.15	18.4	25.9	<2.15	<2.15
	1/22/2008	2,580	<5.50	64.7	<22	<0.5	<0.5
	4/15/2008	1,100	<5.50	11.7	<22	39.9	<5.50
	7/2/2008	8,720	<5.50	75.2	<22	<5.50	<5.50
	10/16/2008	700	<3.6	4.2	37	5.4	<3.6
	1/8/2009	1,500	<3.6	9.9	41	3.6	<3.6
	4/13/2009	1,100	<8.3	<8.3	28	<8.3	<8.3
	8/27/2009	4,900	<5.0	24	<5.0	<5.0	<5.0
	12/2/2009	6,800	<5.0	69	<5.0	<5.0	<5.0
	3/17/2010	1,900	<3.6	18	<3.6	<3.6	<3.6
	6/3/2010	930	<3.6	7.7	<3.6	<3.6	<3.6
	9/2/2010	7,200	<3.6	57	<3.6	<3.6	<3.6
	12/2/2010	3,800	<10	30	<10	<10	<10
	3/3/2011	410	<0.71	3.2	<0.71	<0.71	<0.71
	5/19/2011	130	<0.5	1.4	<0.5	<0.5	<0.5
	9/8/2011	380	<0.5	3.5	<0.5	1.1	<0.5
	12/1/2011	790	<1.6	5.4	8.2	<1.2	<0.86
	3/2/2012	920	<2.0	5.9	24	<2.0	<2.0
	6/7/2012	1,000	<2.5	13	<2.5	<2.5	<2.5
9/21/2012	1,300	<2.5	14	<2.5	<2.5	<2.5	
12/14/2012	36	<0.5	0.65	<0.5	<0.5	<0.5	

**Table 2**  
**Historical Gasoline Oxygenates Results**  
**15101 Freedom Avenue, San Leandro, CA**

Monitoring Well	Date	TBA (µg/L)	DIPE (µg/L)	ETBE (µg/L)	TAME (µg/L)	1,2-DCA (µg/L)	EDB (µg/L)
MW-4 cont.	3/28/2013	2,500	<5.0	29	<5.0	<5.0	<5.0
	6/11/2013	890	<5.0	12	<5.0	<5.0	<5.0
	9/17/2013	1,100	<10	<10	<10	<10	<10
	12/6/2013	1,500	<10	<10	<10	<10	<10
	3/13/2014	190	<6.3	<6.3	<6.3	<6.3	<6.3
	6/6/2014	360	<6.3	<6.3	<6.3	<6.3	<6.3
	<b>Separator</b>						
MW-5	8/8/2002	<250	<6.3	<6.3	510	NA	NA
	11/1/2002	66	< 2.0	< 2.0	560	NA	NA
	2/21/2003	<63	<3.1	<3.1	280	NA	NA
	5/28/2003	<33	<1.7	<1.7	110	NA	NA
	8/12/2003	130	<3.6	<3.6	270	NA	NA
	10/9/2003	<100	<5.0	<5.0	740	NA	NA
	1/15/2004	<63	<3.1	<3.1	300	NA	NA
	5/25/2004	<100	<5.0	<5.0	210	NA	NA
	9/21/2004	<130	<6.3	<6.3	550	NA	NA
	12/14/2004	40	<5.5	<5.5	444	NA	NA
	3/11/2005	88.8	<5.5	<5.5	448	NA	NA
	6/15/2005	<43	<2.15	<2.15	88.1	NA	NA
	8/26/2005	274	<5.50	<5.50	195	NA	NA
	11/11/2005	192	<5.50	<5.50	360	NA	NA
	2/9/2006	218	<5.50	<5.50	523	NA	NA
	5/9/2006	91.8	<2.15	<2.15	163	<2.15	<2.15
	8/10/2006	138	<5.50	<5.50	342	<5.50	<5.50
	10/26/2006	322	<5.50	<5.50	712	<5.50	<5.50
	1/25/2007	878	<5.50	<5.50	552	<5.50	<5.50
	4/26/2007	708	<2.15	<2.15	310	<2.15	<2.15
	7/25/2007	1,020	<2.15	<2.15	356	<2.15	<2.15
	10/23/2007	1,510	<2.15	<2.15	181	<2.15	<2.15
	1/22/2008	470	<0.5	4.56	62.1	<0.5	<0.5
	4/15/2008	566	<1.0	<1.0	29.6	231	5.66
	7/3/2008	2,320	<2.15	<2.15	53.3	<2.15	<2.15
	10/16/2008	990	<5.0	<5.0	82	<5.0	<5.0
	1/8/2009	360	<6.3	<6.3	51	<6.3	<6.3
	4/13/2009	280	<3.1	<3.1	<3.1	<3.1	<3.1
	8/27/2009	1,300	<5.0	<5.0	<5.0	<5.0	<5.0
	12/2/2009	320	<5.0	<5.0	25	<5.0	<5.0
	3/17/2010	570	<1.0	<1.0	<1.0	<1.0	<1.0
	6/4/2010	340	<1.0	<1.0	<1.0	<1.0	<1.0
	9/2/2010	320	<2.5	<2.5	13	<2.5	<2.5
	12/2/2010	200	<3.1	<3.1	<3.1	<3.1	<3.1
	3/4/2011	180	<0.5	<0.5	<0.5	<0.5	<0.5
	5/20/2011	480	<1.0	<1.0	<1.0	<1.0	<1.0
	8/4/2011	110	<0.71	<0.71	2.6	<0.71	<0.71
	9/9/2011	260	<1.0	<1.0	11	<1.0	<1.0
	12/2/2011	95	<3.2	<3.5	14	<2.4	<1.7
	3/2/2012	59	<1.0	<1.0	4.1	<1.0	<1.0
6/7/2012	22	<1.0	<1.0	2.8	<1.0	<1.0	
9/21/2012	66	<1.0	<1.0	<1.0	<1.0	<1.0	
12/14/2012	<20	<1.0	<1.0	4.2	<1.0	<1.0	
3/28/2013	<20	<1.0	<1.0	<1.0	<1.0	<1.0	
6/11/2013	<20	<1.0	<1.0	2.5	<1.0	<1.0	
9/17/2013	20	<1.0	<1.0	5.7	<1.0	<1.0	
12/6/2013	<20	<1.0	<1.0	3.9	<1.0	<1.0	
3/13/2014	<20	<1.0	<1.0	2.2	<1.0	<1.0	
6/6/2014	<10	<0.5	<0.5	0.81	<0.5	<0.5	
<b>Separator</b>							
MW-6	9/21/2004	<10	<0.5	<0.5	<0.5	NA	NA
	12/14/2004	<5.5	<5.5	<5.5	<22	NA	NA
	3/11/2005	2.54	<0.5	<0.5	<2.0	NA	NA
	6/15/2005	<20	<1.0	<1.0	<4.0	NA	NA
	8/26/2005	<43	<2.15	<2.15	<8.6	NA	NA
	11/11/2005	<43	<2.15	<2.15	<8.6	NA	NA

**Table 2**  
**Historical Gasoline Oxygenates Results**  
**15101 Freedom Avenue, San Leandro, CA**

Monitoring Well	Date	TBA (µg/L)	DIPE (µg/L)	ETBE (µg/L)	TAME (µg/L)	1,2-DCA (µg/L)	EDB (µg/L)
MW-6 cont.	2/9/2006	<43	<2.15	<2.15	<8.6	NA	NA
	5/9/2006	<10	<0.5	<0.5	<2.0	<0.5	<0.5
	8/10/2006	<10	<0.5	<0.5	<2.0	<0.5	<0.5
	10/26/2006	<10	<0.5	<0.5	<2.0	<0.5	<0.5
	1/25/2007	<2.0	<0.5	<0.5	<2.0	<0.5	<0.5
	4/26/2007	7.21	<0.5	<0.5	<2.0	<0.5	<0.5
	7/25/2007	5.66	<0.5	<0.5	<2.0	<0.5	<0.5
	10/23/2007	6.68	<0.5	<0.5	<2.0	<0.5	<0.5
	1/21/2008	13.9	<0.5	<0.5	<2.0	<0.5	<0.5
	4/15/2008	<2.0	<0.5	<0.5	<2.0	6.78	1.49
	7/2/2008	4.54	<0.5	<0.5	<2.0	<0.5	<0.5
	10/15/2008	<10	<0.5	<0.5	<0.5	<0.5	<0.5
	1/7/2009	<63	<3.1	<3.1	<3.1	<3.1	<3.1
	4/13/2009	<25	<1.3	<1.3	<1.3	<1.3	<1.3
	8/26/2009	<40	<2.0	<2.0	<2.0	<2.0	<2.0
	12/1/2009	<40	<2.0	<2.0	<2.0	<2.0	<2.0
	3/16/2010	<40	<2.0	<2.0	<2.0	<2.0	<2.0
	6/3/2010	<40	<2.0	<2.0	<2.0	<2.0	<2.0
	9/1/2010	<200	<10	<10	<10	<10	<10
	12/2/2010	<330	<17	<17	<17	<17	<17
	3/3/2011	<50	<2.5	<2.5	<2.5	<2.5	<2.5
	5/20/2011	<50	<2.5	<2.5	<2.5	<2.5	<2.5
	9/8/2011	<50	<2.5	<2.5	<2.5	<2.5	<2.5
	12/1/2011	NA	NA	NA	NA	NA	NA
	3/2/2012	<83	<4.2	<4.2	<4.2	<4.2	<4.2
	6/6/2012	<33	<1.7	<1.7	<1.7	<1.7	<1.7
	9/20/2012	NA	NA	NA	NA	NA	NA
	12/13/2012	29	<0.71	<0.71	<0.71	<0.71	<0.71
	3/27/2013	<25	<1.3	<1.3	<1.3	<1.3	<1.3
	6/10/2013	<50	<2.5	<2.5	<2.5	<2.5	<2.5
	9/16/2013	FP	FP	FP	FP	FP	FP
	12/5/2013	270	<2.5	<2.5	<2.5	<2.5	<2.5
3/12/2014	<50	<2.5	<2.5	<2.5	<2.5	<2.5	
6/5/2014	<50	<2.5	<2.5	<2.5	<2.5	<2.5	
MW-7	9/21/2004	<10	<0.5	<0.5	1.5	NA	NA
	12/14/2004	<2.5	<0.5	<0.5	<2.0	NA	NA
	3/11/2005	<12.5	<2.5	<2.5	<10	NA	NA
	6/15/2005	<10	<0.5	<0.5	2.23	NA	NA
	8/26/2005	<10	<0.5	<0.5	<2.0	NA	NA
	11/11/2005	<10	<0.5	<0.5	<2.0	NA	NA
	2/9/2006	NA	NA	NA	NA	NA	NA
	5/9/2006	<10	<0.5	<0.5	<2.0	<0.5	<0.5
	8/10/2006	<10	<0.5	<0.5	<2.0	<0.5	<0.5
	10/26/2006	<10	<0.5	<0.5	<2.0	<0.5	<0.5
	1/25/2007	<2.0	<0.5	<0.5	<2.0	<0.5	<0.5
	4/26/2007	<2.0	<0.5	<0.5	<2.0	<0.5	<0.5
	7/25/2007	<2.0	<0.5	<0.5	<2.0	<0.5	<0.5
	10/23/2007	6.49	<0.5	<0.5	2.58	<0.5	<0.5
	1/21/2008	<2.0	<0.5	<0.5	6.01	<0.5	<0.5
	4/15/2008	8.8	<0.5	<0.5	<2.0	<0.5	1.26
	7/2/2008	<2.0	<0.5	<0.5	<2.0	<0.5	<0.5
	10/15/2008	<10	<0.5	<0.5	14	<0.5	<0.5
	1/7/2009	<10	<0.5	<0.5	11	<0.5	<0.5
	4/13/2009	<10	<0.5	<0.5	16	<0.5	<0.5
	8/26/2009	<33	<0.5	<0.5	33	<0.5	<0.5
12/1/2009	<10	<0.5	<0.5	30	<0.5	<0.5	
3/16/2010	11	<0.5	<0.5	<0.5	<0.5	<0.5	
6/3/2010	20	<0.5	<0.5	7.1	<0.5	<0.5	
9/1/2010	47	<0.5	<0.5	7.2	<0.5	<0.5	
12/2/2010	22	<0.5	<0.5	4.9	<0.5	<0.5	
3/4/2011	14	<0.5	<0.5	4.0	<0.5	<0.5	
5/19/2011	<10	<0.5	<0.5	2.1	<0.5	<0.5	
9/8/2011	<10	<0.5	<0.5	1.6	<0.5	<0.5	
12/1/2011	15	<0.36	<0.40	2.4	<0.28	<0.19	

**Table 2**  
**Historical Gasoline Oxygenates Results**  
**15101 Freedom Avenue, San Leandro, CA**

Monitoring Well	Date	TBA (µg/L)	DIPE (µg/L)	ETBE (µg/L)	TAME (µg/L)	1,2-DCA (µg/L)	EDB (µg/L)
MW-7 cont.	3/2/2012	<10	<0.5	<0.5	0.82	<0.5	<0.5
	6/6/2012	<10	<0.5	<0.5	<0.5	<0.5	<0.5
	9/20/2012	<10	<0.5	<0.5	<0.5	<0.5	<0.5
	12/13/2012	<10	<0.5	<0.5	<0.5	<0.5	<0.5
	3/27/2013	<10	<0.5	<0.5	<0.5	<0.5	<0.5
	6/10/2013	<10	<0.5	<0.5	<0.5	<0.5	<0.5
	9/16/2013	<10	<0.5	<0.5	<0.5	<0.5	<0.5
	12/5/2013	<10	<0.5	<0.5	0.73	<0.5	<0.5
	3/12/2014	<10	<0.5	<0.5	0.64	<0.5	<0.5
	6/5/2014	<10	<0.5	<0.5	0.76	<0.5	<0.5
<b>Well Decommissioned 11/13/2009</b>							
MW-8	9/21/2004	<10	<0.5	<0.5	<0.5	NA	NA
	12/14/2004	<2.5	<0.5	<0.5	<2.0	NA	NA
	3/11/2005	NA	NA	NA	NA	NA	NA
	6/15/2005	<10	<0.5	<0.5	<2.0	NA	NA
	8/26/2005	<10	<0.5	<0.5	<2.0	NA	NA
	11/11/2005	<10	<0.5	<0.5	<2.0	NA	NA
	2/9/2006	<10	<0.5	<0.5	<2.0	NA	NA
	5/9/2006	<10	<0.5	<0.5	<2.0	<0.5	<0.5
	8/10/2006	<10	<0.5	<0.5	<2.0	<0.5	<0.5
	10/26/2006	<10	<0.5	<0.5	<2.0	<0.5	<0.5
	1/25/2007	<2.0	<0.5	<0.5	<2.0	<0.5	<0.5
	4/26/2007	<2.0	<0.5	<0.5	<2.0	<0.5	<0.5
	7/25/2007	<2.0	<0.5	<0.5	<2.0	<0.5	<0.5
	10/23/2007	<2.0	<0.5	<0.5	<2.0	<0.5	<0.5
	1/21/2008	<2.0	<0.5	<0.5	<2.0	<0.5	<0.5
	4/15/2008	<2.0	<0.5	<0.5	<2.0	<0.5	<0.5
	7/2/2008	<2.0	<0.5	<0.5	<2.0	<0.5	<0.5
	10/15/2008	<10	<0.5	<0.5	<0.5	<0.5	<0.5
	1/7/2009	<10	<0.5	<0.5	<0.5	<0.5	<0.5
	4/13/2009	<10	<0.5	<0.5	<0.5	<0.5	<0.5
8/27/2009	<10	<0.5	<0.5	<0.5	<0.5	<0.5	
<b>Well Decommissioned 11/13/2009</b>							
MW-9	9/21/2004	<10	<0.5	<0.5	<0.5	NA	NA
	12/14/2004	<2.5	<0.5	<0.5	<2.0	NA	NA
	3/11/2005	<2.5	<0.5	<0.5	<2.0	NA	NA
	6/15/2005	<10	<0.5	<0.5	<2.0	NA	NA
	8/26/2005	<10	<0.5	<0.5	<2.0	NA	NA
	11/11/2005	<10	<0.5	<0.5	<2.0	NA	NA
	2/9/2006	<10	<0.5	<0.5	<2.0	NA	NA
	5/9/2006	<10	<0.5	<0.5	<2.0	2.8	<0.5
	8/10/2006	<10	<0.5	<0.5	<2.0	1.83	<0.5
	10/26/2006	<10	<0.5	<0.5	<2.0	3.07	<0.5
	1/25/2007	<2.0	<0.5	<0.5	<2.0	2.92	<0.5
	4/26/2007	<2.0	<0.5	<0.5	<2.0	<0.5	<0.5
	7/25/2007	<2.0	<0.5	<0.5	<2.0	<0.5	<0.5
	10/23/2007	<2.0	<0.5	<0.5	<2.0	<0.5	<0.5
	1/21/2008	<2.0	<0.5	<0.5	<2.0	1.18	<0.5
	4/15/2008	<2.0	<0.5	<0.5	<2.0	<0.5	<0.5
	7/2/2008	<2.0	<0.5	<0.5	<2.0	2.07	<0.5
	10/15/2008	<10	<0.5	<0.5	<0.5	1.5	<0.5
	1/7/2009	<10	<0.5	<0.5	<0.5	1.4	<0.5
	4/13/2009	<10	<0.5	<0.5	<0.5	0.97	<0.5
8/26/2009	<10	<0.5	<0.5	<0.5	2.6	<0.5	
<b>Well Decommissioned 11/13/2009</b>							
EX-1	12/2/2009	150	<1.3	<1.3	<1.3	<1.3	<1.3
	3/16/2010	980	<1.3	2.4	27	<1.3	<1.3
	6/3/2010	570	<1.3	1.9	<1.3	<1.3	<1.3
	9/1/2010	470	<0.5	1.4	2	<0.5	<0.5
	12/2/2010	1,300	<2.0	3.6	15	<2.0	<2.0
	3/3/2011	690	<0.71	2.5	12	<0.71	<0.71
	5/19/2011	370	<0.71	1.9	13	<0.71	<0.71
	9/8/2011	32	<0.5	<0.5	0.53	<0.5	<0.5
	12/1/2011	1,200	<1.6	8.3	6.8	<1.2	<0.86

**Table 2**  
**Historical Gasoline Oxygenates Results**  
**15101 Freedom Avenue, San Leandro, CA**

Monitoring Well	Date	TBA (µg/L)	DIPE (µg/L)	ETBE (µg/L)	TAME (µg/L)	1,2-DCA (µg/L)	EDB (µg/L)
EX-1 cont.	3/2/2012	31	<0.5	<0.5	<0.5	<0.5	<0.5
	6/6/2012	390	<0.5	2.9	4.8	0.57	<0.5
	9/20/2012	170	<0.5	1.5	<0.5	<0.5	<0.5
	12/13/2012	210	<0.5	2.7	5.2	<0.5	<0.5
	3/27/2013	<10	<0.5	<0.5	<0.5	<0.5	<0.5
	6/10/2013	280	<0.5	4.0	1.6	<0.5	<0.5
	9/16/2013	450	<0.5	2.4	1.9	<0.5	<0.5
	12/5/2013	230	<0.5	1.7	5.5	<0.5	<0.5
	3/12/2014	48	<0.5	0.77	3.1	<0.5	<0.5
	<b>6/5/2014</b>	<b>70</b>	<b>&lt;0.5</b>	<b>1.1</b>	<b>3.9</b>	<b>0.69</b>	<b>&lt;0.5</b>
<b>MPE Wells</b>							
EX-2	12/2/2009	<63	<3.1	<3.1	<3.1	<3.1	<3.1
	3/16/2010	<100	<5.0	<5.0	<5.0	<5.0	<5.0
	6/3/2010	<100	<5.0	<5.0	<5.0	<5.0	<5.0
	9/1/2010	<50	<2.5	<2.5	<2.5	<2.5	<2.5
	12/2/2010	<100	<5.0	<5.0	<5.0	<5.0	<5.0
	3/3/2011	<100	<5.0	<5.0	<5.0	<5.0	<5.0
	5/19/2011	<100	<5.0	<5.0	<5.0	<5.0	<5.0
	9/8/2011	<25	<1.3	<1.3	<1.3	<1.3	<1.3
	12/1/2011	74	<3.2	<3.5	<2.8	<2.4	<1.7
	3/2/2012	<25	<1.3	<1.3	<1.3	<1.3	<1.3
	6/6/2012	<33	<1.7	<1.7	<1.7	<1.7	<1.7
	9/20/2012	<33	<1.7	<1.7	<1.7	<1.7	<1.7
	12/13/2012	<71	<3.6	<3.6	<3.6	<3.6	<3.6
	3/27/2013	<20	<1.0	<1.0	<1.0	<1.0	<1.0
	6/10/2013	32	<1.0	<1.0	<1.0	<1.0	<1.0
	9/20/2013	<20	<1.0	<1.0	<1.0	1.4	<1.0
12/5/2013	30	<1.0	<1.0	<1.0	1.2	<1.0	
3/12/2014	<40	<2.0	<2.0	<2.0	<2.0	<2.0	
<b>6/5/2014</b>	<b>&lt;40</b>	<b>&lt;2.0</b>	<b>&lt;2.0</b>	<b>&lt;2.0</b>	<b>&lt;2.0</b>	<b>&lt;2.0</b>	
<b>MPE Wells</b>							
MPE-1	8/4/2011	<500	<25	<25	<25	<25	<25
	9/26/2011	<500	<25	<25	600	<25	<25
	12/2/2011	830	<32	<35	750	<24	<17
	3/2/2012	<710	<36	<36	1,200	<36	<36
	6/6/2012	<630	<31	<31	430	<31	<31
	9/20/2012	<1,300	<63	<63	1,200	<63	<63
	12/14/2012	<1,300	<63	<63	940	<63	<63
	3/27/2013	<710	<36	<36	890	<36	<36
	6/10/2013	660	<13	<13	380	<13	<13
	9/17/2013	1,400	<13	<13	<13	<13	<13
	12/6/2013	1,500	<20	<20	30	<20	<20
	3/13/2014	1,100	<20	<20	160	<20	<20
<b>6/5/2014</b>	<b>FP</b>	<b>FP</b>	<b>FP</b>	<b>FP</b>	<b>FP</b>	<b>FP</b>	
<b>MPE Wells</b>							
MPE-2	8/4/2011	<330	<17	<17	<17	<17	<17
	9/26/2011	<330	<17	<17	<17	<17	<17
	12/2/2011	<66	<16	<17	<14	<12	<8.6
	3/2/2012	<330	<17	<17	<17	<17	<17
	6/7/2012	<250	<13	<13	<13	<13	<13
	9/21/2012	<250	<13	<13	<13	<13	<13
	12/14/2012	<250	<13	<13	<13	<13	<13
	3/28/2013	<400	<20	<20	<20	<20	<20
	6/11/2013	<250	<13	<13	<13	<13	<13
	9/17/2013	<250	<13	<13	<13	<13	<13
	12/5/2013	FP	FP	FP	FP	FP	FP
	3/12/2014	FP	FP	FP	FP	FP	FP
<b>6/5/2014</b>	<b>FP</b>	<b>FP</b>	<b>FP</b>	<b>FP</b>	<b>FP</b>	<b>FP</b>	
<b>2nd WBZ</b>							
MW-1D	1/3/2008	111	<0.5	<0.5	<2.0	NA	NA
	1/22/2008	12.9	<0.5	<0.5	<2.0	<0.5	<0.5
	4/16/2008	<2.0	<0.5	<0.5	<2.0	<0.5	<0.5
	7/3/2008	<2.0	<0.5	<0.5	<2.0	<0.5	<0.5
	10/15/2008	<10	<0.5	<0.5	<0.5	<0.5	<0.5

**Table 2**  
**Historical Gasoline Oxygenates Results**  
**15101 Freedom Avenue, San Leandro, CA**

Monitoring Well	Date	TBA (µg/L)	DIPE (µg/L)	ETBE (µg/L)	TAME (µg/L)	1,2-DCA (µg/L)	EDB (µg/L)
MW-1D cont.	1/8/2009	<10	<0.5	<0.5	<0.5	<0.5	<0.5
	4/14/2009	<10	<0.5	<0.5	<0.5	<0.5	<0.5
	8/26/2009	<10	<0.5	<0.5	<0.5	<0.5	<0.5
	12/1/2009	<10	<0.5	<0.5	<0.5	<0.5	<0.5
	3/16/2010	<10	<0.5	<0.5	<0.5	<0.5	<0.5
	6/4/2010	<10	<0.5	<0.5	<0.5	<0.5	<0.5
	9/1/2010	<10	<0.5	<0.5	<0.5	<0.5	<0.5
	12/3/2010	<10	<0.5	<0.5	<0.5	<0.5	<0.5
	3/3/2011	<10	<0.5	<0.5	<0.5	<0.5	<0.5
	5/19/2011	<10	<0.5	<0.5	<0.5	<0.5	<0.5
	9/8/2011	<10	<0.5	<0.5	<0.5	<0.5	<0.5
	12/1/2011	<1.5	<0.36	<0.40	<0.32	<0.28	<0.19
	3/2/2012	<10	<0.5	<0.5	<0.5	<0.5	<0.5
	6/6/2012	<10	<0.5	<0.5	<0.5	<0.5	<0.5
	9/20/2012	<10	<0.5	<0.5	<0.5	<0.5	<0.5
	12/13/2012	<10	<0.5	<0.5	<0.5	<0.5	<0.5
	3/27/2013	<10	<0.5	<0.5	<0.5	<0.5	<0.5
	6/10/2013	<10	<0.5	<0.5	<0.5	<0.5	<0.5
	9/16/2013	<10	<0.5	<0.5	<0.5	<0.5	<0.5
	12/5/2013	<10	<0.5	<0.5	<0.5	<0.5	<0.5
3/12/2014	<10	<0.5	<0.5	<0.5	<0.5	<0.5	
6/5/2014	<10	<0.5	<0.5	<0.5	<0.5	<0.5	
MW-3D	1/3/2008	37.3	<0.5	3.12	15.3	NA	NA
	1/22/2008	15.6	<0.5	3.1	15.3	<0.5	<0.5
	4/16/2008	17.7	<0.5	<0.5	<2.0	<0.5	<0.5
	7/3/2008	<2.0	<0.5	<0.5	7.45	<0.5	<0.5
	10/16/2008	<10	<0.5	<0.5	4.7	<0.5	<0.5
	1/8/2009	<10	<0.5	<0.5	3.4	<0.5	<0.5
	4/14/2009	<10	<0.5	<0.5	5	<0.5	<0.5
	8/26/2009	<10	<0.5	<0.5	1.6	<0.5	<0.5
	12/1/2009	<10	<0.5	<0.5	2.2	<0.5	<0.5
	3/16/2010	<10	<0.5	<0.5	0.65	<0.5	<0.5
	6/4/2010	<10	<0.5	<0.5	1.8	<0.5	<0.5
	9/1/2010	<10	<0.5	<0.5	<0.5	<0.5	<0.5
	12/3/2010	<10	<0.5	<0.5	0.93	<0.5	<0.5
	3/3/2011	<10	<0.5	<0.5	1.0	<0.5	<0.5
	5/19/2011	<10	<0.5	<0.5	<0.5	<0.5	<0.5
	9/8/2011	<10	<0.5	<0.5	<0.5	<0.5	<0.5
	12/1/2011	<1.5	<0.36	<0.40	0.52	<0.28	<0.19
	3/2/2012	<10	<0.5	<0.5	<0.5	<0.5	<0.5
	6/6/2012	<10	<0.5	<0.5	<0.5	<0.5	<0.5
	9/20/2012	<10	<0.5	<0.5	<0.5	<0.5	<0.5
12/13/2012	<10	<0.5	<0.5	<0.5	<0.5	<0.5	
3/27/2013	<10	<0.5	<0.5	<0.5	<0.5	<0.5	
6/10/2013	<10	<0.5	<0.5	<0.5	<0.5	<0.5	
9/16/2013	<10	<0.5	<0.5	<0.5	<0.5	<0.5	
12/5/2013	<10	<0.5	<0.5	<0.5	<0.5	<0.5	
3/13/2014	<10	<0.5	<0.5	<0.5	<0.5	<0.5	
6/5/2014	<10	<0.5	<0.5	<0.5	<0.5	<0.5	
MW-4D	1/4/2008	25	<0.5	<0.5	<2.0	NA	NA
	1/22/2008	124	<0.5	4.9	3.32	<0.5	<0.5
	4/15/2008	25.7	<0.5	<0.5	<2.0	<0.5	<0.5
	7/3/2008	3.38	<0.5	<0.5	<2.0	<0.5	<0.5
	10/16/2008	<10	<0.5	<0.5	<0.5	<0.5	<0.5
	1/8/2009	<10	<0.5	<0.5	<0.5	<0.5	<0.5
	4/14/2009	<10	<0.5	<0.5	<0.5	<0.5	<0.5
	8/27/2009	<10	<0.5	<0.5	<0.5	<0.5	<0.5
	12/1/2009	<10	<0.5	<0.5	<0.5	<0.5	<0.5
	3/16/2010	<10	<0.5	<0.5	<0.5	<0.5	<0.5
	6/4/2010	<10	<0.5	<0.5	<0.5	<0.5	<0.5
	9/1/2010	<10	<0.5	<0.5	<0.5	<0.5	<0.5
	12/3/2010	<10	<0.5	<0.5	<0.5	<0.5	<0.5

**Table 2**  
**Historical Gasoline Oxygenates Results**  
**15101 Freedom Avenue, San Leandro, CA**

Monitoring Well	Date	TBA (µg/L)	DIPE (µg/L)	ETBE (µg/L)	TAME (µg/L)	1,2-DCA (µg/L)	EDB (µg/L)
MW-4D cont.	3/3/2011	<10	<0.5	<0.5	<0.5	<0.5	<0.5
	5/19/2011	<10	<0.5	<0.5	<0.5	<0.5	<0.5
	9/8/2011	<10	<0.5	<0.5	<0.5	<0.5	<0.5
	12/1/2011	<1.5	<0.36	<0.40	<0.32	<0.28	<0.19
	3/2/2012	<10	<0.5	<0.5	<0.5	<0.5	<0.5
	6/6/2012	<10	<0.5	<0.5	<0.5	<0.5	<0.5
	9/20/2012	<10	<0.5	<0.5	<0.5	<0.5	<0.5
	12/13/2012	<10	<0.5	<0.5	<0.5	<0.5	<0.5
	3/27/2013	<10	<0.5	<0.5	<0.5	<0.5	<0.5
	6/10/2013	<10	<0.5	<0.5	<0.5	<0.5	<0.5
	9/16/2013	<10	<0.5	<0.5	<0.5	<0.5	<0.5
	12/6/2013	<10	<0.5	<0.5	<0.5	<0.5	<0.5
	3/13/2014	<10	<0.5	<0.5	<0.5	<0.5	<0.5
	6/6/2014	<10	<0.5	<0.5	<0.5	<0.5	<0.5
1573 153 RD	1/3/2008	21	<0.5	<0.5	<2.0	<0.5	<2.0
	7/2/2008	<2.0	<0.5	<0.5	<2.0	<0.5	<0.5
	10/16/2008	<10	<0.5	<0.5	<0.5	<0.5	<0.5
EB-PMP	1/21/2008	<2.0	<0.5	<0.5	<2.0	<0.5	<0.5
EB-PRB	1/21/2008	<2.0	<0.5	<0.5	<2.0	<0.5	<0.5
EB-PMP2	1/22/2008	<2.0	<0.5	<0.5	<2.0	<0.5	<0.5
EB-PRB2	1/22/2008	<2.0	<0.5	<0.5	<2.0	<0.5	<0.5
<b>ESL</b>		<b>12</b>	<b>NE</b>	<b>NE</b>	<b>NE</b>	<b>0.5</b>	<b>0.05</b>

Notes:

August 8, 2002 was the first time that samples were analyzed for Gasoline Oxygenates  
 <: Not detected above the laboratory reporting limit.  
 NA: Not Analyzed. Well MW-8 was inaccessible during the 1Q05  
 & well MW-7 (1Q06) car was parked over each well.  
 NE: Not Established  
 TBA: tert-Butyl Alcohol  
 DIPE: Isopropyl Ether  
 ETBE: Ethyl tert-Butyl Ether  
 TAME: Methyl tert-Amyl Ether  
 ESL: Environmental Screening Levels per CRWQCB SFBay Region Interim Final Nov. 2007 (Revised May 2008);  
 Table F-1a, Groundwater Screening Levels (groundwater is a current or potential drinking water resource)  
 MW-8 and MW-9 were decommissioned November 13, 2009  
 FP: Groundwater not sampled due to presence of free-product in MW-6

**Table 3**  
**Effluent Chemical Analytical Results**  
**and Operational History of Remediation System**  
15101 Freedom Ave, San Leandro, CA

Date	Volume (gallons)	TPH-g (µg/L)	TPH-d (µg/L)	TPH-mo (µg/L)	Benzene (µg/L)	Toluene (µg/L)	Ethylbenzene (µg/L)	Total Xylenes (µg/L)	COD (mg/L)	TSS (mg/L)	pH
<b>2009</b>											
8-Oct-2009	15,351	<50	120 <sup>Y</sup>	NA	NA	NA	NA	NA	NA	NA	NA
19-Nov-2009	8,287	<50	<50	<300	<0.5	<0.5	<0.5	<0.5	<10	<5	7.7
9-Dec-2009	0	Installation of GWETS									
16-Dec-2009	20,000	<50	<50	<300	<0.5	0.65 C	<0.5	0.84 C	<10	<5	7.4
<b>2010</b>											
18-Jan-2010	215,453	<50	<50	<300	<0.5	<0.5	<0.5	<0.5	<10	<5	7.4
15-Feb-2010	297,560	<50	<50	<300	<0.5	<0.5	<0.5	<0.5	11	<5	6.7
15-Mar-2010	475,245	<50	<50	<300	<0.5	<0.5	<0.5	<0.5	<10	<5.0	6.5
19-Apr-2010	621,180	<50	<50	<300	<0.5	<0.5	<0.5	<0.5	<10	8	6.6
17-May-2010	705,770	<50	<50	<300	<0.5	<0.5	<0.5	<0.5	<10	8	6.7
16-Jun-2010	825,200	<50	<50	<300	<0.5	<0.5	<0.5	<0.5	17	9	6.8
19-Jul-2010	910,652	<50	<50	<300	<0.5	<0.5	<0.5	<0.5	<10	8	6.6
16-Aug-2010	939,935	<50	<50	<300	<0.5	<0.5	<0.5	<0.5	<10	6	6.6
28-Sep-2010	970,450	<50	<50	<300	<0.5	<0.5	<0.5	<0.5	<10	10	6.8
26-Oct-2010	1,013,700	<50	<50	<300	<0.5	<0.5	<0.5	<0.5	<10	<5	7.2
15-Nov-2010	1,052,591	<50	<50	<300	<0.5	<0.5	<0.5	<0.5	<10	<5	6.5
7-Dec-2010	1,100,492	<50	<50	<300	<0.5	<0.5	<0.5	<0.5	<10	6	6.6
<b>2011</b>											
11-Jan-2011	1,179,075	<50	<50	<300	<0.5	<0.5	<0.5	<0.5	12	6	6.6
10-Feb-2011	1,249,569	<50	<50	<300	<0.5	<0.5	<0.5	<0.5	<10	<5	6.6
14-Mar-2011	1,336,784	<50	<50	<300	<0.5	<0.5	<0.5	<0.5	<10	<5	6.5
11-Apr-2011	1,364,272	<50	<50	<300	<0.5	<0.5	<0.5	<0.5	<10	6	6.5
10-May-2011	1,466,472	<50	<50	<300	<0.5	<0.5	<0.5	<0.5	12	7	6.6
7-Jun-2011	1,532,263	<50	<50	<300	<0.5	<0.5	<0.5	<0.5	<10	6	6.6



**Table 3**  
**Effluent Chemical Analytical Results**  
**and Operational History of Remediation System**  
15101 Freedom Ave, San Leandro, CA

Date	Volume (gallons)	TPH-g (µg/L)	TPH-d (µg/L)	TPH-mo (µg/L)	Benzene (µg/L)	Toluene (µg/L)	Ethylbenzene (µg/L)	Total Xylenes (µg/L)	COD (mg/L)	TSS (mg/L)	pH
28-Jul-2011	1,573,295	<50	<50	<300	<0.5	<0.5	<0.5	<0.5	<10	5	6.3
25-Aug-2011	1,613,935	77	<50	<300	<0.5	<0.5	<0.5	<0.5	<10	<5	7.1
23-Sep-2011	1,631,273	<50	<50	<300	<0.5	<0.5	<0.5	<0.5	<10	<5	6.7
27-Oct-2011	1,642,277	<50	<50	<300	<0.5	<0.5	<0.5	<0.5	<10	7	7.1
18-Nov-2011	1,676,170	<50	<50	<300	<0.5	<0.5	<0.5	<0.5	<10	<5	7.8
1-Dec-2011	1,694,889	<50	<50	<300	<0.5	<0.5	<0.5	<0.5	<10	<5	6.97
<b>2012</b>											
19-Jan-2012	1,715,163	<50	<50	<300	<0.5	<0.5	<0.5	<0.5	<10	<5	7.02
23-Feb-2012	1,794,185	<50	<50	<300	<0.5	<0.5	<0.5	<0.5	<10	<5	6.98
20-Mar-2012	1,803,832	<50	<50	<300	<0.5	<0.5	<0.5	<0.5	<10	7	7.02
17-Apr-2012	1,876,439	<50	<50	<300	<0.5	<0.5	<0.5	<0.5	NA	NA	6.95
29-May-2012	1,900,111	<50	<50	<300	<0.5	<0.5	<0.5	<0.5	NA	NA	6.89
11-Jun-2012	1,914,130	<50	<50	<300	<0.5	<0.5	<0.5	<0.5	NA	NA	7.1
12-Jul-2012	1,943,456	<50	<50	<300	<0.5	<0.5	<0.5	<0.5	NA	NA	7.3
17-Aug-2012	1,955,438	<50	<52	<310	<0.5	<0.5	<0.5	<0.5	NA	NA	7.04
17-Sep-2012	1,979,852	<50	<54	<330	<0.5	<0.5	<0.5	<0.5	NA	NA	7.02
23-Oct-2012	1,989,022	<50	<49	<290	<0.5	<0.5	<0.5	<0.5	NA	NA	6.95
12-Nov-2012	1,995,170	<50	<50	<300	<0.5	<0.5	<0.5	<0.5	NA	NA	6.90
4-Dec-2012	2,024,040	<50	<49	<290	<0.5	<0.5	<0.5	<0.5	NA	NA	6.86
<b>2013</b>											
7-Jan-2013	2,099,002	<50	<50	<300	<0.5	<0.5	<0.5	<0.5	NA	NA	7.01
14-Feb-2013	2,186,595	<50	<50	<300	<0.5	<0.5	<0.5	<0.5	NA	NA	7.08
14-Mar-2013	2,193,121	<50	<50	<300	<0.5	<0.5	<0.5	<0.5	NA	NA	6.98
12-Apr-2013	2,198,793	<50	<50	<300	<0.5	<0.5	<0.5	<0.5	NA	NA	6.83
10-Jun-2013	2,273,686	<50	<58	<350	<0.5	<0.5	<0.5	<0.5	NA	NA	6.91

**Table 3**  
**Effluent Chemical Analytical Results**  
**and Operational History of Remediation System**  
15101 Freedom Ave, San Leandro, CA

Date	Volume (gallons)	TPH-g (µg/L)	TPH-d (µg/L)	TPH-mo (µg/L)	Benzene (µg/L)	Toluene (µg/L)	Ethylbenzene (µg/L)	Total Xylenes (µg/L)	COD (mg/L)	TSS (mg/L)	pH
5-Jul-2013	2,282,444	<50	<49	<290	<0.5	<0.5	<0.5	<0.5	NA	NA	6.87
15-Aug-2013	2,403,250	<50	<50	<300	<0.5	<0.5	<0.5	<0.5	NA	NA	6.64
24-Sep-2013	2,449,583	<50	<50	<300	<0.5	<0.5	<0.5	<0.5	NA	NA	6.59
28-Oct-2013	2,551,538	<50	<50	<300	<0.5	<0.5	<0.5	<0.5	NA	NA	6.71
14-Nov-2013	2,665,016	<50	<49	<290	<0.5	<0.5	<0.5	<0.5	NA	NA	6.53
6-Dec-2013	2,770,675	<50	<49	<290	<0.5	<0.5	<0.5	<0.5	NA	NA	6.44
<b>2014</b>											
9-Jan-2014	2,884,292	<50	<50	<300	<0.5	<0.5	<0.5	<0.5	NA	NA	6.49
18-Feb-2014	2,953,173	<50	<50	<300	<0.5	<0.5	<0.5	<0.5	NA	NA	6.66
14-Mar-2014	2,977,698	<50	<50	<300	<0.5	<0.5	<0.5	<0.5	NA	NA	6.58
17-Apr-2014	3,035,679	89 Y	<50	<300	<0.5	<0.5	<0.5	<0.5	NA	NA	6.60
15-May-2014	3,054,723	<50	<50	<300	<0.5	<0.5	<0.5	<0.5	NA	NA	6.19
16-Jun-2014	55-Gallon polishing drum replaced due to leak										
<b>17-Jun-2014</b>	<b>3,070,826</b>	<b>&lt;50</b>	<b>&lt;49</b>	<b>&lt;290</b>	<b>&lt;0.5</b>	<b>&lt;0.5</b>	<b>&lt;0.5</b>	<b>&lt;0.5</b>	<b>NA</b>	<b>NA</b>	<b>6.74</b>

Note:

NA: Not Available/Not Applicable

< : Less than Laboratory-reporting limit

Y: Sample exhibits chromatographic pattern which does not resemble standard

In October and November 2009 discharge occurred only during MPE events

GWETS and totalizer installed in December 2009.

Week # 1 sampling conducted on Oct 8, 2009

C: Presence confirmed, but RPD between column exceeds 40%

Volume discharged during the October 2009 MPE event was 18,669 gallons

Volume discharged during the November 2009 MPE event was 10,507 gallons

Volume discharged during the December 2009 MPE event was 20,298 gallons

Volume discharged during the February 2010 MPE event was 6,339 gallons

Volume discharged during the March 2010 MPE event was 3,810 gallons

Volume discharged during the June 2010 MPE event was 15,600 gallons

Volume discharged during the August 2010 MPE event was 1,421 gallons

Volume discharged during the October 2010 MPE event was 13,282 gallons

SOMA ceased COD and TSS testing based on a request from OLSA dated April 5, 2012

**Table 4**  
**Cumulative Masses of Petroleum Hydrocarbons Removed from**  
**the Groundwater Since Installation of the Treatment System**

15101 Freedom Ave, San Leandro, CA

Date	Volume (gallons)	Influent Concentration (µg/L)					Mass removed (pounds)				
		TPH-g	Benzene	Toluene	Ethyl- benzene	Total Xylenes	TPH-g	Benzene	Toluene	Ethyl- benzene	Total Xylenes
<b>2009</b>											
9-Dec-2009	0	Installation of GWETS, began discharging treated groundwater to site sewer main									
<b>2010</b>											
18-Jan-2010	215,453	1,900	79	32.00	2.4	260	3.41	0.14	0.06	0.00	0.47
19-Apr-2010	621,180	2,100	75	28	56	332	10.50	0.40	0.15	0.19	1.59
19-Jul-2010	910,652	56 <sup>Y</sup>	<0.5	<0.5	<0.5	<0.5	10.64	0.40	0.15	0.19	1.59
26-Oct-2010	1,013,700	2,600	200	25	68	405	12.87	0.57	0.17	0.25	1.94
<b>2011</b>											
11-Jan-2011	1,179,075	1,700	80	19	50	295	15.21	0.68	0.20	0.32	2.34
11-Apr-2011	1,364,272	1,200	41	3.3	23	185	17.06	0.75	0.20	0.36	2.63
28-Jul-2011	1,573,295	540	21	2.8	5.4	49	18.00	0.78	0.21	0.37	2.71
27-Oct-2011	1,642,277	<50	1.50	<0.5	<0.5	2.9	18.00	0.78	0.21	0.37	2.71
<b>2012</b>											
19-Jan-2012	1,715,163	110 <sup>Y</sup>	<0.5	<0.5	<0.5	<0.5	18.07	0.78	0.21	0.37	2.71
17-Apr-2012	1,876,439	1,100	60	6.8	24	161	19.54	0.87	0.22	0.40	2.93
12-Jul-2012	1,943,456	320	30	1.6	15	34	19.72	0.88	0.22	0.41	2.95
23-Oct-2012	1,989,022	1,400 <sup>Y</sup>	130	12	42	153	20.25	0.93	0.22	0.42	3.01
<b>2013</b>											
7-Jan-2013	2,099,002	1,500	66	9.8	37	228	21.63	0.99	0.23	0.46	3.22
12-Apr-2013	2,198,793	1,600	110	3.8	64	131	22.96	1.08	0.24	0.51	3.32
5-Jul-2013	2,282,444	680	71	1.8	22	33.9	23.43	1.13	0.24	0.52	3.35
28-Oct-2013	2,551,538	4,900	88	49	150	583	34.41	1.33	0.35	0.86	4.65
<b>2014</b>											
9-Jan-2014	2,884,292	590	17	4.1	9.1	68	36.04	1.38	0.36	0.89	4.84
<b>17-Apr-2014</b>	<b>3,035,679</b>	<b>650</b>	<b>19</b>	<b>0.67</b>	<b>16</b>	<b>50.1</b>	<b>36.86</b>	<b>1.40</b>	<b>0.36</b>	<b>0.91</b>	<b>4.91</b>

Notes:

< : Below laboratory-reporting limit

Y : sample exhibits chromatographic pattern which does not resemble standard

# **Appendix A**

## **Standard Operating Procedures for Conducting Groundwater Monitoring Activities**

# **Standard Operating Procedures for Conducting Groundwater Monitoring Activities**

## **Water Level and Free-Product Measurements**

Prior to measurement of groundwater depth at each well, equalization with the surrounding aquifer must be achieved. Initially, the well cap is removed and the pressure is allowed to dissipate, creating a more stable water table level within the well. After about 10-15 minutes, once the water level in the well stabilizes, the depth to groundwater is measured from the top of the casing to the nearest 0.01 foot using an electric sounder.

For free-product (FP) measurement, an oil-water interface probe is used. When the probe is lowered into the FP, the oil/water light and beeper are continuously on at which point a reading for depth to FP is noted. The probe is lowered further into the well until the water signal is given (light flashes and beeps intermittently). Then the probe is carefully raised until the FP signal is given and the reading is noted. This gives the depth to interface of product and water.

## **Purging and Field Measurements**

Prior to sample collection, each well is purged using a battery-operated, 2-inch-diameter pump (Model ES-60 DC). During purging, groundwater is measured for parameters such as dissolved oxygen (DO), pH, temperature, electrical conductivity (EC), and oxygen-reduction potential (ORP) using a Hanna HI-9828 multi-parameter instrument. Turbidity is measured using a Hanna HI-98703 portable turbidimeter. The equipment is calibrated at the site using standard solutions and procedures provided by the manufacturer.

The pH of groundwater has an effect on the activity of microbial populations in the groundwater. The groundwater temperature affects the metabolic activity of bacteria. The groundwater EC is directly related to the concentration of total dissolved solids (TDS) in solution.

There is a strong correlation between the turbidity level and the biological oxygen demand of natural water bodies. The main purpose for checking the turbidity level is to provide a general overview of the extent of the suspended solids in the groundwater.

ORP is the measure of the potential for an oxidation or reduction process to occur. In the oxidation process, a molecule or ion loses one or several electrons. In the reduction process, a molecule or ion gains one or several electrons. The unit of the redox potential is the volt or millivolt. The most important redox reaction in petroleum-contaminated groundwater is the oxidation of petroleum hydrocarbons in the presence of bacteria and free molecular oxygen. Because the solubility of O<sub>2</sub> in water is low (9 mg/L at 25 °C and 11 mg/L at 5 °C), and

because the rate of  $O_2$  replenishment in subsurface environments is limited, DO can be entirely consumed when the oxidation of only a small amount of petroleum hydrocarbons occurs.

Oxidation of petroleum hydrocarbons can still occur when all the dissolved  $O_2$  in the groundwater is consumed; however, the oxidizing agents (i.e., the constituents that undergo reduction) now become  $NO_3^-$ ,  $MnO_2$ ,  $Fe(OH)_3$ ,  $SO_4^{2-}$  and others (Freeze and Cherry, 1979). As these oxidizing agents are consumed, the groundwater environment becomes more and more reduced. If the process advances far enough, the environment may become so strongly reduced that the petroleum hydrocarbons undergo anaerobic degradation, resulting in the production of methane and carbon dioxide. The concept of oxidation and reduction in terms of changes in oxidation states is illustrated below.

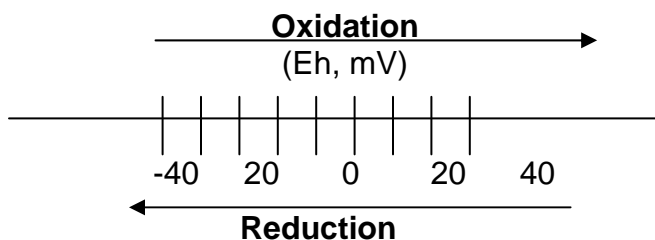

Purging of wells continues until the parameters for DO, pH, temperature, EC, turbidity, and redox stabilize, or three casing volumes are purged.

Once stabilization occurs, the groundwater samples are also tested on-site for ferrous iron ( $Fe^{+2}$ ), nitrate ( $NO_3^-$ ), and sulfate ( $SO_4^{2-}$ ) concentrations.

$Fe^{+2}$ ,  $NO_3^-$ , and  $SO_4^{2-}$  are measured colorimetrically using the Hach Colorimeter Model 890, a microprocessor-controlled photometer suitable for colorimetric testing in the laboratory or the field. The required reagents for each specific test are provided in AccuVac ampuls.

## Sampling

For sampling purposes, after purging a disposable polyethylene bailer is used to collect sufficient samples from each monitoring well for laboratory analyses. Groundwater samples are transferred into 40-mL VOA vials and preserved with hydrochloric acid. The vials are sealed to prevent air bubbles from developing within the headspace. For TPH-d analysis, groundwater samples are collected using 1-L, amber, non-preserved glass containers. Samples are placed in an ice-filled cooler and maintained at  $4^\circ C$ . A chain of custody form for all samples is prepared to accompany the samples, which are promptly delivered to a California state-certified analytical laboratory.

# Appendix B

Table of Elevations and Coordinates on Monitoring Wells,  
Field Measurements of Physical, Chemical, and Natural  
Attenuation Parameters of Groundwater Samples, and  
Groundwater Gradient Calculations

# *Harrington Surveys Inc.*

## *Land Surveying & Mapping*

2278 Larkey Lane, Walnut Creek, Ca. 94596 Phone (925)935-7228 Fax (925)935-5118  
Cel (925)788-7359 E-Mail (ben5132@pacbell.net)

Soma Environmental Engineering  
2680 Bishop Dr. # 203  
San Ramon, Ca. 94583

Oct. 14, 2004

Attn: Elena Manzo  
Job # 2445

Ref: 15101 Freedom Ave, San Leandro, Ca.

**HORIZONTAL CONTROL, NAD 88:**

Survey based on California Coordinate System, Zone 3, NAD 83.

CHABOT "B", NORTH 2,087,731.02 EAST 6,094,039.23 sft. LAT. N37°43'02.71762"  
W122°07'00.46339", NAVD 88, ELEV. 134.957.

CHABOT "A", NORTH 2,088,584.99 EAST 6,093,351.39 sft. LAT. N37°43'11.04190"  
W122°07'09.20691", NAVD 88, ELEV. 492.08.

**VERTICAL CONTROL, NAVD 88:**

NGS 1974, STATION K 1256, NAVD 88 ELEV. 58.50.  
PID # HT1871

GPS: TRIMBLE 5800, LEICA TCA 1800, 1" HORZ. & VERT.

EPOCH DATE 1998.5

OBSERVATION: EPOCH=180.

FIELD SURVEY: OCT. 11, 2004.

  
Ben Harrington  
PLS 5132





SURVEY REPORT  
 15101 FREEDOM AVE  
 SAN LEANDRO, CA.

HARRINGTON SURVEYS INC.  
 2278 LARKEY LANE  
 WALNUT CREEK, CA. 94597  
 925-935-7228 FAX. 935-5118

JOB NO. 2445  
 DATE: OCT. 12, 2004

	NAD 83	NAD 83	NAVD 88		NORTH	WEST
PT	NORTH (sft)	EAST(sft)	ELEV.	DESCRIPTION	LATITUDE (DMS)	LONGITUDE (DMS)
1	2087731.02	6094039.23	442.77	FD CHABOT B	37°43'02.71762"	122°07'00.46339"
2	2088584.99	6093351.39	492.08	FD CHABOT A	37°43'11.04190"	122°07'09.20691"
51	2084348.54	6092159.32	55.44	FD. X-8		
52	2084073.17	6092141.24	46.15	MW-6 PAV		
53	2084072.72	6092140.95	46.15	MW-6 PUNCH		
54	2084072.47	6092140.95	45.82	MW-6 NOTCH	37°42'26.22635"	122°07'23.29643
55	2083909.71	6091947.10	40.61	MW-9 PAV		
56	2083909.10	6091946.97	40.61	MW-9 PUNCH		
57	2083908.71	6091947.00	40.26	MW-9 NOTCH	37°42'24.57425"	122°07'25.67431"
58	2083861.20	6092118.11	41.38	MW-8 PAV		
59	2083860.43	6092118.36	41.44	MW-8 PUNCH		
60	2083860.03	6092118.52	41.14	MW-8 NOTCH	37°42'24.12245"	122°07'23.52966"
61	2084008.21	6092290.11	44.94	MW-7 PAV		
62	2084007.88	6092290.27	44.95	MW-7 PVNCH		
63	2084007.68	6092290.40	44.74	MW-7 NOTCH	37°42'25.61150"	122°07'21.42290"
64	2084206.49	6092175.95	51.03	MW-5 PAV		
65	2084206.17	6092176.55	50.96	MW-5 PUNCH		
66	2084206.01	6092176.79	50.53	MW-5 NOTCH	37°42'27.55260	122°07'22.87930
67	2084670.41	6092307.68	69.79	FD BM FAIR580		
68	2084443.65	6092198.88	53.70	MW-4 PAV		
69	2084444.39	6092199.72	53.74	MW-4 PUNCH		
70	2084444.59	6092199.51	53.31	MW-4 NOTCH	37°42'29.91496"	122°07'22.64809"
71	2084399.10	6092145.43	54.37	MW-3 PAV		
72	2084399.78	6092145.28	54.33	MW-3 PUNCH		
73	2084400.15	6092145.27	53.91	MW-3 NOTCH	37°42'29.46636"	122°07'23.31339"
74	2084329.47	6092199.72	54.82	MW-1 PAV		
75	2084330.44	6092199.45	54.79	MW-1 PUNCH		
76	2084330.75	6092199.20	54.46	MW-1 NOTCH	37°42'28.78955"	122°07'22.62738"
77	2084367.59	6092256.38	52.88	MW-2 PAV		
78	2084368.15	6092256.14	52.92	MW-2 PUNCH		
79	2084368.53	6092256.06	52.41	MW-2 NOTCH	37°42'29.17277"	122°07'21.92804"
80	2084930.49	6091759.33	58.50	FD BM K1256	37°42'34.64279"	122°07'28.23011"



DATE: 1/08/2008  
 JOB NUMBER 0208101  
 DATE OF SURVEY 1/03/08  
 INSTRUMENT LIECA SR520

TABLE OF ELEVATIONS & COORDINATES  
 ON MONITORING WELLS  
 SOMA ENVIRONMENTAL, PROJECT 15101 FREEDOM DRIVE - SAN LEANDRO

WELL ID#	NORTHING (ft.) LATITUDE	EASTING (ft.) LONGITUDE	ELEVATION (ft.)	DESCRIPTION
MW-1D	2084371.23	6092127.90	54.42	MW-1D NOTCH
	37.708104856	122.123200912	54.94	MW-1D RIM
	37° 42' 29.1" N	122° 07' 23" W	54.74	PAVEMENT
MW-3D	2084303.98	6092183.53	54.10	MW-3D NOTCH
	37.707922851	122.123004590	54.56	MW-3D RIM
	37° 42' 28.5" N	122° 07' 22" W	54.47	PAVEMENT
MW-4D	2084222.77	6092116.37	53.12	MW-4D NOTCH
	37.707696648	122.123231858	53.37	MW-4D RIM
	37° 42' 27.7" N	122° 07' 23" W	53.39	PAVEMENT

BENCH MARK: NGS BENCH MARK NO. HT1871

3.0 KM (1.85 MI) NORTH FROM SAM LORENZO. 1.85 MILES NORTH ALONG INTERSTATE HIGHWAY 580 FROM THE JUNCTION OF STATE HIGHWAY 238 IN SAN LORENZO, IN THE WEST CORNER OF THE CROSSING OF 150TH AVENUE, IN TOP OF THE CONCRETE BRIDGE DECK, 15.5 FEET NORTHWEST OF THE SOUTHWEST BOUND LANES OF THE AVENUE, 10.9 FEET NORTHEAST OF THE SOUTH CORNER OF THE SOUTHWEST END OF THE NORTHWEST CONCRETE GUARDRAIL, 0.7 FOOT NORTHEAST OF THE SOUTHWEST EDGE OF THE DECK, 0.9 FOOT SOUTHEAST OF THE NORTHWEST CONCRETE GUARDRAIL, AND ABOUT LEVEL WITH THE HIGHWAY.

ELEVATION = 58.50 NAVD 88 DATUM

HORIZONTAL AND VERTICAL CONTROL BASED ON HARRINGTON SURVEY DATED 10-12-2004

FD CHABOT A, CALIFORNIA STATE PLAIN COORDINATE SYSTEM, NAD 83, ZONE 3. NORTH 2,088,584.99 EAST 6,093,351.39. LAT N 37°43'11.04190" LONG W 122°07'09.20691", ELEVATION 492.08 NAVD 88.

FD CHABOT B, CALIFORNIA STATE PLAIN COORDINATE SYSTEM, NAD 83, ZONE 3. NORTH 2,087,731.02 EAST 6,094,039.23. . LAT N 37°43'02.71762" LONG W 122°07'00.46339", ELEVATION 442.77 NAVD 88.



DATE: 12/11/2009

JOB# 09039

**TABLE OF ELEVATIONS & COORDINATES  
ON MONITORING WELLS**

SOMA ENVIRONMENTAL ENGINEERING  
15101 FREEDOM AVENUE  
SAN LEANDRO, CA 94579

WELL ID #	NORTHING (FT.) / LATITUDE (D.DEG.)	EASTING (FT.) / LONGITUDE (D.DEG.)	ELEVATION (FT.)	DESCRIPTION
EX-1	2084135.454	6092163.720	47.36	4" PVC NOTCH NORTH SIDE
	37.707459134	122.123062972	47.61	SET PUNCH NORTH SIDE RIM
			47.60	PAVEMENT NORTH SIDE
EX-2	2084082.018	6092130.224	45.96	4" PVC NOTCH NORTH SIDE
	37.707310806	122.123175540	47.04	SET PUNCH NORTH SIDE RIM
			47.00	CONCRETE NORTH SIDE
MPE-1	2084213.168	6092125.258	51.96	4" PVC NOTCH NORTH SIDE
	37.707670702	122.123200567	52.49	SET PUNCH NORTH SIDE RIM
			52.51	CONCRETE NORTH SIDE
MPE-2	2084293.133	6092171.374	53.72	4" PVC NOTCH NORTH SIDE
	37.707892479	122.123045970	54.29	SET PUNCH NORTH SIDE RIM
			54.27	PAVEMENT NORTH SIDE

**HORIZONTAL AND VERTICAL CONTROL**

SURVEY BASED ON PREVIOUS SURVEY BY HARRINGTON SURVEY INC. DATED: 2/21/2008  
COORDINATE VALUES ARE BASED ON THE CALIFORNIA COORDINATE SYSTEM, ZONE 3, NAD83.  
ELEVATIONS ARE NAVD 88 DATUM.

**MW-2, PUNCH**

NORTHING 2,084323.44, EASTING 6,092063.77, ELEVATION 52.92

**MW-4 PUNCH**

NORTHING 2,084250.55, EASTING 6,092124.46, ELEVATION 53.74

EQUIPMENT USED: TRIMBLE S6

**Edgis Land Surveying**  
Land Surveying and mapping  
1374 Garland Avenue, Clovis, CA 93612  
Phone (559) 906-3554 Fax (559) 292-0560  
email: edgis@aol.com



*[Handwritten Signature]* 1 of 1

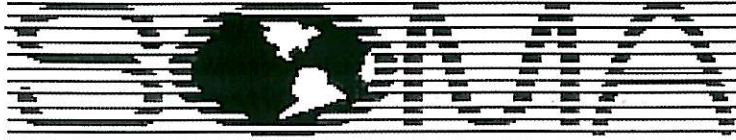

ENVIRONMENTAL ENGINEERING, INC

Well No.: MW-1  
 Casing Diameter: 4 inches  
 Depth of Well: 30.50 feet  
 Top of Casing Elevation: 54.46 feet  
 Depth to Groundwater: 23.46 feet  
 Groundwater Elevation: 31.00 feet  
 Water Column Height: 7.04 feet  
 Purged Volume: 12 gallons

Project No.: 2551  
 Address: 15101 Freedom Avenue  
 San Leandro, CA  
 Date: June 6, 2014  
 Sampler: Lizzie Hightower

Purging Method: Bailer  Pump

Sampling Method: Bailer  Pump

Color: Yes  No  Describe: \_\_\_\_\_

Sheen: Yes  No  Describe: \_\_\_\_\_

Odor: Yes  No  Describe: Slight Petro

Field Measurements:

Time	Volume (gallons)	D.O. mg/L	pH	Temp °C	E.C. (µS/cm)	Turb. NTU	ORP
10:02	Started purging well						
10:03	2	3.13	6.77	19.06	869	9.87	+20.0
10:05	6	2.33	6.73	19.07	855	7.99	+28.3
10:07	10	2.69	6.71	19.08	962	9.15	+26.7
10:08	12	2.58	6.70	19.06	1041	8.23	+21.6
10:13	Sampled						

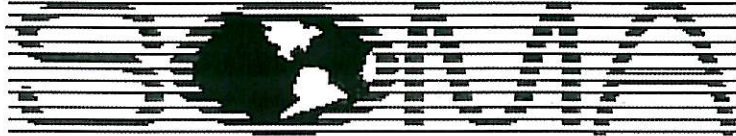

ENVIRONMENTAL ENGINEERING, INC

Well No.: MW-2 Project No.: 2551  
 Casing Diameter: 4 inches Address: 15101 Freedom Avenue  
 Depth of Well: 30.15 feet San Leandro, CA  
 Top of Casing Elevation: 52.41 feet Date: June 6, 2014  
 Depth to Groundwater: 21.70 feet Sampler: Lizzie Hightower  
 Groundwater Elevation: 30.71 feet  
 Water Column Height: 8.45 feet  
 Purged Volume: 12 gallons

Purging Method: Bailer  Pump   
 Sampling Method: Bailer  Pump

Color: Yes  No  Describe: \_\_\_\_\_  
 Sheen: Yes  No  Describe: \_\_\_\_\_  
 Odor: Yes  No  Describe: Slight Petro

Field Measurements:

Time	Volume (gallons)	D.O. mg/L	pH	Temp °C	E.C. (µS/cm)	Turb. NTU	ORP
09:36	Started purging well						
09:37	2	4.04	6.72	18.92	765	12.3	+20.2
09:39	6	2.48	6.65	19.96	747	9.29	+23.7
09:41	10	1.36	6.77	18.99	873	9.27	+18.3
09:42	12	1.11	6.80	18.99	951	9.36	+20.3
09:47	Sampled						



ENVIRONMENTAL ENGINEERING, INC

Well No.: MW-3  
 Casing Diameter: 4 inches  
 Depth of Well: 29.90 feet  
 Top of Casing Elevation: 53.91 feet  
 Depth to Groundwater: 23.08 feet  
 Groundwater Elevation: 30.84 feet ↗  
 Water Column Height: 6.82 feet  
 Purged Volume: - gallons  
Not purged

Project No.: 2551  
 Address: 15101 Freedom Avenue  
 San Leandro, CA  
 Date: June 5, 2014  
 Sampler: Lizzie Hightower

Purging Method: Bailer  Pump

Sampling Method: Bailer  Pump  Not sampled

Color: Yes  No  Describe: Unknown

Sheen: Yes  No  Describe: Free Product

Odor: Yes  No  Describe: Strong Petro

Field Measurements:

Time	Volume (gallons)	D.O. mg/L	pH	Temp °C	E.C. (µS/cm)	Turb. NTU	ORP

Depth to free product: 23.06  
 0.02 feet of FP.  
 \* Calculated for presence of FP



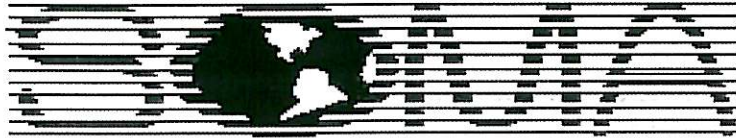

ENVIRONMENTAL ENGINEERING, INC

Well No.: MW-4 Project No.: 2551  
 Casing Diameter: 4 inches Address: 15101 Freedom Avenue  
 Depth of Well: 30.20 feet San Leandro, CA  
 Top of Casing Elevation: 53.31 feet Date: June 6, 2014  
 Depth to Groundwater: 22.97 feet Sampler: Lizzie Hightower  
 Groundwater Elevation: 30.34 feet  
 Water Column Height: 7.23 feet  
 Purged Volume: 12 gallons

Purging Method: Bailer  Pump   
 Sampling Method: Bailer  Pump   
 Color: Yes  No  Describe: \_\_\_\_\_  
 Sheen: Yes  No  Describe: \_\_\_\_\_  
 Odor: Yes  No  Describe: Slight Petro

Field Measurements:

Time	Volume (gallons)	D.O. mg/L	pH	Temp °C	E.C. (µS/cm)	Turb. NTU	ORP
11:00	Started purging well						
11:01	2	1.32	7.00	18.85	914	9.50	+56.7
11:03	6	1.23	6.72	18.81	1120	10.2	+73.5
11:05	10	1.41	6.67	18.81	1171	6.81	+80.2
11:06	12	1.15	6.67	18.81	1194	5.67	+81.9
11:11	Sampled						

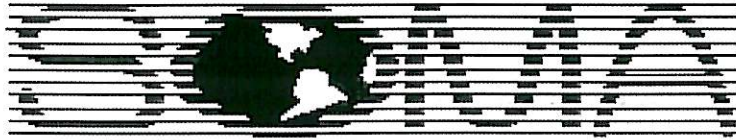

ENVIRONMENTAL ENGINEERING, INC

Well No.: MW-5  
 Casing Diameter: 4 inches  
 Depth of Well: 29.80 feet  
 Top of Casing Elevation: 50.53 feet  
 Depth to Groundwater: 20.27 feet  
 Groundwater Elevation: 30.26 feet  
 Water Column Height: 9.53 feet  
 Purged Volume: 12 gallons

Project No.: 2551  
 Address: 15101 Freedom Avenue  
 San Leandro, CA  
 Date: June 6, 2014  
 Sampler: Lizzie Hightower

Purging Method: Bailer  Pump

Sampling Method: Bailer  Pump

Color: Yes  No  Describe: \_\_\_\_\_

Sheen: Yes  No  Describe: \_\_\_\_\_

Odor: Yes  No  Describe: Very Slight Petro

Field Measurements:

Time	Volume (gallons)	D.O. mg/L	pH	Temp °C	E.C. (µS/cm)	Turb. NTU	ORP
10:36	Started purging well						
10:37	2	2.47	7.25	19.96	1234	21.3	+36.7
10:39	6	1.26	7.16	19.95	1227	9.35	+32.7
10:41	10	0.86	7.10	19.95	1217	9.14	+25.0
10:42	12	0.76	7.11	19.94	1214	9.67	+21.9
10:47	sampled						

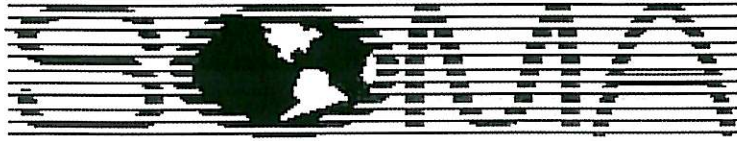

ENVIRONMENTAL ENGINEERING, INC

Well No.: MW-6  
 Casing Diameter: 4 inches  
 Depth of Well: 27.30 feet  
 Top of Casing Elevation: 45.82 feet  
 Depth to Groundwater: 18.15 feet  
 Groundwater Elevation: 27.67 feet  
 Water Column Height: 9.15 feet  
 Purged Volume: 14 gallons

Project No.: 2551  
 Address: 15101 Freedom Avenue  
 San Leandro, CA  
 Date: June 5, 2014  
 Sampler: Lizzie Hightower

Purging Method: Bailer  Pump

Sampling Method: Bailer  Pump

Color: Yes  No  Describe: Slightly Cloudy  
 Sheen: Yes  No  Describe: Slight Rainbow sheen  
 Odor: Yes  No  Describe: Petro odor

Field Measurements:

Time	Volume (gallons)	D.O. mg/L	pH	Temp °C	E.C. (µS/cm)	Turb. NTU	ORP
13:24	Started purging well						
13:25	2	1.33	6.90	19.68	1300	12.5	+58.2
13:26	4	1.43	6.86	19.68	1300	12.3	+36.7
13:28	8	3.54	6.72	19.66	1299	12.9	+24.5
13:30	12	3.71	6.72	19.65	1299	11.5	+27.3
13:31	14	3.02	6.74	19.63	1300	10.5	+31.7
13:36	Sampled						









ENVIRONMENTAL ENGINEERING, INC

Well No.: MPE-1  
 Casing Diameter: 4 inches  
 Depth of Well: 30.00 feet  
 Top of Casing Elevation: 51.96 feet  
 Depth to Groundwater: 21.89 feet  
 Groundwater Elevation: 30.08 feet →  
 Water Column Height: 8.11 feet  
 Purged Volume: - gallons  
Not purged

Project No.: 2551  
 Address: 15101 Freedom Avenue  
 San Leandro, CA  
 Date: June 5, 2014  
 Sampler: Lizzie Hightower

Purging Method: Bailer  Pump   
 Sampling Method: Bailer  Pump  Not sampled

Color: Yes  No  Describe: Unknown  
 Sheen: Yes  No  Describe: Free Product  
 Odor: Yes  No  Describe: Strong Petro

Field Measurements:

Time	Volume (gallons)	D.O. mg/L	pH	Temp °C	E.C. (µS/cm)	Turb. NTU	ORP

Depth to Free Product: 21.80  
 0.09 feet of FP  
 \* calculated for presence of FP

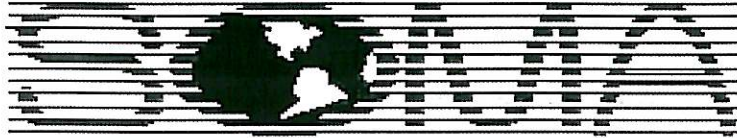

ENVIRONMENTAL ENGINEERING, INC

Well No.: MPE-2  
 Casing Diameter: 4 inches  
 Depth of Well: 30.00 feet  
 Top of Casing Elevation: 53.72 feet  
 Depth to Groundwater: 22.96 feet  
 Groundwater Elevation: 30.77 feet ↗  
 Water Column Height: 7.04 feet  
 Purged Volume: - gallons  
not purged

Project No.: 2551  
 Address: 15101 Freedom Avenue  
 San Leandro, CA  
 Date: June 5, 2014  
 Sampler: Lizzie Hightower

Purging Method: Bailer  Pump   
 Sampling Method: Bailer  Pump  Not sampled

Color: Yes  No  Describe: Unknown  
 Sheen: Yes  No  Describe: Free Product  
 Odor: Yes  No  Describe: Strong Petro odor

Field Measurements:

Time	Volume (gallons)	D.O. mg/L	pH	Temp °C	E.C. (µS/cm)	Turb. NTU	ORP

Depth to Free Product: 22.94  
 0.02 feet of FP.  
 ↗ Calculated for presence of FP



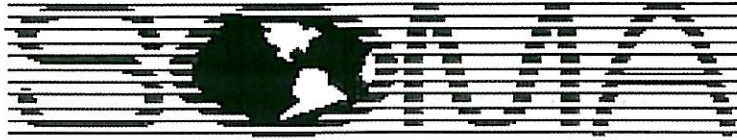

**ENVIRONMENTAL ENGINEERING, INC**

Well No.: MW-1D  
 Casing Diameter: 2 inches  
 Depth of Well: 59.81 feet  
 Top of Casing Elevation: 54.42 feet  
 Depth to Groundwater: 23.68 feet  
 Groundwater Elevation: 30.74 feet  
 Water Column Height: 36.13 feet  
 Purged Volume: 14 gallons

Project No.: 2551  
 Address: 15101 Freedom Avenue  
 San Leandro, CA  
 Date: June 5, 2014  
 Sampler: Lizzie Hightower

Purging Method: Bailer  Pump

Sampling Method: Bailer  Pump

Color: Yes  No  Describe: \_\_\_\_\_

Sheen: Yes  No  Describe: \_\_\_\_\_

Odor: Yes  No  Describe: \_\_\_\_\_

**Field Measurements:**

Time	Volume (gallons)	D.O. mg/L	pH	Temp °C	E.C. (µS/cm)	Turb. NTU	ORP
14:18	Started purging well						
14:19	2	2.28	7.44	18.37	1189	8.52	+176.4
14:20	4	2.32	7.38	18.29	1189	9.10	+177.0
14:22	8	1.90	7.25	18.24	1189	17.8	+174.7
14:24	12	1.52	7.23	18.24	1187	12.9	+180.2
14:25	14	1.37	7.26	18.23	1189	11.3	+174.1
14:30	Sampled						

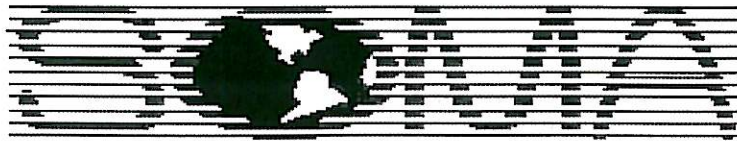

ENVIRONMENTAL ENGINEERING, INC

Well No.: MW-3D  
 Casing Diameter: 2 inches  
 Depth of Well: 59.81 feet  
 Top of Casing Elevation: 54.10 feet  
 Depth to Groundwater: 23.33 feet  
 Groundwater Elevation: 30.77 feet  
 Water Column Height: 36.48 feet  
 Purged Volume: 14 gallons

Project No.: 2551  
 Address: 15101 Freedom Avenue  
 San Leandro, CA  
 Date: June 5, 2014  
 Sampler: Lizzie Hightower

Purging Method: Bailer  Pump   
 Sampling Method: Bailer  Pump

Color: Yes  No  Describe: \_\_\_\_\_  
 Sheen: Yes  No  Describe: \_\_\_\_\_  
 Odor: Yes  No  Describe: \_\_\_\_\_

Field Measurements:

Time	Volume (gallons)	D.O. mg/L	pH	Temp °C	E.C. (µS/cm)	Turb. NTU	ORP
14:48	Started purging well						
14:50	2	1.37	7.99	18.75	957	8.32	+184.2
14:51	4	1.21	7.32	18.79	1120	7.14	+181.9
14:53	8	1.33	7.23	18.80	1168	6.50	+179.6
14:55	12	1.44	7.21	18.80	1182	5.22	+178.2
14:56	14	1.39	7.23	18.80	1186	4.36	+177.6
15:01	Sampled						

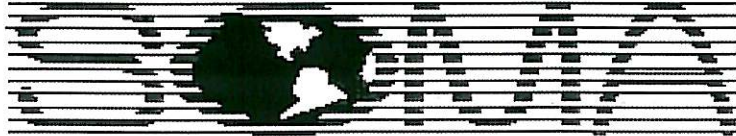

ENVIRONMENTAL ENGINEERING, INC

Well No.: MW-4D  
 Casing Diameter: 2 inches  
 Depth of Well: 58.79 feet  
 Top of Casing Elevation: 53.12 feet  
 Depth to Groundwater: 22.78 feet  
 Groundwater Elevation: 30.34 feet  
 Water Column Height: 36.01 feet  
 Purged Volume: 14 gallons

Project No.: 2551  
 Address: 15101 Freedom Avenue  
 San Leandro, CA  
 Date: June 6, 2014  
 Sampler: Lizzie Hightower

Purging Method: Bailer  Pump

Sampling Method: Bailer  Pump

Color: Yes  No  Describe: \_\_\_\_\_

Sheen: Yes  No  Describe: \_\_\_\_\_

Odor: Yes  No  Describe: \_\_\_\_\_

Field Measurements:

Time	Volume (gallons)	D.O. (mg/L)	pH	Temp (°C)	E.C. (µS/cm)	Turb. (NTU)	ORP
08:54	Started purging well						
08:55	2	4.94	7.10	17.85	1160	11.1	+72.0
08:56	4	3.58	7.16	17.80	1176	6.29	+94.8
08:58	8	2.42	7.22	17.78	1180	11.2	+112.7
09:00	12	1.95	7.23	17.78	1179	8.29	+125.0
09:01	14	1.81	7.23	17.79	1178	8.83	+131.9
09:06	Sampled						



# EPA On-line Tools for Site Assessment Calculation

## Hydraulic Gradient -- Magnitude and Direction

**Gradient Calculation** from fitting a plane to as many as thirty points

$$\begin{aligned}
 a x_1 + b y_1 + c &= h_1 \\
 a x_2 + b y_2 + c &= h_2 \\
 a x_3 + b y_3 + c &= h_3 \\
 &\dots \\
 a x_{30} + b y_{30} + c &= h_{30}
 \end{aligned}$$

where  $(x_i, y_i)$  are the coordinates of the well and  $h_i$  is the head

$i = 1, 2, 3, \dots, 30$

The coefficients  $a$ ,  $b$ , and  $c$  are calculated by a least-squares fitting of the the data to a plane

The gradient is calculated from the square root of  $(a^2 + b^2)$  and the angle from the arctangent of  $a/b$  or  $b/a$  depending on the quadrant

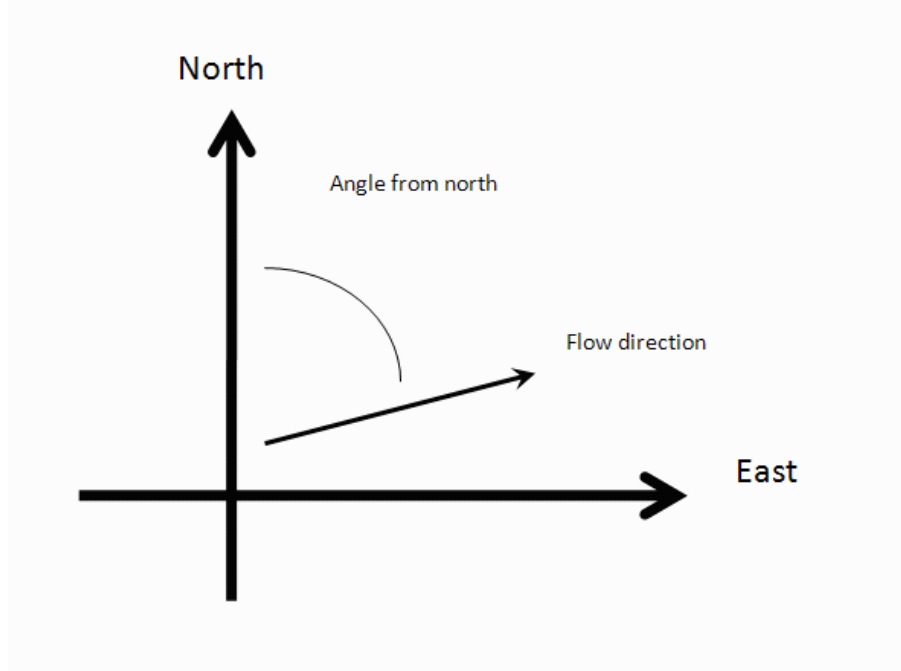

### Inputs

Site Name

Date

Calculation basis

Coordinates

I.D.	x-coordinate	y-coordinate	head	ft
1) MW-1	6092119.016	2084364.691	31.00	
2) MW-2	6092063.978	2084323.224	30.71	
3) MW-3	6092176.317	2084298.343	30.84	
4) MW-4	6092124.294	2084251.598	30.34	
5) MW-5	6092177.071	2084206.361	30.26	
6) MW-6	6092140.881	2084072.911	27.67	
7) MW-7	6092290.918	2084008.071	29.56	
8) EX-1	6092163.5	2084133.982	26.05	
9) EX-2	6092131.08	2084082.713	22.55	
10) MPE-1	6092125.048	2084212.393	30.13	
11) MPE-2	6092171.793	2084292.312	30.77	
12)				
13)				

14)			
15)			
16)			
17)			
18)			
19)			
20)			
21)			
22)			
23)			
24)			
25)			
26)			
27)			
28)			
29)			
30)			

**Results**

Number of Points Used in Calculation	11
Max. Difference Between Head Values	2.576
Gradient Magnitude (i)	0.03449
Flow direction as degrees from North (positive y axis)	230.1
Coefficient of Determination (R <sup>2</sup> )	0.631

WCMS

Last updated on 1/10/2013



# EPA On-line Tools for Site Assessment Calculation

[Module Home](#) [Objectives](#) [Table of Contents](#) [Previous](#) < [Next](#) >

## Hydraulic Gradient

**Gradient Calculation** from fitting a plane to three points

$$a x_1 + b y_1 + c = h_1$$

$$a x_2 + b y_2 + c = h_2$$

$$a x_3 + b y_3 + c = h_3$$

where  $(x_i, y_i)$  are the coordinates of the well and

$h_i$  is the head

$i = 1, 2, 3$

The gradient is calculated from the square root of  $(a^2 + b^2)$  and the angle from the arctangent of  $a/b$  or  $b/a$  depending on the quadrant

<input type="button" value="Example Data Set 1"/>	<input type="button" value="Calculate"/>	<input type="button" value="Clear"/>
<input type="button" value="Save Data"/>	<input type="button" value="Recall Data"/>	<input type="button" value="Go Back"/>
Site Name <input type="text" value="15101 Freedom Ave"/>		
Date <input type="text" value="June 5, 2014"/>	<input type="button" value="Current Date"/>	
Calculation basis <input type="text" value="Head"/>		
Coordinates <input type="text" value="ft"/>		
x-coordinate	y-coordinate	head <input type="text" value="ft"/>
<input type="text" value="6092128.064"/>	<input type="text" value="2084372.231"/>	<input type="text" value="30.74"/>
<input type="text" value="6092183.856"/>	<input type="text" value="2084303.621"/>	<input type="text" value="30.77"/>
<input type="text" value="6092116.755"/>	<input type="text" value="2084222.948"/>	<input type="text" value="30.34"/>
Gradient Magnitude (i) <input type="text" value="0.004257"/>		
Degrees from North (+ y axis) <input type="text" value="235.5"/>		

[Previous](#) [Top](#) [Next](#)

[Home](#) | [Glossary](#) | [Notation](#) | [Links](#) | [References](#) | [Calculators](#)

# Appendix C

Laboratory Reports and Chain of Custody Forms  
for the Second Quarter 2014 Monitoring Event



Curtis & Tompkins, Ltd., Analytical Laboratories, Since 1878

2323 Fifth Street, Berkeley, CA 94710, Phone (510) 486-0900

Laboratory Job Number 257759
ANALYTICAL REPORT

SOMA Environmental Engineering Inc.
6620 Owens Dr.
Pleasanton, CA 94588

Project : 2551
Location : 15101 Freedom Avenue San Leandro
Level : II

Table with 2 columns: Sample ID, Lab ID. Rows include MW-1 through MW-7, MW-1D through MW-4D, EX-1, and EX-2.

This data package has been reviewed for technical correctness and completeness. Release of this data has been authorized by the Laboratory Manager or the Manager's designee, as verified by the following signature. The results contained in this report meet all requirements of NELAC and pertain only to those samples which were submitted for analysis. This report may be reproduced only in its entirety.

Signature: [Handwritten Signature]
Tracy Babjar
Project Manager
tracy.babjar@ctberk.com
(510) 204-2226

Date: 06/19/2014



### CASE NARRATIVE

Laboratory number: 257759  
Client: SOMA Environmental Engineering Inc.  
Project: 2551  
Location: 15101 Freedom Avenue San Leandro  
Request Date: 06/06/14  
Samples Received: 06/06/14

This data package contains sample and QC results for eleven water samples, requested for the above referenced project on 06/06/14. The samples were received cold and intact.

#### Volatile Organics by GC/MS (EPA 8260B):

Low response was observed for tert-butyl alcohol (TBA) in the CCV analyzed 06/17/14 09:51; this analyte met minimum response criteria, and affected data was qualified with "b". High response was observed for 1,2-dichloroethane in the CCV analyzed 06/15/14 13:54; affected data was qualified with "b". High recovery was observed for 1,2-dichloroethane in the BSD for batch 212210; the associated RPD was within limits, and the high recovery was not associated with any reported results. High surrogate recovery was observed for 1,2-dichloroethane-d4 in the BSD for batch 212210. No other analytical problems were encountered.

# CHAIN OF CUSTODY

## Curtis & Tompkins, Ltd.

Analytical Laboratory Since 1878  
 2323 Fifth Street  
 Berkeley, CA 94710  
 (510)486-0900 Phone  
 (510)486-0532 Fax

## Analyses

C&T LOGIN # 257759

Sampler: Lizzie Hightower

Project No: 2551

Report To: Joyce Bobek

Project Name: 15101 Freedom Ave., San Leandro

Company: SOMA Environmental

Turnaround Time: Standard

Telephone: 925-734-6400

Fax: 925-734-6401

Lab No.	Sample ID.	Sampling Date Time		Matrix			# of Containers	Preservative				TPHg, BTEX, MtBE 8260B	Gasoline Oxygenates & Lead Scavengers
				Soil	Water	Waste		HCL	H <sub>2</sub> SO <sub>4</sub>	HNO <sub>3</sub>	ICE		
1	MW-1	6/6/14	10:13	*			3-VOAs	*			*		
2	MW-2	6/6/14	09:47	*			3-VOAs	*			*		
	<del>MW-3</del>			*			<del>3-VOAs</del>	<del>*</del>			<del>*</del>		
3	MW-4	6/6/14	11:11	*			3-VOAs	*			*		
4	MW-5	6/6/14	10:47	*			3-VOAs	*			*		
5	MW-6	6/5/14	13:36	*			3-VOAs	*			*		
6	MW-7	6/5/14	13:09	*			3-VOAs	*			*		
7	MW-1D	6/5/14	14:30	*			3-VOAs	*			*		
8	MW-3D	6/5/14	15:01	*			3-VOAs	*			*		
9	MW-4D	6/6/14	09:06	*			3-VOAs	*			*		
10	EX-1	6/5/14	14:00	*			3-VOAs	*			*		
11	EX-2	6/5/14	13:50	*			3-VOAs	*			*		
	<del>MPE-1</del>			*			<del>3-VOAs</del>	<del>*</del>			<del>*</del>		
	<del>MPE-2</del>			*			<del>3-VOAs</del>	<del>*</del>			<del>*</del>		

Notes: **EDF OUTPUT REQUIRED**

Ethanol

ON BLUE ICE

RELINQUISHED BY:

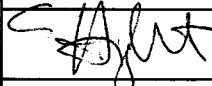
 6/6/14  
 12:36 DATE/TIME

RECEIVED BY:

 6/6/14 1236  
 DATE/TIME

DATE/TIME

DATE/TIME

DATE/TIME

DATE/TIME

COOLER RECEIPT CHECKLIST



Login # 257759 Date Received 6/6/14 Number of coolers 0
Client SOMA Project 2551

Date Opened 6/6/14 By (print) MT (sign) [Signature]
Date Logged in [Signature] By (print) [Signature] (sign) [Signature]

1. Did cooler come with a shipping slip (airbill, etc) YES NO
Shipping info

2A. Were custody seals present? ... YES (circle) on cooler on samples NO
How many Name Date

2B. Were custody seals intact upon arrival? YES NO N/A

3. Were custody papers dry and intact when received? YES NO

4. Were custody papers filled out properly (ink, signed, etc)? YES NO

5. Is the project identifiable from custody papers? (If so fill out top of form) YES NO

6. Indicate the packing in cooler: (if other, describe)

- Bubble Wrap, Cloth material, Foam blocks, Cardboard, Bags, Styrofoam, None, Paper towels

7. Temperature documentation: \* Notify PM if temperature exceeds 6°C

Type of ice used: Wet, Blue/Gel, None Temp(°C)

Samples received on ice & cold without a temperature blank; temp taken with IR gun

Samples received on ice directly from the field. Cooling process had begun

8. Were Method 5035 sampling containers present? YES NO
If YES, what time were they transferred to freezer?

9. Did all bottles arrive unbroken/unopened? YES NO

10. Are there any missing / extra samples? YES NO

11. Are samples in the appropriate containers for indicated tests? YES NO

12. Are sample labels present, in good condition and complete? YES NO

13. Do the sample labels agree with custody papers? YES NO

14. Was sufficient amount of sample sent for tests requested? YES NO

15. Are the samples appropriately preserved? YES NO N/A

16. Did you check preservatives for all bottles for each sample? YES NO N/A

17. Did you document your preservative check? YES NO N/A

18. Did you change the hold time in LIMS for unpreserved VOAs? YES NO N/A

19. Did you change the hold time in LIMS for preserved terracores? YES NO N/A

20. Are bubbles > 6mm absent in VOA samples? YES NO N/A

21. Was the client contacted concerning this sample delivery? YES NO

If YES, Who was called? By Date:

COMMENTS

Blank lines for handwritten comments.

Detections Summary for 257759

Client : SOMA Environmental Engineering Inc.  
 Project : 2551  
 Location : 15101 Freedom Avenue San Leandro

Client Sample ID : MW-1                                  Laboratory Sample ID :                                  257759-001

Analyte	Result	Flags	RL	MDL	Units	Basis	IDF	Method	Prep Method
Gasoline C7-C12	5,000		250	20	ug/L	As Recd	5.000	EPA 8260B	EPA 5030B
MTBE	0.90		0.50	0.10	ug/L	As Recd	1.000	EPA 8260B	EPA 5030B
Benzene	47		0.50	0.10	ug/L	As Recd	1.000	EPA 8260B	EPA 5030B
Ethylbenzene	240		2.5	0.51	ug/L	As Recd	5.000	EPA 8260B	EPA 5030B
m,p-Xylenes	58		0.50	0.14	ug/L	As Recd	1.000	EPA 8260B	EPA 5030B

Client Sample ID : MW-2                                  Laboratory Sample ID :                                  257759-002

Analyte	Result	Flags	RL	MDL	Units	Basis	IDF	Method	Prep Method
Gasoline C7-C12	97		50	4.0	ug/L	As Recd	1.000	EPA 8260B	EPA 5030B

Client Sample ID : MW-4                                  Laboratory Sample ID :                                  257759-003

Analyte	Result	Flags	RL	MDL	Units	Basis	IDF	Method	Prep Method
tert-Butyl Alcohol (TBA)	360		130	18	ug/L	As Recd	12.50	EPA 8260B	EPA 5030B
MTBE	17		6.3	1.3	ug/L	As Recd	12.50	EPA 8260B	EPA 5030B
Benzene	710		6.3	1.3	ug/L	As Recd	12.50	EPA 8260B	EPA 5030B
Ethylbenzene	21		6.3	2.0	ug/L	As Recd	12.50	EPA 8260B	EPA 5030B

Client Sample ID : MW-5                                  Laboratory Sample ID :                                  257759-004

Analyte	Result	Flags	RL	MDL	Units	Basis	IDF	Method	Prep Method
Gasoline C7-C12	1,700		50	4.0	ug/L	As Recd	1.000	EPA 8260B	EPA 5030B
Methyl tert-Amyl Ether (TAME)	0.81		0.50	0.10	ug/L	As Recd	1.000	EPA 8260B	EPA 5030B
MTBE	0.75		0.50	0.10	ug/L	As Recd	1.000	EPA 8260B	EPA 5030B
Benzene	8.2		0.50	0.10	ug/L	As Recd	1.000	EPA 8260B	EPA 5030B
Toluene	0.56		0.50	0.10	ug/L	As Recd	1.000	EPA 8260B	EPA 5030B
Ethylbenzene	63		0.50	0.16	ug/L	As Recd	1.000	EPA 8260B	EPA 5030B
m,p-Xylenes	35		0.50	0.10	ug/L	As Recd	1.000	EPA 8260B	EPA 5030B
o-Xylene	5.2		0.50	0.10	ug/L	As Recd	1.000	EPA 8260B	EPA 5030B

Client Sample ID : MW-6                                  Laboratory Sample ID :                                  257759-005

Analyte	Result	Flags	RL	MDL	Units	Basis	IDF	Method	Prep Method
Gasoline C7-C12	9,600		250	20	ug/L	As Recd	5.000	EPA 8260B	EPA 5030B
Benzene	29		2.5	0.50	ug/L	As Recd	5.000	EPA 8260B	EPA 5030B
Ethylbenzene	370		2.5	0.51	ug/L	As Recd	5.000	EPA 8260B	EPA 5030B
m,p-Xylenes	250		2.5	0.68	ug/L	As Recd	5.000	EPA 8260B	EPA 5030B
o-Xylene	45		2.5	0.66	ug/L	As Recd	5.000	EPA 8260B	EPA 5030B

Client Sample ID : MW-7

Laboratory Sample ID :

257759-006

Analyte	Result	Flags	RL	MDL	Units	Basis	IDF	Method	Prep Method
Gasoline C7-C12	1,600		50	4.0	ug/L	As Recd	1.000	EPA 8260B	EPA 5030B
Methyl tert-Amyl Ether (TAME)	0.76		0.50	0.10	ug/L	As Recd	1.000	EPA 8260B	EPA 5030B
MTBE	5.7		0.50	0.10	ug/L	As Recd	1.000	EPA 8260B	EPA 5030B
Ethylbenzene	11		0.50	0.10	ug/L	As Recd	1.000	EPA 8260B	EPA 5030B
m,p-Xylenes	3.0		0.50	0.14	ug/L	As Recd	1.000	EPA 8260B	EPA 5030B

Client Sample ID : MW-1D

Laboratory Sample ID :

257759-007

No Detections

Client Sample ID : MW-3D

Laboratory Sample ID :

257759-008

Analyte	Result	Flags	RL	MDL	Units	Basis	IDF	Method	Prep Method
MTBE	1.5		0.50	0.10	ug/L	As Recd	1.000	EPA 8260B	EPA 5030B
m,p-Xylenes	0.77		0.50	0.14	ug/L	As Recd	1.000	EPA 8260B	EPA 5030B

Client Sample ID : MW-4D

Laboratory Sample ID :

257759-009

Analyte	Result	Flags	RL	MDL	Units	Basis	IDF	Method	Prep Method
MTBE	1.8		0.50	0.10	ug/L	As Recd	1.000	EPA 8260B	EPA 5030B

Client Sample ID : EX-1

Laboratory Sample ID :

257759-010

Analyte	Result	Flags	RL	MDL	Units	Basis	IDF	Method	Prep Method
Gasoline C7-C12	1,700		50	4.0	ug/L	As Recd	1.000	EPA 8260B	EPA 5030B
tert-Butyl Alcohol (TBA)	70		10	1.3	ug/L	As Recd	1.000	EPA 8260B	EPA 5030B
Ethyl tert-Butyl Ether (ETBE)	1.1		0.50	0.10	ug/L	As Recd	1.000	EPA 8260B	EPA 5030B
Methyl tert-Amyl Ether (TAME)	3.9		0.50	0.10	ug/L	As Recd	1.000	EPA 8260B	EPA 5030B
MTBE	40		0.50	0.10	ug/L	As Recd	1.000	EPA 8260B	EPA 5030B
1,2-Dichloroethane	0.69		0.50	0.10	ug/L	As Recd	1.000	EPA 8260B	EPA 5030B
Benzene	70		0.50	0.10	ug/L	As Recd	1.000	EPA 8260B	EPA 5030B
Toluene	11		0.50	0.10	ug/L	As Recd	1.000	EPA 8260B	EPA 5030B
Ethylbenzene	92		0.50	0.10	ug/L	As Recd	1.000	EPA 8260B	EPA 5030B
m,p-Xylenes	170		0.50	0.14	ug/L	As Recd	1.000	EPA 8260B	EPA 5030B
o-Xylene	38		0.50	0.13	ug/L	As Recd	1.000	EPA 8260B	EPA 5030B

Client Sample ID : EX-2

Laboratory Sample ID :

257759-011

Analyte	Result	Flags	RL	MDL	Units	Basis	IDF	Method	Prep Method
Gasoline C7-C12	4,400		200	16	ug/L	As Recd	4.000	EPA 8260B	EPA 5030B
MTBE	5.4		2.0	0.40	ug/L	As Recd	4.000	EPA 8260B	EPA 5030B
Benzene	120		2.0	0.40	ug/L	As Recd	4.000	EPA 8260B	EPA 5030B
Toluene	37		2.0	0.40	ug/L	As Recd	4.000	EPA 8260B	EPA 5030B
Ethylbenzene	280		2.0	0.41	ug/L	As Recd	4.000	EPA 8260B	EPA 5030B
m,p-Xylenes	480		2.0	0.54	ug/L	As Recd	4.000	EPA 8260B	EPA 5030B
o-Xylene	110		2.0	0.53	ug/L	As Recd	4.000	EPA 8260B	EPA 5030B

### Purgeable Organics by GC/MS

Lab #: 257759	Location: 15101 Freedom Avenue San Leandro
Client: SOMA Environmental Engineering Inc.	Prep: EPA 5030B
Project#: 2551	Analysis: EPA 8260B
Field ID: MW-1	Units: ug/L
Lab ID: 257759-001	Sampled: 06/06/14
Matrix: Water	Received: 06/06/14

Analyte	Result	RL	Diln Fac	Batch#	Analyzed
Gasoline C7-C12	5,000	250	5.000	212276	06/17/14
tert-Butyl Alcohol (TBA)	ND	10	1.000	212186	06/13/14
Isopropyl Ether (DIPE)	ND	0.50	1.000	212186	06/13/14
Ethyl tert-Butyl Ether (ETBE)	ND	0.50	1.000	212186	06/13/14
Methyl tert-Amyl Ether (TAME)	ND	0.50	1.000	212186	06/13/14
Ethanol	ND	1,000	1.000	212186	06/13/14
MTBE	0.90	0.50	1.000	212186	06/13/14
1,2-Dichloroethane	ND	0.50	1.000	212186	06/13/14
Benzene	47	0.50	1.000	212186	06/13/14
Toluene	ND	0.50	1.000	212186	06/13/14
1,2-Dibromoethane	ND	0.50	1.000	212186	06/13/14
Ethylbenzene	240	2.5	5.000	212276	06/17/14
m,p-Xylenes	58	0.50	1.000	212186	06/13/14
o-Xylene	ND	0.50	1.000	212186	06/13/14

Surrogate	%REC	Limits	Diln Fac	Batch#	Analyzed
Dibromofluoromethane	102	77-136	1.000	212186	06/13/14
1,2-Dichloroethane-d4	135	75-139	1.000	212186	06/13/14
Toluene-d8	99	80-120	1.000	212186	06/13/14
Bromofluorobenzene	101	80-120	1.000	212186	06/13/14

ND= Not Detected  
 RL= Reporting Limit

### Purgeable Organics by GC/MS

Lab #: 257759	Location: 15101 Freedom Avenue San Leandro
Client: SOMA Environmental Engineering Inc.	Prep: EPA 5030B
Project#: 2551	Analysis: EPA 8260B
Field ID: MW-2	Batch#: 212276
Lab ID: 257759-002	Sampled: 06/06/14
Matrix: Water	Received: 06/06/14
Units: ug/L	Analyzed: 06/17/14
Diln Fac: 1.000	

Analyte	Result	RL
Gasoline C7-C12	97	50
tert-Butyl Alcohol (TBA)	ND	10
Isopropyl Ether (DIPE)	ND	0.50
Ethyl tert-Butyl Ether (ETBE)	ND	0.50
Methyl tert-Amyl Ether (TAME)	ND	0.50
Ethanol	ND	1,000
MTBE	ND	0.50
1,2-Dichloroethane	ND	0.50
Benzene	ND	0.50
Toluene	ND	0.50
1,2-Dibromoethane	ND	0.50
Ethylbenzene	ND	0.50
m,p-Xylenes	ND	0.50
o-Xylene	ND	0.50

Surrogate	%REC	Limits
Dibromofluoromethane	95	77-136
1,2-Dichloroethane-d4	104	75-139
Toluene-d8	99	80-120
Bromofluorobenzene	98	80-120

ND= Not Detected  
 RL= Reporting Limit



Purgeable Organics by GC/MS			
Lab #:	257759	Location:	15101 Freedom Avenue San Leandro
Client:	SOMA Environmental Engineering Inc.	Prep:	EPA 5030B
Project#:	2551	Analysis:	EPA 8260B
Field ID:	MW-4	Diln Fac:	12.50
Lab ID:	257759-003	Sampled:	06/06/14
Matrix:	Water	Received:	06/06/14
Units:	ug/L		

Analyte	Result	RL	Batch#	Analyzed
Gasoline C7-C12	ND	630	212210	06/15/14
tert-Butyl Alcohol (TBA)	360	130	212286	06/17/14
Isopropyl Ether (DIPE)	ND	6.3	212286	06/17/14
Ethyl tert-Butyl Ether (ETBE)	ND	6.3	212286	06/17/14
Methyl tert-Amyl Ether (TAME)	ND	6.3	212286	06/17/14
Ethanol	ND	13,000	212286	06/17/14
MTBE	17	6.3	212286	06/17/14
1,2-Dichloroethane	ND	6.3	212286	06/17/14
Benzene	710	6.3	212286	06/17/14
Toluene	ND	6.3	212286	06/17/14
1,2-Dibromoethane	ND	6.3	212286	06/17/14
Ethylbenzene	21	6.3	212286	06/17/14
m,p-Xylenes	ND	6.3	212286	06/17/14
o-Xylene	ND	6.3	212286	06/17/14

Surrogate	%REC	Limits	Batch#	Analyzed
Dibromofluoromethane	103	77-136	212286	06/17/14
1,2-Dichloroethane-d4	109	75-139	212286	06/17/14
Toluene-d8	103	80-120	212286	06/17/14
Bromofluorobenzene	106	80-120	212286	06/17/14

ND= Not Detected  
 RL= Reporting Limit

### Purgeable Organics by GC/MS

Lab #: 257759	Location: 15101 Freedom Avenue San Leandro
Client: SOMA Environmental Engineering Inc.	Prep: EPA 5030B
Project#: 2551	Analysis: EPA 8260B
Field ID: MW-5	Diln Fac: 1.000
Lab ID: 257759-004	Sampled: 06/06/14
Matrix: Water	Received: 06/06/14
Units: ug/L	

Analyte	Result	RL	Batch#	Analyzed
Gasoline C7-C12	1,700	50	212276	06/17/14
tert-Butyl Alcohol (TBA)	ND	10	212333	06/18/14
Isopropyl Ether (DIPE)	ND	0.50	212333	06/18/14
Ethyl tert-Butyl Ether (ETBE)	ND	0.50	212333	06/18/14
Methyl tert-Amyl Ether (TAME)	0.81	0.50	212333	06/18/14
Ethanol	ND	1,000	212333	06/18/14
MTBE	0.75	0.50	212333	06/18/14
1,2-Dichloroethane	ND	0.50	212333	06/18/14
Benzene	8.2	0.50	212333	06/18/14
Toluene	0.56	0.50	212333	06/18/14
1,2-Dibromoethane	ND	0.50	212333	06/18/14
Ethylbenzene	63	0.50	212333	06/18/14
m,p-Xylenes	35	0.50	212333	06/18/14
o-Xylene	5.2	0.50	212333	06/18/14

Surrogate	%REC	Limits	Batch#	Analyzed
Dibromofluoromethane	102	77-136	212333	06/18/14
1,2-Dichloroethane-d4	112	75-139	212333	06/18/14
Toluene-d8	103	80-120	212333	06/18/14
Bromofluorobenzene	102	80-120	212333	06/18/14

ND= Not Detected  
 RL= Reporting Limit

### Purgeable Organics by GC/MS

Lab #: 257759	Location: 15101 Freedom Avenue San Leandro
Client: SOMA Environmental Engineering Inc.	Prep: EPA 5030B
Project#: 2551	Analysis: EPA 8260B
Field ID: MW-6	Batch#: 212186
Lab ID: 257759-005	Sampled: 06/05/14
Matrix: Water	Received: 06/06/14
Units: ug/L	Analyzed: 06/14/14
Diln Fac: 5.000	

Analyte	Result	RL
Gasoline C7-C12	9,600	250
tert-Butyl Alcohol (TBA)	ND	50
Isopropyl Ether (DIPE)	ND	2.5
Ethyl tert-Butyl Ether (ETBE)	ND	2.5
Methyl tert-Amyl Ether (TAME)	ND	2.5
Ethanol	ND	5,000
MTBE	ND	2.5
1,2-Dichloroethane	ND	2.5
Benzene	29	2.5
Toluene	ND	2.5
1,2-Dibromoethane	ND	2.5
Ethylbenzene	370	2.5
m,p-Xylenes	250	2.5
o-Xylene	45	2.5

Surrogate	%REC	Limits
Dibromofluoromethane	95	77-136
1,2-Dichloroethane-d4	118	75-139
Toluene-d8	102	80-120
Bromofluorobenzene	104	80-120

ND= Not Detected  
 RL= Reporting Limit

### Purgeable Organics by GC/MS

Lab #: 257759	Location: 15101 Freedom Avenue San Leandro
Client: SOMA Environmental Engineering Inc.	Prep: EPA 5030B
Project#: 2551	Analysis: EPA 8260B
Field ID: MW-7	Batch#: 212186
Lab ID: 257759-006	Sampled: 06/05/14
Matrix: Water	Received: 06/06/14
Units: ug/L	Analyzed: 06/13/14
Diln Fac: 1.000	

Analyte	Result	RL
Gasoline C7-C12	1,600	50
tert-Butyl Alcohol (TBA)	ND	10
Isopropyl Ether (DIPE)	ND	0.50
Ethyl tert-Butyl Ether (ETBE)	ND	0.50
Methyl tert-Amyl Ether (TAME)	0.76	0.50
Ethanol	ND	1,000
MTBE	5.7	0.50
1,2-Dichloroethane	ND	0.50
Benzene	ND	0.50
Toluene	ND	0.50
1,2-Dibromoethane	ND	0.50
Ethylbenzene	11	0.50
m,p-Xylenes	3.0	0.50
o-Xylene	ND	0.50

Surrogate	%REC	Limits
Dibromofluoromethane	97	77-136
1,2-Dichloroethane-d4	115	75-139
Toluene-d8	103	80-120
Bromofluorobenzene	103	80-120

ND= Not Detected  
 RL= Reporting Limit

### Purgeable Organics by GC/MS

Lab #: 257759	Location: 15101 Freedom Avenue San Leandro
Client: SOMA Environmental Engineering Inc.	Prep: EPA 5030B
Project#: 2551	Analysis: EPA 8260B
Field ID: MW-1D	Batch#: 212186
Lab ID: 257759-007	Sampled: 06/05/14
Matrix: Water	Received: 06/06/14
Units: ug/L	Analyzed: 06/13/14
Diln Fac: 1.000	

Analyte	Result	RL
Gasoline C7-C12	ND	50
tert-Butyl Alcohol (TBA)	ND	10
Isopropyl Ether (DIPE)	ND	0.50
Ethyl tert-Butyl Ether (ETBE)	ND	0.50
Methyl tert-Amyl Ether (TAME)	ND	0.50
Ethanol	ND	1,000
MTBE	ND	0.50
1,2-Dichloroethane	ND	0.50
Benzene	ND	0.50
Toluene	ND	0.50
1,2-Dibromoethane	ND	0.50
Ethylbenzene	ND	0.50
m,p-Xylenes	ND	0.50
o-Xylene	ND	0.50

Surrogate	%REC	Limits
Dibromofluoromethane	90	77-136
1,2-Dichloroethane-d4	115	75-139
Toluene-d8	102	80-120
Bromofluorobenzene	104	80-120

ND= Not Detected  
 RL= Reporting Limit

### Purgeable Organics by GC/MS

Lab #: 257759	Location: 15101 Freedom Avenue San Leandro
Client: SOMA Environmental Engineering Inc.	Prep: EPA 5030B
Project#: 2551	Analysis: EPA 8260B
Field ID: MW-3D	Batch#: 212186
Lab ID: 257759-008	Sampled: 06/05/14
Matrix: Water	Received: 06/06/14
Units: ug/L	Analyzed: 06/14/14
Diln Fac: 1.000	

Analyte	Result	RL
Gasoline C7-C12	ND	50
tert-Butyl Alcohol (TBA)	ND	10
Isopropyl Ether (DIPE)	ND	0.50
Ethyl tert-Butyl Ether (ETBE)	ND	0.50
Methyl tert-Amyl Ether (TAME)	ND	0.50
Ethanol	ND	1,000
MTBE	1.5	0.50
1,2-Dichloroethane	ND	0.50
Benzene	ND	0.50
Toluene	ND	0.50
1,2-Dibromoethane	ND	0.50
Ethylbenzene	ND	0.50
m,p-Xylenes	0.77	0.50
o-Xylene	ND	0.50

Surrogate	%REC	Limits
Dibromofluoromethane	97	77-136
1,2-Dichloroethane-d4	120	75-139
Toluene-d8	104	80-120
Bromofluorobenzene	104	80-120

ND= Not Detected  
 RL= Reporting Limit

### Purgeable Organics by GC/MS

Lab #: 257759	Location: 15101 Freedom Avenue San Leandro
Client: SOMA Environmental Engineering Inc.	Prep: EPA 5030B
Project#: 2551	Analysis: EPA 8260B
Field ID: MW-4D	Batch#: 212186
Lab ID: 257759-009	Sampled: 06/06/14
Matrix: Water	Received: 06/06/14
Units: ug/L	Analyzed: 06/14/14
Diln Fac: 1.000	

Analyte	Result	RL
Gasoline C7-C12	ND	50
tert-Butyl Alcohol (TBA)	ND	10
Isopropyl Ether (DIPE)	ND	0.50
Ethyl tert-Butyl Ether (ETBE)	ND	0.50
Methyl tert-Amyl Ether (TAME)	ND	0.50
Ethanol	ND	1,000
MTBE	1.8	0.50
1,2-Dichloroethane	ND	0.50
Benzene	ND	0.50
Toluene	ND	0.50
1,2-Dibromoethane	ND	0.50
Ethylbenzene	ND	0.50
m,p-Xylenes	ND	0.50
o-Xylene	ND	0.50

Surrogate	%REC	Limits
Dibromofluoromethane	99	77-136
1,2-Dichloroethane-d4	127	75-139
Toluene-d8	103	80-120
Bromofluorobenzene	107	80-120

ND= Not Detected  
 RL= Reporting Limit

### Purgeable Organics by GC/MS

Lab #: 257759	Location: 15101 Freedom Avenue San Leandro
Client: SOMA Environmental Engineering Inc.	Prep: EPA 5030B
Project#: 2551	Analysis: EPA 8260B
Field ID: EX-1	Batch#: 212186
Lab ID: 257759-010	Sampled: 06/05/14
Matrix: Water	Received: 06/06/14
Units: ug/L	Analyzed: 06/14/14
Diln Fac: 1.000	

Analyte	Result	RL
Gasoline C7-C12	1,700	50
tert-Butyl Alcohol (TBA)	70	10
Isopropyl Ether (DIPE)	ND	0.50
Ethyl tert-Butyl Ether (ETBE)	1.1	0.50
Methyl tert-Amyl Ether (TAME)	3.9	0.50
Ethanol	ND	1,000
MTBE	40	0.50
1,2-Dichloroethane	0.69	0.50
Benzene	70	0.50
Toluene	11	0.50
1,2-Dibromoethane	ND	0.50
Ethylbenzene	92	0.50
m,p-Xylenes	170	0.50
o-Xylene	38	0.50

Surrogate	%REC	Limits
Dibromofluoromethane	99	77-136
1,2-Dichloroethane-d4	129	75-139
Toluene-d8	101	80-120
Bromofluorobenzene	102	80-120

ND= Not Detected  
 RL= Reporting Limit



### Purgeable Organics by GC/MS

Lab #: 257759	Location: 15101 Freedom Avenue San Leandro
Client: SOMA Environmental Engineering Inc.	Prep: EPA 5030B
Project#: 2551	Analysis: EPA 8260B
Field ID: EX-2	Batch#: 212186
Lab ID: 257759-011	Sampled: 06/05/14
Matrix: Water	Received: 06/06/14
Units: ug/L	Analyzed: 06/14/14
Diln Fac: 4.000	

Analyte	Result	RL
Gasoline C7-C12	4,400	200
tert-Butyl Alcohol (TBA)	ND	40
Isopropyl Ether (DIPE)	ND	2.0
Ethyl tert-Butyl Ether (ETBE)	ND	2.0
Methyl tert-Amyl Ether (TAME)	ND	2.0
Ethanol	ND	4,000
MTBE	5.4	2.0
1,2-Dichloroethane	ND	2.0
Benzene	120	2.0
Toluene	37	2.0
1,2-Dibromoethane	ND	2.0
Ethylbenzene	280	2.0
m,p-Xylenes	480	2.0
o-Xylene	110	2.0

Surrogate	%REC	Limits
Dibromofluoromethane	97	77-136
1,2-Dichloroethane-d4	118	75-139
Toluene-d8	101	80-120
Bromofluorobenzene	103	80-120

ND= Not Detected  
 RL= Reporting Limit

**Batch QC Report**

Purgeable Organics by GC/MS			
Lab #:	257759	Location:	15101 Freedom Avenue San Leandro
Client:	SOMA Environmental Engineering Inc.	Prep:	EPA 5030B
Project#:	2551	Analysis:	EPA 8260B
Matrix:	Water	Batch#:	212186
Units:	ug/L	Analyzed:	06/13/14
Diln Fac:	1.000		

Type: BS Lab ID: QC744803

Analyte	Spiked	Result	%REC	Limits
tert-Butyl Alcohol (TBA)	75.00	68.36	91	37-151
Isopropyl Ether (DIPE)	15.00	12.82	85	56-124
Ethyl tert-Butyl Ether (ETBE)	15.00	14.12	94	61-122
Methyl tert-Amyl Ether (TAME)	15.00	14.12	94	65-120
MTBE	15.00	13.94	93	64-121
1,2-Dichloroethane	15.00	18.45	123	77-137
Benzene	15.00	14.97	100	80-124
Toluene	15.00	15.35	102	80-122
1,2-Dibromoethane	15.00	15.45	103	80-120
Ethylbenzene	15.00	16.30	109	80-124
m,p-Xylenes	30.00	33.05	110	80-122
o-Xylene	15.00	16.19	108	77-120

Surrogate	%REC	Limits
Dibromofluoromethane	97	77-136
1,2-Dichloroethane-d4	119	75-139
Toluene-d8	102	80-120
Bromofluorobenzene	101	80-120

Type: BSD Lab ID: QC744804

Analyte	Spiked	Result	%REC	Limits	RPD	Lim
tert-Butyl Alcohol (TBA)	75.00	70.71	94	37-151	3	30
Isopropyl Ether (DIPE)	15.00	12.57	84	56-124	2	20
Ethyl tert-Butyl Ether (ETBE)	15.00	14.29	95	61-122	1	22
Methyl tert-Amyl Ether (TAME)	15.00	14.24	95	65-120	1	22
MTBE	15.00	14.38	96	64-121	3	20
1,2-Dichloroethane	15.00	19.00	127	77-137	3	20
Benzene	15.00	14.73	98	80-124	2	20
Toluene	15.00	15.37	102	80-122	0	20
1,2-Dibromoethane	15.00	15.22	101	80-120	2	20
Ethylbenzene	15.00	15.80	105	80-124	3	20
m,p-Xylenes	30.00	32.38	108	80-122	2	20
o-Xylene	15.00	16.09	107	77-120	1	20

Surrogate	%REC	Limits
Dibromofluoromethane	95	77-136
1,2-Dichloroethane-d4	120	75-139
Toluene-d8	101	80-120
Bromofluorobenzene	102	80-120

RPD= Relative Percent Difference

**Batch QC Report**

<b>Purgeable Organics by GC/MS</b>		
Lab #:	257759	Location: 15101 Freedom Avenue San Leandro
Client:	SOMA Environmental Engineering Inc.	Prep: EPA 5030B
Project#:	2551	Analysis: EPA 8260B
Type:	BLANK	Diln Fac: 1.000
Lab ID:	QC744805	Batch#: 212186
Matrix:	Water	Analyzed: 06/13/14
Units:	ug/L	

<b>Analyte</b>	<b>Result</b>	<b>RL</b>
Gasoline C7-C12	ND	50
tert-Butyl Alcohol (TBA)	ND	10
Isopropyl Ether (DIPE)	ND	0.50
Ethyl tert-Butyl Ether (ETBE)	ND	0.50
Methyl tert-Amyl Ether (TAME)	ND	0.50
Ethanol	ND	1,000
MTBE	ND	0.50
1,2-Dichloroethane	ND	0.50
Benzene	ND	0.50
Toluene	ND	0.50
1,2-Dibromoethane	ND	0.50
Ethylbenzene	ND	0.50
m,p-Xylenes	ND	0.50
o-Xylene	ND	0.50

<b>Surrogate</b>	<b>%REC</b>	<b>Limits</b>
Dibromofluoromethane	96	77-136
1,2-Dichloroethane-d4	135	75-139
Toluene-d8	102	80-120
Bromofluorobenzene	106	80-120

ND= Not Detected  
 RL= Reporting Limit

## Batch QC Report

Purgeable Organics by GC/MS			
Lab #:	257759	Location:	15101 Freedom Avenue San Leandro
Client:	SOMA Environmental Engineering Inc.	Prep:	EPA 5030B
Project#:	2551	Analysis:	EPA 8260B
Matrix:	Water	Batch#:	212186
Units:	ug/L	Analyzed:	06/13/14
Diln Fac:	1.000		

Type: BS Lab ID: QC744806

Analyte	Spiked	Result	%REC	Limits
Gasoline C7-C12	1,000	931.4	93	80-120

Surrogate	%REC	Limits
Dibromofluoromethane	96	77-136
1,2-Dichloroethane-d4	123	75-139
Toluene-d8	101	80-120
Bromofluorobenzene	101	80-120

Type: BSD Lab ID: QC744807

Analyte	Spiked	Result	%REC	Limits	RPD	Lim
Gasoline C7-C12	1,000	949.1	95	80-120	2	20

Surrogate	%REC	Limits
Dibromofluoromethane	96	77-136
1,2-Dichloroethane-d4	122	75-139
Toluene-d8	102	80-120
Bromofluorobenzene	103	80-120

RPD= Relative Percent Difference

**Batch QC Report**

Purgeable Organics by GC/MS			
Lab #:	257759	Location:	15101 Freedom Avenue San Leandro
Client:	SOMA Environmental Engineering Inc.	Prep:	EPA 5030B
Project#:	2551	Analysis:	EPA 8260B
Matrix:	Water	Batch#:	212210
Units:	ug/L	Analyzed:	06/15/14
Diln Fac:	1.000		

Type: BS Lab ID: QC744916

Analyte	Spiked	Result	%REC	Limits
tert-Butyl Alcohol (TBA)	62.50	53.28	85	37-151
Isopropyl Ether (DIPE)	12.50	10.72	86	56-124
Ethyl tert-Butyl Ether (ETBE)	12.50	12.24	98	61-122
Methyl tert-Amyl Ether (TAME)	12.50	11.98	96	65-120
MTBE	12.50	11.79	94	64-121
1,2-Dichloroethane	12.50	16.74 b	134	77-137
Benzene	12.50	12.46	100	80-124
Toluene	12.50	12.87	103	80-122
1,2-Dibromoethane	12.50	12.83	103	80-120
Ethylbenzene	12.50	13.95	112	80-124
m,p-Xylenes	25.00	28.01	112	80-122
o-Xylene	12.50	13.76	110	77-120

Surrogate	%REC	Limits
Dibromofluoromethane	99	77-136
1,2-Dichloroethane-d4	127	75-139
Toluene-d8	102	80-120
Bromofluorobenzene	103	80-120

Type: BSD Lab ID: QC744917

Analyte	Spiked	Result	%REC	Limits	RPD	Lim
tert-Butyl Alcohol (TBA)	62.50	55.40	89	37-151	4	30
Isopropyl Ether (DIPE)	12.50	10.63	85	56-124	1	20
Ethyl tert-Butyl Ether (ETBE)	12.50	12.61	101	61-122	3	22
Methyl tert-Amyl Ether (TAME)	12.50	12.15	97	65-120	1	22
MTBE	12.50	12.38	99	64-121	5	20
1,2-Dichloroethane	12.50	18.33 b	147 *	77-137	9	20
Benzene	12.50	11.98	96	80-124	4	20
Toluene	12.50	12.16	97	80-122	6	20
1,2-Dibromoethane	12.50	12.96	104	80-120	1	20
Ethylbenzene	12.50	13.18	105	80-124	6	20
m,p-Xylenes	25.00	25.99	104	80-122	7	20
o-Xylene	12.50	12.98	104	77-120	6	20

Surrogate	%REC	Limits
Dibromofluoromethane	103	77-136
1,2-Dichloroethane-d4	140 *	75-139
Toluene-d8	102	80-120
Bromofluorobenzene	102	80-120

\*= Value outside of QC limits; see narrative

b= See narrative

RPD= Relative Percent Difference

## Batch QC Report

Purgeable Organics by GC/MS			
Lab #:	257759	Location:	15101 Freedom Avenue San Leandro
Client:	SOMA Environmental Engineering Inc.	Prep:	EPA 5030B
Project#:	2551	Analysis:	EPA 8260B
Matrix:	Water	Batch#:	212210
Units:	ug/L	Analyzed:	06/15/14
Diln Fac:	1.000		

Type: BS Lab ID: QC744918

Analyte	Spiked	Result	%REC	Limits
Gasoline C7-C12	1,000	921.5	92	80-120

Surrogate	%REC	Limits
Dibromofluoromethane	99	77-136
1,2-Dichloroethane-d4	128	75-139
Toluene-d8	100	80-120
Bromofluorobenzene	104	80-120

Type: BSD Lab ID: QC744919

Analyte	Spiked	Result	%REC	Limits	RPD	Lim
Gasoline C7-C12	1,000	882.9	88	80-120	4	20

Surrogate	%REC	Limits
Dibromofluoromethane	94	77-136
1,2-Dichloroethane-d4	121	75-139
Toluene-d8	99	80-120
Bromofluorobenzene	103	80-120

RPD= Relative Percent Difference

**Batch QC Report**

Purgeable Organics by GC/MS		
Lab #:	257759	Location: 15101 Freedom Avenue San Leandro
Client:	SOMA Environmental Engineering Inc.	Prep: EPA 5030B
Project#:	2551	Analysis: EPA 8260B
Type:	BLANK	Diln Fac: 1.000
Lab ID:	QC744920	Batch#: 212210
Matrix:	Water	Analyzed: 06/15/14
Units:	ug/L	

Analyte	Result	RL
Gasoline C7-C12	ND	50
tert-Butyl Alcohol (TBA)	ND	10
Isopropyl Ether (DIPE)	ND	0.50
Ethyl tert-Butyl Ether (ETBE)	ND	0.50
Methyl tert-Amyl Ether (TAME)	ND	0.50
Ethanol	ND	1,000
MTBE	ND	0.50
1,2-Dichloroethane	ND	0.50
Benzene	ND	0.50
Toluene	ND	0.50
1,2-Dibromoethane	ND	0.50
Ethylbenzene	ND	0.50
m,p-Xylenes	ND	0.50
o-Xylene	ND	0.50

Surrogate	%REC	Limits
Dibromofluoromethane	98	77-136
1,2-Dichloroethane-d4	133	75-139
Toluene-d8	101	80-120
Bromofluorobenzene	112	80-120

ND= Not Detected  
 RL= Reporting Limit

**Batch QC Report**

Purgeable Organics by GC/MS			
Lab #:	257759	Location:	15101 Freedom Avenue San Leandro
Client:	SOMA Environmental Engineering Inc.	Prep:	EPA 5030B
Project#:	2551	Analysis:	EPA 8260B
Matrix:	Water	Batch#:	212276
Units:	ug/L	Analyzed:	06/17/14
Diln Fac:	1.000		

Type: BS Lab ID: QC745185

Analyte	Spiked	Result	%REC	Limits
tert-Butyl Alcohol (TBA)	62.50	42.19 b	68	37-151
Isopropyl Ether (DIPE)	12.50	10.64	85	56-124
Ethyl tert-Butyl Ether (ETBE)	12.50	11.55	92	61-122
Methyl tert-Amyl Ether (TAME)	12.50	11.61	93	65-120
MTBE	12.50	11.38	91	64-121
1,2-Dichloroethane	12.50	13.02	104	77-137
Benzene	12.50	12.71	102	80-124
Toluene	12.50	12.84	103	80-122
1,2-Dibromoethane	12.50	12.58	101	80-120
Ethylbenzene	12.50	13.12	105	80-124
m,p-Xylenes	25.00	26.93	108	80-122
o-Xylene	12.50	13.85	111	77-120

Surrogate	%REC	Limits
Dibromofluoromethane	95	77-136
1,2-Dichloroethane-d4	97	75-139
Toluene-d8	98	80-120
Bromofluorobenzene	103	80-120

Type: BSD Lab ID: QC745186

Analyte	Spiked	Result	%REC	Limits	RPD	Lim
tert-Butyl Alcohol (TBA)	62.50	47.40 b	76	37-151	12	30
Isopropyl Ether (DIPE)	12.50	11.20	90	56-124	5	20
Ethyl tert-Butyl Ether (ETBE)	12.50	12.38	99	61-122	7	22
Methyl tert-Amyl Ether (TAME)	12.50	12.55	100	65-120	8	22
MTBE	12.50	11.97	96	64-121	5	20
1,2-Dichloroethane	12.50	13.85	111	77-137	6	20
Benzene	12.50	13.42	107	80-124	5	20
Toluene	12.50	13.64	109	80-122	6	20
1,2-Dibromoethane	12.50	13.57	109	80-120	8	20
Ethylbenzene	12.50	13.89	111	80-124	6	20
m,p-Xylenes	25.00	29.01	116	80-122	7	20
o-Xylene	12.50	14.52	116	77-120	5	20

Surrogate	%REC	Limits
Dibromofluoromethane	93	77-136
1,2-Dichloroethane-d4	96	75-139
Toluene-d8	100	80-120
Bromofluorobenzene	98	80-120

b= See narrative  
 RPD= Relative Percent Difference  
 Page 1 of 1



**Batch QC Report**

<b>Purgeable Organics by GC/MS</b>		
Lab #:	257759	Location: 15101 Freedom Avenue San Leandro
Client:	SOMA Environmental Engineering Inc.	Prep: EPA 5030B
Project#:	2551	Analysis: EPA 8260B
Type:	BLANK	Diln Fac: 1.000
Lab ID:	QC745187	Batch#: 212276
Matrix:	Water	Analyzed: 06/17/14
Units:	ug/L	

<b>Analyte</b>	<b>Result</b>	<b>RL</b>
Gasoline C7-C12	ND	50
tert-Butyl Alcohol (TBA)	ND	10
Isopropyl Ether (DIPE)	ND	0.50
Ethyl tert-Butyl Ether (ETBE)	ND	0.50
Methyl tert-Amyl Ether (TAME)	ND	0.50
Ethanol	ND	1,000
MTBE	ND	0.50
1,2-Dichloroethane	ND	0.50
Benzene	ND	0.50
Toluene	ND	0.50
1,2-Dibromoethane	ND	0.50
Ethylbenzene	ND	0.50
m,p-Xylenes	ND	0.50
o-Xylene	ND	0.50

<b>Surrogate</b>	<b>%REC</b>	<b>Limits</b>
Dibromofluoromethane	98	77-136
1,2-Dichloroethane-d4	109	75-139
Toluene-d8	98	80-120
Bromofluorobenzene	103	80-120

ND= Not Detected  
 RL= Reporting Limit

## Batch QC Report

Purgeable Organics by GC/MS			
Lab #:	257759	Location:	15101 Freedom Avenue San Leandro
Client:	SOMA Environmental Engineering Inc.	Prep:	EPA 5030B
Project#:	2551	Analysis:	EPA 8260B
Matrix:	Water	Batch#:	212276
Units:	ug/L	Analyzed:	06/17/14
Diln Fac:	1.000		

Type: BS Lab ID: QC745194

Analyte	Spiked	Result	%REC	Limits
Gasoline C7-C12	1,000	923.2	92	80-120

Surrogate	%REC	Limits
Dibromofluoromethane	92	77-136
1,2-Dichloroethane-d4	100	75-139
Toluene-d8	98	80-120
Bromofluorobenzene	100	80-120

Type: BSD Lab ID: QC745195

Analyte	Spiked	Result	%REC	Limits	RPD	Lim
Gasoline C7-C12	1,000	857.7	86	80-120	7	20

Surrogate	%REC	Limits
Dibromofluoromethane	92	77-136
1,2-Dichloroethane-d4	100	75-139
Toluene-d8	98	80-120
Bromofluorobenzene	100	80-120

RPD= Relative Percent Difference

**Batch QC Report**

Purgeable Organics by GC/MS		
Lab #:	257759	Location: 15101 Freedom Avenue San Leandro
Client:	SOMA Environmental Engineering Inc.	Prep: EPA 5030B
Project#:	2551	Analysis: EPA 8260B
Type:	BLANK	Diln Fac: 1.000
Lab ID:	QC745221	Batch#: 212286
Matrix:	Water	Analyzed: 06/17/14
Units:	ug/L	

Analyte	Result	RL
Gasoline C7-C12	NA	
tert-Butyl Alcohol (TBA)	ND	10
Isopropyl Ether (DIPE)	ND	0.50
Ethyl tert-Butyl Ether (ETBE)	ND	0.50
Methyl tert-Amyl Ether (TAME)	ND	0.50
Ethanol	ND	1,000
MTBE	ND	0.50
1,2-Dichloroethane	ND	0.50
Benzene	ND	0.50
Toluene	ND	0.50
1,2-Dibromoethane	ND	0.50
Ethylbenzene	ND	0.50
m,p-Xylenes	ND	0.50
o-Xylene	ND	0.50

Surrogate	%REC	Limits
Dibromofluoromethane	99	77-136
1,2-Dichloroethane-d4	110	75-139
Toluene-d8	99	80-120
Bromofluorobenzene	106	80-120

NA= Not Analyzed  
 ND= Not Detected  
 RL= Reporting Limit

**Batch QC Report**

Purgeable Organics by GC/MS			
Lab #:	257759	Location:	15101 Freedom Avenue San Leandro
Client:	SOMA Environmental Engineering Inc.	Prep:	EPA 5030B
Project#:	2551	Analysis:	EPA 8260B
Matrix:	Water	Batch#:	212286
Units:	ug/L	Analyzed:	06/17/14
Diln Fac:	1.000		

Type: BS Lab ID: QC745222

Analyte	Spiked	Result	%REC	Limits
tert-Butyl Alcohol (TBA)	100.0	90.36	90	37-151
Isopropyl Ether (DIPE)	20.00	22.64	113	56-124
Ethyl tert-Butyl Ether (ETBE)	20.00	21.53	108	61-122
Methyl tert-Amyl Ether (TAME)	20.00	19.35	97	65-120
MTBE	20.00	20.17	101	64-121
1,2-Dichloroethane	20.00	23.39	117	77-137
Benzene	20.00	22.16	111	80-124
Toluene	20.00	21.35	107	80-122
1,2-Dibromoethane	20.00	19.31	97	80-120
Ethylbenzene	20.00	21.21	106	80-124
m,p-Xylenes	40.00	46.17	115	80-122
o-Xylene	20.00	22.43	112	77-120

Surrogate	%REC	Limits
Dibromofluoromethane	102	77-136
1,2-Dichloroethane-d4	113	75-139
Toluene-d8	103	80-120
Bromofluorobenzene	100	80-120

Type: BSD Lab ID: QC745223

Analyte	Spiked	Result	%REC	Limits	RPD	Lim
tert-Butyl Alcohol (TBA)	100.0	89.39	89	37-151	1	30
Isopropyl Ether (DIPE)	20.00	21.31	107	56-124	6	20
Ethyl tert-Butyl Ether (ETBE)	20.00	20.65	103	61-122	4	22
Methyl tert-Amyl Ether (TAME)	20.00	18.85	94	65-120	3	22
MTBE	20.00	20.30	102	64-121	1	20
1,2-Dichloroethane	20.00	22.48	112	77-137	4	20
Benzene	20.00	20.29	101	80-124	9	20
Toluene	20.00	21.36	107	80-122	0	20
1,2-Dibromoethane	20.00	20.19	101	80-120	4	20
Ethylbenzene	20.00	21.57	108	80-124	2	20
m,p-Xylenes	40.00	46.13	115	80-122	0	20
o-Xylene	20.00	22.92	115	77-120	2	20

Surrogate	%REC	Limits
Dibromofluoromethane	98	77-136
1,2-Dichloroethane-d4	102	75-139
Toluene-d8	100	80-120
Bromofluorobenzene	102	80-120

RPD= Relative Percent Difference

**Batch QC Report**

Purgeable Organics by GC/MS		
Lab #:	257759	Location: 15101 Freedom Avenue San Leandro
Client:	SOMA Environmental Engineering Inc.	Prep: EPA 5030B
Project#:	2551	Analysis: EPA 8260B
Type:	BLANK	Diln Fac: 1.000
Lab ID:	QC745424	Batch#: 212333
Matrix:	Water	Analyzed: 06/18/14
Units:	ug/L	

Analyte	Result	RL
Gasoline C7-C12	NA	
tert-Butyl Alcohol (TBA)	ND	10
Isopropyl Ether (DIPE)	ND	0.50
Ethyl tert-Butyl Ether (ETBE)	ND	0.50
Methyl tert-Amyl Ether (TAME)	ND	0.50
Ethanol	ND	1,000
MTBE	ND	0.50
1,2-Dichloroethane	ND	0.50
Benzene	ND	0.50
Toluene	ND	0.50
1,2-Dibromoethane	ND	0.50
Ethylbenzene	ND	0.50
m,p-Xylenes	ND	0.50
o-Xylene	ND	0.50

Surrogate	%REC	Limits
Dibromofluoromethane	105	77-136
1,2-Dichloroethane-d4	117	75-139
Toluene-d8	105	80-120
Bromofluorobenzene	105	80-120

NA= Not Analyzed  
 ND= Not Detected  
 RL= Reporting Limit

**Batch QC Report**

Purgeable Organics by GC/MS			
Lab #:	257759	Location:	15101 Freedom Avenue San Leandro
Client:	SOMA Environmental Engineering Inc.	Prep:	EPA 5030B
Project#:	2551	Analysis:	EPA 8260B
Matrix:	Water	Batch#:	212333
Units:	ug/L	Analyzed:	06/18/14
Diln Fac:	1.000		

Type: BS Lab ID: QC745425

Analyte	Spiked	Result	%REC	Limits
tert-Butyl Alcohol (TBA)	106.3	99.19	93	37-151
Isopropyl Ether (DIPE)	21.25	26.20	123	56-124
Ethyl tert-Butyl Ether (ETBE)	21.25	23.08	109	61-122
Methyl tert-Amyl Ether (TAME)	21.25	21.60	102	65-120
MTBE	21.25	21.50	101	64-121
1,2-Dichloroethane	21.25	25.48	120	77-137
Benzene	21.25	24.20	114	80-124
Toluene	21.25	22.40	105	80-122
1,2-Dibromoethane	21.25	20.19	95	80-120
Ethylbenzene	21.25	22.29	105	80-124
m,p-Xylenes	42.50	48.84	115	80-122
o-Xylene	21.25	23.72	112	77-120

Surrogate	%REC	Limits
Dibromofluoromethane	105	77-136
1,2-Dichloroethane-d4	120	75-139
Toluene-d8	105	80-120
Bromofluorobenzene	102	80-120

Type: BSD Lab ID: QC745426

Analyte	Spiked	Result	%REC	Limits	RPD	Lim
tert-Butyl Alcohol (TBA)	106.3	103.2	97	37-151	4	30
Isopropyl Ether (DIPE)	21.25	24.24	114	56-124	8	20
Ethyl tert-Butyl Ether (ETBE)	21.25	23.24	109	61-122	1	22
Methyl tert-Amyl Ether (TAME)	21.25	21.47	101	65-120	1	22
MTBE	21.25	22.25	105	64-121	3	20
1,2-Dichloroethane	21.25	24.84	117	77-137	3	20
Benzene	21.25	22.75	107	80-124	6	20
Toluene	21.25	22.00	104	80-122	2	20
1,2-Dibromoethane	21.25	21.13	99	80-120	5	20
Ethylbenzene	21.25	22.32	105	80-124	0	20
m,p-Xylenes	42.50	48.00	113	80-122	2	20
o-Xylene	21.25	23.74	112	77-120	0	20

Surrogate	%REC	Limits
Dibromofluoromethane	100	77-136
1,2-Dichloroethane-d4	112	75-139
Toluene-d8	101	80-120
Bromofluorobenzene	99	80-120

RPD= Relative Percent Difference

**Batch QC Report**

Purgeable Organics by GC/MS			
Lab #:	257759	Location:	15101 Freedom Avenue San Leandro
Client:	SOMA Environmental Engineering Inc.	Prep:	EPA 5030B
Project#:	2551	Analysis:	EPA 8260B
Field ID:	ZZZZZZZZZZ	Diln Fac:	1.000
MSS Lab ID:	257922-003	Batch#:	212333
Matrix:	Water	Sampled:	06/11/14
Units:	ug/L	Received:	06/11/14

Type: MS Analyzed: 06/18/14  
 Lab ID: QC745477

Analyte	MSS Result	Spiked	Result	%REC	Limits
tert-Butyl Alcohol (TBA)	<1.458	100.0	88.98	89	38-150
Isopropyl Ether (DIPE)	<0.1000	20.00	22.49	112	62-120
Ethyl tert-Butyl Ether (ETBE)	<0.1000	20.00	21.27	106	64-120
Methyl tert-Amyl Ether (TAME)	<0.1000	20.00	20.46	102	67-120
MTBE	<0.1000	20.00	20.11	101	66-120
1,2-Dichloroethane	<0.1000	20.00	22.95	115	80-136
Benzene	<0.1000	20.00	21.37	107	80-127
Toluene	<0.1000	20.00	19.92	100	80-123
1,2-Dibromoethane	<0.1000	20.00	19.17	96	80-120
Ethylbenzene	<0.1561	20.00	20.13	101	80-126
m,p-Xylenes	<0.1000	40.00	42.92	107	80-123
o-Xylene	<0.09974	20.00	20.78	104	76-120

Surrogate	%REC	Limits
Dibromofluoromethane	102	77-136
1,2-Dichloroethane-d4	113	75-139
Toluene-d8	103	80-120
Bromofluorobenzene	100	80-120

Type: MSD Analyzed: 06/19/14  
 Lab ID: QC745478

Analyte	Spiked	Result	%REC	Limits	RPD	Lim
tert-Butyl Alcohol (TBA)	100.0	90.47	90	38-150	2	38
Isopropyl Ether (DIPE)	20.00	22.32	112	62-120	1	25
Ethyl tert-Butyl Ether (ETBE)	20.00	21.49	107	64-120	1	27
Methyl tert-Amyl Ether (TAME)	20.00	19.82	99	67-120	3	28
MTBE	20.00	20.12	101	66-120	0	27
1,2-Dichloroethane	20.00	22.08	110	80-136	4	23
Benzene	20.00	20.22	101	80-127	6	23
Toluene	20.00	19.27	96	80-123	3	22
1,2-Dibromoethane	20.00	19.30	96	80-120	1	23
Ethylbenzene	20.00	19.13	96	80-126	5	22
m,p-Xylenes	40.00	41.24	103	80-123	4	22
o-Xylene	20.00	19.93	100	76-120	4	23

Surrogate	%REC	Limits
Dibromofluoromethane	101	77-136
1,2-Dichloroethane-d4	111	75-139
Toluene-d8	98	80-120
Bromofluorobenzene	99	80-120

RPD= Relative Percent Difference

Date : 17-JUN-2014 18:05  
Client ID: DYNA P&T  
Sample Info: S,257759-001

Instrument: MSV0A10.i

Operator: VOA

Column diameter: 2.00

Column phase:

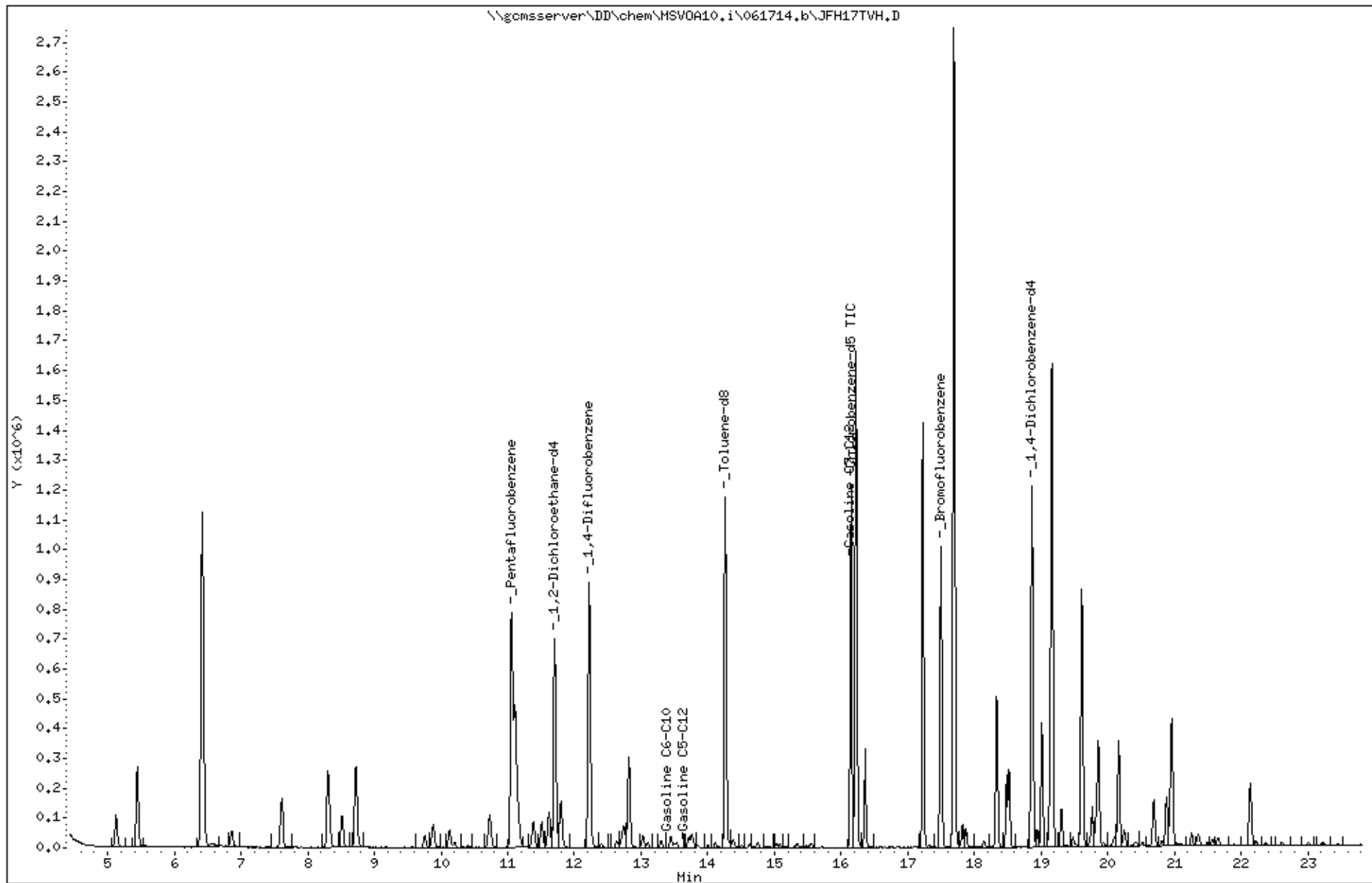



Date : 17-JUN-2014 16:19  
Client ID: DYNA P&T  
Sample Info: S,258759-002

Instrument: MSV0A10.i

Operator: VOA  
Column diameter: 2.00

Column phase:

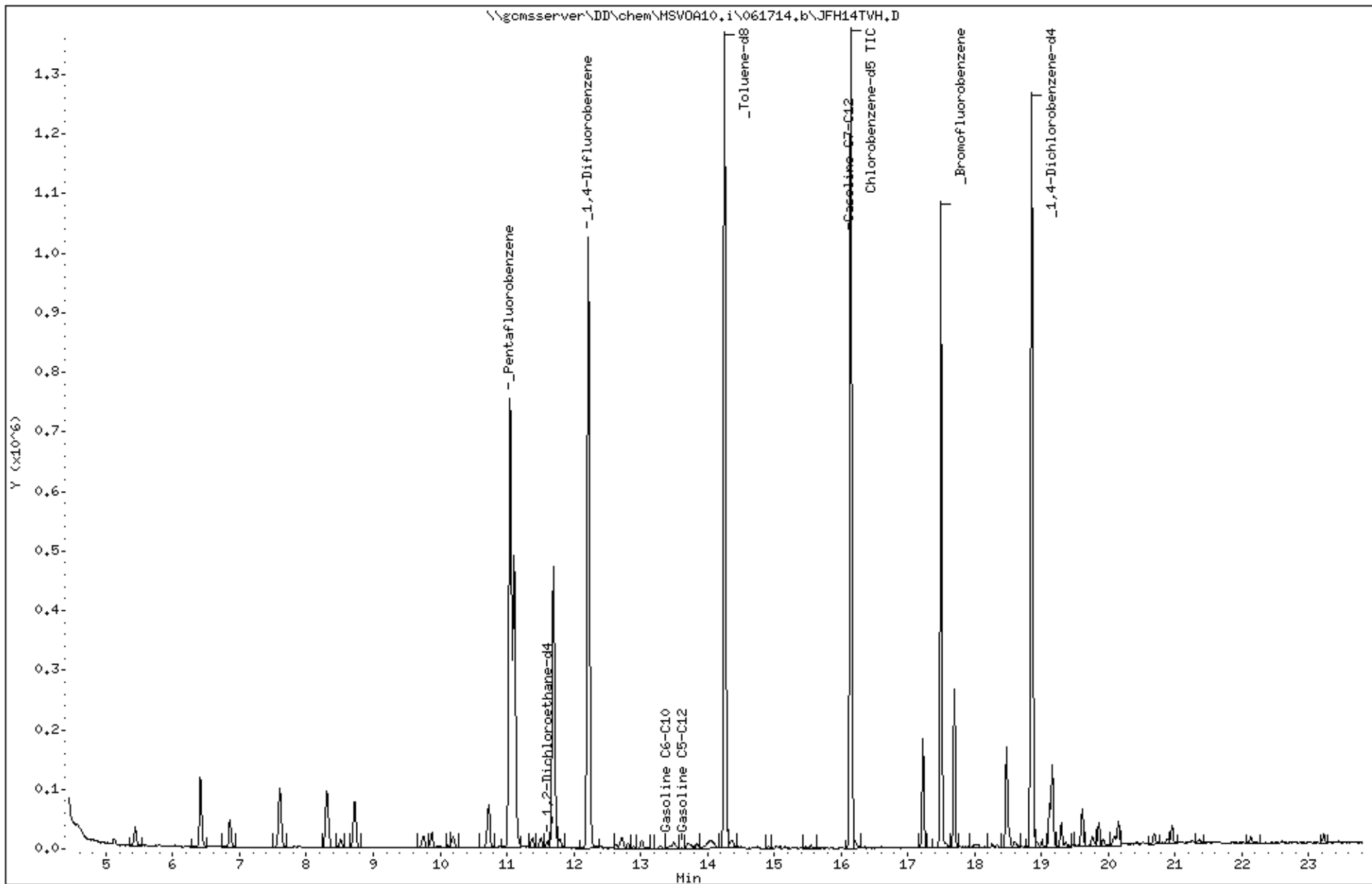

Date : 17-JUN-2014 15:47  
Client ID: DYNA P&T  
Sample Info: S,258759-004

Instrument: MSV0A10.i

Operator: VOA  
Column diameter: 2.00

Column phase:

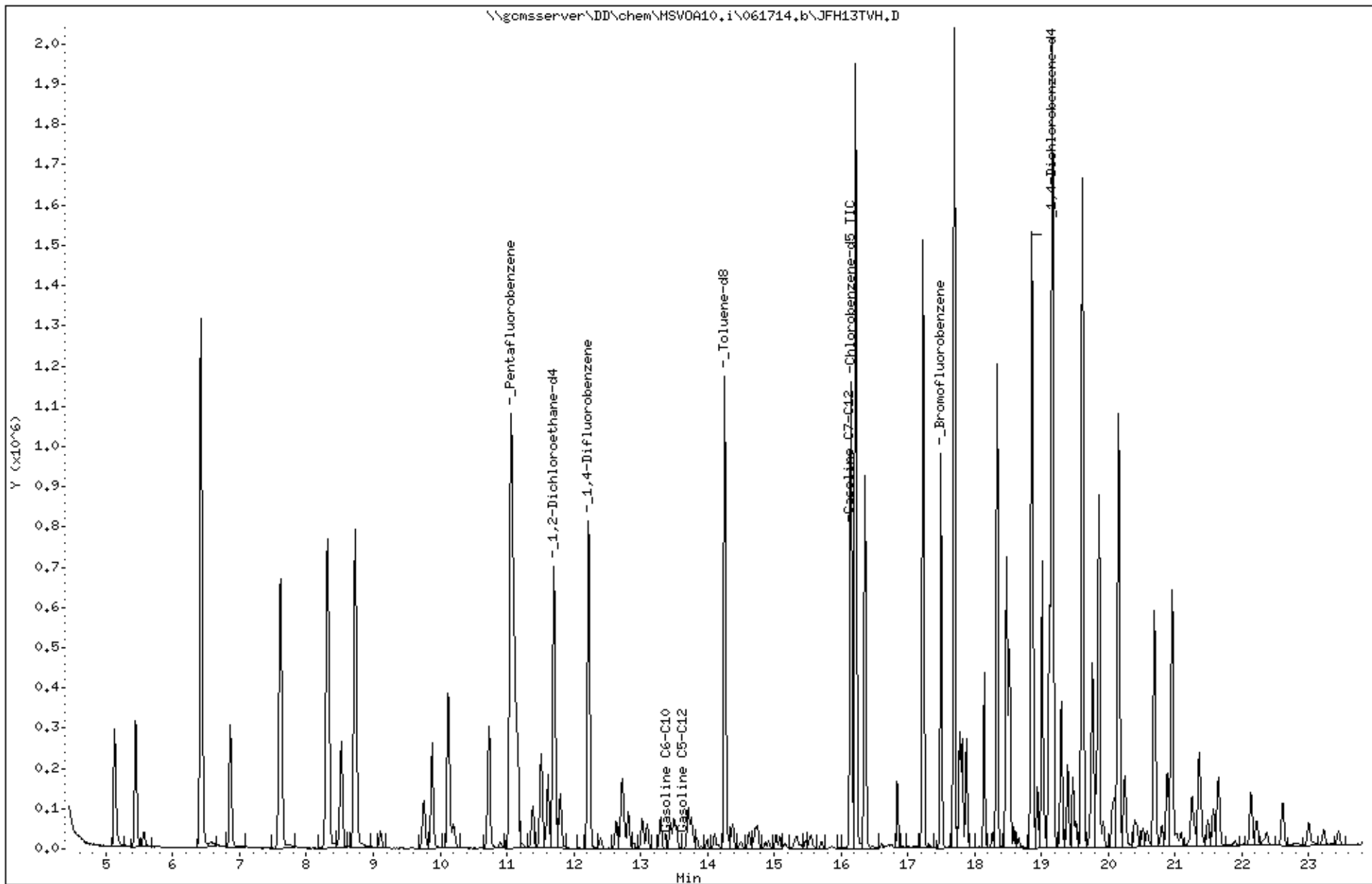

Date : 14-JUN-2014 03:09

Client ID: DYNA P&T

Sample Info: S,257759-005

Instrument: MSV0A10.i

Operator: VOA

Column diameter: 2.00

Column phase:

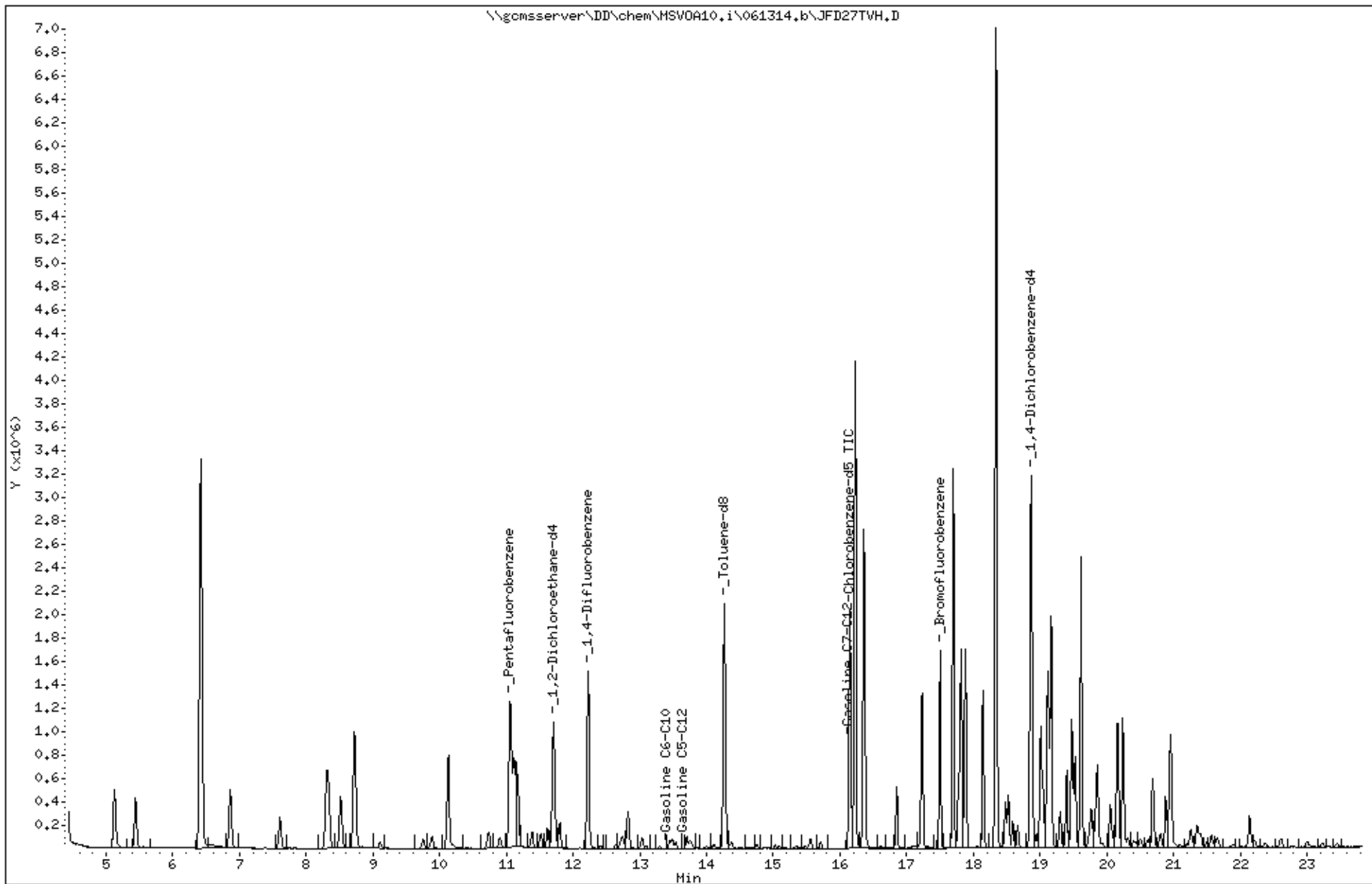

Date : 13-JUN-2014 23:25

Client ID: DYNA P&T

Sample Info: S,257759-006

Instrument: MSV0A10.i

Operator: VOA

Column diameter: 2.00

Column phase:

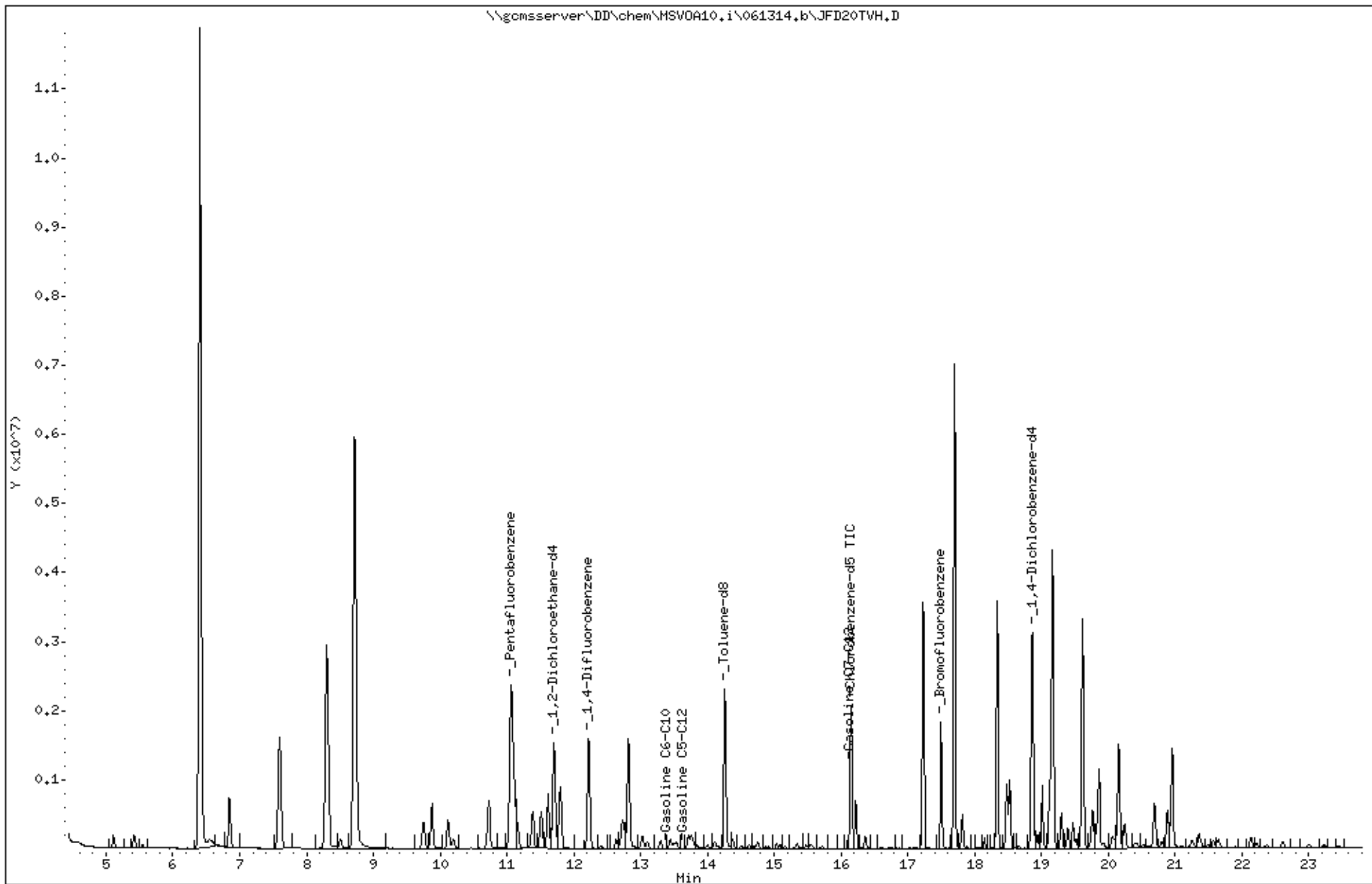

Date : 14-JUN-2014 01:33

Client ID: DYNA P&T

Sample Info: S,257759-010

Instrument: MSV0A10.i

Operator: VOA

Column diameter: 2.00

Column phase:

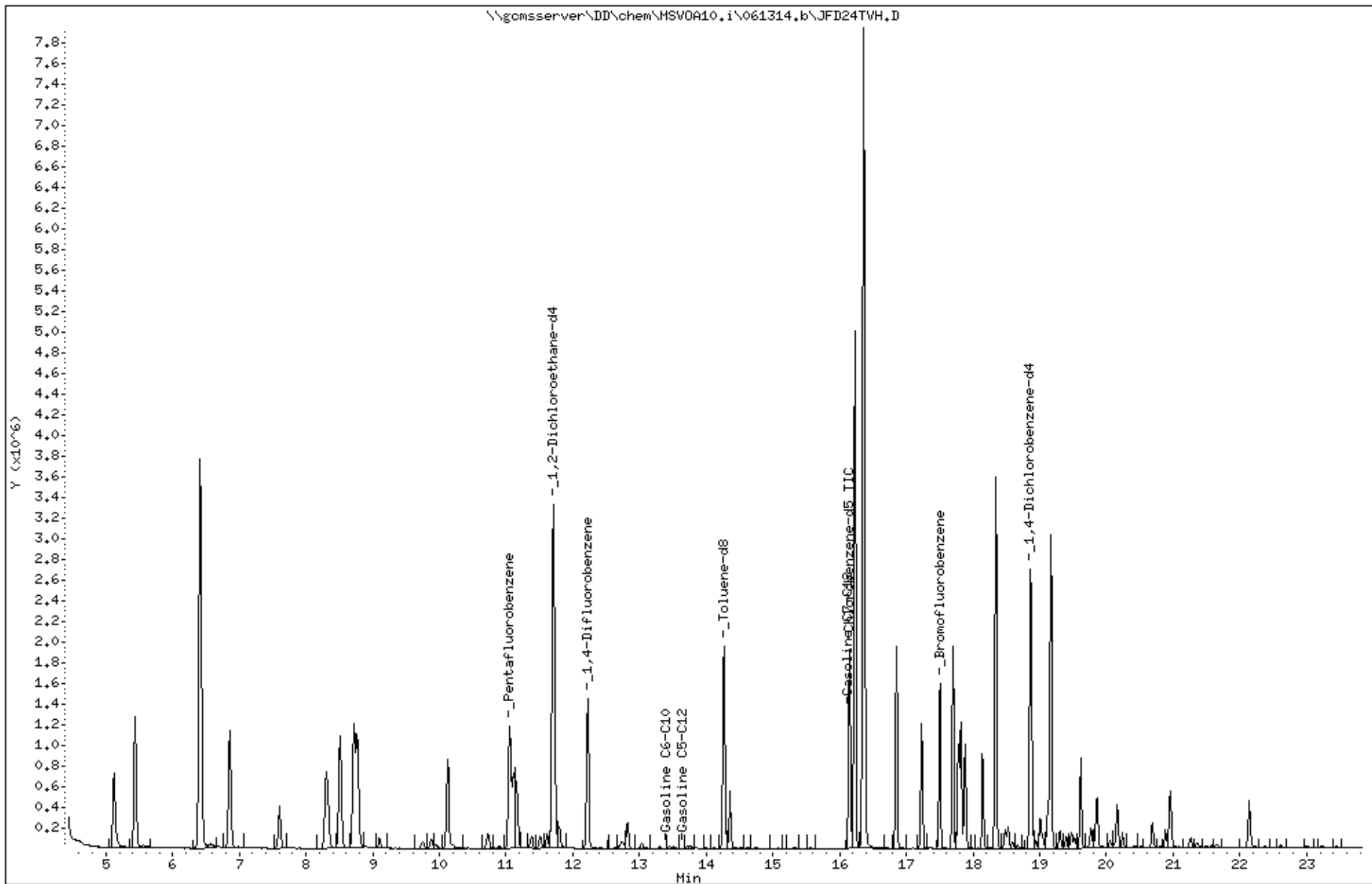

Date : 14-JUN-2014 02:37

Client ID: DYNA P&T

Sample Info: S,257759-011

Instrument: MSV0A10.i

Operator: VOA

Column diameter: 2.00

Column phase:

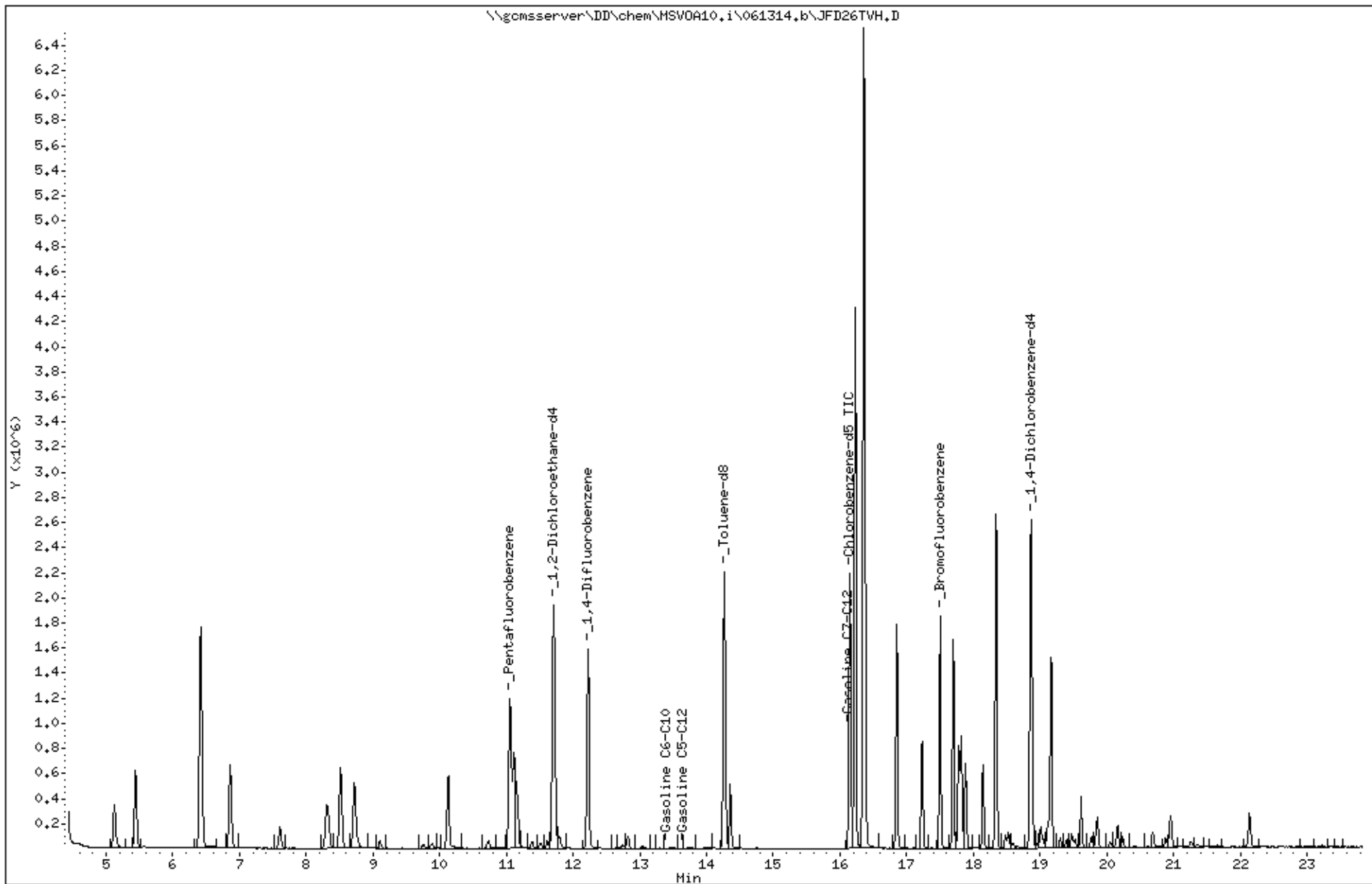

Date : 13-JUN-2014 17:39

Client ID: DYNA P&T

Sample Info: CCV/BS, QC744806, 212186, S24762, 10000X

Instrument: MSV0A10.i

Operator: VOA

Column diameter: 2.00

Column phase:

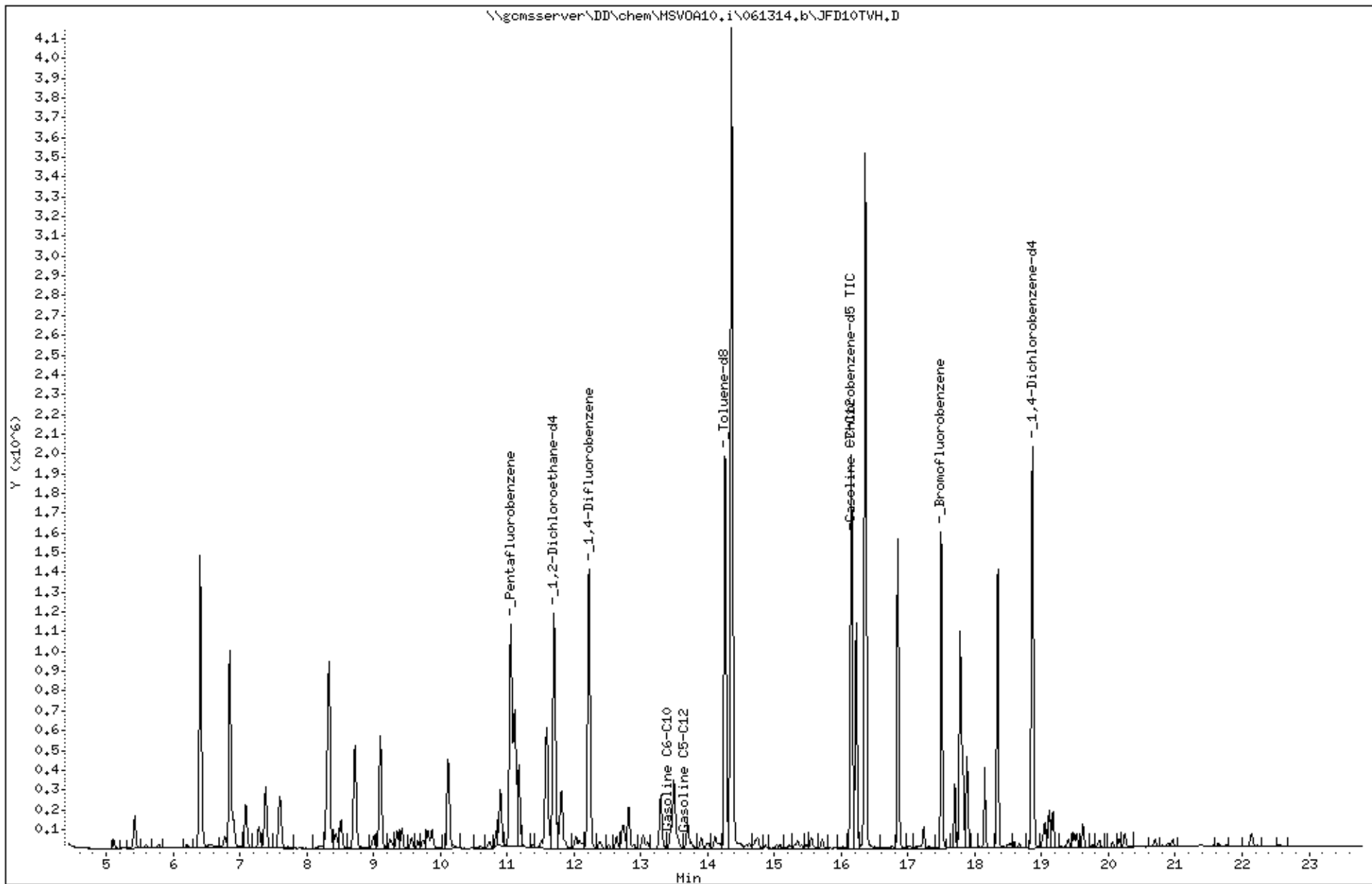

# Appendix D

## Laboratory Reports and Chain of Custody Forms for the Treatment System





Curtis & Tompkins, Ltd., Analytical Laboratories, Since 1878

2323 Fifth Street, Berkeley, CA 94710, Phone (510) 486-0900

**Laboratory Job Number 255697  
ANALYTICAL REPORT**

SOMA Environmental Engineering Inc.  
6620 Owens Dr.  
Pleasanton, CA 94588

Project : 2553  
Location : 15101 Freedom Ave. San Leandro  
Level : II

<u>Sample ID</u>	<u>Lab ID</u>
EFFLUENT	255697-001
GAC-1	255697-002
INFLUENT	255697-003

This data package has been reviewed for technical correctness and completeness. Release of this data has been authorized by the Laboratory Manager or the Manager's designee, as verified by the following signature. The results contained in this report meet all requirements of NELAC and pertain only to those samples which were submitted for analysis. This report may be reproduced only in its entirety.

Signature: \_\_\_\_\_

Tracy Babjar  
Project Manager  
tracy.babjar@ctberk.com  
(510) 204-2226

Date: 04/24/2014

CA ELAP# 2896, NELAP# 4044-001

**CASE NARRATIVE**

Laboratory number: 255697  
Client: SOMA Environmental Engineering Inc.  
Project: 2553  
Location: 15101 Freedom Ave. San Leandro  
Request Date: 04/17/14  
Samples Received: 04/17/14

This data package contains sample and QC results for three water samples, requested for the above referenced project on 04/17/14. The samples were received cold and intact.

**TPH-Purgeables and/or BTXE by GC (EPA 8015B and EPA 8021B):**

No analytical problems were encountered.

**TPH-Extractables by GC (EPA 8015B):**

No analytical problems were encountered.

# CHAIN OF CUSTODY

## Analyses

**Curtis & Tompkins, Ltd**  
 Analytical Laboratory Since 1878  
 2323 Fifth Street  
 Berkeley, CA 94710  
 (510)486-0900 Phone  
 (510)486-0532 Fax

LOGIN # 255697

Sampler: MASOOD

Project No: 2553

Report To: Joyce Bobek

Project Name: 15101 Freedom Ave, San Leandr Company: SOMA Environmental

Turnaround Time: Standard

Telephone: 925-734-6400

Fax: 925-734-6401

Lab No.	Sample ID.	Sampling Date Time	Matrix			# of Containers	Preservative				TPH-g 8015	TPH-d, TPH-mo 8015	BTEX 8020							
			Soil	Water	Waste		HCL	H <sub>2</sub> SO <sub>4</sub>	HNO <sub>3</sub>	ICE										
1	EFFLUENT	4/17/14-9		*		6 VOAs	*			*	*									
				*		1-1 L Amber			*		*									
2	GAC-1		*			6 VOAs	*			*	*									
3	INFLUENT		*			6 VOAs	*			*	*									

Notes: **EDF OUTPUT REQUIRED**

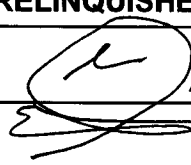
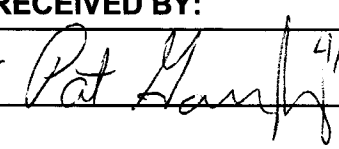
RELINQUISHED BY:		RECEIVED BY:	
	4/17/14 11:10		4/17/14 11:10
	DATE/TIME		DATE/TIME
	DATE/TIME		DATE/TIME
	DATE/TIME		DATE/TIME

COOLER RECEIPT CHECKLIST



Curtis & Tompkins, Ltd.

Login # 255697 Date Received 4/17/14 Number of coolers 0
Client GMA Environmental Project 2553

Date Opened 4/17/14 By (print) MT (sign) [Signature]
Date Logged in [Signature] By (print) [Signature] (sign) [Signature]

1. Did cooler come with a shipping slip (airbill, etc) YES NO
Shipping info

2A. Were custody seals present? ... YES (circle) on cooler on samples NO
How many Name Date

2B. Were custody seals intact upon arrival? YES NO N/A

3. Were custody papers dry and intact when received? YES NO

4. Were custody papers filled out properly (ink, signed, etc)? YES NO

5. Is the project identifiable from custody papers? (If so fill out top of form) YES NO

6. Indicate the packing in cooler: (if other, describe)

- Bubble Wrap, Cloth material, Foam blocks, Cardboard, Bags, Styrofoam, None, Paper towels

7. Temperature documentation: \* Notify PM if temperature exceeds 6°C

Type of ice used: Wet, Blue/Gel, None Temp(°C)

Samples received on ice & cold without a temperature blank; temp taken with IR gun

Samples received on ice directly from the field. Cooling process had begun

8. Were Method 5035 sampling containers present? YES NO

If YES, what time were they transferred to freezer?

9. Did all bottles arrive unbroken/unopened? YES NO

10. Are there any missing / extra samples? YES NO

11. Are samples in the appropriate containers for indicated tests? YES NO

12. Are sample labels present, in good condition and complete? YES NO

13. Do the sample labels agree with custody papers? YES NO

14. Was sufficient amount of sample sent for tests requested? YES NO

15. Are the samples appropriately preserved? YES NO N/A

16. Did you check preservatives for all bottles for each sample? YES NO N/A

17. Did you document your preservative check? YES NO N/A

18. Did you change the hold time in LIMS for unpreserved VOAs? YES NO N/A

19. Did you change the hold time in LIMS for preserved terracores? YES NO N/A

20. Are bubbles > 6mm absent in VOA samples? YES NO N/A

21. Was the client contacted concerning this sample delivery? YES NO

If YES, Who was called? By Date:

COMMENTS

Blank lines for handwritten comments.

## Detections Summary for 255697

Client : SOMA Environmental Engineering Inc.  
 Project : 2553  
 Location : 15101 Freedom Ave. San Leandro

Client Sample ID : EFFLUENT                      Laboratory Sample ID :                      255697-001

Analyte	Result	Flags	RL	MDL	Units	Basis	IDF	Method	Prep Method
Gasoline C7-C12	89	Y	50	11	ug/L	As Recd	1.000	EPA 8015B	EPA 5030B

Client Sample ID : GAC-1                      Laboratory Sample ID :                      255697-002

No Detections

Client Sample ID : INFLUENT                      Laboratory Sample ID :                      255697-003

Analyte	Result	Flags	RL	MDL	Units	Basis	IDF	Method	Prep Method
Gasoline C7-C12	650		50	11	ug/L	As Recd	1.000	EPA 8015B	EPA 5030B
Benzene	19		0.50	0.10	ug/L	As Recd	1.000	EPA 8021B	EPA 5030B
Toluene	0.67		0.50	0.11	ug/L	As Recd	1.000	EPA 8021B	EPA 5030B
Ethylbenzene	16		0.50	0.10	ug/L	As Recd	1.000	EPA 8021B	EPA 5030B
m,p-Xylenes	42		0.50	0.14	ug/L	As Recd	1.000	EPA 8021B	EPA 5030B
o-Xylene	8.1		0.50	0.11	ug/L	As Recd	1.000	EPA 8021B	EPA 5030B

Y = Sample exhibits chromatographic pattern which does not resemble standard

**Curtis & Tompkins Laboratories Analytical Report**

Lab #:	255697	Location:	15101 Freedom Ave. San Leandro	
Client:	SOMA Environmental Engineering Inc.	Prep:	EPA 5030B	
Project#:	2553			
Matrix:	Water	Sampled:	04/17/14	
Units:	ug/L	Received:	04/17/14	
Diln Fac:	1.000	Analyzed:	04/18/14	
Batch#:	210203			

Field ID: EFFLUENT                                  Lab ID: 255697-001  
 Type: SAMPLE

Analyte	Result	RL	Analysis
Gasoline C7-C12	89 Y	50	EPA 8015B
Benzene	ND	0.50	EPA 8021B
Toluene	ND	0.50	EPA 8021B
Ethylbenzene	ND	0.50	EPA 8021B
m,p-Xylenes	ND	0.50	EPA 8021B
o-Xylene	ND	0.50	EPA 8021B

Surrogate	%REC	Limits	Analysis
Bromofluorobenzene (FID)	104	77-128	EPA 8015B
Bromofluorobenzene (PID)	112	75-132	EPA 8021B

Field ID: GAC-1                                      Lab ID: 255697-002  
 Type: SAMPLE

Analyte	Result	RL	Analysis
Gasoline C7-C12	ND	50	EPA 8015B
Benzene	ND	0.50	EPA 8021B
Toluene	ND	0.50	EPA 8021B
Ethylbenzene	ND	0.50	EPA 8021B
m,p-Xylenes	ND	0.50	EPA 8021B
o-Xylene	ND	0.50	EPA 8021B

Surrogate	%REC	Limits	Analysis
Bromofluorobenzene (FID)	104	77-128	EPA 8015B
Bromofluorobenzene (PID)	113	75-132	EPA 8021B

Y= Sample exhibits chromatographic pattern which does not resemble standard  
 ND= Not Detected  
 RL= Reporting Limit

### Curtis & Tompkins Laboratories Analytical Report

Lab #:	255697	Location:	15101 Freedom Ave. San Leandro
Client:	SOMA Environmental Engineering Inc.	Prep:	EPA 5030B
Project#:	2553		
Matrix:	Water	Sampled:	04/17/14
Units:	ug/L	Received:	04/17/14
Diln Fac:	1.000	Analyzed:	04/18/14
Batch#:	210203		

Field ID: INFLUENT                      Lab ID: 255697-003  
 Type: SAMPLE

Analyte	Result	RL	Analysis
Gasoline C7-C12	650	50	EPA 8015B
Benzene	19	0.50	EPA 8021B
Toluene	0.67	0.50	EPA 8021B
Ethylbenzene	16	0.50	EPA 8021B
m,p-Xylenes	42	0.50	EPA 8021B
o-Xylene	8.1	0.50	EPA 8021B

Surrogate	%REC	Limits	Analysis
Bromofluorobenzene (FID)	105	77-128	EPA 8015B
Bromofluorobenzene (PID)	114	75-132	EPA 8021B

Type: BLANK                              Lab ID: QC736658

Analyte	Result	RL	Analysis
Gasoline C7-C12	ND	50	EPA 8015B
Benzene	ND	0.50	EPA 8021B
Toluene	ND	0.50	EPA 8021B
Ethylbenzene	ND	0.50	EPA 8021B
m,p-Xylenes	ND	0.50	EPA 8021B
o-Xylene	ND	0.50	EPA 8021B

Surrogate	%REC	Limits	Analysis
Bromofluorobenzene (FID)	103	77-128	EPA 8015B
Bromofluorobenzene (PID)	114	75-132	EPA 8021B

Y= Sample exhibits chromatographic pattern which does not resemble standard  
 ND= Not Detected  
 RL= Reporting Limit

## Batch QC Report

**Curtis & Tompkins Laboratories Analytical Report**

Lab #:	255697	Location:	15101 Freedom Ave. San Leandro
Client:	SOMA Environmental Engineering Inc.	Prep:	EPA 5030B
Project#:	2553	Analysis:	EPA 8021B
Matrix:	Water	Batch#:	210203
Units:	ug/L	Analyzed:	04/18/14
Diln Fac:	1.000		

Type: BS Lab ID: QC736655

Analyte	Spiked	Result	%REC	Limits
Benzene	10.00	10.12	101	80-120
Toluene	10.00	9.974	100	80-120
Ethylbenzene	10.00	10.65	107	80-120
m,p-Xylenes	10.00	10.63	106	80-120
o-Xylene	10.00	10.58	106	80-120

Surrogate	%REC	Limits
Bromofluorobenzene (PID)	114	75-132

Type: BSD Lab ID: QC736656

Analyte	Spiked	Result	%REC	Limits	RPD	Lim
Benzene	10.00	10.26	103	80-120	1	20
Toluene	10.00	10.31	103	80-120	3	20
Ethylbenzene	10.00	10.82	108	80-120	2	20
m,p-Xylenes	10.00	10.70	107	80-120	1	20
o-Xylene	10.00	10.89	109	80-120	3	20

Surrogate	%REC	Limits
Bromofluorobenzene (PID)	113	75-132

RPD= Relative Percent Difference



## Batch QC Report

**Curtis & Tompkins Laboratories Analytical Report**

Lab #:	255697	Location:	15101 Freedom Ave. San Leandro	
Client:	SOMA Environmental Engineering Inc.	Prep:	EPA 5030B	
Project#:	2553	Analysis:	EPA 8015B	
Type:	LCS	Diln Fac:	1.000	
Lab ID:	QC736657	Batch#:	210203	
Matrix:	Water	Analyzed:	04/18/14	
Units:	ug/L			

Analyte	Spiked	Result	%REC	Limits
Gasoline C7-C12	1,000	1,078	108	80-120

Surrogate	%REC	Limits
Bromofluorobenzene (FID)	103	77-128

## Batch QC Report

**Curtis & Tompkins Laboratories Analytical Report**

Lab #:	255697	Location:	15101 Freedom Ave. San Leandro
Client:	SOMA Environmental Engineering Inc.	Prep:	EPA 5030B
Project#:	2553	Analysis:	EPA 8015B
Field ID:	ZZZZZZZZZZ	Batch#:	210203
MSS Lab ID:	255690-006	Sampled:	04/16/14
Matrix:	Water	Received:	04/16/14
Units:	ug/L	Analyzed:	04/18/14
Diln Fac:	1.000		

Type: MS Lab ID: QC736698

Analyte	MSS Result	Spiked	Result	%REC	Limits
Gasoline C7-C12	35.79	2,000	2,071	102	74-120

Surrogate	%REC	Limits
Bromofluorobenzene (FID)	108	77-128

Type: MSD Lab ID: QC736699

Analyte	Spiked	Result	%REC	Limits	RPD	Lim
Gasoline C7-C12	2,000	2,104	103	74-120	2	27

Surrogate	%REC	Limits
Bromofluorobenzene (FID)	106	77-128

RPD= Relative Percent Difference

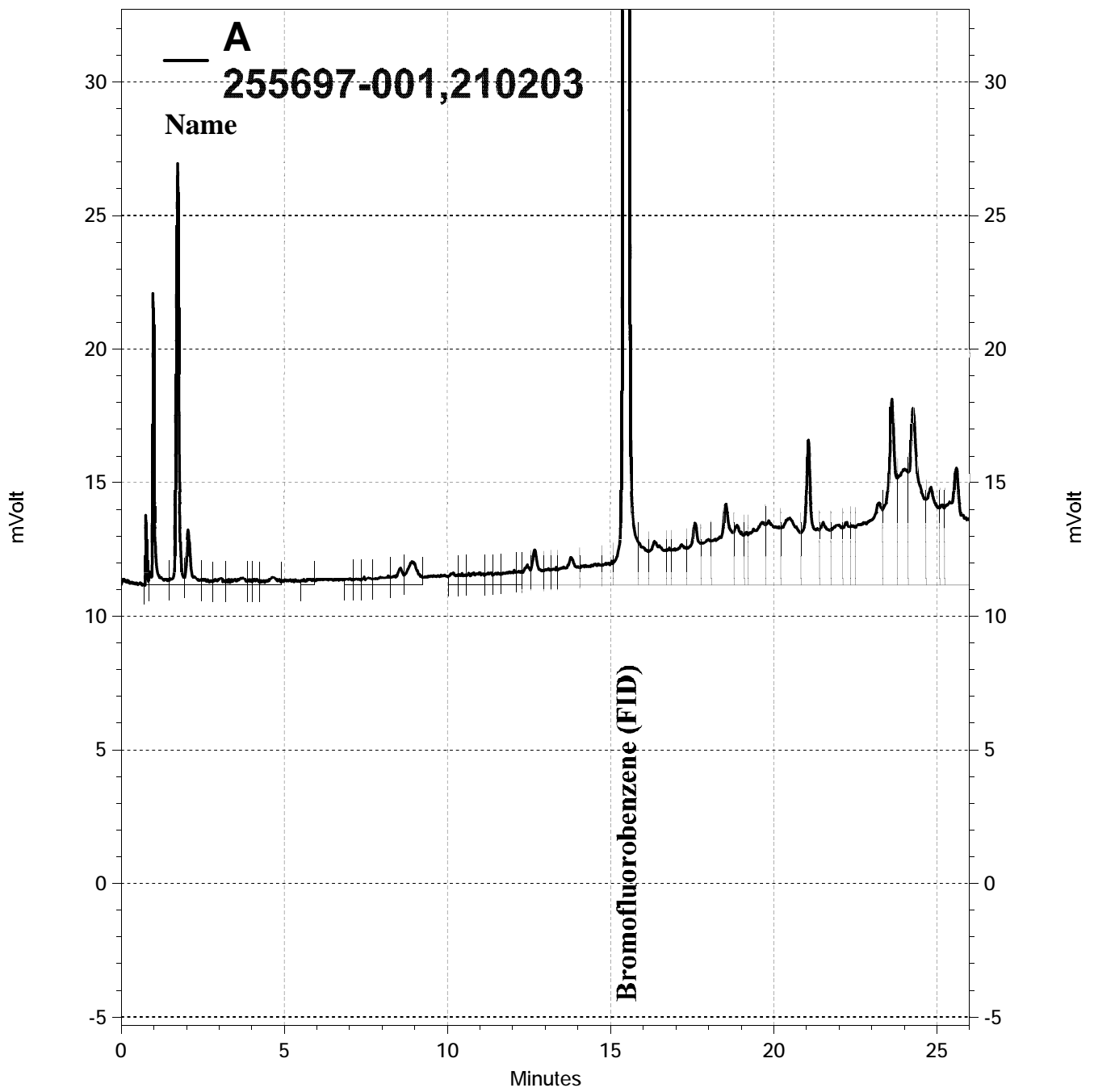

— \\Lims\gdrive\ezchrom\Projects\GC07\Data\108-009, A

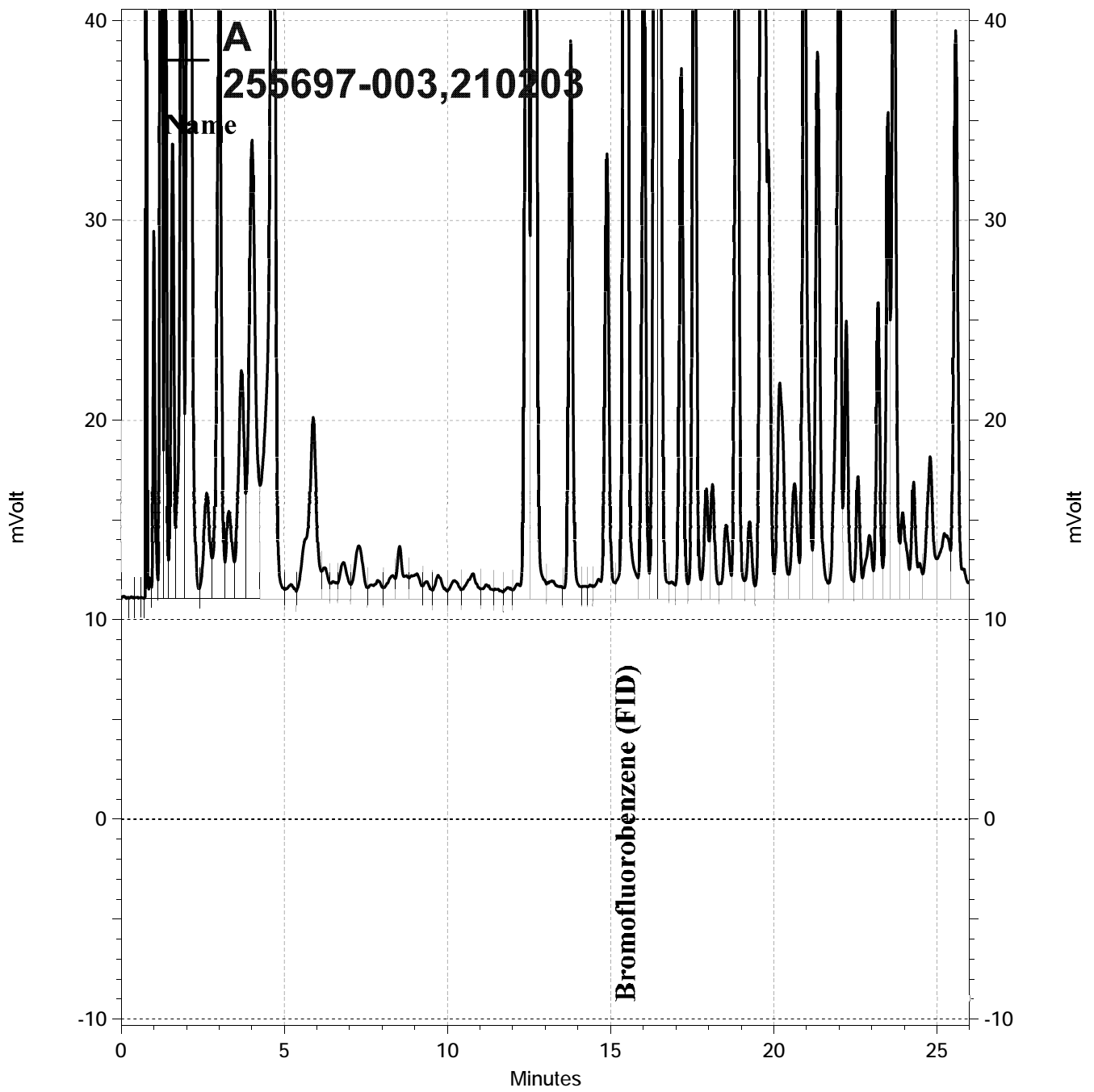

— \\Lims\gdrive\ezchrom\Projects\GC07\Data\108-011, A

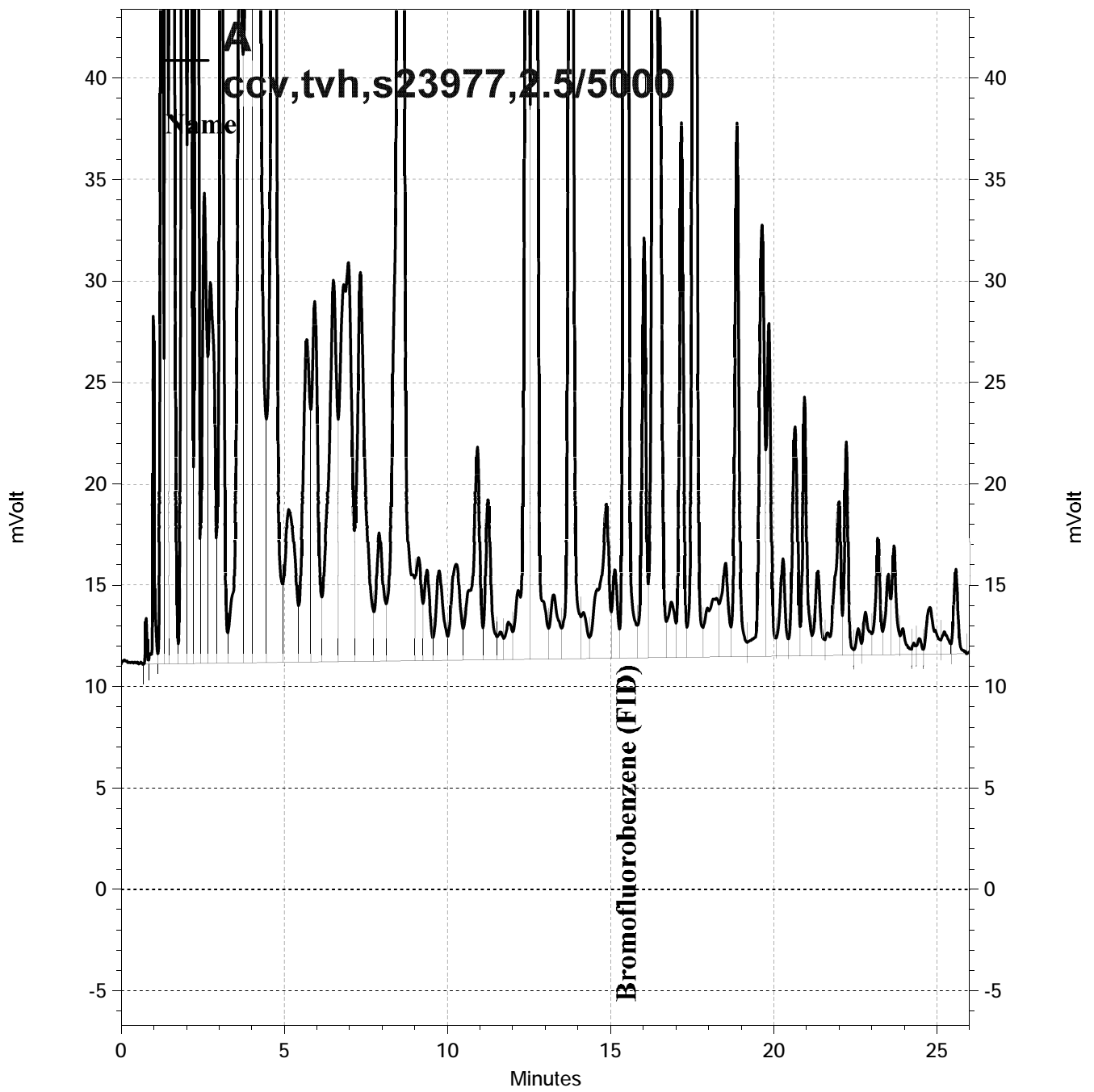

— \\Lims\gdrive\ezchrom\Projects\GC07\Data\108-003, A

Total Extractable Hydrocarbons			
Lab #:	255697	Location:	15101 Freedom Ave. San Leandro
Client:	SOMA Environmental Engineering Inc.	Prep:	EPA 3520C
Project#:	2553	Analysis:	EPA 8015B
Field ID:	EFFLUENT	Batch#:	210224
Matrix:	Water	Sampled:	04/17/14
Units:	ug/L	Received:	04/17/14
Diln Fac:	1.000	Prepared:	04/18/14

Type: SAMPLE Analyzed: 04/24/14  
 Lab ID: 255697-001

Analyte	Result	RL
Diesel C10-C24	ND	50
Motor Oil C24-C36	ND	300

Surrogate	%REC	Limits
o-Terphenyl	104	66-129

Type: BLANK Analyzed: 04/21/14  
 Lab ID: QC736747

Analyte	Result	RL
Diesel C10-C24	ND	50
Motor Oil C24-C36	ND	300

Surrogate	%REC	Limits
o-Terphenyl	109	66-129

ND= Not Detected  
 RL= Reporting Limit

## Batch QC Report

Total Extractable Hydrocarbons			
Lab #:	255697	Location:	15101 Freedom Ave. San Leandro
Client:	SOMA Environmental Engineering Inc.	Prep:	EPA 3520C
Project#:	2553	Analysis:	EPA 8015B
Matrix:	Water	Batch#:	210224
Units:	ug/L	Prepared:	04/18/14
Diln Fac:	1.000		

Type: BS Analyzed: 04/22/14  
 Lab ID: QC736748 Cleanup Method: EPA 3630C

Analyte	Spiked	Result	%REC	Limits
Diesel C10-C24	2,500	2,137	85	61-120

Surrogate	%REC	Limits
o-Terphenyl	106	66-129

Type: BSD Analyzed: 04/21/14  
 Lab ID: QC736749 Cleanup Method: EPA 3630C

Analyte	Spiked	Result	%REC	Limits	RPD	Lim
Diesel C10-C24	2,500	2,691	108	61-120	23	45

Surrogate	%REC	Limits
o-Terphenyl	127	66-129

RPD= Relative Percent Difference

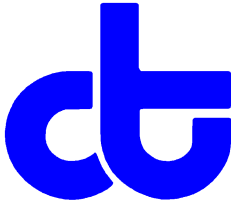

Curtis & Tompkins, Ltd., Analytical Laboratories, Since 1878

2323 Fifth Street, Berkeley, CA 94710, Phone (510) 486-0900

**Laboratory Job Number 256900  
ANALYTICAL REPORT**

SOMA Environmental Engineering Inc.  
6620 Owens Dr.  
Pleasanton, CA 94588

Project : 2553  
Location : 15101 Freedom Ave. San Leandro  
Level : II

Sample ID  
EFFLUENT

Lab ID  
256900-001

This data package has been reviewed for technical correctness and completeness. Release of this data has been authorized by the Laboratory Manager or the Manager's designee, as verified by the following signature. The results contained in this report meet all requirements of NELAC and pertain only to those samples which were submitted for analysis. This report may be reproduced only in its entirety.

Signature: \_\_\_\_\_

Tracy Babjar  
Project Manager  
tracy.babjar@ctberk.com  
(510) 204-2226

Date: 05/22/2014

CA ELAP# 2896, NELAP# 4044-001



### CASE NARRATIVE

Laboratory number: 256900  
Client: SOMA Environmental Engineering Inc.  
Project: 2553  
Location: 15101 Freedom Ave. San Leandro  
Request Date: 05/16/14  
Samples Received: 05/16/14

This data package contains sample and QC results for one water sample, requested for the above referenced project on 05/16/14. The sample was received cold and intact.

**TPH-Purgeables and/or BTXE by GC (EPA 8015B and EPA 8021B):**

High response was observed for m,p-xylenes in the CCV analyzed 05/18/14 17:49; affected data was qualified with "b". No other analytical problems were encountered.

**TPH-Extractables by GC (EPA 8015B):**

No analytical problems were encountered.

# CHAIN OF CUSTODY

**Curtis & Tompkins, Ltd**  
 Analytical Laboratory Since 1878  
 2323 Fifth Street  
 Berkeley, CA 94710  
 (510)486-0900 Phone  
 (510)486-0532 Fax

## Analyses

LOGIN # 251A00

Sampler: DAVID B

Project No: 2553

Report To: Joyce Bobek

Project Name: 15101 Freedom Ave, San Leandro Company: SOMA Environmental

Turnaround Time: Standard

Telephone: 925-734-6400

Fax: 925-734-6401

Lab No.	Sample ID.	Sampling Date Time	Matrix				# of Containers	Preservative												
			Soil	Water	Waste			HCL	H <sub>2</sub> SO <sub>4</sub>	HNO <sub>3</sub>	ICE									
	Effluent	5/15/14 9:55	*				6 VOAs	*			*									
			*				2-500 mL Ambers				*									

Notes: **EDF OUTPUT REQUIRED**

RELINQUISHED BY:		RECEIVED BY:	
<i>DB</i>	5/15/14 10:45	<i>[Signature]</i>	5/15/14 10:45
	DATE/TIME		DATE/TIME
<i>[Signature]</i>	5/16/14 11:37	<i>[Signature]</i>	5/16/14 11:37
	DATE/TIME		DATE/TIME
	DATE/TIME		DATE/TIME

**COOLER RECEIPT CHECKLIST**



Curtis & Tompkins, Ltd.

# 256900  
 Login # ~~256900~~ Date Received 5/16/14 Number of coolers 1  
 Client SOMA Environmental Project 2553

Date Opened 5/16/14 By (print) MT (sign) [Signature]  
 Date Logged in 5/16/14 By (print) Me (sign) [Signature]

1. Did cooler come with a shipping slip (airbill, etc) YES  NO  
 Shipping info \_\_\_\_\_

2A. Were custody seals present? ....  YES (circle) on cooler on samples  NO  
 How many \_\_\_\_\_ Name \_\_\_\_\_ Date \_\_\_\_\_

2B. Were custody seals intact upon arrival? \_\_\_\_\_ YES NO N/A

3. Were custody papers dry and intact when received? YES NO

4. Were custody papers filled out properly (ink, signed, etc)? YES NO

5. Is the project identifiable from custody papers? (If so fill out top of form) YES NO

6. Indicate the packing in cooler: (if other, describe) \_\_\_\_\_

- Bubble Wrap  Foam blocks  Bags  None
- Cloth material  Cardboard  Styrofoam  Paper towels

7. Temperature documentation: \* Notify PM if temperature exceeds 6°C

Type of ice used:  Wet  Blue/Gel  None Temp(°C) 6.0

Samples received on ice & cold without a temperature blank; temp taken with IR gun

Samples received on ice directly from the field. Cooling process had begun

8. Were Method 5035 sampling containers present? \_\_\_\_\_ YES  NO

If YES, what time were they transferred to freezer? \_\_\_\_\_

9. Did all bottles arrive unbroken/unopened? \_\_\_\_\_ YES NO

10. Are there any missing / extra samples? \_\_\_\_\_ YES  NO

11. Are samples in the appropriate containers for indicated tests? \_\_\_\_\_  YES NO

12. Are sample labels present, in good condition and complete? \_\_\_\_\_  YES NO

13. Do the sample labels agree with custody papers? \_\_\_\_\_  YES NO

14. Was sufficient amount of sample sent for tests requested? \_\_\_\_\_  YES NO

15. Are the samples appropriately preserved? \_\_\_\_\_  YES NO N/A

16. Did you check preservatives for all bottles for each sample? \_\_\_\_\_ YES NO N/A

17. Did you document your preservative check? \_\_\_\_\_ YES NO N/A

18. Did you change the hold time in LIMS for unpreserved VOAs? \_\_\_\_\_ YES NO N/A

19. Did you change the hold time in LIMS for preserved terracores? \_\_\_\_\_ YES NO N/A

20. Are bubbles > 6mm absent in VOA samples? \_\_\_\_\_ YES  NO N/A

21. Was the client contacted concerning this sample delivery? \_\_\_\_\_ YES  NO

If YES, Who was called? \_\_\_\_\_ By \_\_\_\_\_ Date: \_\_\_\_\_

**COMMENTS**

- cool: 1 of 6 VOAs w/ bubble  
 \_\_\_\_\_  
 \_\_\_\_\_  
 \_\_\_\_\_  
 \_\_\_\_\_

Detections Summary for 256900

Client : SOMA Environmental Engineering Inc.  
Project : 2553  
Location : 15101 Freedom Ave. San Leandro

Client Sample ID : EFFLUENT                      Laboratory Sample ID :                      256900-001

No Detections

**Curtis & Tompkins Laboratories Analytical Report**

Lab #:	256900	Location:	15101 Freedom Ave. San Leandro
Client:	SOMA Environmental Engineering Inc.	Prep:	EPA 5030B
Project#:	2553		
Field ID:	EFFLUENT	Batch#:	211213
Matrix:	Water	Sampled:	05/15/14
Units:	ug/L	Received:	05/16/14
Diln Fac:	1.000	Analyzed:	05/18/14

Type: SAMPLE                      Lab ID: 256900-001

Analyte	Result	RL	Analysis
Gasoline C7-C12	ND	50	EPA 8015B
Benzene	ND	0.50	EPA 8021B
Toluene	ND	0.50	EPA 8021B
Ethylbenzene	ND	0.50	EPA 8021B
m,p-Xylenes	ND	0.50	EPA 8021B
o-Xylene	ND	0.50	EPA 8021B

Surrogate	%REC	Limits	Analysis
Bromofluorobenzene (FID)	94	77-128	EPA 8015B
Bromofluorobenzene (PID)	97	75-132	EPA 8021B

Type: BLANK                      Lab ID: QC740831

Analyte	Result	RL	Analysis
Gasoline C7-C12	ND	50	EPA 8015B
Benzene	ND	0.50	EPA 8021B
Toluene	ND	0.50	EPA 8021B
Ethylbenzene	ND	0.50	EPA 8021B
m,p-Xylenes	ND	0.50	EPA 8021B
o-Xylene	ND	0.50	EPA 8021B

Surrogate	%REC	Limits	Analysis
Bromofluorobenzene (FID)	81	77-128	EPA 8015B
Bromofluorobenzene (PID)	84	75-132	EPA 8021B

ND= Not Detected  
 RL= Reporting Limit

## Batch QC Report

**Curtis & Tompkins Laboratories Analytical Report**

Lab #:	256900	Location:	15101 Freedom Ave. San Leandro
Client:	SOMA Environmental Engineering Inc.	Prep:	EPA 5030B
Project#:	2553	Analysis:	EPA 8021B
Matrix:	Water	Batch#:	211213
Units:	ug/L	Analyzed:	05/18/14
Diln Fac:	1.000		

Type: BS Lab ID: QC740828

Analyte	Spiked	Result	%REC	Limits
Benzene	10.00	9.962	100	80-120
Toluene	10.00	10.33	103	80-120
Ethylbenzene	10.00	10.59	106	80-120
m,p-Xylenes	10.00	11.07	111	80-120
o-Xylene	10.00	11.01	110	80-120

Surrogate	%REC	Limits
Bromofluorobenzene (PID)	107	75-132

Type: BSD Lab ID: QC740829

Analyte	Spiked	Result	%REC	Limits	RPD	Lim
Benzene	10.00	10.55	105	80-120	6	20
Toluene	10.00	10.96	110	80-120	6	20
Ethylbenzene	10.00	11.14	111	80-120	5	20
m,p-Xylenes	10.00	11.66 b	117	80-120	5	20
o-Xylene	10.00	11.56	116	80-120	5	20

Surrogate	%REC	Limits
Bromofluorobenzene (PID)	101	75-132

b= See narrative

RPD= Relative Percent Difference

## Batch QC Report

**Curtis & Tompkins Laboratories Analytical Report**

Lab #:	256900	Location:	15101 Freedom Ave. San Leandro	
Client:	SOMA Environmental Engineering Inc.	Prep:	EPA 5030B	
Project#:	2553	Analysis:	EPA 8015B	
Type:	LCS	Diln Fac:	1.000	
Lab ID:	QC740830	Batch#:	211213	
Matrix:	Water	Analyzed:	05/18/14	
Units:	ug/L			

Analyte	Spiked	Result	%REC	Limits
Gasoline C7-C12	1,000	1,032	103	80-120

Surrogate	%REC	Limits
Bromofluorobenzene (FID)	101	77-128

## Batch QC Report

**Curtis & Tompkins Laboratories Analytical Report**

Lab #:	256900	Location:	15101 Freedom Ave. San Leandro
Client:	SOMA Environmental Engineering Inc.	Prep:	EPA 5030B
Project#:	2553	Analysis:	EPA 8015B
Field ID:	EFFLUENT	Batch#:	211213
MSS Lab ID:	256900-001	Sampled:	05/15/14
Matrix:	Water	Received:	05/16/14
Units:	ug/L	Analyzed:	05/18/14
Diln Fac:	1.000		

Type: MS Lab ID: QC740832

Analyte	MSS Result	Spiked	Result	%REC	Limits
Gasoline C7-C12	12.87	2,000	2,146	107	74-120

Surrogate	%REC	Limits
Bromofluorobenzene (FID)	119	77-128

Type: MSD Lab ID: QC740833

Analyte	Spiked	Result	%REC	Limits	RPD	Lim
Gasoline C7-C12	2,000	2,160	107	74-120	1	27

Surrogate	%REC	Limits
Bromofluorobenzene (FID)	120	77-128

RPD= Relative Percent Difference



<b>Total Extractable Hydrocarbons</b>			
Lab #:	256900	Location:	15101 Freedom Ave. San Leandro
Client:	SOMA Environmental Engineering Inc.	Prep:	EPA 3520C
Project#:	2553	Analysis:	EPA 8015B
Field ID:	EFFLUENT	Sampled:	05/15/14
Matrix:	Water	Received:	05/16/14
Units:	ug/L	Prepared:	05/19/14
Diln Fac:	1.000	Analyzed:	05/20/14
Batch#:	211252		

Type: SAMPLE Lab ID: 256900-001

Analyte	Result	RL
Diesel C10-C24	ND	49
Motor Oil C24-C36	ND	290

Surrogate	%REC	Limits
o-Terphenyl	97	66-129

Type: BLANK Lab ID: QC740992

Analyte	Result	RL
Diesel C10-C24	ND	50
Motor Oil C24-C36	ND	300

Surrogate	%REC	Limits
o-Terphenyl	100	66-129

ND= Not Detected  
 RL= Reporting Limit

## Batch QC Report

Total Extractable Hydrocarbons			
Lab #:	256900	Location:	15101 Freedom Ave. San Leandro
Client:	SOMA Environmental Engineering Inc.	Prep:	EPA 3520C
Project#:	2553	Analysis:	EPA 8015B
Matrix:	Water	Batch#:	211252
Units:	ug/L	Prepared:	05/19/14
Diln Fac:	1.000	Analyzed:	05/20/14

Type: BS Lab ID: QC740993

Analyte	Spiked	Result	%REC	Limits
Diesel C10-C24	2,500	2,059	82	61-120

Surrogate	%REC	Limits
o-Terphenyl	105	66-129

Type: BSD Lab ID: QC740994

Analyte	Spiked	Result	%REC	Limits	RPD	Lim
Diesel C10-C24	2,500	2,142	86	61-120	4	45

Surrogate	%REC	Limits
o-Terphenyl	105	66-129

RPD= Relative Percent Difference



Curtis & Tompkins, Ltd., Analytical Laboratories, Since 1878

2323 Fifth Street, Berkeley, CA 94710, Phone (510) 486-0900

**Laboratory Job Number 258139  
ANALYTICAL REPORT**

SOMA Environmental Engineering Inc.  
6620 Owens Dr.  
Pleasanton, CA 94588

Project : 2553  
Location : 15101 Freedom Ave. San Leandro  
Level : II

Sample ID  
EFFLUENT

Lab ID  
258139-001

This data package has been reviewed for technical correctness and completeness. Release of this data has been authorized by the Laboratory Manager or the Manager's designee, as verified by the following signature. The results contained in this report meet all requirements of NELAC and pertain only to those samples which were submitted for analysis. This report may be reproduced only in its entirety.

Signature: \_\_\_\_\_

Tracy Babjar  
Project Manager  
tracy.babjar@ctberk.com  
(510) 204-2226

Date: 06/23/2014

CA ELAP# 2896, NELAP# 4044-001

### CASE NARRATIVE

Laboratory number: 258139  
Client: SOMA Environmental Engineering Inc.  
Project: 2553  
Location: 15101 Freedom Ave. San Leandro  
Request Date: 06/17/14  
Samples Received: 06/17/14

This data package contains sample and QC results for one water sample, requested for the above referenced project on 06/17/14. The sample was received cold and intact.

**TPH-Purgeables and/or BTXE by GC (EPA 8015B and EPA 8021B):**

No analytical problems were encountered.

**TPH-Extractables by GC (EPA 8015B):**

Low recoveries were observed for diesel C10-C24 in the MS/MSD for batch 212398; the parent sample was not a project sample, the LCS was within limits, and the associated RPD was within limits. No other analytical problems were encountered.

# CHAIN OF CUSTODY

**Curtis & Tompkins, Ltd**  
 Analytical Laboratory Since 1878  
 2323 Fifth Street  
 Berkeley, CA 94710  
 (510)486-0900 Phone  
 (510)486-0532 Fax

LOGIN # 258139

Sampler: Davoud Bazrpash

## Analyses

Project No: 2553

Report To: Joyce Bobek

Project Name: 15101 Freedom Ave, San Leandr Company: SOMA Environmental

Turnaround Time: Standard

Telephone: 925-734-6400

Fax: 925-734-6401

Lab No.	Sample ID.	Sampling Date Time	Matrix				Preservative				TPH-g 8015	BTEX 8020	TPH-d, TPH-mo 8015							
			Soil	Water	Waste		HCL	H <sub>2</sub> SO <sub>4</sub>	HNO <sub>3</sub>	ICE										
1	Effluent	6/17/14 9:40	*				6 VOAs	*				*								
			*				2-500 mL Ambers					*								

Notes: **EDF OUTPUT REQUIRED**

RELINQUISHED BY:		RECEIVED BY:	
6/17/14	11:00	<u>[Signature]</u>	6/17/14 11:00
D.B	<u>[Signature]</u>		

COOLER RECEIPT CHECKLIST



Curtis & Tompkins, Ltd.

Login # 258139 Date Received 6/17/14 Number of coolers 0
Client SOMA Project 2553

Date Opened 6/17/14 By (print) MT (sign) [Signature]
Date Logged in [Signature] By (print) [Signature] (sign) [Signature]

1. Did cooler come with a shipping slip (airbill, etc) YES NO
Shipping info

2A. Were custody seals present? ... YES (circle) on cooler on samples NO
How many Name Date

2B. Were custody seals intact upon arrival? YES NO N/A

3. Were custody papers dry and intact when received? YES NO

4. Were custody papers filled out properly (ink, signed, etc)? YES NO

5. Is the project identifiable from custody papers? (If so fill out top of form) YES NO

6. Indicate the packing in cooler: (if other, describe)

- Bubble Wrap, Foam blocks, Bags, None, Cloth material, Cardboard, Styrofoam, Paper towels

7. Temperature documentation: \* Notify PM if temperature exceeds 6°C

Type of ice used: Wet, Blue/Gel, None Temp(°C)

Samples received on ice & cold without a temperature blank; temp taken with IR gun

Samples received on ice directly from the field. Cooling process had begun

8. Were Method 5035 sampling containers present? YES NO
If YES, what time were they transferred to freezer?

9. Did all bottles arrive unbroken/unopened? YES NO

10. Are there any missing / extra samples? YES NO

11. Are samples in the appropriate containers for indicated tests? YES NO

12. Are sample labels present, in good condition and complete? YES NO

13. Do the sample labels agree with custody papers? YES NO

14. Was sufficient amount of sample sent for tests requested? YES NO

15. Are the samples appropriately preserved? YES NO N/A

16. Did you check preservatives for all bottles for each sample? YES NO N/A

17. Did you document your preservative check? YES NO N/A

18. Did you change the hold time in LIMS for unpreserved VOAs? YES NO N/A

19. Did you change the hold time in LIMS for preserved terracores? YES NO N/A

20. Are bubbles > 6mm absent in VOA samples? YES NO N/A

21. Was the client contacted concerning this sample delivery? YES NO
If YES, Who was called? By Date:

COMMENTS

Blank lines for handwritten comments.

Detections Summary for 258139

Client : SOMA Environmental Engineering Inc.  
Project : 2553  
Location : 15101 Freedom Ave. San Leandro

Client Sample ID : EFFLUENT                      Laboratory Sample ID :                      258139-001

No Detections

**Curtis & Tompkins Laboratories Analytical Report**

Lab #:	258139	Location:	15101 Freedom Ave. San Leandro
Client:	SOMA Environmental Engineering Inc.	Prep:	EPA 5030B
Project#:	2553		
Field ID:	EFFLUENT	Batch#:	212349
Matrix:	Water	Sampled:	06/17/14
Units:	ug/L	Received:	06/17/14
Diln Fac:	1.000	Analyzed:	06/18/14

Type: SAMPLE                      Lab ID: 258139-001

Analyte	Result	RL	Analysis
Gasoline C7-C12	ND	50	EPA 8015B
Benzene	ND	0.50	EPA 8021B
Toluene	ND	0.50	EPA 8021B
Ethylbenzene	ND	0.50	EPA 8021B
m,p-Xylenes	ND	0.50	EPA 8021B
o-Xylene	ND	0.50	EPA 8021B

Surrogate	%REC	Limits	Analysis
Bromofluorobenzene (FID)	119	77-128	EPA 8015B
Bromofluorobenzene (PID)	114	75-132	EPA 8021B

Type: BLANK                      Lab ID: QC745501

Analyte	Result	RL	Analysis
Gasoline C7-C12	ND	50	EPA 8015B
Benzene	ND	0.50	EPA 8021B
Toluene	ND	0.50	EPA 8021B
Ethylbenzene	ND	0.50	EPA 8021B
m,p-Xylenes	ND	0.50	EPA 8021B
o-Xylene	ND	0.50	EPA 8021B

Surrogate	%REC	Limits	Analysis
Bromofluorobenzene (FID)	104	77-128	EPA 8015B
Bromofluorobenzene (PID)	101	75-132	EPA 8021B

ND= Not Detected  
 RL= Reporting Limit



## Batch QC Report

**Curtis & Tompkins Laboratories Analytical Report**

Lab #:	258139	Location:	15101 Freedom Ave. San Leandro
Client:	SOMA Environmental Engineering Inc.	Prep:	EPA 5030B
Project#:	2553	Analysis:	EPA 8021B
Matrix:	Water	Batch#:	212349
Units:	ug/L	Analyzed:	06/18/14
Diln Fac:	1.000		

Type: BS Lab ID: QC745498

Analyte	Spiked	Result	%REC	Limits
Benzene	10.00	8.743	87	80-120
Toluene	10.00	9.204	92	80-120
Ethylbenzene	10.00	9.003	90	80-120
m,p-Xylenes	10.00	10.74	107	80-120
o-Xylene	10.00	9.094	91	80-120

Surrogate	%REC	Limits
Bromofluorobenzene (PID)	107	75-132

Type: BSD Lab ID: QC745499

Analyte	Spiked	Result	%REC	Limits	RPD	Lim
Benzene	10.00	8.770	88	80-120	0	20
Toluene	10.00	9.164	92	80-120	0	20
Ethylbenzene	10.00	9.219	92	80-120	2	20
m,p-Xylenes	10.00	10.73	107	80-120	0	20
o-Xylene	10.00	9.099	91	80-120	0	20

Surrogate	%REC	Limits
Bromofluorobenzene (PID)	109	75-132

RPD= Relative Percent Difference

## Batch QC Report

**Curtis & Tompkins Laboratories Analytical Report**

Lab #:	258139	Location:	15101 Freedom Ave. San Leandro	
Client:	SOMA Environmental Engineering Inc.	Prep:	EPA 5030B	
Project#:	2553	Analysis:	EPA 8015B	
Type:	LCS	Diln Fac:	1.000	
Lab ID:	QC745500	Batch#:	212349	
Matrix:	Water	Analyzed:	06/18/14	
Units:	ug/L			

Analyte	Spiked	Result	%REC	Limits
Gasoline C7-C12	1,000	1,071	107	80-120

Surrogate	%REC	Limits
Bromofluorobenzene (FID)	104	77-128

Batch QC Report

**Curtis & Tompkins Laboratories Analytical Report**

Lab #:	258139	Location:	15101 Freedom Ave. San Leandro
Client:	SOMA Environmental Engineering Inc.	Prep:	EPA 5030B
Project#:	2553	Analysis:	EPA 8015B
Field ID:	ZZZZZZZZZZ	Batch#:	212349
MSS Lab ID:	258104-003	Sampled:	06/16/14
Matrix:	Water	Received:	06/16/14
Units:	ug/L	Analyzed:	06/19/14
Diln Fac:	1.000		

Type: MS Lab ID: QC745502

Analyte	MSS Result	Spiked	Result	%REC	Limits
Gasoline C7-C12	40.46	2,000	2,034	100	74-120

Surrogate	%REC	Limits
Bromofluorobenzene (FID)	117	77-128

Type: MSD Lab ID: QC745503

Analyte	Spiked	Result	%REC	Limits	RPD	Lim
Gasoline C7-C12	2,000	1,978	97	74-120	3	27

Surrogate	%REC	Limits
Bromofluorobenzene (FID)	107	77-128

RPD= Relative Percent Difference

### Total Extractable Hydrocarbons

Lab #: 258139	Location: 15101 Freedom Ave. San Leandro
Client: SOMA Environmental Engineering Inc.	Prep: EPA 3520C
Project#: 2553	Analysis: EPA 8015B
Field ID: EFFLUENT	Batch#: 212398
Matrix: Water	Sampled: 06/17/14
Units: ug/L	Received: 06/17/14
Diln Fac: 1.000	Prepared: 06/19/14

Type: SAMPLE Analyzed: 06/21/14  
 Lab ID: 258139-001

Analyte	Result	RL
Diesel C10-C24	ND	49
Motor Oil C24-C36	ND	290

Surrogate	%REC	Limits
o-Terphenyl	68	66-129

Type: BLANK Analyzed: 06/20/14  
 Lab ID: QC745700

Analyte	Result	RL
Diesel C10-C24	ND	50
Motor Oil C24-C36	ND	300

Surrogate	%REC	Limits
o-Terphenyl	67	66-129

ND= Not Detected  
 RL= Reporting Limit

## Batch QC Report

Total Extractable Hydrocarbons				
Lab #:	258139	Location:	15101 Freedom Ave. San Leandro	
Client:	SOMA Environmental Engineering Inc.	Prep:	EPA 3520C	
Project#:	2553	Analysis:	EPA 8015B	
Type:	LCS	Diln Fac:	1.000	
Lab ID:	QC745701	Batch#:	212398	
Matrix:	Water	Prepared:	06/19/14	
Units:	ug/L	Analyzed:	06/20/14	

Analyte	Spiked	Result	%REC	Limits
Diesel C10-C24	2,500	1,533	61	61-120

Surrogate	%REC	Limits
o-Terphenyl	86	66-129

## Batch QC Report

Total Extractable Hydrocarbons			
Lab #:	258139	Location:	15101 Freedom Ave. San Leandro
Client:	SOMA Environmental Engineering Inc.	Prep:	EPA 3520C
Project#:	2553	Analysis:	EPA 8015B
Field ID:	ZZZZZZZZZZ	Batch#:	212398
MSS Lab ID:	258191-001	Sampled:	06/18/14
Matrix:	Water	Received:	06/18/14
Units:	ug/L	Prepared:	06/19/14
Diln Fac:	1.000	Analyzed:	06/21/14

Type: MS Lab ID: QC745702

Analyte	MSS Result	Spiked	Result	%REC	Limits
Diesel C10-C24	24.16	2,451	1,476	59 *	65-120

Surrogate	%REC	Limits
o-Terphenyl	74	66-129

Type: MSD Lab ID: QC745703

Analyte	Spiked	Result	%REC	Limits	RPD	Lim
Diesel C10-C24	2,451	1,503	60 *	65-120	2	26

Surrogate	%REC	Limits
o-Terphenyl	81	66-129

\*= Value outside of QC limits; see narrative  
 RPD= Relative Percent Difference