

# ***Request for No Further Action***

---

Former Lemoine Sausage Factory  
630 29<sup>th</sup> Avenue  
Oakland, California

July 20, 2006  
33104-004578.00

Prepared for  
**ALAMEDA COUNTY  
ENVIRONMENTAL HEALTH**  
1131 Harbor Bay Parkway, Suite 250  
Alameda, California 94502-6577



For the benefit of business and people

**Clayton Group Services, Inc.**  
*A Bureau Veritas Company*  
6920 Koll Center Parkway  
Pleasanton, California 94566  
925.426.2600  
[www.us.bureauveritas.com](http://www.us.bureauveritas.com)



July 20, 2006

Mr. Don Hwang  
Hazardous Materials Specialist  
ALAMEDA COUNTY ENVIRONMENTAL HEALTH  
1131 Harbor Bay Parkway, Suite 250  
Alameda, California 94502-6577

Clayton Project No. 33104-004578.00

**Subject: Request for No Further Action  
Former Lemoine Sausage Factory  
630 29<sup>th</sup> Avenue  
Oakland, California**

Dear Mr. Hwang:

This letter serves as our request for No Further Action (NFA) status to be issued for the Former Lemoine Sausage Factory, located at 630 29<sup>th</sup> Avenue, in Oakland, California. Clayton Group Services, Inc. (Clayton), a *Bureau Veritas* company, makes this request on the basis of extensive site-specific investigative data, as well as on the basis of recent pilot study results for a potential remedial measure.

Numerous investigations and quarterly monitoring events have been performed over the past eight years at the subject property. Descriptions of the site background and the work performed to date, as well as Clayton's justification and rationale for the NFA request for the subject property, are provided in the following sections of this letter.

## **SITE BACKGROUND**

### **Site Description**

The subject property is located at the southeast corner of the intersection of 29<sup>th</sup> Avenue and East 7<sup>th</sup> Street, in an area primarily zoned light industrial and commercial. The location of the subject property is shown on Figure 1. The property is surrounded by light industrial and commercial facilities to the north and south, the 29<sup>th</sup> Avenue overpass to the west, and a light industrial/commercial facility and residences to the east. An unpaved, undeveloped lot containing automobile wreckage, miscellaneous equipment, and scrap metal materials is located to the west of the property. A steel fabrication shop is located further west of the undeveloped lot. According to historic maps, machine shops were formerly located in the adjacent undeveloped lot. An automotive repair



Mr. Don Hwang  
Alameda County Environmental Health  
July 20, 2006

Page 3  
Clayton Project No. 33104-004578.00

facility was formerly located to the south. Residential areas also are located further south and east of the adjacent commercial properties.

The property is occupied by an approximately 9,262-square foot, L-shaped building formerly used as a sausage factory and cold storage warehouse. The building is a one-story, wood-framed, stucco exterior structure with concrete flooring and a wooden roof. The concrete floor is approximately 3.5 feet above street grade within the western and central portions of the building and lies at ground level within the eastern portion of the building. During earlier operations, the interior of the building was divided into a sausage production area, a cold storage area, an office area, a refrigeration machinery room, and an employee locker room. Additional refrigeration equipment was formerly present on the roof of the building, as noted during previous investigations. The building is currently subdivided into three tenant spaces. The eastern portion is occupied by an automobile repair and hobby shop. The central portion is occupied by an architectural design and fabrication facility. The western portion is occupied by art fabricator.

### **UST Removal**

A 1,000-gallon gasoline underground storage tank (UST) and associated piping were formerly located beneath the sidewalk along 7<sup>th</sup> Street adjacent to the northeast side of the building. The UST was located near the roll-up door on the building. The fuel dispenser for the UST was located in a “cubby hole” adjacent to the building’s roll-up door. The locations of the former UST and appurtenant features are shown on Figure 2.

In November 1996, the UST and associated piping were removed. During the UST removal, a petroleum hydrocarbon sheen was observed in groundwater that entered into the excavation for the UST removal. Groundwater was encountered at a depth of 5 feet below ground surface (bgs) during excavation activities. Seven (7) soil samples (S-1 through S-7) were obtained during the UST removal under the direction of Alameda County Department of Environmental Health Services (ACDEHS). The samples were collected at depths between 5 and 8 feet bgs beneath the fill ends of the UST and the dispenser. The samples were analyzed for total petroleum hydrocarbons as gasoline (TPH-g), methyl tertiary butyl ether (MTBE), benzene, toluene, ethylbenzene, and xylenes (BTEX), and organic lead. Analytical results showed concentrations of these constituents ranging between non-detection and 4,300 milligrams per kilogram (mg/kg).

### **Previous Investigations**

Since 1997, several investigations and quarterly groundwater monitoring events have been performed at the site to characterize soil quality and monitor groundwater conditions and quality. Ten (10) soil borings (B-1 through B-10) were drilled to assess



Mr. Don Hwang  
Alameda County Environmental Health  
July 20, 2006

Page 4  
Clayton Project No. 33104-004578.00

soil and groundwater quality around the vicinity of the former UST excavation and beneath the building footprint. Thirteen (13) groundwater monitoring wells (MW-1 through MW-13) were installed within the uppermost water-bearing zone to characterize groundwater conditions and to delineate the extent of impacted groundwater in on-site and off-site areas. Boring and monitoring well locations are shown on Figure 2. Soil analytical results from the soil sampling points during the UST removal and soil borings during previous investigations are shown on Figure 3.

Quarterly groundwater monitoring was initiated at the site in 1999. Groundwater flow is generally to the west-southwest. Groundwater elevations noted during the Second Quarter of 2006 are presented on Figure 4. Historical groundwater elevations are presented in Appendix A.

During previous investigations, TPH- and benzene-impacted soils and groundwater were detected in soil borings and grab groundwater samples, as well as in on-site and off-site wells during quarterly monitoring events. Historical analytical data has shown that TPH- and benzene-impacted groundwater covers a portion of the site and extends into off-site areas. Analytical results from the most recent (Second Quarter 2006) monitoring event show that the highest concentrations of TPH-g and benzene are present in Well MW-1, located within the East 7<sup>th</sup> Street right of way, and in Wells MW-2 and MW-9, located within the eastern portion of the existing building. The mass of impacted soils is present beneath the existing building footprint. TPH-g and benzene concentrations detected in groundwater during Second Quarter 2006 are shown on Figures 5 and 6, respectively. Historical groundwater analytical results are presented in Appendix B.

Volatile organic compounds (VOCs), primarily trichloroethene (TCE), cis-1,2-dichloroethene (cis-1,2-DCE), trans-1,2-DCE, and vinyl chloride (VC), also have been detected in three (3) of the monitoring wells (MW-8, MW-12, and MW-13) during previous quarterly monitoring events. VOC concentrations detected at these wells over the past several monitoring events have not fluctuated and show that the VOC plume is stable in size and configuration. Concentrations of cis-1,2-DCE, trans-1,2-DCE, and vinyl chloride historically have been detected at higher concentrations than the TCE concentrations over the past several monitoring events, thus showing that the VOCs have undergone significant degradation. In consideration of the known groundwater flow conditions, historical site activities, and location of impacted groundwater, the VOCs are likely attributable to an off-site source that is not associated with the UST release. Well MW-8 appears to be crossgradient of this off-site source. Wells MW-12 and MW-13 are downgradient of the off-site source. TCE and cis-1,2-DCE concentrations detected in groundwater during Second Quarter 2006 are shown on Figure 7.



Mr. Don Hwang  
Alameda County Environmental Health  
July 20, 2006

Page 5  
Clayton Project No. 33104-004578.00

## **SUBSURFACE CONDITIONS**

Previous investigation results show that the site is underlain by fine-grained soils containing occasional layers of coarse-grained soils. The uppermost soils beneath the building footprint consist of sandy clay and clayey silt that extend to depths between 4 and 7 feet bgs. Green-colored staining and hydrocarbon odors were encountered within these units at a depth of about 6 feet bgs. The coarse grained soils consist of sands, silty sands, and clayey sands that are discontinuous in extent. The sands are present at depths between 4 and 7 feet bgs and have thicknesses ranging between 2 and 5.5 feet. The sands are underlain by stiff silty clay and clayey silt units, which extend to the termination depth in most borings drilled during previous investigations. Exceptions to this included the borings drilled for Wells MW-7 and MW-13. Clayey sand was encountered at 14 feet bgs in Boring MW-13 and silty gravel was encountered at 18.5 feet bgs in Boring MW-7. No separate phase hydrocarbon product was encountered in any of the borings during previous investigation activities.

In some of the borings drilled along East 7<sup>th</sup> Street, including Borings B-9, B-10, and MW-1, fill soils were encountered. The fill soils represent backfill materials for a trench containing the sanitary sewer line that extends beneath East 7<sup>th</sup> Street. The fill consists of sandy clay with gravel and extends to approximately 8 feet bgs. The sandy clay is underlain by an approximately one-foot thick layer of saturated sand, which occurs between 8 and 9 feet bgs and appears to cover the sanitary sewer line beneath East 7<sup>th</sup> Street.

Quarterly groundwater monitoring events have shown that the depth to groundwater has varied between approximately 6 and 9 feet bgs. Because of the fine-grained nature of the soil beneath the site, the soils generally exhibit low permeability. Slow recharge was noted in the borings during previous investigations, especially, while attempting to obtain grab groundwater samples. Monitoring wells also have exhibited slow recharge characteristics, where monitoring wells have been bailed dry upon removal of a few well casing volumes of water.

The thickness of unsaturated vadose zone soils (clayey silt and sandy clay soils) beneath the site is also limited due to the presence of shallow groundwater. Because of the fluctuating groundwater levels, a hydrocarbon "smear zone" appears to be present at depths between approximately 5 and 9 feet bgs. The highest concentrations of TPH-impacted soils appear to be present at an approximate depth of 6 feet bgs.



Mr. Don Hwang  
Alameda County Environmental Health  
July 20, 2006

Page 6  
Clayton Project No. 33104-004578.00

## **RISK ASSESSMENT/FEASIBILITY STUDY (RA/FS)**

In 2001, Clayton performed a risk assessment and feasibility study (RA/FS) to determine site-specific cleanup goals and evaluate potential remedial measures. The risk assessment was performed in accordance with the California Code of Regulations Title 22 Division 21 (Title 22), American Society for Testing and Materials (ASTM-E1735) Standard Guide for Risk Based Corrective Action (RBCA) Applied at Petroleum Release Sites (ASTM, 1995), and the Oakland Urban Land Redevelopment Program (OULRP) Guidance Document (COPWA, 2000), as well as in accordance with the City of Oakland's document entitled "Oakland Risk-Based Corrective Action: Technical Background Document" updated January 1, 2000. The risk-based corrective action process is a three-tiered method where the potential risk is estimated based on a set of governing mathematical equations. The risk assessment for the site was performed at the Tier II level and followed ASTM guidelines, which included the identification of chemicals of concern, primary sources, secondary sources, transport mechanisms and chemical exposure pathways to potential receptors, as well as receptor characterization and survey, risk evaluation, and decision analysis-remedial action options.

As part of the receptor survey, a well search was performed within a 2,000-foot radius of the site. Nearby underground utilities also were identified as potential conduits for the transport of impacted groundwater. The results of the survey showed that no domestic drinking water wells exist within the 2,000-foot radius of the site. It was concluded that there is no risk of exposure from groundwater consumption within 2,000 feet downgradient of the site. With respect to underground utilities, Well MW-7, which is located along the south side of East 29<sup>th</sup> Avenue adjacent to a storm drain utility trench, also has shown non-detect concentrations of petroleum hydrocarbons and VOCs over the past several quarters. Analytical results therefore indicated that groundwater impact to the storm drain utility trench was unlikely. The canal between the Oakland and Alameda city limits, which is over a ½ mile away to the south, also was considered a point of exposure for the RA/FS assuming groundwater was able to enter the canal through natural pathways or via leakage from utility trenches. The main risk to human health was the ingestion of fish that live in the canal, which was entered into the risk assessment as a surface water receptor. It was concluded that the recreational use of the canal could not be considered as a viable pathway of exposure due to the canal's use as an active marine thoroughfare.

In summary, the results of the risk assessment showed there were no off-site receptors that will be impacted by the TPH and VOC constituents at the site. It was noted that health concerns may be encountered through the ingestion of groundwater from the site. With respect to the groundwater underlying the site, it is highly unlikely that it would ever be developed for beneficial uses, such as drinking water purposes. Groundwater



Mr. Don Hwang  
Alameda County Environmental Health  
July 20, 2006

Page 7  
Clayton Project No. 33104-004578.00

beneath the site would not be of beneficial use because of the site being located less than 300 feet from a known sanitary sewer system. In addition, groundwater beneath the site is of a brackish nature and could not be extracted at sufficient rates for consumption over a prolonged period of time.

Several potential remedial measures were evaluated during the feasibility study. These included soil treatment methods, groundwater remediation methods, and no action supplemented with groundwater monitoring. To date, groundwater monitoring has been performed on a quarterly basis at the site since 1999. Analytical results over the past several years demonstrate that chemical concentrations have decreased over time and plume stability has been maintained.

## **EVALUATION OF OTHER REMEDIAL ALTERNATIVES**

In 2004, other remedial action alternatives were evaluated for practical consideration, technical applicability, and costs. These remedial action alternatives were to address the removal of source areas(s) contributing to impacted soil and groundwater, to effectively control and intercept impacted groundwater as close to the source area(s) as possible, and to capture and treat soil vapor and impacted groundwater until future site-specific cleanup goals were met. Selected remedial action alternatives included Alternative 1 (building demolition, excavation/disposal, and building reconstruction), Alternative 2 (soil excavation, groundwater extraction via the installation of an interceptor trench with soil vapor extraction); and Alternative 3 (groundwater injection using an Oxygen Release Compound (ORC)). Each of these alternatives was evaluated with regard to implementability, effectiveness, and cost.

The results of this evaluation showed that each of the alternatives could be implemented with the exception of several restrictions that were not feasible. Such restrictions included the intrusiveness of each alternative relative to the building footprint and tenant occupancy, overall cost, and length of time to achieve a designated site-specific cleanup goal. Alternative 1 would be the most intrusive to implement at the site because it would entail building demolition, soil excavation/disposal, dewatering, site restoration, and building reconstruction. Existing tenants would have to move out of the building for a significant amount of time during remedial activities. Impacted soils would be removed and sent to an acceptable landfill. Clean soil from the upper 6 feet of the excavation, as well as a limited volume of imported soils, would be used to replace the impacted soil. Impacted groundwater would be removed during the dewatering process. Operations and maintenance activities would not be required. Quarterly groundwater monitoring would be performed for at least a one-year period of time.



Mr. Don Hwang  
Alameda County Environmental Health  
July 20, 2006

Page 8  
Clayton Project No. 33104-004578.00

The cost of implementing Alternative 1 is much higher than those costs for Alternatives 2 and 3. Alternative 1 was considered the most likely approach to achieve cleanup goals. Because of the source area removal associated with Alternative 1, the duration of time to complete Alternative 1 would be significantly less than the time required for completing Alternatives 2 and 3. Alternative 2 also would require temporary relocation of the existing tenants as with Alternative 1, and would take longer to meet a cleanup objective since a more localized area of impacted soil would be removed. In addition, because of the dewatering task in Alternative 1 and groundwater extraction task in Alternative 2, it is likely that the VOC-impacted groundwater from the off-site source would be captured and brought on-site. For Alternative 2, it was also noted that soil vapor extraction would not be effective because of the preponderance of fine-grained, low permeability soils within the vadose zone. Overall, because of the intrusive nature, cost prohibition, time constraints, low permeability soil conditions, and capture of VOC-impacted groundwater from an off-site source associated with Alternatives 1 and 2, it was decided to conduct a pilot test for Alternative 3 (ORC injection).

### **ORC INJECTION PILOT STUDY**

In 2005, an ORC injection pilot study was performed at the site to evaluate its technical feasibility for reducing chemical concentrations in groundwater. The scope of work for implementing the study included the installation of two (2) temporary monitoring wells (T-1 and T-2) and drilling of ORC injection borings. As shown on Figure 8, the wells were positioned downgradient of Well MW-9 to evaluate the effects of ORC injection. The borings were positioned upgradient of Wells MW-9 and MW-4. In addition to the temporary wells (T-1 and T-2), Well MW-9 also was utilized for groundwater monitoring purposes during the study.

Upon completion of the injection process, temporary Wells T-1, T-2, and Well MW-9 were sampled during three events over a five-month period. Pilot study sampling rounds were interspersed with the quarterly groundwater monitoring schedule. During the earlier RA/FS, bio-assessment test data showed that groundwater beneath the site contained heterotrophic bacteria capable of degrading organic compounds. Specifically, test data showed that groundwater beneath the site was anaerobic (oxygen-poor) and lacked essential inorganic nutrients (nitrogen and phosphate). Numerous studies have shown that the lack of oxygen can limit the ability of naturally occurring microorganisms (aerobes) to degrade certain compounds. ORC injection was selected as a remedial alternative for pilot testing at this site based on the premise that if the oxygen, nitrogen, and phosphate compound concentrations could be increased, then these elements could potentially stimulate and increase bacteriological activity allowing for biodegradation of the petroleum hydrocarbons.





Mr. Don Hwang  
Alameda County Environmental Health  
July 20, 2006

Page 9  
Clayton Project No. 33104-004578.00

Pilot study test results showed that minimal aerobic biodegradation of petroleum hydrocarbons is occurring at the site. No significant declines in hydrocarbon concentrations in groundwater were noted during the study. Biodegradation was noted to occur at an extremely slow rate and would be ineffective for reducing chemical concentrations in a timely manner. ORC injection would have to be conducted over a much longer time interval at significant costs to achieve cleanup goals. Multiple ORC injection events also would have to be implemented in order for significant decreases in TPH concentrations to occur. None of the TPH-impacted source area would be removed during ORC injection. Furthermore, low permeability soils beneath the site also would limit the effectiveness of multiple ORC injection events and would likely necessitate re-applications over smaller areas should the quarterly monitoring analytical results continue to show minimal changes of concentrations over time. The length of time to meet site-specific cleanup goals is unknown, as would be the length of time for conducting quarterly monitoring. Therefore, it was recommended that this remedial alternative not be implemented at the site.

#### **RATIONALE FOR NO FURTHER ACTION (NFA)**

As discussed in the previous sections of this letter, numerous field activities and groundwater quarterly monitoring events have been performed at the site. Investigation and monitoring results over the past several years show that chemical concentrations have decreased with time. Historical groundwater analytical data show that the groundwater plume beneath the site has stabilized and not migrated further off-site. Historical groundwater analytical data, as well as the ORC injection pilot study test results, also show that the only option for site remediation would be Alternative 1. However, this alternative would be extremely cost-prohibitive because of the building demolition and reconstruction costs, as well as tenant relocation costs. In addition, remedial measures for Alternative 1 would likely enhance the migration of VOC-impacted groundwater from the off-site source area.

RA/FS results showed that no potential off-site receptors are present downgradient of the site. Low permeability conditions and the brackish nature of the groundwater beneath the site also show that it would not be developed for beneficial uses. Pilot test results also show that the site is not conducive for ORC injection, which originally was considered to be a practical and cost-effective remedial measure for the site. On the basis of the aforementioned information, no additional investigation or remedial action is further warranted at this site. Therefore, the case for this site should be closed.

On the basis of the information presented in this letter, Clayton requests that Alameda County Environmental Health issue a NFA letter for the site. In addition to the NFA letter, Clayton also requests that the existing on-site and off-site monitoring wells be



Mr. Don Hwang  
Alameda County Environmental Health  
July 20, 2006

Page 10  
Clayton Project No. 33104-004578.00

destroyed in accordance with applicable Alameda County Public Works Agency requirements as part of this site closure.

Clayton appreciates the opportunity to work with you and trusts that this information will meet your immediate needs for issuing the NFA letter at this time. If you have any questions or comments regarding this letter, please do not hesitate to contact me at (925) 426-2626 or at [timothy.bodkin@us.bureauveritas.com](mailto:timothy.bodkin@us.bureauveritas.com).

Sincerely,

Timothy G. Bodkin, C.E.G., R.E.A.  
Senior Project Manager  
Environmental Services

TGB/tgb

Enclosures



## **FIGURES**

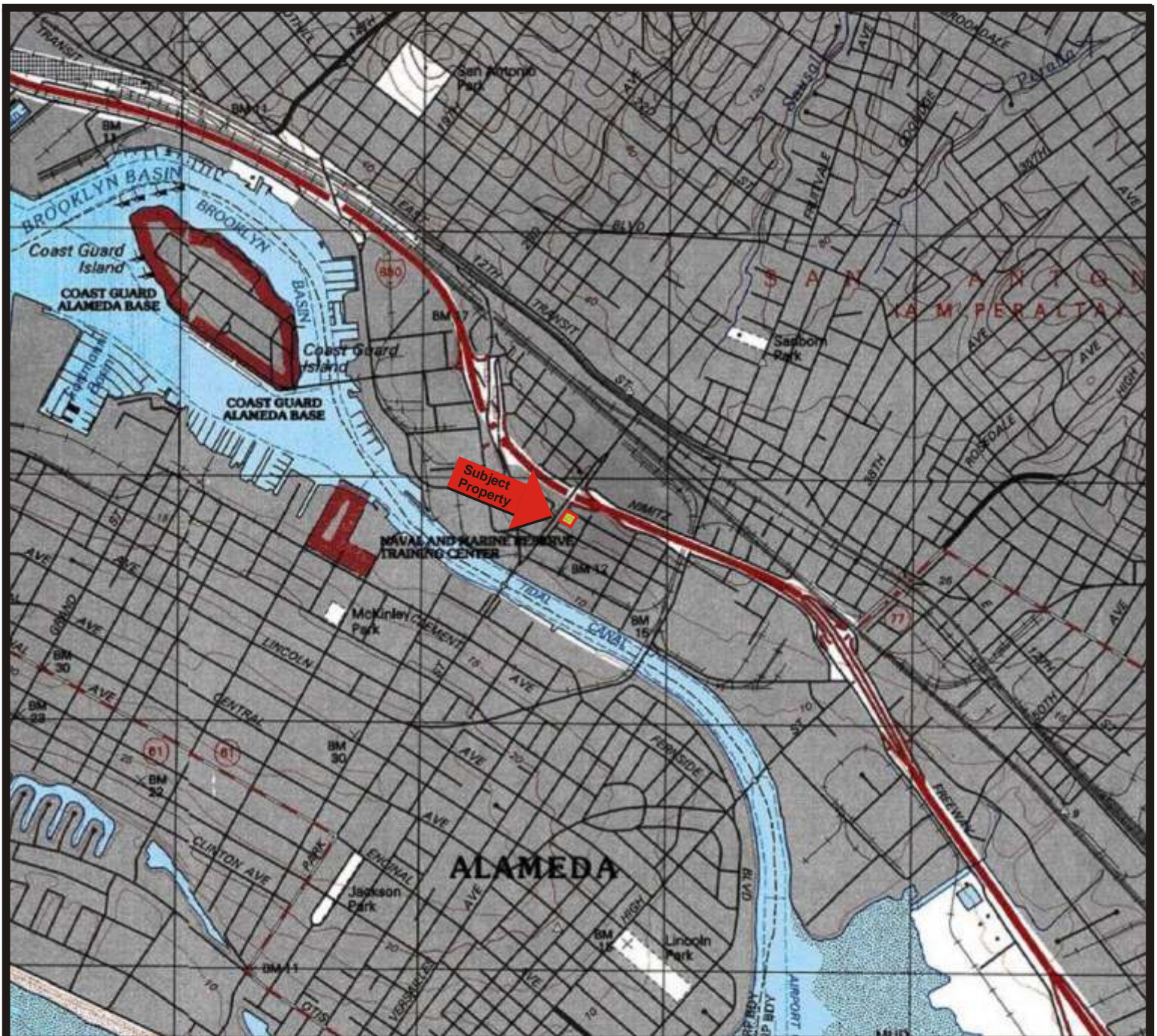

Map Source: TOPO!© 2000 National Geographic Holdings

Note: Boundaries and Location Information is Approximate

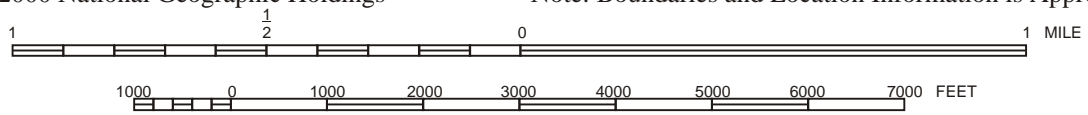

Portion of the 7.5-Minute Series Oakland East, California  
 Quadrangle Topographic Map (Datum: NAD 27)  
 United States Department of the Interior  
 Geological Survey  
 1997



QUADRANGLE LOCATION

PROPERTY LOCATION MAP  
 Former Lemoine Sausage Factory  
 630 29th Avenue  
 Oakland, California  
 Clayton Project No. 70-04578.00

Figure

1



29TH AVENUE

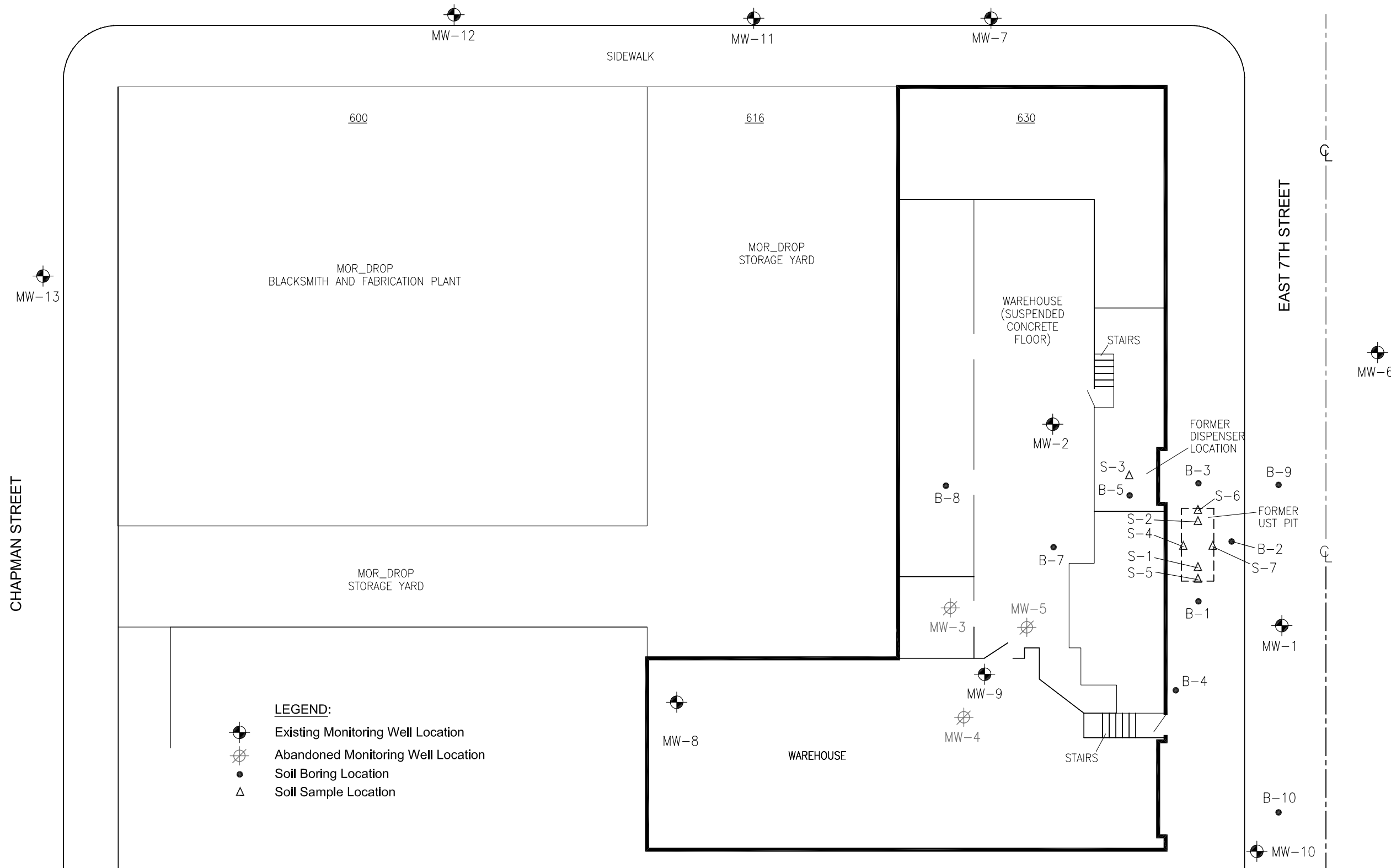

- LEGEND:**
- Existing Monitoring Well Location
  - Abandoned Monitoring Well Location
  - Soil Boring Location
  - Soil Sample Location



**SOIL BORING AND MONITORING WELL LOCATION MAP**  
 FORMER LEMOINE SAUSAGE FACTORY  
 630 29TH AVENUE  
 OAKLAND, CALIFORNIA  
 Clayton Project No. 70-04578.00

Figure

2

06/25/04  
SITE0604.DWG



29TH AVENUE

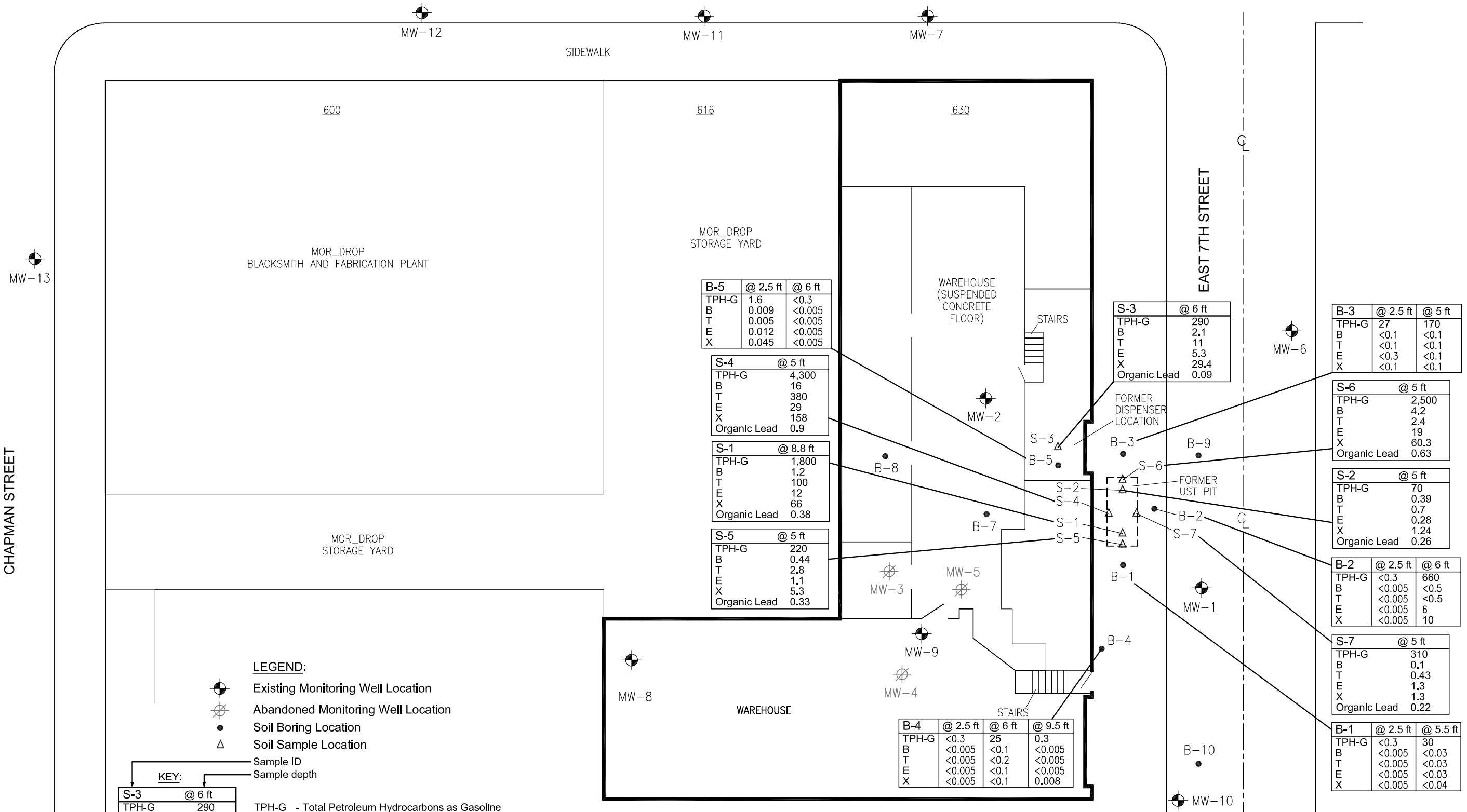

B-5	@ 2.5 ft	@ 6 ft
TPH-G	1.6	<0.3
B	0.009	<0.005
T	0.005	<0.005
E	0.012	<0.005
X	0.045	<0.005

S-4	@ 5 ft
TPH-G	4,300
B	16
T	380
E	29
X	158
Organic Lead	0.9

S-1	@ 8.8 ft
TPH-G	1,800
B	1.2
T	100
E	12
X	66
Organic Lead	0.38

S-5	@ 5 ft
TPH-G	220
B	0.44
T	2.8
E	1.1
X	5.3
Organic Lead	0.33

S-3	@ 6 ft
TPH-G	290
B	2.1
T	11
E	5.3
X	29.4
Organic Lead	0.09

B-3	@ 2.5 ft	@ 5 ft
TPH-G	27	170
B	<0.1	<0.1
T	<0.1	<0.1
E	<0.3	<0.1
X	<0.1	<0.1

S-6	@ 5 ft
TPH-G	2,500
B	4.2
T	2.4
E	19
X	60.3
Organic Lead	0.63

S-2	@ 5 ft
TPH-G	70
B	0.39
T	0.7
E	0.28
X	1.24
Organic Lead	0.26

B-2	@ 2.5 ft	@ 6 ft
TPH-G	<0.3	660
B	<0.005	<0.5
T	<0.005	<0.5
E	<0.005	6
X	<0.005	10

S-7	@ 5 ft
TPH-G	310
B	0.1
T	0.43
E	1.3
X	1.3
Organic Lead	0.22

B-4	@ 2.5 ft	@ 6 ft	@ 9.5 ft
TPH-G	<0.3	25	0.3
B	<0.005	<0.1	<0.005
T	<0.005	<0.2	<0.005
E	<0.005	<0.1	<0.005
X	<0.005	<0.1	0.008

B-1	@ 2.5 ft	@ 5.5 ft
TPH-G	<0.3	30
B	<0.005	<0.03
T	<0.005	<0.03
E	<0.005	<0.03
X	<0.005	<0.04

**LEGEND:**

- Existing Monitoring Well Location
- Abandoned Monitoring Well Location
- Soil Boring Location
- Soil Sample Location

- Sample ID
- Sample depth
- TPH-G - Total Petroleum Hydrocarbons as Gasoline
- B - Benzene
- T - Toluene
- E - Ethylbenzene
- X - Xylenes

**KEY:**

S-3	@ 6 ft
TPH-G	290
B	2.1
T	11
E	5.3
X	29.4
Organic Lead	0.09

Concentration, milligrams per kilogram (mg/kg)  
Analyte



**CHEMICAL CONCENTRATIONS IN SOIL**

FORMER LEMOINE SAUSAGE FACTORY  
630 29TH AVENUE  
OAKLAND, CALIFORNIA  
Clayton Project No. 70-04578.00

Figure

**3**

06/25/04  
SITE0604.DWG



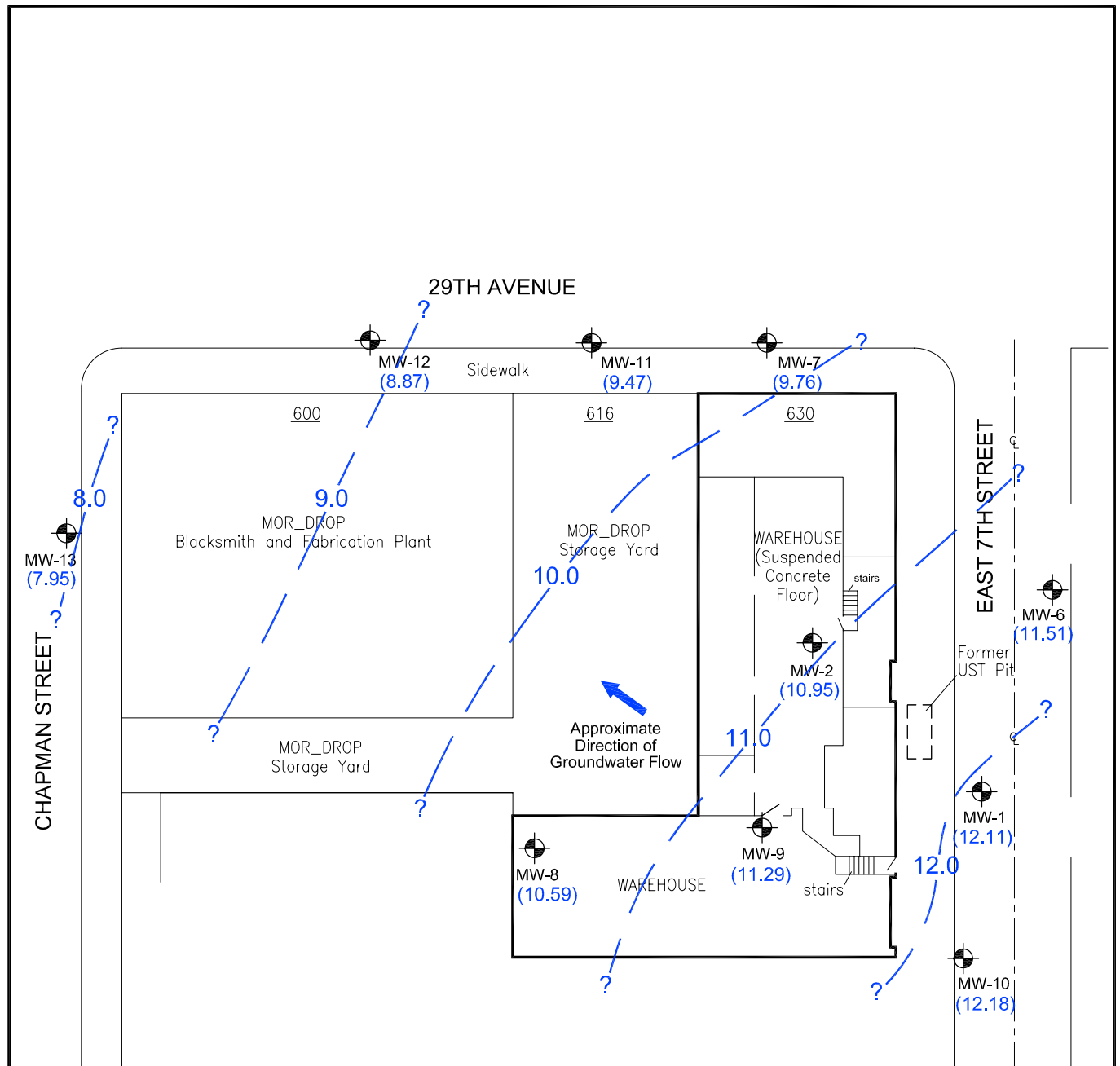

**LEGEND:**

MW-1 Existing Monitoring Well Location

(12.11) Groundwater Elevation (ft msl), 06/15/06

10- - - - Groundwater Surface Elevation Contour (ft msl)

ft msl Feet Above Mean Sea Level



**GROUNDWATER ELEVATION MAP,  
2ND QUARTER 2006**

FORMER LEMOINE SAUSAGE FACTORY  
630 29TH AVENUE  
OAKLAND, CALIFORNIA  
Clayton Project No. 33104-004578.00

Figure

**4**

06/29/06  
SITE0606.DWG



**BUREAU  
VERITAS**

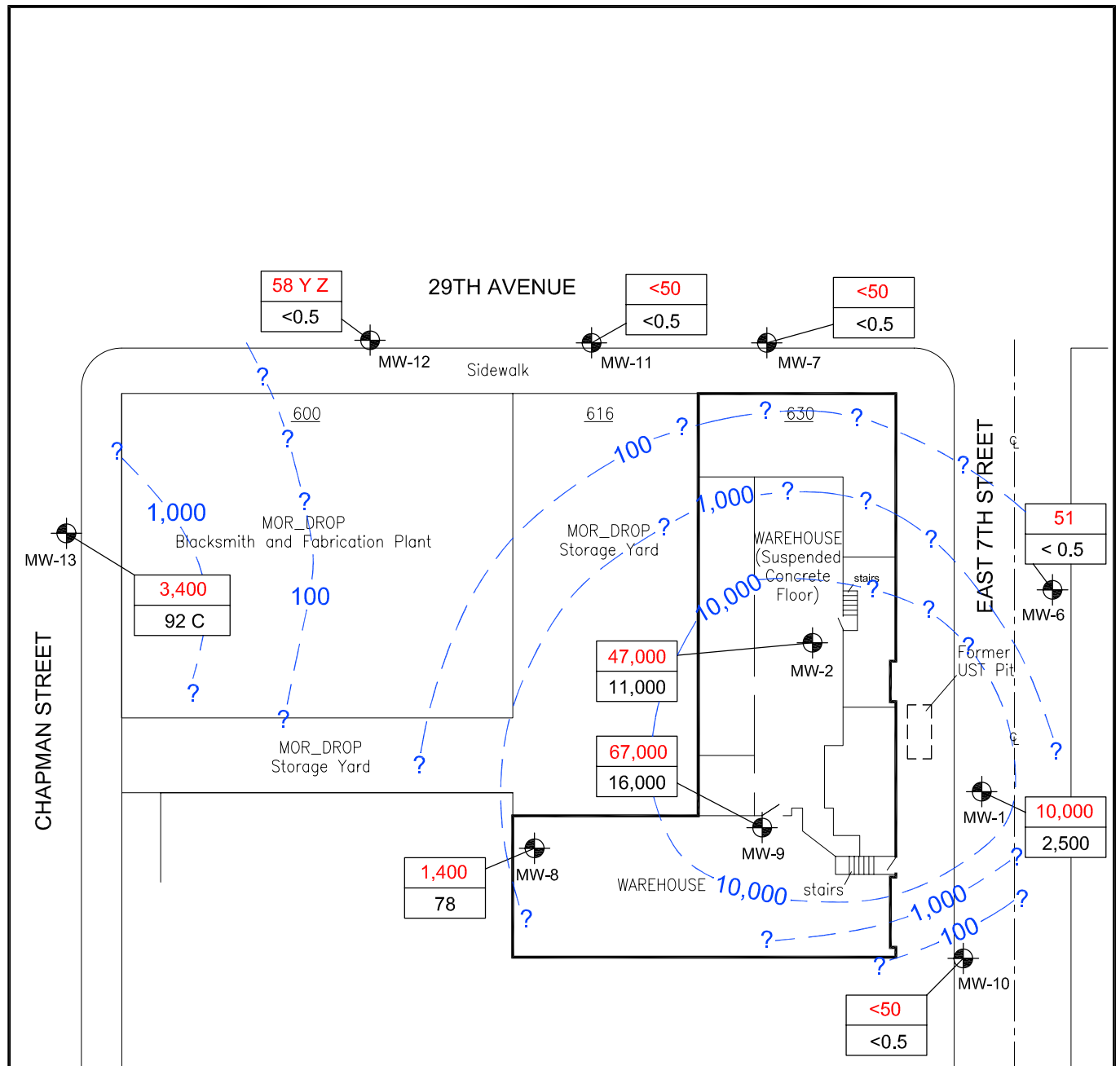

**LEGEND:**

MW-1 Existing Monitoring Well Location

TPH-g Concentration (ug/L), 06/15/06

Benzene Concentration (ug/L), 06/15/06

TPH-g Isoconcentration Contour (ug/L)

TPH-g Total Petroleum Hydrocarbons as Gasoline  
ug/L micrograms per liter

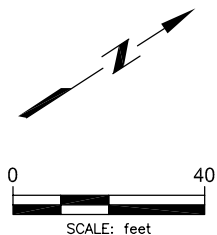

**TPH-g CONCENTRATIONS IN GROUNDWATER, 2ND QUARTER 2006**

FORMER LEMOINE SAUSAGE FACTORY  
630 29TH AVENUE  
OAKLAND, CALIFORNIA  
Clayton Project No. 33104-004578.00

Figure

**5**

06/29/06  
SITE0606.DWG



**BUREAU VERITAS**



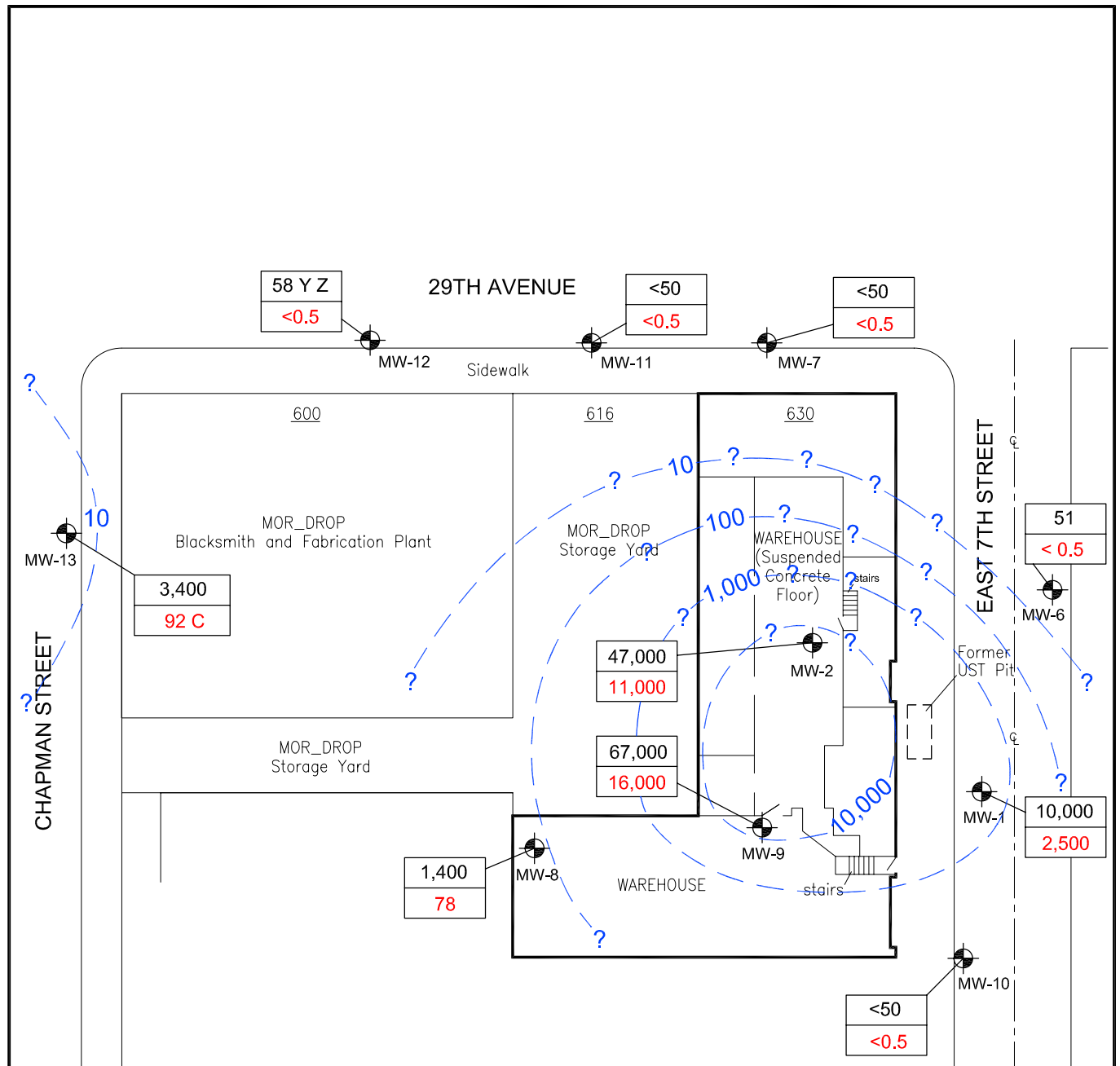

**LEGEND:**

- MW-1 Existing Monitoring Well Location
- |        |
|--------|
| 10,000 |
| 2,500  |

 TPH-g Concentration (ug/L), 06/15/06
- |        |
|--------|
| 10,000 |
| 2,500  |

 Benzene Concentration (ug/L), 06/15/06
- 10- Benzene Isoconcentration Contour (ug/L)
- TPH-g Total Petroleum Hydrocarbons as Gasoline  
ug/L micrograms per liter

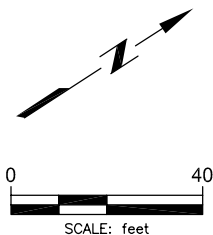

**BENZENE CONCENTRATIONS IN GROUNDWATER, 2ND QUARTER 2006**

FORMER LEMOINE SAUSAGE FACTORY  
630 29TH AVENUE  
OAKLAND, CALIFORNIA  
Clayton Project No. 33104-004578.00

Figure

**6**

06/29/06  
SITE0606.DWG



**BUREAU VERITAS**

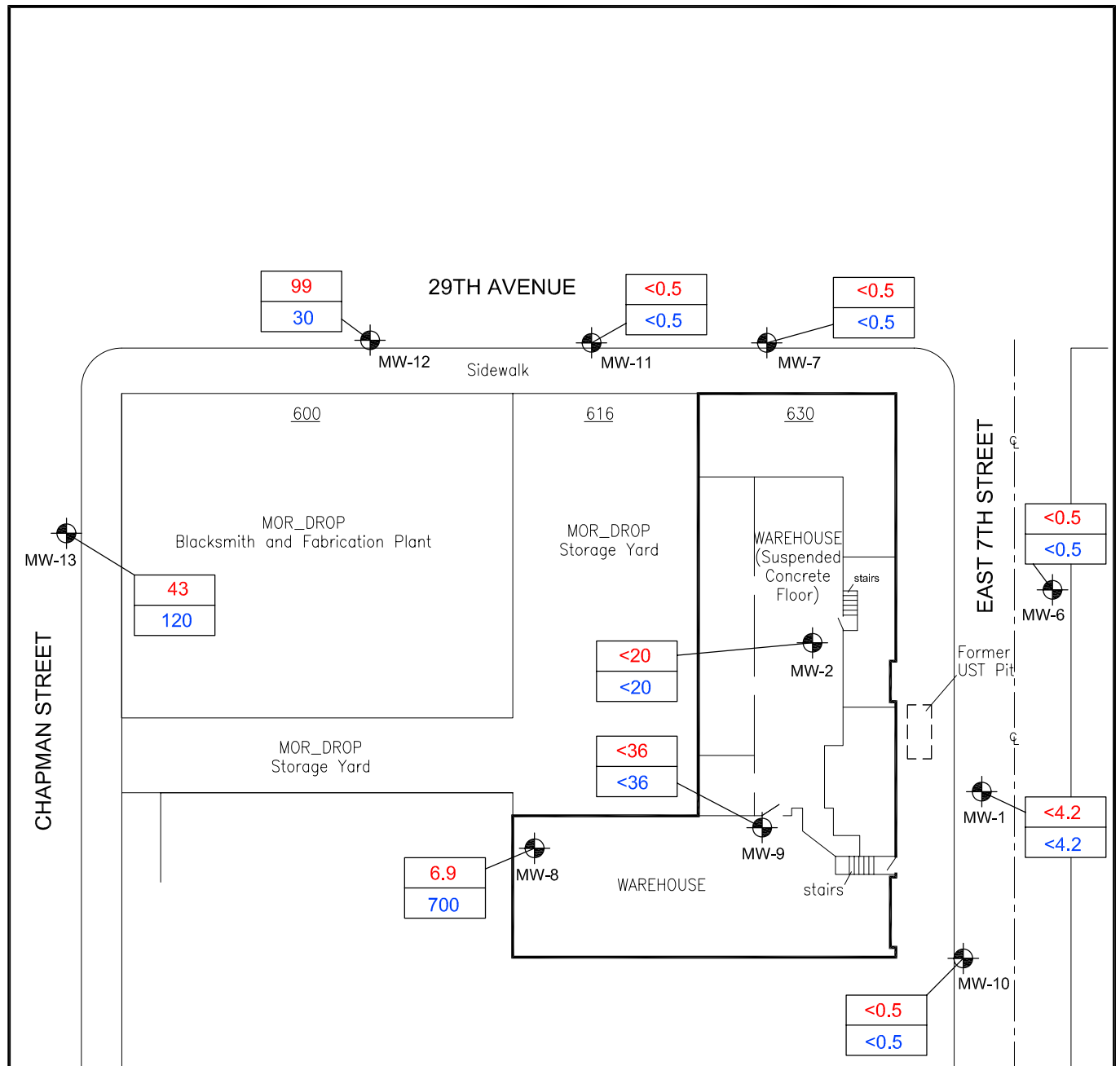

**LEGEND:**

MW-1 Existing Monitoring Well Location

TCE Concentration (ug/L), 06/15/06

cis-1,2-DCE Concentration (ug/L), 06/15/06

TCE Trichloroethene  
 cis 1,2-DCE cis 1,2-Dichloroethene  
 ug/L micrograms per liter

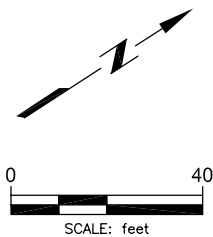

**TCE AND cis-1,2-DCE  
 CONCENTRATIONS IN GROUNDWATER,  
 2ND QUARTER 2006**  
 FORMER LEMOINE SAUSAGE FACTORY  
 630 29TH AVENUE  
 OAKLAND, CALIFORNIA  
 Clayton Project No. 33104-004578.00

Figure

**7**



06/29/06  
 SITE0606.DWG



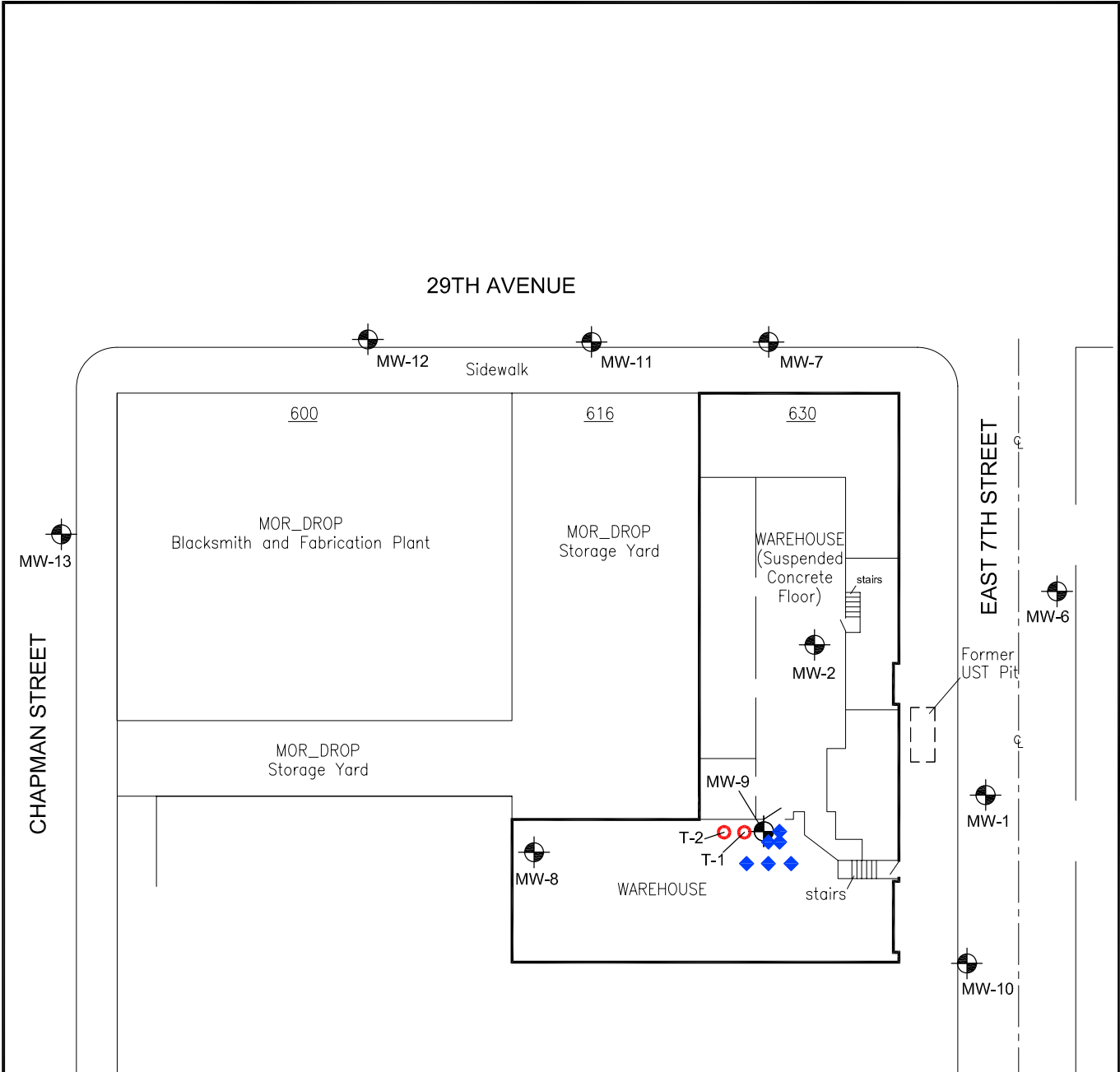

**BUREAU  
 VERITAS**

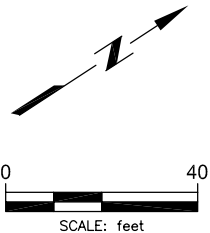

**LEGEND:**

-  Existing Monitoring Well Location
-  Temporary Well (Pilot Study)
-  ORC Injection Boring (Pilot Study)



<p><b>ORC INJECTION SITE PLAN FOR PILOT STUDY</b></p> <p>FORMER LEMOINE SAUSAGE FACTORY          630 29TH AVENUE          OAKLAND, CALIFORNIA          Clayton Project No. 70-04578.00</p>	<p>Figure <b>8</b></p> <p>02/22/06 SITE0206.DWG</p>	 <p><b>BUREAU VERITAS</b></p>
--	---	--



**APPENDIX A**  
**HISTORICAL GROUNDWATER ELEVATION DATA**



APPENDIX A

HISTORICAL GROUNDWATER ELEVATION DATA  
 FORMER LEMOINE SAUSAGE FACTORY  
 630 29TH AVENUE  
 OAKLAND, CALIFORNIA

Well Identification	Date Measured	Top of Casing Elevation (ft,msl)	Depth to Water (feet)	Groundwater Elevation (ft,msl)
MW-1	2/8/1999	16.69	3.60	13.09
	6/15/2000	16.69	4.82	11.87
	9/22/2000	16.69	6.30	10.39
	12/19/2000	16.69	5.50	11.19
	3/21/2001	16.69	4.29	12.40
	6/20/2001	16.69	5.85	10.84
	9/25/2001	16.69	6.76	9.93
	12/3/2001	16.69	4.17	12.52
	3/25/2002	16.69	2.77	13.92
	6/28/2002	16.69	5.61	11.08
	9/11/2002	16.69	6.17	10.52
	12/16/2002	16.69	3.91	12.78
	3/28/2003	16.69	4.44	12.25
	6/24/2003	16.69	5.29	11.40
	9/26/2003	16.69	6.88	9.81
	12/16/2003	16.69	NM	NM
	4/6/2004	16.69	3.57	13.12
	6/23/2004	16.69	5.96	10.73
	9/15/2004	16.69	NM	NM
	12/16/2004	16.69	4.40	12.29
	3/22/2005	16.69	3.44	13.25
	6/24/2005	16.69	4.45	12.24
	9/13/2005	16.69	6.03	10.66
	12/2/2005	16.69	4.95	11.74
	3/2/2006	16.69	3.74	12.95
	6/15/2006	16.69	4.58	12.11
MW-2	2/8/1999	20.79	14.20	6.59
	6/15/2000	20.79	10.46	10.33
	9/22/2000	20.79	11.49	9.30
	12/19/2000	20.79	11.38	9.41
	3/21/2001	20.79	10.01	10.78
	6/20/2001	20.79	10.92	9.87
	9/25/2001	20.79	11.78	9.01
	12/3/2001	20.79	11.13	9.66
	3/25/2002	20.79	9.21	11.58
	6/28/2002	20.79	10.65	10.14
	9/11/2002	20.79	10.89	9.90
	12/16/2002	20.79	11.15	9.64
	3/28/2003	20.79	10.27	10.52
	6/24/2003	20.79	10.24	10.55
	9/26/2003	20.79	11.20	9.59
	12/16/2003	20.79	11.50	9.29
4/6/2004	20.79	9.40	11.39	
6/23/2004	20.79	11.60	9.19	



APPENDIX A

HISTORICAL GROUNDWATER ELEVATION DATA  
 FORMER LEMOINE SAUSAGE FACTORY  
 630 29TH AVENUE  
 OAKLAND, CALIFORNIA

Well Identification	Date Measured	Top of Casing Elevation (ft,msl)	Depth to Water (feet)	Groundwater Elevation (ft,msl)
MW-2	9/15/2004	20.79	10.94	9.85
	12/16/2004	20.79	NM	NM
	3/22/2005	20.79	9.26	11.53
	6/24/2005	20.79	10.03	10.76
	9/13/2005	20.79	10.58	10.21
	12/2/2005	20.79	NM	NM
	3/2/2006	20.79	9.45	11.34
	6/15/2006	20.79	9.84	10.95
MW-3	2/8/1999	21.10	7.45	13.65
	6/15/2000	21.10	10.56	10.54
	9/22/2000	21.10	15.30	5.80
	12/19/2000	21.10	9.72	11.38
	3/21/2001	21.10	8.95	12.15
	6/20/2001	21.10	10.14	10.96
	9/25/2001	21.10	10.74	10.36
	Removed from monitoring program in October 2001			
MW-4	2/8/1999	17.78	4.13	13.65
	6/15/2000	17.78	6.30	11.48
	9/22/2000	17.78	6.90	10.88
	12/19/2000	17.78	6.40	11.38
	3/21/2001	17.78	5.77	12.01
	6/20/2001	17.78	6.78	11.00
	9/25/2001	17.78	7.40	10.38
	Removed from monitoring program in October 2001			
MW-5	2/8/1999	21.12	7.62	13.50
	6/15/2000	21.12	10.36	10.76
	9/22/2000	21.12	9.99	11.13
	12/19/2000	21.12	9.99	11.13
	3/21/2001	21.12	8.68	12.44
	6/20/2001	21.12	9.90	11.22
	9/25/2001	21.12	10.34	10.78
	Removed from monitoring program in October 2001			
MW-6	6/15/2000	16.60	5.47	11.13
	9/22/2000	16.60	6.54	10.06
	12/19/2000	16.60	5.93	10.67
	3/21/2001	16.60	4.70	11.90
	6/20/2001	16.60	6.13	10.47
	9/25/2001	16.60	6.68	9.92
	12/3/2001	16.60	4.72	11.88
	3/25/2002	16.60	3.93	12.67
	6/28/2002	16.60	5.83	10.77

APPENDIX A



**HISTORICAL GROUNDWATER ELEVATION DATA  
FORMER LEMOINE SAUSAGE FACTORY  
630 29TH AVENUE  
OAKLAND, CALIFORNIA**

<b>Well Identification</b>	<b>Date Measured</b>	<b>Top of Casing Elevation (ft,msl)</b>	<b>Depth to Water (feet)</b>	<b>Groundwater Elevation (ft,msl)</b>
<b>MW-6</b>	9/11/2002	16.60	5.43	11.17
	12/16/2002	16.60	3.93	12.67
	3/28/2003	16.60	NM	
	6/24/2003	16.60	5.52	11.08
	9/26/2003	16.60	6.70	9.90
	12/16/2003	16.60	4.99	11.61
	4/6/2004	16.60	4.85	11.75
	6/23/2004	16.60	5.76	10.84
	9/15/2004	16.60	6.56	10.04
	12/16/2004	16.60	4.56	12.04
	3/22/2005	16.60	3.63	12.97
	6/24/2005	16.60	4.84	11.76
	9/13/2005	16.60	6.15	10.45
	12/2/2005	16.60	5.24	11.36
	3/2/2006	16.60	3.41	13.19
	6/15/2006	16.60	5.09	11.51
<b>MW-7</b>	12/16/2002	15.47	5.01	10.46
	12/17/2002	15.47	6.95	8.52
	12/18/2002	15.47	6.94	8.53
	12/19/2002	15.47	6.04	9.43
	12/20/2002	15.47	6.48	8.99
	12/21/2002	15.47	7.25	8.22
	12/22/2002	15.47	6.90	8.57
	12/23/2002	15.47	5.53	9.94
	12/24/2002	15.47	7.20	8.27
	12/25/2002	15.47	7.51	7.96
	12/26/2002	15.47	6.40	9.07
	3/28/2003	15.47	5.68	9.79
	6/24/2003	15.47	6.13	9.34
	9/26/2003	15.47	7.22	8.25
	12/16/2003	15.47	5.68	9.79
	4/6/2004	15.47	5.60	9.87
	6/23/2004	15.47	6.20	9.27
	9/15/2004	15.47	6.70	8.77
	12/16/2004	15.47	5.15	10.32
	3/22/2005	15.47	NM	NM
6/24/2005	15.47	NM	NM	
9/13/2005	15.47	6.45	9.02	
12/2/2005	15.47	5.93	9.54	
3/2/2006	15.47	4.65	10.82	
6/15/2006	15.47	5.71	9.76	



APPENDIX A

**HISTORICAL GROUNDWATER ELEVATION DATA  
FORMER LEMOINE SAUSAGE FACTORY  
630 29TH AVENUE  
OAKLAND, CALIFORNIA**

<b>Well Identification</b>	<b>Date Measured</b>	<b>Top of Casing Elevation (ft,msl)</b>	<b>Depth to Water (feet)</b>	<b>Groundwater Elevation (ft,msl)</b>
<b>MW-8</b>	6/15/2000	17.58	7.14	10.44
	9/22/2000	17.58	8.33	9.25
	12/19/2000	17.58	7.71	9.87
	3/21/2001	17.58	6.40	11.18
	6/20/2001	17.58	7.96	9.62
	9/25/2001	17.58	8.89	8.69
	12/3/2001	17.58	6.58	11.00
	3/25/2002	17.58	5.40	12.18
	6/28/2002	17.58	7.71	9.87
	9/11/2002	17.58	8.40	9.18
	12/16/2002	17.58	5.63	11.95
	3/28/2003	17.58	6.62	10.96
	6/24/2003	17.58	7.44	10.14
	9/26/2003	17.58	8.71	8.87
	12/16/2003	17.58	6.69	10.89
	4/6/2004	17.58	6.74	10.84
	6/23/2004	17.58	7.98	9.60
	9/15/2004	17.58	8.52	9.06
	12/16/2004	17.58	5.61	11.97
	3/22/2005	17.58	5.54	12.04
6/24/2005	17.58	6.77	10.81	
9/13/2005	17.58	7.92	9.66	
12/2/2005	17.58	7.36	10.22	
3/2/2006	17.58	5.83	11.75	
6/15/2006	17.58	6.99	10.59	
<b>MW-9</b>	12/3/2001	17.61	5.79	11.82
	3/25/2002	17.61	4.98	12.63
	6/28/2002	17.61	7.71	9.90
	9/11/2002	17.61	6.91	10.70
	12/16/2002	17.61	6.58	11.03
	3/28/2003	17.61	6.08	11.53
	6/24/2003	17.61	6.42	11.19
	9/26/2003	17.61	8.14	9.47
	12/16/2003	17.61	6.76	10.85
	4/6/2004	17.61	5.97	11.64
	6/23/2004	17.61	7.80	9.81
	9/15/2004	17.61	7.14	10.47
	12/16/2004	17.61	5.73	11.88
	3/22/2005	17.61	5.31	12.30
	6/24/2005	17.61	6.05	11.56
	9/13/2005	17.61	6.70	10.91
	12/2/2005	17.61	6.92	10.69
3/2/2006	17.61	5.83	11.78	
6/15/2006	17.61	6.32	11.29	



APPENDIX A



HISTORICAL GROUNDWATER ELEVATION DATA  
 FORMER LEMOINE SAUSAGE FACTORY  
 630 29TH AVENUE  
 OAKLAND, CALIFORNIA

Well Identification	Date Measured	Top of Casing Elevation (ft,msl)	Depth to Water (feet)	Groundwater Elevation (ft,msl)
<b>MW-10</b>	12/3/2001	16.92	4.22	12.70
	3/25/2002	16.92	3.00	13.92
	6/28/2002	16.92	5.65	11.27
	9/11/2002	16.92	6.16	10.76
	12/16/2002	16.92	3.74	13.18
	3/28/2003	16.92	4.54	12.38
	6/24/2003	16.92	5.40	11.52
	9/26/2003	16.92	6.98	9.94
	12/16/2003	16.92	4.94	11.98
	4/6/2004	16.92	4.54	12.38
	6/23/2004	16.92	5.96	10.96
	9/15/2004	16.92	6.86	10.06
	12/16/2004	16.92	4.45	12.47
	3/22/2005	16.92	3.56	13.36
	6/24/2005	16.92	4.58	12.34
	9/12/2005	16.92	6.08	10.84
	12/2/2005	16.92	4.94	11.98
3/2/2006	16.92	3.90	13.02	
6/15/2006	16.92	4.74	12.18	
<b>MW-11</b>	12/3/2001	14.87	5.67	9.20
	3/25/2002	14.87	4.68	10.19
	6/28/2002	14.87	6.35	8.52
	9/11/2002	14.87	6.91	7.96
	12/16/2002	14.87	3.92	10.95
	3/28/2003	14.87	5.17	9.70
	6/24/2003	14.87	5.86	9.01
	9/26/2003	14.87	7.16	7.71
	12/16/2003	14.87	5.61	9.26
	4/6/2004	14.87	5.49	9.38
	6/23/2004	14.87	5.68	9.19
	12/16/2004	14.87	4.69	10.18
	3/22/2005	14.87	4.20	10.67
	6/24/2005	14.87	5.41	9.46
	9/13/2005	14.87	6.23	8.64
	9/15/2005	14.87	6.45	8.42
	12/2/2005	14.87	5.95	8.92
3/2/2006	14.87	4.31	10.56	
6/15/2006	14.87	5.40	9.47	
<b>MW-12</b>	6/28/2002	14.05	6.13	7.92
	9/11/2002	14.05	6.82	7.23
	12/16/2002	14.05	4.94	9.11
	3/28/2003	14.05	5.08	8.97
	6/24/2003	14.05	5.73	8.32
	9/26/2003	14.05	6.94	7.11



APPENDIX A

HISTORICAL GROUNDWATER ELEVATION DATA  
 FORMER LEMOINE SAUSAGE FACTORY  
 630 29TH AVENUE  
 OAKLAND, CALIFORNIA

Well Identification	Date Measured	Top of Casing Elevation (ft,msl)	Depth to Water (feet)	Groundwater Elevation (ft,msl)
MW-12	12/16/2003	14.05	4.99	9.06
	4/6/2004	14.05	5.04	9.01
	6/23/2004	14.05	5.78	8.27
	9/15/2004	14.05	6.43	7.62
	12/16/2004	14.05	4.34	9.71
	3/22/2005	14.05	3.50	10.55
	6/24/2005	14.05	4.9	9.15
	9/12/2005	14.05	6.11	7.94
	12/2/2005	14.05	5.13	8.92
	3/2/2006	14.05	3.83	10.22
	6/15/2006	14.05	5.18	8.87
MW-13	6/28/2002	13.39	6.21	7.18
	9/11/2002	13.39	6.66	6.73
	12/16/2002	13.39	3.90	9.49
	3/28/2003	13.39	5.34	8.05
	6/24/2003	13.39	5.99	7.40
	9/26/2003	13.39	6.99	6.40
	12/16/2003	13.39	5.01	8.38
	4/6/2004	13.39	5.35	8.04
	6/23/2004	13.39	6.12	7.27
	9/15/2004	13.39	6.63	6.76
	12/16/2004	13.39	4.69	8.70
	3/22/2005	13.39	4.86	8.53
	6/24/2005	13.39	5.13	8.26
	9/12/2005	13.39	6.33	7.06
	12/2/2005	13.39	5.25	8.14
	3/2/2006	13.39	4.33	9.06
	6/15/2006	13.39	5.44	7.95

**Notes:**

1. All top of casing elevations referenced to mean sea level (msl) and surveyed with reference to the benchmark located at Peterson Street and East 7<sup>th</sup> Street.
2. NM refers to Not Measured.



## **APPENDIX B**

### **HISTORICAL GROUNDWATER ANALYTICAL RESULTS**

APPENDIX B

HISTORICAL GROUNDWATER ANALYTICAL RESULTS  
 FORMER LEMOINE SAUSAGE FACTORY  
 630 29TH AVENUE  
 OAKLAND, CALIFORNIA



Sample Location	Date Sampled	TPH-g	Benzene	Toluene	Ethylbenzene	Total Xylenes	TCE	1,2-DCA	cis-1,2-DCE	trans-1,2-DCE	VC
		ug/L	ug/L	ug/L	ug/L	ug/L	ug/L	ug/L	ug/L	ug/L	ug/L
	RWQCB ESL	100	1	40	30	20	5	0.5	6	10	0.5
	DHS MCL	-	1	150	300	1750	5	0.5	6	10	0.5
MW-1	2/8/1999	48,000	3,900	6,300	970	4,300	NA	<30	NA	NA	NA
	6/15/2000	29,000	3,900	<100	1,900	4,200	<5.0	<5.0	<5.0	<5.0	<5.0
	9/22/2000	25,000	3,100	1,800	470	3,600	NA	NA	NA	NA	NA
	12/19/2000	25,000	3,200	1,900	480	3,300	<2.5	<2.5	<2.5	<2.5	<2.5
	3/21/2000	21,000	3,200	1,700	290	2,600	<2.5	<2.5	<2.5	<2.5	<2.5
	6/21/2001	12,000	2,000	880	180	1,180	<0.5	3.0	<0.5	<0.5	<0.5
	9/26/2001	16,000	1,100	130	< 10	320	< 2.5	< 2.5	< 2.5	< 2.5	< 2.5
	12/3/2001	15,000	2,800	1,200	310	1,660	<3.1	<3.1	<3.1	<3.1	<3.1
	3/25/2002	11,000	3,200	1,200	73	1,860	<5	<5	<5	<5	<5
	6/28/2002	26,000	3,200	1,800	640	2,900	<3.1	<3.1	<3.1	<3.1	<3.1
	9/11/2002	27,000	3,200	1,900	720	3,500	<4.2	<4.2	<4.2	<4.2	<4.2
	12/16/2002	20,000	2,800	490	500	2,300	<4.2	<4.2	<4.2	<4.2	<4.2
	3/28/2003	20,000	2,700	1,500	650	2,300	<3.6	<3.6	<3.6	<3.6	<3.6
	6/24/2003	14,000	2,400	1,400	500	2,100	<4.2	<4.2	<4.2	<4.2	<4.2
	9/26/2003	11,000	1,200	960	370	1,600	<1.0	<1.0	<1.0	<1.0	<1.0
	12/16/2003	Not Sampled									
	4/6/2004	18,000	2,400	1,300	550	1,730	<2.0	<2.0	<2.0	<2.0	<2.0
	6/23/2004	25,000	2,700	1,700	680	2,300	<2.5	<2.5	<2.5	<2.5	<2.5
	9/15/2004	Not Sampled									
	12/16/2004	1,800	260	89	32	119	<2.5	<2.5	<2.5	<2.5	<2.5
	3/22/2005	19,000	2,400	960	530	1,330	<3.6	<3.6	<3.6	<3.6	<3.6
	6/24/2005	12,000	2,400	450	470	940	<3.6	<3.6	<3.6	<3.6	<3.6
	9/13/2005	17,000	2,700	1,000	740	1,760	<1.0	<1.0	<1.0	<1.0	<1.0
	12/2/2005	9,300	1,500	500	420	1,060	<3.6	<3.6	<3.6	<3.6	<3.6
	3/2/2006	6,200	1,400	200	180	370	<3.6	<3.6	<3.6	<3.6	<3.6
	6/15/2006	10,000	2,500	200	440	570	<4.2	<4.2	<4.2	<4.2	<4.2

APPENDIX B

HISTORICAL GROUNDWATER ANALYTICAL RESULTS  
 FORMER LEMOINE SAUSAGE FACTORY  
 630 29TH AVENUE  
 OAKLAND, CALIFORNIA



Sample Location	Date Sampled	TPH-g	Benzene	Toluene	Ethylbenzene	Total Xylenes	TCE	1,2-DCA	cis-1,2-DCE	trans-1,2-DCE	VC
		ug/L	ug/L	ug/L	ug/L	ug/L	ug/L	ug/L	ug/L	ug/L	ug/L
	RWQCB ESL	100	1	40	30	20	5	0.5	6	10	0.5
	DHS MCL	-	1	150	300	1750	5	0.5	6	10	0.5
MW-2	2/8/1999	41,000	11,000	4,900	650	1,720	NA	60	NA	NA	NA
	6/29/2000	31,000	11,000	930	4,400	250	<5.0	25	<5.0	<5.0	<5.0
	9/22/2000	24,000	10,000	2,700	370	1,200	NA	NA	NA	NA	NA
	12/19/2000	43,000	9,800	4,000	810	2,430	<13	21	<13	<13	<13
	3/23/2001	34,000	10,000	3,200	410	1,220	<13	14	<13	<13	<13
	6/21/2001	30,000	8,600	2,600	440	1,230	<0.5	5.6	<0.5	<0.5	<0.5
	9/26/2001	26,000	12,000	3,900	590	1,960	<10	11	<10	<10	<10
	12/3/2001	45,000	13,000	5,100	950	2,930	<7.1	14	<7.1	<7.1	<7.1
	3/25/2002	21,000	11,000	3,700	1,000	2,790	<17	<17	<17	<17	<17
	6/28/2002	8,400	2,200	680	21	220	<3.1	8.8	<3.1	<3.1	<3.1
	9/11/2002	23,000	6,600	1,000	600	1,320	<6.3	10	<6.3	<6.3	<6.3
	12/16/2002	6,000	1,600	410	150	402	4.5	2.7	69	6.9	<2.5
	3/28/2003	30,000	9,300	920	930	2,000	<13	14	<13	<13	<13
	6/24/2003	19,000	10,000	1,700	1,100	2,530	<13	<13	<13	<13	<13
	9/26/2003	20,000	10,000	2,100	960	2,520	<17	<17	<17	<17	<17
	12/16/2003	22,000	10,000	2,700	1,200	2,920	<25	<25	<25	<25	<25
	4/6/2004	27,000	7,600	1,700	630	1,420	<10	<10	<10	<10	<10
	6/23/2004	33,000	8,200	1,800	870	1,930	<17	<17	<17	<17	<17
	9/15/2004	46,000	13,000	1,300	1,400	2,710	<17	<17	<17	<17	<17
	12/16/2004	Not Sampled									
3/22/2005	42,000	9,900	1,200	1,200	2,530	<17	<17	<17	<17	<17	
6/24/2005	31,000	12,000	1,200	810	1,380	<20	<20	<20	<20	<20	
9/13/2005	35,000	13,000	1,100	1,300	2,260	<7.1	<7.1	<7.1	<7.1	<7.1	
12/2/2005	Not Sampled										
3/2/2006	25,000	7,900	620	740	1,260	<7.1	<7.1	<7.1	<7.1	<7.1	
6/15/2006	47,000	11,000	800	1,200	2,230	<20	<20	<20	<20	<20	

APPENDIX B

HISTORICAL GROUNDWATER ANALYTICAL RESULTS  
 FORMER LEMOINE SAUSAGE FACTORY  
 630 29TH AVENUE  
 OAKLAND, CALIFORNIA



Sample Location	Date Sampled	TPH-g	Benzene	Toluene	Ethylbenzene	Total Xylenes	TCE	1,2-DCA	cis-1,2-DCE	trans-1,2-DCE	VC
		ug/L	ug/L	ug/L	ug/L	ug/L	ug/L	ug/L	ug/L	ug/L	ug/L
	<b>RWQCB ESL</b>	<b>100</b>	<b>1</b>	<b>40</b>	<b>30</b>	<b>20</b>	<b>5</b>	<b>0.5</b>	<b>6</b>	<b>10</b>	<b>0.5</b>
	<b>DHS MCL</b>	<b>-</b>	<b>1</b>	<b>150</b>	<b>300</b>	<b>1750</b>	<b>5</b>	<b>0.5</b>	<b>6</b>	<b>10</b>	<b>0.5</b>
<b>MW-3</b>	2/8/1999	<b>35,000</b>	<b>1,200</b>	<b>3,400</b>	<b>1,400</b>	<b>4,900</b>	NA	<30	NA	NA	NA
	6/29/2000	<b>39,000</b>	<b>7,800</b>	<b>630</b>	<b>8,000</b>	<b>3,400</b>	<5.0	<b>600</b>	<5.0	<5.0	<5.0
	9/22/2000	<b>83,000</b>	<b>16,000</b>	<b>20,000</b>	<b>1,300</b>	<b>7,000</b>	NA	NA	NA	NA	NA
	12/19/2000	<b>50,000</b>	<b>1,200</b>	<b>1,600</b>	<b>510</b>	<b>1,810</b>	<8.3	<b>350</b>	<8.3	<8.3	<8.3
	3/22/2001	<b>1,300</b>	<b>98</b>	<b>67</b>	<b>51</b>	<b>104</b>	<0.5	<b>2.3</b>	<0.5	<0.5	<0.5
	6/21/2001	<b>34,000</b>	<b>5,900</b>	<b>6,200</b>	<b>340</b>	<b>1,550</b>	2.4	<b>120</b>	<b>0.8</b>	<0.5	<0.5
	9/26/2001	<b>59,000</b>	<b>12,000</b>	<b>13,000</b>	<b>780</b>	<b>3,680</b>	< 8.3	<b>990</b>	< 8.3	< 8.3	< 8.3
Removed from sampling program in October 2001											
<b>MW-4</b>	2/8/1999	<b>15,000</b>	<b>670</b>	<b>90</b>	<b>780</b>	<b>940</b>	NA	<30	NA	NA	NA
	6/15/2000	<b>2,300</b>	<b>230</b>	<5	<b>10</b>	<b>94</b>	<0.5	<b>0.88</b>	<b>2.1</b>	<0.5	<0.5
	9/22/2000	<b>12,000</b>	<b>2,800</b>	<b>82</b>	<b>1,100</b>	<b>1,300</b>	NA	NA	NA	NA	NA
	12/19/2000	<b>2,200</b>	<b>200</b>	<b>2.9</b>	<b>100</b>	<b>81.4</b>	<0.5	<0.5	<0.5	<0.5	<0.5
	3/22/2001	<b>5,600</b>	<b>1,100</b>	<b>13</b>	<b>310</b>	<b>303</b>	<0.5	<0.5	<b>1.6</b>	<0.5	<0.5
	6/21/2001	<b>11,000</b>	<b>2,300</b>	<b>26</b>	<b>570</b>	<b>641</b>	<0.5	<b>1.4</b>	<b>3.3</b>	<0.5	<0.5
	9/26/2001	<b>17,000</b>	<b>7,900</b>	< 50	<b>440</b>	<b>581</b>	< 0.5	<b>1.9</b>	<b>8.1</b>	< 0.5	< 0.5
Removed from sampling program in October 2001											
<b>MW-5</b>	2/8/1999	<b>4,900</b>	<b>780</b>	<b>440</b>	<b>230</b>	<b>370</b>	<0.5	<0.5	<0.5	<0.5	<0.5
	6/29/2000	<b>3,900</b>	<b>1,500</b>	<b>28</b>	<b>330</b>	<b>260</b>	<0.5	<b>36</b>	<0.5	<0.5	<0.5
	9/27/2000	<b>16,000</b>	<b>4,300</b>	<b>3,100</b>	<b>420</b>	<b>1,600</b>	NA	NA	NA	NA	NA
	12/19/2000	<b>21,000</b>	<b>3,200</b>	<b>1,100</b>	<b>1,100</b>	<b>1,300</b>	<4.2	<b>15</b>	<4.2	<4.2	<4.2
	3/22/2001	<b>6,200</b>	<b>1,500</b>	<b>360</b>	<b>310</b>	<b>288</b>	<0.5	<b>3.3</b>	<0.5	<0.5	<0.5
	6/21/2001	<b>18,000</b>	<b>3,400</b>	<b>2,300</b>	<b>350</b>	<b>1,020</b>	<0.5	<b>21</b>	<0.5	<0.5	<0.5
	9/26/2001	<b>5,100</b>	<b>2,400</b>	<b>1,200</b>	< 10	<b>460</b>	< 3.6	<b>22</b>	< 3.6	< 3.6	< 3.6
Removed from sampling program in October 2001											

APPENDIX B

HISTORICAL GROUNDWATER ANALYTICAL RESULTS  
 FORMER LEMOINE SAUSAGE FACTORY  
 630 29TH AVENUE  
 OAKLAND, CALIFORNIA



Sample Location	Date Sampled	TPH-g	Benzene	Toluene	Ethylbenzene	Total Xylenes	TCE	1,2-DCA	cis-1,2-DCE	trans-1,2-DCE	VC
		ug/L	ug/L	ug/L	ug/L	ug/L	ug/L	ug/L	ug/L	ug/L	ug/L
	RWQCB ESL	100	1	40	30	20	5	0.5	6	10	0.5
	DHS MCL	-	1	150	300	1750	5	0.5	6	10	0.5
MW-6	6/15/2000	1,100	3.8	2.2	2.1	4.8	< 0.5	0.78	< 0.5	< 0.5	< 0.5
	9/22/2000	71	< 0.5	< 0.5	< 0.5	< 0.5	NA	NA	NA	NA	NA
	12/19/2000	320	< 0.5	< 0.5	< 0.5	< 0.5	< 0.5	< 0.5	< 0.5	< 0.5	< 0.5
	3/21/2001	820	< 0.5	< 0.5	1.4	0.52	< 0.5	< 0.5	< 0.5	< 0.5	< 0.5
	6/21/2001	420	< 0.5	< 0.5	0.59	1	< 0.5	0.9	< 0.5	< 0.5	< 0.5
	9/25/2001	760	< 0.5	< 0.5	< 0.5	2.9	< 0.5	< 0.5	< 0.5	< 0.5	< 0.5
	12/3/2001	72	< 0.5	< 0.5	< 0.5	< 0.5	< 0.5	1.6	< 0.5	< 0.5	< 0.5
	3/25/2002	1,200	22	8.0	5.7	13.5	< 0.5	< 0.5	< 0.5	< 0.5	< 0.5
	6/28/2002	120	< 0.5	< 0.5	< 0.5	< 0.5	< 0.5	0.6	< 0.5	< 0.5	< 0.5
	9/11/2002	120	< 0.5	< 0.5	< 0.5	< 0.5	< 0.5	< 0.5	< 0.5	< 0.5	< 0.5
	12/16/2002	62	< 0.5	0.54	3.0	8.39	0.7	1	< 0.5	< 0.5	< 0.5
	3/28/2003	NS	NS	NS	NS	NS	NS	NS	NS	NS	NS
	6/24/2003	130	< 0.5	< 0.5	< 0.5	< 0.5	< 0.5	< 0.5	< 0.5	< 0.5	< 0.5
	9/26/2003	< 50	< 0.5	< 0.5	< 0.5	< 0.5	< 0.5	0.7	< 0.5	< 0.5	< 0.5
	12/16/2003	< 50	< 0.5	< 0.5	< 0.5	0.88	1.7	< 0.5	0.6	< 0.5	< 0.5
	4/6/2004	260	< 0.5	< 0.5	< 0.5	< 0.5	< 0.5	< 0.5	< 0.5	< 0.5	< 0.5
	6/23/2004	63	< 0.5	< 0.5	< 0.5	< 0.5	< 0.5	0.8	< 0.5	< 0.5	< 0.5
	9/15/2004	< 50	< 0.5	< 0.5	< 0.5	< 0.5	< 0.5	< 0.5	< 0.5	< 0.5	< 0.5
	12/16/2004	240	< 0.5	< 0.5	< 0.5	< 0.5	< 0.5	< 0.5	< 0.5	< 0.5	< 0.5
	3/22/2005	420	< 0.5	< 0.5	< 0.5	0.95	< 0.5	< 0.5	< 0.5	< 0.5	< 0.5
	6/24/2005	91	< 0.5	< 0.5	< 0.5	< 0.5	< 0.5	< 0.5	< 0.5	< 0.5	< 0.5
	9/13/2005	< 50	< 0.5	< 0.5	< 0.5	< 0.5	< 0.5	< 0.5	< 0.5	< 0.5	< 0.5
	12/2/2005	< 50	< 0.5	< 0.5	< 0.5	< 0.5	< 0.5	0.7	< 0.5	< 0.5	< 0.5
	3/2/2006	120	< 0.5	< 0.5	< 0.5	< 0.5	< 0.5	< 0.5	< 0.5	< 0.5	< 0.5
	6/15/2006	51	< 0.5	< 0.5	< 0.5	< 0.5	< 0.5	< 0.5	< 0.5	< 0.5	< 0.5

APPENDIX B

HISTORICAL GROUNDWATER ANALYTICAL RESULTS  
 FORMER LEMOINE SAUSAGE FACTORY  
 630 29TH AVENUE  
 OAKLAND, CALIFORNIA



Sample Location	Date Sampled	TPH-g	Benzene	Toluene	Ethylbenzene	Total Xylenes	TCE	1,2-DCA	cis-1,2-DCE	trans-1,2-DCE	VC
		ug/L	ug/L	ug/L	ug/L	ug/L	ug/L	ug/L	ug/L	ug/L	ug/L
	RWQCB ESL	100	1	40	30	20	5	0.5	6	10	0.5
	DHS MCL	-	1	150	300	1750	5	0.5	6	10	0.5
MW-7	6/15/2000	1,000	250	< 10	<10	16	< 0.5	< 0.5	< 0.5	< 0.5	< 0.5
	9/22/2000	<50	2	< 0.5	< 0.5	< 0.5	NA	NA	NA	NA	NA
	12/19/2000	<50	1.6	< 0.5	< 0.5	< 0.5	< 0.5	< 0.5	< 0.5	< 0.5	< 0.5
	3/21/2001	160	59	< 0.5	< 0.5	< 0.5	< 0.5	< 0.5	< 0.5	< 0.5	< 0.5
	6/21/2001	<50	< 0.5	< 0.5	< 0.5	< 0.5	< 0.5	< 0.5	< 0.5	< 0.5	< 0.5
	9/25/2001	< 50	< 0.5	< 0.5	< 0.5	< 0.5	< 0.5	< 0.5	< 0.5	< 0.5	< 0.5
	12/3/2001	82	24	< 0.5	< 0.5	< 0.5	< 0.5	< 0.5	< 0.5	< 0.5	< 0.5
	3/25/2002	<50	0.56	0.75	<0.5	0.69	< 0.5	< 0.5	< 0.5	< 0.5	< 0.5
	6/28/2002	<50	< 0.5	< 0.5	< 0.5	< 0.5	< 0.5	< 0.5	< 0.5	< 0.5	< 0.5
	9/11/2002	<50	< 0.5	< 0.5	< 0.5	< 0.5	< 0.5	< 0.5	< 0.5	< 0.5	< 0.5
	12/16/2002	<50	< 0.5	< 0.5	1.6	3.7	0.5	<0.5	<0.5	<0.5	<0.5
	3/28/2003	<50	< 0.5	< 0.5	< 0.5	< 0.5	< 0.5	< 0.5	< 0.5	< 0.5	< 0.5
	6/24/2003	<50	< 0.5	< 0.5	< 0.5	< 0.5	< 0.5	< 0.5	< 0.5	< 0.5	< 0.5
	9/26/2003	<50	< 0.5	< 0.5	< 0.5	< 0.5	< 0.5	< 0.5	< 0.5	< 0.5	< 0.5
	12/16/2003	<50	< 0.5	< 0.5	< 0.5	0.75	1.8	< 0.5	0.6	< 0.5	< 0.5
	4/6/2004	<50	< 0.5	< 0.5	< 0.5	< 0.5	< 0.5	< 0.5	< 0.5	< 0.5	< 0.5
	6/23/2004	<50	< 0.5	< 0.5	< 0.5	< 0.5	< 0.5	< 0.5	< 0.5	< 0.5	< 0.5
	9/15/2004	<50	< 0.5	< 0.5	< 0.5	< 0.5	< 0.5	< 0.5	< 0.5	< 0.5	< 0.5
	12/16/2004	<50	< 0.5	< 0.5	< 0.5	< 0.5	< 0.5	< 0.5	< 0.5	< 0.5	< 0.5
	3/22/2005	Not Sampled									
	6/24/2005	Not Sampled									
	9/12/2005	<50	< 0.5	< 0.5	< 0.5	< 0.5	< 0.5	< 0.5	< 0.5	< 0.5	< 0.5
	12/2/2005	<50	< 0.5	< 0.5	< 0.5	< 0.5	< 0.5	< 0.5	< 0.5	< 0.5	< 0.5
	3/2/2006	<50	< 0.5	< 0.5	< 0.5	< 0.5	< 0.5	< 0.5	< 0.5	< 0.5	< 0.5
	6/15/2006	<50	< 0.5	< 0.5	< 0.5	0.62	< 0.5	< 0.5	< 0.5	< 0.5	< 0.5



APPENDIX B

HISTORICAL GROUNDWATER ANALYTICAL RESULTS  
 FORMER LEMOINE SAUSAGE FACTORY  
 630 29TH AVENUE  
 OAKLAND, CALIFORNIA



Sample Location	Date Sampled	TPH-g	Benzene	Toluene	Ethylbenzene	Total Xylenes	TCE	1,2-DCA	cis-1,2-DCE	trans-1,2-DCE	VC
		ug/L	ug/L	ug/L	ug/L	ug/L	ug/L	ug/L	ug/L	ug/L	ug/L
	RWQCB ESL	100	1	40	30	20	5	0.5	6	10	0.5
	DHS MCL	-	1	150	300	1750	5	0.5	6	10	0.5
MW-8	6/15/2000	5,400	150	<5	8.9	8.7	210	<13	1,100	73	25
	9/22/2000	1,800	340	<2.5	<2.5	<2.5	NA	NA	NA	NA	NA
	12/19/2000	2,700	410	<2.5	4.8	<2.5	130	9.1	1,000	67	48
	3/21/2001	3,500	530	<2.5	21	<2.5	32	<3.6	760	39	58
	6/21/2001	2,400	490	<2.5	29	<2.5	28	4.9	910	48	75
	9/25/2001	1,500	170	4.3	1.6	2.7	36	5.0	820	59	53
	12/3/2001	1,200	190	14	2.7	11.3	100	<2.5	650	44	31
	3/25/2002	990	280	7.2	1.4	6.8	10	3.6	790	33	49
	6/28/2002	2,200	410	<1.0	40	<1.0	18	4.9	900	54	80
	9/11/2002	2,000	390	1.6	39	<1.0	17	<3.6	1,000	60	91
	12/16/2002	95	26	<0.5	1	<0.5	17	2.2	330	36	4.7
	3/28/2003	1,500	400	<0.5	50	0.62	3.5	<2.5	700	39	41
	6/24/2003	3,300	520	<0.5	58	0.63	6.4	3.7	1,000	49	61
	9/26/2003	1,300	280	3.9	38	0.85	20	<3.6	890	49	47
	12/16/2003	1,100	310	<2.5	14	<2.5	12	4.3	1,200	53	110
	4/6/2004	3,800	420	<0.5	53	1.2	4.4	3.7	1,100	39	58
	6/23/2004	4,600	570	2.9	100	1.5	<8.3	<8.3	1,300	50	80
	9/15/2004	4,900	710	<1.0	100	<1.0	<7.1	<7.1	1,200	49	100
	12/16/2004	3,800	450	<0.5	75	6.5	<8.3	<8.3	1,500	60	86
	3/22/2005	1,700	120	<1.0	9.8	<1.0	<3.6	<3.6	620	27	38
	6/24/2005	1,400	100	<1.0	37	<1.0	<5.0	<5.0	770	29	51
	9/13/2005	2,700	250	<1.0	110	<1.0	<7.1	<7.1	1,000	35	60
	12/2/2005	1,500	160	<1.0	33	<1.0	13	<5.0	930	46	80
	3/2/2006	2,000 L	210	<0.5	36	<0.5	<6.3	<6.3	890	34	50
	6/15/2006	1,400	78	<0.5	21	<0.5	6.9	<5.0	700	28	41

APPENDIX B

HISTORICAL GROUNDWATER ANALYTICAL RESULTS  
 FORMER LEMOINE SAUSAGE FACTORY  
 630 29TH AVENUE  
 OAKLAND, CALIFORNIA



Sample Location	Date Sampled	TPH-g	Benzene	Toluene	Ethylbenzene	Total Xylenes	TCE	1,2-DCA	cis-1,2-DCE	trans-1,2-DCE	VC
		ug/L	ug/L	ug/L	ug/L	ug/L	ug/L	ug/L	ug/L	ug/L	ug/L
	<b>RWQCB ESL</b>	<b>100</b>	<b>1</b>	<b>40</b>	<b>30</b>	<b>20</b>	<b>5</b>	<b>0.5</b>	<b>6</b>	<b>10</b>	<b>0.5</b>
	<b>DHS MCL</b>	<b>-</b>	<b>1</b>	<b>150</b>	<b>300</b>	<b>1750</b>	<b>5</b>	<b>0.5</b>	<b>6</b>	<b>10</b>	<b>0.5</b>
<b>MW-9</b>	12/3/2001	<b>90,000</b>	<b>15,000</b>	<b>15,000</b>	<b>2,200</b>	<b>9,100</b>	<10	<10	<10	<10	<10
	3/25/2002	<b>71,000</b>	<b>15,000</b>	<b>17,000</b>	<b>1,900</b>	<b>8,000</b>	<31	<31	<31	<31	<31
	6/28/2002	<b>60,000</b>	<b>5,800</b>	<b>7,400</b>	<b>1,100</b>	<b>5,400</b>	<13	<13	<13	<13	<13
	9/11/2002	<b>57,000</b>	<b>8,300</b>	<b>6,100</b>	<b>340</b>	<b>4,700</b>	<10	<b>18</b>	<10	<10	<10
	12/16/2002	<b>29,000</b>	<b>5,500</b>	<b>3,900</b>	<b>300</b>	<b>1,860</b>	<5	<b>8.9</b>	<5	<5	<5
	3/28/2003	<b>61,000</b>	<b>13,000</b>	<b>8,600</b>	<b>860</b>	<b>4,800</b>	<20	<20	<20	<20	<20
	6/24/2003	<b>45,000</b>	<b>15,000</b>	<b>9,600</b>	<b>1,100</b>	<b>5,200</b>	<5	<b>10</b>	<5	<5	<5
	9/26/2003	<b>34,000</b>	<b>12,000</b>	<b>5,600</b>	<b>880</b>	<b>4,700</b>	<17	<17	<17	<17	<17
	12/16/2003	<b>34,000</b>	<b>14,000</b>	<b>4,900</b>	<b>940</b>	<b>4,700</b>	<42	<42	<42	<42	<42
	4/6/2004	<b>60,000</b>	<b>14,000</b>	<b>3,100</b>	<b>1,300</b>	<b>5,500</b>	<17	<17	<17	<17	<17
	6/23/2004	<b>53,000</b>	<b>12,000</b>	<b>2,600</b>	<b>1,100</b>	<b>4,800</b>	<20	<20	<20	<20	<20
	9/15/2004	<b>76,000</b>	<b>17,000</b>	<b>2,200</b>	<b>1,500</b>	<b>6,600</b>	<20	<20	<20	<20	<20
	12/16/2004	<b>63,000</b>	<b>15,000</b>	<b>1,700</b>	<b>1,300</b>	<b>5,900</b>	<20	<20	<20	<20	<20
	3/22/2005	<b>66,000</b>	<b>13,000</b>	<b>2,000</b>	<b>1,200</b>	<b>5,800</b>	<17	<17	<17	<17	<17
	6/24/2005	<b>54,000</b>	<b>16,000</b>	<b>780</b>	<b>1,300</b>	<b>5,200</b>	<20	<20	<20	<20	<20
	9/13/2005	<b>48,000</b>	<b>11,000</b>	<b>4,800</b>	<b>470</b>	<b>4,110</b>	<17	<17	<17	<17	<17
12/2/2005	<b>39,000</b>	<b>12,000</b>	<b>3,800</b>	<b>650</b>	<b>3,470 C</b>	<20	<20	<20	<20	<20	
3/2/2006	<b>51,000</b>	<b>12,000</b>	<b>3,500</b>	<b>750</b>	<b>4,170</b>	<20	<20	<20	<20	<20	
6/15/2006	<b>67,000</b>	<b>16,000</b>	<b>5,000</b>	<b>1,900</b>	<b>5,790</b>	<36	<36	<36	<36	<36	
<b>MW-10</b>	12/3/2001	<50	<0.5	<0.5	<0.5	<0.5	<0.5	<0.5	<0.5	<0.5	<0.5
	3/25/2002	<b>51</b>	<b>2.5</b>	<b>3.6</b>	<b>0.53</b>	<b>2.27</b>	<0.5	<0.5	<0.5	<0.5	<0.5
	6/28/2002	<50	<0.5	<0.5	<0.5	<0.5	<0.5	<0.5	<0.5	<0.5	<0.5
	9/11/2002	<50	<0.5	<0.5	<0.5	<0.5	<0.5	<0.5	<0.5	<0.5	<0.5
	12/16/2002	<50	<0.5	0.65	<b>3.0</b>	<b>7.53</b>	<b>0.8</b>	<0.5	<0.5	<0.5	<0.5
	3/28/2003	<50	<0.5	<0.5	<0.5	<0.5	<0.5	<0.5	<0.5	<0.5	<0.5
6/24/2003	<50	<0.5	<0.5	<0.5	<0.5	<0.5	<0.5	<0.5	<0.5	<0.5	

APPENDIX B

HISTORICAL GROUNDWATER ANALYTICAL RESULTS  
 FORMER LEMOINE SAUSAGE FACTORY  
 630 29TH AVENUE  
 OAKLAND, CALIFORNIA



Sample Location	Date Sampled	TPH-g	Benzene	Toluene	Ethylbenzene	Total Xylenes	TCE	1,2-DCA	cis-1,2-DCE	trans-1,2-DCE	VC
		ug/L	ug/L	ug/L	ug/L	ug/L	ug/L	ug/L	ug/L	ug/L	ug/L
	<b>RWQCB ESL</b>	<b>100</b>	<b>1</b>	<b>40</b>	<b>30</b>	<b>20</b>	<b>5</b>	<b>0.5</b>	<b>6</b>	<b>10</b>	<b>0.5</b>
	<b>DHS MCL</b>	<b>-</b>	<b>1</b>	<b>150</b>	<b>300</b>	<b>1750</b>	<b>5</b>	<b>0.5</b>	<b>6</b>	<b>10</b>	<b>0.5</b>
<b>MW-10</b>	9/26/2003	<50	<0.5	<0.5	<0.5	<0.5	<0.5	<0.5	<0.5	<0.5	<0.5
	12/16/2003	<50	<0.5	<0.5	<0.5	<0.5	<b>0.6</b>	<0.5	<0.5	<0.5	<0.5
	4/6/2004	<50	<0.5	<0.5	<0.5	<0.5	<0.5	<0.5	<0.5	<0.5	<0.5
	6/23/2004	<50	<0.5	<0.5	<0.5	<0.5	<0.5	<0.5	<0.5	<0.5	<0.5
	9/15/2004	<50	<0.5	<0.5	<0.5	<0.5	<0.5	<0.5	<0.5	<0.5	<0.5
	12/16/2004	<50	<0.5	<0.5	<0.5	<0.5	<0.5	<0.5	<0.5	<0.5	<0.5
	3/22/2005	<50	<0.5	<0.5	<0.5	<0.5	<0.5	<0.5	<0.5	<0.5	<0.5
	6/24/2005	<50	<0.5	<0.5	<0.5	<0.5	<0.5	<0.5	<0.5	<0.5	<0.5
	9/12/2005	<50	<0.5	<0.5	<0.5	<0.5	<0.5	<0.5	<0.5	<0.5	<0.5
	12/2/2005	<50	<0.5	<0.5	<0.5	<0.5	<0.5	<0.5	<0.5	<0.5	<0.5
	3/2/2006	<50	<b>0.74</b>	<0.5	<0.5	<0.5	<0.5	<0.5	<0.5	<0.5	<0.5
6/15/2006	<50	<0.5	<0.5	<0.5	<0.5	<0.5	<0.5	<0.5	<0.5	<0.5	
<b>MW-11</b>	12/3/2001	<b>1,600</b>	<b>470</b>	<0.5	<b>3.7</b>	<0.5	<0.5	<0.5	<0.5	<0.5	<0.5
	3/25/2002	<b>130</b>	<b>11</b>	<b>20</b>	<b>3.3</b>	<b>14.5</b>	<0.5	<0.5	<0.5	<0.5	<0.5
	6/28/2002	<50	<b>7.7</b>	<0.5	<b>&lt;0.5</b>	<0.5	<b>0.6</b>	<0.5	<0.5	<0.5	<0.5
	9/11/2002	<b>120</b>	<b>66</b>	<0.5	<b>0.74</b>	<0.5	<0.5	<0.5	<b>0.6</b>	<0.5	<0.5
	12/16/2002	<b>160</b>	<b>42</b>	<b>0.89</b>	<b>4.8</b>	<b>11.1</b>	<b>3.6</b>	<0.5	<b>1.1</b>	<0.5	<0.5
	3/28/2003	<50	<0.5	<0.5	<0.5	<0.5	<0.5	<0.5	<0.5	<0.5	<0.5
	6/24/2003	<50	<0.5	<0.5	<0.5	<0.5	<0.5	<0.5	<0.5	<0.5	<0.5
	9/26/2003	<50	<b>1.2</b>	<b>0.69</b>	<0.5	<0.5	<0.5	<0.5	<0.5	<0.5	<0.5
	12/16/2003	<b>91</b>	<b>4.7</b>	<0.5	<0.5	<b>0.51</b>	<b>2.9</b>	<0.5	<b>0.9</b>	<b>0.6</b>	<0.5
	4/6/2004	<50	<0.5	<0.5	<0.5	<0.5	<0.5	<0.5	<0.5	<0.5	<0.5
	6/23/2004	<50	<0.5	<0.5	<0.5	<0.5	<0.5	<0.5	<0.5	<0.5	<0.5
	9/15/2004	<50	<0.5	<0.5	<0.5	<0.5	<0.5	<0.5	<0.5	<0.5	<0.5
	12/16/2004	<50	<b>1.3</b>	<0.5	<0.5	<b>0.59</b>	<0.5	<0.5	<0.5	<0.5	<0.5
	3/22/2005	<50	<0.5	<0.5	<0.5	<0.5	<0.5	<0.5	<0.5	<0.5	<0.5

APPENDIX B

HISTORICAL GROUNDWATER ANALYTICAL RESULTS  
 FORMER LEMOINE SAUSAGE FACTORY  
 630 29TH AVENUE  
 OAKLAND, CALIFORNIA



Sample Location	Date Sampled	TPH-g	Benzene	Toluene	Ethylbenzene	Total Xylenes	TCE	1,2-DCA	cis-1,2-DCE	trans-1,2-DCE	VC
		ug/L	ug/L	ug/L	ug/L	ug/L	ug/L	ug/L	ug/L	ug/L	ug/L
	<b>RWQCB ESL</b>	<b>100</b>	<b>1</b>	<b>40</b>	<b>30</b>	<b>20</b>	<b>5</b>	<b>0.5</b>	<b>6</b>	<b>10</b>	<b>0.5</b>
	<b>DHS MCL</b>	<b>-</b>	<b>1</b>	<b>150</b>	<b>300</b>	<b>1750</b>	<b>5</b>	<b>0.5</b>	<b>6</b>	<b>10</b>	<b>0.5</b>
<b>MW-11</b>	6/24/2005	<0.5	<0.5	<0.5	<0.5	<0.5	<0.5	<0.5	<0.5	<0.5	<0.5
	9/13/2005	<0.5	<0.5	<0.5	<0.5	<0.5	<0.5	<0.5	<0.5	<0.5	<0.5
	12/2/2005	<0.5	<0.5	<0.5	<0.5	<0.5	<0.5	<0.5	<0.5	<0.5	<0.5
	3/2/2006	<0.5	<0.5	<0.5	<0.5	<0.5	<0.5	<0.5	<0.5	<0.5	<0.5
	6/15/2006	<0.5	<0.5	<0.5	<0.5	<0.5	<0.5	<0.5	<0.5	<0.5	<0.5
<b>MW-12</b>	6/28/2002	<b>71</b>	<0.5	<0.5	<0.5	<0.5	<b>170</b>	<0.5	<b>42</b>	<b>47</b>	<b>0.9</b>
	9/11/2002	<b>89</b>	<0.5	<0.5	<0.5	<0.5	<b>180</b>	<0.5	<b>46</b>	<b>51</b>	<b>0.9</b>
	12/16/2002	<b>130</b>	<0.5	<b>0.9</b>	<b>4.2</b>	<b>9.9</b>	<b>200</b>	<0.5	<b>57</b>	<b>60</b>	<b>0.9</b>
	3/28/2003	<b>110</b>	<0.5	<0.5	<0.5	<0.5	<b>190</b>	<0.7	<b>53</b>	<b>53</b>	<b>0.9</b>
	6/24/2003	<b>140</b>	<0.5	<0.5	<0.5	<0.5	<b>220</b>	<1.0	<b>58</b>	<b>66</b>	<1.0
	9/26/2003	<b>230</b>	<b>2.9</b>	<b>1.1</b>	<b>3.8</b>	<b>6.71</b>	<b>210</b>	<0.7	<b>60</b>	<b>63</b>	<0.7
	12/16/2003	<b>120</b>	<0.5	<0.5	<0.5	<b>0.65</b>	<b>140</b>	<0.5	<b>44</b>	<b>44</b>	<0.5
	4/6/2004	<b>76</b>	<0.5	<0.5	<0.5	<0.5	<b>160</b>	<0.5	<b>49</b>	<b>54</b>	<0.5
	6/23/2004	<b>99</b>	<0.5	<0.5	<0.5	<0.5	<b>200</b>	<0.5	<b>65</b>	<b>74</b>	<0.5
	9/15/2004	<b>130</b>	<0.5	<0.5	<0.5	<0.5	<b>290</b>	<1.7	<b>73</b>	<b>83</b>	<1.7
	12/16/2004	<b>110</b>	<b>0.94</b>	<0.5	<0.5	<0.5	<b>240</b>	<2.0	<b>80</b>	<b>77</b>	<2.0
	3/22/2005	<b>61</b>	<0.5	<0.5	<0.5	<0.5	<b>95</b>	<0.5	<b>26</b>	<b>42</b>	<0.5
	6/24/2005	<b>59</b>	<0.5	<0.5	<0.5	<0.5	<b>120</b>	<1.0	<b>31</b>	<b>39</b>	<1.0
	9/12/2005	<b>64</b>	<0.5	<0.5	<0.5	<0.5	<b>130</b>	<0.7	<b>34</b>	<b>42</b>	<0.7
12/2/2005	<b>80 Y,Z</b>	<0.5	<0.5	<0.5	<0.5	<b>170</b>	<1.0	<b>43</b>	<b>49</b>	<1.0	
3/2/2006	<b>54 Y Z</b>	<0.5	<0.5	<0.5	<0.5	<b>84</b>	<0.8	<b>27</b>	<b>31</b>	<0.8	
6/15/2006	<b>58 Y,Z</b>	<0.5	<0.5	<0.5	<0.5	<b>99</b>	<0.5	<b>30</b>	<b>38</b>	<0.5	
<b>MW-13</b>	6/28/2002	<b>5,600</b>	<b>120</b>	<b>55</b>	<b>130</b>	<b>9.5</b>	<b>61</b>	<0.5	<b>430</b>	<b>14</b>	<b>4.4</b>
	9/11/2002	<b>4,500</b>	<b>58</b>	<b>7.5</b>	<b>150</b>	<b>14</b>	<b>63</b>	<0.5	<b>410</b>	<b>13</b>	<1.3
	12/16/2002	<b>4,800</b>	<b>90</b>	<0.5	<b>85</b>	<b>24</b>	<b>76</b>	<0.5	<b>250</b>	<b>9.4</b>	<b>1.8</b>

APPENDIX B

HISTORICAL GROUNDWATER ANALYTICAL RESULTS  
 FORMER LEMOINE SAUSAGE FACTORY  
 630 29TH AVENUE  
 OAKLAND, CALIFORNIA



Sample Location	Date Sampled	TPH-g	Benzene	Toluene	Ethylbenzene	Total Xylenes	TCE	1,2-DCA	cis-1,2-DCE	trans-1,2-DCE	VC
		ug/L	ug/L	ug/L	ug/L	ug/L	ug/L	ug/L	ug/L	ug/L	ug/L
	RWQCB ESL	100	1	40	30	20	5	0.5	6	10	0.5
	DHS MCL	-	1	150	300	1750	5	0.5	6	10	0.5
MW-13	3/28/2003	4,400	55	<0.5	51	14.3	85	<0.5	150	13	1.8
	6/24/2003	8,300	100	<0.5	94	12	68	<1.0	250	19	4.2
	9/26/2003	7,200	150	<1.0	89	57	51	<1.0	270	23	5.1
	12/16/2003	8,100	120	36	72	26.6	66	<0.7	240	23	10
	4/6/2004	3,300	22	<1.0	37	9.0	90	<0.5	190	23	8
	6/23/2004	7,000	140	25	88	21	53	<2.0	350	31	25
	9/15/2004	6,700	84	<1.0	78	7.2	37	<1.7	300	40	31
	12/16/2004	4,300	61	<0.5	44	11.5	69	<2.0	240	32	15
	3/22/2005	3,000	24	<0.5	20	7.6	72	<0.5	120	23	6.6
	6/24/2005	2,600	63	<0.5	25	4.3	42	<1.0	150	36	16
	9/12/2005	2,500	20 C	<0.5	33	6.7 c	25	<1.3	170	38	22
	12/2/2005	4,200 Y	70 C	<0.5	21 C	15.5 C	17	<1.3	140	40	24
	3/2/2006	3,200 L Y	67 C	<0.5	27	5.19 C	43	<0.8	110	32	16
6/15/2006	3,400	92 C	<0.5	26	3.4 C	43	<0.8	120	39	18	

**Notes:**

- All results are reported in micrograms per liter (µg/L).
- NA refers to Not Analyzed.
- NS refers to Not Sampled.
- TPH-g refers to Total Petroleum Hydrocarbons as Gasoline.
- MTBE refers to Methyl tert-butyl ether.
- TCE refers to Trichloroethene.
- trans-1,2-DCE refers to trans-1,2-dichloroethene.
- cis-1,2-DCE refers to cis-1,2-Dichloroethene.
- VC refers to Vinyl Chloride.
- 1,2-DCA refers to 1,2-dichloroethane.
- Z=Sample exhibits unknown single peak or peaks.
- C=Presence confirmed, but RPD between columns exceed 40%.
- L=Lighter hydrocarbons contributed to the quantitation.
- RWQCB ESL refers to the California Regional Water Quality Control Board Environmental Screening Level for shallow soils less than 10 feet deep assuming groundwater is a current or potential source of drinking water, as presented in Table A of the RWQCB ESLs (2005).
- DHS MCL refers to California Department of Health Services Maximum Contaminant Level.

**APPENDIX B**

**HISTORICAL GROUNDWATER ANALYTICAL RESULTS  
FORMER LEMOINE SAUSAGE FACTORY  
630 29TH AVENUE  
OAKLAND, CALIFORNIA**



Sample Location	Date Sampled	TPH-g	Benzene	Toluene	Ethylbenzene	Total Xylenes	TCE	1,2-DCA	cis-1,2-DCE	trans-1,2-DCE	VC
		ug/L	ug/L	ug/L	ug/L	ug/L	ug/L	ug/L	ug/L	ug/L	ug/L
	RWQCB ESL	100	1	40	30	20	5	0.5	6	10	0.5
	DHS MCL	-	1	150	300	1750	5	0.5	6	10	0.5

11. Y=Sample exhibits chromatographic pattern which does not resemble standard.