

**RECEIVED**

2:40 pm, Jan 29, 2008

Alameda County  
Environmental Health



November 2, 2007

Ms. Donna Drogos, P.E.  
Supervising Hazardous Materials Specialist  
ALAMEDA COUNTY ENVIROMENTAL HEALTH  
1131 Harbor Bay Parkway, Suite 250  
Alameda, California 94502-6577

Bureau Veritas Project No.33104-004578.00

**Subject: Third Quarter 2007 Groundwater Monitoring Report  
Former Lemoine Sausage Factory  
630 29<sup>th</sup> Avenue  
Oakland, California**

Dear Ms. Drogos:

Bureau Veritas North America, Inc., *formerly Clayton Group Services* (Bureau Veritas) is pleased to present the results of the Third Quarter 2007 groundwater monitoring event performed at the Former Lemoine Sausage Factory, located at 630 29<sup>th</sup> Avenue in Oakland, California.

I declare, under penalty of perjury, that the information and/or recommendations contained in this attached report are true and correct to the best of my knowledge and belief. If you have any comments or questions regarding the report, please do not hesitate to contact Timothy Bodkin at (925) 426-2626.

Sincerely,

Jeremy V. Wilson  
Environmental Consultant  
Environmental Services

Timothy G. Bodkin, C.E.G., R.E.A.  
Senior Project Manager  
Environmental Services

JVW/tgb

cc: Bob Pender, AIG Technical Services  
Donna Proffitt, Bank of America  
Richard Tong, Bureau Veritas North America, Inc.

**Bureau Veritas North America, Inc.**

*Clayton Group Services*  
6920 Koll Center Parkway, Suite 216  
Pleasanton, CA 94566

Main (925) 426-2600  
Fax (925) 426-0106  
[www.us.bureauveritas.com](http://www.us.bureauveritas.com)

# ***Third Quarter 2007*** **Groundwater Monitoring Report**

Former Lemoine Sausage Factory  
630 29<sup>th</sup> Avenue  
Oakland, California

November 2, 2007  
33104-004578.00

Prepared for:  
**AIG Technical Services, Inc.**  
80 Pine Street, 6<sup>th</sup> Floor  
New York, New York 10005



For the benefit of business and people

**Bureau Veritas North America, Inc.**  
6920 Koll Center Parkway, Suite 216  
Pleasanton, California 94566  
925.426.2600  
[www.us.bureauveritas.com](http://www.us.bureauveritas.com)



## CONTENTS

<u>Section</u>	<u>Page</u>
<b>1.0 INTRODUCTION</b> .....	<b>1</b>
<b>2.0 SITE DESCRIPTION AND HISTORY</b> .....	<b>1</b>
<b>3.0 FIELD ACTIVITIES</b> .....	<b>1</b>
3.1. GROUNDWATER LEVEL MEASUREMENTS .....	2
3.2. GROUNDWATER PURGING.....	2
3.4 LABORATORY ANALYSES.....	3
<b>4.0 FINDINGS</b> .....	<b>3</b>
4.1. GROUNDWATER FLOW CONDITIONS .....	3
4.2. ANALYTICAL RESULTS .....	3
<b>5.0 CONCLUSIONS</b> .....	<b>4</b>

### Tables

1. Historical Groundwater Elevation Data
2. Historical Groundwater Analytical Results

### Figures

1. Property Location Map
2. Groundwater Elevation Map, Third Quarter 2007
3. TPH-g Concentrations in Groundwater, Third Quarter 2007
4. Benzene Concentrations in Groundwater, Third Quarter 2007
5. TCE and cis-1,2- DCE Concentrations in Groundwater, Third Quarter 2007

### Appendices

- A. Field Sampling Data Sheets
- B. Chain-of-Custody Documentation and Certified Analytical Reports



## **1.0 INTRODUCTION**

Bureau Veritas North America, Inc. (Bureau Veritas), *formerly Clayton Group Services*, has prepared the following Third Quarter 2007 Groundwater Monitoring Report for the former Lemoine Sausage Factory. The site is located at 630 29<sup>th</sup> Avenue near its intersection with 7<sup>th</sup> Street in Oakland, California (Figure 1). Groundwater monitoring is being performed at this site on a quarterly basis in accordance with an Alameda County Environmental Health (ACEH) letter dated June 19, 1999. Groundwater monitoring has been required due to past releases from a gasoline underground storage tank (UST) previously located beneath the sidewalk adjacent to the site.

The purpose of the groundwater monitoring is to document groundwater flow conditions and water quality beneath the site. Depth to groundwater measurements were obtained and groundwater samples were collected and analyzed for total petroleum hydrocarbons as gasoline (TPH-g) and associated compounds, including benzene, toluene, ethylbenzene and total xylenes (BTEX), and volatile organic compounds (VOCs).

## **2.0 SITE DESCRIPTION AND HISTORY**

A single 1,000-gallon gasoline UST and associated plumbing/piping were formerly located beneath the sidewalk along 7<sup>th</sup> Street immediately east of the subject building. The fuel dispenser for the UST was located in a “cubby hole” near the building’s roll-up door. The UST, fuel dispenser, and associated piping were removed on November 21, 1996. Confirmation soil samples were collected from the excavation for laboratory analyses. A petroleum hydrocarbon sheen was noted on groundwater that collected in the tank excavation. Analytical results showed the presence of petroleum hydrocarbons in the confirmation samples.

Subsequent groundwater investigations were performed to define the vertical and lateral extent of petroleum hydrocarbons in groundwater and to monitor groundwater conditions around the site. Several monitoring wells were installed and screened within the first-encountered water bearing zone, which predominantly occurs within low permeability clayey and sandy silts. The highest concentrations of TPH-g and benzene have been detected in the immediate vicinity or just downgradient of the former UST. VOCs have also been detected in monitoring wells located to the south and southwest of the former UST location and are believed to originate from an off-site source.

## **3.0 FIELD ACTIVITIES**

Groundwater level measurements and samples were obtained from nine (9) of ten (10) existing monitoring wells (MW-1, MW-2, MW-6 through MW-10, MW12, and MW-13). Groundwater level measurements and samples were not collected from Well MW-11 because a vehicle covering the well location made it inaccessible to collect measurements and samples.



### **3.1. GROUNDWATER LEVEL MEASUREMENTS**

On September 17, 2007, depth to water measurements were obtained in the monitoring wells to calculate groundwater elevations and to estimate the groundwater flow direction and gradient. The wells were opened and allowed to stabilize prior to measuring the groundwater levels. The depth to water in each well was measured using an electronic well sounder. Groundwater depths were measured from a surveyed reference elevation point represented by a V-notch at the top of each casing. Groundwater elevations were calculated by subtracting the measured depth to water from the top of casing elevation at each monitoring well.

### **3.2. GROUNDWATER PURGING**

Prior to groundwater sample collection at each monitoring well, approximately three well casing volumes of standing water were removed with the exception of Wells MW-1 and MW-2, which were not purged because of the lack of sufficient water within the wells and poor groundwater recharge after purging. Wells MW-6 through MW-13 were purged by hand bailing with 1-liter plastic disposable bailers.

The purge volume from each monitoring well was determined by multiplying the nominal cross-sectional area of the well casing by the water column within each well casing. The water column height in each well was determined by subtracting the depth to water from the total well casing depth. Water quality parameters (pH, specific conductivity, and temperature) were measured and recorded onto Field Sampling Data Sheets. Water quality parameter measurements were taken prior to purging and after removing each well casing volume of water from each monitoring well.

Groundwater purged from monitoring wells was stored onsite in sealed 55-gallon drums and labeled with identifying information. Groundwater level measurements for the Third Quarter 2007 monitoring event were recorded on Field Sampling Data Sheets, as presented in Appendix A.

### **3.3 GROUNDWATER SAMPLING**

Before groundwater sampling commenced, each purged monitoring well was allowed to recharge to at least 80% of the pre-purged standing water volume, except for Wells MW-1 and MW-2 for the reasons stated above. Groundwater samples for laboratory analyses were retrieved using either a peristaltic pump equipped with polytubing or a new disposable bailer. Groundwater samples were poured into appropriate laboratory-supplied containers. Sample containers were sealed, labeled with identifying project information, logged onto a chain-of-custody document, and temporarily stored in a chilled ice chest containing crushed ice for transport to the laboratory.



### **3.4 LABORATORY ANALYSES**

Groundwater samples were analyzed by Curtis and Tompkins Ltd. of Berkeley, California, a State of California-certified laboratory. The samples were analyzed by the following United States Environmental Protection Agency (USEPA) approved analytical methods:

- USEPA Method 8021B for TPH-g/BTEX
- USEPA Method 8260B for VOCs

Certified analytical data sheets and chain-of-custody documentation for the Third Quarter 2007 groundwater sampling event are presented in Appendix B.

## **4.0 FINDINGS**

### **4.1. GROUNDWATER FLOW CONDITIONS**

Groundwater flow conditions were assessed based upon the groundwater level measurements obtained in the wells. Groundwater depths ranged between 6.39 and 10.85 feet below the tops of well casings. Groundwater elevations ranged between 6.74 and 10.44 feet above mean sea level. Groundwater flow is in a westerly direction at an estimated gradient of 0.015 feet per foot (ft/ft). Depth to water measurements and groundwater elevation data from this event and previous events are presented in Table 1. The Third Quarter 2007 groundwater elevation map is presented on Figure 2.

### **4.2. ANALYTICAL RESULTS**

Analytical results for groundwater showed the presence of petroleum hydrocarbons and VOCs. The frequency and range of petroleum hydrocarbons and VOCs detected in groundwater during this quarter are as follows:

- TPH-g was detected in Wells MW-1, MW-2, MW-8, MW-9, MW-12, and MW-13 at concentrations ranging between 84 and 19,000 micrograms per liter ( $\mu\text{g/L}$ ).
- Benzene was detected in Wells MW-1, MW-2, MW-8, MW-9, and MW-13 at concentrations ranging between 52 and 9,600  $\mu\text{g/L}$ .
- Toluene was detected in Wells MW-1, MW-2, MW-9, and MW-13 at concentrations ranging between 4.0 and 410  $\mu\text{g/L}$ . This is the first detection of toluene in Well MW-13 since the Second Quarter 2004 monitoring event.
- Ethylbenzene was detected in Wells MW-1, MW-2, MW-8, MW-9, and MW-13 at concentrations ranging between 25 and 1,100  $\mu\text{g/L}$ .
- Total xylenes were detected in Wells MW-1, MW-2, MW-9, and MW-13 at concentrations ranging between 8.2 and 2,540  $\mu\text{g/L}$ .



- Trichloroethene (TCE) was detected in Wells MW-12 and MW-13 at 160 and 11  $\mu\text{g/L}$ , respectively.
- Cis-1,2-dichloroethene (cis-1,2-DCE) was detected in Wells MW-8, MW-12, and MW-13 at concentrations of 900, 61, and 56  $\mu\text{g/L}$ , respectively.
- Trans-1,2-dichloroethene (trans-1,2-DCE) was detected in Wells MW-8, MW-12, and MW-13 at concentrations ranging between 28 and 65  $\mu\text{g/L}$ .
- Vinyl chloride (VC) was detected in Wells MW-8 and MW-13 at 91 and 11  $\mu\text{g/L}$ , respectively.
- Bromodichloromethane and chloroethane were detected in Well MW-13 at concentrations of 4.3 and 2.1  $\mu\text{g/L}$ , respectively.

Historical groundwater analytical results for petroleum hydrocarbons and VOCs detected in groundwater are presented in Table 2. TPH-g and benzene concentrations detected in groundwater and isoconcentration contours for these constituents detected during Third Quarter 2007 are presented on Figures 3 and 4, respectively. TCE and cis-1,2-DCE concentrations detected in groundwater during Third Quarter 2007 are presented in Figure 5.

## **5.0 CONCLUSIONS**

Groundwater conditions for Third Quarter 2007 are relatively consistent with the trends noted during previous monitoring events. TPH-g and BTEX concentrations detected in groundwater have slightly decreased and remain similar in comparison with the analytical results from the previous event with the exception of Well MW-8, where the TPH-g and benzene concentrations increased. The highest concentrations of TPH-g and benzene were detected in Wells MW-2 and MW-9, which are both located within the central portion of the subject building downgradient of the former UST location. The lateral extent of the hydrocarbon plume is roughly defined by the concentrations detected in Wells MW-1, MW-12, and MW-13, which are located in areas to the north, west, and south.



VOCs detected in groundwater during the Third Quarter 2007 monitoring event include TCE and associated degradation compounds, including cis-1,2-DCE, trans-1,2-DCE, and VC. VOC concentrations were detected in Wells MW-8, MW-12, and MW-13, which are located downgradient from the site. VOC concentrations detected during this monitoring event are similar with the concentrations detected during the previous event. The source of the VOCs in groundwater is unknown and appears to originate from an offsite source. On this basis, the VOC concentrations in groundwater are not related to the UST release. The presence of the various degradation compounds, as well as the changes in VOC concentrations over the past several monitoring events, indicate that degradation of the TCE is occurring. No additional investigation of the TPH- and VOC-impacted groundwater is recommended.

Report prepared by: 

Jeremy V. Wilson  
Environmental Consultant  
Environmental Services

Report reviewed by: 

Timothy G. Bodkin, C.E.G., R.E.A.  
Senior Project Manager  
Environmental Services



November 2, 2007





## **TABLES**



**TABLE 1**

**HISTORICAL GROUNDWATER ELEVATION DATA  
FORMER LEMOINE SAUSAGE FACTORY  
630 29TH AVENUE  
OAKLAND, CALIFORNIA**

<b>Well Identification</b>	<b>Date Measured</b>	<b>Top of Casing Elevation (ft,msl)</b>	<b>Depth to Water (feet)</b>	<b>Groundwater Elevation (ft,msl)</b>
<b>MW-1</b>	2/8/1999	16.69	3.60	13.09
	6/15/2000	16.69	4.82	11.87
	9/22/2000	16.69	6.30	10.39
	12/19/2000	16.69	5.50	11.19
	3/21/2001	16.69	4.29	12.40
	6/20/2001	16.69	5.85	10.84
	9/25/2001	16.69	6.76	9.93
	12/3/2001	16.69	4.17	12.52
	3/25/2002	16.69	2.77	13.92
	6/28/2002	16.69	5.61	11.08
	9/11/2002	16.69	6.17	10.52
	12/16/2002	16.69	3.91	12.78
	3/28/2003	16.69	4.44	12.25
	6/24/2003	16.69	5.29	11.40
	9/26/2003	16.69	6.88	9.81
	12/16/2003	16.69	NM	NM
	4/6/2004	16.69	3.57	13.12
	6/23/2004	16.69	5.96	10.73
	9/15/2004	16.69	NM	NM
	12/16/2004	16.69	4.40	12.29
	3/22/2005	16.69	3.44	13.25
	6/24/2005	16.69	4.45	12.24
	9/13/2005	16.69	6.03	10.66
	12/2/2005	16.69	4.95	11.74
3/2/2006	16.69	3.74	12.95	
6/15/2006	16.69	4.58	12.11	
9/14/2006	16.69	5.15	11.54	
1/11/2007	16.69	4.01	12.68	
4/9/2007	16.69	4.67	12.02	
9/17/2007	16.69	6.39	10.30	
<b>MW-2</b>	2/8/1999	20.79	14.20	6.59
	6/15/2000	20.79	10.46	10.33
	9/22/2000	20.79	11.49	9.30
	12/19/2000	20.79	11.38	9.41
	3/21/2001	20.79	10.01	10.78
	6/20/2001	20.79	10.92	9.87
	9/25/2001	20.79	11.78	9.01
	12/3/2001	20.79	11.13	9.66
	3/25/2002	20.79	9.21	11.58
	6/28/2002	20.79	10.65	10.14
	9/11/2002	20.79	10.89	9.90
	12/16/2002	20.79	11.15	9.64
	3/28/2003	20.79	10.27	10.52



TABLE 1

HISTORICAL GROUNDWATER ELEVATION DATA  
 FORMER LEMOINE SAUSAGE FACTORY  
 630 29TH AVENUE  
 OAKLAND, CALIFORNIA

Well Identification	Date Measured	Top of Casing Elevation (ft,msl)	Depth to Water (feet)	Groundwater Elevation (ft,msl)
<b>MW-2</b>	6/24/2003	20.79	10.24	10.55
	9/26/2003	20.79	11.20	9.59
	12/16/2003	20.79	11.50	9.29
	4/6/2004	20.79	9.40	11.39
	6/23/2004	20.79	11.60	9.19
	9/15/2004	20.79	10.94	9.85
	12/16/2004	20.79	NM	NM
	3/22/2005	20.79	9.26	11.53
	6/24/2005	20.79	10.03	10.76
	9/13/2005	20.79	10.58	10.21
	12/2/2005	20.79	NM	NM
	3/2/2006	20.79	9.45	11.34
	6/15/2006	20.79	9.84	10.95
	9/14/2006	20.79	10.27	10.52
	1/11/2007	20.79	10.45	10.34
4/9/2007	20.79	10.03	10.76	
9/17/2007	20.79	10.85	9.94	
<b>MW-3</b>	2/8/1999	21.10	7.45	13.65
	6/15/2000	21.10	10.56	10.54
	9/22/2000	21.10	15.30	5.80
	12/19/2000	21.10	9.72	11.38
	3/21/2001	21.10	8.95	12.15
	6/20/2001	21.10	10.14	10.96
	9/25/2001	21.10	10.74	10.36
	Removed from monitoring program in October 2001			
<b>MW-4</b>	2/8/1999	17.78	4.13	13.65
	6/15/2000	17.78	6.30	11.48
	9/22/2000	17.78	6.90	10.88
	12/19/2000	17.78	6.40	11.38
	3/21/2001	17.78	5.77	12.01
	6/20/2001	17.78	6.78	11.00
	9/25/2001	17.78	7.40	10.38
	Removed from monitoring program in October 2001			
<b>MW-5</b>	2/8/1999	21.12	7.62	13.50
	6/15/2000	21.12	10.36	10.76
	9/22/2000	21.12	9.99	11.13
	12/19/2000	21.12	9.99	11.13
	3/21/2001	21.12	8.68	12.44
	6/20/2001	21.12	9.90	11.22
	9/25/2001	21.12	10.34	10.78
	Removed from monitoring program in October 2001			



TABLE 1

HISTORICAL GROUNDWATER ELEVATION DATA  
 FORMER LEMOINE SAUSAGE FACTORY  
 630 29TH AVENUE  
 OAKLAND, CALIFORNIA

Well Identification	Date Measured	Top of Casing Elevation (ft,msl)	Depth to Water (feet)	Groundwater Elevation (ft,msl)
MW-6	6/15/2000	16.60	5.47	11.13
	9/22/2000	16.60	6.54	10.06
	12/19/2000	16.60	5.93	10.67
	3/21/2001	16.60	4.70	11.90
	6/20/2001	16.60	6.13	10.47
	9/25/2001	16.60	6.68	9.92
	12/3/2001	16.60	4.72	11.88
	3/25/2002	16.60	3.93	12.67
	6/28/2002	16.60	5.83	10.77
	9/11/2002	16.60	5.43	11.17
	12/16/2002	16.60	3.93	12.67
	3/28/2003	16.60	NM	NM
	6/24/2003	16.60	5.52	11.08
	9/26/2003	16.60	6.70	9.90
	12/16/2003	16.60	4.99	11.61
	4/6/2004	16.60	4.85	11.75
	6/23/2004	16.60	5.76	10.84
	9/15/2004	16.60	6.56	10.04
	12/16/2004	16.60	4.56	12.04
	3/22/2005	16.60	3.63	12.97
	6/24/2005	16.60	4.84	11.76
	9/13/2005	16.60	6.15	10.45
	12/2/2005	16.60	5.24	11.36
	3/2/2006	16.60	3.41	13.19
	6/15/2006	16.60	5.09	11.51
	9/14/2006	16.60	5.68	10.92
1/11/2007	16.60	4.71	11.89	
4/9/2007	16.60	5.25	11.35	
9/17/2007	16.60	6.56	10.04	
MW-7	12/16/2002	15.47	5.01	10.46
	12/17/2002	15.47	6.95	8.52
	12/18/2002	15.47	6.94	8.53
	12/19/2002	15.47	6.04	9.43
	12/20/2002	15.47	6.48	8.99
	12/21/2002	15.47	7.25	8.22
	12/22/2002	15.47	6.90	8.57
	12/23/2002	15.47	5.53	9.94
	12/24/2002	15.47	7.20	8.27
	12/25/2002	15.47	7.51	7.96
	12/26/2002	15.47	6.40	9.07
	3/28/2003	15.47	5.68	9.79
	6/24/2003	15.47	6.13	9.34
	9/26/2003	15.47	7.22	8.25
	12/16/2003	15.47	5.68	9.79



TABLE 1

HISTORICAL GROUNDWATER ELEVATION DATA  
 FORMER LEMOINE SAUSAGE FACTORY  
 630 29TH AVENUE  
 OAKLAND, CALIFORNIA

Well Identification	Date Measured	Top of Casing Elevation (ft,msl)	Depth to Water (feet)	Groundwater Elevation (ft,msl)
MW-7	4/6/2004	15.47	5.60	9.87
	6/23/2004	15.47	6.20	9.27
	9/15/2004	15.47	6.70	8.77
	12/16/2004	15.47	5.15	10.32
	3/22/2005	15.47	NM	NM
	6/24/2005	15.47	NM	NM
	9/13/2005	15.47	6.45	9.02
	12/2/2005	15.47	5.93	9.54
	3/2/2006	15.47	4.65	10.82
	6/15/2006	15.47	5.71	9.76
	9/14/2006	15.47	6.10	9.37
	1/11/2007	15.47	6.04	9.43
	4/9/2007	15.47	5.68	9.79
	9/17/2007	15.47	6.93	8.54
MW-8	6/15/2000	17.58	7.14	10.44
	9/22/2000	17.58	8.33	9.25
	12/19/2000	17.58	7.71	9.87
	3/21/2001	17.58	6.40	11.18
	6/20/2001	17.58	7.96	9.62
	9/25/2001	17.58	8.89	8.69
	12/3/2001	17.58	6.58	11.00
	3/25/2002	17.58	5.40	12.18
	6/28/2002	17.58	7.71	9.87
	9/11/2002	17.58	8.40	9.18
	12/16/2002	17.58	5.63	11.95
	3/28/2003	17.58	6.62	10.96
	6/24/2003	17.58	7.44	10.14
	9/26/2003	17.58	8.71	8.87
	12/16/2003	17.58	6.69	10.89
	4/6/2004	17.58	6.74	10.84
	6/23/2004	17.58	7.98	9.60
	9/15/2004	17.58	8.52	9.06
	12/16/2004	17.58	5.61	11.97
	3/22/2005	17.58	5.54	12.04
	6/24/2005	17.58	6.77	10.81
	9/13/2005	17.58	7.92	9.66
	12/2/2005	17.58	7.36	10.22
	3/2/2006	17.58	5.83	11.75
6/15/2006	17.58	6.99	10.59	
9/14/2006	17.58	7.58	10.00	
1/11/2007	17.58	6.30	11.28	
4/9/2007	17.58	7.05	10.53	
9/17/2007	17.58	8.26	9.32	



TABLE 1

HISTORICAL GROUNDWATER ELEVATION DATA  
FORMER LEMOINE SAUSAGE FACTORY  
630 29TH AVENUE  
OAKLAND, CALIFORNIA

Well Identification	Date Measured	Top of Casing Elevation (ft,msl)	Depth to Water (feet)	Groundwater Elevation (ft,msl)
MW-9	12/3/2001	17.61	5.79	11.82
	3/25/2002	17.61	4.98	12.63
	6/28/2002	17.61	7.71	9.90
	9/11/2002	17.61	6.91	10.70
	12/16/2002	17.61	6.58	11.03
	3/28/2003	17.61	6.08	11.53
	6/24/2003	17.61	6.42	11.19
	9/26/2003	17.61	8.14	9.47
	12/16/2003	17.61	6.76	10.85
	4/6/2004	17.61	5.97	11.64
	6/23/2004	17.61	7.80	9.81
	9/15/2004	17.61	7.14	10.47
	12/16/2004	17.61	5.73	11.88
	3/22/2005	17.61	5.31	12.30
	6/24/2005	17.61	6.05	11.56
	9/13/2005	17.61	6.70	10.91
	12/2/2005	17.61	6.92	10.69
	3/2/2006	17.61	5.83	11.78
	6/15/2006	17.61	6.32	11.29
9/14/2006	17.61	6.79	10.82	
1/11/2007	17.61	5.59	12.02	
4/9/2007	17.61	6.35	11.26	
9/17/2007	17.61	7.26	10.35	
MW-10	12/3/2001	16.92	4.22	12.70
	3/25/2002	16.92	3.00	13.92
	6/28/2002	16.92	5.65	11.27
	9/11/2002	16.92	6.16	10.76
	12/16/2002	16.92	3.74	13.18
	3/28/2003	16.92	4.54	12.38
	6/24/2003	16.92	5.40	11.52
	9/26/2003	16.92	6.98	9.94
	12/16/2003	16.92	4.94	11.98
	4/6/2004	16.92	4.54	12.38
	6/23/2004	16.92	5.96	10.96
	9/15/2004	16.92	6.86	10.06
	12/16/2004	16.92	4.45	12.47
	3/22/2005	16.92	3.56	13.36
	6/24/2005	16.92	4.58	12.34
	9/12/2005	16.92	6.08	10.84
	12/2/2005	16.92	4.94	11.98
	3/2/2006	16.92	3.90	13.02
	6/15/2006	16.92	4.74	12.18
9/14/2006	16.92	5.27	11.65	
1/11/2007	16.92	4.37	12.55	



TABLE 1

HISTORICAL GROUNDWATER ELEVATION DATA  
 FORMER LEMOINE SAUSAGE FACTORY  
 630 29TH AVENUE  
 OAKLAND, CALIFORNIA

Well Identification	Date Measured	Top of Casing Elevation (ft,msl)	Depth to Water (feet)	Groundwater Elevation (ft,msl)
MW-10	4/9/2007	16.92	4.81	12.11
	9/17/2007	16.92	6.48	10.44
MW-11	12/3/2001	14.87	5.67	9.20
	3/25/2002	14.87	4.68	10.19
	6/28/2002	14.87	6.35	8.52
	9/11/2002	14.87	6.91	7.96
	12/16/2002	14.87	3.92	10.95
	3/28/2003	14.87	5.17	9.70
	6/24/2003	14.87	5.86	9.01
	9/26/2003	14.87	7.16	7.71
	12/16/2003	14.87	5.61	9.26
	4/6/2004	14.87	5.49	9.38
	6/23/2004	14.87	5.68	9.19
	12/16/2004	14.87	4.69	10.18
	3/22/2005	14.87	4.20	10.67
	6/24/2005	14.87	5.41	9.46
	9/13/2005	14.87	6.23	8.64
	9/15/2005	14.87	6.45	8.42
	12/2/2005	14.87	5.95	8.92
	3/2/2006	14.87	4.31	10.56
	6/15/2006	14.87	5.40	9.47
	9/14/2006	14.87	5.94	8.93
1/11/2007	14.87	5.45	9.42	
4/9/2007	14.87	5.52	9.35	
9/17/2007	14.87	NM	NM	
MW-12	6/28/2002	14.05	6.13	7.92
	9/11/2002	14.05	6.82	7.23
	12/16/2002	14.05	4.94	9.11
	3/28/2003	14.05	5.08	8.97
	6/24/2003	14.05	5.73	8.32
	9/26/2003	14.05	6.94	7.11
	12/16/2003	14.05	4.99	9.06
	4/6/2004	14.05	5.04	9.01
	6/23/2004	14.05	5.78	8.27
	9/15/2004	14.05	6.43	7.62
	12/16/2004	14.05	4.34	9.71
	3/22/2005	14.05	3.50	10.55
	6/24/2005	14.05	4.9	9.15
	9/12/2005	14.05	6.11	7.94
	12/2/2005	14.05	5.13	8.92
	3/2/2006	14.05	3.83	10.22
	6/15/2006	14.05	5.18	8.87
9/14/2006	14.05	5.86	8.19	



TABLE 1

HISTORICAL GROUNDWATER ELEVATION DATA  
 FORMER LEMOINE SAUSAGE FACTORY  
 630 29TH AVENUE  
 OAKLAND, CALIFORNIA

Well Identification	Date Measured	Top of Casing Elevation (ft,msl)	Depth to Water (feet)	Groundwater Elevation (ft,msl)
MW-12	1/11/2007	14.05	6.97	7.08
	4/9/2007	14.05	5.31	8.74
	9/17/2007	14.05	6.59	7.46
MW-13	6/28/2002	13.39	6.21	7.18
	9/11/2002	13.39	6.66	6.73
	12/16/2002	13.39	3.90	9.49
	3/28/2003	13.39	5.34	8.05
	6/24/2003	13.39	5.99	7.40
	9/26/2003	13.39	6.99	6.40
	12/16/2003	13.39	5.01	8.38
	4/6/2004	13.39	5.35	8.04
	6/23/2004	13.39	6.12	7.27
	9/15/2004	13.39	6.63	6.76
	12/16/2004	13.39	4.69	8.70
	3/22/2005	13.39	4.86	8.53
	6/24/2005	13.39	5.13	8.26
	9/12/2005	13.39	6.33	7.06
	12/2/2005	13.39	5.25	8.14
	3/2/2006	13.39	4.33	9.06
	6/15/2006	13.39	5.44	7.95
9/14/2006	13.39	6.03	7.36	
1/11/2007	13.39	5.41	7.98	
4/9/2007	13.39	5.71	7.68	
9/17/2007	13.39	6.65	6.74	

**Notes:**

1. All top of casing elevations referenced to mean sea level (msl) and surveyed with reference to the benchmark located at Peterson Street and East 7<sup>th</sup> Street.
2. NM refers to Not Measured.
3. ft, msl refers to feet above mean sea level.



TABLE 2

**HISTORICAL GROUNDWATER ANALYTICAL RESULTS  
FORMER LEMOINE SAUSAGE FACTORY  
630 29TH AVENUE  
OAKLAND, CALIFORNIA**



Well Location	Date Sampled	TPH-g (ug/L)	Benzene (ug/L)	Toluene (ug/L)	Ethylbenzene (ug/L)	Total Xylenes (ug/L)	TCE (ug/L)	1,2-DCA (ug/L)	cis-1,2-DCE (ug/L)	trans-1,2-DCE (ug/L)	VC (ug/L)	
MW-1	2/8/1999	48,000	3,900	6,300	970	4,300	NA	<30	NA	NA	NA	
	6/15/2000	29,000	3,900	<100	1,900	4,200	<5.0	<5.0	<5.0	<5.0	<5.0	
	9/22/2000	25,000	3,100	1,800	470	3,600	NA	NA	NA	NA	NA	
	12/19/2000	25,000	3,200	1,900	480	3,300	<2.5	<2.5	<2.5	<2.5	<2.5	
	3/21/2000	21,000	3,200	1,700	290	2,600	<2.5	<2.5	<2.5	<2.5	<2.5	
	6/21/2001	12,000	2,000	880	180	1,180	<0.5	3.0	<0.5	<0.5	<0.5	
	9/26/2001	16,000	1,100	130	< 10	320	< 2.5	< 2.5	< 2.5	< 2.5	< 2.5	
	12/3/2001	15,000	2,800	1,200	310	1,660	<3.1	<3.1	<3.1	<3.1	<3.1	
	3/25/2002	11,000	3,200	1,200	73	1,860	<5	<5	<5	<5	<5	
	6/28/2002	26,000	3,200	1,800	640	2,900	<3.1	<3.1	<3.1	<3.1	<3.1	
	9/11/2002	27,000	3,200	1,900	720	3,500	<4.2	<4.2	<4.2	<4.2	<4.2	
	12/16/2002	20,000	2,800	490	500	2,300	<4.2	<4.2	<4.2	<4.2	<4.2	
	3/28/2003	20,000	2,700	1,500	650	2,300	<3.6	<3.6	<3.6	<3.6	<3.6	
	6/24/2003	14,000	2,400	1,400	500	2,100	<4.2	<4.2	<4.2	<4.2	<4.2	
	9/26/2003	11,000	1,200	960	370	1,600	<1.0	<1.0	<1.0	<1.0	<1.0	
	12/16/2003	Not Sampled										
	4/6/2004	18,000	2,400	1,300	550	1,730	<2.0	<2.0	<2.0	<2.0	<2.0	
	6/23/2004	25,000	2,700	1,700	680	2,300	<2.5	<2.5	<2.5	<2.5	<2.5	
	9/15/2004	Not Sampled										
	12/16/2004	1,800	260	89	32	119	<2.5	<2.5	<2.5	<2.5	<2.5	
	3/22/2005	19,000	2,400	960	530	1,330	<3.6	<3.6	<3.6	<3.6	<3.6	
	6/24/2005	12,000	2,400	450	470	940	<3.6	<3.6	<3.6	<3.6	<3.6	
	9/13/2005	17,000	2,700	1,000	740	1,760	<1.0	<1.0	<1.0	<1.0	<1.0	
	12/2/2005	9,300	1,500	500	420	1,060	<3.6	<3.6	<3.6	<3.6	<3.6	
	3/2/2006	6,200	1,400	200	180	370	<3.6	<3.6	<3.6	<3.6	<3.6	
	6/15/2006	10,000	2,500	200	440	570	<4.2	<4.2	<4.2	<4.2	<4.2	
9/14/2006	13,000	2,300	320	450	870	<4.2	<4.2	<4.2	<4.2	<4.2		
1/11/2007	14,000	1,200	270	450	850	<2.0	<2.0	<2.0	<2.0	<2.0		
4/9/2007	12,000	1,800	270	520	750	<2.0	<2.0	<2.0	<2.0	<2.0		
9/17/2007	9,000	1,200	230	450	471	<2.0	<2.0	<2.0	<2.0	<2.0		
MW-2	2/8/1999	41,000	11,000	4,900	650	1,720	NA	60	NA	NA	NA	
	6/29/2000	31,000	11,000	930	4,400	250	<5.0	25	<5.0	<5.0	<5.0	
	9/22/2000	24,000	10,000	2,700	370	1,200	NA	NA	NA	NA	NA	
	12/19/2000	43,000	9,800	4,000	810	2,430	<13	21	<13	<13	<13	
	3/23/2001	34,000	10,000	3,200	410	1,220	<13	14	<13	<13	<13	
	6/21/2001	30,000	8,600	2,600	440	1,230	<0.5	5.6	<0.5	<0.5	<0.5	
	9/26/2001	26,000	12,000	3,900	590	1,960	< 10	11	< 10	< 10	< 10	
	12/3/2001	45,000	13,000	5,100	950	2,930	<7.1	14	<7.1	<7.1	<7.1	
	3/25/2002	21,000	11,000	3,700	1,000	2,790	<17	<17	<17	<17	<17	
	6/28/2002	8,400	2,200	680	21	220	<3.1	8.8	<3.1	<3.1	<3.1	
	9/11/2002	23,000	6,600	1,000	600	1,320	<6.3	10	<6.3	<6.3	<6.3	
	12/16/2002	6,000	1,600	410	150	402	4.5	2.7	69	6.9	<2.5	
	3/28/2003	30,000	9,300	920	930	2,000	<13	14	<13	<13	<13	
	6/24/2003	19,000	10,000	1,700	1,100	2,530	<13	<13	<13	<13	<13	
	9/26/2003	20,000	10,000	2,100	960	2,520	<17	<17	<17	<17	<17	
	12/16/2003	22,000	10,000	2,700	1,200	2,920	<25	<25	<25	<25	<25	
	4/6/2004	27,000	7,600	1,700	630	1,420	<10	<10	<10	<10	<10	
	6/23/2004	33,000	8,200	1,800	870	1,930	<17	<17	<17	<17	<17	
	9/15/2004	46,000	13,000	1,300	1,400	2,710	<17	<17	<17	<17	<17	
	12/16/2004	Not Sampled										
3/22/2005	42,000	9,900	1,200	1,200	2,530	<17	<17	<17	<17	<17		
6/24/2005	31,000	12,000	1,200	810	1,380	<20	<20	<20	<20	<20		
9/13/2005	35,000	13,000	1,100	1,300	2,260	<7.1	<7.1	<7.1	<7.1	<7.1		
12/2/2005	Not Sampled											
<b>DHS MCL</b>		-	1	150	300	1,750	5	0.5	6	10	0.5	

TABLE 2

**HISTORICAL GROUNDWATER ANALYTICAL RESULTS  
FORMER LEMOINE SAUSAGE FACTORY  
630 29TH AVENUE  
OAKLAND, CALIFORNIA**



Well Location	Date Sampled	TPH-g (ug/L)	Benzene (ug/L)	Toluene (ug/L)	Ethylbenzene (ug/L)	Total Xylenes (ug/L)	TCE (ug/L)	1,2-DCA (ug/L)	cis-1,2-DCE (ug/L)	trans-1,2-DCE (ug/L)	VC (ug/L)	
MW-2	3/2/2006	25,000	7,900	620	740	1,260	<7.1	<7.1	<7.1	<7.1	<7.1	
	6/15/2006	47,000	11,000	800	1,200	2,230	<20	<20	<20	<20	<20	
	9/14/2006	50,000	11,000	470	1,200	2,330 C	<10	<10	<10	<10	<10	
	1/11/2007	29,000	10,000	240	1,100	1,340	<13	<13	<13	<13	<13	
	4/9/2007	33,000	9,200	1,000	1,200	1,510	<13	<13	<13	<13	<13	
	9/17/2007	11,000	9,200	410	1,100	1,300	<13	<13	<13	<13	<13	
MW-3	2/8/1999	35,000	1,200	3,400	1,400	4,900	NA	<30	NA	NA	NA	
	6/29/2000	39,000	7,800	630	8,000	3,400	<5.0	600	<5.0	<5.0	<5.0	
	9/22/2000	83,000	16,000	20,000	1,300	7,000	NA	NA	NA	NA	NA	
	12/19/2000	50,000	1,200	1,600	510	1,810	<8.3	350	<8.3	<8.3	<8.3	
	3/22/2001	1,300	98	67	51	104	<0.5	2.3	<0.5	<0.5	<0.5	
	6/21/2001	34,000	5,900	6,200	340	1,550	2.4	120	0.8	<0.5	<0.5	
	9/26/2001	59,000	12,000	13,000	780	3,680	< 8.3	990	< 8.3	< 8.3	< 8.3	
Removed from sampling program in October 2001												
MW-4	2/8/1999	15,000	670	90	780	940	NA	<30	NA	NA	NA	
	6/15/2000	2,300	230	<5	10	94	<0.5	0.88	2.1	<0.5	<0.5	
	9/22/2000	12,000	2,800	82	1,100	1,300	NA	NA	NA	NA	NA	
	12/19/2000	2,200	200	2.9	100	81.4	<0.5	<0.5	<0.5	<0.5	<0.5	
	3/22/2001	5,600	1,100	13	310	303	<0.5	<0.5	1.6	<0.5	<0.5	
	6/21/2001	11,000	2,300	26	570	641	<0.5	1.4	3.3	<0.5	<0.5	
	9/26/2001	17,000	7,900	< 50	440	581	< 0.5	1.9	8.1	< 0.5	< 0.5	
Removed from sampling program in October 2001												
MW-5	2/8/1999	4,900	780	440	230	370	<0.5	<0.5	<0.5	<0.5	<0.5	
	6/29/2000	3,900	1,500	28	330	260	<0.5	36	<0.5	<0.5	<0.5	
	9/27/2000	16,000	4,300	3,100	420	1,600	NA	NA	NA	NA	NA	
	12/19/2000	21,000	3,200	1,100	1,100	1,300	<4.2	15	<4.2	<4.2	<4.2	
	3/22/2001	6,200	1,500	360	310	288	<0.5	3.3	<0.5	<0.5	<0.5	
	6/21/2001	18,000	3,400	2,300	350	1,020	<0.5	21	<0.5	<0.5	<0.5	
	9/26/2001	5,100	2,400	1,200	< 10	460	< 3.6	22	< 3.6	< 3.6	< 3.6	
Removed from sampling program in October 2001												
MW-6	6/15/2000	1,100	3.8	2.2	2.1	4.8	< 0.5	0.78	< 0.5	< 0.5	< 0.5	
	9/22/2000	71	< 0.5	< 0.5	< 0.5	< 0.5	NA	NA	NA	NA	NA	
	12/19/2000	320	< 0.5	< 0.5	< 0.5	< 0.5	< 0.5	< 0.5	< 0.5	< 0.5	< 0.5	
	3/21/2001	820	< 0.5	< 0.5	1.4	0.52	< 0.5	< 0.5	< 0.5	< 0.5	< 0.5	
	6/21/2001	420	< 0.5	< 0.5	0.59	1	< 0.5	0.9	< 0.5	< 0.5	< 0.5	
	9/25/2001	760	< 0.5	< 0.5	< 0.5	2.9	< 0.5	< 0.5	< 0.5	< 0.5	< 0.5	
	12/3/2001	72	< 0.5	< 0.5	< 0.5	< 0.5	< 0.5	1.6	< 0.5	< 0.5	< 0.5	
	3/25/2002	1,200	22	8.0	5.7	13.5	< 0.5	< 0.5	< 0.5	< 0.5	< 0.5	
	6/28/2002	120	< 0.5	< 0.5	< 0.5	< 0.5	< 0.5	0.6	< 0.5	< 0.5	< 0.5	
	9/11/2002	120	< 0.5	< 0.5	< 0.5	< 0.5	< 0.5	< 0.5	< 0.5	< 0.5	< 0.5	
	12/16/2002	62	< 0.5	0.54	3.0	8.39	0.7	1	< 0.5	< 0.5	< 0.5	
	3/28/2003	Not Sampled										
	6/24/2003	130	< 0.5	< 0.5	< 0.5	< 0.5	< 0.5	< 0.5	< 0.5	< 0.5	< 0.5	
	9/26/2003	<50	< 0.5	< 0.5	< 0.5	< 0.5	< 0.5	< 0.5	0.7	< 0.5	< 0.5	
	12/16/2003	<50	< 0.5	< 0.5	< 0.5	< 0.5	0.88	1.7	< 0.5	0.6	< 0.5	
	4/6/2004	260	< 0.5	< 0.5	< 0.5	< 0.5	< 0.5	< 0.5	< 0.5	< 0.5	< 0.5	
	6/23/2004	63	< 0.5	< 0.5	< 0.5	< 0.5	< 0.5	< 0.5	0.8	< 0.5	< 0.5	
	9/15/2004	<50	< 0.5	< 0.5	< 0.5	< 0.5	< 0.5	< 0.5	< 0.5	< 0.5	< 0.5	
	12/16/2004	240	< 0.5	< 0.5	< 0.5	< 0.5	< 0.5	< 0.5	< 0.5	< 0.5	< 0.5	
	3/22/2005	420	< 0.5	< 0.5	< 0.5	< 0.5	0.95	< 0.5	< 0.5	< 0.5	< 0.5	
6/24/2005	91	< 0.5	< 0.5	< 0.5	< 0.5	< 0.5	< 0.5	< 0.5	< 0.5	< 0.5		
<b>DHS MCL</b>		<b>-</b>	<b>1</b>	<b>150</b>	<b>300</b>	<b>1,750</b>	<b>5</b>	<b>0.5</b>	<b>6</b>	<b>10</b>	<b>0.5</b>	

TABLE 2

**HISTORICAL GROUNDWATER ANALYTICAL RESULTS  
FORMER LEMOINE SAUSAGE FACTORY  
630 29TH AVENUE  
OAKLAND, CALIFORNIA**



Well Location	Date Sampled	TPH-g (ug/L)	Benzene (ug/L)	Toluene (ug/L)	Ethylbenzene (ug/L)	Total Xylenes (ug/L)	TCE (ug/L)	1,2-DCA (ug/L)	cis-1,2-DCE (ug/L)	trans-1,2-DCE (ug/L)	VC (ug/L)	
MW-6	9/13/2005	<50	< 0.5	< 0.5	< 0.5	< 0.5	< 0.5	< 0.5	< 0.5	< 0.5	< 0.5	
	12/2/2005	<50	< 0.5	< 0.5	< 0.5	< 0.5	< 0.5	<b>0.7</b>	< 0.5	< 0.5	< 0.5	
	3/2/2006	<b>120</b>	< 0.5	< 0.5	< 0.5	< 0.5	< 0.5	< 0.5	< 0.5	< 0.5	< 0.5	
	6/15/2006	<b>51</b>	< 0.5	< 0.5	< 0.5	< 0.5	< 0.5	< 0.5	< 0.5	< 0.5	< 0.5	
	9/14/2006	<b>57</b>	< 0.5	< 0.5	< 0.5	< 0.5	< 0.5	< 0.5	< 0.5	< 0.5	< 0.5	
	1/11/2007	<50	< 0.5	< 0.5	< 0.5	< 0.5	< 0.5	< 0.5	< 0.5	< 0.5	< 0.5	
	4/9/2007	<50	< 0.5	< 0.5	< 0.5	< 0.5	< 0.5	< 0.5	< 0.5	< 0.5	< 0.5	
	9/17/2007	<50	< 0.5	< 0.5	< 0.5	< 0.5	< 0.5	< 0.5	< 0.5	< 0.5	< 0.5	
MW-7	6/15/2000	<b>1,000</b>	<b>250</b>	< 10	<10	<b>16</b>	< 0.5	< 0.5	< 0.5	< 0.5	< 0.5	
	9/22/2000	<50	<b>2</b>	< 0.5	< 0.5	< 0.5	NA	NA	NA	NA	NA	
	12/19/2000	<50	<b>1.6</b>	< 0.5	< 0.5	< 0.5	< 0.5	< 0.5	< 0.5	< 0.5	< 0.5	
	3/21/2001	<b>160</b>	<b>59</b>	< 0.5	< 0.5	< 0.5	< 0.5	< 0.5	< 0.5	< 0.5	< 0.5	
	6/21/2001	<50	< 0.5	< 0.5	< 0.5	< 0.5	< 0.5	< 0.5	< 0.5	< 0.5	< 0.5	
	9/25/2001	< 50	< 0.5	< 0.5	< 0.5	< 0.5	< 0.5	< 0.5	< 0.5	< 0.5	< 0.5	
	12/3/2001	<b>82</b>	<b>24</b>	< 0.5	< 0.5	< 0.5	< 0.5	< 0.5	< 0.5	< 0.5	< 0.5	
	3/25/2002	<50	<b>0.56</b>	<b>0.75</b>	<0.5	<b>0.69</b>	< 0.5	< 0.5	< 0.5	< 0.5	< 0.5	
	6/28/2002	<50	< 0.5	< 0.5	< 0.5	< 0.5	< 0.5	< 0.5	< 0.5	< 0.5	< 0.5	
	9/11/2002	<50	< 0.5	< 0.5	< 0.5	< 0.5	< 0.5	< 0.5	< 0.5	< 0.5	< 0.5	
	12/16/2002	<50	< 0.5	< 0.5	<b>1.6</b>	<b>3.7</b>	<b>0.5</b>	<0.5	<0.5	<0.5	<0.5	
	3/28/2003	<50	< 0.5	< 0.5	< 0.5	< 0.5	< 0.5	< 0.5	< 0.5	< 0.5	< 0.5	
	6/24/2003	<50	< 0.5	< 0.5	< 0.5	< 0.5	< 0.5	< 0.5	< 0.5	< 0.5	< 0.5	
	9/26/2003	<50	< 0.5	< 0.5	< 0.5	< 0.5	< 0.5	< 0.5	< 0.5	< 0.5	< 0.5	
	12/16/2003	<50	< 0.5	< 0.5	< 0.5	< 0.5	<b>0.75</b>	<b>1.8</b>	< 0.5	<b>0.6</b>	< 0.5	< 0.5
	4/6/2004	<50	< 0.5	< 0.5	< 0.5	< 0.5	< 0.5	< 0.5	< 0.5	< 0.5	< 0.5	
	6/23/2004	<50	< 0.5	< 0.5	< 0.5	< 0.5	< 0.5	< 0.5	< 0.5	< 0.5	< 0.5	
	9/15/2004	<50	< 0.5	< 0.5	< 0.5	< 0.5	< 0.5	< 0.5	< 0.5	< 0.5	< 0.5	
	12/16/2004	<50	< 0.5	< 0.5	< 0.5	< 0.5	< 0.5	< 0.5	< 0.5	< 0.5	< 0.5	
	3/22/2005	Not Sampled										
	6/24/2005	Not Sampled										
	9/12/2005	<50	< 0.5	< 0.5	< 0.5	< 0.5	< 0.5	< 0.5	< 0.5	< 0.5	< 0.5	< 0.5
	12/2/2005	<50	< 0.5	< 0.5	< 0.5	< 0.5	< 0.5	< 0.5	< 0.5	< 0.5	< 0.5	< 0.5
	3/2/2006	<50	< 0.5	< 0.5	< 0.5	< 0.5	< 0.5	< 0.5	< 0.5	< 0.5	< 0.5	< 0.5
	6/15/2006	<50	< 0.5	< 0.5	< 0.5	< 0.5	<b>0.62</b>	< 0.5	< 0.5	< 0.5	< 0.5	< 0.5
9/14/2006	<50	< 0.5	< 0.5	< 0.5	< 0.5	< 0.5	< 0.5	< 0.5	< 0.5	< 0.5	< 0.5	
1/11/2007	<50	< 0.5	< 0.5	< 0.5	< 0.5	< 0.5	< 0.5	< 0.5	< 0.5	< 0.5	< 0.5	
4/9/2007	<50	< 0.5	< 0.5	< 0.5	< 0.5	< 0.5	< 0.5	< 0.5	< 0.5	< 0.5	< 0.5	
9/17/2007	<50	< 0.5	< 0.5	< 0.5	< 0.5	< 0.5	< 0.5	< 0.5	< 0.5	< 0.5	< 0.5	
MW-8	6/15/2000	<b>5,400</b>	<b>150</b>	<5	<b>8.9</b>	<b>8.7</b>	<b>210</b>	<13	<b>1,100</b>	<b>73</b>	<b>25</b>	
	9/22/2000	<b>1,800</b>	<b>340</b>	<2.5	<2.5	<2.5	NA	NA	NA	NA	NA	
	12/19/2000	<b>2,700</b>	<b>410</b>	<2.5	<b>4.8</b>	<2.5	<b>130</b>	<b>9.1</b>	<b>1,000</b>	<b>67</b>	<b>48</b>	
	3/21/2001	<b>3,500</b>	<b>530</b>	<2.5	<b>21</b>	<2.5	<b>32</b>	<3.6	<b>760</b>	<b>39</b>	<b>58</b>	
	6/21/2001	<b>2,400</b>	<b>490</b>	<2.5	<b>29</b>	<2.5	<b>28</b>	<b>4.9</b>	<b>910</b>	<b>48</b>	<b>75</b>	
	9/25/2001	<b>1,500</b>	<b>170</b>	<b>4.3</b>	<b>1.6</b>	<b>2.7</b>	<b>36</b>	<b>5.0</b>	<b>820</b>	<b>59</b>	<b>53</b>	
	12/3/2001	<b>1,200</b>	<b>190</b>	<b>14</b>	<b>2.7</b>	<b>11.3</b>	<b>100</b>	<2.5	<b>650</b>	<b>44</b>	<b>31</b>	
	3/25/2002	<b>990</b>	<b>280</b>	<b>7.2</b>	<b>1.4</b>	<b>6.8</b>	<b>10</b>	<b>3.6</b>	<b>790</b>	<b>33</b>	<b>49</b>	
	6/28/2002	<b>2,200</b>	<b>410</b>	<1.0	<b>40</b>	<1.0	<b>18</b>	<b>4.9</b>	<b>900</b>	<b>54</b>	<b>80</b>	
	9/11/2002	<b>2,000</b>	<b>390</b>	<b>1.6</b>	<b>39</b>	<1.0	<b>17</b>	<3.6	<b>1,000</b>	<b>60</b>	<b>91</b>	
	12/16/2002	<b>95</b>	<b>26</b>	<0.5	<b>1</b>	<0.5	<b>17</b>	<b>2.2</b>	<b>330</b>	<b>36</b>	<b>4.7</b>	
	3/28/2003	<b>1,500</b>	<b>400</b>	<0.5	<b>50</b>	<b>0.62</b>	<b>3.5</b>	<2.5	<b>700</b>	<b>39</b>	<b>41</b>	
	6/24/2003	<b>3,300</b>	<b>520</b>	<0.5	<b>58</b>	<b>0.63</b>	<b>6.4</b>	<b>3.7</b>	<b>1,000</b>	<b>49</b>	<b>61</b>	
	9/26/2003	<b>1,300</b>	<b>280</b>	<b>3.9</b>	<b>38</b>	<b>0.85</b>	<b>20</b>	<3.6	<b>890</b>	<b>49</b>	<b>47</b>	
	12/16/2003	<b>1,100</b>	<b>310</b>	<2.5	<b>14</b>	<2.5	<b>12</b>	<b>4.3</b>	<b>1,200</b>	<b>53</b>	<b>110</b>	
4/6/2004	<b>3,800</b>	<b>420</b>	<0.5	<b>53</b>	<b>1.2</b>	<b>4.4</b>	<b>3.7</b>	<b>1,100</b>	<b>39</b>	<b>58</b>		
6/23/2004	<b>4,600</b>	<b>570</b>	<b>2.9</b>	<b>100</b>	<b>1.5</b>	<8.3	<8.3	<b>1,300</b>	<b>50</b>	<b>80</b>		
<b>DHS MCL</b>		<b>-</b>	<b>1</b>	<b>150</b>	<b>300</b>	<b>1,750</b>	<b>5</b>	<b>0.5</b>	<b>6</b>	<b>10</b>	<b>0.5</b>	

TABLE 2

**HISTORICAL GROUNDWATER ANALYTICAL RESULTS  
FORMER LEMOINE SAUSAGE FACTORY  
630 29TH AVENUE  
OAKLAND, CALIFORNIA**



Well Location	Date Sampled	TPH-g (ug/L)	Benzene (ug/L)	Toluene (ug/L)	Ethylbenzene (ug/L)	Total Xylenes (ug/L)	TCE (ug/L)	1,2-DCA (ug/L)	cis-1,2-DCE (ug/L)	trans-1,2-DCE (ug/L)	VC (ug/L)
MW-8	9/15/2004	4,900	710	<1.0	100	<1.0	<7.1	<7.1	1,200	49	100
	12/16/2004	3,800	450	<0.5	75	6.5	<8.3	<8.3	1,500	60	86
	3/22/2005	1,700	120	<1.0	9.8	<1.0	<3.6	<3.6	620	27	38
	6/24/2005	1,400	100	<1.0	37	<1.0	<5.0	<5.0	770	29	51
	9/13/2005	2,700	250	<1.0	110	<1.0	<7.1	<7.1	1,000	35	60
	12/2/2005	1,500	160	<1.0	33	<1.0	13	<5.0	930	46	80
	3/2/2006	2,000 L	210	<0.5	36	<0.5	<6.3	<6.3	890	34	50
	6/15/2006	1,400	78	<0.5	21	<0.5	6.9	<5.0	700	28	41
	9/14/2006	1,600	120	<0.5	42	<0.5	7.6	<6.3	800	37	43
	1/11/2007	1,100 Y	130	<0.5	49	1.1 C	<6.3	<6.3	820	32	58
	4/9/2007	2,200 L	160	<0.5	65	1.1	<6.3	<6.3	820	24	55
	9/17/2007	3,300 L Y	230	<0.5	140	<0.5	<6.3	<6.3	900	28	91
	MW-9	12/3/2001	90,000	15,000	15,000	2,200	9,100	<10	<10	<10	<10
3/25/2002		71,000	15,000	17,000	1,900	8,000	<31	<31	<31	<31	<31
6/28/2002		60,000	5,800	7,400	1,100	5,400	<13	<13	<13	<13	<13
9/11/2002		57,000	8,300	6,100	340	4,700	<10	18	<10	<10	<10
12/16/2002		29,000	5,500	3,900	300	1,860	<5	8.9	<5	<5	<5
3/28/2003		61,000	13,000	8,600	860	4,800	<20	<20	<20	<20	<20
6/24/2003		45,000	15,000	9,600	1,100	5,200	<5	10	<5	<5	<5
9/26/2003		34,000	12,000	5,600	880	4,700	<17	<17	<17	<17	<17
12/16/2003		34,000	14,000	4,900	940	4,700	<42	<42	<42	<42	<42
4/6/2004		60,000	14,000	3,100	1,300	5,500	<17	<17	<17	<17	<17
6/23/2004		53,000	12,000	2,600	1,100	4,800	<20	<20	<20	<20	<20
9/15/2004		76,000	17,000	2,200	1,500	6,600	<20	<20	<20	<20	<20
12/16/2004		63,000	15,000	1,700	1,300	5,900	<20	<20	<20	<20	<20
3/22/2005		66,000	13,000	2,000	1,200	5,800	<17	<17	<17	<17	<17
6/24/2005		54,000	16,000	780	1,300	5,200	<20	<20	<20	<20	<20
9/13/2005		48,000	11,000	4,800	470	4,110	<17	<17	<17	<17	<17
12/2/2005		39,000	12,000	3,800	650	3,470 C	<20	<20	<20	<20	<20
3/2/2006		51,000	12,000	3,500	750	4,170	<20	<20	<20	<20	<20
6/15/2006	67,000	16,000	5,000	1,900	5,790	<36	<36	<36	<36	<36	
9/14/2006	49,000	13,000	620	1,000	3,680	<13	<13	<13	<13	<13	
1/11/2007	45,000	13,000	460	1,100	3,050	<17	<17	<17	<17	<17	
4/9/2007	49,000	13,000	580	1,100	3,020	<17	<17	<17	<17	<17	
9/17/2007	19,000	9,600	250	1,000	2,540	<17	<17	<17	<17	<17	
MW-10	12/3/2001	<50	<0.5	<0.5	<0.5	<0.5	<0.5	<0.5	<0.5	<0.5	<0.5
	3/25/2002	51	2.5	3.6	0.53	2.27	<0.5	<0.5	<0.5	<0.5	<0.5
	6/28/2002	<50	<0.5	<0.5	<0.5	<0.5	<0.5	<0.5	<0.5	<0.5	<0.5
	9/11/2002	<50	<0.5	<0.5	<0.5	<0.5	<0.5	<0.5	<0.5	<0.5	<0.5
	12/16/2002	<50	<0.5	0.65	3.0	7.53	0.8	<0.5	<0.5	<0.5	<0.5
	3/28/2003	<50	<0.5	<0.5	<0.5	<0.5	<0.5	<0.5	<0.5	<0.5	<0.5
	6/24/2003	<50	<0.5	<0.5	<0.5	<0.5	<0.5	<0.5	<0.5	<0.5	<0.5
	9/26/2003	<50	<0.5	<0.5	<0.5	<0.5	<0.5	<0.5	<0.5	<0.5	<0.5
	12/16/2003	<50	<0.5	<0.5	<0.5	<0.5	0.6	<0.5	<0.5	<0.5	<0.5
	4/6/2004	<50	<0.5	<0.5	<0.5	<0.5	<0.5	<0.5	<0.5	<0.5	<0.5
	6/23/2004	<50	<0.5	<0.5	<0.5	<0.5	<0.5	<0.5	<0.5	<0.5	<0.5
	9/15/2004	<50	<0.5	<0.5	<0.5	<0.5	<0.5	<0.5	<0.5	<0.5	<0.5
	12/16/2004	<50	<0.5	<0.5	<0.5	<0.5	<0.5	<0.5	<0.5	<0.5	<0.5
	3/22/2005	<50	<0.5	<0.5	<0.5	<0.5	<0.5	<0.5	<0.5	<0.5	<0.5
	6/24/2005	<50	<0.5	<0.5	<0.5	<0.5	<0.5	<0.5	<0.5	<0.5	<0.5
9/12/2005	<50	<0.5	<0.5	<0.5	<0.5	<0.5	<0.5	<0.5	<0.5	<0.5	
12/2/2005	<50	<0.5	<0.5	<0.5	<0.5	<0.5	<0.5	<0.5	<0.5	<0.5	
3/2/2006	<50	0.74	<0.5	<0.5	<0.5	<0.5	<0.5	<0.5	<0.5	<0.5	
<b>DHS MCL</b>		-	1	150	300	1,750	5	0.5	6	10	0.5

TABLE 2

HISTORICAL GROUNDWATER ANALYTICAL RESULTS  
 FORMER LEMOINE SAUSAGE FACTORY  
 630 29TH AVENUE  
 OAKLAND, CALIFORNIA



Well Location	Date Sampled	TPH-g (ug/L)	Benzene (ug/L)	Toluene (ug/L)	Ethylbenzene (ug/L)	Total Xylenes (ug/L)	TCE (ug/L)	1,2-DCA (ug/L)	cis-1,2-DCE (ug/L)	trans-1,2-DCE (ug/L)	VC (ug/L)	
MW-10	6/15/2006	<50	<0.5	<0.5	<0.5	<0.5	<0.5	<0.5	<0.5	<0.5	<0.5	
	9/14/2006	<50	<0.5	<0.5	<0.5	<0.5	<0.5	<0.5	<0.5	<0.5	<0.5	
	1/11/2007	<50	<0.5	<0.5	<0.5	<0.5	<0.5	<0.5	<0.5	<0.5	<0.5	
	4/9/2007	<50	<0.5	<0.5	<0.5	<0.5	<0.5	<0.5	<0.5	<0.5	<0.5	
	9/17/2007	<50	<0.5	<0.5	<0.5	<0.5	<0.5	<0.5	<0.5	<0.5	<0.5	
MW-11	12/3/2001	<b>1,600</b>	<b>470</b>	<0.5	<b>3.7</b>	<0.5	<0.5	<0.5	<0.5	<0.5	<0.5	
	3/25/2002	<b>130</b>	<b>11</b>	<b>20</b>	<b>3.3</b>	<b>14.5</b>	<0.5	<0.5	<0.5	<0.5	<0.5	
	6/28/2002	<50	<b>7.7</b>	<0.5	<b>&lt;0.5</b>	<0.5	<b>0.6</b>	<0.5	<0.5	<0.5	<0.5	
	9/11/2002	<b>120</b>	<b>66</b>	<0.5	<b>0.74</b>	<0.5	<0.5	<0.5	<b>0.6</b>	<0.5	<0.5	
	12/16/2002	<b>160</b>	<b>42</b>	<b>0.89</b>	<b>4.8</b>	<b>11.1</b>	<b>3.6</b>	<0.5	<b>1.1</b>	<0.5	<0.5	
	3/28/2003	<50	<0.5	<0.5	<0.5	<0.5	<0.5	<0.5	<0.5	<0.5	<0.5	
	6/24/2003	<50	<0.5	<0.5	<0.5	<0.5	<0.5	<0.5	<0.5	<0.5	<0.5	
	9/26/2003	<50	<b>1.2</b>	<b>0.69</b>	<0.5	<0.5	<0.5	<0.5	<0.5	<0.5	<0.5	
	12/16/2003	<b>91</b>	<b>4.7</b>	<0.5	<0.5	<b>0.51</b>	<b>2.9</b>	<0.5	<b>0.9</b>	<b>0.6</b>	<0.5	
	4/6/2004	<50	<0.5	<0.5	<0.5	<0.5	<0.5	<0.5	<0.5	<0.5	<0.5	
	6/23/2004	<50	<0.5	<0.5	<0.5	<0.5	<0.5	<0.5	<0.5	<0.5	<0.5	
	9/15/2004	<50	<0.5	<0.5	<0.5	<0.5	<0.5	<0.5	<0.5	<0.5	<0.5	
	12/16/2004	<50	<b>1.3</b>	<0.5	<0.5	<0.5	<b>0.59</b>	<0.5	<0.5	<0.5	<0.5	
	3/22/2005	<50	<0.5	<0.5	<0.5	<0.5	<0.5	<0.5	<0.5	<0.5	<0.5	
	6/24/2005	<50	<0.5	<0.5	<0.5	<0.5	<0.5	<0.5	<0.5	<0.5	<0.5	
	9/13/2005	<50	<0.5	<0.5	<0.5	<0.5	<0.5	<0.5	<0.5	<0.5	<0.5	
	12/2/2005	<50	<0.5	<0.5	<0.5	<0.5	<0.5	<0.5	<0.5	<0.5	<0.5	
	3/2/2006	<50	<0.5	<0.5	<0.5	<0.5	<0.5	<0.5	<0.5	<0.5	<0.5	
	6/15/2006	<50	<0.5	<0.5	<0.5	<0.5	<0.5	<0.5	<0.5	<0.5	<0.5	
	9/14/2006	<50	<0.5	<0.5	<0.5	<0.5	<0.5	<0.5	<0.5	<0.5	<0.5	
1/11/2007	<50	<0.5	<0.5	<0.5	<0.5	<0.5	<0.5	<0.5	<0.5	<0.5		
4/9/2007	<50	<0.5	<0.5	<0.5	<0.5	<0.5	<0.5	<0.5	<0.5	<0.5		
9/17/2007	Not Sampled											
MW-12	6/28/2002	<b>71</b>	<0.5	<0.5	<0.5	<0.5	<b>170</b>	<0.5	<b>42</b>	<b>47</b>	<b>0.9</b>	
	9/11/2002	<b>89</b>	<0.5	<0.5	<0.5	<0.5	<b>180</b>	<0.5	<b>46</b>	<b>51</b>	<b>0.9</b>	
	12/16/2002	<b>130</b>	<0.5	<b>0.9</b>	<b>4.2</b>	<b>9.9</b>	<b>200</b>	<0.5	<b>57</b>	<b>60</b>	<b>0.9</b>	
	3/28/2003	<b>110</b>	<0.5	<0.5	<0.5	<0.5	<b>190</b>	<0.7	<b>53</b>	<b>53</b>	<b>0.9</b>	
	6/24/2003	<b>140</b>	<0.5	<0.5	<0.5	<0.5	<b>220</b>	<1.0	<b>58</b>	<b>66</b>	<1.0	
	9/26/2003	<b>230</b>	<b>2.9</b>	<b>1.1</b>	<b>3.8</b>	<b>6.71</b>	<b>210</b>	<0.7	<b>60</b>	<b>63</b>	<0.7	
	12/16/2003	<b>120</b>	<0.5	<0.5	<0.5	<0.5	<b>0.65</b>	<b>140</b>	<0.5	<b>44</b>	<b>44</b>	<0.5
	4/6/2004	<b>76</b>	<0.5	<0.5	<0.5	<0.5	<b>160</b>	<0.5	<b>49</b>	<b>54</b>	<0.5	
	6/23/2004	<b>99</b>	<0.5	<0.5	<0.5	<0.5	<b>200</b>	<0.5	<b>65</b>	<b>74</b>	<0.5	
	9/15/2004	<b>130</b>	<0.5	<0.5	<0.5	<0.5	<b>290</b>	<1.7	<b>73</b>	<b>83</b>	<1.7	
	12/16/2004	<b>110</b>	<b>0.94</b>	<0.5	<0.5	<0.5	<b>240</b>	<2.0	<b>80</b>	<b>77</b>	<2.0	
	3/22/2005	<b>61</b>	<0.5	<0.5	<0.5	<0.5	<b>95</b>	<0.5	<b>26</b>	<b>42</b>	<0.5	
	6/24/2005	<b>59</b>	<0.5	<0.5	<0.5	<0.5	<b>120</b>	<1.0	<b>31</b>	<b>39</b>	<1.0	
	9/12/2005	<b>64</b>	<0.5	<0.5	<0.5	<0.5	<b>130</b>	<0.7	<b>34</b>	<b>42</b>	<0.7	
	12/2/2005	<b>80 Y,Z</b>	<0.5	<0.5	<0.5	<0.5	<b>170</b>	<1.0	<b>43</b>	<b>49</b>	<1.0	
	3/2/2006	<b>54 Y,Z</b>	<0.5	<0.5	<0.5	<0.5	<b>84</b>	<0.8	<b>27</b>	<b>31</b>	<0.8	
	6/15/2006	<b>58 Y,Z</b>	<0.5	<0.5	<0.5	<0.5	<b>99</b>	<0.5	<b>30</b>	<b>38</b>	<0.5	
9/14/2006	<b>81 Y,Z</b>	<0.5	<0.5	<0.5	<0.5	<b>110</b>	<1.0	<b>41</b>	<b>47</b>	<1.0		
1/11/2007	<b>76 Y,Z</b>	<0.5	<0.5	<0.5	<0.5	<b>140</b>	<1.0	<b>47</b>	<b>53</b>	<1.0		
4/9/2007	<b>70 Y,Z</b>	<b>1.4</b>	<0.5	<0.5	<0.5	<b>130</b>	<1.0	<b>43</b>	<b>48</b>	<1.0		
9/17/2007	<b>84 L,Y</b>	<0.5	<0.5	<0.5	<0.5	<b>160</b>	<1.0	<b>61</b>	<b>63</b>	<1.0		
MW-13	6/28/2002	<b>5,600</b>	<b>120</b>	<b>55</b>	<b>130</b>	<b>9.5</b>	<b>61</b>	<0.5	<b>430</b>	<b>14</b>	<b>4.4</b>	
	9/11/2002	<b>4,500</b>	<b>58</b>	<b>7.5</b>	<b>150</b>	<b>14</b>	<b>63</b>	<0.5	<b>410</b>	<b>13</b>	<1.3	
	12/16/2002	<b>4,800</b>	<b>90</b>	<0.5	<b>85</b>	<b>24</b>	<b>76</b>	<0.5	<b>250</b>	<b>9.4</b>	<b>1.8</b>	
	3/28/2003	<b>4,400</b>	<b>55</b>	<0.5	<b>51</b>	<b>14.3</b>	<b>85</b>	<0.5	<b>150</b>	<b>13</b>	<b>1.8</b>	
	6/24/2003	<b>8,300</b>	<b>100</b>	<0.5	<b>94</b>	<b>12</b>	<b>68</b>	<1.0	<b>250</b>	<b>19</b>	<b>4.2</b>	
	9/26/2003	<b>7,200</b>	<b>150</b>	<1.0	<b>89</b>	<b>57</b>	<b>51</b>	<1.0	<b>270</b>	<b>23</b>	<b>5.1</b>	
<b>DHS MCL</b>		<b>-</b>	<b>1</b>	<b>150</b>	<b>300</b>	<b>1,750</b>	<b>5</b>	<b>0.5</b>	<b>6</b>	<b>10</b>	<b>0.5</b>	

TABLE 2

**HISTORICAL GROUNDWATER ANALYTICAL RESULTS  
FORMER LEMOINE SAUSAGE FACTORY  
630 29TH AVENUE  
OAKLAND, CALIFORNIA**



Well Location	Date Sampled	TPH-g (ug/L)	Benzene (ug/L)	Toluene (ug/L)	Ethylbenzene (ug/L)	Total Xylenes (ug/L)	TCE (ug/L)	1,2-DCA (ug/L)	cis-1,2-DCE (ug/L)	trans-1,2-DCE (ug/L)	VC (ug/L)
MW-13	12/16/2003	8,100	120	36	72	26.6	66	<0.7	240	23	10
	4/6/2004	3,300	22	<1.0	37	9.0	90	<0.5	190	23	8
	6/23/2004	7,000	140	25	88	21	53	<2.0	350	31	25
	9/15/2004	6,700	84	<1.0	78	7.2	37	<1.7	300	40	31
	12/16/2004	4,300	61	<0.5	44	11.5	69	<2.0	240	32	15
	3/22/2005	3,000	24	<0.5	20	7.6	72	<0.5	120	23	6.6
	6/24/2005	2,600	63	<0.5	25	4.3	42	<1.0	150	36	16
	9/12/2005	2,500	20 C	<0.5	33	6.7 c	25	<1.3	170	38	22
	12/2/2005	4,200 Y	70 C	<0.5	21 C	15.5 C	17	<1.3	140	40	24
	3/2/2006	3,200 L Y	67 C	<0.5	27	5.19 C	43	<0.8	110	32	16
	6/15/2006	3,400	92 C	<0.5	26	3.4 C	43	<0.8	120	39	18
	9/14/2006	2,000	<0.5	<0.5	64 C	38 C	15	<0.8	93	45	17
	1/11/2007	25,000 Y	44	<5.0	160	69 C	24	<0.8	87	45	11
	4/9/2007	5,800 Y	42 C	<5.0	41	21.2 C	34	<0.8	82	43	14
	9/17/2007	3,800 L	52 C	4.0	25	8.2 C	11	<0.8	56	65	11
<b>DHS MCL</b>		-	1	150	300	1,750	5	0.5	6	10	0.5

**Notes:**

- All results are reported in micrograms per liter (µg/L).
- NA refers to Not Analyzed.
- NS refers to Not Sampled.
- TPH-g refers to Total Petroleum Hydrocarbons as Gasoline.
- MTBE refers to Methyl tert-butyl ether.
- TCE refers to Trichloroethene.
- trans-1,2-DCE refers to trans-1,2-dichloroethene.
- cis-1,2-DCE refers to cis-1,2-Dichloroethene.
- VC refers to Vinyl Chloride.
- 1,2-DCA refers to 1,2-dichloroethane.
- Y=Sample exhibits chromatographic pattern which does not resemble standard.
- Z=Sample exhibits unknown single peak or peaks.
- C=Presence confirmed, but RPD between columns exceed 40%.
- L=Lighter hydrocarbons contributed to the quantitation.
- RWQCB ESL refers to the California Regional Water Quality Control Board F399 Environmental Screening Level for shallow soils less than 10 feet deep groundwater is a current or potential source of drinking water, as presented in Table A of the RWQCB ESLs (2005).
- DHS MCL refers to California Department of Health Services Maximum Contaminant Level.
- Bromodichloromethane and Chloroethane were detected at 4.3 and 2.1 ug/L, respectively, in Well MW-13.



## **FIGURES**

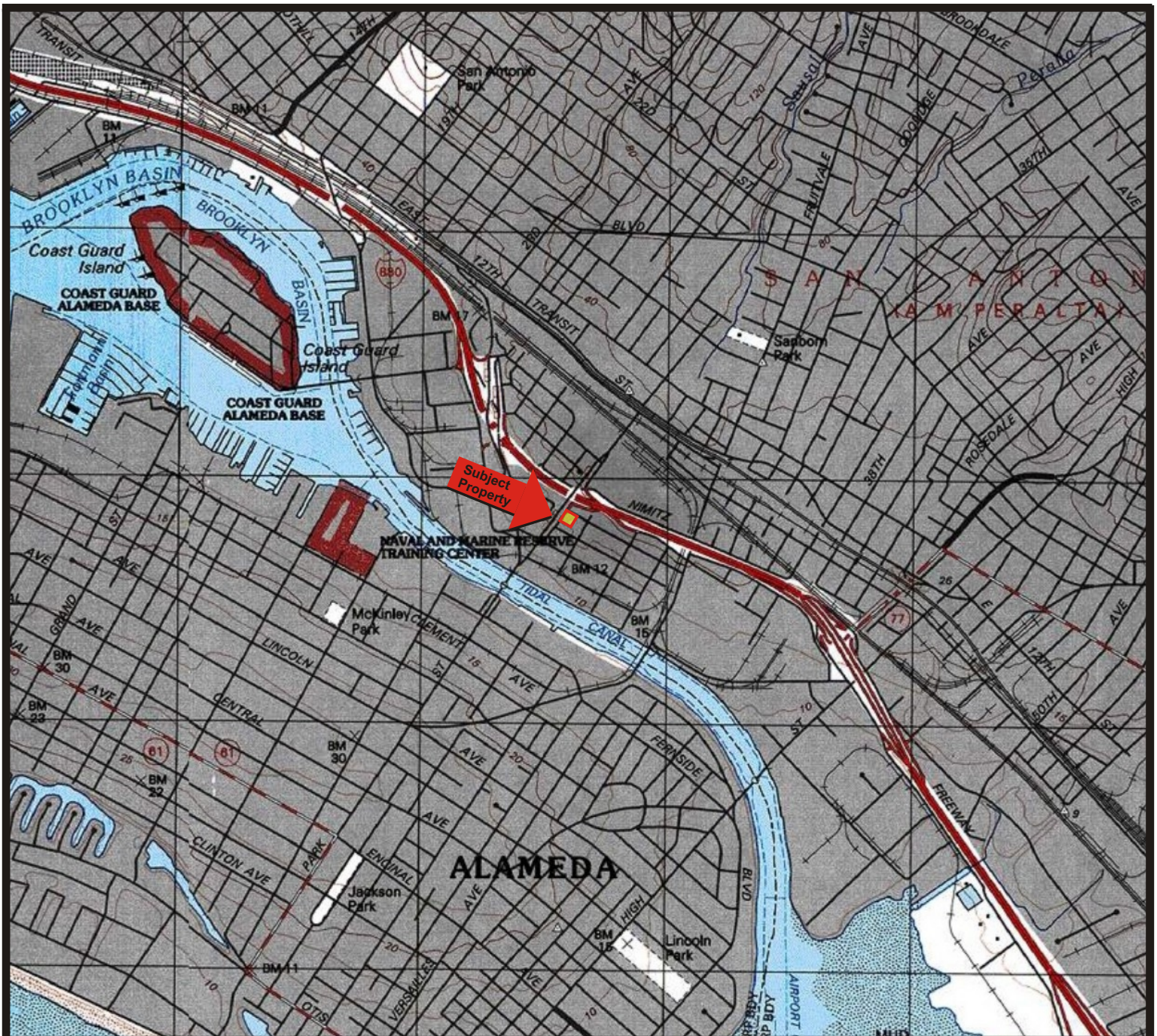

Map Source: TOPO!© 2000 National Geographic Holdings

Note: Boundaries and Location Information is Approximate

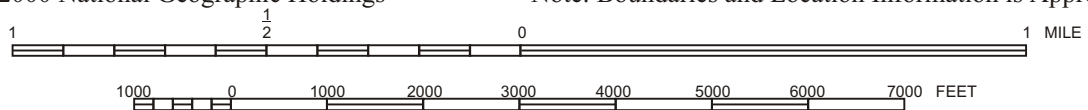

Portion of the 7.5-Minute Series Oakland East, California  
 Quadrangle Topographic Map (Datum: NAD 27)  
 United States Department of the Interior  
 Geological Survey  
 1997



QUADRANGLE LOCATION

PROPERTY LOCATION MAP  
 Former Lemoine Sausage Factory  
 630 29th Avenue  
 Oakland, California  
 Project No. 33104-004578.00

FIGURE

1



**BUREAU  
 VERITAS**



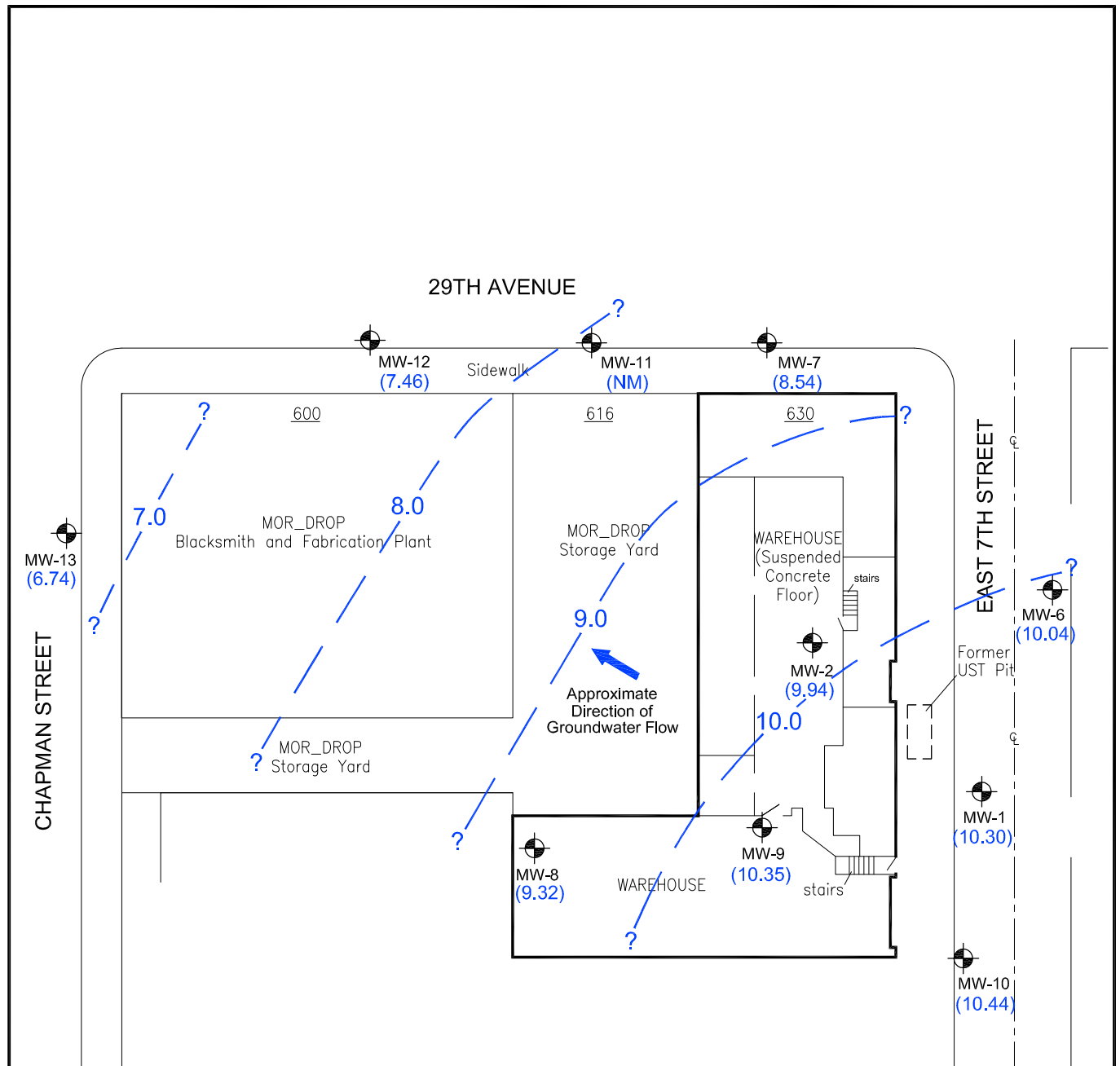

**LEGEND:**

- MW-1  Existing Monitoring Well Location
- (9.94) Groundwater Elevation (ft msl), 09/17/07
- 10- - - - Groundwater Surface Elevation Contour (ft msl)
- ft msl Feet Above Mean Sea Level
- NM Not Measured

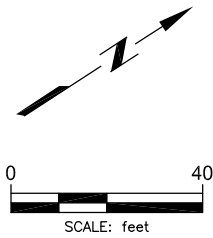

<p><b>GROUNDWATER ELEVATION MAP, 3rd QUARTER 2007</b></p> <p>FORMER LEMOINE SAUSAGE FACTORY 630 29TH AVENUE OAKLAND, CALIFORNIA Project No. 33104-004578.00</p>	<p>Figure <b>2</b> 10/05/07 SITE0907.DWG</p>	 <p><b>BUREAU VERITAS</b></p>
---------------------------------------------------------------------------------------------------------------------------------------------------------------------------------	----------------------------------------------------------	------------------------------------------------------------------------------------------------------------------------

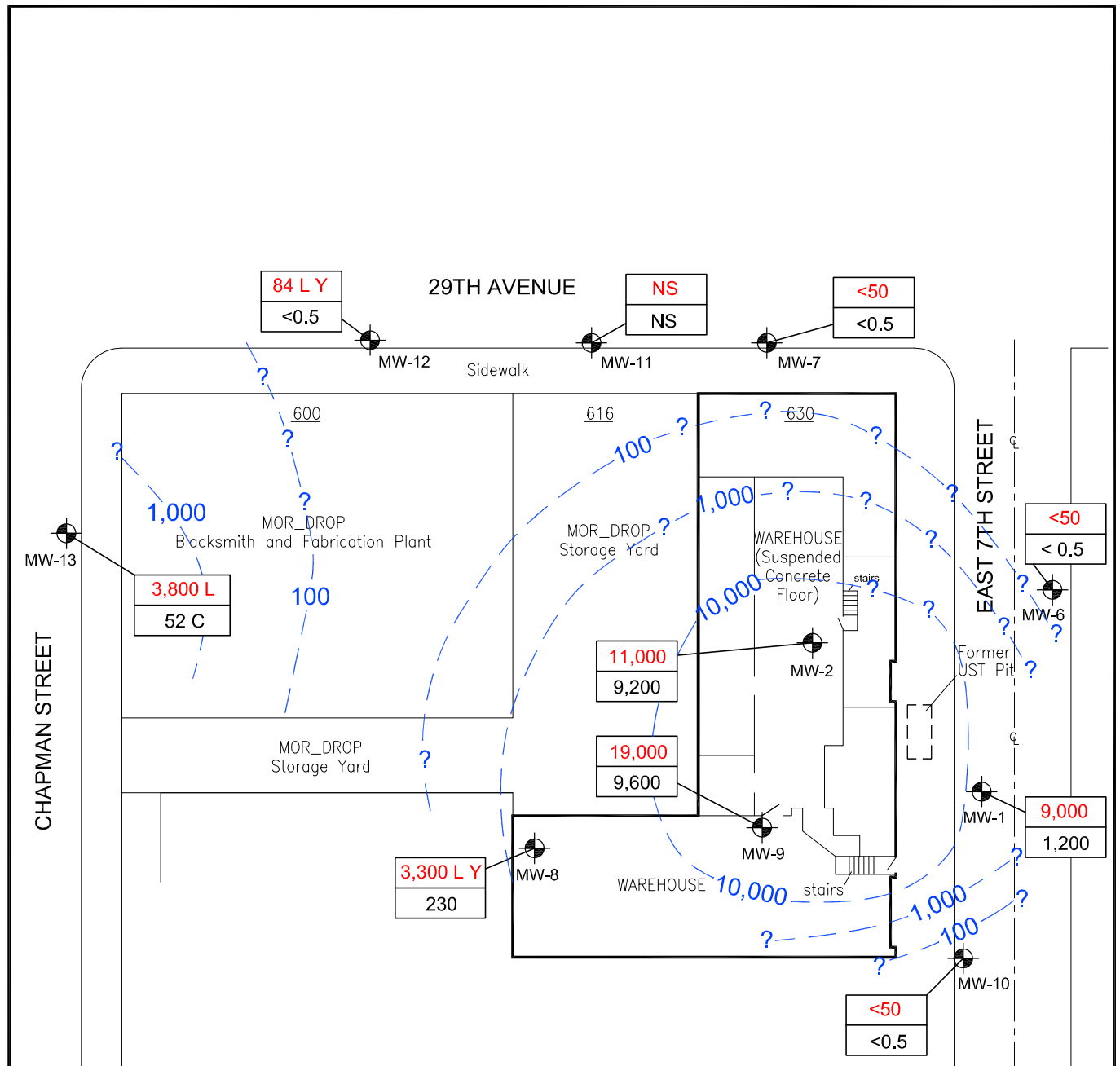

**LEGEND:**

MW-1  Existing Monitoring Well Location

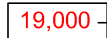
 TPH-g Concentration (ug/L), 09/17/07

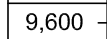
 Benzene Concentration (ug/L), 09/17/07

 TPH-g Isoconcentration Contour (ug/L)

TPH-g Total Petroleum Hydrocarbons as Gasoline

ug/L micrograms per liter

NS Not Sampled

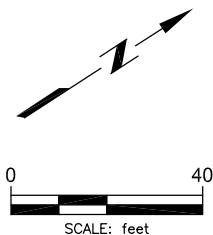

**TPH-g CONCENTRATIONS IN GROUNDWATER, 3rd QUARTER 2007**

FORMER LEMOINE SAUSAGE FACTORY  
630 29TH AVENUE  
OAKLAND, CALIFORNIA  
Project No. 33104-004578.00

Figure

**3**

10/05/07  
SITE0907.DWG



**BUREAU VERITAS**

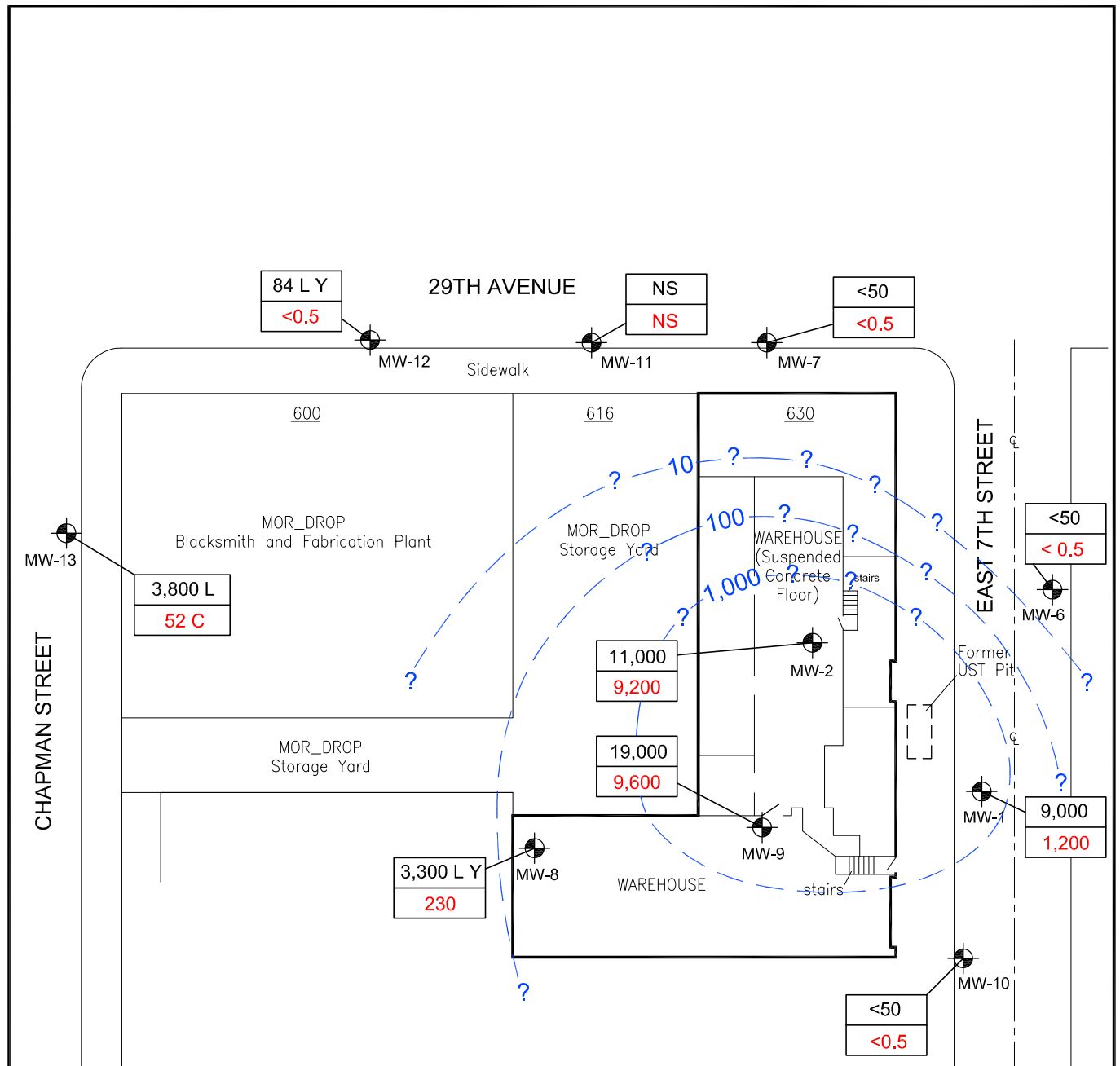

**LEGEND:**

MW-1 Existing Monitoring Well Location

19,000 — TPH-g Concentration (ug/L), 09/17/07

9,600 — Benzene Concentration (ug/L), 09/17/07

10 — Benzene Isoconcentration Contour (ug/L)

TPH-g Total Petroleum Hydrocarbons as Gasoline  
ug/L micrograms per liter

NS Not Sampled

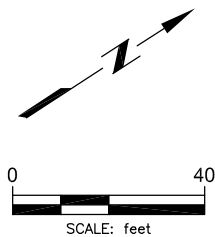

**BENZENE CONCENTRATIONS IN GROUNDWATER, 3rd QUARTER 2007**

FORMER LEMOINE SAUSAGE FACTORY  
630 29TH AVENUE  
OAKLAND, CALIFORNIA  
Project No. 33104-004578.00

Figure

**4**

10/05/07  
SITE0907.DWG



**BUREAU VERITAS**

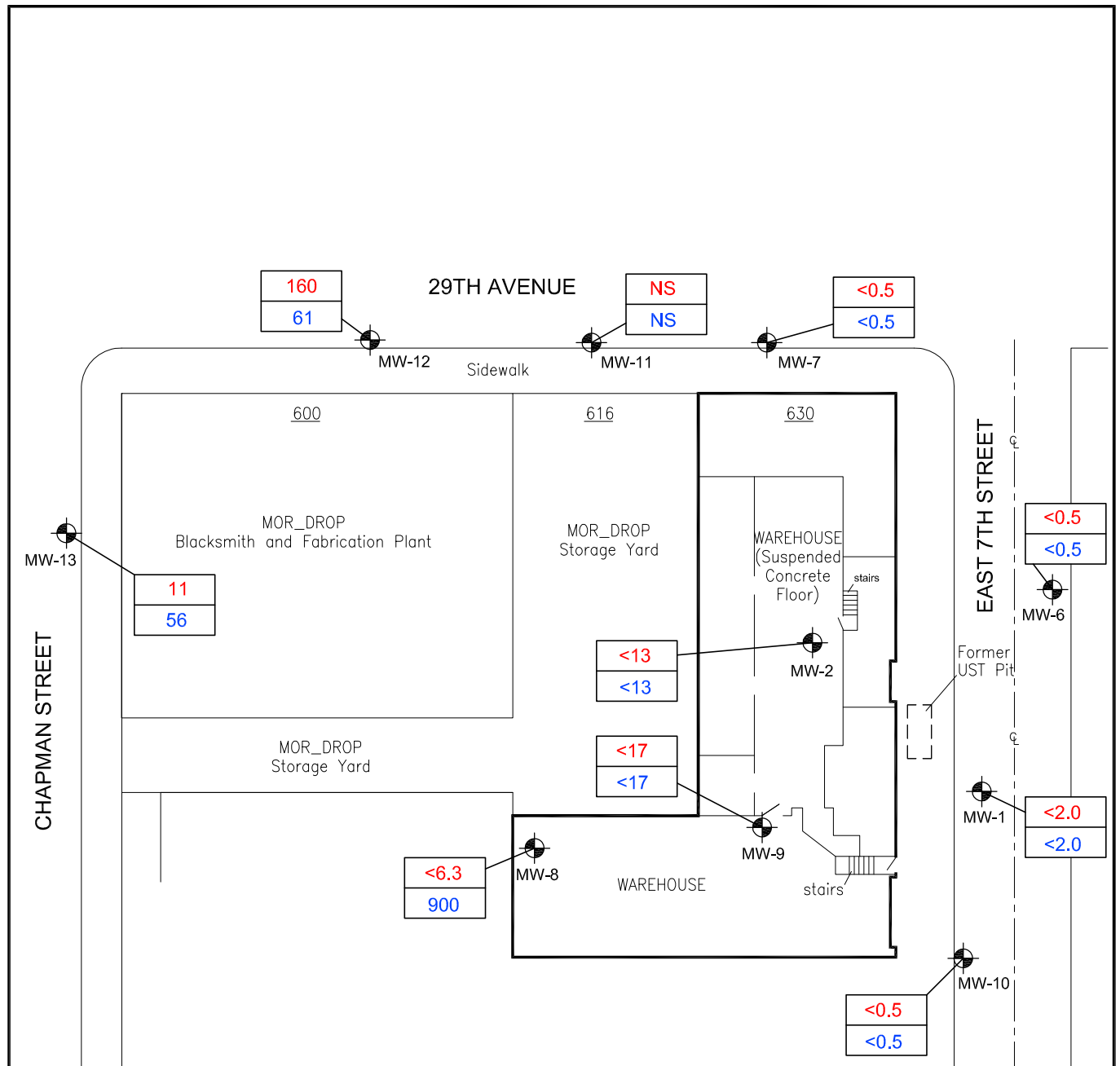

**LEGEND:**

MW-1 Existing Monitoring Well Location

TCE Concentration (ug/L), 09/17/07  
 cis 1,2-DCE Concentration (ug/L), 09/17/07

TCE Trichloroethene  
 cis 1,2-DCE cis 1,2-Dichloroethene  
 ug/L micrograms per liter  
 NS Not Sampled

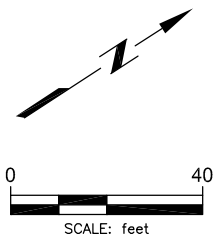

**TCE AND cis-1,2-DCE  
 CONCENTRATIONS IN GROUNDWATER,  
 3rd QUARTER 2007**  
 FORMER LEMOINE SAUSAGE FACTORY  
 630 29TH AVENUE  
 OAKLAND, CALIFORNIA  
 Project No. 33104-004578.00

Figure

**5**

09/28/07  
 SITE0907.DWG



**BUREAU  
 VERITAS**



**APPENDIX A**

**FIELD SAMPLING DATA SHEETS**







**FIELD SAMPLING DATA SHEET**

Job Location:	Former Lemoine Sausage Factory	Job #:	33104-004578.00
	630 29th Avenue	Date Purged:	9.17.07
	Oakland, California	Purge Method:	Disposable Bailer
Sampling Location:	<b>MW-6</b>	Date & Time Sampled:	9.17.07 1350
Top of Casing Elevation:	16.60 (ft, msl)	Sampling Method:	Disposable Bailer
Depth to Water:	6.56 (ft)	Lab Analysis:	TPH-g/BTEX/VOCs
Groundwater Elevation:	10.04 (ft)	Preservatives:	Ice/HCL
Well Bottom Depth:	-3.40 (ft)	# of Containers:	6
Water Column Height:	13.44 (ft)	Sampling Personnel:	JVW
Well Casing Volume:	2.15 (WC* 0.16)	Weather Conditions:	clear/sunny/90/breezy
Casing Volumes Purged:			
Purge Rate:		Well Diameter:	2"

Time	Volume Removed (gal)	pH	Specific Conductivity (µmhos/cm)	Redox Potential (mVolts)	Temperature (°F or °C)	Turbidity (Visual)
13:25	0	6.53	1.09	—	23.87	clear
13:30	2.25	6.63	1.19	—	23.70	clear
13:35	4.50	6.68	1.25	—	22.38	clear
13:40	6.75	6.71	1.31	—	22.13	clear
:				—		
:						
:						
:						
:						
:						
:						
:						

Field Notes: No odor





**FIELD SAMPLING DATA SHEET**

Job Location:	Former Lemoine Sausage Factory	Job #:	33104-004578.00
	630 29th Avenue	Date Purged:	9/17/07
	Oakland, California	Purge Method:	Disposable Bailer
Sampling Location:	<b>MW-7</b>	Date & Time Sampled:	9/17/07 1610
Top of Casing Elevation:	15.47 (ft, msl)	Sampling Method:	Disposable Bailer
Depth to Water:	6.93 (ft)	Lab Analysis:	TPH-g/BTEX/VOCs
Groundwater Elevation:	8.54 (ft)	Preservatives:	Ice/HCL
Well Bottom Depth:	-4.53 (ft)	# of Containers:	6
Water Column Height:	13.07 (ft)	Sampling Personnel:	JVW
Well Casing Volume:	2.09 (WC* 0.16)	Weather Conditions:	clear/sunny/mild breeze
Casing Volumes Purged:			
Purge Rate:		Well Diameter:	2"

Time	Volume Removed (gal)	pH	Specific Conductivity (µmhos/cm)	Redox Potential (mVolts)	Temperature (°F or °C)	Turbidity (Visual)
15:50	0	6.88	1.21	—	21.33	clear
15:55	2.25	6.91	1.23	—	21.34	clear
16:00	4.50	6.93	1.24	—	20.66	clear
16:05	6.75	6.93	1.27	—	20.56	clear
:				—		
:				—		
:						
:						
:						
:						
:						
:						

Field Notes: *No odor*



**FIELD SAMPLING DATA SHEET**

Job Location: Former Lemoine Sausage Factory	Job #: 33104-004578.00
630 29th Avenue	Date Purged: 9/17/07
Oakland, California	Purge Method: Disposable Bailer
Sampling Location: <b>MW-8</b>	Date & Time Sampled: 9/17/07 1140
Top of Casing Elevation: 17.58 (ft, msl)	Sampling Method: Disposable Bailer
Depth to Water: 8.26 (ft)	Lab Analysis: TPH-g/BTEX/VOCs
Groundwater Elevation: 9.32 (ft)	Preservatives: Ice/HCL
Well Bottom Depth: -2.42 (ft)	# of Containers: 6
Water Column Height: 11.74 (ft)	Sampling Personnel: JWV
Well Casing Volume: 1.88 (WC* 0.16)	Weather Conditions: clear/sunny/breezy
Casing Volumes Purged:	mild
Purge Rate:	Well Diameter: 2"

Time	Volume Removed (gal)	pH	Specific Conductivity (µmhos/cm)	Redox Potential (mVolts)	Temperature (°F or °C)	Turbidity (Visual)
11:20	0	7.33	1.55	—	17.72	clear
11:25	2	6.71	1.53	—	17.44	clear
11:30	4	6.53	1.52	—	17.00	clear
11:35	6	6.55	1.54	—	16.95	clear
:				—		
:						
:						
:						
:						
:						
:						
:						
:						

Field Notes: Strong Petroleum Odor

Strong Petroleum Odor



**FIELD SAMPLING DATA SHEET**

Job Location:	Former Lemoine Sausage Factory	Job #:	33104-004578.00
	630 29th Avenue	Date Purged:	9.17.07
	Oakland, California	Purge Method:	Disposable Bailer
Sampling Location:	<b>MW-9</b>	Date & Time Sampled:	9.17.07 12:30
Top of Casing Elevation:	17.61 (ft, msl)	Sampling Method:	Disposable Bailer
Depth to Water:	7.26 (ft)	Lab Analysis:	TPH-g/BTEX/VOCs
Groundwater Elevation:	10.35 (ft)	Preservatives:	Ice/HCL
Well Bottom Depth:	2.61 (ft)	# of Containers:	6
Water Column Height:	7.74 (ft)	Sampling Personnel:	JVW
Well Casing Volume:	1.24 (WC* 0.16)	Weather Conditions:	clear/sunny/breezy/mild
Casing Volumes Purged:		Well Diameter:	2"
Purge Rate:			

Time	Volume Removed (gal)	pH	Specific Conductivity (µmhos/cm)	Redox Potential (mVolts)	Temperature (°F or °C)	Turbidity (Visual)
12:00	0	6.45	10.72	—	18.12	clear
12:05	1.25	6.93	10.60	—	18.03	clear
12:10	2.50	6.69	10.89	—	17.96	clear
12:15	3.25	6.78	11.21	—	17.87	clear
:				—		
:						
:						
:						
:						
:						
:						
:						

**Field Notes:** Strong petroleum odor

Well purged dry during 3rd purging event waited ~ 15 min until well recharged + sampled

Well cap missing bolts



**FIELD SAMPLING DATA SHEET**

Job Location:	Former Lemoine Sausage Factory	Job #:	33104-004578.00
	630 29th Avenue	Date Purged:	9.17.07
	Oakland, California	Purge Method:	Disposable Bailer
Sampling Location:	<b>MW-10</b>	Date & Time Sampled:	9.17.07 1430
Top of Casing Elevation:	16.92 (ft, msl)	Sampling Method:	Disposable Bailer
Depth to Water:	6.48 (ft)	Lab Analysis:	TPH-g/BTEX/VOCs
Groundwater Elevation:	10.44 (ft)	Preservatives:	Ice/HCL
Well Bottom Depth:	7.92 (ft)	# of Containers:	6
Water Column Height:	2.52 (ft)	Sampling Personnel:	JVW
Well Casing Volume:	0.40 (WC* 0.16)	Weather Conditions:	Sunny/clear 70 / breezy
Casing Volumes Purged:		Well Diameter:	2"
Purge Rate:			

Time	Volume Removed (gal)	pH	Specific Conductivity (µmhos/cm)	Redox Potential (mVolts)	Temperature (°F or °C)	Turbidity (Visual)
14:05	0	6.46	0.838	—	25.71	Clear
14:08	0.50	6.58	0.843	—	25.68	Clear
14:12	1.0	6.82	0.824	—	25.68	Clear
14:15	1.50	6.85	0.824	—	25.70	Clear
:						
:						
:						
:						
:						
:						
:						
:						
:						

**Field Notes:** No odor  
 Well purged close to dry, waited 15 min for recharge to original elev.





**FIELD SAMPLING DATA SHEET**

Job Location:	Former Lemoine Sausage Factory	Job #:	33104-004578.00
	630 29th Avenue	Date Purged:	9/17/07
	Oakland, California	Purge Method:	Disposable Bailer
Sampling Location:	<b>MW-12</b>	Date & Time Sampled:	9/17/07 1540
Top of Casing Elevation:	14.05 (ft, msl)	Sampling Method:	Disposable Bailer
Depth to Water:	6.59 (ft)	Lab Analysis:	TPH-g/BTEX/VOCs
Groundwater Elevation:	7.46 (ft)	Preservatives:	Ice/HCL
Well Bottom Depth:	-0.95 (ft)	# of Containers:	6
Water Column Height:	8.41 (ft)	Sampling Personnel:	JVW
Well Casing Volume:	1.35 (WC* 0.16)	Weather Conditions:	clear/sunny/NO/breezy
Casing Volumes Purged:		Well Diameter:	2"
Purge Rate:			

Time	Volume Removed (gal)	pH	Specific Conductivity (µmhos/cm)	Redox Potential (mVolts)	Temperature (°F or °C)	Turbidity (Visual)
15:15	0	7.02	1.53	—	22.02	clear
15:20	1.5	7.06	1.55	—	22.04	clear
15:25	3.0	7.01	1.55	—	21.30	clear
15:30	4.5	6.98	1.56	—	21.27	clear
:				—		
:				—		
:						
:						
:						
:						
:						
:						

Field Notes: No apparent odor



**FIELD SAMPLING DATA SHEET**

Job Location: Former Lemoine Sausage Factory	Job #: 33104-004578.00
630 29th Avenue	Date Purged: 9.17.09
Oakland, California	Purge Method: Disposable Bailer
Sampling Location: <b>MW-13</b>	Date & Time Sampled: 9.17.09 1505
Top of Casing Elevation: 13.39 (ft, msl)	Sampling Method: Disposable Bailer
Depth to Water: 6.65 (ft)	Lab Analysis: TPH-g/BTEX/VOCs
Groundwater Elevation: 6.74 (ft)	Preservatives: Ice/HCL
Well Bottom Depth: -1.61 (ft)	# of Containers: 6
Water Column Height: 8.35 (ft)	Sampling Personnel: JWV
Well Casing Volume: 1.34 (WC* 0.16)	Weather Conditions: Sunny/Clear/90% / breezy
Casing Volumes Purged:	
Purge Rate:	Well Diameter: 2"

Time	Volume Removed (gal)	pH	Specific Conductivity (µmhos/cm)	Redox Potential (mVolts)	Temperature (°F or °C)	Turbidity (Visual)
14:45	0	6.75	1.06	—	23.24	Clear
14:48	1.5	6.78	1.08	—	23.25	Clear
14:53	3.0	6.83	1.09	—	22.26	Clear
14:58	4.5	6.87	1.09	—	22.28	Clear
:				—		
:				—		
:						
:						
:						
:						
:						
:						

Field Notes: Strong Petroleum odor



## **APPENDIX B**

# **CHAIN-OF-CUSTODY DOCUMENTATION AND CERTIFIED ANALYTICAL REPORTS**





### CASE NARRATIVE

Laboratory number: 197672  
Client: Bureau Veritas North America  
Project: 33104-004578.00  
Location: Sausage Factory  
Request Date: 09/17/07  
Samples Received: 09/17/07

This hardcopy data package contains sample and QC results for nine water samples, requested for the above referenced project on 09/17/07. The samples were received on ice and intact.

**TPH-Purgeables and/or BTXE by GC (EPA 8015B and EPA 8021B):**

Low surrogate recovery was observed for trifluorotoluene (FID) in MW-13 (lab # 197672-009); the corresponding bromofluorobenzene (FID) surrogate recovery was within limits. High surrogate recoveries were also observed for trifluorotoluene (FID) in the LCS for batch 129617 and the MS/MSD of MW-06 (lab # 197672-003); the corresponding bromofluorobenzene (FID) surrogate recoveries were within limits. No other analytical problems were encountered.

**Volatile Organics by GC/MS (EPA 8260B):**

MW-01 (lab # 197672-001) and MW-06 (lab # 197672-003) had pH greater than 2. These samples were analyzed within the seven day holding time for unpreserved waters. No other analytical problems were encountered.

**Curtis & Tompkins Laboratories Analytical Report**

Lab #:	197672	Location:	Sausage Factory
Client:	Bureau Veritas North America	Prep:	EPA 5030B
Project#:	33104-004578.00		
Matrix:	Water	Sampled:	09/17/07
Units:	ug/L	Received:	09/17/07
Batch#:	129617		

Field ID: MW-01 Diln Fac: 10.00  
 Type: SAMPLE Analyzed: 09/18/07  
 Lab ID: 197672-001

Analyte	Result	RL	Analysis
Gasoline C7-C12	9,000	500	EPA 8015B
Benzene	1,200	5.0	EPA 8021B
Toluene	230	5.0	EPA 8021B
Ethylbenzene	450	5.0	EPA 8021B
m,p-Xylenes	410	5.0	EPA 8021B
o-Xylene	61	5.0	EPA 8021B

Surrogate	%REC	Limits	Analysis
Trifluorotoluene (FID)	117	73-134	EPA 8015B
Bromofluorobenzene (FID)	95	77-140	EPA 8015B
Trifluorotoluene (PID)	128	65-142	EPA 8021B
Bromofluorobenzene (PID)	95	74-135	EPA 8021B

Field ID: MW-02 Diln Fac: 50.00  
 Type: SAMPLE Analyzed: 09/18/07  
 Lab ID: 197672-002

Analyte	Result	RL	Analysis
Gasoline C7-C12	11,000	2,500	EPA 8015B
Benzene	9,200	25	EPA 8021B
Toluene	410	25	EPA 8021B
Ethylbenzene	1,100	25	EPA 8021B
m,p-Xylenes	980	25	EPA 8021B
o-Xylene	320	25	EPA 8021B

Surrogate	%REC	Limits	Analysis
Trifluorotoluene (FID)	113	73-134	EPA 8015B
Bromofluorobenzene (FID)	96	77-140	EPA 8015B
Trifluorotoluene (PID)	106	65-142	EPA 8021B
Bromofluorobenzene (PID)	92	74-135	EPA 8021B

\*= Value outside of QC limits; see narrative  
 C= Presence confirmed, but RPD between columns exceeds 40%  
 L= Lighter hydrocarbons contributed to the quantitation  
 Y= Sample exhibits chromatographic pattern which does not resemble standard  
 ND= Not Detected  
 RL= Reporting Limit

**Curtis & Tompkins Laboratories Analytical Report**

Lab #:	197672	Location:	Sausage Factory
Client:	Bureau Veritas North America	Prep:	EPA 5030B
Project#:	33104-004578.00		
Matrix:	Water	Sampled:	09/17/07
Units:	ug/L	Received:	09/17/07
Batch#:	129617		

Field ID:	MW-06	Diln Fac:	1.000
Type:	SAMPLE	Analyzed:	09/19/07
Lab ID:	197672-003		

Analyte	Result	RL	Analysis
Gasoline C7-C12	ND	50	EPA 8015B
Benzene	ND	0.50	EPA 8021B
Toluene	ND	0.50	EPA 8021B
Ethylbenzene	ND	0.50	EPA 8021B
m,p-Xylenes	ND	0.50	EPA 8021B
o-Xylene	ND	0.50	EPA 8021B

Surrogate	%REC	Limits	Analysis
Trifluorotoluene (FID)	102	73-134	EPA 8015B
Bromofluorobenzene (FID)	99	77-140	EPA 8015B
Trifluorotoluene (PID)	96	65-142	EPA 8021B
Bromofluorobenzene (PID)	93	74-135	EPA 8021B

Field ID:	MW-07	Diln Fac:	1.000
Type:	SAMPLE	Analyzed:	09/19/07
Lab ID:	197672-004		

Analyte	Result	RL	Analysis
Gasoline C7-C12	ND	50	EPA 8015B
Benzene	ND	0.50	EPA 8021B
Toluene	ND	0.50	EPA 8021B
Ethylbenzene	ND	0.50	EPA 8021B
m,p-Xylenes	ND	0.50	EPA 8021B
o-Xylene	ND	0.50	EPA 8021B

Surrogate	%REC	Limits	Analysis
Trifluorotoluene (FID)	107	73-134	EPA 8015B
Bromofluorobenzene (FID)	105	77-140	EPA 8015B
Trifluorotoluene (PID)	97	65-142	EPA 8021B
Bromofluorobenzene (PID)	94	74-135	EPA 8021B

\*= Value outside of QC limits; see narrative  
 C= Presence confirmed, but RPD between columns exceeds 40%  
 L= Lighter hydrocarbons contributed to the quantitation  
 Y= Sample exhibits chromatographic pattern which does not resemble standard  
 ND= Not Detected  
 RL= Reporting Limit

**Curtis & Tompkins Laboratories Analytical Report**

Lab #:	197672	Location:	Sausage Factory
Client:	Bureau Veritas North America	Prep:	EPA 5030B
Project#:	33104-004578.00		
Matrix:	Water	Sampled:	09/17/07
Units:	ug/L	Received:	09/17/07
Batch#:	129617		

Field ID: MW-08 Diln Fac: 1.000  
 Type: SAMPLE Analyzed: 09/19/07  
 Lab ID: 197672-005

Analyte	Result	RL	Analysis
Gasoline C7-C12	3,300 L Y	50	EPA 8015B
Benzene	230	0.50	EPA 8021B
Toluene	ND	0.50	EPA 8021B
Ethylbenzene	140	0.50	EPA 8021B
m,p-Xylenes	ND	0.50	EPA 8021B
o-Xylene	ND	0.50	EPA 8021B

Surrogate	%REC	Limits	Analysis
Trifluorotoluene (FID)	113	73-134	EPA 8015B
Bromofluorobenzene (FID)	116	77-140	EPA 8015B
Trifluorotoluene (PID)	102	65-142	EPA 8021B
Bromofluorobenzene (PID)	103	74-135	EPA 8021B

Field ID: MW-09 Diln Fac: 50.00  
 Type: SAMPLE Analyzed: 09/18/07  
 Lab ID: 197672-006

Analyte	Result	RL	Analysis
Gasoline C7-C12	19,000	2,500	EPA 8015B
Benzene	9,600	25	EPA 8021B
Toluene	250	25	EPA 8021B
Ethylbenzene	1,000	25	EPA 8021B
m,p-Xylenes	2,100	25	EPA 8021B
o-Xylene	440	25	EPA 8021B

Surrogate	%REC	Limits	Analysis
Trifluorotoluene (FID)	119	73-134	EPA 8015B
Bromofluorobenzene (FID)	94	77-140	EPA 8015B
Trifluorotoluene (PID)	109	65-142	EPA 8021B
Bromofluorobenzene (PID)	93	74-135	EPA 8021B

\*= Value outside of QC limits; see narrative  
 C= Presence confirmed, but RPD between columns exceeds 40%  
 L= Lighter hydrocarbons contributed to the quantitation  
 Y= Sample exhibits chromatographic pattern which does not resemble standard  
 ND= Not Detected  
 RL= Reporting Limit

**Curtis & Tompkins Laboratories Analytical Report**

Lab #:	197672	Location:	Sausage Factory
Client:	Bureau Veritas North America	Prep:	EPA 5030B
Project#:	33104-004578.00		
Matrix:	Water	Sampled:	09/17/07
Units:	ug/L	Received:	09/17/07
Batch#:	129617		

Field ID: MW-10 Diln Fac: 1.000  
 Type: SAMPLE Analyzed: 09/19/07  
 Lab ID: 197672-007

Analyte	Result	RL	Analysis
Gasoline C7-C12	ND	50	EPA 8015B
Benzene	ND	0.50	EPA 8021B
Toluene	ND	0.50	EPA 8021B
Ethylbenzene	ND	0.50	EPA 8021B
m,p-Xylenes	ND	0.50	EPA 8021B
o-Xylene	ND	0.50	EPA 8021B

Surrogate	%REC	Limits	Analysis
Trifluorotoluene (FID)	98	73-134	EPA 8015B
Bromofluorobenzene (FID)	92	77-140	EPA 8015B
Trifluorotoluene (PID)	89	65-142	EPA 8021B
Bromofluorobenzene (PID)	86	74-135	EPA 8021B

Field ID: MW-12 Diln Fac: 1.000  
 Type: SAMPLE Analyzed: 09/19/07  
 Lab ID: 197672-008

Analyte	Result	RL	Analysis
Gasoline C7-C12	84 L Y	50	EPA 8015B
Benzene	ND	0.50	EPA 8021B
Toluene	ND	0.50	EPA 8021B
Ethylbenzene	ND	0.50	EPA 8021B
m,p-Xylenes	ND	0.50	EPA 8021B
o-Xylene	ND	0.50	EPA 8021B

Surrogate	%REC	Limits	Analysis
Trifluorotoluene (FID)	102	73-134	EPA 8015B
Bromofluorobenzene (FID)	98	77-140	EPA 8015B
Trifluorotoluene (PID)	100	65-142	EPA 8021B
Bromofluorobenzene (PID)	88	74-135	EPA 8021B

\*= Value outside of QC limits; see narrative  
 C= Presence confirmed, but RPD between columns exceeds 40%  
 L= Lighter hydrocarbons contributed to the quantitation  
 Y= Sample exhibits chromatographic pattern which does not resemble standard  
 ND= Not Detected  
 RL= Reporting Limit



## Batch QC Report

**Curtis & Tompkins Laboratories Analytical Report**

Lab #:	197672	Location:	Sausage Factory
Client:	Bureau Veritas North America	Prep:	EPA 5030B
Project#:	33104-004578.00	Analysis:	EPA 8021B
Type:	LCS	Diln Fac:	1.000
Lab ID:	QC406743	Batch#:	129617
Matrix:	Water	Analyzed:	09/18/07
Units:	ug/L		

Analyte	Spiked	Result	%REC	Limits
Benzene	20.00	18.68	93	80-120
Toluene	20.00	18.53	93	80-120
Ethylbenzene	20.00	18.53	93	80-120
m,p-Xylenes	20.00	18.69	93	80-121
o-Xylene	20.00	18.26	91	80-120

Surrogate	%REC	Limits
Trifluorotoluene (PID)	96	65-142
Bromofluorobenzene (PID)	91	74-135



## Batch QC Report

**Curtis & Tompkins Laboratories Analytical Report**

Lab #:	197672	Location:	Sausage Factory
Client:	Bureau Veritas North America	Prep:	EPA 5030B
Project#:	33104-004578.00	Analysis:	EPA 8015B
Type:	LCS	Diln Fac:	1.000
Lab ID:	QC406744	Batch#:	129617
Matrix:	Water	Analyzed:	09/18/07
Units:	ug/L		

Analyte	Spiked	Result	%REC	Limits
Gasoline C7-C12	2,000	1,811	91	79-120

Surrogate	%REC	Limits
Trifluorotoluene (FID)	141 *	73-134
Bromofluorobenzene (FID)	100	77-140

\*= Value outside of QC limits; see narrative

## Batch QC Report

**Curtis & Tompkins Laboratories Analytical Report**

Lab #:	197672	Location:	Sausage Factory
Client:	Bureau Veritas North America	Prep:	EPA 5030B
Project#:	33104-004578.00	Analysis:	EPA 8015B
Field ID:	MW-06	Batch#:	129617
MSS Lab ID:	197672-003	Sampled:	09/17/07
Matrix:	Water	Received:	09/17/07
Units:	ug/L	Analyzed:	09/18/07
Diln Fac:	1.000		

Type: MS Lab ID: QC406745

Analyte	MSS Result	Spiked	Result	%REC	Limits
Gasoline C7-C12	39.04	2,000	1,726	84	72-120

Surrogate	%REC	Limits
Trifluorotoluene (FID)	146 *	73-134
Bromofluorobenzene (FID)	104	77-140

Type: MSD Lab ID: QC406746

Analyte	Spiked	Result	%REC	Limits	RPD	Lim
Gasoline C7-C12	2,000	1,711	84	72-120	1	20

Surrogate	%REC	Limits
Trifluorotoluene (FID)	146 *	73-134
Bromofluorobenzene (FID)	108	77-140

\*= Value outside of QC limits; see narrative

RPD= Relative Percent Difference

Sequence File: \\Lims\gdrive\ezchrom\Projects\GC04\Sequence\261.seq  
 Sample Name: 197672-001,129617,10x,tvh+btxe  
 Data File: \\Lims\gdrive\ezchrom\Projects\GC04\Data\261\_009  
 Instrument: GC04 (Offline) Vial: N/A Operator: Tvh 2. Analyst (lims2k3\tvh2)  
 Method Name: \\Lims\gdrive\ezchrom\Projects\GC04\Method\tvhbtxe260 Surrfun.met

Software Version 3.1.7  
 Run Date: 9/18/2007 9:50:22 PM  
 Analysis Date: 9/19/2007 12:32:35 PM  
 Sample Amount: 5 Multiplier: 5  
 Vial & pH or Core ID: A1.3

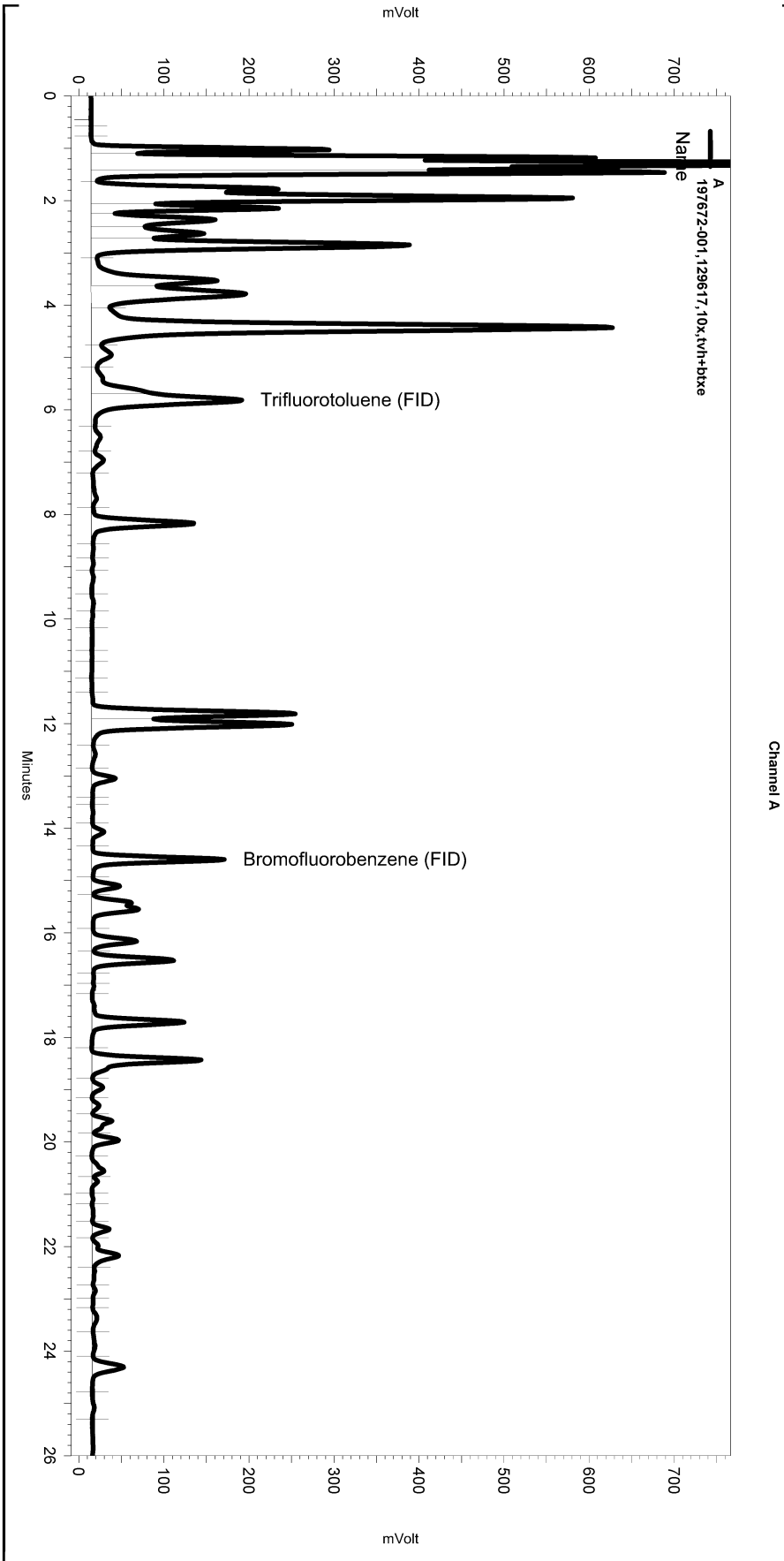

---< General Method Parameters >---

No items selected for this section

---< A >---

No items selected for this section

Integration Events

Enabled	Event Type	Start (Minutes)	Stop (Minutes)	Value
Yes	Width	0	0	0.2
Yes	Threshold	0	0	50

Manual Integration Fixes

Data File: \\Lims\gdrive\ezchrom\Projects\GC04\Data\261\_009

Enabled	Event Type	Start (Minutes)	Stop (Minutes)	Value
Yes	Split Peak	5.706	0	0

Sequence File: \\Lims\gdrive\ezchrom\Projects\GC04\Sequence\261.seq  
 Sample Name: 197672-002,129617,50x,tvh+btxe  
 Data File: \\Lims\gdrive\ezchrom\Projects\GC04\Data\261\_007  
 Instrument: GC04 (Offline) Vial: N/A Operator: Tvh 2. Analyst (lims2k3\tvh2)  
 Method Name: \\Lims\gdrive\ezchrom\Projects\GC04\Method\tvhbtxe260 Surrfun.met

Software Version 3.1.7  
 Run Date: 9/18/2007 8:34:33 PM  
 Analysis Date: 9/19/2007 11:53:09 AM  
 Sample Amount: 5 Multiplier: 5  
 Vial & pH or Core ID: A1.3

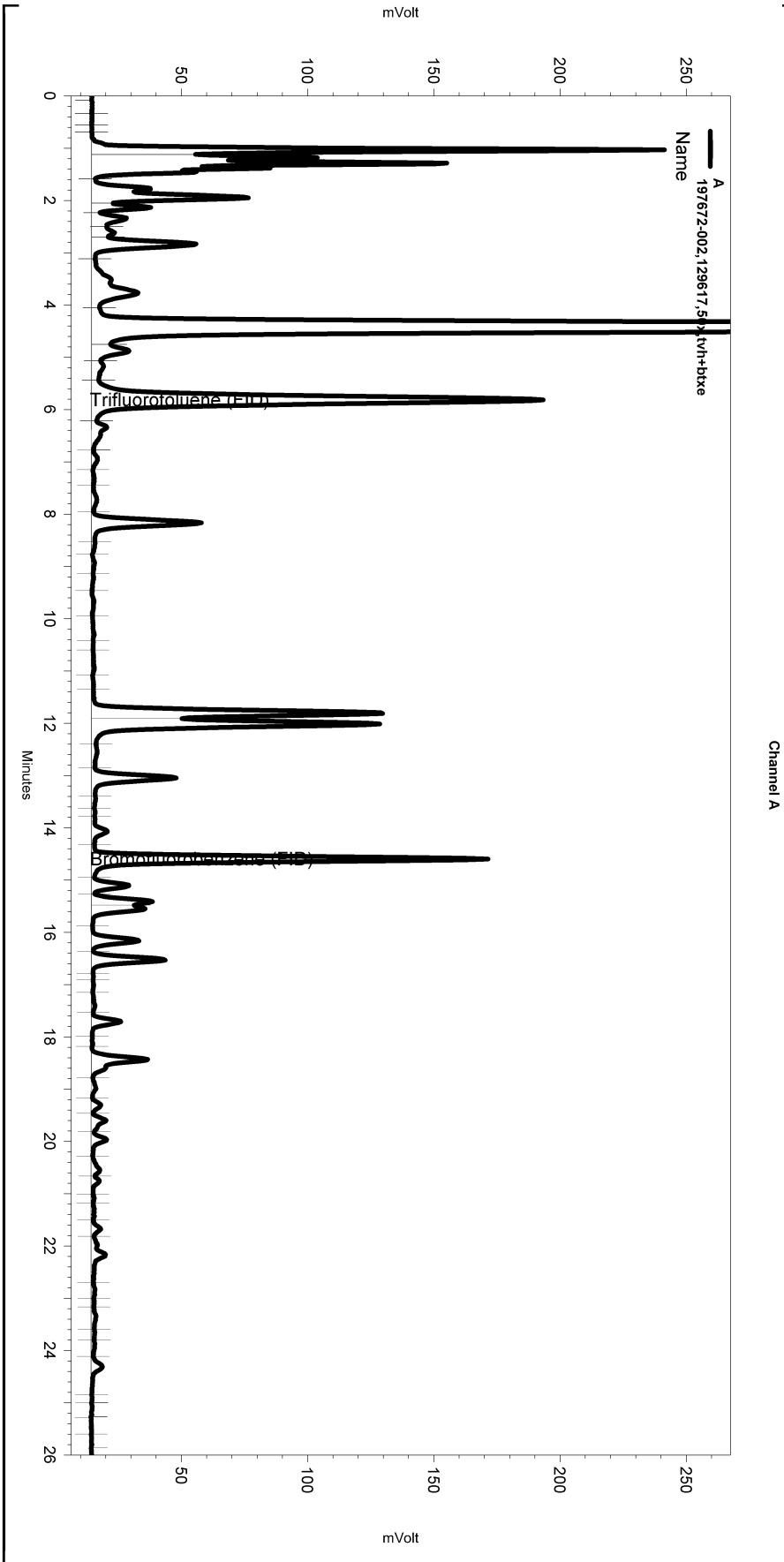

---< General Method Parameters >---

No items selected for this section

---< A >---

No items selected for this section

Integration Events

Enabled	Event Type	Start (Minutes)	Stop (Minutes)	Value
Yes	Width	0	0	0.2
Yes	Threshold	0	0	50

Manual Integration Fixes

Data File: \\Lims\gdrive\ezchrom\Projects\GC04\Data\261\_007

Enabled	Event Type	Start (Minutes)	Stop (Minutes)	Value
None				

Sequence File: \\Lims\gdrive\ezchrom\Projects\GC04\Sequence\261.seq  
 Sample Name: 197672-005,129617,tvh+btxe  
 Data File: \\Lims\gdrive\ezchrom\Projects\GC04\Data\261\_020  
 Instrument: GC04 (Offline) Vial: N/A Operator: Tvh 2. Analyst (lims2k3\tvh2)  
 Method Name: \\Lims\gdrive\ezchrom\Projects\GC04\Method\tvhbtxe260 Surrfun.met

Software Version 3.1.7  
 Run Date: 9/19/2007 4:47:46 AM  
 Analysis Date: 9/19/2007 11:54:01 AM  
 Sample Amount: 5 Multiplier: 5  
 Vial & pH or Core ID: A1.3

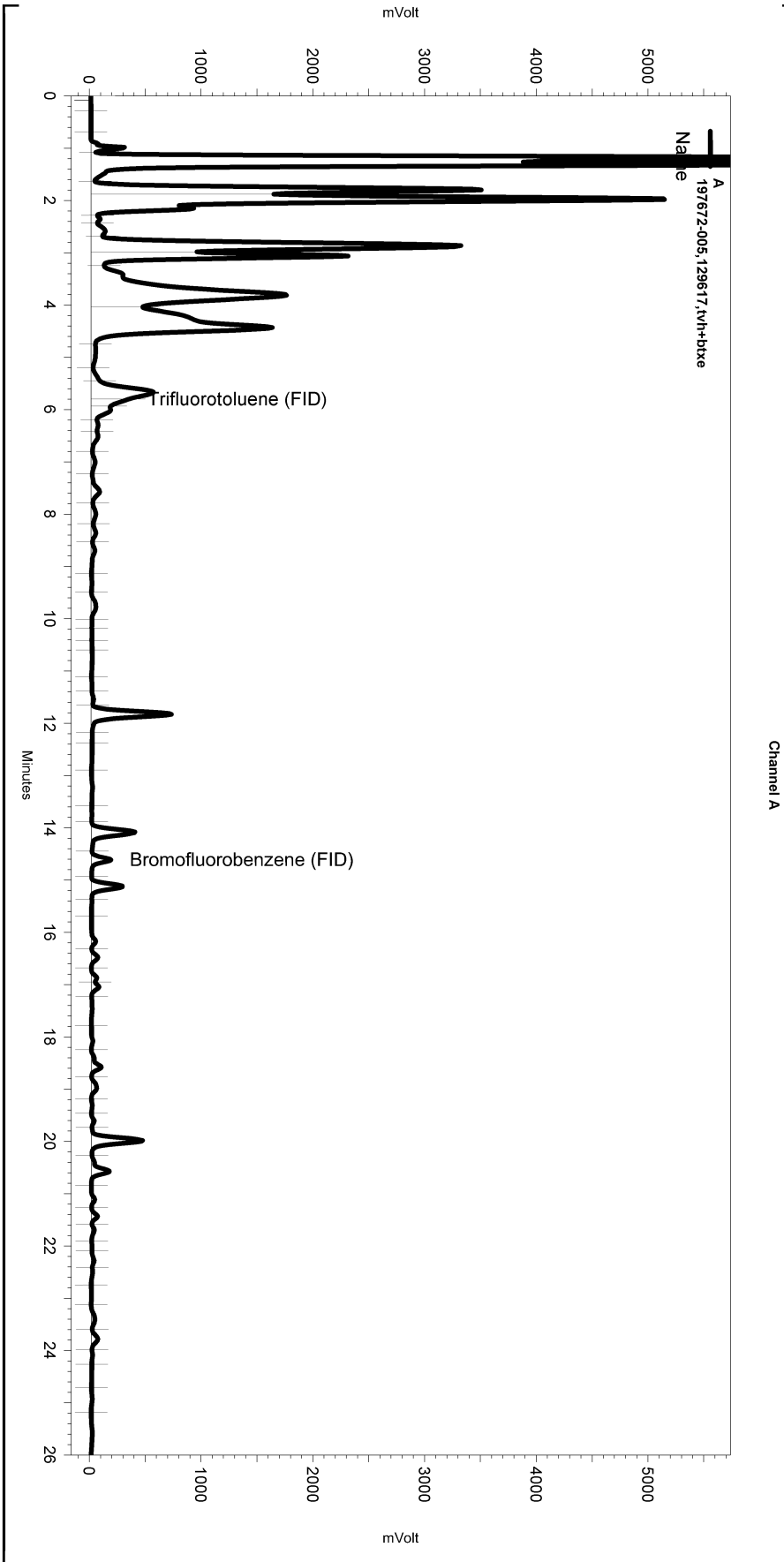

---< General Method Parameters >---

No items selected for this section

---< A >---

No items selected for this section

Integration Events

Enabled	Event Type	Start (Minutes)	Stop (Minutes)	Value
Yes	Width	0	0	0.2
Yes	Threshold	0	0	50

Manual Integration Fixes

Data File: \\Lims\gdrive\ezchrom\Projects\GC04\Data\261\_020

Enabled	Event Type	Start (Minutes)	Stop (Minutes)	Value
Yes	Split Peak	5.451	0	0
Yes	Split Peak	5.798	0	0
Yes	Split Peak	5.936	0	0

Sequence File: \\Lims\gdrive\ezchrom\Projects\GC04\Sequence\261.seq  
 Sample Name: 197672-006,129617,50x,tvh+btxe  
 Data File: \\Lims\gdrive\ezchrom\Projects\GC04\Data\261\_008  
 Instrument: GC04 (Offline) Vial: N/A Operator: Tvh 2. Analyst (lims2k3\tvh2)  
 Method Name: \\Lims\gdrive\ezchrom\Projects\GC04\Method\tvhbtxe260 Surrfun.met

Software Version 3.1.7  
 Run Date: 9/18/2007 9:12:28 PM  
 Analysis Date: 9/19/2007 12:24:56 PM  
 Sample Amount: 5 Multiplier: 5  
 Vial & pH or Core ID: A1.3

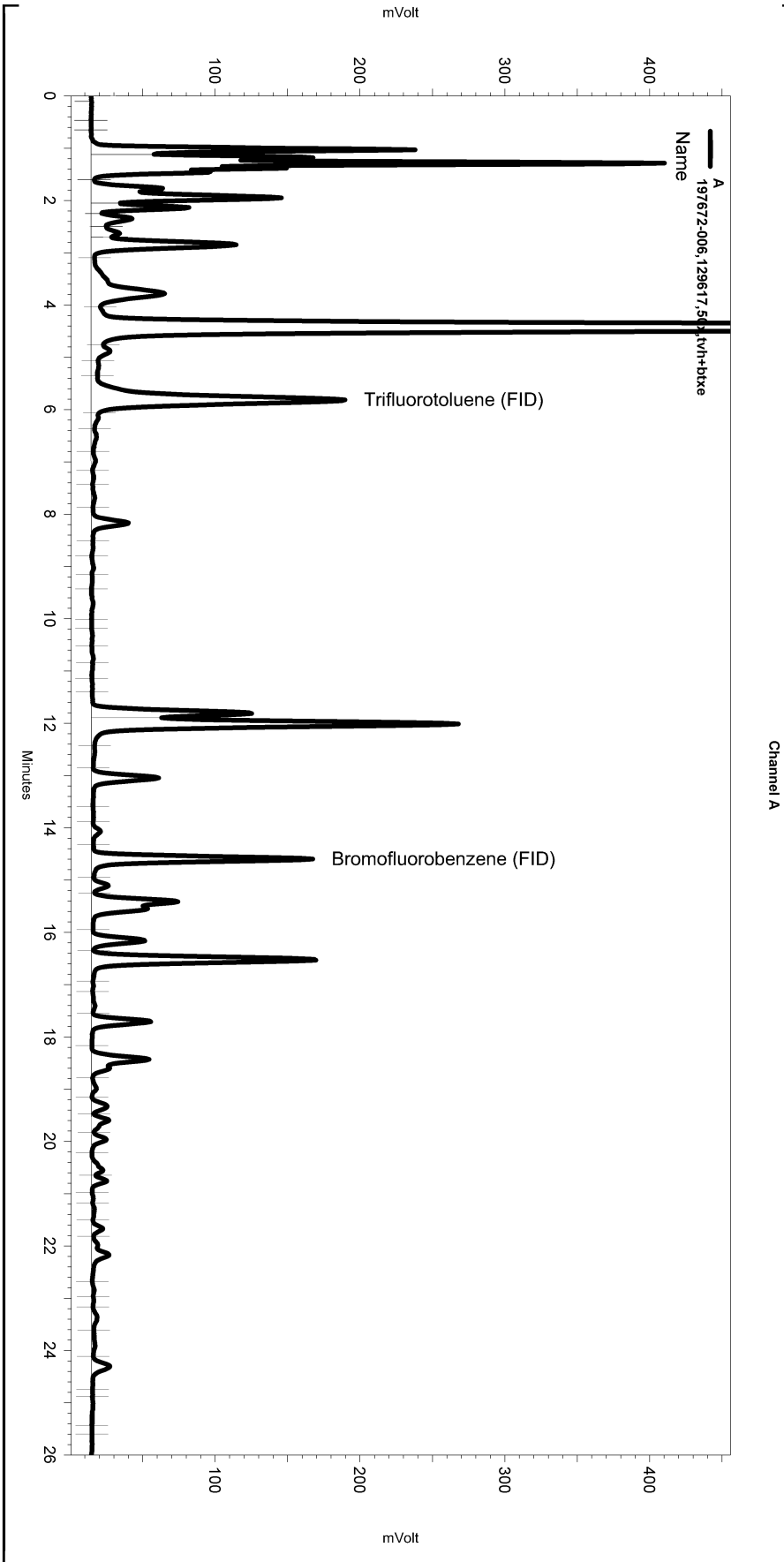

---< General Method Parameters >---

No items selected for this section

---< A >---

No items selected for this section

Integration Events

Enabled	Event Type	Start (Minutes)	Stop (Minutes)	Value
Yes	Width	0	0	0.2
Yes	Threshold	0	0	50

Manual Integration Fixes

Data File: \\Lims\gdrive\ezchrom\Projects\GC04\Data\261\_008

Enabled	Event Type	Start (Minutes)	Stop (Minutes)	Value
Yes	Split Peak	6.072	0	0

Sequence File: \\Lims\gdrive\ezchrom\Projects\GC04\Sequence\261.seq  
 Sample Name: 197672-008,129617,tvh+btxe  
 Data File: \\Lims\gdrive\ezchrom\Projects\GC04\Data\261\_022  
 Instrument: GC04 (Offline) Vial: N/A Operator: Tvh 2. Analyst (lims2k3\tvh2)  
 Method Name: \\Lims\gdrive\ezchrom\Projects\GC04\Method\TVHBTXE260 Surrfun.met

Software Version 3.1.7  
 Run Date: 9/19/2007 6:03:42 AM  
 Analysis Date: 9/19/2007 11:54:08 AM  
 Sample Amount: 5 Multiplier: 5  
 Vial & pH or Core ID: A1.3

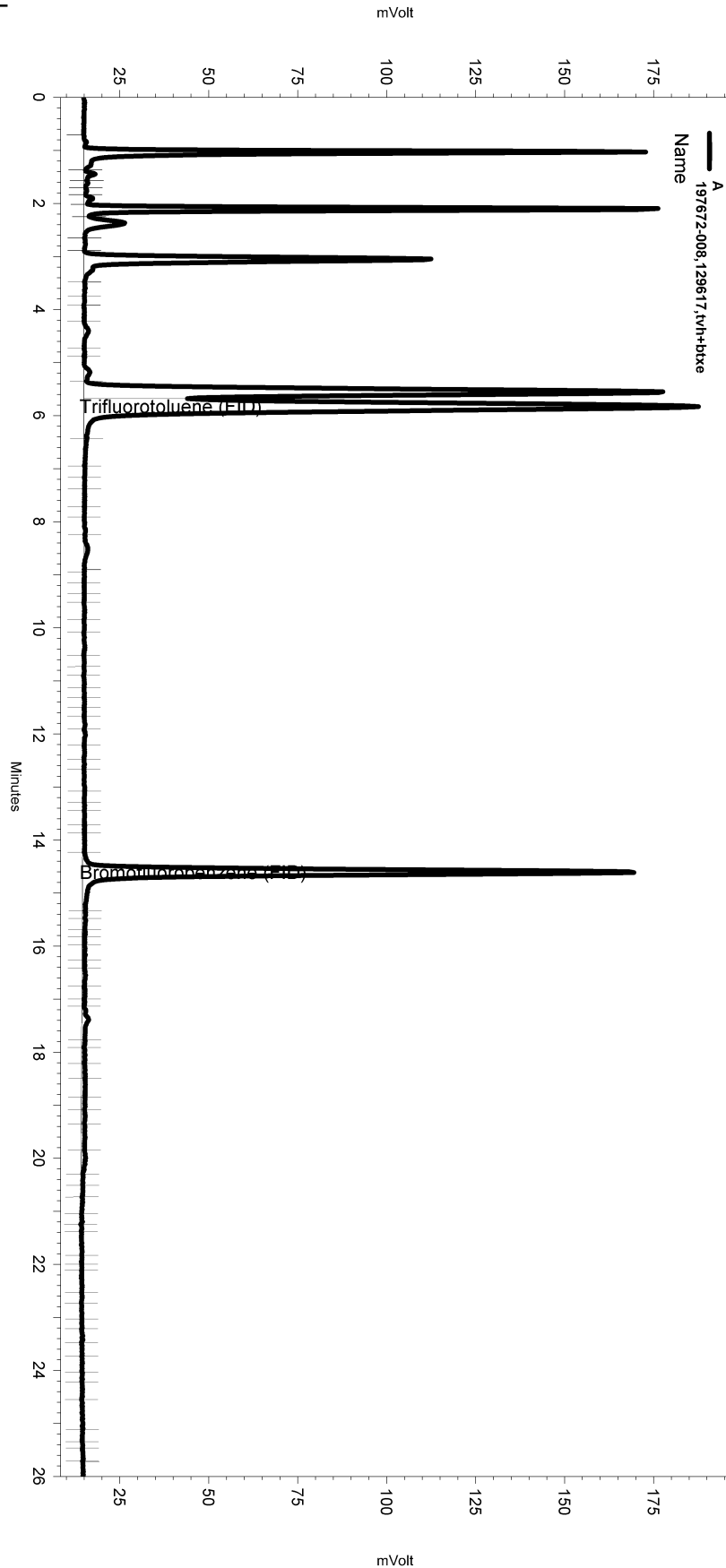

Channel A

---< General Method Parameters >---

No items selected for this section

---< A >---

No items selected for this section

Integration Events

Enabled	Event Type	Start (Minutes)	Stop (Minutes)	Value
Yes	Width	0	0	0.2
Yes	Threshold	0	0	50

Manual Integration Fixes

Data File: \\Lims\gdrive\ezchrom\Projects\GC04\Data\261\_022

Enabled	Event Type	Start (Minutes)	Stop (Minutes)	Value
None				

Sequence File: \\Lims\gdrive\ezchrom\Projects\GC04\Sequence\261.seq  
 Sample Name: 197672-009,129617,tvh+btxe,rr  
 Data File: \\Lims\gdrive\ezchrom\Projects\GC04\Data\261\_028  
 Instrument: GC04 (Offline) Vial: N/A Operator: Tvh 2. Analyst (lims2k3\tvh2)  
 Method Name: \\Lims\gdrive\ezchrom\Projects\GC04\Method\tvhbtxe260 Surrfun.met

Software Version 3.1.7  
 Run Date: 9/19/2007 9:55:07 AM  
 Analysis Date: 9/19/2007 12:56:10 PM  
 Sample Amount: 5 Multiplier: 5  
 Vial & pH or Core ID: {Data Description}

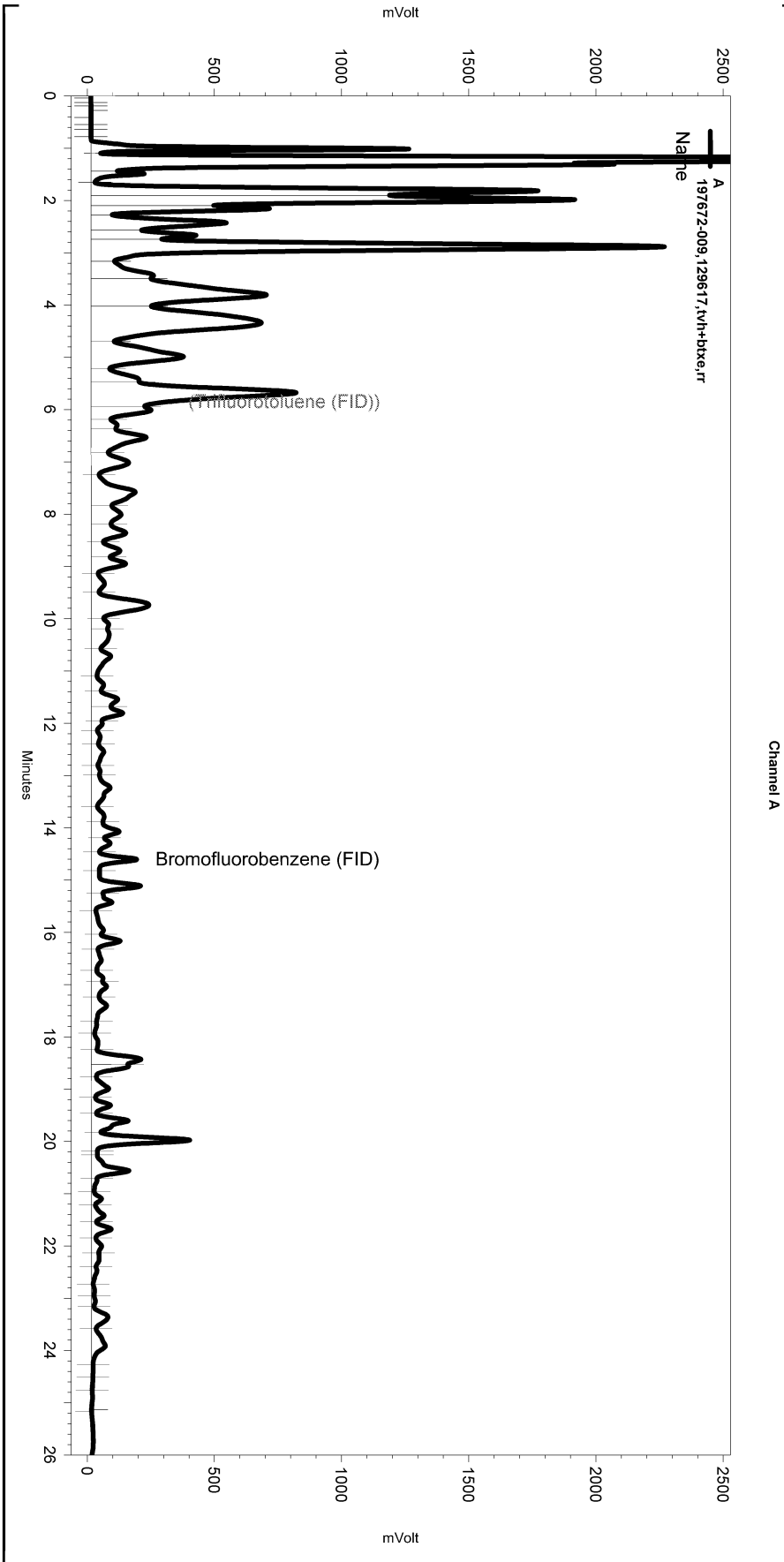

---< General Method Parameters >---

No items selected for this section

---< A >---

No items selected for this section

Integration Events

Enabled	Event Type	Start (Minutes)	Stop (Minutes)	Value
Yes	Width	0	0	0.2
Yes	Threshold	0	0	50

Manual Integration Fixes

Data File: \\Lims\gdrive\ezchrom\Projects\GC04\Data\261\_028

Enabled	Event Type	Start (Minutes)	Stop (Minutes)	Value
Yes	Split Peak	5.474	0	0



Sequence File: \\Lims\gdrive\ezchrom\Projects\GC04\Sequence\261.seq  
 Sample Name: ccv/lcs,qc406744,129617,s7170,5/5000  
 Data File: \\Lims\gdrive\ezchrom\Projects\GC04\Data\261\_003  
 Instrument: GC04 (Offline) Vial: N/A Operator: Tvh 2. Analyst (lims2k3\tvh2)  
 Method Name: \\Lims\gdrive\ezchrom\Projects\GC04\Method\tvhbtxe260 Surrfun.met

Software Version 3.1.7  
 Run Date: 9/18/2007 5:23:33 PM  
 Analysis Date: 9/19/2007 11:52:53 AM  
 Sample Amount: 5 Multiplier: 5  
 Vial & pH or Core ID: {Data Description}

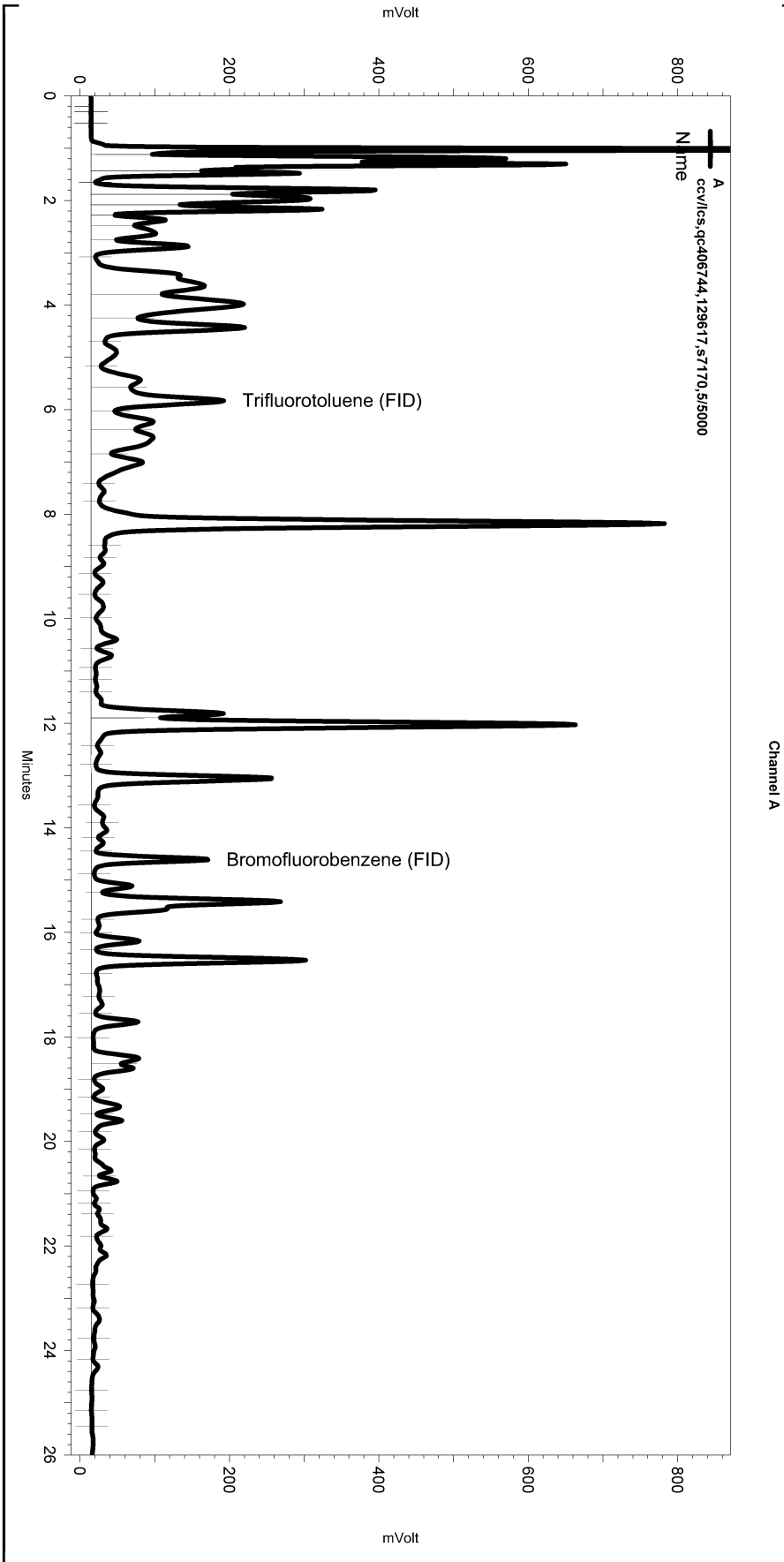

---< General Method Parameters >---

No items selected for this section

---< A >---

No items selected for this section

Integration Events

Enabled	Event Type	Start (Minutes)	Stop (Minutes)	Value
Yes	Width	0	0	0.2
Yes	Threshold	0	0	50

Manual Integration Fixes

Data File: \\Lims\gdrive\ezchrom\Projects\GC04\Data\261\_003

Enabled	Event Type	Start (Minutes)	Stop (Minutes)	Value
None				

### Purgeable Halocarbons by GC/MS

Lab #:	197672	Location:	Sausage Factory
Client:	Bureau Veritas North America	Prep:	EPA 5030B
Project#:	33104-004578.00	Analysis:	EPA 8260B
Field ID:	MW-01	Batch#:	129675
Lab ID:	197672-001	Sampled:	09/17/07
Matrix:	Water	Received:	09/17/07
Units:	ug/L	Analyzed:	09/20/07
Diln Fac:	4.000		

Analyte	Result	RL
Chloromethane	ND	4.0
Vinyl Chloride	ND	2.0
Bromomethane	ND	4.0
Chloroethane	ND	4.0
Trichlorofluoromethane	ND	4.0
Freon 113	ND	8.0
1,1-Dichloroethene	ND	2.0
Methylene Chloride	ND	80
trans-1,2-Dichloroethene	ND	2.0
1,1-Dichloroethane	ND	2.0
cis-1,2-Dichloroethene	ND	2.0
Chloroform	ND	4.0
1,1,1-Trichloroethane	ND	2.0
Carbon Tetrachloride	ND	2.0
1,2-Dichloroethane	ND	2.0
Trichloroethene	ND	2.0
1,2-Dichloropropane	ND	2.0
Bromodichloromethane	ND	2.0
cis-1,3-Dichloropropene	ND	2.0
trans-1,3-Dichloropropene	ND	2.0
1,1,2-Trichloroethane	ND	2.0
Tetrachloroethene	ND	2.0
Dibromochloromethane	ND	2.0
Chlorobenzene	ND	2.0
Bromoform	ND	2.0
1,1,2,2-Tetrachloroethane	ND	2.0
1,3-Dichlorobenzene	ND	2.0
1,4-Dichlorobenzene	ND	2.0
1,2-Dichlorobenzene	ND	2.0

Surrogate	%REC	Limits
1,2-Dichloroethane-d4	120	74-137
Toluene-d8	102	80-120
Bromofluorobenzene	103	80-120

ND= Not Detected  
 RL= Reporting Limit

### Purgeable Halocarbons by GC/MS

Lab #:	197672	Location:	Sausage Factory
Client:	Bureau Veritas North America	Prep:	EPA 5030B
Project#:	33104-004578.00	Analysis:	EPA 8260B
Field ID:	MW-02	Batch#:	129675
Lab ID:	197672-002	Sampled:	09/17/07
Matrix:	Water	Received:	09/17/07
Units:	ug/L	Analyzed:	09/20/07
Diln Fac:	25.00		

Analyte	Result	RL
Chloromethane	ND	25
Vinyl Chloride	ND	13
Bromomethane	ND	25
Chloroethane	ND	25
Trichlorofluoromethane	ND	25
Freon 113	ND	50
1,1-Dichloroethene	ND	13
Methylene Chloride	ND	500
trans-1,2-Dichloroethene	ND	13
1,1-Dichloroethane	ND	13
cis-1,2-Dichloroethene	ND	13
Chloroform	ND	25
1,1,1-Trichloroethane	ND	13
Carbon Tetrachloride	ND	13
1,2-Dichloroethane	ND	13
Trichloroethene	ND	13
1,2-Dichloropropane	ND	13
Bromodichloromethane	ND	13
cis-1,3-Dichloropropene	ND	13
trans-1,3-Dichloropropene	ND	13
1,1,2-Trichloroethane	ND	13
Tetrachloroethene	ND	13
Dibromochloromethane	ND	13
Chlorobenzene	ND	13
Bromoform	ND	13
1,1,2,2-Tetrachloroethane	ND	13
1,3-Dichlorobenzene	ND	13
1,4-Dichlorobenzene	ND	13
1,2-Dichlorobenzene	ND	13

Surrogate	%REC	Limits
1,2-Dichloroethane-d4	105	74-137
Toluene-d8	99	80-120
Bromofluorobenzene	101	80-120

ND= Not Detected

RL= Reporting Limit

### Purgeable Halocarbons by GC/MS

Lab #:	197672	Location:	Sausage Factory
Client:	Bureau Veritas North America	Prep:	EPA 5030B
Project#:	33104-004578.00	Analysis:	EPA 8260B
Field ID:	MW-06	Batch#:	129675
Lab ID:	197672-003	Sampled:	09/17/07
Matrix:	Water	Received:	09/17/07
Units:	ug/L	Analyzed:	09/20/07
Diln Fac:	1.000		

Analyte	Result	RL
Chloromethane	ND	1.0
Vinyl Chloride	ND	0.5
Bromomethane	ND	1.0
Chloroethane	ND	1.0
Trichlorofluoromethane	ND	1.0
Freon 113	ND	2.0
1,1-Dichloroethene	ND	0.5
Methylene Chloride	ND	20
trans-1,2-Dichloroethene	ND	0.5
1,1-Dichloroethane	ND	0.5
cis-1,2-Dichloroethene	ND	0.5
Chloroform	ND	1.0
1,1,1-Trichloroethane	ND	0.5
Carbon Tetrachloride	ND	0.5
1,2-Dichloroethane	ND	0.5
Trichloroethene	ND	0.5
1,2-Dichloropropane	ND	0.5
Bromodichloromethane	ND	0.5
cis-1,3-Dichloropropene	ND	0.5
trans-1,3-Dichloropropene	ND	0.5
1,1,2-Trichloroethane	ND	0.5
Tetrachloroethene	ND	0.5
Dibromochloromethane	ND	0.5
Chlorobenzene	ND	0.5
Bromoform	ND	0.5
1,1,2,2-Tetrachloroethane	ND	0.5
1,3-Dichlorobenzene	ND	0.5
1,4-Dichlorobenzene	ND	0.5
1,2-Dichlorobenzene	ND	0.5

Surrogate	%REC	Limits
1,2-Dichloroethane-d4	124	74-137
Toluene-d8	102	80-120
Bromofluorobenzene	103	80-120

ND= Not Detected  
 RL= Reporting Limit

### Purgeable Halocarbons by GC/MS

Lab #:	197672	Location:	Sausage Factory
Client:	Bureau Veritas North America	Prep:	EPA 5030B
Project#:	33104-004578.00	Analysis:	EPA 8260B
Field ID:	MW-07	Batch#:	129675
Lab ID:	197672-004	Sampled:	09/17/07
Matrix:	Water	Received:	09/17/07
Units:	ug/L	Analyzed:	09/20/07
Diln Fac:	1.000		

Analyte	Result	RL
Chloromethane	ND	1.0
Vinyl Chloride	ND	0.5
Bromomethane	ND	1.0
Chloroethane	ND	1.0
Trichlorofluoromethane	ND	1.0
Freon 113	ND	2.0
1,1-Dichloroethene	ND	0.5
Methylene Chloride	ND	20
trans-1,2-Dichloroethene	ND	0.5
1,1-Dichloroethane	ND	0.5
cis-1,2-Dichloroethene	ND	0.5
Chloroform	ND	1.0
1,1,1-Trichloroethane	ND	0.5
Carbon Tetrachloride	ND	0.5
1,2-Dichloroethane	ND	0.5
Trichloroethene	ND	0.5
1,2-Dichloropropane	ND	0.5
Bromodichloromethane	ND	0.5
cis-1,3-Dichloropropene	ND	0.5
trans-1,3-Dichloropropene	ND	0.5
1,1,2-Trichloroethane	ND	0.5
Tetrachloroethene	ND	0.5
Dibromochloromethane	ND	0.5
Chlorobenzene	ND	0.5
Bromoform	ND	0.5
1,1,2,2-Tetrachloroethane	ND	0.5
1,3-Dichlorobenzene	ND	0.5
1,4-Dichlorobenzene	ND	0.5
1,2-Dichlorobenzene	ND	0.5

Surrogate	%REC	Limits
1,2-Dichloroethane-d4	119	74-137
Toluene-d8	100	80-120
Bromofluorobenzene	98	80-120

ND= Not Detected  
 RL= Reporting Limit

### Purgeable Halocarbons by GC/MS

Lab #:	197672	Location:	Sausage Factory
Client:	Bureau Veritas North America	Prep:	EPA 5030B
Project#:	33104-004578.00	Analysis:	EPA 8260B
Field ID:	MW-08	Batch#:	129675
Lab ID:	197672-005	Sampled:	09/17/07
Matrix:	Water	Received:	09/17/07
Units:	ug/L	Analyzed:	09/20/07
Diln Fac:	12.50		

Analyte	Result	RL
Chloromethane	ND	13
Vinyl Chloride	91	6.3
Bromomethane	ND	13
Chloroethane	ND	13
Trichlorofluoromethane	ND	13
Freon 113	ND	25
1,1-Dichloroethene	ND	6.3
Methylene Chloride	ND	250
trans-1,2-Dichloroethene	28	6.3
1,1-Dichloroethane	ND	6.3
cis-1,2-Dichloroethene	900	6.3
Chloroform	ND	13
1,1,1-Trichloroethane	ND	6.3
Carbon Tetrachloride	ND	6.3
1,2-Dichloroethane	ND	6.3
Trichloroethene	ND	6.3
1,2-Dichloropropane	ND	6.3
Bromodichloromethane	ND	6.3
cis-1,3-Dichloropropene	ND	6.3
trans-1,3-Dichloropropene	ND	6.3
1,1,2-Trichloroethane	ND	6.3
Tetrachloroethene	ND	6.3
Dibromochloromethane	ND	6.3
Chlorobenzene	ND	6.3
Bromoform	ND	6.3
1,1,2,2-Tetrachloroethane	ND	6.3
1,3-Dichlorobenzene	ND	6.3
1,4-Dichlorobenzene	ND	6.3
1,2-Dichlorobenzene	ND	6.3

Surrogate	%REC	Limits
1,2-Dichloroethane-d4	110	74-137
Toluene-d8	98	80-120
Bromofluorobenzene	101	80-120

ND= Not Detected  
 RL= Reporting Limit

### Purgeable Halocarbons by GC/MS

Lab #:	197672	Location:	Sausage Factory
Client:	Bureau Veritas North America	Prep:	EPA 5030B
Project#:	33104-004578.00	Analysis:	EPA 8260B
Field ID:	MW-09	Batch#:	129675
Lab ID:	197672-006	Sampled:	09/17/07
Matrix:	Water	Received:	09/17/07
Units:	ug/L	Analyzed:	09/20/07
Diln Fac:	33.33		

Analyte	Result	RL
Chloromethane	ND	33
Vinyl Chloride	ND	17
Bromomethane	ND	33
Chloroethane	ND	33
Trichlorofluoromethane	ND	33
Freon 113	ND	67
1,1-Dichloroethene	ND	17
Methylene Chloride	ND	670
trans-1,2-Dichloroethene	ND	17
1,1-Dichloroethane	ND	17
cis-1,2-Dichloroethene	ND	17
Chloroform	ND	33
1,1,1-Trichloroethane	ND	17
Carbon Tetrachloride	ND	17
1,2-Dichloroethane	ND	17
Trichloroethene	ND	17
1,2-Dichloropropane	ND	17
Bromodichloromethane	ND	17
cis-1,3-Dichloropropene	ND	17
trans-1,3-Dichloropropene	ND	17
1,1,2-Trichloroethane	ND	17
Tetrachloroethene	ND	17
Dibromochloromethane	ND	17
Chlorobenzene	ND	17
Bromoform	ND	17
1,1,2,2-Tetrachloroethane	ND	17
1,3-Dichlorobenzene	ND	17
1,4-Dichlorobenzene	ND	17
1,2-Dichlorobenzene	ND	17

Surrogate	%REC	Limits
1,2-Dichloroethane-d4	105	74-137
Toluene-d8	100	80-120
Bromofluorobenzene	101	80-120

ND= Not Detected  
 RL= Reporting Limit

### Purgeable Halocarbons by GC/MS

Lab #:	197672	Location:	Sausage Factory
Client:	Bureau Veritas North America	Prep:	EPA 5030B
Project#:	33104-004578.00	Analysis:	EPA 8260B
Field ID:	MW-10	Batch#:	129627
Lab ID:	197672-007	Sampled:	09/17/07
Matrix:	Water	Received:	09/17/07
Units:	ug/L	Analyzed:	09/19/07
Diln Fac:	1.000		

Analyte	Result	RL
Chloromethane	ND	1.0
Vinyl Chloride	ND	0.5
Bromomethane	ND	1.0
Chloroethane	ND	1.0
Trichlorofluoromethane	ND	1.0
Freon 113	ND	2.0
1,1-Dichloroethene	ND	0.5
Methylene Chloride	ND	20
trans-1,2-Dichloroethene	ND	0.5
1,1-Dichloroethane	ND	0.5
cis-1,2-Dichloroethene	ND	0.5
Chloroform	ND	1.0
1,1,1-Trichloroethane	ND	0.5
Carbon Tetrachloride	ND	0.5
1,2-Dichloroethane	ND	0.5
Trichloroethene	ND	0.5
1,2-Dichloropropane	ND	0.5
Bromodichloromethane	ND	0.5
cis-1,3-Dichloropropene	ND	0.5
trans-1,3-Dichloropropene	ND	0.5
1,1,2-Trichloroethane	ND	0.5
Tetrachloroethene	ND	0.5
Dibromochloromethane	ND	0.5
Chlorobenzene	ND	0.5
Bromoform	ND	0.5
1,1,2,2-Tetrachloroethane	ND	0.5
1,3-Dichlorobenzene	ND	0.5
1,4-Dichlorobenzene	ND	0.5
1,2-Dichlorobenzene	ND	0.5

Surrogate	%REC	Limits
1,2-Dichloroethane-d4	107	74-137
Toluene-d8	105	80-120
Bromofluorobenzene	104	80-120

ND= Not Detected

RL= Reporting Limit



### Purgeable Halocarbons by GC/MS

Lab #:	197672	Location:	Sausage Factory
Client:	Bureau Veritas North America	Prep:	EPA 5030B
Project#:	33104-004578.00	Analysis:	EPA 8260B
Field ID:	MW-12	Batch#:	129627
Lab ID:	197672-008	Sampled:	09/17/07
Matrix:	Water	Received:	09/17/07
Units:	ug/L	Analyzed:	09/19/07
Diln Fac:	2.000		

Analyte	Result	RL
Chloromethane	ND	2.0
Vinyl Chloride	ND	1.0
Bromomethane	ND	2.0
Chloroethane	ND	2.0
Trichlorofluoromethane	ND	2.0
Freon 113	ND	4.0
1,1-Dichloroethene	ND	1.0
Methylene Chloride	ND	40
trans-1,2-Dichloroethene	63	1.0
1,1-Dichloroethane	ND	1.0
cis-1,2-Dichloroethene	61	1.0
Chloroform	ND	2.0
1,1,1-Trichloroethane	ND	1.0
Carbon Tetrachloride	ND	1.0
1,2-Dichloroethane	ND	1.0
Trichloroethene	160	1.0
1,2-Dichloropropane	ND	1.0
Bromodichloromethane	ND	1.0
cis-1,3-Dichloropropene	ND	1.0
trans-1,3-Dichloropropene	ND	1.0
1,1,2-Trichloroethane	ND	1.0
Tetrachloroethene	ND	1.0
Dibromochloromethane	ND	1.0
Chlorobenzene	ND	1.0
Bromoform	ND	1.0
1,1,2,2-Tetrachloroethane	ND	1.0
1,3-Dichlorobenzene	ND	1.0
1,4-Dichlorobenzene	ND	1.0
1,2-Dichlorobenzene	ND	1.0

Surrogate	%REC	Limits
1,2-Dichloroethane-d4	110	74-137
Toluene-d8	103	80-120
Bromofluorobenzene	103	80-120

ND= Not Detected  
 RL= Reporting Limit

### Purgeable Halocarbons by GC/MS

Lab #:	197672	Location:	Sausage Factory
Client:	Bureau Veritas North America	Prep:	EPA 5030B
Project#:	33104-004578.00	Analysis:	EPA 8260B
Field ID:	MW-13	Batch#:	129627
Lab ID:	197672-009	Sampled:	09/17/07
Matrix:	Water	Received:	09/17/07
Units:	ug/L	Analyzed:	09/19/07
Diln Fac:	1.667		

Analyte	Result	RL
Chloromethane	ND	1.7
Vinyl Chloride	11	0.8
Bromomethane	ND	1.7
Chloroethane	2.1	1.7
Trichlorofluoromethane	ND	1.7
Freon 113	ND	3.3
1,1-Dichloroethene	ND	0.8
Methylene Chloride	ND	33
trans-1,2-Dichloroethene	65	0.8
1,1-Dichloroethane	ND	0.8
cis-1,2-Dichloroethene	56	0.8
Chloroform	ND	1.7
1,1,1-Trichloroethane	ND	0.8
Carbon Tetrachloride	ND	0.8
1,2-Dichloroethane	ND	0.8
Trichloroethene	11	0.8
1,2-Dichloropropane	ND	0.8
Bromodichloromethane	4.3	0.8
cis-1,3-Dichloropropene	ND	0.8
trans-1,3-Dichloropropene	ND	0.8
1,1,2-Trichloroethane	ND	0.8
Tetrachloroethene	ND	0.8
Dibromochloromethane	ND	0.8
Chlorobenzene	ND	0.8
Bromoform	ND	0.8
1,1,2,2-Tetrachloroethane	ND	0.8
1,3-Dichlorobenzene	ND	0.8
1,4-Dichlorobenzene	ND	0.8
1,2-Dichlorobenzene	ND	0.8

Surrogate	%REC	Limits
1,2-Dichloroethane-d4	117	74-137
Toluene-d8	106	80-120
Bromofluorobenzene	102	80-120

ND= Not Detected  
 RL= Reporting Limit

**Batch QC Report**

<b>Purgeable Halocarbons by GC/MS</b>			
Lab #:	197672	Location:	Sausage Factory
Client:	Bureau Veritas North America	Prep:	EPA 5030B
Project#:	33104-004578.00	Analysis:	EPA 8260B
Type:	BLANK	Diln Fac:	1.000
Lab ID:	QC406798	Batch#:	129627
Matrix:	Water	Analyzed:	09/19/07
Units:	ug/L		

<b>Analyte</b>	<b>Result</b>	<b>RL</b>
Chloromethane	ND	1.0
Vinyl Chloride	ND	0.5
Bromomethane	ND	1.0
Chloroethane	ND	1.0
Trichlorofluoromethane	ND	1.0
Freon 113	ND	2.0
1,1-Dichloroethene	ND	0.5
Methylene Chloride	ND	20
trans-1,2-Dichloroethene	ND	0.5
1,1-Dichloroethane	ND	0.5
cis-1,2-Dichloroethene	ND	0.5
Chloroform	ND	1.0
1,1,1-Trichloroethane	ND	0.5
Carbon Tetrachloride	ND	0.5
1,2-Dichloroethane	ND	0.5
Trichloroethene	ND	0.5
1,2-Dichloropropane	ND	0.5
Bromodichloromethane	ND	0.5
cis-1,3-Dichloropropene	ND	0.5
trans-1,3-Dichloropropene	ND	0.5
1,1,2-Trichloroethane	ND	0.5
Tetrachloroethene	ND	0.5
Dibromochloromethane	ND	0.5
Chlorobenzene	ND	0.5
Bromoform	ND	0.5
1,1,2,2-Tetrachloroethane	ND	0.5
1,3-Dichlorobenzene	ND	0.5
1,4-Dichlorobenzene	ND	0.5
1,2-Dichlorobenzene	ND	0.5

<b>Surrogate</b>	<b>%REC</b>	<b>Limits</b>
1,2-Dichloroethane-d4	108	74-137
Toluene-d8	106	80-120
Bromofluorobenzene	103	80-120

ND= Not Detected

RL= Reporting Limit

**Batch QC Report**

<b>Purgeable Halocarbons by GC/MS</b>			
Lab #:	197672	Location:	Sausage Factory
Client:	Bureau Veritas North America	Prep:	EPA 5030B
Project#:	33104-004578.00	Analysis:	EPA 8260B
Matrix:	Water	Batch#:	129627
Units:	ug/L	Analyzed:	09/19/07
Diln Fac:	1.000		

Type: BS Lab ID: QC406799

Analyte	Spiked	Result	%REC	Limits
1,1-Dichloroethene	25.00	29.21	117	80-133
Trichloroethene	25.00	26.79	107	80-120
Chlorobenzene	25.00	24.96	100	80-120

Surrogate	%REC	Limits
1,2-Dichloroethane-d4	109	74-137
Toluene-d8	100	80-120
Bromofluorobenzene	100	80-120

Type: BSD Lab ID: QC406800

Analyte	Spiked	Result	%REC	Limits	RPD	Lim
1,1-Dichloroethene	25.00	30.16	121	80-133	3	20
Trichloroethene	25.00	27.39	110	80-120	2	20
Chlorobenzene	25.00	24.81	99	80-120	1	20

Surrogate	%REC	Limits
1,2-Dichloroethane-d4	108	74-137
Toluene-d8	106	80-120
Bromofluorobenzene	99	80-120

RPD= Relative Percent Difference

**Batch QC Report**

<b>Purgeable Halocarbons by GC/MS</b>			
Lab #:	197672	Location:	Sausage Factory
Client:	Bureau Veritas North America	Prep:	EPA 5030B
Project#:	33104-004578.00	Analysis:	EPA 8260B
Field ID:	ZZZZZZZZZZ	Batch#:	129627
MSS Lab ID:	197633-049	Sampled:	09/11/07
Matrix:	Water	Received:	09/14/07
Units:	ug/L	Analyzed:	09/19/07
Diln Fac:	1.000		

Type: MS Lab ID: QC406882

Analyte	MSS Result	Spiked	Result	%REC	Limits
1,1-Dichloroethene	<0.1808	25.00	24.40	98	80-141
Trichloroethene	<0.1628	25.00	28.43	114	73-129
Chlorobenzene	<0.04080	25.00	25.06	100	80-120

Surrogate	%REC	Limits
1,2-Dichloroethane-d4	106	74-137
Toluene-d8	106	80-120
Bromofluorobenzene	99	80-120

Type: MSD Lab ID: QC406883

Analyte	Spiked	Result	%REC	Limits	RPD	Lim
1,1-Dichloroethene	25.00	26.63	107	80-141	9	20
Trichloroethene	25.00	29.11	116	73-129	2	20
Chlorobenzene	25.00	25.74	103	80-120	3	20

Surrogate	%REC	Limits
1,2-Dichloroethane-d4	107	74-137
Toluene-d8	104	80-120
Bromofluorobenzene	98	80-120

RPD= Relative Percent Difference

**Batch QC Report**

<b>Purgeable Halocarbons by GC/MS</b>			
Lab #:	197672	Location:	Sausage Factory
Client:	Bureau Veritas North America	Prep:	EPA 5030B
Project#:	33104-004578.00	Analysis:	EPA 8260B
Type:	BLANK	Diln Fac:	1.000
Lab ID:	QC406994	Batch#:	129675
Matrix:	Water	Analyzed:	09/20/07
Units:	ug/L		

<b>Analyte</b>	<b>Result</b>	<b>RL</b>
Chloromethane	ND	1.0
Vinyl Chloride	ND	0.5
Bromomethane	ND	1.0
Chloroethane	ND	1.0
Trichlorofluoromethane	ND	1.0
Freon 113	ND	2.0
1,1-Dichloroethene	ND	0.5
Methylene Chloride	ND	20
trans-1,2-Dichloroethene	ND	0.5
1,1-Dichloroethane	ND	0.5
cis-1,2-Dichloroethene	ND	0.5
Chloroform	ND	1.0
1,1,1-Trichloroethane	ND	0.5
Carbon Tetrachloride	ND	0.5
1,2-Dichloroethane	ND	0.5
Trichloroethene	ND	0.5
1,2-Dichloropropane	ND	0.5
Bromodichloromethane	ND	0.5
cis-1,3-Dichloropropene	ND	0.5
trans-1,3-Dichloropropene	ND	0.5
1,1,2-Trichloroethane	ND	0.5
Tetrachloroethene	ND	0.5
Dibromochloromethane	ND	0.5
Chlorobenzene	ND	0.5
Bromoform	ND	0.5
1,1,2,2-Tetrachloroethane	ND	0.5
1,3-Dichlorobenzene	ND	0.5
1,4-Dichlorobenzene	ND	0.5
1,2-Dichlorobenzene	ND	0.5

<b>Surrogate</b>	<b>%REC</b>	<b>Limits</b>
1,2-Dichloroethane-d4	117	74-137
Toluene-d8	99	80-120
Bromofluorobenzene	104	80-120

ND= Not Detected

RL= Reporting Limit

**Batch QC Report**

<b>Purgeable Halocarbons by GC/MS</b>			
Lab #:	197672	Location:	Sausage Factory
Client:	Bureau Veritas North America	Prep:	EPA 5030B
Project#:	33104-004578.00	Analysis:	EPA 8260B
Matrix:	Water	Batch#:	129675
Units:	ug/L	Analyzed:	09/20/07
Diln Fac:	1.000		

Type: BS Lab ID: QC406995

Analyte	Spiked	Result	%REC	Limits
1,1-Dichloroethene	25.00	25.17	101	80-133
Trichloroethene	25.00	27.35	109	80-120
Chlorobenzene	25.00	24.82	99	80-120

Surrogate	%REC	Limits
1,2-Dichloroethane-d4	113	74-137
Toluene-d8	102	80-120
Bromofluorobenzene	102	80-120

Type: BSD Lab ID: QC406996

Analyte	Spiked	Result	%REC	Limits	RPD	Lim
1,1-Dichloroethene	25.00	24.54	98	80-133	3	20
Trichloroethene	25.00	27.05	108	80-120	1	20
Chlorobenzene	25.00	24.49	98	80-120	1	20

Surrogate	%REC	Limits
1,2-Dichloroethane-d4	112	74-137
Toluene-d8	102	80-120
Bromofluorobenzene	102	80-120

RPD= Relative Percent Difference