

RECEIVED

2:22 pm, May 16, 2007

Alameda County
Environmental Health

February 1, 2007

Mr. Don Hwang
Hazardous Materials Specialist
ALAMEDA COUNTY ENVIRONMENTAL HEALTH
1131 Harbor Bay Parkway, Suite 250
Alameda, California 94502-6577

Clayton Project No.33104-004578.00

**Subject: First Quarter 2007 Groundwater Monitoring Report
Former Lemoine Sausage Factory
630 29th Avenue
Oakland, California**

Dear Mr. Hwang:

Clayton Group Services is pleased to present the results of the First Quarter 2007 groundwater monitoring event performed at the Former Lemoine Sausage Factory, located at 630 29th Avenue in Oakland, California. If you have any comments or questions regarding the report, please do not hesitate to contact me at (925) 426-2626.

Sincerely,



Timothy G. Bodkin, C.E.G., R.E.A.
Senior Project Manager
Environmental Services



Jeremy V. Wilson
Environmental Consultant
Environmental Services

JVW/tgb

cc: Bob Pender, AIG Technical Services
Donna Proffitt, Bank of America
Richard Tong, Bureau Veritas

First Quarter 2007 ***Groundwater Monitoring Report***

Former Lemoine Sausage Factory
630 29th Avenue
Oakland, California

February 1, 2007
33104-004578.00

Prepared for:
AIG Technical Services, Inc.
80 Pine Street, 6th Floor
New York, New York 10005

Clayton Group Services, Inc.
A Bureau Veritas Company
6920 Koll Center Parkway, Suite 216
Pleasanton, California 94566
925.426.2600
www.us.bureauveritas.com

CONTENTS

<u>Section</u>	<u>Page</u>
1.0 INTRODUCTION	1
2.0 SITE DESCRIPTION AND HISTORY	1
3.0 FIELD ACTIVITIES	1
3.1. GROUNDWATER LEVEL MEASUREMENTS	1
3.2. GROUNDWATER PURGING.....	2
3.4 LABORATORY ANALYSES.....	2
4.0 FINDINGS	3
4.1. GROUNDWATER FLOW CONDITIONS	3
4.2. ANALYTICAL RESULTS	3
5.0 CONCLUSIONS	4

Tables

1. Summary of Groundwater Elevation Data
2. Summary of Groundwater Analytical Results

Figures

1. Property Location Map
2. Groundwater Elevation Map, First Quarter 2007
3. TPH-g Concentrations in Groundwater, First Quarter 2007
4. Benzene Concentrations in Groundwater, First Quarter 2007
5. TCE and cis-1,2- DCE Concentrations in Groundwater, First Quarter 2007

Appendices

- A. Field Sampling Data Sheets
- B. Chain-of-Custody Documentation and Certified Analytical Reports

1.0 INTRODUCTION

Clayton Group Services, Inc., a Bureau Veritas Company (Clayton), has prepared the following First Quarter 2007 Groundwater Monitoring Report for the former Lemoine Sausage Factory. The site is located at 630 29th Avenue near its intersection with 7th Street in Oakland, California (Figure 1). Groundwater monitoring is being performed at this site on a quarterly basis in accordance with an Alameda County Environmental Health (ACEH) letter dated June 19, 1999. Groundwater monitoring has been required due to past releases from a gasoline underground storage tank (UST) previously located beneath the sidewalk adjacent to the site.

The purpose of the groundwater monitoring is to document groundwater flow conditions and water quality beneath the site. Depth to groundwater measurements were obtained and groundwater samples were collected and analyzed for total petroleum hydrocarbons as gasoline (TPH-g) and associated compounds, including benzene, toluene, ethylbenzene and total xylenes (BTEX), and volatile organic compounds (VOCs).

2.0 SITE DESCRIPTION AND HISTORY

A single 1,000-gallon gasoline UST and associated plumbing/piping were formerly located beneath the sidewalk along 7th Street immediately east of the subject building. The fuel dispenser for the UST was located in a “cubby hole” near the building’s roll-up door. The UST, fuel dispenser, and associated piping were removed on November 21, 1996. Confirmation soil samples were collected from the excavation for laboratory analyses. A petroleum hydrocarbon sheen was noted on groundwater that collected in the tank excavation. Analytical results showed the presence of petroleum hydrocarbons in the confirmation samples.

Subsequent groundwater investigations were performed to define the vertical and lateral extent of petroleum hydrocarbons in groundwater and to monitor groundwater conditions around the site. Several monitoring wells were installed and screened within the first-encountered water bearing zone, which predominantly occurs within low permeability clayey and sandy silts. The highest concentrations of TPH-g and benzene have been detected in the immediate vicinity or just downgradient of the former UST. VOCs have also been detected in monitoring wells located to the south and southwest of the former UST location and are believed to be originating from an off-site source.

3.0 FIELD ACTIVITIES

Groundwater level measurements and samples were obtained from ten (10) existing monitoring wells (MW-1, MW-2, and MW-6 through MW-13).

3.1. GROUNDWATER LEVEL MEASUREMENTS

On January 11, 2007, depth to water measurements were obtained in the monitoring wells to calculate groundwater elevations and to estimate the groundwater flow direction and gradient. The wells were opened and allowed to stabilize prior to measuring the groundwater levels. The depth to

water in each well was measured using an electronic well sounder. Groundwater depths were measured from a surveyed reference elevation point represented by a V-notch at the top of each casing. Groundwater elevations were calculated by subtracting the measured depth to water from the top of casing elevation at each monitoring well.

3.2. GROUNDWATER PURGING

Prior to groundwater sample collection at each monitoring well, between three and five well casing volumes of standing water were removed with the exception of Wells MW-1 and MW-2, which were not purged because of the lack of sufficient water within the well casing and poor groundwater recharge. Wells MW-6 through MW-13 were purged by hand bailing with 1-liter plastic disposable bailers.

The purge volume from each monitoring well was determined by multiplying the nominal cross-sectional area of the well casing by the water column within each well casing. The water column height in each well was determined by subtracting the depth to water from the total well casing depth. Water quality parameters (pH, specific conductivity, and temperature) were measured and recorded onto Field Sampling Data Sheets. Water quality parameter measurements were taken prior to purging and after removing each well casing volume of water from each monitoring well.

Groundwater purged from monitoring wells was stored onsite in sealed 55-gallon drums and labeled with identifying information. Groundwater level measurements for the First Quarter 2007 monitoring event were recorded on Field Sampling Data Sheets, as presented in Appendix A.

3.3 GROUNDWATER SAMPLING

Before groundwater sampling commenced, each purged monitoring well was allowed to recharge to at least 80% of the pre-purged standing water volume, except for Wells MW-1 and MW-2 for the reasons stated above. Groundwater samples for laboratory analyses were retrieved using either a peristaltic pump equipped with polytubing or a new disposable bailer. Groundwater samples were poured into appropriate laboratory-supplied containers. Sample containers were sealed, labeled with identifying project information, logged onto a chain-of-custody document, and temporarily stored in a chilled ice chest containing crushed ice for transport to the laboratory.

3.4 LABORATORY ANALYSES

Groundwater samples were analyzed by Curtis and Tompkins Ltd. of Berkeley, California, a State of California-certified laboratory. The samples were analyzed by the following United States Environmental Protection Agency (USEPA) approved analytical methods:

- USEPA Method 8021B for TPH-g/BTEX
- USEPA Method 8260B for VOCs

Certified analytical data sheets and chain-of-custody documentation for the First Quarter 2007 groundwater sampling event are presented in Appendix B.

4.0 FINDINGS

4.1. GROUNDWATER FLOW CONDITIONS

Groundwater flow conditions were assessed based upon the groundwater level measurements obtained in the wells. Groundwater depths ranged between 4.01 and 10.45 feet below the tops of well casings. Groundwater elevations ranged between 7.08 and 12.68 feet above mean sea level. Groundwater flow is to the west-southwest at an estimated gradient of 0.029 feet per foot (ft/ft). Depth to water measurements and groundwater elevation data from this event and previous events are presented in Table 1. The First Quarter 2007 groundwater elevation map is presented on Figure 2.

4.2. ANALYTICAL RESULTS

Analytical results for groundwater showed the presence of petroleum hydrocarbons and VOCs. The frequency and range of petroleum hydrocarbons and VOCs detected in groundwater during this quarter are as follows:

- TPH-g was detected in Wells MW-1, MW-2, MW-8, MW-9, MW-12, and MW-13 at concentrations ranging between 76 and 45,000 micrograms per liter ($\mu\text{g/L}$).
- Benzene was detected in Wells MW-1, MW-2, MW-8, MW-9, and MW-13 at concentrations ranging between 44 and 13,000 $\mu\text{g/L}$.
- Toluene was detected in Wells MW-1, MW-2, and MW-9 at concentrations ranging between 240 and 460 $\mu\text{g/L}$.
- Ethylbenzene was detected in Wells MW-1, MW-2, MW-8, MW-9, and MW-13 at concentrations ranging between 49 and 1,100 $\mu\text{g/L}$.
- Total xylenes were detected in Wells MW-1, MW-2, MW-8, MW-9, and MW-13 at concentrations ranging between 1.1 and 3050 $\mu\text{g/L}$.
- Trichloroethene (TCE) was detected in Wells MW-12 and MW-13 at 140 and 24 $\mu\text{g/L}$, respectively.
- Cis-1,2-dichloroethene (cis-1,2-DCE) was detected in Wells MW-8, MW-12, and MW-13 at concentrations of 820, 47, and 87 $\mu\text{g/L}$, respectively.
- Trans-1,2-dichloroethene (trans-1,2-DCE) was detected in Wells MW-8, MW-12, and MW-13 at concentrations ranging between 32 and 53 $\mu\text{g/L}$.

- Vinyl chloride (VC) was detected in Wells MW-8 and MW-13 at 58 and 11 µg/L, respectively.

Historical groundwater analytical results for petroleum hydrocarbons and VOCs detected in groundwater are presented in Table 2. TPH-g and benzene concentrations detected in groundwater and isoconcentration contours for these constituents detected during First Quarter 2007 are presented on Figures 3 and 4, respectively. TCE and cis 1,2-DCE concentrations detected in groundwater during First Quarter 2007 are presented in Figure 5.

5.0 CONCLUSIONS

Groundwater conditions for First Quarter 2007 are relatively consistent with those trends noted during previous monitoring events. TPH-g and BTEX concentrations detected in groundwater have generally slightly increased and remained relatively similar in comparison with the previous event, except for Well MW-13. TPH-g concentrations at Well MW-13 are significantly elevated and according to the analytical laboratory notes, the sample exhibits a chromatographic pattern which does not resemble the standard. The highest concentrations of TPH-g and benzene were detected in Well MW-2, which is near the former UST location, and in Well MW-9, which is located downgradient of the former UST location within the central portion of the subject building. Wells MW-1, MW-12, and MW-13 define the northern, western, and southern edges of the petroleum hydrocarbon plume.

VOCs detected in groundwater during First Quarter 2007 include TCE and associated degradation compounds (such as cis-1,2-DCE, trans-1,2-DCE, and VC). VOC concentrations were detected in Wells MW-8, MW-12, and MW-13, which are located downgradient from the site and former UST location. VOC concentrations detected during this monitoring event appear to be similar with those detected in the previous event. The source of the VOCs is unknown and appears to be located off-site. VOC concentrations in groundwater beneath the site are not related to the UST release. Changes in VOC concentrations over the past several monitoring events indicate that the natural degradation of TCE is occurring.

Report prepared by: _____

Jeremy V. Wilson
Environmental Consultant
Environmental Services

Report reviewed by: _____

Timothy G. Bodkin, C.E.G., R.E.A.
Senior Project Manager
Environmental Services



February 1, 2007

TABLES



TABLE 1

**HISTORICAL GROUNDWATER ELEVATION DATA
FORMER LEMOINE SAUSAGE FACTORY
630 29TH AVENUE
OAKLAND, CALIFORNIA**

Well Identification	Date Measured	Top of Casing Elevation (ft,msl)	Depth to Water (feet)	Groundwater Elevation (ft,msl)
MW-1	2/8/1999	16.69	3.60	13.09
	6/15/2000	16.69	4.82	11.87
	9/22/2000	16.69	6.30	10.39
	12/19/2000	16.69	5.50	11.19
	3/21/2001	16.69	4.29	12.40
	6/20/2001	16.69	5.85	10.84
	9/25/2001	16.69	6.76	9.93
	12/3/2001	16.69	4.17	12.52
	3/25/2002	16.69	2.77	13.92
	6/28/2002	16.69	5.61	11.08
	9/11/2002	16.69	6.17	10.52
	12/16/2002	16.69	3.91	12.78
	3/28/2003	16.69	4.44	12.25
	6/24/2003	16.69	5.29	11.40
	9/26/2003	16.69	6.88	9.81
	12/16/2003	16.69	NM	NM
	4/6/2004	16.69	3.57	13.12
	6/23/2004	16.69	5.96	10.73
	9/15/2004	16.69	NM	NM
	12/16/2004	16.69	4.40	12.29
	3/22/2005	16.69	3.44	13.25
	6/24/2005	16.69	4.45	12.24
	9/13/2005	16.69	6.03	10.66
	12/2/2005	16.69	4.95	11.74
	3/2/2006	16.69	3.74	12.95
	6/15/2006	16.69	4.58	12.11
9/14/2006	16.69	5.15	11.54	
1/11/2007	16.69	4.01	12.68	
MW-2	2/8/1999	20.79	14.20	6.59
	6/15/2000	20.79	10.46	10.33
	9/22/2000	20.79	11.49	9.30
	12/19/2000	20.79	11.38	9.41
	3/21/2001	20.79	10.01	10.78
	6/20/2001	20.79	10.92	9.87
	9/25/2001	20.79	11.78	9.01
	12/3/2001	20.79	11.13	9.66
	3/25/2002	20.79	9.21	11.58
	6/28/2002	20.79	10.65	10.14
	9/11/2002	20.79	10.89	9.90
	12/16/2002	20.79	11.15	9.64
	3/28/2003	20.79	10.27	10.52
	6/24/2003	20.79	10.24	10.55
	9/26/2003	20.79	11.20	9.59
	12/16/2003	20.79	11.50	9.29
4/6/2004	20.79	9.40	11.39	
6/23/2004	20.79	11.60	9.19	
9/15/2004	20.79	10.94	9.85	
12/16/2004	20.79	NM	NM	



TABLE 1

**HISTORICAL GROUNDWATER ELEVATION DATA
FORMER LEMOINE SAUSAGE FACTORY
630 29TH AVENUE
OAKLAND, CALIFORNIA**

Well Identification	Date Measured	Top of Casing Elevation (ft,msl)	Depth to Water (feet)	Groundwater Elevation (ft,msl)
MW-2	3/22/2005	20.79	9.26	11.53
	6/24/2005	20.79	10.03	10.76
	9/13/2005	20.79	10.58	10.21
	12/2/2005	20.79	NM	NM
	3/2/2006	20.79	9.45	11.34
	6/15/2006	20.79	9.84	10.95
	9/14/2006	20.79	10.27	10.52
	1/11/2007	20.79	10.45	10.34
MW-3	2/8/1999	21.10	7.45	13.65
	6/15/2000	21.10	10.56	10.54
	9/22/2000	21.10	15.30	5.80
	12/19/2000	21.10	9.72	11.38
	3/21/2001	21.10	8.95	12.15
	6/20/2001	21.10	10.14	10.96
	9/25/2001	21.10	10.74	10.36
	Removed from monitoring program in October 2001			
MW-4	2/8/1999	17.78	4.13	13.65
	6/15/2000	17.78	6.30	11.48
	9/22/2000	17.78	6.90	10.88
	12/19/2000	17.78	6.40	11.38
	3/21/2001	17.78	5.77	12.01
	6/20/2001	17.78	6.78	11.00
	9/25/2001	17.78	7.40	10.38
	Removed from monitoring program in October 2001			
MW-5	2/8/1999	21.12	7.62	13.50
	6/15/2000	21.12	10.36	10.76
	9/22/2000	21.12	9.99	11.13
	12/19/2000	21.12	9.99	11.13
	3/21/2001	21.12	8.68	12.44
	6/20/2001	21.12	9.90	11.22
	9/25/2001	21.12	10.34	10.78
	Removed from monitoring program in October 2001			
MW-6	6/15/2000	16.60	5.47	11.13
	9/22/2000	16.60	6.54	10.06
	12/19/2000	16.60	5.93	10.67
	3/21/2001	16.60	4.70	11.90
	6/20/2001	16.60	6.13	10.47
	9/25/2001	16.60	6.68	9.92
	12/3/2001	16.60	4.72	11.88
	3/25/2002	16.60	3.93	12.67
	6/28/2002	16.60	5.83	10.77
	9/11/2002	16.60	5.43	11.17
	12/16/2002	16.60	3.93	12.67
	3/28/2003	16.60	NM	
	6/24/2003	16.60	5.52	11.08



TABLE 1

**HISTORICAL GROUNDWATER ELEVATION DATA
FORMER LEMOINE SAUSAGE FACTORY
630 29TH AVENUE
OAKLAND, CALIFORNIA**

Well Identification	Date Measured	Top of Casing Elevation (ft,msl)	Depth to Water (feet)	Groundwater Elevation (ft,msl)
MW-6	9/26/2003	16.60	6.70	9.90
	12/16/2003	16.60	4.99	11.61
	4/6/2004	16.60	4.85	11.75
	6/23/2004	16.60	5.76	10.84
	9/15/2004	16.60	6.56	10.04
	12/16/2004	16.60	4.56	12.04
	3/22/2005	16.60	3.63	12.97
	6/24/2005	16.60	4.84	11.76
	9/13/2005	16.60	6.15	10.45
	12/2/2005	16.60	5.24	11.36
	3/2/2006	16.60	3.41	13.19
	6/15/2006	16.60	5.09	11.51
	9/14/2006	16.60	5.68	10.92
	1/11/2007	16.60	4.71	11.89
	MW-7	12/16/2002	15.47	5.01
12/17/2002		15.47	6.95	8.52
12/18/2002		15.47	6.94	8.53
12/19/2002		15.47	6.04	9.43
12/20/2002		15.47	6.48	8.99
12/21/2002		15.47	7.25	8.22
12/22/2002		15.47	6.90	8.57
12/23/2002		15.47	5.53	9.94
12/24/2002		15.47	7.20	8.27
12/25/2002		15.47	7.51	7.96
12/26/2002		15.47	6.40	9.07
3/28/2003		15.47	5.68	9.79
6/24/2003		15.47	6.13	9.34
9/26/2003		15.47	7.22	8.25
12/16/2003		15.47	5.68	9.79
4/6/2004		15.47	5.60	9.87
6/23/2004		15.47	6.20	9.27
9/15/2004		15.47	6.70	8.77
12/16/2004		15.47	5.15	10.32
3/22/2005		15.47	NM	NM
6/24/2005		15.47	NM	NM
9/13/2005		15.47	6.45	9.02
12/2/2005		15.47	5.93	9.54
3/2/2006	15.47	4.65	10.82	
6/15/2006	15.47	5.71	9.76	
9/14/2006	15.47	6.10	9.37	
1/11/2007	15.47	6.04	9.43	



TABLE 1

**HISTORICAL GROUNDWATER ELEVATION DATA
FORMER LEMOINE SAUSAGE FACTORY
630 29TH AVENUE
OAKLAND, CALIFORNIA**

Well Identification	Date Measured	Top of Casing Elevation (ft,msl)	Depth to Water (feet)	Groundwater Elevation (ft,msl)
MW-8	6/15/2000	17.58	7.14	10.44
	9/22/2000	17.58	8.33	9.25
	12/19/2000	17.58	7.71	9.87
	3/21/2001	17.58	6.40	11.18
	6/20/2001	17.58	7.96	9.62
	9/25/2001	17.58	8.89	8.69
	12/3/2001	17.58	6.58	11.00
	3/25/2002	17.58	5.40	12.18
	6/28/2002	17.58	7.71	9.87
	9/11/2002	17.58	8.40	9.18
	12/16/2002	17.58	5.63	11.95
	3/28/2003	17.58	6.62	10.96
	6/24/2003	17.58	7.44	10.14
	9/26/2003	17.58	8.71	8.87
	12/16/2003	17.58	6.69	10.89
	4/6/2004	17.58	6.74	10.84
	6/23/2004	17.58	7.98	9.60
	9/15/2004	17.58	8.52	9.06
	12/16/2004	17.58	5.61	11.97
	3/22/2005	17.58	5.54	12.04
	6/24/2005	17.58	6.77	10.81
	9/13/2005	17.58	7.92	9.66
	12/2/2005	17.58	7.36	10.22
3/2/2006	17.58	5.83	11.75	
6/15/2006	17.58	6.99	10.59	
9/14/2006	17.58	7.58	10.00	
1/11/2007	17.58	6.30	11.28	
MW-9	12/3/2001	17.61	5.79	11.82
	3/25/2002	17.61	4.98	12.63
	6/28/2002	17.61	7.71	9.90
	9/11/2002	17.61	6.91	10.70
	12/16/2002	17.61	6.58	11.03
	3/28/2003	17.61	6.08	11.53
	6/24/2003	17.61	6.42	11.19
	9/26/2003	17.61	8.14	9.47
	12/16/2003	17.61	6.76	10.85
	4/6/2004	17.61	5.97	11.64
	6/23/2004	17.61	7.80	9.81
	9/15/2004	17.61	7.14	10.47
	12/16/2004	17.61	5.73	11.88
	3/22/2005	17.61	5.31	12.30
	6/24/2005	17.61	6.05	11.56
9/13/2005	17.61	6.70	10.91	



TABLE 1

HISTORICAL GROUNDWATER ELEVATION DATA
FORMER LEMOINE SAUSAGE FACTORY
630 29TH AVENUE
OAKLAND, CALIFORNIA

Well Identification	Date Measured	Top of Casing Elevation (ft,msl)	Depth to Water (feet)	Groundwater Elevation (ft,msl)
MW-9	12/2/2005	17.61	6.92	10.69
	3/2/2006	17.61	5.83	11.78
	6/15/2006	17.61	6.32	11.29
	9/14/2006	17.61	6.79	10.82
	1/11/2007	17.61	5.59	12.02
MW-10	12/3/2001	16.92	4.22	12.70
	3/25/2002	16.92	3.00	13.92
	6/28/2002	16.92	5.65	11.27
	9/11/2002	16.92	6.16	10.76
	12/16/2002	16.92	3.74	13.18
	3/28/2003	16.92	4.54	12.38
	6/24/2003	16.92	5.40	11.52
	9/26/2003	16.92	6.98	9.94
	12/16/2003	16.92	4.94	11.98
	4/6/2004	16.92	4.54	12.38
	6/23/2004	16.92	5.96	10.96
	9/15/2004	16.92	6.86	10.06
	12/16/2004	16.92	4.45	12.47
	3/22/2005	16.92	3.56	13.36
	6/24/2005	16.92	4.58	12.34
	9/12/2005	16.92	6.08	10.84
	12/2/2005	16.92	4.94	11.98
3/2/2006	16.92	3.90	13.02	
6/15/2006	16.92	4.74	12.18	
9/14/2006	16.92	5.27	11.65	
1/11/2007	16.92	4.37	12.55	
MW-11	12/3/2001	14.87	5.67	9.20
	3/25/2002	14.87	4.68	10.19
	6/28/2002	14.87	6.35	8.52
	9/11/2002	14.87	6.91	7.96
	12/16/2002	14.87	3.92	10.95
	3/28/2003	14.87	5.17	9.70
	6/24/2003	14.87	5.86	9.01
	9/26/2003	14.87	7.16	7.71
	12/16/2003	14.87	5.61	9.26
	4/6/2004	14.87	5.49	9.38
	6/23/2004	14.87	5.68	9.19
	12/16/2004	14.87	4.69	10.18
	3/22/2005	14.87	4.20	10.67
	6/24/2005	14.87	5.41	9.46
	9/13/2005	14.87	6.23	8.64
	9/15/2005	14.87	6.45	8.42
	12/2/2005	14.87	5.95	8.92
3/2/2006	14.87	4.31	10.56	
6/15/2006	14.87	5.40	9.47	
9/14/2006	14.87	5.94	8.93	
1/11/2007	14.87	5.45	9.42	



TABLE 1

**HISTORICAL GROUNDWATER ELEVATION DATA
FORMER LEMOINE SAUSAGE FACTORY
630 29TH AVENUE
OAKLAND, CALIFORNIA**

Well Identification	Date Measured	Top of Casing Elevation (ft,msl)	Depth to Water (feet)	Groundwater Elevation (ft,msl)
MW-12	6/28/2002	14.05	6.13	7.92
	9/11/2002	14.05	6.82	7.23
	12/16/2002	14.05	4.94	9.11
	3/28/2003	14.05	5.08	8.97
	6/24/2003	14.05	5.73	8.32
	9/26/2003	14.05	6.94	7.11
	12/16/2003	14.05	4.99	9.06
	4/6/2004	14.05	5.04	9.01
	6/23/2004	14.05	5.78	8.27
	9/15/2004	14.05	6.43	7.62
	12/16/2004	14.05	4.34	9.71
	3/22/2005	14.05	3.50	10.55
	6/24/2005	14.05	4.9	9.15
	9/12/2005	14.05	6.11	7.94
	12/2/2005	14.05	5.13	8.92
	3/2/2006	14.05	3.83	10.22
	6/15/2006	14.05	5.18	8.87
	9/14/2006	14.05	5.86	8.19
1/11/2007	14.05	6.97	7.08	
MW-13	6/28/2002	13.39	6.21	7.18
	9/11/2002	13.39	6.66	6.73
	12/16/2002	13.39	3.90	9.49
	3/28/2003	13.39	5.34	8.05
	6/24/2003	13.39	5.99	7.40
	9/26/2003	13.39	6.99	6.40
	12/16/2003	13.39	5.01	8.38
	4/6/2004	13.39	5.35	8.04
	6/23/2004	13.39	6.12	7.27
	9/15/2004	13.39	6.63	6.76
	12/16/2004	13.39	4.69	8.70
	3/22/2005	13.39	4.86	8.53
	6/24/2005	13.39	5.13	8.26
	9/12/2005	13.39	6.33	7.06
	12/2/2005	13.39	5.25	8.14
	3/2/2006	13.39	4.33	9.06
	6/15/2006	13.39	5.44	7.95
	9/14/2006	13.39	6.03	7.36
1/11/2007	13.39	5.41	7.98	

Notes:

1. All top of casing elevations referenced to mean sea level (msl) and surveyed with reference to the benchmark located at Peterson Street and East 7th Street.
2. NM refers to Not Measured.

TABLE 2

**HISTORICAL GROUNDWATER ANALYTICAL RESULTS
FORMER LEMOINE SAUSAGE FACTORY
630 29TH AVENUE
OAKLAND, CALIFORNIA**



Sample Location	Date Sampled	TPH-g	Benzene	Toluene	Ethylbenzene	Total Xylenes	TCE	1,2-DCA	cis-1,2-DCE	trans-1,2-DCE	VC
		ug/L	ug/L	ug/L	ug/L	ug/L	ug/L	ug/L	ug/L	ug/L	ug/L
	RWQCB ESL	100	1	40	30	20	5	0.5	6	10	0.5
	DHS MCL	-	1	150	300	1750	5	0.5	6	10	0.5
MW-1	2/8/1999	48,000	3,900	6,300	970	4,300	NA	<30	NA	NA	NA
	6/15/2000	29,000	3,900	<100	1,900	4,200	<5.0	<5.0	<5.0	<5.0	<5.0
	9/22/2000	25,000	3,100	1,800	470	3,600	NA	NA	NA	NA	NA
	12/19/2000	25,000	3,200	1,900	480	3,300	<2.5	<2.5	<2.5	<2.5	<2.5
	3/21/2000	21,000	3,200	1,700	290	2,600	<2.5	<2.5	<2.5	<2.5	<2.5
	6/21/2001	12,000	2,000	880	180	1,180	<0.5	3.0	<0.5	<0.5	<0.5
	9/26/2001	16,000	1,100	130	< 10	320	< 2.5	< 2.5	< 2.5	< 2.5	< 2.5
	12/3/2001	15,000	2,800	1,200	310	1,660	<3.1	<3.1	<3.1	<3.1	<3.1
	3/25/2002	11,000	3,200	1,200	73	1,860	<5	<5	<5	<5	<5
	6/28/2002	26,000	3,200	1,800	640	2,900	<3.1	<3.1	<3.1	<3.1	<3.1
	9/11/2002	27,000	3,200	1,900	720	3,500	<4.2	<4.2	<4.2	<4.2	<4.2
	12/16/2002	20,000	2,800	490	500	2,300	<4.2	<4.2	<4.2	<4.2	<4.2
	3/28/2003	20,000	2,700	1,500	650	2,300	<3.6	<3.6	<3.6	<3.6	<3.6
	6/24/2003	14,000	2,400	1,400	500	2,100	<4.2	<4.2	<4.2	<4.2	<4.2
	9/26/2003	11,000	1,200	960	370	1,600	<1.0	<1.0	<1.0	<1.0	<1.0
	12/16/2003	Not Sampled									
	4/6/2004	18,000	2,400	1,300	550	1,730	<2.0	<2.0	<2.0	<2.0	<2.0
	6/23/2004	25,000	2,700	1,700	680	2,300	<2.5	<2.5	<2.5	<2.5	<2.5
	9/15/2004	Not Sampled									
	12/16/2004	1,800	260	89	32	119	<2.5	<2.5	<2.5	<2.5	<2.5
3/22/2005	19,000	2,400	960	530	1,330	<3.6	<3.6	<3.6	<3.6	<3.6	
6/24/2005	12,000	2,400	450	470	940	<3.6	<3.6	<3.6	<3.6	<3.6	
9/13/2005	17,000	2,700	1,000	740	1,760	<1.0	<1.0	<1.0	<1.0	<1.0	
12/2/2005	9,300	1,500	500	420	1,060	<3.6	<3.6	<3.6	<3.6	<3.6	
3/2/2006	6,200	1,400	200	180	370	<3.6	<3.6	<3.6	<3.6	<3.6	
6/15/2006	10,000	2,500	200	440	570	<4.2	<4.2	<4.2	<4.2	<4.2	
9/14/2006	13,000	2,300	320	450	870	<4.2	<4.2	<4.2	<4.2	<4.2	
1/11/2007	14,000	1,200	270	450	850	<2.0	<2.0	<2.0	<2.0	<2.0	

TABLE 2

**HISTORICAL GROUNDWATER ANALYTICAL RESULTS
FORMER LEMOINE SAUSAGE FACTORY
630 29TH AVENUE
OAKLAND, CALIFORNIA**



Sample Location	Date Sampled	TPH-g	Benzene	Toluene	Ethylbenzene	Total Xylenes	TCE	1,2-DCA	cis-1,2-DCE	trans-1,2-DCE	VC
		ug/L	ug/L	ug/L	ug/L	ug/L	ug/L	ug/L	ug/L	ug/L	ug/L
	RWQCB ESL	100	1	40	30	20	5	0.5	6	10	0.5
	DHS MCL	-	1	150	300	1750	5	0.5	6	10	0.5
MW-2	2/8/1999	41,000	11,000	4,900	650	1,720	NA	60	NA	NA	NA
	6/29/2000	31,000	11,000	930	4,400	250	<5.0	25	<5.0	<5.0	<5.0
	9/22/2000	24,000	10,000	2,700	370	1,200	NA	NA	NA	NA	NA
	12/19/2000	43,000	9,800	4,000	810	2,430	<13	21	<13	<13	<13
	3/23/2001	34,000	10,000	3,200	410	1,220	<13	14	<13	<13	<13
	6/21/2001	30,000	8,600	2,600	440	1,230	<0.5	5.6	<0.5	<0.5	<0.5
	9/26/2001	26,000	12,000	3,900	590	1,960	< 10	11	< 10	< 10	< 10
	12/3/2001	45,000	13,000	5,100	950	2,930	<7.1	14	<7.1	<7.1	<7.1
	3/25/2002	21,000	11,000	3,700	1,000	2,790	<17	<17	<17	<17	<17
	6/28/2002	8,400	2,200	680	21	220	<3.1	8.8	<3.1	<3.1	<3.1
	9/11/2002	23,000	6,600	1,000	600	1,320	<6.3	10	<6.3	<6.3	<6.3
	12/16/2002	6,000	1,600	410	150	402	4.5	2.7	69	6.9	<2.5
	3/28/2003	30,000	9,300	920	930	2,000	<13	14	<13	<13	<13
	6/24/2003	19,000	10,000	1,700	1,100	2,530	<13	<13	<13	<13	<13
	9/26/2003	20,000	10,000	2,100	960	2,520	<17	<17	<17	<17	<17
	12/16/2003	22,000	10,000	2,700	1,200	2,920	<25	<25	<25	<25	<25
	4/6/2004	27,000	7,600	1,700	630	1,420	<10	<10	<10	<10	<10
	6/23/2004	33,000	8,200	1,800	870	1,930	<17	<17	<17	<17	<17
	9/15/2004	46,000	13,000	1,300	1,400	2,710	<17	<17	<17	<17	<17
	12/16/2004	Not Sampled									
3/22/2005	42,000	9,900	1,200	1,200	2,530	<17	<17	<17	<17	<17	
6/24/2005	31,000	12,000	1,200	810	1,380	<20	<20	<20	<20	<20	
9/13/2005	35,000	13,000	1,100	1,300	2,260	<7.1	<7.1	<7.1	<7.1	<7.1	
12/2/2005	Not Sampled										
3/2/2006	25,000	7,900	620	740	1,260	<7.1	<7.1	<7.1	<7.1	<7.1	
6/15/2006	47,000	11,000	800	1,200	2,230	<20	<20	<20	<20	<20	
9/14/2006	50,000	11,000	470	1,200	2,330 C	<10	<10	<10	<10	<10	
1/11/2007	29,000	10,000	240	1,100	1,340	<13	<13	<13	<13	<13	

TABLE 2

**HISTORICAL GROUNDWATER ANALYTICAL RESULTS
FORMER LEMOINE SAUSAGE FACTORY
630 29TH AVENUE
OAKLAND, CALIFORNIA**



Sample Location	Date Sampled	TPH-g	Benzene	Toluene	Ethylbenzene	Total Xylenes	TCE	1,2-DCA	cis-1,2-DCE	trans-1,2-DCE	VC
		ug/L	ug/L	ug/L	ug/L	ug/L	ug/L	ug/L	ug/L	ug/L	ug/L
	RWQCB ESL	100	1	40	30	20	5	0.5	6	10	0.5
	DHS MCL	-	1	150	300	1750	5	0.5	6	10	0.5
MW-3	2/8/1999	35,000	1,200	3,400	1,400	4,900	NA	<30	NA	NA	NA
	6/29/2000	39,000	7,800	630	8,000	3,400	<5.0	600	<5.0	<5.0	<5.0
	9/22/2000	83,000	16,000	20,000	1,300	7,000	NA	NA	NA	NA	NA
	12/19/2000	50,000	1,200	1,600	510	1,810	<8.3	350	<8.3	<8.3	<8.3
	3/22/2001	1,300	98	67	51	104	<0.5	2.3	<0.5	<0.5	<0.5
	6/21/2001	34,000	5,900	6,200	340	1,550	2.4	120	0.8	<0.5	<0.5
	9/26/2001	59,000	12,000	13,000	780	3,680	< 8.3	990	< 8.3	< 8.3	< 8.3
	Removed from sampling program in October 2001										
MW-4	2/8/1999	15,000	670	90	780	940	NA	<30	NA	NA	NA
	6/15/2000	2,300	230	<5	10	94	<0.5	0.88	2.1	<0.5	<0.5
	9/22/2000	12,000	2,800	82	1,100	1,300	NA	NA	NA	NA	NA
	12/19/2000	2,200	200	2.9	100	81.4	<0.5	<0.5	<0.5	<0.5	<0.5
	3/22/2001	5,600	1,100	13	310	303	<0.5	<0.5	1.6	<0.5	<0.5
	6/21/2001	11,000	2,300	26	570	641	<0.5	1.4	3.3	<0.5	<0.5
	9/26/2001	17,000	7,900	< 50	440	581	< 0.5	1.9	8.1	< 0.5	< 0.5
	Removed from sampling program in October 2001										
MW-5	2/8/1999	4,900	780	440	230	370	<0.5	<0.5	<0.5	<0.5	<0.5
	6/29/2000	3,900	1,500	28	330	260	<0.5	36	<0.5	<0.5	<0.5
	9/27/2000	16,000	4,300	3,100	420	1,600	NA	NA	NA	NA	NA
	12/19/2000	21,000	3,200	1,100	1,100	1,300	<4.2	15	<4.2	<4.2	<4.2
	3/22/2001	6,200	1,500	360	310	288	<0.5	3.3	<0.5	<0.5	<0.5
	6/21/2001	18,000	3,400	2,300	350	1,020	<0.5	21	<0.5	<0.5	<0.5
	9/26/2001	5,100	2,400	1,200	< 10	460	< 3.6	22	< 3.6	< 3.6	< 3.6
	Removed from sampling program in October 2001										

TABLE 2

HISTORICAL GROUNDWATER ANALYTICAL RESULTS
FORMER LEMOINE SAUSAGE FACTORY
630 29TH AVENUE
OAKLAND, CALIFORNIA



Sample Location	Date Sampled	TPH-g	Benzene	Toluene	Ethylbenzene	Total Xylenes	TCE	1,2-DCA	cis-1,2-DCE	trans-1,2-DCE	VC
		ug/L	ug/L	ug/L	ug/L	ug/L	ug/L	ug/L	ug/L	ug/L	ug/L
	RWQCB ESL	100	1	40	30	20	5	0.5	6	10	0.5
	DHS MCL	-	1	150	300	1750	5	0.5	6	10	0.5
MW-6	6/15/2000	1,100	3.8	2.2	2.1	4.8	< 0.5	0.78	< 0.5	< 0.5	< 0.5
	9/22/2000	71	< 0.5	< 0.5	< 0.5	< 0.5	NA	NA	NA	NA	NA
	12/19/2000	320	< 0.5	< 0.5	< 0.5	< 0.5	< 0.5	< 0.5	< 0.5	< 0.5	< 0.5
	3/21/2001	820	< 0.5	< 0.5	1.4	0.52	< 0.5	< 0.5	< 0.5	< 0.5	< 0.5
	6/21/2001	420	< 0.5	< 0.5	0.59	1	< 0.5	0.9	< 0.5	< 0.5	< 0.5
	9/25/2001	760	< 0.5	< 0.5	< 0.5	2.9	< 0.5	< 0.5	< 0.5	< 0.5	< 0.5
	12/3/2001	72	< 0.5	< 0.5	< 0.5	< 0.5	< 0.5	1.6	< 0.5	< 0.5	< 0.5
	3/25/2002	1,200	22	8.0	5.7	13.5	< 0.5	< 0.5	< 0.5	< 0.5	< 0.5
	6/28/2002	120	< 0.5	< 0.5	< 0.5	< 0.5	< 0.5	0.6	< 0.5	< 0.5	< 0.5
	9/11/2002	120	< 0.5	< 0.5	< 0.5	< 0.5	< 0.5	< 0.5	< 0.5	< 0.5	< 0.5
	12/16/2002	62	< 0.5	0.54	3.0	8.39	0.7	1	< 0.5	< 0.5	< 0.5
	3/28/2003	NS	NS	NS	NS	NS	NS	NS	NS	NS	NS
	6/24/2003	130	< 0.5	< 0.5	< 0.5	< 0.5	< 0.5	< 0.5	< 0.5	< 0.5	< 0.5
	9/26/2003	< 50	< 0.5	< 0.5	< 0.5	< 0.5	< 0.5	0.7	< 0.5	< 0.5	< 0.5
	12/16/2003	< 50	< 0.5	< 0.5	< 0.5	0.88	1.7	< 0.5	0.6	< 0.5	< 0.5
	4/6/2004	260	< 0.5	< 0.5	< 0.5	< 0.5	< 0.5	< 0.5	< 0.5	< 0.5	< 0.5
	6/23/2004	63	< 0.5	< 0.5	< 0.5	< 0.5	< 0.5	0.8	< 0.5	< 0.5	< 0.5
	9/15/2004	< 50	< 0.5	< 0.5	< 0.5	< 0.5	< 0.5	< 0.5	< 0.5	< 0.5	< 0.5
	12/16/2004	240	< 0.5	< 0.5	< 0.5	< 0.5	< 0.5	< 0.5	< 0.5	< 0.5	< 0.5
	3/22/2005	420	< 0.5	< 0.5	< 0.5	< 0.5	0.95	< 0.5	< 0.5	< 0.5	< 0.5
6/24/2005	91	< 0.5	< 0.5	< 0.5	< 0.5	< 0.5	< 0.5	< 0.5	< 0.5	< 0.5	
9/13/2005	< 50	< 0.5	< 0.5	< 0.5	< 0.5	< 0.5	< 0.5	< 0.5	< 0.5	< 0.5	
12/2/2005	< 50	< 0.5	< 0.5	< 0.5	< 0.5	< 0.5	0.7	< 0.5	< 0.5	< 0.5	
3/2/2006	120	< 0.5	< 0.5	< 0.5	< 0.5	< 0.5	< 0.5	< 0.5	< 0.5	< 0.5	
6/15/2006	51	< 0.5	< 0.5	< 0.5	< 0.5	< 0.5	< 0.5	< 0.5	< 0.5	< 0.5	

TABLE 2

**HISTORICAL GROUNDWATER ANALYTICAL RESULTS
FORMER LEMOINE SAUSAGE FACTORY
630 29TH AVENUE
OAKLAND, CALIFORNIA**



Sample Location	Date Sampled	TPH-g	Benzene	Toluene	Ethylbenzene	Total Xylenes	TCE	1,2-DCA	cis-1,2-DCE	trans-1,2-DCE	VC
		ug/L	ug/L	ug/L	ug/L	ug/L	ug/L	ug/L	ug/L	ug/L	ug/L
	RWQCB ESL	100	1	40	30	20	5	0.5	6	10	0.5
	DHS MCL	-	1	150	300	1750	5	0.5	6	10	0.5
MW-6	9/14/2006	57	< 0.5	< 0.5	< 0.5	< 0.5	< 0.5	< 0.5	< 0.5	< 0.5	< 0.5
	1/11/2007	<50	< 0.5	< 0.5	< 0.5	< 0.5	< 0.5	< 0.5	< 0.5	< 0.5	< 0.5
MW-7	6/15/2000	1,000	250	< 10	<10	16	< 0.5	< 0.5	< 0.5	< 0.5	< 0.5
	9/22/2000	<50	2	< 0.5	< 0.5	< 0.5	NA	NA	NA	NA	NA
	12/19/2000	<50	1.6	< 0.5	< 0.5	< 0.5	< 0.5	< 0.5	< 0.5	< 0.5	< 0.5
	3/21/2001	160	59	< 0.5	< 0.5	< 0.5	< 0.5	< 0.5	< 0.5	< 0.5	< 0.5
	6/21/2001	<50	< 0.5	< 0.5	< 0.5	< 0.5	< 0.5	< 0.5	< 0.5	< 0.5	< 0.5
	9/25/2001	< 50	< 0.5	< 0.5	< 0.5	< 0.5	< 0.5	< 0.5	< 0.5	< 0.5	< 0.5
	12/3/2001	82	24	< 0.5	< 0.5	< 0.5	< 0.5	< 0.5	< 0.5	< 0.5	< 0.5
	3/25/2002	<50	0.56	0.75	<0.5	0.69	< 0.5	< 0.5	< 0.5	< 0.5	< 0.5
	6/28/2002	<50	< 0.5	< 0.5	< 0.5	< 0.5	< 0.5	< 0.5	< 0.5	< 0.5	< 0.5
	9/11/2002	<50	< 0.5	< 0.5	< 0.5	< 0.5	< 0.5	< 0.5	< 0.5	< 0.5	< 0.5
	12/16/2002	<50	< 0.5	< 0.5	1.6	3.7	0.5	<0.5	<0.5	<0.5	<0.5
	3/28/2003	<50	< 0.5	< 0.5	< 0.5	< 0.5	< 0.5	< 0.5	< 0.5	< 0.5	< 0.5
	6/24/2003	<50	< 0.5	< 0.5	< 0.5	< 0.5	< 0.5	< 0.5	< 0.5	< 0.5	< 0.5
	9/26/2003	<50	< 0.5	< 0.5	< 0.5	< 0.5	< 0.5	< 0.5	< 0.5	< 0.5	< 0.5
	12/16/2003	<50	< 0.5	< 0.5	< 0.5	0.75	1.8	< 0.5	0.6	< 0.5	< 0.5
	4/6/2004	<50	< 0.5	< 0.5	< 0.5	< 0.5	< 0.5	< 0.5	< 0.5	< 0.5	< 0.5
	6/23/2004	<50	< 0.5	< 0.5	< 0.5	< 0.5	< 0.5	< 0.5	< 0.5	< 0.5	< 0.5
	9/15/2004	<50	< 0.5	< 0.5	< 0.5	< 0.5	< 0.5	< 0.5	< 0.5	< 0.5	< 0.5
	12/16/2004	<50	< 0.5	< 0.5	< 0.5	< 0.5	< 0.5	< 0.5	< 0.5	< 0.5	< 0.5
	3/22/2005	Not Sampled									
6/24/2005	Not Sampled										
9/12/2005	<50	< 0.5	< 0.5	< 0.5	< 0.5	< 0.5	< 0.5	< 0.5	< 0.5	< 0.5	
12/2/2005	<50	< 0.5	< 0.5	< 0.5	< 0.5	< 0.5	< 0.5	< 0.5	< 0.5	< 0.5	
3/2/2006	<50	< 0.5	< 0.5	< 0.5	< 0.5	< 0.5	< 0.5	< 0.5	< 0.5	< 0.5	
6/15/2006	<50	< 0.5	< 0.5	< 0.5	< 0.5	0.62	< 0.5	< 0.5	< 0.5	< 0.5	

TABLE 2

**HISTORICAL GROUNDWATER ANALYTICAL RESULTS
FORMER LEMOINE SAUSAGE FACTORY
630 29TH AVENUE
OAKLAND, CALIFORNIA**



Sample Location	Date Sampled	TPH-g	Benzene	Toluene	Ethylbenzene	Total Xylenes	TCE	1,2-DCA	cis-1,2-DCE	trans-1,2-DCE	VC
		ug/L	ug/L	ug/L	ug/L	ug/L	ug/L	ug/L	ug/L	ug/L	ug/L
	RWQCB ESL	100	1	40	30	20	5	0.5	6	10	0.5
	DHS MCL	-	1	150	300	1750	5	0.5	6	10	0.5
MW-7	9/14/2006	<50	< 0.5	< 0.5	< 0.5	<0.5	< 0.5	< 0.5	< 0.5	< 0.5	< 0.5
	1/11/2007	<50	< 0.5	< 0.5	< 0.5	<0.5	< 0.5	< 0.5	< 0.5	< 0.5	< 0.5
MW-8	6/15/2000	5,400	150	<5	8.9	8.7	210	<13	1,100	73	25
	9/22/2000	1,800	340	<2.5	<2.5	<2.5	NA	NA	NA	NA	NA
	12/19/2000	2,700	410	<2.5	4.8	<2.5	130	9.1	1,000	67	48
	3/21/2001	3,500	530	<2.5	21	<2.5	32	<3.6	760	39	58
	6/21/2001	2,400	490	<2.5	29	<2.5	28	4.9	910	48	75
	9/25/2001	1,500	170	4.3	1.6	2.7	36	5.0	820	59	53
	12/3/2001	1,200	190	14	2.7	11.3	100	<2.5	650	44	31
	3/25/2002	990	280	7.2	1.4	6.8	10	3.6	790	33	49
	6/28/2002	2,200	410	<1.0	40	<1.0	18	4.9	900	54	80
	9/11/2002	2,000	390	1.6	39	<1.0	17	<3.6	1,000	60	91
	12/16/2002	95	26	<0.5	1	<0.5	17	2.2	330	36	4.7
	3/28/2003	1,500	400	<0.5	50	0.62	3.5	<2.5	700	39	41
	6/24/2003	3,300	520	<0.5	58	0.63	6.4	3.7	1,000	49	61
	9/26/2003	1,300	280	3.9	38	0.85	20	<3.6	890	49	47
	12/16/2003	1,100	310	<2.5	14	<2.5	12	4.3	1,200	53	110
	4/6/2004	3,800	420	<0.5	53	1.2	4.4	3.7	1,100	39	58
	6/23/2004	4,600	570	2.9	100	1.5	<8.3	<8.3	1,300	50	80
9/15/2004	4,900	710	<1.0	100	<1.0	<7.1	<7.1	1,200	49	100	
12/16/2004	3,800	450	<0.5	75	6.5	<8.3	<8.3	1,500	60	86	
3/22/2005	1,700	120	<1.0	9.8	<1.0	<3.6	<3.6	620	27	38	
6/24/2005	1,400	100	<1.0	37	<1.0	<5.0	<5.0	770	29	51	
9/13/2005	2,700	250	<1.0	110	<1.0	<7.1	<7.1	1,000	35	60	
12/2/2005	1,500	160	<1.0	33	<1.0	13	<5.0	930	46	80	
3/2/2006	2,000 L	210	<0.5	36	<0.5	<6.3	<6.3	890	34	50	
6/15/2006	1,400	78	<0.5	21	<0.5	6.9	<5.0	700	28	41	

TABLE 2

**HISTORICAL GROUNDWATER ANALYTICAL RESULTS
FORMER LEMOINE SAUSAGE FACTORY
630 29TH AVENUE
OAKLAND, CALIFORNIA**



Sample Location	Date Sampled	TPH-g	Benzene	Toluene	Ethylbenzene	Total Xylenes	TCE	1,2-DCA	cis-1,2-DCE	trans-1,2-DCE	VC
		ug/L	ug/L	ug/L	ug/L	ug/L	ug/L	ug/L	ug/L	ug/L	ug/L
	RWQCB ESL	100	1	40	30	20	5	0.5	6	10	0.5
	DHS MCL	-	1	150	300	1750	5	0.5	6	10	0.5
MW-8	9/14/2006	1,600	120	<0.5	42	<0.5	7.6	<6.3	800	37	43
	1/11/2007	1,100 Y	130	<0.5	49	1.1 C	<6.3	<6.3	820	32	58
MW-9	12/3/2001	90,000	15,000	15,000	2,200	9,100	<10	<10	<10	<10	<10
	3/25/2002	71,000	15,000	17,000	1,900	8,000	<31	<31	<31	<31	<31
	6/28/2002	60,000	5,800	7,400	1,100	5,400	<13	<13	<13	<13	<13
	9/11/2002	57,000	8,300	6,100	340	4,700	<10	18	<10	<10	<10
	12/16/2002	29,000	5,500	3,900	300	1,860	<5	8.9	<5	<5	<5
	3/28/2003	61,000	13,000	8,600	860	4,800	<20	<20	<20	<20	<20
	6/24/2003	45,000	15,000	9,600	1,100	5,200	<5	10	<5	<5	<5
	9/26/2003	34,000	12,000	5,600	880	4,700	<17	<17	<17	<17	<17
	12/16/2003	34,000	14,000	4,900	940	4,700	<42	<42	<42	<42	<42
	4/6/2004	60,000	14,000	3,100	1,300	5,500	<17	<17	<17	<17	<17
	6/23/2004	53,000	12,000	2,600	1,100	4,800	<20	<20	<20	<20	<20
	9/15/2004	76,000	17,000	2,200	1,500	6,600	<20	<20	<20	<20	<20
	12/16/2004	63,000	15,000	1,700	1,300	5,900	<20	<20	<20	<20	<20
	3/22/2005	66,000	13,000	2,000	1,200	5,800	<17	<17	<17	<17	<17
	6/24/2005	54,000	16,000	780	1,300	5,200	<20	<20	<20	<20	<20
	9/13/2005	48,000	11,000	4,800	470	4,110	<17	<17	<17	<17	<17
	12/2/2005	39,000	12,000	3,800	650	3,470 C	<20	<20	<20	<20	<20
3/2/2006	51,000	12,000	3,500	750	4,170	<20	<20	<20	<20	<20	
6/15/2006	67,000	16,000	5,000	1,900	5,790	<36	<36	<36	<36	<36	
9/14/2006	49,000	13,000	620	1,000	3,680	<13	<13	<13	<13	<13	
1/11/2007	45,000	13,000	460	1,100	3,050	<17	<17	<17	<17	<17	
MW-10	12/3/2001	<50	<0.5	<0.5	<0.5	<0.5	<0.5	<0.5	<0.5	<0.5	<0.5
	3/25/2002	51	2.5	3.6	0.53	2.27	<0.5	<0.5	<0.5	<0.5	<0.5
	6/28/2002	<50	<0.5	<0.5	<0.5	<0.5	<0.5	<0.5	<0.5	<0.5	<0.5
	9/11/2002	<50	<0.5	<0.5	<0.5	<0.5	<0.5	<0.5	<0.5	<0.5	<0.5
	12/16/2002	<50	<0.5	0.65	3.0	7.53	0.8	<0.5	<0.5	<0.5	<0.5
	3/28/2003	<50	<0.5	<0.5	<0.5	<0.5	<0.5	<0.5	<0.5	<0.5	<0.5
	6/24/2003	<50	<0.5	<0.5	<0.5	<0.5	<0.5	<0.5	<0.5	<0.5	<0.5
9/26/2003	<50	<0.5	<0.5	<0.5	<0.5	<0.5	<0.5	<0.5	<0.5	<0.5	

TABLE 2

HISTORICAL GROUNDWATER ANALYTICAL RESULTS
FORMER LEMOINE SAUSAGE FACTORY
630 29TH AVENUE
OAKLAND, CALIFORNIA



Sample Location	Date Sampled	TPH-g	Benzene	Toluene	Ethylbenzene	Total Xylenes	TCE	1,2-DCA	cis-1,2-DCE	trans-1,2-DCE	VC
		ug/L	ug/L	ug/L	ug/L	ug/L	ug/L	ug/L	ug/L	ug/L	ug/L
	RWQCB ESL	100	1	40	30	20	5	0.5	6	10	0.5
	DHS MCL	-	1	150	300	1750	5	0.5	6	10	0.5
MW-10	12/16/2003	<50	<0.5	<0.5	<0.5	<0.5	0.6	<0.5	<0.5	<0.5	<0.5
	4/6/2004	<50	<0.5	<0.5	<0.5	<0.5	<0.5	<0.5	<0.5	<0.5	<0.5
	6/23/2004	<50	<0.5	<0.5	<0.5	<0.5	<0.5	<0.5	<0.5	<0.5	<0.5
	9/15/2004	<50	<0.5	<0.5	<0.5	<0.5	<0.5	<0.5	<0.5	<0.5	<0.5
	12/16/2004	<50	<0.5	<0.5	<0.5	<0.5	<0.5	<0.5	<0.5	<0.5	<0.5
	3/22/2005	<50	<0.5	<0.5	<0.5	<0.5	<0.5	<0.5	<0.5	<0.5	<0.5
	6/24/2005	<50	<0.5	<0.5	<0.5	<0.5	<0.5	<0.5	<0.5	<0.5	<0.5
	9/12/2005	<50	<0.5	<0.5	<0.5	<0.5	<0.5	<0.5	<0.5	<0.5	<0.5
	12/2/2005	<50	<0.5	<0.5	<0.5	<0.5	<0.5	<0.5	<0.5	<0.5	<0.5
	3/2/2006	<50	0.74	<0.5	<0.5	<0.5	<0.5	<0.5	<0.5	<0.5	<0.5
	6/15/2006	<50	<0.5	<0.5	<0.5	<0.5	<0.5	<0.5	<0.5	<0.5	<0.5
	9/14/2006	<50	<0.5	<0.5	<0.5	<0.5	<0.5	<0.5	<0.5	<0.5	<0.5
1/11/2007	<50	<0.5	<0.5	<0.5	<0.5	<0.5	<0.5	<0.5	<0.5	<0.5	
MW-11	12/3/2001	1,600	470	<0.5	3.7	<0.5	<0.5	<0.5	<0.5	<0.5	<0.5
	3/25/2002	130	11	20	3.3	14.5	<0.5	<0.5	<0.5	<0.5	<0.5
	6/28/2002	<50	7.7	<0.5	<0.5	<0.5	0.6	<0.5	<0.5	<0.5	<0.5
	9/11/2002	120	66	<0.5	0.74	<0.5	<0.5	<0.5	0.6	<0.5	<0.5
	12/16/2002	160	42	0.89	4.8	11.1	3.6	<0.5	1.1	<0.5	<0.5
	3/28/2003	<50	<0.5	<0.5	<0.5	<0.5	<0.5	<0.5	<0.5	<0.5	<0.5
	6/24/2003	<50	<0.5	<0.5	<0.5	<0.5	<0.5	<0.5	<0.5	<0.5	<0.5
	9/26/2003	<50	1.2	0.69	<0.5	<0.5	<0.5	<0.5	<0.5	<0.5	<0.5
	12/16/2003	91	4.7	<0.5	<0.5	0.51	2.9	<0.5	0.9	0.6	<0.5
	4/6/2004	<50	<0.5	<0.5	<0.5	<0.5	<0.5	<0.5	<0.5	<0.5	<0.5
	6/23/2004	<50	<0.5	<0.5	<0.5	<0.5	<0.5	<0.5	<0.5	<0.5	<0.5
	9/15/2004	<50	<0.5	<0.5	<0.5	<0.5	<0.5	<0.5	<0.5	<0.5	<0.5
	12/16/2004	<50	1.3	<0.5	<0.5	0.59	<0.5	<0.5	<0.5	<0.5	<0.5
	3/22/2005	<50	<0.5	<0.5	<0.5	<0.5	<0.5	<0.5	<0.5	<0.5	<0.5
	6/24/2005	<50	<0.5	<0.5	<0.5	<0.5	<0.5	<0.5	<0.5	<0.5	<0.5
	9/13/2005	<50	<0.5	<0.5	<0.5	<0.5	<0.5	<0.5	<0.5	<0.5	<0.5
	12/2/2005	<50	<0.5	<0.5	<0.5	<0.5	<0.5	<0.5	<0.5	<0.5	<0.5

TABLE 2

**HISTORICAL GROUNDWATER ANALYTICAL RESULTS
FORMER LEMOINE SAUSAGE FACTORY
630 29TH AVENUE
OAKLAND, CALIFORNIA**



Sample Location	Date Sampled	TPH-g	Benzene	Toluene	Ethylbenzene	Total Xylenes	TCE	1,2-DCA	cis-1,2-DCE	trans-1,2-DCE	VC
		ug/L	ug/L	ug/L	ug/L	ug/L	ug/L	ug/L	ug/L	ug/L	ug/L
	RWQCB ESL	100	1	40	30	20	5	0.5	6	10	0.5
	DHS MCL	-	1	150	300	1750	5	0.5	6	10	0.5
MW-11	3/2/2006	<50	<0.5	<0.5	<0.5	<0.5	<0.5	<0.5	<0.5	<0.5	<0.5
	6/15/2006	<50	<0.5	<0.5	<0.5	<0.5	<0.5	<0.5	<0.5	<0.5	<0.5
	9/14/2006	<50	<0.5	<0.5	<0.5	<0.5	<0.5	<0.5	<0.5	<0.5	<0.5
	1/11/2007	<50	<0.5	<0.5	<0.5	<0.5	<0.5	<0.5	<0.5	<0.5	<0.5
MW-12	6/28/2002	71	<0.5	<0.5	<0.5	<0.5	170	<0.5	42	47	0.9
	9/11/2002	89	<0.5	<0.5	<0.5	<0.5	180	<0.5	46	51	0.9
	12/16/2002	130	<0.5	0.9	4.2	9.9	200	<0.5	57	60	0.9
	3/28/2003	110	<0.5	<0.5	<0.5	<0.5	190	<0.7	53	53	0.9
	6/24/2003	140	<0.5	<0.5	<0.5	<0.5	220	<1.0	58	66	<1.0
	9/26/2003	230	2.9	1.1	3.8	6.71	210	<0.7	60	63	<0.7
	12/16/2003	120	<0.5	<0.5	<0.5	0.65	140	<0.5	44	44	<0.5
	4/6/2004	76	<0.5	<0.5	<0.5	<0.5	160	<0.5	49	54	<0.5
	6/23/2004	99	<0.5	<0.5	<0.5	<0.5	200	<0.5	65	74	<0.5
	9/15/2004	130	<0.5	<0.5	<0.5	<0.5	290	<1.7	73	83	<1.7
	12/16/2004	110	0.94	<0.5	<0.5	<0.5	240	<2.0	80	77	<2.0
	3/22/2005	61	<0.5	<0.5	<0.5	<0.5	95	<0.5	26	42	<0.5
	6/24/2005	59	<0.5	<0.5	<0.5	<0.5	120	<1.0	31	39	<1.0
	9/12/2005	64	<0.5	<0.5	<0.5	<0.5	130	<0.7	34	42	<0.7
	12/2/2005	80 Y,Z	<0.5	<0.5	<0.5	<0.5	170	<1.0	43	49	<1.0
	3/2/2006	54 Y Z	<0.5	<0.5	<0.5	<0.5	84	<0.8	27	31	<0.8
	6/15/2006	58 Y,Z	<0.5	<0.5	<0.5	<0.5	99	<0.5	30	38	<0.5
9/14/2006	81 Y Z	<0.5	<0.5	<0.5	<0.5	110	<1.0	41	47	<1.0	
1/11/2007	76 Y Z	<0.5	<0.5	<0.5	<0.5	140	<1.0	47	53	<1.0	

TABLE 2

**HISTORICAL GROUNDWATER ANALYTICAL RESULTS
FORMER LEMOINE SAUSAGE FACTORY
630 29TH AVENUE
OAKLAND, CALIFORNIA**



Sample Location	Date Sampled	TPH-g	Benzene	Toluene	Ethylbenzene	Total Xylenes	TCE	1,2-DCA	cis-1,2-DCE	trans-1,2-DCE	VC
		ug/L	ug/L	ug/L	ug/L	ug/L	ug/L	ug/L	ug/L	ug/L	ug/L
	RWQCB ESL	100	1	40	30	20	5	0.5	6	10	0.5
	DHS MCL	-	1	150	300	1750	5	0.5	6	10	0.5
MW-13	6/28/2002	5,600	120	55	130	9.5	61	<0.5	430	14	4.4
	9/11/2002	4,500	58	7.5	150	14	63	<0.5	410	13	<1.3
	12/16/2002	4,800	90	<0.5	85	24	76	<0.5	250	9.4	1.8
	3/28/2003	4,400	55	<0.5	51	14.3	85	<0.5	150	13	1.8
	6/24/2003	8,300	100	<0.5	94	12	68	<1.0	250	19	4.2
	9/26/2003	7,200	150	<1.0	89	57	51	<1.0	270	23	5.1
	12/16/2003	8,100	120	36	72	26.6	66	<0.7	240	23	10
	4/6/2004	3,300	22	<1.0	37	9.0	90	<0.5	190	23	8
	6/23/2004	7,000	140	25	88	21	53	<2.0	350	31	25
	9/15/2004	6,700	84	<1.0	78	7.2	37	<1.7	300	40	31
	12/16/2004	4,300	61	<0.5	44	11.5	69	<2.0	240	32	15
	3/22/2005	3,000	24	<0.5	20	7.6	72	<0.5	120	23	6.6
	6/24/2005	2,600	63	<0.5	25	4.3	42	<1.0	150	36	16
	9/12/2005	2,500	20 C	<0.5	33	6.7 c	25	<1.3	170	38	22
	12/2/2005	4,200 Y	70 C	<0.5	21 C	15.5 C	17	<1.3	140	40	24
	3/2/2006	3,200 L Y	67 C	<0.5	27	5.19 C	43	<0.8	110	32	16
	6/15/2006	3,400	92 C	<0.5	26	3.4 C	43	<0.8	120	39	18
	9/14/2006	2,000	<0.5	<0.5	64 C	38 C	15	<0.8	93	45	17
	1/11/2007	25,000 Y	44	<5.0	160	69 C	24	<0.8	87	45	11

Notes:

- All results are reported in micrograms per liter ($\mu\text{g/L}$).
- NA refers to Not Analyzed.
- NS refers to Not Sampled.
- TPH-g refers to Total Petroleum Hydrocarbons as Gasoline.
- MTBE refers to Methyl tert-butyl ether.
- TCE refers to Trichloroethene.
- trans-1,2-DCE refers to trans-1,2-dichloroethene.
- cis-1,2-DCE refers to cis-1,2-Dichloroethene.
- VC refers to Vinyl Chloride.
- 1,2-DCA refers to 1,2-dichloroethane.
- Y=Sample exhibits chromatographic pattern which does not resemble standard.
- Z=Sample exhibits unknown single peak or peaks.
- C=Presence confirmed, but RPD between columns exceed 40%.
- L=Lighter hydrocarbons contributed to the quantitation.
- RWQCB ESL refers to the California Regional Water Quality Control Board Environmental Screening Level for shallow soils less than 10 feet deep assuming groundwater is a current or potential source of drinking water, as presented in Table A of the RWQCB ESLs (2005).
- DHS MCL refers to California Department of Health Services Maximum Contaminant Level.

FIGURES

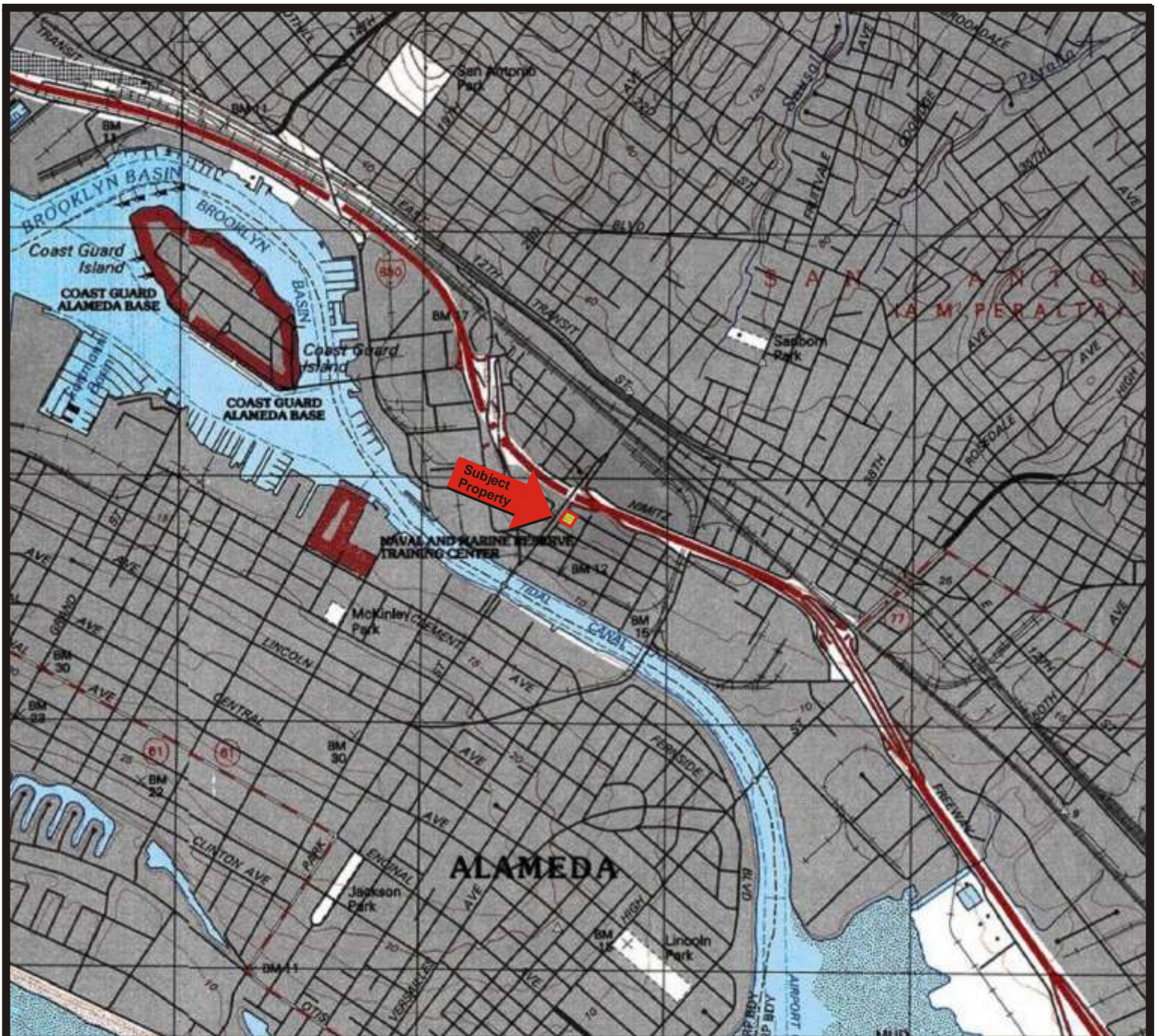

Map Source: TOPO!© 2000 National Geographic Holdings

Note: Boundaries and Location Information is Approximate

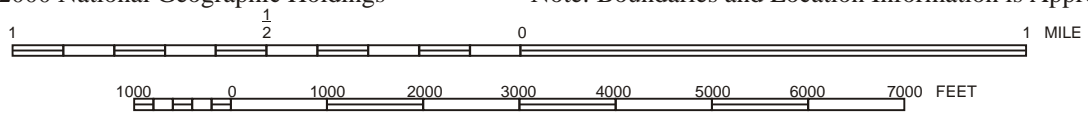

Portion of the 7.5-Minute Series Oakland East, California
 Quadrangle Topographic Map (Datum: NAD 27)
 United States Department of the Interior
 Geological Survey
 1997



QUADRANGLE LOCATION

PROPERTY LOCATION MAP
 Former Lemoine Sausage Factory
 630 29th Avenue
 Oakland, California
 Clayton Project No. 33104-004578.00

Figure

1



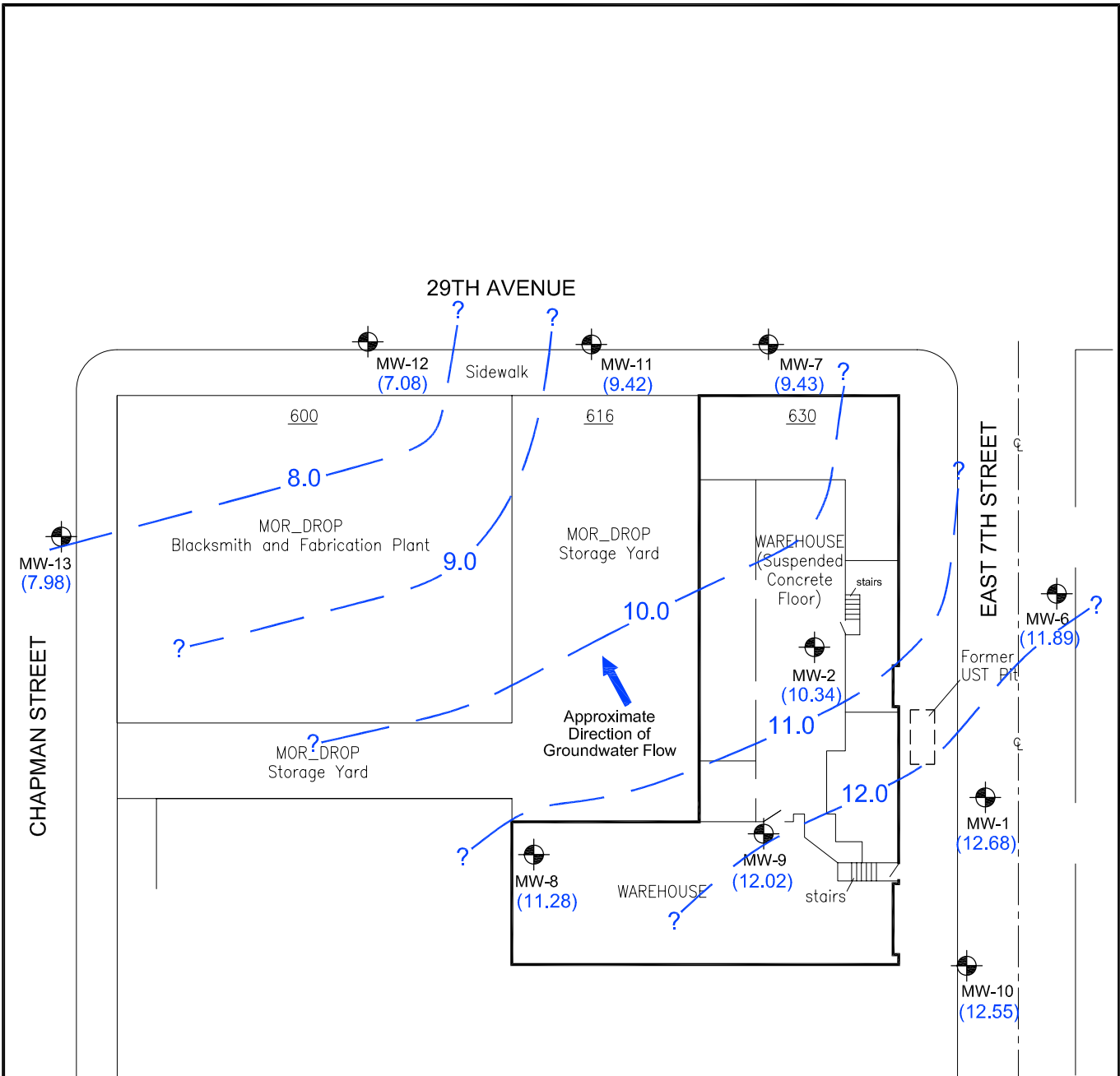

LEGEND:

MW-1  Existing Monitoring Well Location

(12.68) Groundwater Elevation (ft msl), 01/11/07

10- - - - Groundwater Surface Elevation Contour (ft msl)

ft msl Feet Above Mean Sea Level

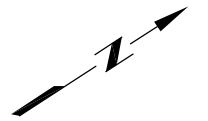

<p>GROUNDWATER ELEVATION MAP, 1ST QUARTER 2007</p> <p>FORMER LEMOINE SAUSAGE FACTORY 630 29TH AVENUE OAKLAND, CALIFORNIA Clayton Project No. 33104-004578.00</p>	<p>Figure 2 01/30/07 SITE0107.DWG</p>	 <p>BUREAU VERITAS</p>
---	--	--

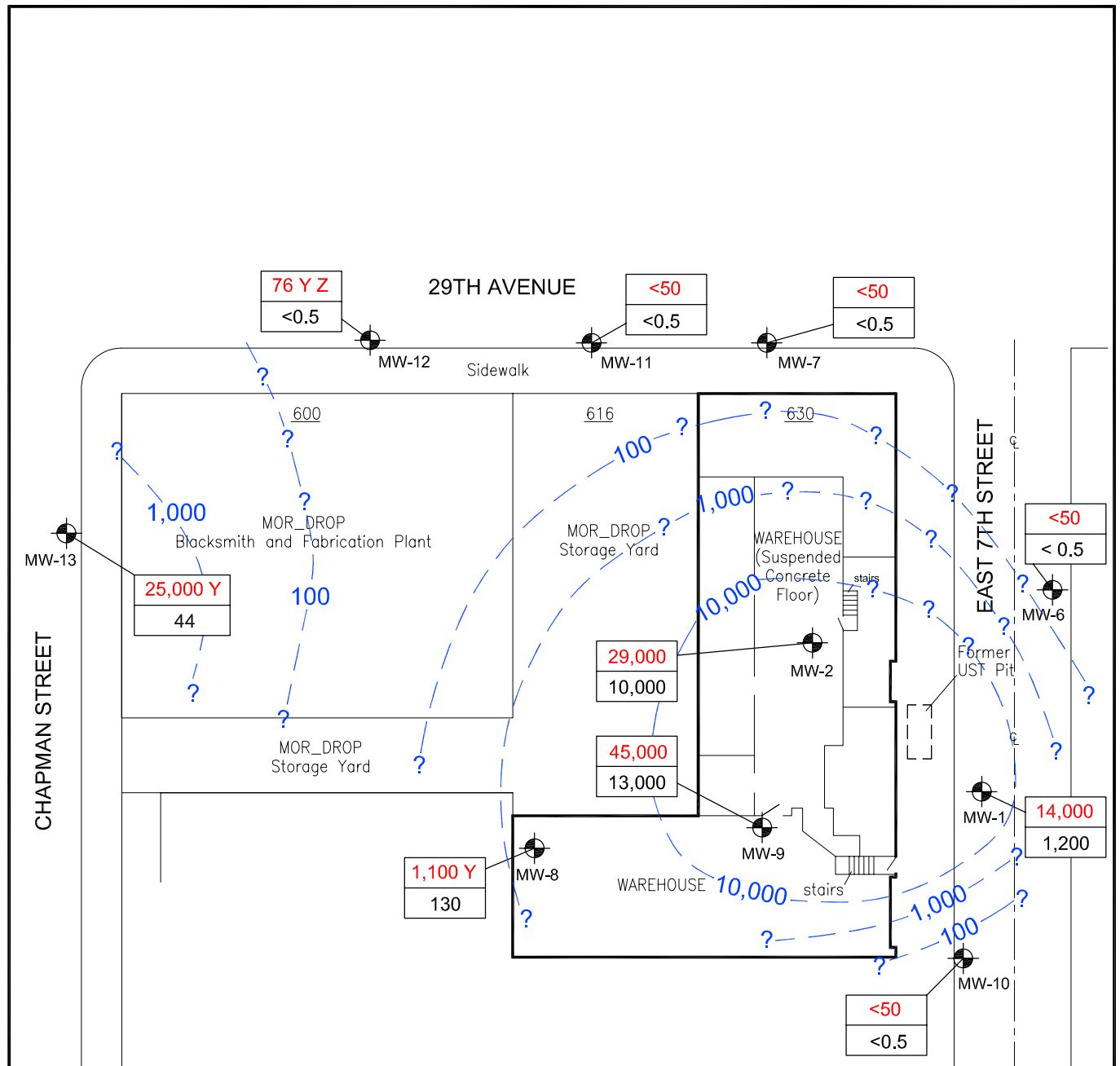

LEGEND:

MW-1  Existing Monitoring Well Location

 TPH-g Concentration (ug/L), 01/11/07

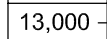
 Benzene Concentration (ug/L), 01/11/07

 TPH-g Isoconcentration Contour (ug/L)

TPH-g Total Petroleum Hydrocarbons as Gasoline
ug/L micrograms per liter

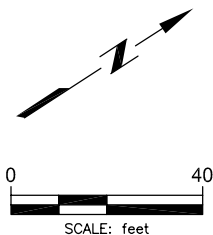

TPH-g CONCENTRATIONS IN GROUNDWATER, 1ST QUARTER 2007

FORMER LEMOINE SAUSAGE FACTORY
630 29TH AVENUE
OAKLAND, CALIFORNIA
Clayton Project No. 33104-004578.00

Figure

3

01/30/07
SITE0107.DWG



BUREAU VERITAS

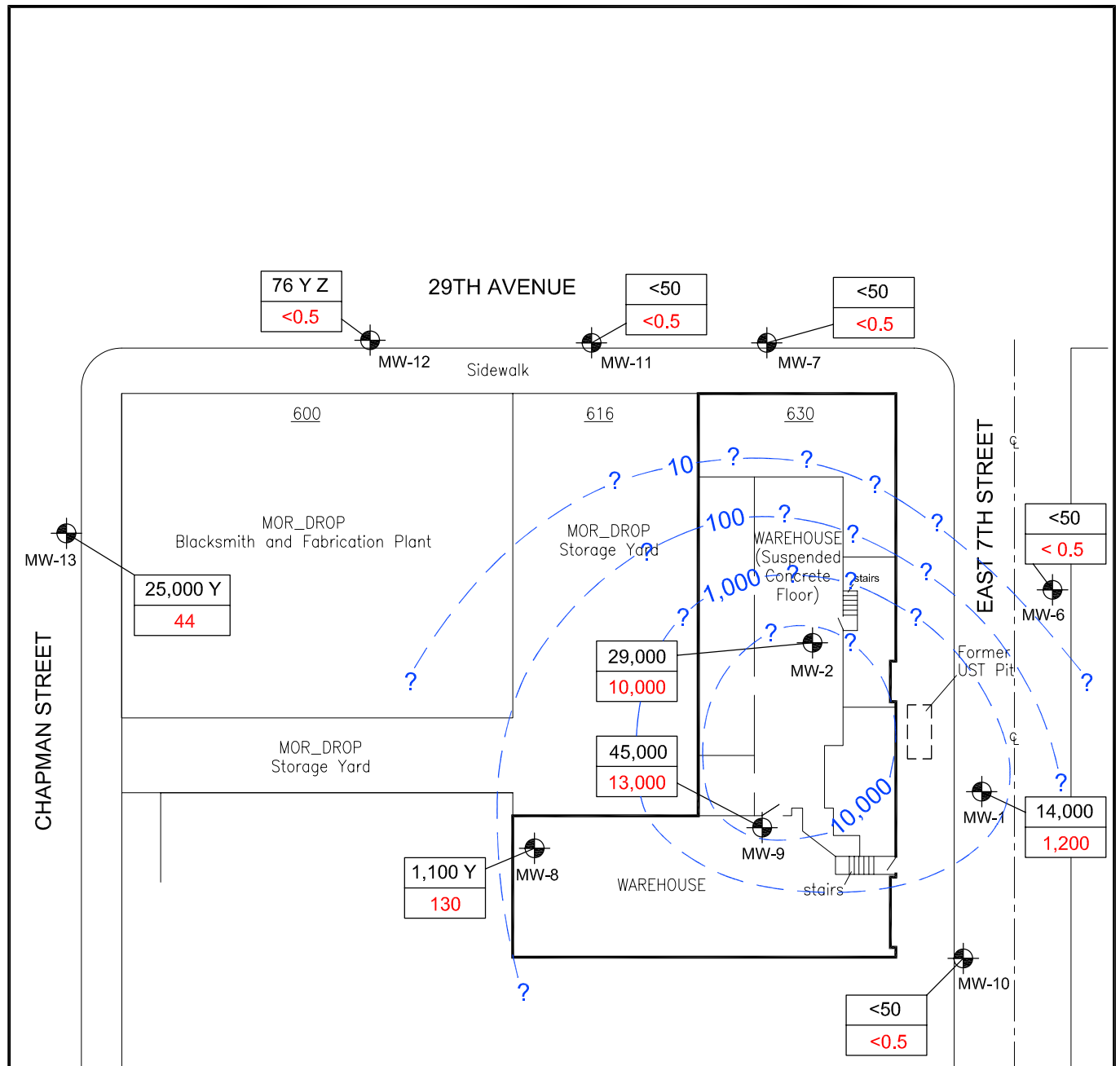

LEGEND:

MW-1 Existing Monitoring Well Location

TPH-g Concentration (ug/L), 01/11/07

Benzene Concentration (ug/L), 01/11/07

Benzene Isoconcentration Contour (ug/L)

TPH-g Total Petroleum Hydrocarbons as Gasoline
ug/L micrograms per liter

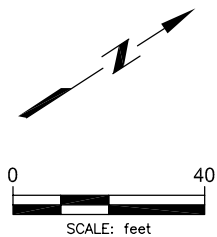

BENZENE CONCENTRATIONS IN GROUNDWATER, 1ST QUARTER 2007

FORMER LEMOINE SAUSAGE FACTORY
630 29TH AVENUE
OAKLAND, CALIFORNIA
Clayton Project No. 33104-004578.00

Figure

4

01/30/07
SITE0107.DWG



BUREAU VERITAS

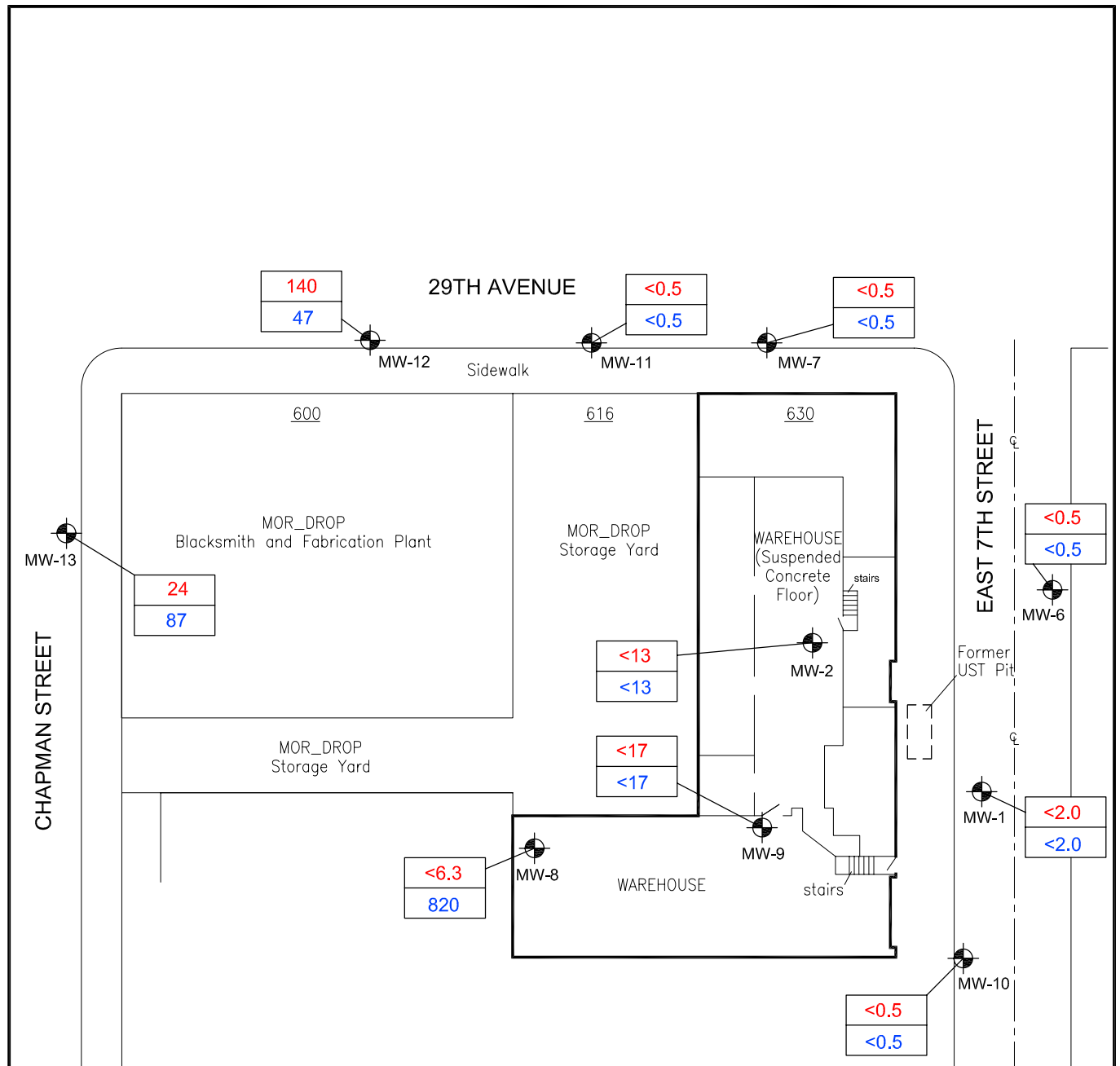

LEGEND:

- MW-1 Existing Monitoring Well Location
- | |
|-----|
| 7.6 |
| 800 |

 TCE Concentration (ug/L), 01/11/07
- | |
|-----|
| 800 |
|-----|

 cis-1,2-DCE Concentration (ug/L), 01/11/07
- TCE Trichloroethene
- cis 1,2-DCE cis 1,2-Dichloroethene
- ug/L micrograms per liter

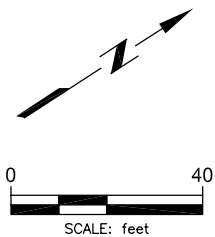

TCE AND cis-1,2-DCE CONCENTRATIONS IN GROUNDWATER, 1ST QUARTER 2007
 FORMER LEMOINE SAUSAGE FACTORY
 630 29TH AVENUE
 OAKLAND, CALIFORNIA
 Clayton Project No. 33104-004578.00

Figure
5
 01/30/07
 SITE0107.DWG



APPENDIX A
FIELD SAMPLING DATA SHEETS



GROUNDWATER SAMPLING DATA SHEET

Project Name: <i>Former Lemoine Sewage Facility</i>	Well ID Number: <i>MW - 1</i>
Project No.: <i>33104-00 457B-00</i>	Sample ID Number: <i>MW - 1</i>
Project Location: <i>630 24th Ave, Oakland, CA</i>	Date Gauged: <i>1/11/07</i>
Field Technician: <i>Adnan</i>	Date Purged: <i>1/11/07</i>
Weather Conditions: <i>~40, Sunny, breezy</i>	Date Sampled: <i>1/11/07</i>
Top of Casing Elevation (ft, msl): <i>16.69</i>	Casing Diameter (inches): <i>3/4</i>
Depth to Water Elevation (ft, btoc): 4.01 <i>4.01</i>	Wellhead Condition: <i>Good</i>
Groundwater Elevation (ft, msl): <i>12.68</i>	Presence of Wellhead Gases: <i>-</i>
Depth to Well Bottom (ft, btoc): <i>8.44</i>	Vapor Reading (ppm): <i>-</i>
Water Column Height (ft): <i>4.43</i>	Presence of SPH: <i>-</i>
Calculated Purge Volume (gal): <i>0.4</i>	Thickness of SPH (ft): <i>-</i>
Actual Purge Volume (gal): <i>0.4</i>	Comments: <i>-</i>

Gallons Per Foot: 1"=0.04, 2"=0.17, 3"=0.37, 4"=0.66, 6"=1.5, other= 2 x 0.163

PURGING MEASUREMENTS

Time	Volume Removed (gal)	Specific Conductivity (microhos/cm)	Temp (°C)	Dissolved Oxygen (mg/L)	pH (units)	Turbidity (NTUs)	ORP (mV)	Odor
<i>1240</i>	<i>~0.4</i>	7738 <i>544</i>	<i>13.3</i>		<i>7.38</i>	<i>260</i>		<i>-</i>
	<i>WELL</i>	<i>DRIED</i>	<i>AFTER</i>	<i>45T</i>	<i>PURGE VOLUME</i>			

Water Level Indicator Model & No.:	Purge Method: <i>Pari Pump</i>
pH/Cond/Temp Meter Model:	Purge Equipment Used: <i>"</i>
Turbidity Meter Model:	Purge Rate (gpm):
Sample Collection Time: <i>1300</i>	Chemical Laboratory: <i>CTT</i>
Sample Collection Method: <i>Pari Pump</i>	Chemical Analysis: <i>TPH-g, BTEX, VOCs</i>
Sample Containers Used: <i>6 VOAs</i>	
Other Field Observations: <i>Spec Cond = microhos/cm, Turbidity = TDS, ppm</i>	



GROUNDWATER SAMPLING DATA SHEET

Project Name: Former Lemoine Sewage Facility	Well ID Number: MW-2
Project No.: 33104-004578-00	Sample ID Number: MW-2
Project Location: 630, 24th Ave, Oakland, CA	Date Gauged: 1/11/07
Field Technician: Adnan	Date Purged: 1/11/07
Weather Conditions: ~40, sunny, breezy	Date Sampled: 1/11/07
Top of Casing Elevation (ft, msl): 20.79	Casing Diameter (inches): 3.4"
Depth to Water Elevation (ft, btoc): 10.45	Wellhead Condition: good
Groundwater Elevation (ft, msl): 10.34	Presence of Wellhead Gases: -
Depth to Well Bottom (ft, btoc): 20.55	Vapor Reading (ppm): -
Water Column Height (ft): 10.10	Presence of SPH: -
Calculated Purge Volume (gal): 219 0.7	Thickness of SPH (ft): -
Actual Purge Volume (gal): 219 ~2.3	Comments:

Gallons Per Foot: 1"=0.04, 2"=0.17, 3"=0.37, 4"=0.66, 6"=1.5, other= 12 x 0.163

PURGING MEASUREMENTS

Time	Volume Removed (gal)	Specific Conductivity (microhos/cm)	Temp (°C)	Dissolved Oxygen (mg/L)	pH (units)	Turbidity (NTUs)	ORP (mV)	Odor
12:10	0.5	3999	17.0		6.57	2000		-
	WELL DRIED							

Water Level Indicator Model & No.:	Purge Method: Peri Pump
pH/Cond/Temp Meter Model:	Purge Equipment Used: "
Turbidity Meter Model:	Purge Rate (gpm):
Sample Collection Time: 1230	Chemical Laboratory: C+T
Sample Collection Method: Peri Pump	Chemical Analysis: TPH-g, BTEX, VOCs
Sample Containers Used: 6 VOCs	
Other Field Observations: Spec Cond = cmhos, Turbidity = TDS, ppm	



GROUNDWATER SAMPLING DATA SHEET

Project Name: Former Lemoine Sewage Facility	Well ID Number: MW-6
Project No.: 33104-00 4578-00	Sample ID Number: MW-6
Project Location: 630 24th Ave, Oakland, CA	Date Gauged: 1/11/07
Field Technician: Adnan	Date Purged: 1/11/07
Weather Conditions: ~40, sunny, breezy	Date Sampled: 1/11/07
Top of Casing Elevation (ft, msl): 16.60	Casing Diameter (inches): 2
Depth to Water Elevation (ft, btoc): 4.71	Wellhead Condition: good
Groundwater Elevation (ft, msl): 11.89	Presence of Wellhead Gases: -
Depth to Well Bottom (ft, btoc): 20.13	Vapor Reading (ppm): -
Water Column Height (ft): 15.42	Presence of SPH: -
Calculated Purge Volume (gal): 2.6	Thickness of SPH (ft): -
Actual Purge Volume (gal): 10.4	Comments: -

Gallons Per Foot: 1"=0.04, 2"=0.17, 3"=0.37, 4"=0.66, 6"=1.5, other= r2 x 0.163

PURGING MEASUREMENTS

Time	Volume Removed (gal)	Specific Conductivity (<u>µmhos/cm</u>)	Temp (°C)	Dissolved Oxygen (mg/L)	pH (units)	^{ppm} Turbidity (NTUs)	ORP (mV)	Odor
1355	2.6	869	16.6		7.08	414		-
1405	2.6	906	18.2		7.07	434		-
1420	2.6	908	18.1		7.10	444		-
1430	2.6	900	18.1		7.11	447		-

Water Level Indicator Model & No.:	Purge Method: bailer
pH/Cond/Temp Meter Model:	Purge Equipment Used: bailer
Turbidity Meter Model:	Purge Rate (gpm):

Sample Collection Time: 1440	Chemical Laboratory: C+T
Sample Collection Method: bailer	Chemical Analysis: TPH-g, BTEX, VOCs
Sample Containers Used: 6 VOAs	

Other Field Observations: Spec Cond = µmhos/cm, Turbidity = TDS ppm



GROUNDWATER SAMPLING DATA SHEET

Project Name: <i>Former Lemoine Sewage Facility</i>	Well ID Number: <i>MW-7</i>
Project No.: <i>33104-004578-00</i>	Sample ID Number: <i>MW-7</i>
Project Location: <i>630, 24th Ave, Oakland, CA</i>	Date Gauged: <i>1/11/07</i>
Field Technician: <i>Adnan</i>	Date Purged: <i>1/11/07</i>
Weather Conditions: <i>N 50, sunny breezy</i>	Date Sampled: <i>1/11/07</i>
Top of Casing Elevation (ft, msl): <i>15.17</i>	Casing Diameter (inches): <i>2"</i>
Depth to Water Elevation (ft, btoc): <i>6.04</i>	Wellhead Condition: <i>good</i>
Groundwater Elevation (ft, msl): <i>9.43</i>	Presence of Wellhead Gases: <i>-</i>
Depth to Well Bottom (ft, btoc): <i>19.95</i>	Vapor Reading (ppm): <i>-</i>
Water Column Height (ft): <i>13.91</i>	Presence of SPH: <i>-</i>
Calculated Purge Volume (gal): <i>2.3</i>	Thickness of SPH (ft): <i>-</i>
Actual Purge Volume (gal): <i>9.2</i>	Comments:

Gallons Per Foot: 1"=0.04, 2"=0.17, 3"=0.37, 4"=0.66, 6"=1.5, other= r2 x 0.163

PURGING MEASUREMENTS

Time	Volume Removed (gal)	Specific Conductivity <small>(µmhos/cm)</small>	Temp (°C)	Dissolved Oxygen (mg/L)	pH (units)	^{ppm} Turbidity (NTUs)	ORP (mV)	Odor
<i>1735</i>	<i>2.3</i>	<i>993</i>	<i>16.6</i>		<i>7.50</i>	<i>470</i>		<i>-</i>
<i>1745</i>	<i>2.3</i>	<i>1001</i>	<i>17.3</i>		<i>7.42</i>	<i>481</i>		<i>-</i>
<i>1755</i>	<i>2.3</i>	<i>1010</i>	<i>18.4</i>		<i>7.37</i>	<i>496</i>		<i>-</i>
<i>1805</i>	<i>2.3</i>	<i>1007</i>	<i>18.2</i>		<i>7.40</i>	<i>499</i>		<i>-</i>

Water Level Indicator Model & No.:	Purge Method: <i>bailed</i>
pH/Cond/Temp Meter Model:	Purge Equipment Used: <i>"</i>
Turbidity Meter Model:	Purge Rate (gpm):

Sample Collection Time: <i>1815</i>	Chemical Laboratory: <i>C+T</i>
Sample Collection Method: <i>bailed</i>	Chemical Analysis: <i>TPH-g, BTEX, VOCs</i>
Sample Containers Used: <i>6 VOCs</i>	

Other Field Observations: *Spec Cond = µmhos/cm, Turbidity = TDS, ppm*



GROUNDWATER SAMPLING DATA SHEET

Project Name: Former Lemoine Sausage Factory	Well ID Number: MW-8
Project No.: 33104-00 4578-00	Sample ID Number: MW-8
Project Location: 630 24th Ave, Oakland, CA	Date Gauged: 1/11/07
Field Technician: Adnan	Date Purged: 1/11/07
Weather Conditions: ~40, Sunny, breezy	Date Sampled: 1/11/07
Top of Casing Elevation (ft, msl): 17.58	Casing Diameter (inches): 2"
Depth to Water Elevation (ft, btoc): 6.04 6.30	Wellhead Condition: good
Groundwater Elevation (ft, msl): 11.54 11.28	Presence of Wellhead Gases: -
Depth to Well Bottom (ft, btoc): 20.0	Vapor Reading (ppm): -
Water Column Height (ft): 13.7	Presence of SPH: -
Calculated Purge Volume (gal): 2.3	Thickness of SPH (ft): -
Actual Purge Volume (gal): 2.3 9.2	Comments:

Gallons Per Foot: 1"=0.04, 2"=0.17, 3"=0.37, 4"=0.66, 6"=1.5, other=1.2 x 0.163

PURGING MEASUREMENTS

Time	Volume Removed (gal)	Specific Conductivity (microhm/cm)	Temp (°C)	Dissolved Oxygen (mg/L)	pH (units)	Turbidity (NTUs)	ORP (mV)	Odor
1045	2.3	980	15.8		7.19	440		-
1050	2.3	1009	16.4		7.12	484		-
1055	2.3	986	16.5		7.06	471		-
1100	2.3	998	16.5		7.05	478		-

Water Level Indicator Model & No.:	Purge Method: bailer
pH/Cond/Temp Meter Model:	Purge Equipment Used: "
Turbidity Meter Model:	Purge Rate (gpm):
Sample Collection Time: 1110	Chemical Laboratory: C+T
Sample Collection Method: bailer	Chemical Analysis: TPH-g, BTEX, VOCs
Sample Containers Used: 6 VOAs	

Other Field Observations: Spec Cond = $\mu\text{mhos/cm}$, Turbidity = $\mu\text{TDS, ppm}$



GROUNDWATER SAMPLING DATA SHEET

Project Name: *Former Lemoine Sewage Facility* Well ID Number: *MW-9*
 Project No.: *33104-00457B-00* Sample ID Number: *MW-9*
 Project Location: *630 24th Ave, Oakland, CA* Date Gauged: *1/11/07*
 Field Technician: *Adnan* Date Purged: *1/11/07*
 Weather Conditions: *~45, sunny, breezy* Date Sampled: *1/11/07*

Top of Casing Elevation (ft, msl): *17.61* Casing Diameter (inches): *2"*
 Depth to Water Elevation (ft, btoc): *5.59* Wellhead Condition: *good*
 Groundwater Elevation (ft, msl): *12.02* Presence of Wellhead Gases: *-*
 Depth to Well Bottom (ft, btoc): *14.90* Vapor Reading (ppm): *-*
 Water Column Height (ft): *9.31* Presence of SPH: *-*
 Calculated Purge Volume (gal): *1.5* Thickness of SPH (ft): *-*
 Actual Purge Volume (gal): _____ Comments: _____

Gallons Per Foot: 1"=0.04, 2"=0.17, 3"=0.37, 4"=0.66, 6"=1.5, other= r2 x 0.163

PURGING MEASUREMENTS

Time	Volume Removed (gal)	Specific Conductivity (microhm/cm)	Temp (°C)	Dissolved Oxygen (mg/L)	pH (units)	Turbidity (NTUs)	ORP (mV)	Odor
<i>1130</i>	<i>1.5</i>	<i>3999</i>			<i>7.01</i>	<i>2000</i>		<i>-</i>
<i>1133</i>	<i>1.5</i>	<i>3999</i>			<i>6.45</i>	<i>2000</i>		<i>-</i>
<i>1140</i>	<i>1.5</i>	<i>3999</i>			<i>6.7</i>	<i>2000</i>		<i>-</i>
<i>1150</i>	<i>1.5</i>	<i>3999</i>			<i>6.7</i>	<i>2000</i>		<i>-</i>

Water Level Indicator Model & No.: _____ Purge Method: *boiler*
 pH/Cond/Temp Meter Model: _____ Purge Equipment Used: *"*
 Turbidity Meter Model: _____ Purge Rate (gpm): _____

Sample Collection Time: *1155* Chemical Laboratory: *LFT*
 Sample Collection Method: *boiler* Chemical Analysis: *TPH, BTEX, VOCs*
 Sample Containers Used: *6 VOCs*

Other Field Observations: *Spec Cond. = microhm/cm, Turbidity = FDS, ppm*



GROUNDWATER SAMPLING DATA SHEET

Project Name: <i>Former Lemoine Sewage Facility</i>	Well ID Number: <i>MW-10</i>
Project No.: <i>33104-004578-00</i>	Sample ID Number: <i>MW-10</i>
Project Location: <i>630 24th Ave, Oakland, CA</i>	Date Gauged: <i>1/11/07</i>
Field Technician: <i>Adnan</i>	Date Purged: <i>1/11/07</i>
Weather Conditions:	Date Sampled: <i>1/11/07</i>
Top of Casing Elevation (ft, msl): <i>16.92</i>	Casing Diameter (inches): <i>2</i>
Depth to Water Elevation (ft, btoc): <i>4.37</i>	Wellhead Condition: <i>good</i>
Groundwater Elevation (ft, msl): <i>12.55</i>	Presence of Wellhead Gases: <i>-</i>
Depth to Well Bottom (ft, btoc): <i>8.70</i>	Vapor Reading (ppm): <i>-</i>
Water Column Height (ft): <i>4.33</i>	Presence of SPH: <i>-</i>
Calculated Purge Volume (gal): <i>0.7</i>	Thickness of SPH (ft): <i>-</i>
Actual Purge Volume (gal): <i>2.8</i>	Comments:

Gallons Per Foot: 1"=0.04, 2"=0.17, 3"=0.37, 4"=0.66, 6"=1.5, other= r2 x 0.163

PURGING MEASUREMENTS

Time	Volume Removed (gal)	Specific Conductivity ($\mu\text{mhos/cm}$)	Temp (°C)	Dissolved Oxygen (mg/L)	pH (units)	SPH Turbidity (NTUs)	ORP (mV)	Odor
<i>1315</i>	<i>0.7</i>	<i>460</i>	<i>14.6</i>			<i>220</i>		<i>-</i>
<i>1320</i>	<i>0.7</i>	<i>480</i>	<i>14.9</i>			<i>230</i>		<i>-</i>
<i>1325</i>	<i>0.7</i>	<i>478</i>	<i>15.0</i>			<i>229</i>		<i>-</i>
<i>1330</i>	<i>0.7</i>	<i>480</i>	<i>15.0</i>			<i>230</i>		<i>-</i>

Water Level Indicator Model & No.:	Purge Method: <i>ba/w</i>
pH/Cond/Temp Meter Model:	Purge Equipment Used: <i>ba/w</i>
Turbidity Meter Model:	Purge Rate (gpm):
Sample Collection Time: <i>1335</i>	Chemical Laboratory: <i>C+T</i>
Sample Collection Method: <i>ba/w</i>	Chemical Analysis: <i>TPH, BTEX, VOCs</i>
Sample Containers Used: <i>6 VOCs</i>	
Other Field Observations: <i>Spec Cond = $\mu\text{mhos/cm}$, Turbidity = TDS, ppm</i>	



GROUNDWATER SAMPLING DATA SHEET

Project Name: <i>Former Lemoine Sewage Facility</i>	Well ID Number: <i>MW - 11</i>
Project No.: <i>33104-004578-00</i>	Sample ID Number: <i>MW - 11</i>
Project Location: <i>630 24th Ave, Oakland, CA</i>	Date Gauged: <i>1/11/07</i>
Field Technician: <i>Adnan</i>	Date Purged: <i>1/11/07</i>
Weather Conditions: <i>~50, sunny, breezy</i>	Date Sampled: <i>1/11/07</i>
Top of Casing Elevation (ft, msl): <i>14.87</i>	Casing Diameter (inches): <i>2</i>
Depth to Water Elevation (ft, btoc): <i>5.45</i>	Wellhead Condition: <i>good</i>
Groundwater Elevation (ft, msl): <i>9.42</i>	Presence of Wellhead Gases:
Depth to Well Bottom (ft, btoc): <i>15.11</i>	Vapor Reading (ppm):
Water Column Height (ft): <i>9.66</i>	Presence of SPH:
Calculated Purge Volume (gal): <i>1.6</i>	Thickness of SPH (ft):
Actual Purge Volume (gal): <i>4.8</i>	Comments:

Gallons Per Foot: 1"=0.04, 2"=0.17, 3"=0.37, 4"=0.66, 6"=1.5, other= r2 x 0.163

PURGING MEASUREMENTS

Time	Volume Removed (gal)	Specific Conductivity ($\mu\text{mhos/cm}$)	Temp (°C)	Dissolved Oxygen (mg/L)	pH (units)	Turbidity (NTUs)	ORP (mV)	Odor
<i>1645</i>	<i>1.6</i>	<i>1373</i>	<i>16.5</i>		<i>7.44</i>	<i>656</i>		<i>gasoline - slight</i>
<i>1655</i>	<i>1.6</i>	<i>1356</i>	<i>16.5</i>		<i>7.39</i>	<i>649</i>		↓
<i>1705</i>	<i>1.6</i>	<i>1362</i>	<i>16.5</i>		<i>7.30</i>	<i>648</i>		↓

Water Level Indicator Model & No.:	Purge Method: <i>baile</i>
pH/Cond/Temp Meter Model:	Purge Equipment Used: <i>"</i>
Turbidity Meter Model:	Purge Rate (gpm):
Sample Collection Time: <i>1715</i>	Chemical Laboratory: <i>C+T</i>
Sample Collection Method: <i>baile</i>	Chemical Analysis: <i>TPH-g, BTEX, VOCs</i>
Sample Containers Used: <i>6 VOAs</i>	

Other Field Observations: *Spec Cond = $\mu\text{mhos/cm}$, Turbidity = TDS, ppm*



GROUNDWATER SAMPLING DATA SHEET

Project Name: <i>Former Lemoine Sewage Facility</i>	Well ID Number: <i>MW-12</i>
Project No.: <i>33104-00 4578-00</i>	Sample ID Number: <i>MW-12</i>
Project Location: <i>630 24th Ave, Oakland, CA</i>	Date Gauged: <i>1/11/07</i>
Field Technician: <i>Adnan</i>	Date Purged: <i>1/11/07</i>
Weather Conditions: <i>~50, sunny, breezy</i>	Date Sampled: <i>1/11/07</i>
Top of Casing Elevation (ft, msl): <i>14.05</i>	Casing Diameter (inches):
Depth to Water Elevation (ft, btoc): 6.88 <i>6.97</i>	Wellhead Condition:
Groundwater Elevation (ft, msl): 15 <i>7.08</i>	Presence of Wellhead Gases:
Depth to Well Bottom (ft, btoc): <i>15.59</i>	Vapor Reading (ppm):
Water Column Height (ft): <i>8.92</i>	Presence of SPH:
Calculated Purge Volume (gal): 80.88 <i>1.5</i>	Thickness of SPH (ft):
Actual Purge Volume (gal): <i>4.5</i>	Comments:

Gallons Per Foot: 1"=0.04, 2"=0.17, 3"=0.37, 4"=0.66, 6"=1.5, other= (2 x 0.163)

PURGING MEASUREMENTS

Time	Volume Removed (gal)	Specific Conductivity (micromhos/cm)	Temp (°C)	Dissolved Oxygen (mg/L)	pH (units)	Turbidity (NTUs) <small>ppm</small>	ORP (mV)	Odor
<i>1600</i>	<i>1.5</i>	<i>1393</i>	<i>16.6</i>		<i>7.30</i>	<i>664</i>		<i>-</i>
<i>1610</i>	<i>1.5</i>	<i>1361</i>	<i>16.6</i>		<i>7.40</i>	<i>672</i>		<i>-</i>
<i>1620</i>	<i>1.5</i>	<i>1384</i>	<i>16.6</i>		<i>7.34</i>	<i>664</i>		<i>-</i>

Water Level Indicator Model & No.:	Purge Method: <i>boiler</i>
pH/Cond/Temp Meter Model:	Purge Equipment Used: <i> </i>
Turbidity Meter Model:	Purge Rate (gpm):
Sample Collection Time: <i>1630</i>	Chemical Laboratory: <i>CHT</i>
Sample Collection Method: <i>boiler</i>	Chemical Analysis: <i>TPH-g, BTEX, VOCs</i>
Sample Containers Used: <i>6 VOA's</i>	
Other Field Observations: <i>Spec Cond = umhos/cm, Turbidity = TDS, ppm</i>	



GROUNDWATER SAMPLING DATA SHEET

Project Name: <i>Former Lemoine Sewage Facility</i>	Well ID Number: <i>MW-13</i>
Project No.: <i>33104-00 4578-00</i>	Sample ID Number: <i>MW-13</i>
Project Location: <i>630 24th Ave, Oakland, CA</i>	Date Gauged: <i>1/11/07</i>
Field Technician: <i>Adnan</i>	Date Purged: <i>1/11/07</i>
Weather Conditions:	Date Sampled: <i>1/11/07</i>
Top of Casing Elevation (ft, msl): <i>13.39</i>	Casing Diameter (inches):
Depth to Water Elevation (ft, btoc): <i>5.41</i>	Wellhead Condition:
Groundwater Elevation (ft, msl): <i>7.98</i>	Presence of Wellhead Gases:
Depth to Well Bottom (ft, btoc): <i>14.32</i>	Vapor Reading (ppm):
Water Column Height (ft): <i>8.91</i>	Presence of SPH:
Calculated Purge Volume (gal): <i>1.5</i>	Thickness of SPH (ft):
Actual Purge Volume (gal):	Comments:

Gallons Per Foot: 1"=0.04, 2"=0.17, 3"=0.37, 4"=0.66, 6"=1.5, other= r2 x 0.163

PURGING MEASUREMENTS

Time	Volume Removed (gal)	Specific Conductivity <small>(µmhos/cm)</small>	Temp (°C)	Dissolved Oxygen (mg/L)	pH (units)	Turbidity <small>(NTUs)</small>	ORP (mV)	Odor
<i>1500</i>	<i>1.5</i>	<i>726</i>			<i>7.39</i>			
<i>1510</i>	<i>1.5</i>	<i>725</i>			<i>7.23</i>			
<i>1520</i>	<i>1.5</i>	<i>731</i>			<i>7.20</i>			
<i>1525</i>	<i>1.5</i>	<i>740</i>			<i>7.19</i>			
<i>1530</i>	<i>1.5</i>	<i>737</i>			<i>7.20</i>			

Water Level Indicator Model & No.:	Purge Method: <i>boiler</i>
pH/Cond/Temp Meter Model:	Purge Equipment Used: <i>"</i>
Turbidity Meter Model:	Purge Rate (gpm):
Sample Collection Time: <i>1535</i>	Chemical Laboratory: <i>C+T</i>
Sample Collection Method: <i>boiler</i>	Chemical Analysis: <i>TPH-g, BTEX, VOLs</i>
Sample Containers Used: <i>6 VOCs</i>	
Other Field Observations: <i>Spec Cond = µmhos/cm, Turbidity = TDS, ppm</i>	

APPENDIX B

**CHAIN-OF-CUSTODY DOCUMENTATION AND CERTIFIED
ANALYTICAL REPORTS**

CASE NARRATIVE

Laboratory number: 192085
Client: Clayton Group Services
Location: Sausage Factory
Request Date: 01/12/07
Samples Received: 01/12/07

This hardcopy data package contains sample and QC results for eleven water samples, requested for the above referenced project on 01/12/07. The samples were received intact.

TPH-Purgeables and/or BTXE by GC (EPA 8015B and EPA 8021B):

High surrogate recovery was observed for bromofluorobenzene (FID) in MW-13 (lab # 192085-010); the corresponding trifluorotoluene (FID) surrogate recovery was within limits. High surrogate recoveries were observed for trifluorotoluene (PID) in MW-08 (lab # 192085-005) and MW-13 (lab # 192085-010). High surrogate recovery was observed for bromofluorobenzene (PID) in MW-13 (lab # 192085-010). No other analytical problems were encountered.

Volatile Organics by GC/MS (EPA 8260B):

No analytical problems were encountered.

Curtis & Tompkins Laboratories Analytical Report

Lab #:	192085	Location:	Sausage Factory
Client:	Clayton Group Services	Prep:	EPA 5030B
Project#:	STANDARD		
Matrix:	Water	Sampled:	01/11/07
Units:	ug/L	Received:	01/12/07

Field ID: MW-01	Diln Fac: 5.000
Type: SAMPLE	Batch#: 121230
Lab ID: 192085-001	Analyzed: 01/15/07

Analyte	Result	RL	Analysis
Gasoline C7-C12	14,000	250	EPA 8015B
Benzene	1,200	2.5	EPA 8021B
Toluene	270	2.5	EPA 8021B
Ethylbenzene	450	2.5	EPA 8021B
m,p-Xylenes	670	2.5	EPA 8021B
o-Xylene	180	2.5	EPA 8021B

Surrogate	%REC	Limits	Analysis
Trifluorotoluene (FID)	124	69-137	EPA 8015B
Bromofluorobenzene (FID)	113	80-133	EPA 8015B
Trifluorotoluene (PID)	97	64-132	EPA 8021B
Bromofluorobenzene (PID)	91	80-120	EPA 8021B

Field ID: MW-02	Diln Fac: 50.00
Type: SAMPLE	Batch#: 121230
Lab ID: 192085-002	Analyzed: 01/16/07

Analyte	Result	RL	Analysis
Gasoline C7-C12	29,000	2,500	EPA 8015B
Benzene	10,000	25	EPA 8021B
Toluene	240	25	EPA 8021B
Ethylbenzene	1,100	25	EPA 8021B
m,p-Xylenes	1,100	25	EPA 8021B
o-Xylene	240	25	EPA 8021B

Surrogate	%REC	Limits	Analysis
Trifluorotoluene (FID)	102	69-137	EPA 8015B
Bromofluorobenzene (FID)	95	80-133	EPA 8015B
Trifluorotoluene (PID)	115	64-132	EPA 8021B
Bromofluorobenzene (PID)	112	80-120	EPA 8021B

*= Value outside of QC limits; see narrative
 C= Presence confirmed, but RPD between columns exceeds 40%
 Y= Sample exhibits chromatographic pattern which does not resemble standard
 Z= Sample exhibits unknown single peak or peaks
 ND= Not Detected
 RL= Reporting Limit

Curtis & Tompkins Laboratories Analytical Report

Lab #:	192085	Location:	Sausage Factory
Client:	Clayton Group Services	Prep:	EPA 5030B
Project#:	STANDARD		
Matrix:	Water	Sampled:	01/11/07
Units:	ug/L	Received:	01/12/07

Field ID:	MW-06	Diln Fac:	1.000
Type:	SAMPLE	Batch#:	121209
Lab ID:	192085-003	Analyzed:	01/13/07

Analyte	Result	RL	Analysis
Gasoline C7-C12	ND	50	EPA 8015B
Benzene	ND	0.50	EPA 8021B
Toluene	ND	0.50	EPA 8021B
Ethylbenzene	ND	0.50	EPA 8021B
m,p-Xylenes	ND	0.50	EPA 8021B
o-Xylene	ND	0.50	EPA 8021B

Surrogate	%REC	Limits	Analysis
Trifluorotoluene (FID)	95	69-137	EPA 8015B
Bromofluorobenzene (FID)	92	80-133	EPA 8015B
Trifluorotoluene (PID)	90	64-132	EPA 8021B
Bromofluorobenzene (PID)	90	80-120	EPA 8021B

Field ID:	MW-07	Diln Fac:	1.000
Type:	SAMPLE	Batch#:	121209
Lab ID:	192085-004	Analyzed:	01/13/07

Analyte	Result	RL	Analysis
Gasoline C7-C12	ND	50	EPA 8015B
Benzene	ND	0.50	EPA 8021B
Toluene	ND	0.50	EPA 8021B
Ethylbenzene	ND	0.50	EPA 8021B
m,p-Xylenes	ND	0.50	EPA 8021B
o-Xylene	ND	0.50	EPA 8021B

Surrogate	%REC	Limits	Analysis
Trifluorotoluene (FID)	102	69-137	EPA 8015B
Bromofluorobenzene (FID)	102	80-133	EPA 8015B
Trifluorotoluene (PID)	102	64-132	EPA 8021B
Bromofluorobenzene (PID)	102	80-120	EPA 8021B

*= Value outside of QC limits; see narrative
 C= Presence confirmed, but RPD between columns exceeds 40%
 Y= Sample exhibits chromatographic pattern which does not resemble standard
 Z= Sample exhibits unknown single peak or peaks
 ND= Not Detected
 RL= Reporting Limit

Curtis & Tompkins Laboratories Analytical Report

Lab #:	192085	Location:	Sausage Factory
Client:	Clayton Group Services	Prep:	EPA 5030B
Project#:	STANDARD		
Matrix:	Water	Sampled:	01/11/07
Units:	ug/L	Received:	01/12/07

Field ID:	MW-08	Diln Fac:	1.000
Type:	SAMPLE	Batch#:	121209
Lab ID:	192085-005	Analyzed:	01/13/07

Analyte	Result	RL	Analysis
Gasoline C7-C12	1,100 Y	50	EPA 8015B
Benzene	130	0.50	EPA 8021B
Toluene	ND	0.50	EPA 8021B
Ethylbenzene	49	0.50	EPA 8021B
m,p-Xylenes	1.1 C	0.50	EPA 8021B
o-Xylene	ND	0.50	EPA 8021B

Surrogate	%REC	Limits	Analysis
Trifluorotoluene (FID)	111	69-137	EPA 8015B
Bromofluorobenzene (FID)	112	80-133	EPA 8015B
Trifluorotoluene (PID)	135 *	64-132	EPA 8021B
Bromofluorobenzene (PID)	119	80-120	EPA 8021B

Field ID:	MW-09	Diln Fac:	50.00
Type:	SAMPLE	Batch#:	121230
Lab ID:	192085-006	Analyzed:	01/16/07

Analyte	Result	RL	Analysis
Gasoline C7-C12	45,000	2,500	EPA 8015B
Benzene	13,000	25	EPA 8021B
Toluene	460	25	EPA 8021B
Ethylbenzene	1,100	25	EPA 8021B
m,p-Xylenes	2,600	25	EPA 8021B
o-Xylene	450	25	EPA 8021B

Surrogate	%REC	Limits	Analysis
Trifluorotoluene (FID)	118	69-137	EPA 8015B
Bromofluorobenzene (FID)	104	80-133	EPA 8015B
Trifluorotoluene (PID)	119	64-132	EPA 8021B
Bromofluorobenzene (PID)	120	80-120	EPA 8021B

*= Value outside of QC limits; see narrative
 C= Presence confirmed, but RPD between columns exceeds 40%
 Y= Sample exhibits chromatographic pattern which does not resemble standard
 Z= Sample exhibits unknown single peak or peaks
 ND= Not Detected
 RL= Reporting Limit

Curtis & Tompkins Laboratories Analytical Report

Lab #:	192085	Location:	Sausage Factory
Client:	Clayton Group Services	Prep:	EPA 5030B
Project#:	STANDARD		
Matrix:	Water	Sampled:	01/11/07
Units:	ug/L	Received:	01/12/07

Field ID:	MW-10	Diln Fac:	1.000
Type:	SAMPLE	Batch#:	121230
Lab ID:	192085-007	Analyzed:	01/15/07

Analyte	Result	RL	Analysis
Gasoline C7-C12	ND	50	EPA 8015B
Benzene	ND	0.50	EPA 8021B
Toluene	ND	0.50	EPA 8021B
Ethylbenzene	ND	0.50	EPA 8021B
m,p-Xylenes	ND	0.50	EPA 8021B
o-Xylene	ND	0.50	EPA 8021B

Surrogate	%REC	Limits	Analysis
Trifluorotoluene (FID)	99	69-137	EPA 8015B
Bromofluorobenzene (FID)	103	80-133	EPA 8015B
Trifluorotoluene (PID)	109	64-132	EPA 8021B
Bromofluorobenzene (PID)	115	80-120	EPA 8021B

Field ID:	MW-11	Diln Fac:	1.000
Type:	SAMPLE	Batch#:	121209
Lab ID:	192085-008	Analyzed:	01/13/07

Analyte	Result	RL	Analysis
Gasoline C7-C12	ND	50	EPA 8015B
Benzene	ND	0.50	EPA 8021B
Toluene	ND	0.50	EPA 8021B
Ethylbenzene	ND	0.50	EPA 8021B
m,p-Xylenes	ND	0.50	EPA 8021B
o-Xylene	ND	0.50	EPA 8021B

Surrogate	%REC	Limits	Analysis
Trifluorotoluene (FID)	89	69-137	EPA 8015B
Bromofluorobenzene (FID)	91	80-133	EPA 8015B
Trifluorotoluene (PID)	83	64-132	EPA 8021B
Bromofluorobenzene (PID)	86	80-120	EPA 8021B

*= Value outside of QC limits; see narrative
 C= Presence confirmed, but RPD between columns exceeds 40%
 Y= Sample exhibits chromatographic pattern which does not resemble standard
 Z= Sample exhibits unknown single peak or peaks
 ND= Not Detected
 RL= Reporting Limit

Curtis & Tompkins Laboratories Analytical Report

Lab #:	192085	Location:	Sausage Factory
Client:	Clayton Group Services	Prep:	EPA 5030B
Project#:	STANDARD		
Matrix:	Water	Sampled:	01/11/07
Units:	ug/L	Received:	01/12/07

Field ID:	MW-12	Diln Fac:	1.000
Type:	SAMPLE	Batch#:	121209
Lab ID:	192085-009	Analyzed:	01/13/07

Analyte	Result	RL	Analysis
Gasoline C7-C12	76 Y Z	50	EPA 8015B
Benzene	ND	0.50	EPA 8021B
Toluene	ND	0.50	EPA 8021B
Ethylbenzene	ND	0.50	EPA 8021B
m,p-Xylenes	ND	0.50	EPA 8021B
o-Xylene	ND	0.50	EPA 8021B

Surrogate	%REC	Limits	Analysis
Trifluorotoluene (FID)	98	69-137	EPA 8015B
Bromofluorobenzene (FID)	102	80-133	EPA 8015B
Trifluorotoluene (PID)	109	64-132	EPA 8021B
Bromofluorobenzene (PID)	102	80-120	EPA 8021B

Field ID:	MW-13	Diln Fac:	10.00
Type:	SAMPLE	Batch#:	121209
Lab ID:	192085-010	Analyzed:	01/13/07

Analyte	Result	RL	Analysis
Gasoline C7-C12	25,000 Y	500	EPA 8015B
Benzene	44	5.0	EPA 8021B
Toluene	ND	5.0	EPA 8021B
Ethylbenzene	160	5.0	EPA 8021B
m,p-Xylenes	69 C	5.0	EPA 8021B
o-Xylene	ND	5.0	EPA 8021B

Surrogate	%REC	Limits	Analysis
Trifluorotoluene (FID)	115	69-137	EPA 8015B
Bromofluorobenzene (FID)	144 *	80-133	EPA 8015B
Trifluorotoluene (PID)	147 *	64-132	EPA 8021B
Bromofluorobenzene (PID)	139 *	80-120	EPA 8021B

*= Value outside of QC limits; see narrative
 C= Presence confirmed, but RPD between columns exceeds 40%
 Y= Sample exhibits chromatographic pattern which does not resemble standard
 Z= Sample exhibits unknown single peak or peaks
 ND= Not Detected
 RL= Reporting Limit

Curtis & Tompkins Laboratories Analytical Report

Lab #:	192085	Location:	Sausage Factory
Client:	Clayton Group Services	Prep:	EPA 5030B
Project#:	STANDARD		
Matrix:	Water	Sampled:	01/11/07
Units:	ug/L	Received:	01/12/07

Field ID:	TRIP BLANK	Diln Fac:	1.000
Type:	SAMPLE	Batch#:	121230
Lab ID:	192085-011	Analyzed:	01/15/07

Analyte	Result	RL	Analysis
Gasoline C7-C12	ND	50	EPA 8015B
Benzene	ND	0.50	EPA 8021B
Toluene	ND	0.50	EPA 8021B
Ethylbenzene	ND	0.50	EPA 8021B
m,p-Xylenes	ND	0.50	EPA 8021B
o-Xylene	ND	0.50	EPA 8021B

Surrogate	%REC	Limits	Analysis
Trifluorotoluene (FID)	95	69-137	EPA 8015B
Bromofluorobenzene (FID)	97	80-133	EPA 8015B
Trifluorotoluene (PID)	100	64-132	EPA 8021B
Bromofluorobenzene (PID)	103	80-120	EPA 8021B

Type:	BLANK	Batch#:	121209
Lab ID:	QC371664	Analyzed:	01/12/07
Diln Fac:	1.000		

Analyte	Result	RL	Analysis
Gasoline C7-C12	ND	50	EPA 8015B
Benzene	ND	0.50	EPA 8021B
Toluene	ND	0.50	EPA 8021B
Ethylbenzene	ND	0.50	EPA 8021B
m,p-Xylenes	ND	0.50	EPA 8021B
o-Xylene	ND	0.50	EPA 8021B

Surrogate	%REC	Limits	Analysis
Trifluorotoluene (FID)	96	69-137	EPA 8015B
Bromofluorobenzene (FID)	96	80-133	EPA 8015B
Trifluorotoluene (PID)	101	64-132	EPA 8021B
Bromofluorobenzene (PID)	100	80-120	EPA 8021B

*= Value outside of QC limits; see narrative
 C= Presence confirmed, but RPD between columns exceeds 40%
 Y= Sample exhibits chromatographic pattern which does not resemble standard
 Z= Sample exhibits unknown single peak or peaks
 ND= Not Detected
 RL= Reporting Limit

Curtis & Tompkins Laboratories Analytical Report

Lab #:	192085	Location:	Sausage Factory
Client:	Clayton Group Services	Prep:	EPA 5030B
Project#:	STANDARD		
Matrix:	Water	Sampled:	01/11/07
Units:	ug/L	Received:	01/12/07

Type:	BLANK	Batch#:	121230
Lab ID:	QC371736	Analyzed:	01/15/07
Diln Fac:	1.000		

Analyte	Result	RL	Analysis
Gasoline C7-C12	ND	50	EPA 8015B
Benzene	ND	0.50	EPA 8021B
Toluene	ND	0.50	EPA 8021B
Ethylbenzene	ND	0.50	EPA 8021B
m,p-Xylenes	ND	0.50	EPA 8021B
o-Xylene	ND	0.50	EPA 8021B

Surrogate	%REC	Limits	Analysis
Trifluorotoluene (FID)	99	69-137	EPA 8015B
Bromofluorobenzene (FID)	102	80-133	EPA 8015B
Trifluorotoluene (PID)	76	64-132	EPA 8021B
Bromofluorobenzene (PID)	80	80-120	EPA 8021B

*= Value outside of QC limits; see narrative
 C= Presence confirmed, but RPD between columns exceeds 40%
 Y= Sample exhibits chromatographic pattern which does not resemble standard
 Z= Sample exhibits unknown single peak or peaks
 ND= Not Detected
 RL= Reporting Limit

Batch QC Report

Curtis & Tompkins Laboratories Analytical Report

Lab #:	192085	Location:	Sausage Factory
Client:	Clayton Group Services	Prep:	EPA 5030B
Project#:	STANDARD	Analysis:	EPA 8021B
Type:	LCS	Diln Fac:	1.000
Lab ID:	QC371665	Batch#:	121209
Matrix:	Water	Analyzed:	01/12/07
Units:	ug/L		

Analyte	Spiked	Result	%REC	Limits
Benzene	20.00	18.15	91	80-120
Toluene	20.00	18.67	93	80-120
Ethylbenzene	20.00	19.23	96	80-120
m,p-Xylenes	20.00	19.90	100	80-120
o-Xylene	20.00	19.87	99	80-120

Surrogate	%REC	Limits
Trifluorotoluene (PID)	112	64-132
Bromofluorobenzene (PID)	115	80-120

Batch QC Report

Curtis & Tompkins Laboratories Analytical Report

Lab #:	192085	Location:	Sausage Factory
Client:	Clayton Group Services	Prep:	EPA 5030B
Project#:	STANDARD	Analysis:	EPA 8015B
Type:	LCS	Diln Fac:	1.000
Lab ID:	QC371666	Batch#:	121209
Matrix:	Water	Analyzed:	01/12/07
Units:	ug/L		

Analyte	Spiked	Result	%REC	Limits
Gasoline C7-C12	2,000	1,860	93	80-120

Surrogate	%REC	Limits
Trifluorotoluene (FID)	104	69-137
Bromofluorobenzene (FID)	113	80-133

Batch QC Report

Curtis & Tompkins Laboratories Analytical Report

Lab #:	192085	Location:	Sausage Factory
Client:	Clayton Group Services	Prep:	EPA 5030B
Project#:	STANDARD	Analysis:	EPA 8015B
Field ID:	ZZZZZZZZZZ	Batch#:	121209
MSS Lab ID:	192080-001	Sampled:	01/11/07
Matrix:	Water	Received:	01/12/07
Units:	ug/L	Analyzed:	01/12/07
Diln Fac:	1.000		

Type: MS Lab ID: QC371667

Analyte	MSS Result	Spiked	Result	%REC	Limits
Gasoline C7-C12	18.28	2,000	1,840	91	80-120

Surrogate	%REC	Limits
Trifluorotoluene (FID)	100	69-137
Bromofluorobenzene (FID)	99	80-133

Type: MSD Lab ID: QC371668

Analyte	Spiked	Result	%REC	Limits	RPD	Lim
Gasoline C7-C12	2,000	1,761	87	80-120	4	20

Surrogate	%REC	Limits
Trifluorotoluene (FID)	93	69-137
Bromofluorobenzene (FID)	103	80-133

Batch QC Report

Curtis & Tompkins Laboratories Analytical Report

Lab #:	192085	Location:	Sausage Factory
Client:	Clayton Group Services	Prep:	EPA 5030B
Project#:	STANDARD	Analysis:	EPA 8021B
Matrix:	Water	Batch#:	121230
Units:	ug/L	Analyzed:	01/15/07
Diln Fac:	1.000		

Type: BS Lab ID: QC371737

Analyte	Spiked	Result	%REC	Limits
Benzene	20.00	19.41	97	80-120
Toluene	20.00	18.10	90	80-120
Ethylbenzene	20.00	18.05	90	80-120
m,p-Xylenes	20.00	17.96	90	80-120
o-Xylene	20.00	19.84	99	80-120

Surrogate	%REC	Limits
Trifluorotoluene (PID)	78	64-132
Bromofluorobenzene (PID)	82	80-120

Type: BSD Lab ID: QC371738

Analyte	Spiked	Result	%REC	Limits	RPD	Lim
Benzene	20.00	19.44	97	80-120	0	20
Toluene	20.00	17.96	90	80-120	1	20
Ethylbenzene	20.00	17.35	87	80-120	4	20
m,p-Xylenes	20.00	17.58	88	80-120	2	20
o-Xylene	20.00	18.93	95	80-120	5	20

Surrogate	%REC	Limits
Trifluorotoluene (PID)	78	64-132
Bromofluorobenzene (PID)	81	80-120

RPD= Relative Percent Difference

Batch QC Report

Curtis & Tompkins Laboratories Analytical Report

Lab #:	192085	Location:	Sausage Factory
Client:	Clayton Group Services	Prep:	EPA 5030B
Project#:	STANDARD	Analysis:	EPA 8015B
Type:	LCS	Diln Fac:	1.000
Lab ID:	QC371739	Batch#:	121230
Matrix:	Water	Analyzed:	01/15/07
Units:	ug/L		

Analyte	Spiked	Result	%REC	Limits
Gasoline C7-C12	2,000	1,888	94	80-120

Surrogate	%REC	Limits
Trifluorotoluene (FID)	111	69-137
Bromofluorobenzene (FID)	113	80-133

Batch QC Report

Curtis & Tompkins Laboratories Analytical Report

Lab #:	192085	Location:	Sausage Factory
Client:	Clayton Group Services	Prep:	EPA 5030B
Project#:	STANDARD	Analysis:	EPA 8015B
Field ID:	ZZZZZZZZZZ	Batch#:	121230
MSS Lab ID:	192095-003	Sampled:	01/10/07
Matrix:	Water	Received:	01/12/07
Units:	ug/L	Analyzed:	01/15/07
Diln Fac:	1.000		

Type: MS Lab ID: QC371740

Analyte	MSS Result	Spiked	Result	%REC	Limits
Gasoline C7-C12	109.6	2,000	1,993	94	80-120

Surrogate	%REC	Limits
Trifluorotoluene (FID)	103	69-137
Bromofluorobenzene (FID)	107	80-133

Type: MSD Lab ID: QC371741

Analyte	Spiked	Result	%REC	Limits	RPD	Lim
Gasoline C7-C12	2,000	1,990	94	80-120	0	20

Surrogate	%REC	Limits
Trifluorotoluene (FID)	100	69-137
Bromofluorobenzene (FID)	105	80-133

RPD= Relative Percent Difference

Purgeable Halocarbons by GC/MS

Lab #:	192085	Location:	Sausage Factory
Client:	Clayton Group Services	Prep:	EPA 5030B
Project#:	STANDARD	Analysis:	EPA 8260B
Field ID:	MW-01	Batch#:	121244
Lab ID:	192085-001	Sampled:	01/11/07
Matrix:	Water	Received:	01/12/07
Units:	ug/L	Analyzed:	01/16/07
Diln Fac:	4.000		

Analyte	Result	RL
Chloromethane	ND	4.0
Vinyl Chloride	ND	2.0
Bromomethane	ND	4.0
Chloroethane	ND	4.0
Trichlorofluoromethane	ND	4.0
Freon 113	ND	2.0
1,1-Dichloroethene	ND	2.0
Methylene Chloride	ND	80
trans-1,2-Dichloroethene	ND	2.0
1,1-Dichloroethane	ND	2.0
cis-1,2-Dichloroethene	ND	2.0
Chloroform	ND	4.0
1,1,1-Trichloroethane	ND	2.0
Carbon Tetrachloride	ND	2.0
1,2-Dichloroethane	ND	2.0
Trichloroethene	ND	2.0
1,2-Dichloropropane	ND	2.0
Bromodichloromethane	ND	2.0
cis-1,3-Dichloropropene	ND	2.0
trans-1,3-Dichloropropene	ND	2.0
1,1,2-Trichloroethane	ND	2.0
Tetrachloroethene	ND	2.0
Dibromochloromethane	ND	2.0
Chlorobenzene	ND	2.0
Bromoform	ND	2.0
1,1,2,2-Tetrachloroethane	ND	2.0
1,3-Dichlorobenzene	ND	2.0
1,4-Dichlorobenzene	ND	2.0
1,2-Dichlorobenzene	ND	2.0

Surrogate	%REC	Limits
1,2-Dichloroethane-d4	108	80-130
Toluene-d8	103	80-120
Bromofluorobenzene	102	80-122

ND= Not Detected

RL= Reporting Limit

Purgeable Halocarbons by GC/MS

Lab #:	192085	Location:	Sausage Factory
Client:	Clayton Group Services	Prep:	EPA 5030B
Project#:	STANDARD	Analysis:	EPA 8260B
Field ID:	MW-02	Batch#:	121244
Lab ID:	192085-002	Sampled:	01/11/07
Matrix:	Water	Received:	01/12/07
Units:	ug/L	Analyzed:	01/16/07
Diln Fac:	25.00		

Analyte	Result	RL
Chloromethane	ND	25
Vinyl Chloride	ND	13
Bromomethane	ND	25
Chloroethane	ND	25
Trichlorofluoromethane	ND	25
Freon 113	ND	13
1,1-Dichloroethene	ND	13
Methylene Chloride	ND	500
trans-1,2-Dichloroethene	ND	13
1,1-Dichloroethane	ND	13
cis-1,2-Dichloroethene	ND	13
Chloroform	ND	25
1,1,1-Trichloroethane	ND	13
Carbon Tetrachloride	ND	13
1,2-Dichloroethane	ND	13
Trichloroethene	ND	13
1,2-Dichloropropane	ND	13
Bromodichloromethane	ND	13
cis-1,3-Dichloropropene	ND	13
trans-1,3-Dichloropropene	ND	13
1,1,2-Trichloroethane	ND	13
Tetrachloroethene	ND	13
Dibromochloromethane	ND	13
Chlorobenzene	ND	13
Bromoform	ND	13
1,1,2,2-Tetrachloroethane	ND	13
1,3-Dichlorobenzene	ND	13
1,4-Dichlorobenzene	ND	13
1,2-Dichlorobenzene	ND	13

Surrogate	%REC	Limits
1,2-Dichloroethane-d4	104	80-130
Toluene-d8	101	80-120
Bromofluorobenzene	105	80-122

ND= Not Detected
 RL= Reporting Limit

Purgeable Halocarbons by GC/MS

Lab #:	192085	Location:	Sausage Factory
Client:	Clayton Group Services	Prep:	EPA 5030B
Project#:	STANDARD	Analysis:	EPA 8260B
Field ID:	MW-06	Batch#:	121244
Lab ID:	192085-003	Sampled:	01/11/07
Matrix:	Water	Received:	01/12/07
Units:	ug/L	Analyzed:	01/15/07
Diln Fac:	1.000		

Analyte	Result	RL
Chloromethane	ND	1.0
Vinyl Chloride	ND	0.5
Bromomethane	ND	1.0
Chloroethane	ND	1.0
Trichlorofluoromethane	ND	1.0
Freon 113	ND	0.5
1,1-Dichloroethene	ND	0.5
Methylene Chloride	ND	20
trans-1,2-Dichloroethene	ND	0.5
1,1-Dichloroethane	ND	0.5
cis-1,2-Dichloroethene	ND	0.5
Chloroform	ND	1.0
1,1,1-Trichloroethane	ND	0.5
Carbon Tetrachloride	ND	0.5
1,2-Dichloroethane	ND	0.5
Trichloroethene	ND	0.5
1,2-Dichloropropane	ND	0.5
Bromodichloromethane	ND	0.5
cis-1,3-Dichloropropene	ND	0.5
trans-1,3-Dichloropropene	ND	0.5
1,1,2-Trichloroethane	ND	0.5
Tetrachloroethene	ND	0.5
Dibromochloromethane	ND	0.5
Chlorobenzene	ND	0.5
Bromoform	ND	0.5
1,1,2,2-Tetrachloroethane	ND	0.5
1,3-Dichlorobenzene	ND	0.5
1,4-Dichlorobenzene	ND	0.5
1,2-Dichlorobenzene	ND	0.5

Surrogate	%REC	Limits
1,2-Dichloroethane-d4	103	80-130
Toluene-d8	101	80-120
Bromofluorobenzene	107	80-122

ND= Not Detected

RL= Reporting Limit

Purgeable Halocarbons by GC/MS

Lab #:	192085	Location:	Sausage Factory
Client:	Clayton Group Services	Prep:	EPA 5030B
Project#:	STANDARD	Analysis:	EPA 8260B
Field ID:	MW-07	Batch#:	121244
Lab ID:	192085-004	Sampled:	01/11/07
Matrix:	Water	Received:	01/12/07
Units:	ug/L	Analyzed:	01/15/07
Diln Fac:	1.000		

Analyte	Result	RL
Chloromethane	ND	1.0
Vinyl Chloride	ND	0.5
Bromomethane	ND	1.0
Chloroethane	ND	1.0
Trichlorofluoromethane	ND	1.0
Freon 113	ND	0.5
1,1-Dichloroethene	ND	0.5
Methylene Chloride	ND	20
trans-1,2-Dichloroethene	ND	0.5
1,1-Dichloroethane	ND	0.5
cis-1,2-Dichloroethene	ND	0.5
Chloroform	ND	1.0
1,1,1-Trichloroethane	ND	0.5
Carbon Tetrachloride	ND	0.5
1,2-Dichloroethane	ND	0.5
Trichloroethene	ND	0.5
1,2-Dichloropropane	ND	0.5
Bromodichloromethane	ND	0.5
cis-1,3-Dichloropropene	ND	0.5
trans-1,3-Dichloropropene	ND	0.5
1,1,2-Trichloroethane	ND	0.5
Tetrachloroethene	ND	0.5
Dibromochloromethane	ND	0.5
Chlorobenzene	ND	0.5
Bromoform	ND	0.5
1,1,2,2-Tetrachloroethane	ND	0.5
1,3-Dichlorobenzene	ND	0.5
1,4-Dichlorobenzene	ND	0.5
1,2-Dichlorobenzene	ND	0.5

Surrogate	%REC	Limits
1,2-Dichloroethane-d4	104	80-130
Toluene-d8	100	80-120
Bromofluorobenzene	107	80-122

ND= Not Detected

RL= Reporting Limit

Purgeable Halocarbons by GC/MS

Lab #:	192085	Location:	Sausage Factory
Client:	Clayton Group Services	Prep:	EPA 5030B
Project#:	STANDARD	Analysis:	EPA 8260B
Field ID:	MW-08	Batch#:	121203
Lab ID:	192085-005	Sampled:	01/11/07
Matrix:	Water	Received:	01/12/07
Units:	ug/L	Analyzed:	01/13/07
Diln Fac:	12.50		

Analyte	Result	RL
Chloromethane	ND	13
Vinyl Chloride	58	6.3
Bromomethane	ND	13
Chloroethane	ND	13
Trichlorofluoromethane	ND	13
Freon 113	ND	6.3
1,1-Dichloroethene	ND	6.3
Methylene Chloride	ND	250
trans-1,2-Dichloroethene	32	6.3
1,1-Dichloroethane	ND	6.3
cis-1,2-Dichloroethene	820	6.3
Chloroform	ND	13
1,1,1-Trichloroethane	ND	6.3
Carbon Tetrachloride	ND	6.3
1,2-Dichloroethane	ND	6.3
Trichloroethene	ND	6.3
1,2-Dichloropropane	ND	6.3
Bromodichloromethane	ND	6.3
cis-1,3-Dichloropropene	ND	6.3
trans-1,3-Dichloropropene	ND	6.3
1,1,2-Trichloroethane	ND	6.3
Tetrachloroethene	ND	6.3
Dibromochloromethane	ND	6.3
Chlorobenzene	ND	6.3
Bromoform	ND	6.3
1,1,2,2-Tetrachloroethane	ND	6.3
1,3-Dichlorobenzene	ND	6.3
1,4-Dichlorobenzene	ND	6.3
1,2-Dichlorobenzene	ND	6.3

Surrogate	%REC	Limits
1,2-Dichloroethane-d4	93	80-130
Toluene-d8	95	80-120
Bromofluorobenzene	95	80-122

ND= Not Detected
 RL= Reporting Limit

Purgeable Halocarbons by GC/MS

Lab #:	192085	Location:	Sausage Factory
Client:	Clayton Group Services	Prep:	EPA 5030B
Project#:	STANDARD	Analysis:	EPA 8260B
Field ID:	MW-09	Batch#:	121244
Lab ID:	192085-006	Sampled:	01/11/07
Matrix:	Water	Received:	01/12/07
Units:	ug/L	Analyzed:	01/16/07
Diln Fac:	33.33		

Analyte	Result	RL
Chloromethane	ND	33
Vinyl Chloride	ND	17
Bromomethane	ND	33
Chloroethane	ND	33
Trichlorofluoromethane	ND	33
Freon 113	ND	17
1,1-Dichloroethene	ND	17
Methylene Chloride	ND	670
trans-1,2-Dichloroethene	ND	17
1,1-Dichloroethane	ND	17
cis-1,2-Dichloroethene	ND	17
Chloroform	ND	33
1,1,1-Trichloroethane	ND	17
Carbon Tetrachloride	ND	17
1,2-Dichloroethane	ND	17
Trichloroethene	ND	17
1,2-Dichloropropane	ND	17
Bromodichloromethane	ND	17
cis-1,3-Dichloropropene	ND	17
trans-1,3-Dichloropropene	ND	17
1,1,2-Trichloroethane	ND	17
Tetrachloroethene	ND	17
Dibromochloromethane	ND	17
Chlorobenzene	ND	17
Bromoform	ND	17
1,1,2,2-Tetrachloroethane	ND	17
1,3-Dichlorobenzene	ND	17
1,4-Dichlorobenzene	ND	17
1,2-Dichlorobenzene	ND	17

Surrogate	%REC	Limits
1,2-Dichloroethane-d4	106	80-130
Toluene-d8	101	80-120
Bromofluorobenzene	104	80-122

ND= Not Detected

RL= Reporting Limit

Purgeable Halocarbons by GC/MS

Lab #:	192085	Location:	Sausage Factory
Client:	Clayton Group Services	Prep:	EPA 5030B
Project#:	STANDARD	Analysis:	EPA 8260B
Field ID:	MW-10	Batch#:	121244
Lab ID:	192085-007	Sampled:	01/11/07
Matrix:	Water	Received:	01/12/07
Units:	ug/L	Analyzed:	01/15/07
Diln Fac:	1.000		

Analyte	Result	RL
Chloromethane	ND	1.0
Vinyl Chloride	ND	0.5
Bromomethane	ND	1.0
Chloroethane	ND	1.0
Trichlorofluoromethane	ND	1.0
Freon 113	ND	0.5
1,1-Dichloroethene	ND	0.5
Methylene Chloride	ND	20
trans-1,2-Dichloroethene	ND	0.5
1,1-Dichloroethane	ND	0.5
cis-1,2-Dichloroethene	ND	0.5
Chloroform	ND	1.0
1,1,1-Trichloroethane	ND	0.5
Carbon Tetrachloride	ND	0.5
1,2-Dichloroethane	ND	0.5
Trichloroethene	ND	0.5
1,2-Dichloropropane	ND	0.5
Bromodichloromethane	ND	0.5
cis-1,3-Dichloropropene	ND	0.5
trans-1,3-Dichloropropene	ND	0.5
1,1,2-Trichloroethane	ND	0.5
Tetrachloroethene	ND	0.5
Dibromochloromethane	ND	0.5
Chlorobenzene	ND	0.5
Bromoform	ND	0.5
1,1,2,2-Tetrachloroethane	ND	0.5
1,3-Dichlorobenzene	ND	0.5
1,4-Dichlorobenzene	ND	0.5
1,2-Dichlorobenzene	ND	0.5

Surrogate	%REC	Limits
1,2-Dichloroethane-d4	105	80-130
Toluene-d8	100	80-120
Bromofluorobenzene	107	80-122

ND= Not Detected

RL= Reporting Limit

Purgeable Halocarbons by GC/MS

Lab #:	192085	Location:	Sausage Factory
Client:	Clayton Group Services	Prep:	EPA 5030B
Project#:	STANDARD	Analysis:	EPA 8260B
Field ID:	MW-11	Batch#:	121244
Lab ID:	192085-008	Sampled:	01/11/07
Matrix:	Water	Received:	01/12/07
Units:	ug/L	Analyzed:	01/15/07
Diln Fac:	1.000		

Analyte	Result	RL
Chloromethane	ND	1.0
Vinyl Chloride	ND	0.5
Bromomethane	ND	1.0
Chloroethane	ND	1.0
Trichlorofluoromethane	ND	1.0
Freon 113	ND	0.5
1,1-Dichloroethene	ND	0.5
Methylene Chloride	ND	20
trans-1,2-Dichloroethene	ND	0.5
1,1-Dichloroethane	ND	0.5
cis-1,2-Dichloroethene	ND	0.5
Chloroform	ND	1.0
1,1,1-Trichloroethane	ND	0.5
Carbon Tetrachloride	ND	0.5
1,2-Dichloroethane	ND	0.5
Trichloroethene	ND	0.5
1,2-Dichloropropane	ND	0.5
Bromodichloromethane	ND	0.5
cis-1,3-Dichloropropene	ND	0.5
trans-1,3-Dichloropropene	ND	0.5
1,1,2-Trichloroethane	ND	0.5
Tetrachloroethene	ND	0.5
Dibromochloromethane	ND	0.5
Chlorobenzene	ND	0.5
Bromoform	ND	0.5
1,1,2,2-Tetrachloroethane	ND	0.5
1,3-Dichlorobenzene	ND	0.5
1,4-Dichlorobenzene	ND	0.5
1,2-Dichlorobenzene	ND	0.5

Surrogate	%REC	Limits
1,2-Dichloroethane-d4	105	80-130
Toluene-d8	102	80-120
Bromofluorobenzene	109	80-122

ND= Not Detected
 RL= Reporting Limit

Purgeable Halocarbons by GC/MS

Lab #:	192085	Location:	Sausage Factory
Client:	Clayton Group Services	Prep:	EPA 5030B
Project#:	STANDARD	Analysis:	EPA 8260B
Field ID:	MW-12	Batch#:	121203
Lab ID:	192085-009	Sampled:	01/11/07
Matrix:	Water	Received:	01/12/07
Units:	ug/L	Analyzed:	01/13/07
Diln Fac:	2.000		

Analyte	Result	RL
Chloromethane	ND	2.0
Vinyl Chloride	ND	1.0
Bromomethane	ND	2.0
Chloroethane	ND	2.0
Trichlorofluoromethane	ND	2.0
Freon 113	ND	1.0
1,1-Dichloroethene	ND	1.0
Methylene Chloride	ND	40
trans-1,2-Dichloroethene	53	1.0
1,1-Dichloroethane	ND	1.0
cis-1,2-Dichloroethene	47	1.0
Chloroform	ND	2.0
1,1,1-Trichloroethane	ND	1.0
Carbon Tetrachloride	ND	1.0
1,2-Dichloroethane	ND	1.0
Trichloroethene	140	1.0
1,2-Dichloropropane	ND	1.0
Bromodichloromethane	ND	1.0
cis-1,3-Dichloropropene	ND	1.0
trans-1,3-Dichloropropene	ND	1.0
1,1,2-Trichloroethane	ND	1.0
Tetrachloroethene	ND	1.0
Dibromochloromethane	ND	1.0
Chlorobenzene	ND	1.0
Bromoform	ND	1.0
1,1,2,2-Tetrachloroethane	ND	1.0
1,3-Dichlorobenzene	ND	1.0
1,4-Dichlorobenzene	ND	1.0
1,2-Dichlorobenzene	ND	1.0

Surrogate	%REC	Limits
1,2-Dichloroethane-d4	94	80-130
Toluene-d8	96	80-120
Bromofluorobenzene	96	80-122

ND= Not Detected

RL= Reporting Limit

Purgeable Halocarbons by GC/MS

Lab #:	192085	Location:	Sausage Factory
Client:	Clayton Group Services	Prep:	EPA 5030B
Project#:	STANDARD	Analysis:	EPA 8260B
Field ID:	MW-13	Batch#:	121203
Lab ID:	192085-010	Sampled:	01/11/07
Matrix:	Water	Received:	01/12/07
Units:	ug/L	Analyzed:	01/13/07
Diln Fac:	1.667		

Analyte	Result	RL
Chloromethane	ND	1.7
Vinyl Chloride	11	0.8
Bromomethane	ND	1.7
Chloroethane	ND	1.7
Trichlorofluoromethane	ND	1.7
Freon 113	ND	0.8
1,1-Dichloroethene	ND	0.8
Methylene Chloride	ND	33
trans-1,2-Dichloroethene	45	0.8
1,1-Dichloroethane	ND	0.8
cis-1,2-Dichloroethene	87	0.8
Chloroform	ND	1.7
1,1,1-Trichloroethane	ND	0.8
Carbon Tetrachloride	ND	0.8
1,2-Dichloroethane	ND	0.8
Trichloroethene	24	0.8
1,2-Dichloropropane	ND	0.8
Bromodichloromethane	ND	0.8
cis-1,3-Dichloropropene	ND	0.8
trans-1,3-Dichloropropene	ND	0.8
1,1,2-Trichloroethane	ND	0.8
Tetrachloroethene	ND	0.8
Dibromochloromethane	ND	0.8
Chlorobenzene	ND	0.8
Bromoform	ND	0.8
1,1,2,2-Tetrachloroethane	ND	0.8
1,3-Dichlorobenzene	ND	0.8
1,4-Dichlorobenzene	ND	0.8
1,2-Dichlorobenzene	ND	0.8

Surrogate	%REC	Limits
1,2-Dichloroethane-d4	112	80-130
Toluene-d8	100	80-120
Bromofluorobenzene	102	80-122

ND= Not Detected

RL= Reporting Limit

Batch QC Report

Purgeable Halocarbons by GC/MS			
Lab #:	192085	Location:	Sausage Factory
Client:	Clayton Group Services	Prep:	EPA 5030B
Project#:	STANDARD	Analysis:	EPA 8260B
Type:	BLANK	Diln Fac:	1.000
Lab ID:	QC371635	Batch#:	121203
Matrix:	Water	Analyzed:	01/12/07
Units:	ug/L		

Analyte	Result	RL
Chloromethane	ND	1.0
Vinyl Chloride	ND	0.5
Bromomethane	ND	1.0
Chloroethane	ND	1.0
Trichlorofluoromethane	ND	1.0
Freon 113	ND	0.5
1,1-Dichloroethene	ND	0.5
Methylene Chloride	ND	20
trans-1,2-Dichloroethene	ND	0.5
1,1-Dichloroethane	ND	0.5
cis-1,2-Dichloroethene	ND	0.5
Chloroform	ND	1.0
1,1,1-Trichloroethane	ND	0.5
Carbon Tetrachloride	ND	0.5
1,2-Dichloroethane	ND	0.5
Trichloroethene	ND	0.5
1,2-Dichloropropane	ND	0.5
Bromodichloromethane	ND	0.5
cis-1,3-Dichloropropene	ND	0.5
trans-1,3-Dichloropropene	ND	0.5
1,1,2-Trichloroethane	ND	0.5
Tetrachloroethene	ND	0.5
Dibromochloromethane	ND	0.5
Chlorobenzene	ND	0.5
Bromoform	ND	0.5
1,1,2,2-Tetrachloroethane	ND	0.5
1,3-Dichlorobenzene	ND	0.5
1,4-Dichlorobenzene	ND	0.5
1,2-Dichlorobenzene	ND	0.5

Surrogate	%REC	Limits
1,2-Dichloroethane-d4	102	80-130
Toluene-d8	99	80-120
Bromofluorobenzene	97	80-122

ND= Not Detected

RL= Reporting Limit

Batch QC Report

Purgeable Halocarbons by GC/MS			
Lab #:	192085	Location:	Sausage Factory
Client:	Clayton Group Services	Prep:	EPA 5030B
Project#:	STANDARD	Analysis:	EPA 8260B
Matrix:	Water	Batch#:	121203
Units:	ug/L	Analyzed:	01/12/07
Diln Fac:	1.000		

Type: BS Lab ID: QC371636

Analyte	Spiked	Result	%REC	Limits
1,1-Dichloroethene	25.00	28.30	113	77-128
Trichloroethene	25.00	25.90	104	80-120
Chlorobenzene	25.00	25.72	103	80-120

Surrogate	%REC	Limits
1,2-Dichloroethane-d4	99	80-130
Toluene-d8	100	80-120
Bromofluorobenzene	98	80-122

Type: BSD Lab ID: QC371637

Analyte	Spiked	Result	%REC	Limits	RPD	Lim
1,1-Dichloroethene	25.00	27.01	108	77-128	5	20
Trichloroethene	25.00	25.78	103	80-120	0	20
Chlorobenzene	25.00	25.08	100	80-120	2	20

Surrogate	%REC	Limits
1,2-Dichloroethane-d4	99	80-130
Toluene-d8	100	80-120
Bromofluorobenzene	94	80-122

RPD= Relative Percent Difference

Batch QC Report

Purgeable Halocarbons by GC/MS			
Lab #:	192085	Location:	Sausage Factory
Client:	Clayton Group Services	Prep:	EPA 5030B
Project#:	STANDARD	Analysis:	EPA 8260B
Matrix:	Water	Batch#:	121244
Units:	ug/L	Analyzed:	01/15/07
Diln Fac:	1.000		

Type: BS Lab ID: QC371793

Analyte	Spiked	Result	%REC	Limits
1,1-Dichloroethene	25.00	28.49	114	77-128
Trichloroethene	25.00	26.31	105	80-120
Chlorobenzene	25.00	25.11	100	80-120

Surrogate	%REC	Limits
1,2-Dichloroethane-d4	101	80-130
Toluene-d8	100	80-120
Bromofluorobenzene	99	80-122

Type: BSD Lab ID: QC371794

Analyte	Spiked	Result	%REC	Limits	RPD	Lim
1,1-Dichloroethene	25.00	26.58	106	77-128	7	20
Trichloroethene	25.00	24.71	99	80-120	6	20
Chlorobenzene	25.00	24.97	100	80-120	1	20

Surrogate	%REC	Limits
1,2-Dichloroethane-d4	98	80-130
Toluene-d8	102	80-120
Bromofluorobenzene	100	80-122

RPD= Relative Percent Difference

Batch QC Report

Purgeable Halocarbons by GC/MS			
Lab #:	192085	Location:	Sausage Factory
Client:	Clayton Group Services	Prep:	EPA 5030B
Project#:	STANDARD	Analysis:	EPA 8260B
Type:	BLANK	Diln Fac:	1.000
Lab ID:	QC371795	Batch#:	121244
Matrix:	Water	Analyzed:	01/15/07
Units:	ug/L		

Analyte	Result	RL
Chloromethane	ND	1.0
Vinyl Chloride	ND	0.5
Bromomethane	ND	1.0
Chloroethane	ND	1.0
Trichlorofluoromethane	ND	1.0
Freon 113	ND	0.5
1,1-Dichloroethene	ND	0.5
Methylene Chloride	ND	20
trans-1,2-Dichloroethene	ND	0.5
1,1-Dichloroethane	ND	0.5
cis-1,2-Dichloroethene	ND	0.5
Chloroform	ND	1.0
1,1,1-Trichloroethane	ND	0.5
Carbon Tetrachloride	ND	0.5
1,2-Dichloroethane	ND	0.5
Trichloroethene	ND	0.5
1,2-Dichloropropane	ND	0.5
Bromodichloromethane	ND	0.5
cis-1,3-Dichloropropene	ND	0.5
trans-1,3-Dichloropropene	ND	0.5
1,1,2-Trichloroethane	ND	0.5
Tetrachloroethene	ND	0.5
Dibromochloromethane	ND	0.5
Chlorobenzene	ND	0.5
Bromoform	ND	0.5
1,1,2,2-Tetrachloroethane	ND	0.5
1,3-Dichlorobenzene	ND	0.5
1,4-Dichlorobenzene	ND	0.5
1,2-Dichlorobenzene	ND	0.5

Surrogate	%REC	Limits
1,2-Dichloroethane-d4	102	80-130
Toluene-d8	100	80-120
Bromofluorobenzene	104	80-122

ND= Not Detected

RL= Reporting Limit



CHAIN OF CUSTODY

Lab: Curtis&Tompkins

192085

TAT: Standard

Report results to:

Name Jeremy Wilson
 Company Clayton Group Services
 Mailing Address 6920 Koll Center Parkway, Ste. 216
 City, State, Zip Pleasanton, California 94566
 Telephone No. (925) 426-2600
 Fax No. (925) 426-0106
 E-mail: jeremy.wilson@us.bureauveritas.com

Project Information

Project No. 33104-04578.00
 Name Sausage Factory
 Location 630 29th Avenue, Oakland
 Global_Id T0600102114
 Log_code CGSP

Analyses Requested

Special instructions and/or specific regulatory requirements:

Sample Identification	Sample Date	Sample Time	Matrix/Media	No. of Concs.	8021B for TPH-g/BTEX	8260B for HVOCs	Sample Condition/Comments	Preservative
-1 MW-01	1/11/07	1300	Water	6	X	X		HCl
-2 MW-02		1230		6				HCl
-3 MW-06		1440		6				HCl
-4 MW-07		1015		6				HCl
-5 MW-08		1110		6				HCl
-6 MW-09		1155		6				HCl
-7 MW-10		1335		6				HCl
-8 MW-11		1715		6				HCl
-9 MW-12		1630		6				HCl
-10 MW-13		1535		6				HCl

Collected by: AE Date/Time _____

Collector's Signature: _____ Date/Time 1/11/07

Relinquished by: _____ Date/Time _____

Received by: [Signature] Date/Time 1/12/07 - 1235

Relinquished by: _____ Date/Time _____

Received by: _____ Date/Time _____

Method of Shipment: _____

Sample Condition on Rcpt: _____