

RECEIVED

2:20 pm, May 16, 2007

Alameda County
Environmental Health

April 14, 2006

Mr. Amir Gholami
Hazardous Materials Specialist
ALAMEDA COUNTY ENVIROMENTAL HEALTH
1131 Harbor Bay Parkway, Suite 250
Alameda, California 94502-6577

Clayton Project No.70-04578.00

**Subject: First Quarter 2006 Groundwater Monitoring Report
Former Lemoine Sausage Factory
630 29th Avenue
Oakland, California**

Dear Mr. Gholami:

Clayton Group Services is pleased to present the results of the First Quarter 2006 groundwater monitoring event performed at 630 29th Avenue in Oakland, California.

If you have any comments or questions regarding the report, please do not hesitate to contact me at (925) 426-2626.

Sincerely,



Timothy G. Bodkin, C.E.G., R.E.A.
Senior Project Manager
Environmental Services

TGB/jvw

cc: Bob Pender, AIG Technical Services
Donna Profitt, Bank of America
Richard Tong, Bureau Veritas

**First Quarter 2006
Groundwater Monitoring Report
Former Lemoine Sausage Factory
630 29th Avenue
Oakland, California**

**Clayton Project No. 70-04578.00
April 14, 2006**

Prepared for:
Robert Pender
Environmental Claims
AIG Technical Services, Inc.
80 Pine Street, 6th Floor
New York, New York 10005

Prepared by:
CLAYTON GROUP SERVICES, INC.
A Bureau Veritas Company
6920 Koll Center Parkway
Suite 216
Pleasanton, California
925.426.2600

CONTENTS

<u>Section</u>	<u>Page</u>
1.0 INTRODUCTION	1
2.0 SITE DESCRIPTION AND HISTORY	1
3.0 FIELD ACTIVITIES	2
3.1. GROUNDWATER LEVEL MEASUREMENTS	2
3.2. GROUNDWATER PURGING.....	2
3.4 LABORATORY ANALYSES.....	3
4.0 FINDINGS	3
4.1. GROUNDWATER FLOW CONDITIONS	3
4.2. ANALYTICAL RESULTS	3
5.0 CONCLUSIONS	5

Tables

1. Summary of Groundwater Elevation Data
2. Summary of Groundwater Analytical Results

Figures

1. Property Location Map
2. Groundwater Elevation Contour Map – 1st Quarter 2006
3. TPH-g Concentrations in Groundwater – 1st Quarter 2006
4. Benzene Concentrations in Groundwater – 1st Quarter 2006
5. TCE and cis-1,2- DCE Concentrations in Groundwater – 1st Quarter 2006

Appendices

- A. First Quarter 2006- Field Sampling Data Sheets
- B. First Quarter 2006- Certified Analytical Data Sheets and Chain-of-Custody Documentation

1.0 INTRODUCTION

Clayton Group Services, Inc., a Bureau Veritas Company (Clayton), has prepared the following First Quarter 2006 Groundwater Monitoring Report for the former Lemoine Sausage Factory. The site is located at 630 29th Avenue near the intersection with 7th Street in Oakland, California (Figure 1). Groundwater monitoring is performed at this site in accordance with an Alameda County Environmental Health (ACEH) letter dated June 19, 1999. Groundwater monitoring is required due to past releases from a gasoline underground storage tank (UST) previously located beneath the sidewalk adjacent to the site.

The purpose of the groundwater monitoring is to document groundwater flow conditions and water quality beneath the site. Depth to groundwater measurements were obtained and groundwater samples were collected and analyzed for total petroleum hydrocarbons as gasoline (TPH-g) and associated compounds, including benzene, toluene, ethylbenzene and total xylenes (BTEX), and volatile organic compounds (VOCs).

As required by ACEH, groundwater monitoring is being performed on a quarterly basis. This First Quarter 2006 Groundwater Monitoring Report documents field activities and presents data used to evaluate groundwater flow conditions and quality at the site.

2.0 SITE DESCRIPTION AND HISTORY

A single 1,000-gallon gasoline UST and associated plumbing/piping were formerly located beneath the sidewalk along 7th Street immediately east of the subject building. The associated fuel dispenser was located in a “cubby hole” near the building’s roll-up door. The UST and associated piping were removed on November 21, 1996 and confirmation soil samples were collected. A petroleum hydrocarbon sheen was noted on groundwater that collected in the tank excavation. Petroleum hydrocarbons were detected in the confirmation soil samples collected at the time of the UST removal.

Subsequent groundwater investigations were performed to define the vertical and lateral extent of petroleum hydrocarbons in groundwater and monitor groundwater conditions around the site. Ten (10) groundwater monitoring wells were installed and screened within the first-encountered water bearing zone, which predominantly occurs within low permeability clayey and sandy silts. In general, the highest concentrations of TPH-g and benzene have been detected in the immediate vicinity or just down gradient of the former UST, and the plume is well defined. VOCs have also been detected in monitoring wells located to the south and southwest of the former UST location and are believed to be originating off-site.

3.0 FIELD ACTIVITIES

Groundwater level measurements and samples were collected from ten (10) existing monitoring wells (MW-1, MW-2, and MW-6 through MW-13).

3.1. GROUNDWATER LEVEL MEASUREMENTS

On March 2, 2006, depth to water measurements were obtained in the monitoring wells to calculate groundwater elevations and to estimate the groundwater flow direction and gradient. The wells were opened and allowed to stabilize prior to measuring the groundwater levels. The depth to water in each well was measured using an electronic well sounder. Groundwater depths were measured from a surveyed reference elevation point represented by a V-notch at the top of each casing. Groundwater elevations were calculated by subtracting the measured depth to water from the top of casing elevation at each monitoring well.

3.2. GROUNDWATER PURGING

Prior to groundwater sample collection at each monitoring well, approximately three (3) well casing volumes of standing water were removed, except that monitoring wells MW-1 and MW-2 were not purged because they did not contain sufficient water for purging purposes. Wells MW-6 through MW-13 were purged by hand bailing with 1-liter plastic disposable bailers.

The purge volume from each monitoring well was determined by multiplying the nominal cross-sectional area of the well casing by the water column within each well casing. The water column height in each well was determined by subtracting the depth to water from the total well casing depth. Water quality parameters (pH, specific conductivity, and temperature) were measured and recorded onto Field Sampling Data Sheets. Water quality parameter measurements were taken prior to purging and after removing each well casing volume of water from each monitoring well.

Groundwater purged from monitoring wells during sampling was stored onsite in sealed 55-gallon drums meeting U.S. Department of Transportation (USDOT) regulations and labeled with identifying information. Groundwater level measurements for the First Quarter 2006 monitoring event were recorded on Field Sampling Data Sheets as presented in Appendix A.

3.3 GROUNDWATER SAMPLING

Before groundwater sampling commenced, each purged monitoring well was allowed to recharge to at least 80% of the pre-purged standing water volume. Groundwater samples for laboratory analyses were retrieved using either a peristaltic pump with polytubing or a new disposable bailer. Groundwater samples were poured into appropriate laboratory-supplied containers. Sample containers were sealed, labeled with identifying project information, logged onto a

chain-of-custody document, and temporarily stored in a chilled ice chest containing crushed ice for transport to the laboratory.

3.4 LABORATORY ANALYSES

Groundwater samples were analyzed by Curtis and Tompkins Ltd. of Berkeley, California, a State of California-certified laboratory. The samples were analyzed by the following United States Environmental Protection Agency (USEPA) approved analytical methods:

- USEPA Method 8021B for TPH-g/BTEX
- USEPA Method 8260B for VOCs

Certified analytical data sheets and chain-of-custody documentation for the First Quarter 2006 groundwater sampling event are presented in Appendix B.

4.0 FINDINGS

4.1. GROUNDWATER FLOW CONDITIONS

Groundwater flow conditions were assessed based upon the groundwater level measurements obtained in the wells. Groundwater depths ranged between 3.41 and 9.45 feet below the tops of well casings. Groundwater elevations ranged between 9.06 and 13.19 feet mean sea level. The direction of groundwater flow is inferred to be to the west-southwest at an approximate gradient of 0.016 feet per foot (ft/ft). Depth to water measurements and groundwater elevation data from this event and previous events are presented in Table 1. The First Quarter 2006 groundwater elevation map is presented on Figure 2.

4.2. ANALYTICAL RESULTS

Analytical results for groundwater showed the presence of total petroleum hydrocarbons and VOCs. The frequency and range of petroleum hydrocarbons detected in groundwater samples obtained during this quarter are as follows:

- TPH-g was detected in Wells MW-1, MW-2, MW-6, MW-8, MW-9, MW-12, and MW-13 at concentrations ranging between 54 and 51,000 micrograms per liter ($\mu\text{g/L}$).
- Benzene was detected in Wells MW-1, MW-2, MW-8, MW-9, MW-10, and MW-13 at concentrations ranging between 0.74 and 12,000 $\mu\text{g/L}$.
- Toluene was detected in Wells MW-1, MW-2, and MW-9 at concentrations ranging between 200 and 3,500 $\mu\text{g/L}$.

- Ethylbenzene was detected in Wells MW-1, MW-2, MW-8, MW-9, and MW-13 at concentrations ranging between 36 and 750 µg/L.
- Total xylenes were detected in Wells MW-1, MW-2, MW-9, and MW-13 at concentrations ranging between 5.19 and 4,170 µg/L.
- Trichloroethene (TCE) was detected in Wells MW-12 and MW-13 at 84 and 43 µg/L, respectively.
- Cis-1,2-dichloroethene (cis-1,2-DCE) was detected in Wells MW-8, MW-12, and MW-13 at concentrations ranging between 27 and 890 µg/L.
- Trans-1,2-dichloroethene (trans-1,2-DCE) was detected in Wells MW-8, MW-12, and MW-13 at concentrations ranging between 31 and 34 µg/L.
- Vinyl chloride (VC) was detected in Wells MW-8 and MW-13 at 50 and 16µg/L, respectively.

A summary of petroleum hydrocarbons and VOCs detected in groundwater is presented in Table 2. Concentrations of TPH-g and benzene detected in groundwater and isoconcentration contours for TPH and benzene in groundwater for the First Quarter 2006 monitoring event are presented on Figures 3 and 4, respectively. Concentrations of TCE and cis 1,2-DCE detected in groundwater for the First Quarter 2006 monitoring event are presented in Figure 5.

5.0 CONCLUSIONS

Groundwater flow conditions and quality for the First Quarter 2006 monitoring event appear to be relatively consistent with those noted during previous monitoring events. TPH-g and BTEX concentrations detected in groundwater have decreased or remained similar to previous events. The highest concentrations of TPH-g and benzene were detected in Well MW-2, which is near the former UST location, and Well MW-9, which is located within the central portion of the subject building and downgradient of the former UST location. Wells MW-6, MW-7, and MW-10 define the northern, western, and eastern edges of the hydrocarbon plume.

Halogenated VOCs detected in groundwater during this monitoring event include TCE and associated degradation compounds (cis-1,2-DCE, trans-1,2-DCE, and VC). VOC concentrations were detected in Wells MW-8, MW-12, and MW-13, which are located downgradient from the former UST location. The source of the VOCs is unknown and appears to be off-site. The source of the VOCs does not appear to be related to the UST release. In addition, the apparent changes in concentrations of VOCs over the past several monitoring events indicate that the natural degradation of TCE is occurring.

Report prepared by: _____

Jeremy Wilson
Staff Environmental Consultant
Environmental Services

Report reviewed by: _____

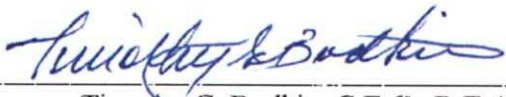
Timothy G. Bodkin, C.E.G., R.E.A.
Senior Project Manager
Environmental Services



April 14, 2006

TABLES

Table 1

**Summary of Groundwater Elevation Data
Former Lemoine Sausage Facility
630 29th Avenue
Oakland, California**

Well Identification	Date Measured	Top of Casing Elevation (ft,msl)	Depth to Water (feet)	Groundwater Elevation (ft,msl)
MW-1	2/8/1999	16.69	3.60	13.09
	6/15/2000	16.69	4.82	11.87
	9/22/2000	16.69	6.30	10.39
	12/19/2000	16.69	5.50	11.19
	3/21/2001	16.69	4.29	12.40
	6/20/2001	16.69	5.85	10.84
	9/25/2001	16.69	6.76	9.93
	12/3/2001	16.69	4.17	12.52
	3/25/2002	16.69	2.77	13.92
	6/28/2002	16.69	5.61	11.08
	9/11/2002	16.69	6.17	10.52
	12/16/2002	16.69	3.91	12.78
	3/28/2003	16.69	4.44	12.25
	6/24/2003	16.69	5.29	11.40
	9/26/2003	16.69	6.88	9.81
	12/16/2003	16.69	NM	NM
	4/6/2004	16.69	3.57	13.12
	6/23/2004	16.69	5.96	10.73
	9/15/2004	16.69	NM	NM
	12/16/2004	16.69	4.40	12.29
3/22/2005	16.69	3.44	13.25	
6/24/2005	16.69	4.45	12.24	
9/13/2005	16.69	6.03	10.66	
12/2/2005	16.69	4.95	11.74	
3/2/2006	16.69	3.74	12.95	
MW-2	2/8/1999	20.79	14.20	6.59
	6/15/2000	20.79	10.46	10.33
	9/22/2000	20.79	11.49	9.30
	12/19/2000	20.79	11.38	9.41
	3/21/2001	20.79	10.01	10.78
	6/20/2001	20.79	10.92	9.87
	9/25/2001	20.79	11.78	9.01
	12/3/2001	20.79	11.13	9.66
	3/25/2002	20.79	9.21	11.58
	6/28/2002	20.79	10.65	10.14
	9/11/2002	20.79	10.89	9.90
	12/16/2002	20.79	11.15	9.64
	3/28/2003	20.79	10.27	10.52
	6/24/2003	20.79	10.24	10.55
	9/26/2003	20.79	11.20	9.59
	12/16/2003	20.79	11.50	9.29
4/6/2004	20.79	9.40	11.39	
6/23/2004	20.79	11.60	9.19	

Table 1

**Summary of Groundwater Elevation Data
Former Lemoine Sausage Facility
630 29th Avenue
Oakland, California**

Well Identification	Date Measured	Top of Casing Elevation (ft,msl)	Depth to Water (feet)	Groundwater Elevation (ft,msl)
MW-2	9/15/2004	20.79	10.94	9.85
	12/16/2004	20.79	NM	NM
	3/22/2005	20.79	9.26	11.53
	6/24/2005	20.79	10.03	10.76
	9/13/2005	20.79	10.58	10.21
	12/2/2005	20.79	NM	NM
	3/2/2006	20.79	9.45	11.34
MW-3	2/8/1999	21.10	7.45	13.65
	6/15/2000	21.10	10.56	10.54
	9/22/2000	21.10	15.30	5.80
	12/19/2000	21.10	9.72	11.38
	3/21/2001	21.10	8.95	12.15
	6/20/2001	21.10	10.14	10.96
	9/25/2001	21.10	10.74	10.36
Removed from monitoring program in October 2001				
MW-4	2/8/1999	17.78	4.13	13.65
	6/15/2000	17.78	6.30	11.48
	9/22/2000	17.78	6.90	10.88
	12/19/2000	17.78	6.40	11.38
	3/21/2001	17.78	5.77	12.01
	6/20/2001	17.78	6.78	11.00
	9/25/2001	17.78	7.40	10.38
Removed from monitoring program in October 2001				
MW-5	2/8/1999	21.12	7.62	13.50
	6/15/2000	21.12	10.36	10.76
	9/22/2000	21.12	9.99	11.13
	12/19/2000	21.12	9.99	11.13
	3/21/2001	21.12	8.68	12.44
	6/20/2001	21.12	9.90	11.22
	9/25/2001	21.12	10.34	10.78
Removed from monitoring program in October 2001				
MW-6	6/15/2000	16.60	5.47	11.13
	9/22/2000	16.60	6.54	10.06
	12/19/2000	16.60	5.93	10.67
	3/21/2001	16.60	4.70	11.90
	6/20/2001	16.60	6.13	10.47
	9/25/2001	16.60	6.68	9.92
	12/3/2001	16.60	4.72	11.88
	3/25/2002	16.60	3.93	12.67
	6/28/2002	16.60	5.83	10.77

Table 1

**Summary of Groundwater Elevation Data
Former Lemoine Sausage Facility
630 29th Avenue
Oakland, California**

Well Identification	Date Measured	Top of Casing Elevation (ft,msl)	Depth to Water (feet)	Groundwater Elevation (ft,msl)
MW-6	9/11/2002	16.60	5.43	11.17
	12/16/2002	16.60	3.93	12.67
	3/28/2003	16.60	NM	
	6/24/2003	16.60	5.52	11.08
	9/26/2003	16.60	6.70	9.90
	12/16/2003	16.60	4.99	11.61
	4/6/2004	16.60	4.85	11.75
	6/23/2004	16.60	5.76	10.84
	9/15/2004	16.60	6.56	10.04
	12/16/2004	16.60	4.56	12.04
	3/22/2005	16.60	3.63	12.97
	6/24/2005	16.60	4.84	11.76
	9/13/2005	16.60	6.15	10.45
	12/2/2005	16.60	5.24	11.36
	3/2/2006	16.60	3.41	13.19
MW-7	12/16/2002	15.47	5.01	10.46
	12/17/2002	15.47	6.95	8.52
	12/18/2002	15.47	6.94	8.53
	12/19/2002	15.47	6.04	9.43
	12/20/2002	15.47	6.48	8.99
	12/21/2002	15.47	7.25	8.22
	12/22/2002	15.47	6.90	8.57
	12/23/2002	15.47	5.53	9.94
	12/24/2002	15.47	7.20	8.27
	12/25/2002	15.47	7.51	7.96
	12/26/2002	15.47	6.40	9.07
	3/28/2003	15.47	5.68	9.79
	6/24/2003	15.47	6.13	9.34
	9/26/2003	15.47	7.22	8.25
	12/16/2003	15.47	5.68	9.79
	4/6/2004	15.47	5.60	9.87
	6/23/2004	15.47	6.20	9.27
	9/15/2004	15.47	6.70	8.77
	12/16/2004	15.47	5.15	10.32
	3/22/2005	15.47	NM	NM
6/24/2005	15.47	NM	NM	
9/13/2005	15.47	6.45	9.02	
12/2/2005	15.47	5.93	9.54	
3/2/2006	15.47	4.65	10.82	

Table 1

**Summary of Groundwater Elevation Data
Former Lemoine Sausage Facility
630 29th Avenue
Oakland, California**

Well Identification	Date Measured	Top of Casing Elevation (ft,msl)	Depth to Water (feet)	Groundwater Elevation (ft,msl)
MW-8	6/15/2000	17.58	7.14	10.44
	9/22/2000	17.58	8.33	9.25
	12/19/2000	17.58	7.71	9.87
	3/21/2001	17.58	6.40	11.18
	6/20/2001	17.58	7.96	9.62
	9/25/2001	17.58	8.89	8.69
	12/3/2001	17.58	6.58	11.00
	3/25/2002	17.58	5.40	12.18
	6/28/2002	17.58	7.71	9.87
	9/11/2002	17.58	8.40	9.18
	12/16/2002	17.58	5.63	11.95
	3/28/2003	17.58	6.62	10.96
	6/24/2003	17.58	7.44	10.14
	9/26/2003	17.58	8.71	8.87
	12/16/2003	17.58	6.69	10.89
	4/6/2004	17.58	6.74	10.84
	6/23/2004	17.58	7.98	9.60
	9/15/2004	17.58	8.52	9.06
	12/16/2004	17.58	5.61	11.97
	3/22/2005	17.58	5.54	12.04
6/24/2005	17.58	6.77	10.81	
9/13/2005	17.58	7.92	9.66	
12/2/2005	17.58	7.36	10.22	
3/2/2006	17.58	5.83	11.75	
MW-9	12/3/2001	17.61	5.79	11.82
	3/25/2002	17.61	4.98	12.63
	6/28/2002	17.61	7.71	9.90
	9/11/2002	17.61	6.91	10.70
	12/16/2002	17.61	6.58	11.03
	3/28/2003	17.61	6.08	11.53
	6/24/2003	17.61	6.42	11.19
	9/26/2003	17.61	8.14	9.47
	12/16/2003	17.61	6.76	10.85
	4/6/2004	17.61	5.97	11.64
	6/23/2004	17.61	7.80	9.81
	9/15/2004	17.61	7.14	10.47
	12/16/2004	17.61	5.73	11.88
	3/22/2005	17.61	5.31	12.30
	6/24/2005	17.61	6.05	11.56
	9/13/2005	17.61	6.70	10.91
12/2/2005	17.61	6.92	10.69	
3/2/2006	17.61	5.83	11.78	

Table 1

**Summary of Groundwater Elevation Data
Former Lemoine Sausage Facility
630 29th Avenue
Oakland, California**

Well Identification	Date Measured	Top of Casing Elevation (ft,msl)	Depth to Water (feet)	Groundwater Elevation (ft,msl)
MW-10	12/3/2001	16.92	4.22	12.70
	3/25/2002	16.92	3.00	13.92
	6/28/2002	16.92	5.65	11.27
	9/11/2002	16.92	6.16	10.76
	12/16/2002	16.92	3.74	13.18
	3/28/2003	16.92	4.54	12.38
	6/24/2003	16.92	5.40	11.52
	9/26/2003	16.92	6.98	9.94
	12/16/2003	16.92	4.94	11.98
	4/6/2004	16.92	4.54	12.38
	6/23/2004	16.92	5.96	10.96
	9/15/2004	16.92	6.86	10.06
	12/16/2004	16.92	4.45	12.47
	3/22/2005	16.92	3.56	13.36
	6/24/2005	16.92	4.58	12.34
	9/12/2005	16.92	6.08	10.84
12/2/2005	16.92	4.94	11.98	
3/2/2006	16.92	3.90	13.02	
MW-11	12/3/2001	14.87	5.67	9.20
	3/25/2002	14.87	4.68	10.19
	6/28/2002	14.87	6.35	8.52
	9/11/2002	14.87	6.91	7.96
	12/16/2002	14.87	3.92	10.95
	3/28/2003	14.87	5.17	9.70
	6/24/2003	14.87	5.86	9.01
	9/26/2003	14.87	7.16	7.71
	12/16/2003	14.87	5.61	9.26
	4/6/2004	14.87	5.49	9.38
	6/23/2004	14.87	5.68	9.19
	12/16/2004	14.87	4.69	10.18
	3/22/2005	14.87	4.20	10.67
	6/24/2005	14.87	5.41	9.46
	9/13/2005	14.87	6.23	8.64
	9/15/2005	14.87	6.45	8.42
12/2/2005	14.87	5.95	8.92	
3/2/2006	14.87	4.31	10.56	
MW-12	6/28/2002	14.05	6.13	7.92
	9/11/2002	14.05	6.82	7.23
	12/16/2002	14.05	4.94	9.11
	3/28/2003	14.05	5.08	8.97
	6/24/2003	14.05	5.73	8.32
	9/26/2003	14.05	6.94	7.11

Table 1

Summary of Groundwater Elevation Data
Former Lemoine Sausage Facility
630 29th Avenue
Oakland, California

Well Identification	Date Measured	Top of Casing Elevation (ft,msl)	Depth to Water (feet)	Groundwater Elevation (ft,msl)
MW-12	12/16/2003	14.05	4.99	9.06
	4/6/2004	14.05	5.04	9.01
	6/23/2004	14.05	5.78	8.27
	9/15/2004	14.05	6.43	7.62
	12/16/2004	14.05	4.34	9.71
	3/22/2005	14.05	3.50	10.55
	6/24/2005	14.05	4.9	9.15
	9/12/2005	14.05	6.11	7.94
	12/2/2005	14.05	5.13	8.92
	3/2/2006	14.05	3.83	10.22
MW-13	6/28/2002	13.39	6.21	7.18
	9/11/2002	13.39	6.66	6.73
	12/16/2002	13.39	3.90	9.49
	3/28/2003	13.39	5.34	8.05
	6/24/2003	13.39	5.99	7.40
	9/26/2003	13.39	6.99	6.40
	12/16/2003	13.39	5.01	8.38
	4/6/2004	13.39	5.35	8.04
	6/23/2004	13.39	6.12	7.27
	9/15/2004	13.39	6.63	6.76
	12/16/2004	13.39	4.69	8.70
	3/22/2005	13.39	4.86	8.53
	6/24/2005	13.39	5.13	8.26
	9/12/2005	13.39	6.33	7.06
	12/2/2005	13.39	5.25	8.14
3/2/2006	13.39	4.33	9.06	

Notes:

1. All top of casing elevations referenced to mean sea level (msl) and surveyed with reference to the benchmark located at Peterson Street and East 7th Street.
2. NM refers to Not Measured.

Table 2

Summary of Groundwater Analytical Results
Former Lemoine Sausage Facility
630 29th Avenue
Oakland, California

Sample Location	Date Sampled	TPH-g	MTBE	Benzene	Toluene	Ethylbenzene	Total Xylenes	TCE	1,2-DCA	cis-1,2-DCE	trans-1,2-DCE	VC
		ug/L	ug/L	ug/L	ug/L	ug/L	ug/L	ug/L	ug/L	ug/L	ug/L	ug/L
	RWQCB ESL	100	5	1	40	30	20	5	0.5	6	10	0.5
	DHS MCL	-	13	1	150	300	1750	5	0.5	6	10	0.5
MW-1	2/8/1999	48,000	NA	3,900	6,300	970	4,300	NA	<30	NA	NA	NA
	6/15/2000	29,000	NA	3,900	<100	1,900	4,200	<5.0	<5.0	<5.0	<5.0	<5.0
	9/22/2000	25,000	<500	3,100	1,800	470	3,600	NA	NA	NA	NA	NA
	12/19/2000	25,000	NA	3,200	1,900	480	3,300	<2.5	<2.5	<2.5	<2.5	<2.5
	3/21/2000	21,000	NA	3,200	1,700	290	2,600	<2.5	<2.5	<2.5	<2.5	<2.5
	6/21/2001	12,000	NA	2,000	880	180	1,180	<0.5	3.0	<0.5	<0.5	<0.5
	9/26/2001	16,000	NA	1,100	130	< 10	320	< 2.5	< 2.5	< 2.5	< 2.5	< 2.5
	12/3/2001	15,000	NA	2,800	1,200	310	1,660	<3.1	<3.1	<3.1	<3.1	<3.1
	3/25/2002	11,000	NA	3,200	1,200	73	1,860	<5	<5	<5	<5	<5
	6/28/2002	26,000	NA	3,200	1,800	640	2,900	<3.1	<3.1	<3.1	<3.1	<3.1
	9/11/2002	27,000	NA	3,200	1,900	720	3,500	<4.2	<4.2	<4.2	<4.2	<4.2
	12/16/2002	20,000	NA	2,800	490	500	2,300	<4.2	<4.2	<4.2	<4.2	<4.2
	3/28/2003	20,000	NA	2,700	1,500	650	2,300	<3.6	<3.6	<3.6	<3.6	<3.6
	6/24/2003	14,000	NA	2,400	1,400	500	2,100	<4.2	<4.2	<4.2	<4.2	<4.2
	9/26/2003	11,000	NA	1,200	960	370	1,600	<1.0	<1.0	<1.0	<1.0	<1.0
	12/16/2003	Not Sampled										
	4/6/2004	18,000	NA	2,400	1,300	550	1,730	<2.0	<2.0	<2.0	<2.0	<2.0
	6/23/2004	25,000	NA	2,700	1,700	680	2,300	<2.5	<2.5	<2.5	<2.5	<2.5
	9/15/2004	Not Sampled										
	12/16/2004	1,800	NA	260	89	32	119	<2.5	<2.5	<2.5	<2.5	<2.5
	3/22/2005	19,000	NA	2,400	960	530	1,330	<3.6	<3.6	<3.6	<3.6	<3.6
	6/24/2005	12,000	NA	2,400	450	470	940	<3.6	<3.6	<3.6	<3.6	<3.6
	9/13/2005	17,000	NA	2,700	1,000	740	1,760	<1.0	<1.0	<1.0	<1.0	<1.0
	12/2/2005	9,300	NA	1,500	500	420	1,060	<3.6	<3.6	<3.6	<3.6	<3.6
	3/2/2006	6,200	Nna	1,400	200	180	370	<3.6	<3.6	<3.6	<3.6	<3.6

Table 2

**Summary of Groundwater Analytical Results
Former Lemoine Sausage Facility
630 29th Avenue
Oakland, California**

Sample Location	Date Sampled	TPH-g	MTBE	Benzene	Toluene	Ethylbenzene	Total Xylenes	TCE	1,2-DCA	cis-1,2-DCE	trans-1,2-DCE	VC
		ug/L	ug/L	ug/L	ug/L	ug/L	ug/L	ug/L	ug/L	ug/L	ug/L	ug/L
	RWQCB ESL	100	5	1	40	30	20	5	0.5	6	10	0.5
	DHS MCL	-	13	1	150	300	1750	5	0.5	6	10	0.5
MW-2	2/8/1999	41,000	NA	11,000	4,900	650	1,720	NA	60	NA	NA	NA
	6/29/2000	31,000	NA	11,000	930	4,400	250	<5.0	25	<5.0	<5.0	<5.0
	9/22/2000	24,000	<500	10,000	2,700	370	1,200	NA	NA	NA	NA	NA
	12/19/2000	43,000	NA	9,800	4,000	810	2,430	<13	21	<13	<13	<13
	3/23/2001	34,000	NA	10,000	3,200	410	1,220	<13	14	<13	<13	<13
	6/21/2001	30,000	NA	8,600	2,600	440	1,230	<0.5	5.6	<0.5	<0.5	<0.5
	9/26/2001	26,000	NA	12,000	3,900	590	1,960	< 10	11	< 10	< 10	< 10
	12/3/2001	45,000	NA	13,000	5,100	950	2,930	<7.1	14	<7.1	<7.1	<7.1
	3/25/2002	21,000	NA	11,000	3,700	1,000	2,790	<17	<17	<17	<17	<17
	6/28/2002	8,400	NA	2,200	680	21	220	<3.1	8.8	<3.1	<3.1	<3.1
	9/11/2002	23,000	NA	6,600	1,000	600	1,320	<6.3	10	<6.3	<6.3	<6.3
	12/16/2002	6,000	NA	1,600	410	150	402	4.5	2.7	69	6.9	<2.5
	3/28/2003	30,000	NA	9,300	920	930	2,000	<13	14	<13	<13	<13
	6/24/2003	19,000	NA	10,000	1,700	1,100	2,530	<13	<13	<13	<13	<13
	9/26/2003	20,000	NA	10,000	2,100	960	2,520	<17	<17	<17	<17	<17
	12/16/2003	22,000	NA	10,000	2,700	1,200	2,920	<25	<25	<25	<25	<25
	4/6/2004	27,000	NA	7,600	1,700	630	1,420	<10	<10	<10	<10	<10
	6/23/2004	33,000	NA	8,200	1,800	870	1,930	<17	<17	<17	<17	<17
	9/15/2004	46,000	NA	13,000	1,300	1,400	2,710	<17	<17	<17	<17	<17
	12/16/2004	Not Sampled										
	3/22/2005	42,000	NA	9,900	1,200	1,200	2,530	<17	<17	<17	<17	<17
	6/24/2005	31,000	NA	12,000	1,200	810	1,380	<20	<20	<20	<20	<20
	9/13/2005	35,000	NA	13,000	1,100	1,300	2,260	<7.1	<7.1	<7.1	<7.1	<7.1
	12/2/2005	Not Sampled										
	3/2/2006	25,000	NA	7,900	620	740	1,260	<7.1	<7.1	<7.1	<7.1	<7.1

Table 2

Summary of Groundwater Analytical Results
Former Lemoine Sausage Facility
630 29th Avenue
Oakland, California

Sample Location	Date Sampled	TPH-g	MTBE	Benzene	Toluene	Ethylbenzene	Total Xylenes	TCE	1,2-DCA	cis-1,2-DCE	trans-1,2-DCE	VC
		ug/L	ug/L	ug/L	ug/L	ug/L	ug/L	ug/L	ug/L	ug/L	ug/L	ug/L
	RWQCB ESL	100	5	1	40	30	20	5	0.5	6	10	0.5
	DHS MCL	-	13	1	150	300	1750	5	0.5	6	10	0.5
MW-3	2/8/1999	35,000	NA	1,200	3,400	1,400	4,900	NA	<30	NA	NA	NA
	6/29/2000	39,000	NA	7,800	630	8,000	3,400	<5.0	600	<5.0	<5.0	<5.0
	9/22/2000	83,000	<1,000	16,000	20,000	1,300	7,000	NA	NA	NA	NA	NA
	12/19/2000	50,000	NA	1,200	1,600	510	1,810	<8.3	350	<8.3	<8.3	<8.3
	3/22/2001	1,300	NA	98	67	51	104	<0.5	2.3	<0.5	<0.5	<0.5
	6/21/2001	34,000	NA	5,900	6,200	340	1,550	2.4	120	0.8	<0.5	<0.5
	9/26/2001	59,000	NA	12,000	13,000	780	3,680	< 8.3	990	< 8.3	< 8.3	< 8.3
	Removed from sampling program in October 2001											
MW-4	2/8/1999	15,000	NA	670	90	780	940	NA	<30	NA	NA	NA
	6/15/2000	2,300	NA	230	<5	10	94	<0.5	0.88	2.1	<0.5	<0.5
	9/22/2000	12,000	<500	2,800	82	1,100	1,300	NA	NA	NA	NA	NA
	12/19/2000	2,200	NA	200	2.9	100	81.4	<0.5	<0.5	<0.5	<0.5	<0.5
	3/22/2001	5,600	NA	1,100	13	310	303	<0.5	<0.5	1.6	<0.5	<0.5
	6/21/2001	11,000	NA	2,300	26	570	641	<0.5	1.4	3.3	<0.5	<0.5
	9/26/2001	17,000	NA	7,900	< 50	440	581	< 0.5	1.9	8.1	< 0.5	< 0.5
	Removed from sampling program in October 2001											
MW-5	2/8/1999	4,900	NA	780	440	230	370	<0.5	<0.5	<0.5	<0.5	<0.5
	6/29/2000	3,900	NA	1,500	28	330	260	<0.5	36	<0.5	<0.5	<0.5
	9/27/2000	16,000	<500	4,300	3,100	420	1,600	NA	NA	NA	NA	NA
	12/19/2000	21,000	NA	3,200	1,100	1,100	1,300	<4.2	15	<4.2	<4.2	<4.2
	3/22/2001	6,200	NA	1,500	360	310	288	<0.5	3.3	<0.5	<0.5	<0.5
	6/21/2001	18,000	NA	3,400	2,300	350	1,020	<0.5	21	<0.5	<0.5	<0.5
	9/26/2001	5,100	NA	2,400	1,200	< 10	460	< 3.6	22	< 3.6	< 3.6	< 3.6
	Removed from sampling program in October 2001											

Table 2

Summary of Groundwater Analytical Results
Former Lemoine Sausage Facility
630 29th Avenue
Oakland, California

Sample Location	Date Sampled	TPH-g	MTBE	Benzene	Toluene	Ethylbenzene	Total Xylenes	TCE	1,2-DCA	cis-1,2-DCE	trans-1,2-DCE	VC
		ug/L	ug/L	ug/L	ug/L	ug/L	ug/L	ug/L	ug/L	ug/L	ug/L	ug/L
	RWQCB ESL	100	5	1	40	30	20	5	0.5	6	10	0.5
	DHS MCL	-	13	1	150	300	1750	5	0.5	6	10	0.5
MW-6	6/15/2000	1,100	NA	3.8	2.2	2.1	4.8	< 0.5	0.78	< 0.5	< 0.5	< 0.5
	9/22/2000	71	< 5	< 0.5	< 0.5	< 0.5	< 0.5	NA	NA	NA	NA	NA
	12/19/2000	320	NA	< 0.5	< 0.5	< 0.5	< 0.5	< 0.5	< 0.5	< 0.5	< 0.5	< 0.5
	3/21/2001	820	NA	< 0.5	< 0.5	1.4	0.52	< 0.5	< 0.5	< 0.5	< 0.5	< 0.5
	6/21/2001	420	NA	< 0.5	< 0.5	0.59	1	< 0.5	0.9	< 0.5	< 0.5	< 0.5
	9/25/2001	760	NA	< 0.5	< 0.5	< 0.5	2.9	< 0.5	< 0.5	< 0.5	< 0.5	< 0.5
	12/3/2001	72	NA	< 0.5	< 0.5	< 0.5	< 0.5	< 0.5	1.6	< 0.5	< 0.5	< 0.5
	3/25/2002	1,200	NA	22	8.0	5.7	13.5	< 0.5	< 0.5	< 0.5	< 0.5	< 0.5
	6/28/2002	120	NA	< 0.5	< 0.5	< 0.5	< 0.5	< 0.5	0.6	< 0.5	< 0.5	< 0.5
	9/11/2002	120	NA	< 0.5	< 0.5	< 0.5	< 0.5	< 0.5	< 0.5	< 0.5	< 0.5	< 0.5
	12/16/2002	62	NA	< 0.5	0.54	3.0	8.39	0.7	1	< 0.5	< 0.5	< 0.5
	3/28/2003	NS	NS	NS	NS	NS	NS	NS	NS	NS	NS	NS
	6/24/2003	130	NA	< 0.5	< 0.5	< 0.5	< 0.5	< 0.5	< 0.5	< 0.5	< 0.5	< 0.5
	9/26/2003	< 50	NA	< 0.5	< 0.5	< 0.5	< 0.5	< 0.5	0.7	< 0.5	< 0.5	< 0.5
	12/16/2003	< 50	NA	< 0.5	< 0.5	< 0.5	0.88	1.7	< 0.5	0.6	< 0.5	< 0.5
	4/6/2004	260	NA	< 0.5	< 0.5	< 0.5	< 0.5	< 0.5	< 0.5	< 0.5	< 0.5	< 0.5
	6/23/2004	63	NA	< 0.5	< 0.5	< 0.5	< 0.5	< 0.5	0.8	< 0.5	< 0.5	< 0.5
	9/15/2004	< 50	NA	< 0.5	< 0.5	< 0.5	< 0.5	< 0.5	< 0.5	< 0.5	< 0.5	< 0.5
	12/16/2004	240	NA	< 0.5	< 0.5	< 0.5	< 0.5	< 0.5	< 0.5	< 0.5	< 0.5	< 0.5
	3/22/2005	420	NA	< 0.5	< 0.5	< 0.5	0.95	< 0.5	< 0.5	< 0.5	< 0.5	< 0.5
	6/24/2005	91	NA	< 0.5	< 0.5	< 0.5	< 0.5	< 0.5	< 0.5	< 0.5	< 0.5	< 0.5
	9/13/2005	< 50	NA	< 0.5	< 0.5	< 0.5	< 0.5	< 0.5	< 0.5	< 0.5	< 0.5	< 0.5
	12/2/2005	< 50	NA	< 0.5	< 0.5	< 0.5	< 0.5	< 0.5	0.7	< 0.5	< 0.5	< 0.5
	3/2/2006	120	NA	< 0.5	< 0.5	< 0.5	< 0.5	< 0.5	< 0.5	< 0.5	< 0.5	< 0.5

Table 2

Summary of Groundwater Analytical Results
Former Lemoine Sausage Facility
630 29th Avenue
Oakland, California

Sample Location	Date Sampled	TPH-g	MTBE	Benzene	Toluene	Ethylbenzene	Total Xylenes	TCE	1,2-DCA	cis-1,2-DCE	trans-1,2-DCE	VC
		ug/L	ug/L	ug/L	ug/L	ug/L	ug/L	ug/L	ug/L	ug/L	ug/L	ug/L
	RWQCB ESL	100	5	1	40	30	20	5	0.5	6	10	0.5
	DHS MCL	-	13	1	150	300	1750	5	0.5	6	10	0.5
MW-7	6/15/2000	1,000	NA	250	< 10	<10	16	< 0.5	< 0.5	< 0.5	< 0.5	< 0.5
	9/22/2000	<50	<5	2	< 0.5	< 0.5	< 0.5	NA	NA	NA	NA	NA
	12/19/2000	<50	NA	1.6	< 0.5	< 0.5	< 0.5	< 0.5	< 0.5	< 0.5	< 0.5	< 0.5
	3/21/2001	160	NA	59	< 0.5	< 0.5	< 0.5	< 0.5	< 0.5	< 0.5	< 0.5	< 0.5
	6/21/2001	<50	NA	< 0.5	< 0.5	< 0.5	< 0.5	< 0.5	< 0.5	< 0.5	< 0.5	< 0.5
	9/25/2001	< 50	NA	< 0.5	< 0.5	< 0.5	< 0.5	< 0.5	< 0.5	< 0.5	< 0.5	< 0.5
	12/3/2001	82	NA	24	< 0.5	< 0.5	< 0.5	< 0.5	< 0.5	< 0.5	< 0.5	< 0.5
	3/25/2002	<50	NA	0.56	0.75	< 0.5	0.69	< 0.5	< 0.5	< 0.5	< 0.5	< 0.5
	6/28/2002	<50	NA	< 0.5	< 0.5	< 0.5	< 0.5	< 0.5	< 0.5	< 0.5	< 0.5	< 0.5
	9/11/2002	<50	NA	< 0.5	< 0.5	< 0.5	< 0.5	< 0.5	< 0.5	< 0.5	< 0.5	< 0.5
	12/16/2002	<50	NA	< 0.5	< 0.5	1.6	3.7	0.5	< 0.5	< 0.5	< 0.5	< 0.5
	3/28/2003	<50	NA	< 0.5	< 0.5	< 0.5	< 0.5	< 0.5	< 0.5	< 0.5	< 0.5	< 0.5
	6/24/2003	<50	NA	< 0.5	< 0.5	< 0.5	< 0.5	< 0.5	< 0.5	< 0.5	< 0.5	< 0.5
	9/26/2003	<50	NA	< 0.5	< 0.5	< 0.5	< 0.5	< 0.5	< 0.5	< 0.5	< 0.5	< 0.5
	12/16/2003	<50	NA	< 0.5	< 0.5	< 0.5	0.75	1.8	< 0.5	0.6	< 0.5	< 0.5
	4/6/2004	<50	NA	< 0.5	< 0.5	< 0.5	< 0.5	< 0.5	< 0.5	< 0.5	< 0.5	< 0.5
	6/23/2004	<50	NA	< 0.5	< 0.5	< 0.5	< 0.5	< 0.5	< 0.5	< 0.5	< 0.5	< 0.5
	9/15/2004	<50	NA	< 0.5	< 0.5	< 0.5	< 0.5	< 0.5	< 0.5	< 0.5	< 0.5	< 0.5
	12/16/2004	<50	NA	< 0.5	< 0.5	< 0.5	< 0.5	< 0.5	< 0.5	< 0.5	< 0.5	< 0.5
	3/22/2005	Not Sampled										
	6/24/2005	Not Sampled										
	9/12/2005	<50	NA	< 0.5	< 0.5	< 0.5	< 0.5	< 0.5	< 0.5	< 0.5	< 0.5	< 0.5
	12/2/2005	<50	NA	< 0.5	< 0.5	< 0.5	< 0.5	< 0.5	< 0.5	< 0.5	< 0.5	< 0.5
	3/2/2006	<50	NA	< 0.5	< 0.5	< 0.5	< 0.5	< 0.5	< 0.5	< 0.5	< 0.5	< 0.5

Table 2

**Summary of Groundwater Analytical Results
Former Lemoine Sausage Facility
630 29th Avenue
Oakland, California**

Sample Location	Date Sampled	TPH-g	MTBE	Benzene	Toluene	Ethylbenzene	Total Xylenes	TCE	1,2-DCA	cis-1,2-DCE	trans-1,2-DCE	VC
		ug/L	ug/L	ug/L	ug/L	ug/L	ug/L	ug/L	ug/L	ug/L	ug/L	ug/L
	RWQCB ESL	100	5	1	40	30	20	5	0.5	6	10	0.5
	DHS MCL	-	13	1	150	300	1750	5	0.5	6	10	0.5
MW-8	6/15/2000	5,400	NA	150	<5	8.9	8.7	210	<13	1,100	73	25
	9/22/2000	1,800	<25	340	<2.5	<2.5	<2.5	NA	NA	NA	NA	NA
	12/19/2000	2,700	NA	410	<2.5	4.8	<2.5	130	9.1	1,000	67	48
	3/21/2001	3,500	NA	530	<2.5	21	<2.5	32	<3.6	760	39	58
	6/21/2001	2,400	NA	490	<2.5	29	<2.5	28	4.9	910	48	75
	9/25/2001	1,500	NA	170	4.3	1.6	2.7	36	5.0	820	59	53
	12/3/2001	1,200	NA	190	14	2.7	11.3	100	<2.5	650	44	31
	3/25/2002	990	NA	280	7.2	1.4	6.8	10	3.6	790	33	49
	6/28/2002	2,200	NA	410	<1.0	40	<1.0	18	4.9	900	54	80
	9/11/2002	2,000	NA	390	1.6	39	<1.0	17	<3.6	1,000	60	91
	12/16/2002	95	NA	26	<0.5	1	<0.5	17	2.2	330	36	4.7
	3/28/2003	1,500	NA	400	<0.5	50	0.62	3.5	<2.5	700	39	41
	6/24/2003	3,300	NA	520	<0.5	58	0.63	6.4	3.7	1,000	49	61
	9/26/2003	1,300	NA	280	3.9	38	0.85	20	<3.6	890	49	47
	12/16/2003	1,100	NA	310	<2.5	14	<2.5	12	4.3	1,200	53	110
	4/6/2004	3,800	NA	420	<0.5	53	1.2	4.4	3.7	1,100	39	58
	6/23/2004	4,600	NA	570	2.9	100	1.5	<8.3	<8.3	1,300	50	80
	9/15/2004	4,900	NA	710	<1.0	100	<1.0	<7.1	<7.1	1,200	49	100
	12/16/2004	3,800	NA	450	<0.5	75	6.5	<8.3	<8.3	1,500	60	86
	3/22/2005	1,700	NA	120	<1.0	9.8	<1.0	<3.6	<3.6	620	27	38
	6/24/2005	1,400	NA	100	<1.0	37	<1.0	<5.0	<5.0	770	29	51
	9/13/2005	2,700	NA	250	<1.0	110	<1.0	<7.1	<7.1	1,000	35	60
	12/2/2005	1,500	NA	160	<1.0	33	<1.0	13	<5.0	930	46	80
	3/2/2006	2,000 L	NA	210	<0.5	36	<0.5	<6.3	<6.3	890	34	50

Table 2

Summary of Groundwater Analytical Results
Former Lemoine Sausage Facility
630 29th Avenue
Oakland, California

Sample Location	Date Sampled	TPH-g	MTBE	Benzene	Toluene	Ethylbenzene	Total Xylenes	TCE	1,2-DCA	cis-1,2-DCE	trans-1,2-DCE	VC
		ug/L	ug/L	ug/L	ug/L	ug/L	ug/L	ug/L	ug/L	ug/L	ug/L	ug/L
	RWQCB ESL	100	5	1	40	30	20	5	0.5	6	10	0.5
	DHS MCL	-	13	1	150	300	1750	5	0.5	6	10	0.5
MW-9	12/3/2001	90,000	NA	15,000	15,000	2,200	9,100	<10	<10	<10	<10	<10
	3/25/2002	71,000	NA	15,000	17,000	1,900	8,000	<31	<31	<31	<31	<31
	6/28/2002	60,000	NA	5,800	7,400	1,100	5,400	<13	<13	<13	<13	<13
	9/11/2002	57,000	NA	8,300	6,100	340	4,700	<10	18	<10	<10	<10
	12/16/2002	29,000	NA	5,500	3,900	300	1,860	<5	8.9	<5	<5	<5
	3/28/2003	61,000	NA	13,000	8,600	860	4,800	<20	<20	<20	<20	<20
	6/24/2003	45,000	NA	15,000	9,600	1,100	5,200	<5	10	<5	<5	<5
	9/26/2003	34,000	NA	12,000	5,600	880	4,700	<17	<17	<17	<17	<17
	12/16/2003	34,000	NA	14,000	4,900	940	4,700	<42	<42	<42	<42	<42
	4/6/2004	60,000	NA	14,000	3,100	1,300	5,500	<17	<17	<17	<17	<17
	6/23/2004	53,000	NA	12,000	2,600	1,100	4,800	<20	<20	<20	<20	<20
	9/15/2004	76,000	NA	17,000	2,200	1,500	6,600	<20	<20	<20	<20	<20
	12/16/2004	63,000	NA	15,000	1,700	1,300	5,900	<20	<20	<20	<20	<20
	3/22/2005	66,000	NA	13,000	2,000	1,200	5,800	<17	<17	<17	<17	<17
	6/24/2005	54,000	NA	16,000	780	1,300	5,200	<20	<20	<20	<20	<20
	9/13/2005	48,000	NA	11,000	4,800	470	4,110	<17	<17	<17	<17	<17
12/2/2005	39,000	NA	12,000	3,800	650	3,470 C	<20	<20	<20	<20	<20	
3/2/2006	51,000	NA	12,000	3,500	750	4,170	<20	<20	<20	<20	<20	
MW-10	12/3/2001	<50	NA	<0.5	<0.5	<0.5	<0.5	<0.5	<0.5	<0.5	<0.5	<0.5
	3/25/2002	51	NA	2.5	3.6	0.53	2.27	<0.5	<0.5	<0.5	<0.5	<0.5
	6/28/2002	<50	NA	<0.5	<0.5	<0.5	<0.5	<0.5	<0.5	<0.5	<0.5	<0.5
	9/11/2002	<50	NA	<0.5	<0.5	<0.5	<0.5	<0.5	<0.5	<0.5	<0.5	<0.5
	12/16/2002	<50	NA	<0.5	0.65	3.0	7.53	0.8	<0.5	<0.5	<0.5	<0.5
	3/28/2003	<50	NA	<0.5	<0.5	<0.5	<0.5	<0.5	<0.5	<0.5	<0.5	<0.5
	6/24/2003	<50	NA	<0.5	<0.5	<0.5	<0.5	<0.5	<0.5	<0.5	<0.5	<0.5
	9/26/2003	<50	NA	<0.5	<0.5	<0.5	<0.5	<0.5	<0.5	<0.5	<0.5	<0.5

Table 2

Summary of Groundwater Analytical Results
Former Lemoine Sausage Facility
630 29th Avenue
Oakland, California

Sample Location	Date Sampled	TPH-g	MTBE	Benzene	Toluene	Ethylbenzene	Total Xylenes	TCE	1,2-DCA	cis-1,2-DCE	trans-1,2-DCE	VC
		ug/L	ug/L	ug/L	ug/L	ug/L	ug/L	ug/L	ug/L	ug/L	ug/L	ug/L
	RWQCB ESL	100	5	1	40	30	20	5	0.5	6	10	0.5
	DHS MCL	-	13	1	150	300	1750	5	0.5	6	10	0.5
MW-10	12/16/2003	<50	NA	<0.5	<0.5	<0.5	<0.5	0.6	<0.5	<0.5	<0.5	<0.5
	4/6/2004	<50	NA	<0.5	<0.5	<0.5	<0.5	<0.5	<0.5	<0.5	<0.5	<0.5
	6/23/2004	<50	NA	<0.5	<0.5	<0.5	<0.5	<0.5	<0.5	<0.5	<0.5	<0.5
	9/15/2004	<50	NA	<0.5	<0.5	<0.5	<0.5	<0.5	<0.5	<0.5	<0.5	<0.5
	12/16/2004	<50	NA	<0.5	<0.5	<0.5	<0.5	<0.5	<0.5	<0.5	<0.5	<0.5
	3/22/2005	<50	NA	<0.5	<0.5	<0.5	<0.5	<0.5	<0.5	<0.5	<0.5	<0.5
	6/24/2005	<50	NA	<0.5	<0.5	<0.5	<0.5	<0.5	<0.5	<0.5	<0.5	<0.5
	9/12/2005	<50	NA	<0.5	<0.5	<0.5	<0.5	<0.5	<0.5	<0.5	<0.5	<0.5
	12/2/2005	<50	NA	<0.5	<0.5	<0.5	<0.5	<0.5	<0.5	<0.5	<0.5	<0.5
	3/2/2006	<50	NA	0.74	<0.5	<0.5	<0.5	<0.5	<0.5	<0.5	<0.5	<0.5
MW-11	12/3/2001	1,600	NA	470	<0.5	3.7	<0.5	<0.5	<0.5	<0.5	<0.5	<0.5
	3/25/2002	130	NA	11	20	3.3	14.5	<0.5	<0.5	<0.5	<0.5	<0.5
	6/28/2002	<50	NA	7.7	<0.5	<0.5	<0.5	0.6	<0.5	<0.5	<0.5	<0.5
	9/11/2002	120	NA	66	<0.5	0.74	<0.5	<0.5	<0.5	0.6	<0.5	<0.5
	12/16/2002	160	NA	42	0.89	4.8	11.1	3.6	<0.5	1.1	<0.5	<0.5
	3/28/2003	<50	NA	<0.5	<0.5	<0.5	<0.5	<0.5	<0.5	<0.5	<0.5	<0.5
	6/24/2003	<50	NA	<0.5	<0.5	<0.5	<0.5	<0.5	<0.5	<0.5	<0.5	<0.5
	9/26/2003	<50	NA	1.2	0.69	<0.5	<0.5	<0.5	<0.5	<0.5	<0.5	<0.5
	12/16/2003	91	NA	4.7	<0.5	<0.5	0.51	2.9	<0.5	0.9	0.6	<0.5
	4/6/2004	<50	NA	<0.5	<0.5	<0.5	<0.5	<0.5	<0.5	<0.5	<0.5	<0.5
	6/23/2004	<50	NA	<0.5	<0.5	<0.5	<0.5	<0.5	<0.5	<0.5	<0.5	<0.5
	9/15/2004	<50	NA	<0.5	<0.5	<0.5	<0.5	<0.5	<0.5	<0.5	<0.5	<0.5
	12/16/2004	<50	NA	1.3	<0.5	<0.5	0.59	<0.5	<0.5	<0.5	<0.5	<0.5
	3/22/2005	<50	NA	<0.5	<0.5	<0.5	<0.5	<0.5	<0.5	<0.5	<0.5	<0.5
	6/24/2005	<50	NA	<0.5	<0.5	<0.5	<0.5	<0.5	<0.5	<0.5	<0.5	<0.5
9/13/2005	<50	NA	<0.5	<0.5	<0.5	<0.5	<0.5	<0.5	<0.5	<0.5	<0.5	

Table 2

**Summary of Groundwater Analytical Results
Former Lemoine Sausage Facility
630 29th Avenue
Oakland, California**

Sample Location	Date Sampled	TPH-g	MTBE	Benzene	Toluene	Ethylbenzene	Total Xylenes	TCE	1,2-DCA	cis-1,2-DCE	trans-1,2-DCE	VC
		ug/L	ug/L	ug/L	ug/L	ug/L	ug/L	ug/L	ug/L	ug/L	ug/L	ug/L
	RWQCB ESL	100	5	1	40	30	20	5	0.5	6	10	0.5
	DHS MCL	-	13	1	150	300	1750	5	0.5	6	10	0.5
MW-11	12/2/2005	<50	NA	<0.5	<0.5	<0.5	<0.5	<0.5	<0.5	<0.5	<0.5	<0.5
	3/2/2006	<50	NA	<0.5	<0.5	<0.5	<0.5	<0.5	<0.5	<0.5	<0.5	<0.5
MW-12	6/28/2002	71	NA	<0.5	<0.5	<0.5	<0.5	170	<0.5	42	47	0.9
	9/11/2002	89	NA	<0.5	<0.5	<0.5	<0.5	180	<0.5	46	51	0.9
	12/16/2002	130	NA	<0.5	0.9	4.2	9.9	200	<0.5	57	60	0.9
	3/28/2003	110	NA	<0.5	<0.5	<0.5	<0.5	190	<0.7	53	53	0.9
	6/24/2003	140	NA	<0.5	<0.5	<0.5	<0.5	220	<1.0	58	66	<1.0
	9/26/2003	230	NA	2.9	1.1	3.8	6.71	210	<0.7	60	63	<0.7
	12/16/2003	120	NA	<0.5	<0.5	<0.5	0.65	140	<0.5	44	44	<0.5
	4/6/2004	76	NA	<0.5	<0.5	<0.5	<0.5	160	<0.5	49	54	<0.5
	6/23/2004	99	NA	<0.5	<0.5	<0.5	<0.5	200	<0.5	65	74	<0.5
	9/15/2004	130	NA	<0.5	<0.5	<0.5	<0.5	290	<1.7	73	83	<1.7
	12/16/2004	110	NA	0.94	<0.5	<0.5	<0.5	240	<2.0	80	77	<2.0
	3/22/2005	61	NA	<0.5	<0.5	<0.5	<0.5	95	<0.5	26	42	<0.5
	6/24/2005	59	NA	<0.5	<0.5	<0.5	<0.5	120	<1.0	31	39	<1.0
	9/12/2005	64	NA	<0.5	<0.5	<0.5	<0.5	130	<0.7	34	42	<0.7
	12/2/2005	80 Y,Z	NA	<0.5	<0.5	<0.5	<0.5	170	<1.0	43	49	<1.0
	3/2/2006	54 Y Z	NA	<0.5	<0.5	<0.5	<0.5	84	<0.8	27	31	<0.8
MW-13	6/28/2002	5,600	NA	120	55	130	9.5	61	<0.5	430	14	4.4
	9/11/2002	4,500	NA	58	7.5	150	14	63	<0.5	410	13	<1.3
	12/16/2002	4,800	NA	90	<0.5	85	24	76	<0.5	250	9.4	1.8
	3/28/2003	4,400	NA	55	<0.5	51	14.3	85	<0.5	150	13	1.8
	6/24/2003	8,300	NA	100	<0.5	94	12	68	<1.0	250	19	4.2
	9/26/2003	7,200	NA	150	<1.0	89	57	51	<1.0	270	23	5.1
12/16/2003	8,100	NA	120	36	72	26.6	66	<0.7	240	23	10	

Table 2

**Summary of Groundwater Analytical Results
Former Lemoine Sausage Facility
630 29th Avenue
Oakland, California**

Sample Location	Date Sampled	TPH-g	MTBE	Benzene	Toluene	Ethylbenzene	Total Xylenes	TCE	1,2-DCA	cis-1,2-DCE	trans-1,2-DCE	VC
		ug/L	ug/L	ug/L	ug/L	ug/L	ug/L	ug/L	ug/L	ug/L	ug/L	ug/L
	RWQCB ESL	100	5	1	40	30	20	5	0.5	6	10	0.5
	DHS MCL	-	13	1	150	300	1750	5	0.5	6	10	0.5
MW-13	4/6/2004	3,300	NA	22	<1.0	37	9.0	90	<0.5	190	23	8
	6/23/2004	7,000	NA	140	25	88	21	53	<2.0	350	31	25
	9/15/2004	6,700	NA	84	<1.0	78	7.2	37	<1.7	300	40	31
	12/16/2004	4,300	NA	61	<0.5	44	11.5	69	<2.0	240	32	15
	3/22/2005	3,000	NA	24	<0.5	20	7.6	72	<0.5	120	23	6.6
	6/24/2005	2,600	NA	63	<0.5	25	4.3	42	<1.0	150	36	16
	9/12/2005	2,500	NA	20 c	<0.5	33	6.7 c	25	<1.3	170	38	22
	12/2/2005	4,200 Y	NA	70 C	<0.5	21 C	15.5 C	17	<1.3	140	40	24
3/2/2006	3,200 L Y	NA	67 C	<0.5	27	5.19 C	43	<0.8	110	32	16	

Notes:

1. All results are reported in micrograms per liter ($\mu\text{g/L}$).
2. NA refers to Not Analyzed.
3. NS refers to Not Sampled.
4. TPH-g refers to Total Petroleum Hydrocarbons as Gasoline.
5. MTBE refers to Methyl tert-butyl ether.
6. TCE refers to Trichloroethene.
7. trans-1,2-DCE refers to trans-1,2-dichloroethene.
8. cis-1,2-DCE refers to cis-1,2-Dichloroethene.
9. VC refers to Vinyl Chloride.
10. 1,2-DCA refers to 1,2-dichloroethane.
11. Y=Sample exhibits chromatographic pattern which does not resemble standard.
12. Z=Sample exhibits unknown single peak or peaks.
13. C=Presence confirmed, but RPD between columns exceed 40%.
14. L=Lighter hydrocarbons contributed to the quantitation.

FIGURES

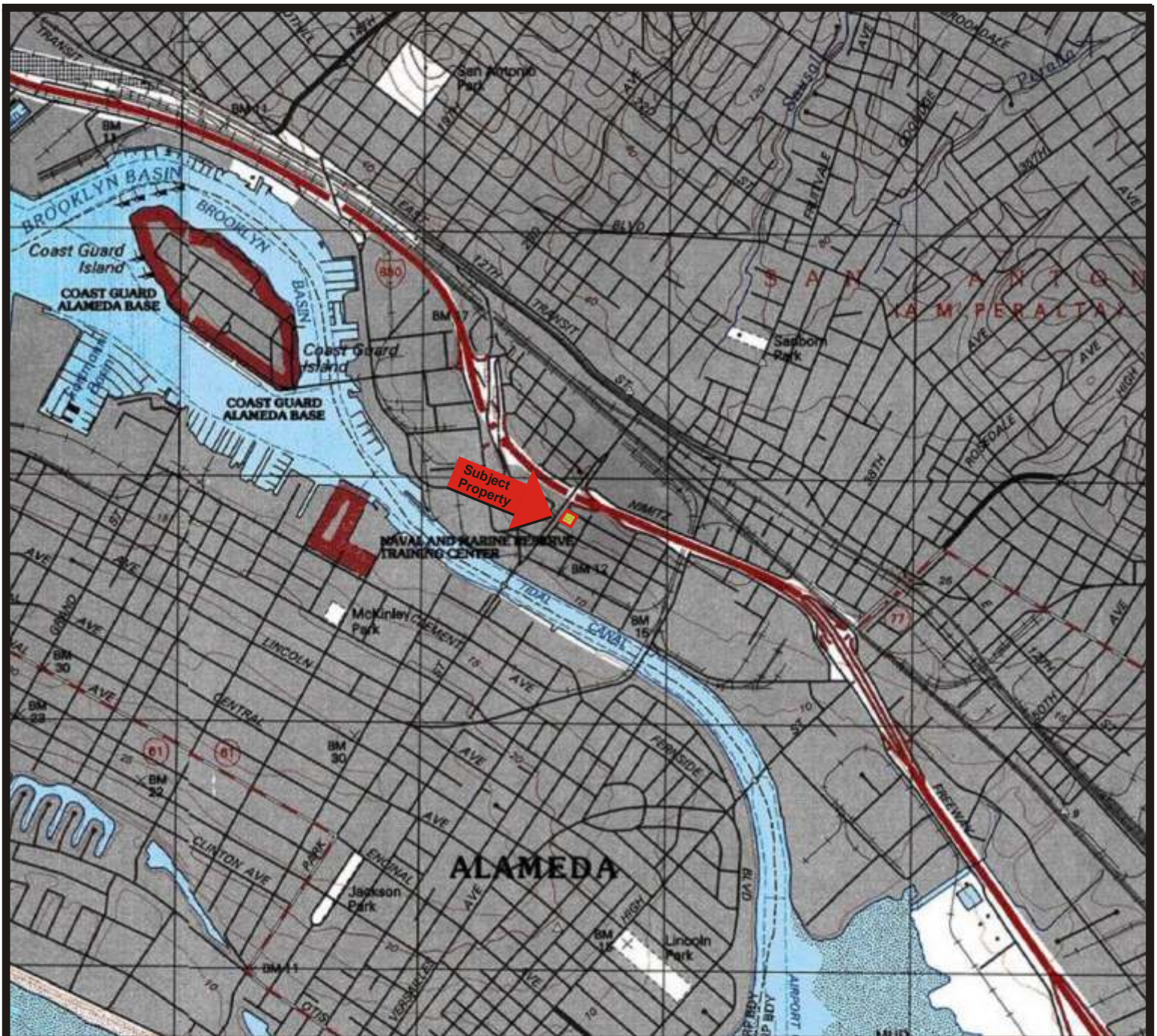

Map Source: TOPO!© 2000 National Geographic Holdings

Note: Boundaries and Location Information is Approximate

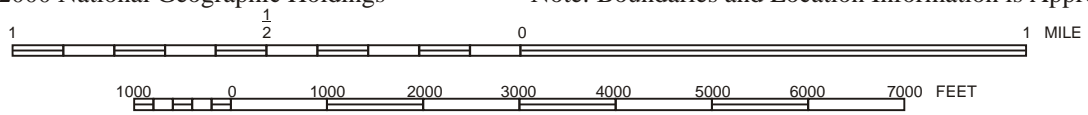

Portion of the 7.5-Minute Series Oakland East, California
 Quadrangle Topographic Map (Datum: NAD 27)
 United States Department of the Interior
 Geological Survey
 1997



QUADRANGLE LOCATION

PROPERTY LOCATION MAP
 Former Lemoine Sausage Factory
 630 29th Avenue
 Oakland, California
 Clayton Project No. 70-04578.00



Figure

1

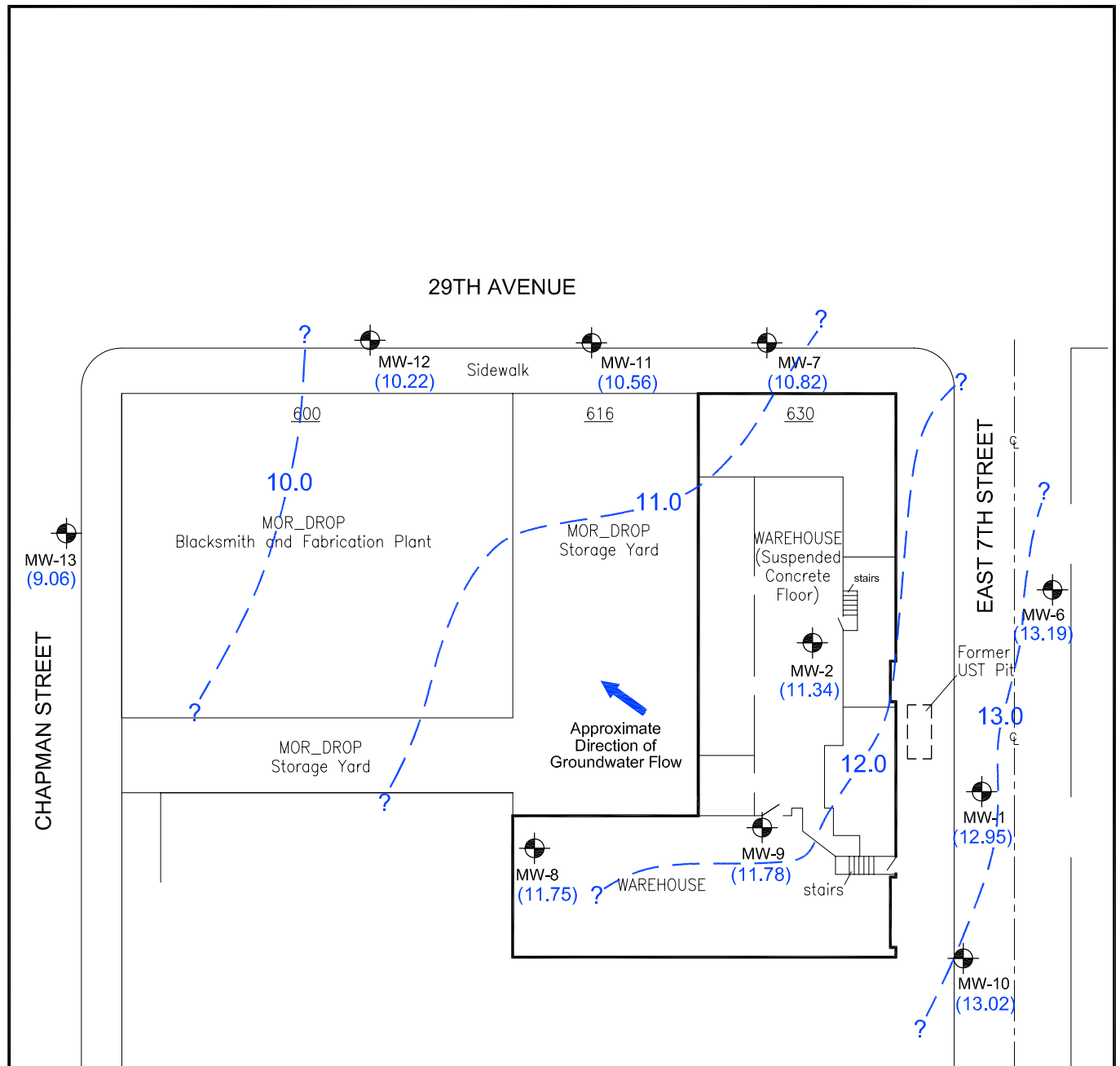



LEGEND:

- MW-1  Existing Monitoring Well Location
- (11.74) Groundwater Elevation (ft msl), 03/02/06
- 10.0  Groundwater Surface Elevation Contour (ft msl)
- ft msl Feet Above Mean Sea Level

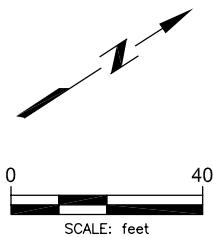

**GROUNDWATER ELEVATION MAP,
1ST QUARTER 2006**

FORMER LEMOINE SAUSAGE FACTORY
630 29TH AVENUE
OAKLAND, CALIFORNIA
Clayton Project No. 70-04578.00

Figure

2

04/14/06
SITE0306.DWG



**BUREAU
VERITAS**

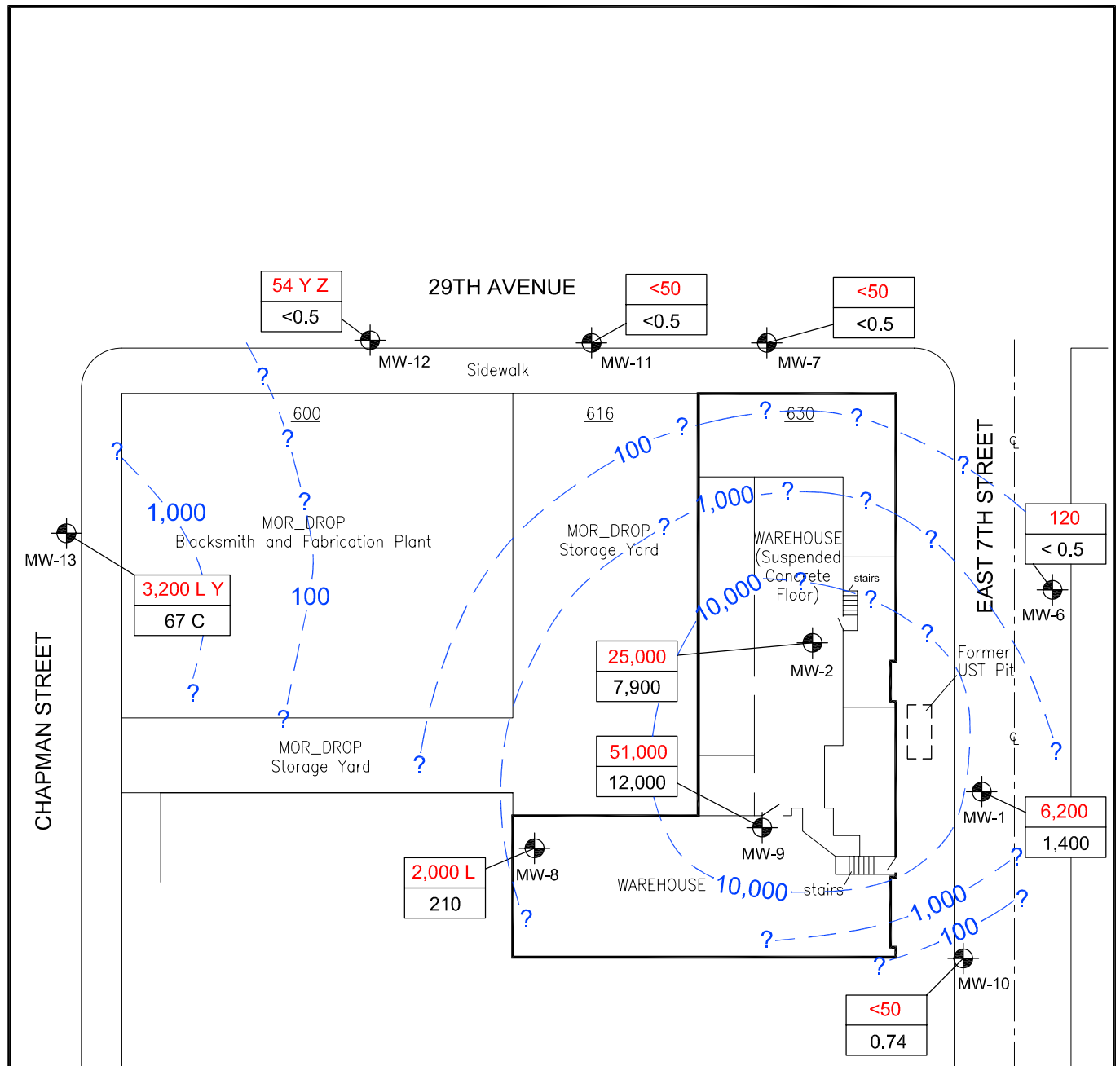

LEGEND:

MW-1 Existing Monitoring Well Location

TPH-g Concentration (ug/L), 03/02/06

Benzene Concentration (ug/L), 03/02/06

TPH-g Isocentration Contour (ug/L)

TPH-g Total Petroleum Hydrocarbons as Gasoline
ug/L micrograms per liter

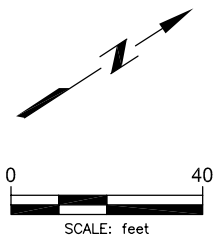

TPH-g CONCENTRATIONS IN GROUNDWATER, 1ST QUARTER 2006

FORMER LEMOINE SAUSAGE FACTORY
630 29TH AVENUE
OAKLAND, CALIFORNIA
Clayton Project No. 70-04578.00

Figure

3

04/14/06
SITE0306.DWG



BUREAU VERITAS

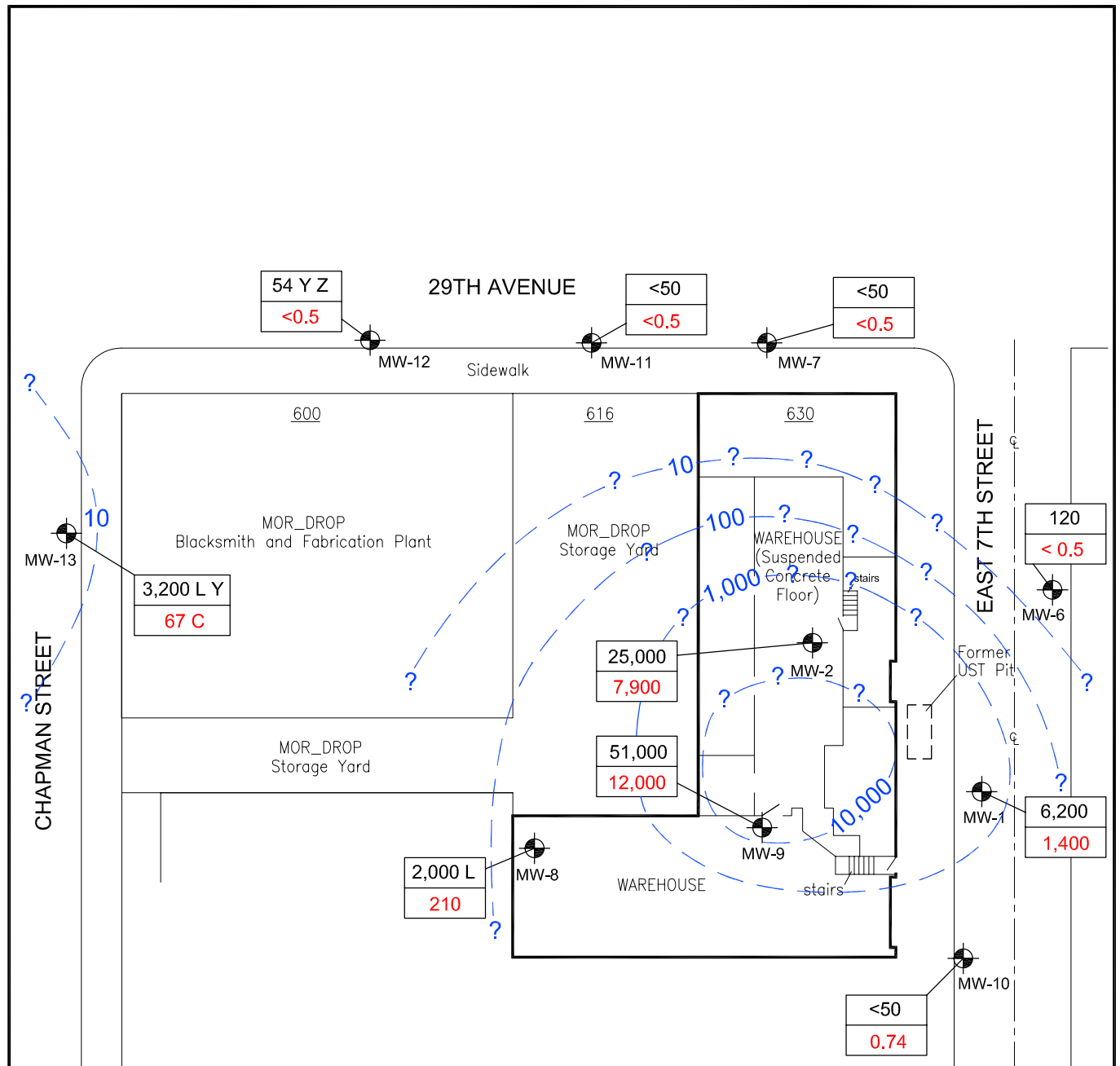

LEGEND:

MW-1 Existing Monitoring Well Location

6,200 — TPH-g Concentration (ug/L), 03/02/06

1,400 — Benzene Concentration (ug/L), 03/02/06

10 — Benzene Isocentration Contour (ug/L)

TPH-g Total Petroleum Hydrocarbons as Gasoline
ug/L micrograms per liter

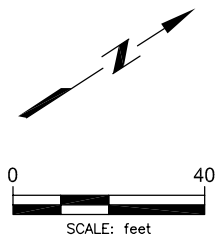

BENZENE CONCENTRATIONS IN GROUNDWATER, 1ST QUARTER 2006

FORMER LEMOINE SAUSAGE FACTORY
630 29TH AVENUE
OAKLAND, CALIFORNIA
Clayton Project No. 70-04578.00

Figure

4

04/14/06
SITE0306.DWG



BUREAU VERITAS

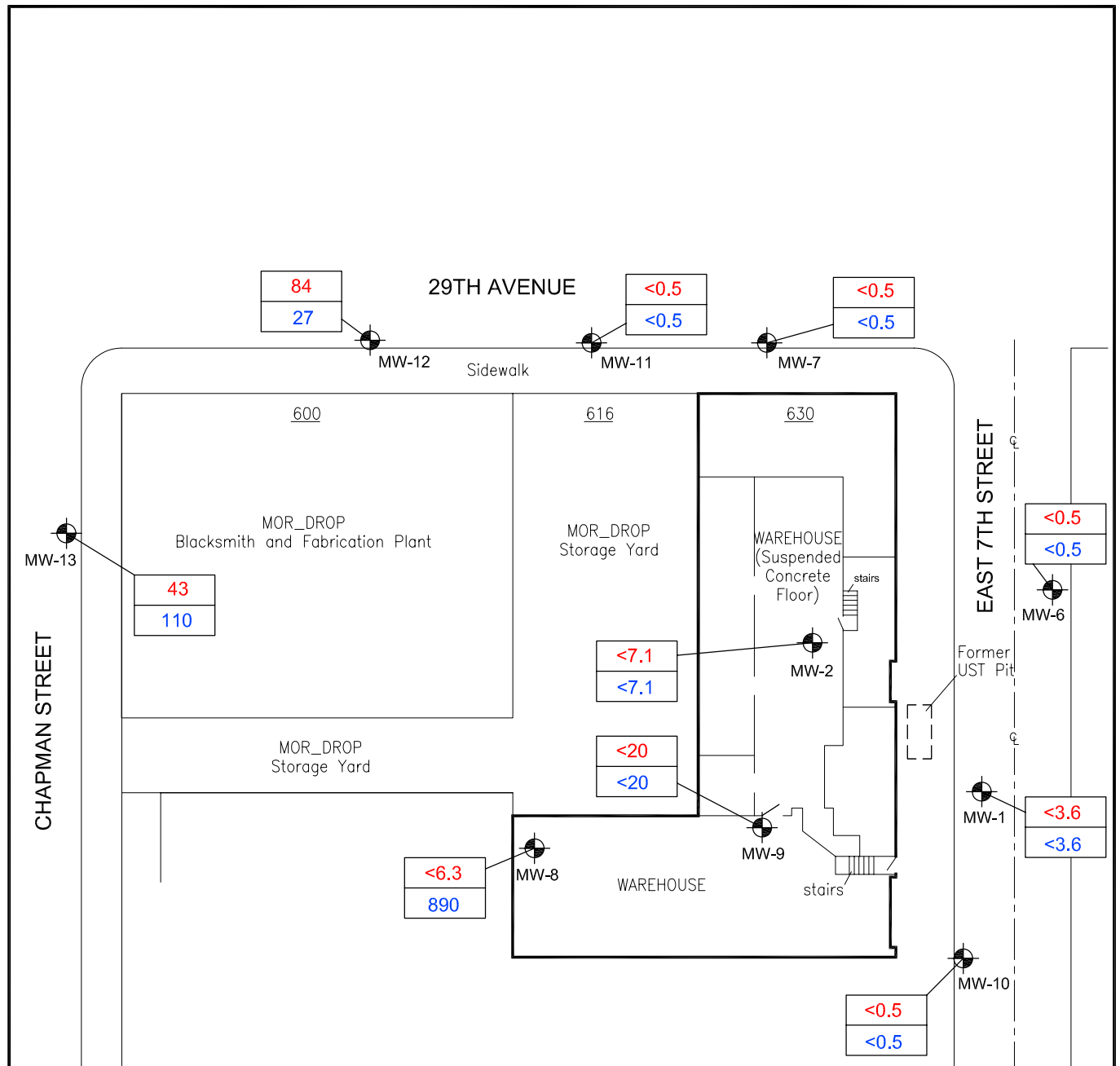

LEGEND:

MW-1 Existing Monitoring Well Location

TCE Concentration (ug/L), 03/02/06
 cis 1,2-DCE Concentration (ug/L), 03/02/06

TCE Trichloroethene
 cis 1,2-DCE cis 1,2-Dichloroethene
 ug/L micrograms per liter

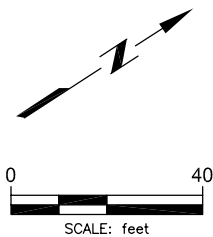

TCE AND cis-1,2-DCE CONCENTRATIONS IN GROUNDWATER, 1ST QUARTER 2006
 FORMER LEMOINE SAUSAGE FACTORY
 630 29TH AVENUE
 OAKLAND, CALIFORNIA
 Clayton Project No. 70-04578.00

Figure

5

04/14/06
 SITE0306.DWG



BUREAU VERITAS

APPENDIX A
FIRST QUARTER 2006
FIELD SAMPLING DATA SHEETS

FIELD SAMPLING DATA SHEET

Job Location: Former Lemoine Sausage Factory	Job #: 70-04578.00
630 29th Avenue	Date Purged: 3-2-06
Oakland, California	Purge Method: Percolate Pump
Sampling Location: MW-1	Date & Time Sampled: 3-2-06 12:57
Top of Casing Elevation: 16.69 (ft, msl)	Sampling Method: Percolate Pump
Depth to Water: 3.74 (ft)	Lab Analysis: TPH-g/BTEX/VOCs
Groundwater Elevation: 12.95 (ft)	Preservatives: Ice/HCL
Well Bottom Depth: 7.69 (ft)	# of Containers: 6
Water Column Height: 5.26 (ft)	Sampling Personnel: JWV
Well Casing Volume: 0.0526 (WC* 0.01)	Weather Conditions: Sunny
Casing Volumes Purged: 1	Warm slight breeze
Purge Rate:	Well Diameter: 3/4"

Time	Volume Removed (gal)	pH	Specific Conductivity (µmhos/cm)	Redox Potential (mVolts)	Temperature (°F or °C)	Turbidity (Visual)
12:52	0	8.20	0.835		16.1	Clear
:						
:						
:						
:						
:						
:						
:						
:						
:						
:						
:						

Field Notes:
 Slight petro leum odor
 Lack of groundwater within well for appropriate purging

FIELD SAMPLING DATA SHEET

Job Location: Former Lemoine Sausage Factory	Job #: 70-04578.00
630 29th Avenue	Date Purged: 3-2-06
Oakland, California	Purge Method: <i>inst/htz</i> Pump
Sampling Location: MW-2	Date & Time Sampled: 3-2-06 1235
Top of Casing Elevation: 20.79 (ft, msl)	Sampling Method: <i>inst/htz</i> Pump
Depth to Water: 9.45 (ft)	Lab Analysis: TPH-g/BTEX/VOCs
Groundwater Elevation: 11.34 (ft)	Preservatives: Ice/HCL
Well Bottom Depth: 0.79 (ft)	# of Containers: 6
Water Column Height: 10.55 (ft)	Sampling Personnel: JWV
Well Casing Volume: 0.1055 (WC* 0.01)	Weather Conditions: <i>Sunny Partly Cloudy</i>
Casing Volumes Purged: 1	<i>Warm Well Indoors</i>
Purge Rate:	Well Diameter: 3/4"

Time	Volume Removed (gal)	pH	Specific Conductivity (µmhos/cm)	Redox Potential (mVolts)	Temperature (°F or °C)	Turbidity (Visual)
12:30	0.1	7.65	5.09		17.5	Clear
:						
:						
:						
:						
:						
:						
:						
:						
:						
:						
:						

Field Notes:
Slight Petroleum Odor
lack of groundwater within well for appropriate purging

FIELD SAMPLING DATA SHEET

Job Location: Former Lemoine Sausage Factory	Job #: 70-04578.00
630 29th Avenue	Date Purged: 3-2-04
Oakland, California	Purge Method: Disposable Bailer
Sampling Location: MW-6	Date & Time Sampled: 3-2-06 1523
Top of Casing Elevation: 16.60 (ft, msl)	Sampling Method: Disposable Bailer
Depth to Water: 3.41 (ft)	Lab Analysis: TPH-g/BTEX/VOCs
Groundwater Elevation: 13.19 (ft)	Preservatives: Ice/HCL
Well Bottom Depth: -3.40 (ft)	# of Containers: 6
Water Column Height: 16.59 (ft)	Sampling Personnel: JWW
Well Casing Volume: 2,6544 (WC* 0.16)	Weather Conditions:
Casing Volumes Purged: 3	Clear Sunny, slight breeze
Purge Rate:	Well Diameter: 2"

Time	Volume Removed (gal)	pH	Specific Conductivity (µmhos/cm)	Redox Potential (mVolts)	Temperature (°F or °C)	Turbidity (Visual)
15:05	2.6	7.55	1,069	—	17.5	Slightly Cloudy
15:12	5.2	7.41	1,076	—	17.8	SAA
15:19	7.8	7.23	1,052	—	18.2	SAA
:						
:						
:						
:						
:						
:						
:						
:						
:						
:						

Field Notes:

Water surrounding well casing within well cap

FIELD SAMPLING DATA SHEET

Job Location: Former Lemoine Sausage Factory	Job #: 70-04578.00
630 29th Avenue	Date Purged: 3-2-06
Oakland, California	Purge Method: Disposable Bailer
Sampling Location: MW-7	Date & Time Sampled: 3-2-06 1742
Top of Casing Elevation: 15.47 (ft, msl)	Sampling Method: Disposable Bailer
Depth to Water: 4.65 (ft)	Lab Analysis: TPH-g/BTEX/VOCs
Groundwater Elevation: 10.82 (ft)	Preservatives: Ice/HCL
Well Bottom Depth: -4.53 (ft)	# of Containers: 6
Water Column Height: 15.35 (ft)	Sampling Personnel: JWV
Well Casing Volume: 2,456 (WC* 0.16)	Weather Conditions: Cold Windy Sun setting
Casing Volumes Purged: 3	
Purge Rate:	Well Diameter: 2"

Time	Volume Removed (gal)	pH	Specific Conductivity (µmhos/cm)	Redox Potential (mVolts)	Temperature (°F or °C)	Turbidity (Visual)
17:26	2.5	7.83	1.109	—	15.1	clear
17:31	5.0	7.52	1.093	—	17.3	clear
17:37	7.5	7.39	1.110	—	17.8	clear
:						
:						
:						
:						
:						
:						
:						
:						
:						
:						

Field Notes:

FIELD SAMPLING DATA SHEET

Job Location:	Former Lemoine Sausage Factory	Job #:	70-04578.00
	630 29th Avenue	Date Purged:	3-2-06
	Oakland, California	Purge Method:	Disposable Bailer
Sampling Location:	MW-8	Date & Time Sampled:	3-2-06 1334
Top of Casing Elevation:	17.58 (ft, msl)	Sampling Method:	Disposable Bailer
Depth to Water:	5.83 (ft)	Lab Analysis:	TPH-g/BTEX/VOCs
Groundwater Elevation:	11.75 (ft)	Preservatives:	Ice/HCL
Well Bottom Depth:	-2.42 (ft)	# of Containers:	6
Water Column Height:	14.17 (ft)	Sampling Personnel:	JVW
Well Casing Volume:	2.2672 (WC* 0.16)	Weather Conditions:	Clear Sunny
Casing Volumes Purged:	3		
Purge Rate:		Well Diameter:	2"

Time	Volume Removed (gal)	pH	Specific Conductivity (µmhos/cm)	Redox Potential (mVolts)	Temperature (°F or °C)	Turbidity (Visual)
13:15	2.2	7.66	1.129	—	15.8	Cloudy
13:19	4.4	7.69	1.147	—	15.9	Cloudy
13:24	6.6	7.61	1.125	—	16.0	Slightly Cloudy
:						
:						
:						
:						
:						
:						
:						
:						

Field Notes: Slight Petroleum odor

FIELD SAMPLING DATA SHEET

Job Location: Former Lemoine Sausage Factory	Job #: 70-04578.00
630 29th Avenue	Date Purged: 3-2-06
Oakland, California	Purge Method: Disposable Bailer
Sampling Location: MW-9	Date & Time Sampled: 3-2-06 1414
Top of Casing Elevation: 17.61 (ft, msl)	Sampling Method: Disposable Bailer
Depth to Water: 5.83 (ft)	Lab Analysis: TPH-g/BTEX/VOCs
Groundwater Elevation: 11.78 (ft)	Preservatives: Ice/HCL
Well Bottom Depth: 2.61 (ft)	# of Containers: 6
Water Column Height: 9.17 (ft)	Sampling Personnel: JWV
Well Casing Volume: 1.4672 (WC* 0.16)	Weather Conditions: Clear Sunny Warm
Casing Volumes Purged: 3	(in barrels)
Purge Rate:	Well Diameter: 2"

Time	Volume Removed (gal)	pH	Specific Conductivity (µmhos/cm)	Redox Potential (mVolts)	Temperature (°F or °C)	Turbidity (Visual)
13:46	1.5	7.50	7.85 ^{mS/cm}	—	16.9	Cloudy
13:56	3.0	7.01	8.76 ^{mS/cm}	—	17.4	Cloudy
14:01	4.5	6.89	9.54 ^{mS/cm}	—	17.7	Cloudy
:						
:						
:						
:						
:						
:						
:						
:						
:						
:						

Field Notes:
 Petroleum odor purged water was slightly ~~foggy~~ foamy
 well ran dry
 waited until 14:12, well appeared to be ~80% recharged

FIELD SAMPLING DATA SHEET

Job Location: Former Lemoine Sausage Factory	Job #: 70-04578.00
630 29th Avenue	Date Purged: 3-2-06
Oakland, California	Purge Method: Disposable Bailer
Sampling Location: MW-10	Date & Time Sampled: 3-2-06 1445
Top of Casing Elevation: 16.92 (ft, msl)	Sampling Method: Disposable Bailer
Depth to Water: 3.90 (ft)	Lab Analysis: TPH-g/BTEX/VOCs
Groundwater Elevation: 13.02 (ft)	Preservatives: Ice/HCL
Well Bottom Depth: 7.92 (ft)	# of Containers: 6
Water Column Height: 5.10 (ft)	Sampling Personnel: JWV
Well Casing Volume: 0.816 (WC* 0.16)	Weather Conditions: Clear & Sunny slight breeze
Casing Volumes Purged: 3	
Purge Rate:	Well Diameter: 2"

Time	Volume Removed (gal)	pH	Specific Conductivity (µmhos/cm)	Redox Potential (mVolts)	Temperature (°F or °C)	Turbidity (Visual)
14:35	0.8	8.72	0.903 ¹² slc	—	16.0	Clear
14:39	1.6	8.17	0.628	—	16.1	Slightly cloudy
1443 14:39	2.4	7.99	0.627	—	16.1	Slightly Cloudy
:						
:						
:						
:						
:						
:						
:						
:						
:						

Field Notes:

Water in well clear ~~and~~ surrounding well casing

FIELD SAMPLING DATA SHEET

Job Location: Former Lemoine Sausage Factory	Job #: 70-04578.00
630 29th Avenue	Date Purged: 3-2-06
Oakland, California	Purge Method: Disposable Bailer
Sampling Location: MW-11	Date & Time Sampled: 3-2-06 1715
Top of Casing Elevation: 14.87 (ft, msl)	Sampling Method: Disposable Bailer
Depth to Water: 4.31 (ft)	Lab Analysis: TPH-g/BTEX/VOCs
Groundwater Elevation: 10.56 (ft)	Preservatives: Ice/HCL
Well Bottom Depth: -0.13 (ft)	# of Containers: 6
Water Column Height: 16.69 (ft)	Sampling Personnel: JWV
Well Casing Volume: 1.7104 (WC* 0.16)	Weather Conditions: Cool breezy sun ^{settling}
Casing Volumes Purged: 3	
Purge Rate:	Well Diameter: 2"

Time	Volume Removed (gal)	pH	Specific Conductivity (µmhos/cm)	Redox Potential (mVolts)	Temperature (°F or °C)	Turbidity (Visual)
16:55	1.8	7.55	1.762	—	16.2	Clear
16:59	3.6	7.53	1.562	—	16.5	Clear
17:04	5.4	7.27	1.678	—	17.2	Brownish from sediments
:						
:						
:						
:						
:						
:						
:						
:						
:						
:						

Field Notes:

Well was almost dry waited 10 minutes for recharge

Water surrounding well casing beneath within well ^{Steel} cap

FIELD SAMPLING DATA SHEET

Job Location:	Former Lemoine Sausage Factory	Job #:	70-04578.00
	630 29th Avenue	Date Purged:	3-2-06
	Oakland, California	Purge Method:	Disposable Bailer
Sampling Location:	MW-12	Date & Time Sampled:	3-2-06 16.36
Top of Casing Elevation:	14.05 (ft, msl)	Sampling Method:	Disposable Bailer
Depth to Water:	3.83 (ft)	Lab Analysis:	TPH-g/BTEX/VOCs
Groundwater Elevation:	10.22 (ft)	Preservatives:	Ice/HCL
Well Bottom Depth:	-0.95 (ft)	# of Containers:	6
Water Column Height:	11.17 (ft)	Sampling Personnel:	JVW
Well Casing Volume:	1.7872 (WC* 0.16)	Weather Conditions:	Clear, Sunny, cooler
Casing Volumes Purged:	3		windy
Purge Rate:		Well Diameter:	2"

Time	Volume Removed (gal)	pH	Specific Conductivity (µmhos/cm)	Redox Potential (mVolts)	Temperature (°F or °C)	Turbidity (Visual)
16:21	2.0	7.45	1.735	—	16.1	Clear
16:26	4.0	7.51	1.726	—	16.2	Clear
16:31	6.0	7.63	1.792	—	16.3	Clear
:						
:						
:						
:						
:						
:						
:						
:						
:						

Field Notes:

FIELD SAMPLING DATA SHEET

Job Location: Former Lemoine Sausage Factory	Job #: 70-04578.00
630 29th Avenue	Date Purged: 3-2-06
Oakland, California	Purge Method: Disposable Bailer
Sampling Location: MW-13	Date & Time Sampled: 3-2-06 1604
Top of Casing Elevation: 13.39 (ft, msl)	Sampling Method: Disposable Bailer
Depth to Water: 4.33 (ft)	Lab Analysis: TPH-g/BTEX/VOCs
Groundwater Elevation: 9.06 (ft)	Preservatives: Ice/HCL
Well Bottom Depth: -1.61 (ft)	# of Containers: 6
Water Column Height: 10.67 (ft)	Sampling Personnel: JVV
Well Casing Volume: 1.7072 (WC* 0.16)	Weather Conditions:
Casing Volumes Purged: 3	Clear + sunny, slight breeze
Purge Rate:	Well Diameter: 2"

Time	Volume Removed (gal)	pH	Specific Conductivity (µmhos/cm)	Redox Potential (mVolts)	Temperature (°F or °C)	Turbidity (Visual)
15:50	1.7	7.47	0.889	—	17.9	Clear
15:55	3.4	7.55	0.890	—	17.1	Clear
15:59	5.1	7.63	0.879	—	17.3	Slightly cloudy
:						
:						
:						
:						
:						
:						
:						
:						
:						

Field Notes:
 Slight petroleum odor

 Water surrounded well casing within/below steel well cap

APPENDIX B

FIRST QUARTER 2006

**LABORATORY ANALYTICAL DATA SHEETS AND CHAIN-OF-
CUSTODY DOCUMENTATION**

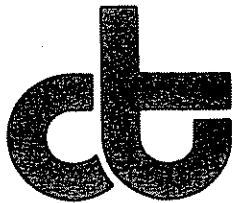

Curtis & Tompkins, Ltd., Analytical Laboratories, Since 1878

2323 Fifth Street, Berkeley, CA 94710, Phone (510) 486-0900

A N A L Y T I C A L R E P O R T

Prepared for:

Clayton Group Services
6920 Koll Center Parkway
Suite 216
Pleasanton, CA 94566

Date: 17-MAR-06
Lab Job Number: 185290
Project ID: 70-04578.00
Location: Sausage Factory

This data package has been reviewed for technical correctness and completeness. Release of this data has been authorized by the Laboratory Manager or the Manager's designee, as verified by the following signatures. The results contained in this report meet all requirements of NELAC and pertain only to those samples which were submitted for analysis.

Reviewed by:



Project Manager

Reviewed by:

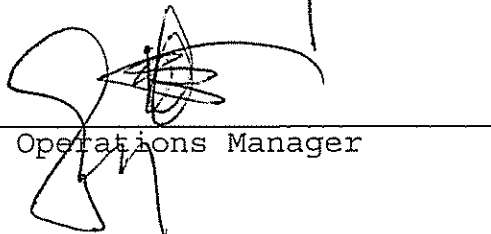

Operations Manager

This package may be reproduced only in its entirety.

CASE NARRATIVE

Laboratory number: 185290
Client: Clayton Group Services
Project: 70-04578.00
Location: Sausage Factory
Request Date: 03/03/06
Samples Received: 03/03/06

This hardcopy data package contains sample and QC results for ten water samples, requested for the above referenced project on 03/03/06. The samples were received cold and intact.

TPH-Purgeables and/or BTXE by GC (EPA 8015B and EPA 8021B):
No analytical problems were encountered.

Volatile Organics by GC/MS (EPA 8260B):
No analytical problems were encountered.

Curtis & Tompkins Laboratories Analytical Report

Lab #:	185290	Location:	Sausage Factory
Client:	Clayton Group Services	Prep:	EPA 5030B
Project#:	70-04578.00		
Matrix:	Water	Sampled:	03/02/06
Units:	uq/L	Received:	03/03/06

Field ID:	MW-01	Diln Fac:	10.00
Type:	SAMPLE	Batch#:	110959
Lab ID:	185290-001	Analyzed:	03/03/06

Analyte	Result	RL	Analysis
Gasoline C7-C12	6,200	500	EPA 8015B
Benzene	1,400	5.0	EPA 8021B
Toluene	200	5.0	EPA 8021B
Ethylbenzene	180	5.0	EPA 8021B
m,p-Xylenes	250	5.0	EPA 8021B
o-Xylene	120	5.0	EPA 8021B

Surrogate	%REC	Limits	Analysis
Trifluorotoluene (FID)	111	69-137	EPA 8015B
Bromofluorobenzene (FID)	99	80-133	EPA 8015B
Trifluorotoluene (PID)	101	64-132	EPA 8021B
Bromofluorobenzene (PID)	86	80-120	EPA 8021B

Field ID:	MW-02	Diln Fac:	50.00
Type:	SAMPLE	Batch#:	110959
Lab ID:	185290-002	Analyzed:	03/03/06

Analyte	Result	RL	Analysis
Gasoline C7-C12	25,000	2,500	EPA 8015B
Benzene	7,900	25	EPA 8021B
Toluene	620	25	EPA 8021B
Ethylbenzene	740	25	EPA 8021B
m,p-Xylenes	1,000	25	EPA 8021B
o-Xylene	260	25	EPA 8021B

Surrogate	%REC	Limits	Analysis
Trifluorotoluene (FID)	108	69-137	EPA 8015B
Bromofluorobenzene (FID)	95	80-133	EPA 8015B
Trifluorotoluene (PID)	90	64-132	EPA 8021B
Bromofluorobenzene (PID)	82	80-120	EPA 8021B

C= Presence confirmed, but RPD between columns exceeds 40%
 L= Lighter hydrocarbons contributed to the quantitation
 Y= Sample exhibits chromatographic pattern which does not resemble standard
 Z= Sample exhibits unknown single peak or peaks
 ND= Not Detected
 RL= Reporting Limit
 Page 1 of 7

Chromatogram

Sample Name : 185290-001,110959,tvh+btxe
FileName : G:\GC05\DATA\062G012.raw
Method : TVHBTXE
Start Time : 0.00 min
Scale Factor: 1.0

End Time : 25.00 min
Plot Offset: -16 mV

Sample #: a1.3
Date : 3/5/06 12:29 PM
Time of Injection: 3/3/06 03:24 PM
Low Point : -16.14 mV
Plot Scale: 592.6 mV

Page 1 of 1

MW-01

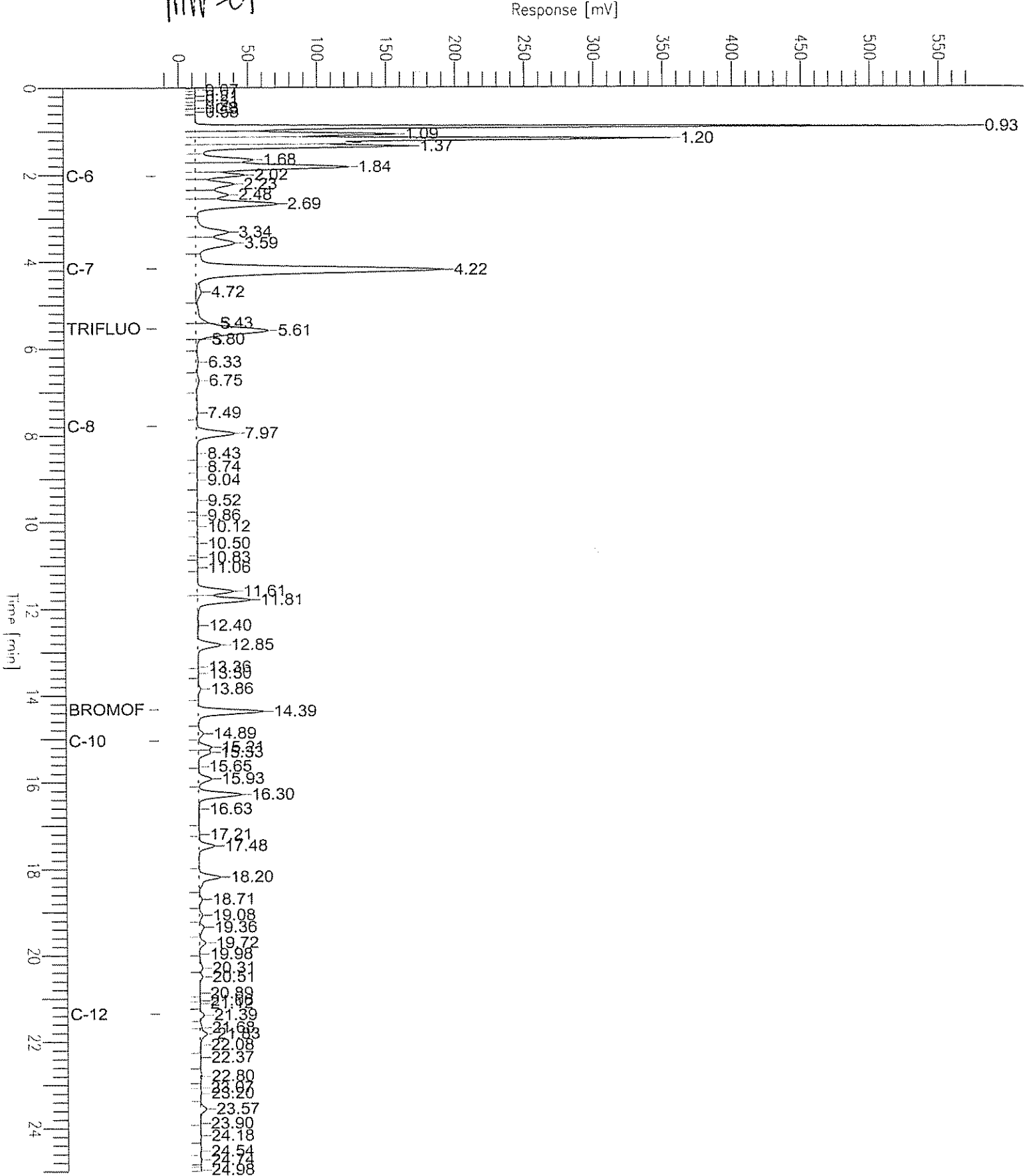

Chromatogram

Sample Name : 185290-002,110959,tvh+btxe
FileName : G:\GC05\DATA\062G013.raw
Method : TVHBTXE
Start Time : 0.00 min
Scale Factor: 1.0

End Time : 25.00 min
Plot Offset: 2 mV

Sample #: a1.3

Date : 3/3/06 04:21 PM

Time of Injection: 3/3/06 03:56 PM

Low Point : 1.58 mV

Plot Scale: 221.7 mV

Page 1 of 1

High Point : 223.33 mV

MW-02

Response [mV]

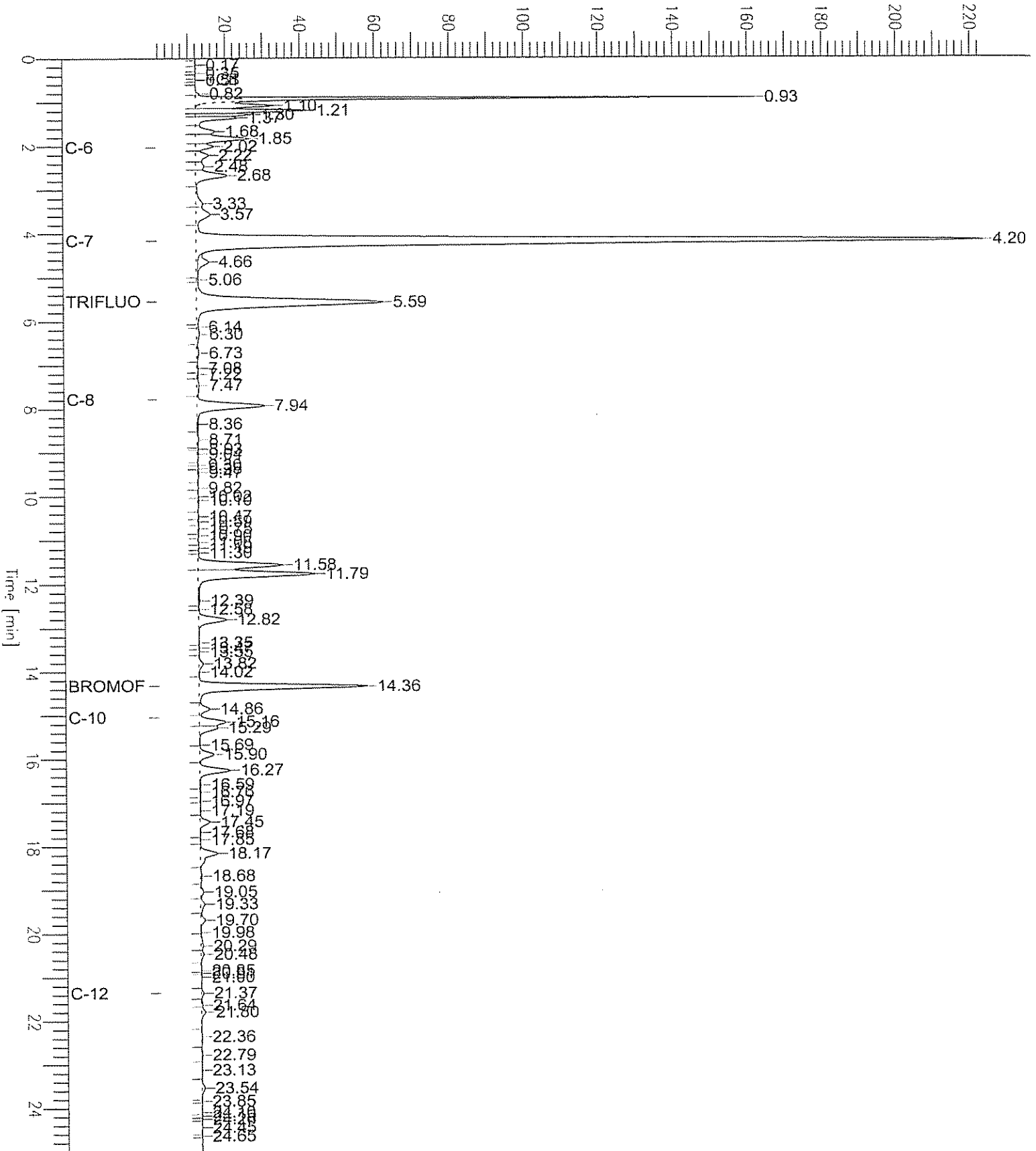



Curtis & Tompkins Laboratories Analytical Report

Lab #:	185290	Location:	Sausage Factory
Client:	Clayton Group Services	Prep:	EPA 5030B
Project#:	70-04578.00		
Matrix:	Water	Sampled:	03/02/06
Units:	ug/L	Received:	03/03/06

Field ID: MW-06 Diln Fac: 1.000
 Type: SAMPLE Batch#: 110959
 Lab ID: 185290-003 Analyzed: 03/03/06

Analyte	Result	RL	Analysis
Gasoline C7-C12	120	50	EPA 8015B
Benzene	ND	0.50	EPA 8021B
Toluene	ND	0.50	EPA 8021B
Ethylbenzene	ND	0.50	EPA 8021B
m,p-Xylenes	ND	0.50	EPA 8021B
o-Xylene	ND	0.50	EPA 8021B

Surrogate	%REC	Limits	Analysis
Trifluorotoluene (FID)	113	69-137	EPA 8015B
Bromofluorobenzene (FID)	103	80-133	EPA 8015B
Trifluorotoluene (PID)	88	64-132	EPA 8021B
Bromofluorobenzene (PID)	87	80-120	EPA 8021B

Field ID: MW-07 Diln Fac: 1.000
 Type: SAMPLE Batch#: 111004
 Lab ID: 185290-004 Analyzed: 03/05/06

Analyte	Result	RL	Analysis
Gasoline C7-C12	ND	50	EPA 8015B
Benzene	ND	0.50	EPA 8021B
Toluene	ND	0.50	EPA 8021B
Ethylbenzene	ND	0.50	EPA 8021B
m,p-Xylenes	ND	0.50	EPA 8021B
o-Xylene	ND	0.50	EPA 8021B

Surrogate	%REC	Limits	Analysis
Trifluorotoluene (FID)	105	69-137	EPA 8015B
Bromofluorobenzene (FID)	100	80-133	EPA 8015B
Trifluorotoluene (PID)	85	64-132	EPA 8021B
Bromofluorobenzene (PID)	85	80-120	EPA 8021B

C= Presence confirmed, but RPD between columns exceeds 40%

L= Lighter hydrocarbons contributed to the quantitation

Y= Sample exhibits chromatographic pattern which does not resemble standard

Z= Sample exhibits unknown single peak or peaks

ND= Not Detected

RL= Reporting Limit

Chromatogram

Sample Name : 185290-003,110959,tvh+btxe
FileName : G:\GC05\DATA\062G014.raw
Method : TVHBTXE
Start Time : 0.00 min
Scale Factor: 1.0

End Time : 25.00 min
Plot Offset: 5 mV

Sample #: a1.3

Date : 3/3/06 04:53 PM

Time of Injection: 3/3/06 04:28 PM

Low Point : 5.13 mV

Plot Scale: 147.1 mV

Page 1 of 1

High Point : 152.20 mV

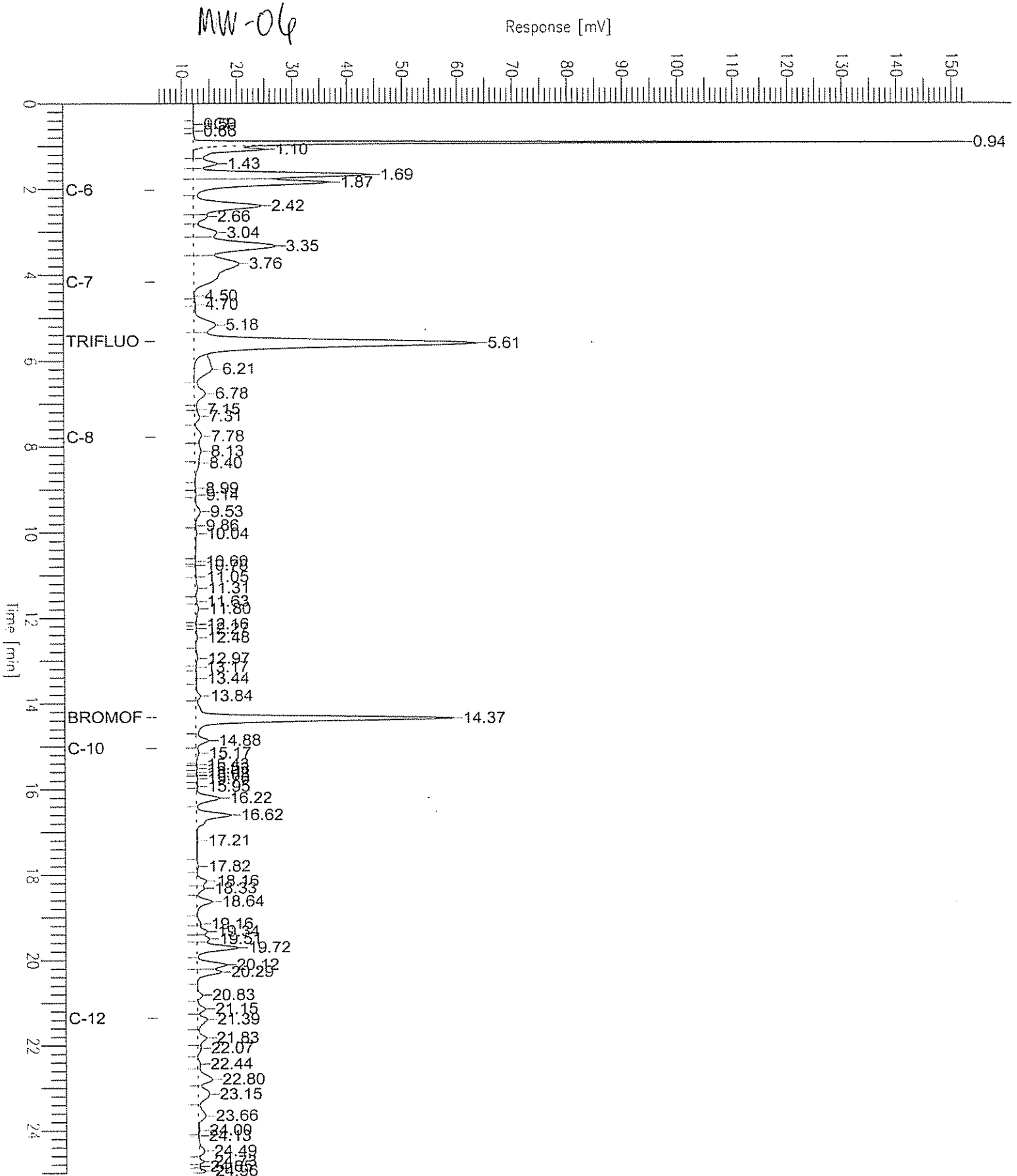



Curtis & Tompkins Laboratories Analytical Report

Lab #:	185290	Location:	Sausage Factory
Client:	Clayton Group Services	Prep:	EPA 5030B
Project#:	70-04578.00		
Matrix:	Water	Sampled:	03/02/06
Units:	ug/L	Received:	03/03/06

Field ID: MW-08 Diln Fac: 1.000
 Type: SAMPLE Batch#: 111015
 Lab ID: 185290-005 Analyzed: 03/06/06

Analyte	Result	RL	Analysis
Gasoline C7-C12	2,000 L	50	EPA 8015B
Benzene	210	0.50	EPA 8021B
Toluene	ND	0.50	EPA 8021B
Ethylbenzene	36	0.50	EPA 8021B
m,p-Xylenes	ND	0.50	EPA 8021B
o-Xylene	ND	0.50	EPA 8021B

Surrogate	%REC	Limits	Analysis
Trifluorotoluene (FID)	122	69-137	EPA 8015B
Bromofluorobenzene (FID)	110	80-133	EPA 8015B
Trifluorotoluene (PID)	97	64-132	EPA 8021B
Bromofluorobenzene (PID)	93	80-120	EPA 8021B

Field ID: MW-09 Diln Fac: 50.00
 Type: SAMPLE Batch#: 111015
 Lab ID: 185290-006 Analyzed: 03/06/06

Analyte	Result	RL	Analysis
Gasoline C7-C12	51,000	2,500	EPA 8015B
Benzene	12,000	25	EPA 8021B
Toluene	3,500	25	EPA 8021B
Ethylbenzene	750	25	EPA 8021B
m,p-Xylenes	3,700	25	EPA 8021B
o-Xylene	470	25	EPA 8021B

Surrogate	%REC	Limits	Analysis
Trifluorotoluene (FID)	124	69-137	EPA 8015B
Bromofluorobenzene (FID)	102	80-133	EPA 8015B
Trifluorotoluene (PID)	104	64-132	EPA 8021B
Bromofluorobenzene (PID)	90	80-120	EPA 8021B

C= Presence confirmed, but RPD between columns exceeds 40%
 L= Lighter hydrocarbons contributed to the quantitation
 Y= Sample exhibits chromatographic pattern which does not resemble standard
 Z= Sample exhibits unknown single peak or peaks
 ND= Not Detected
 RL= Reporting Limit

Chromatogram

Sample Name : 185290-005,111015,tvh+btxe
FileName : G:\GC05\DATA\065G008.raw
Method : TVHBTXE
Start Time : 0.00 min
Scale Factor: 1.0

End Time : 25.00 min
Plot Offset: -36 mV

Sample #: c1.3
Date : 3/7/06 09:35 AM
Time of Injection: 3/6/06 05:48 PM
Low Point : -35.80 mV
Plot Scale: 1005.2 mV

Page 1 of 1

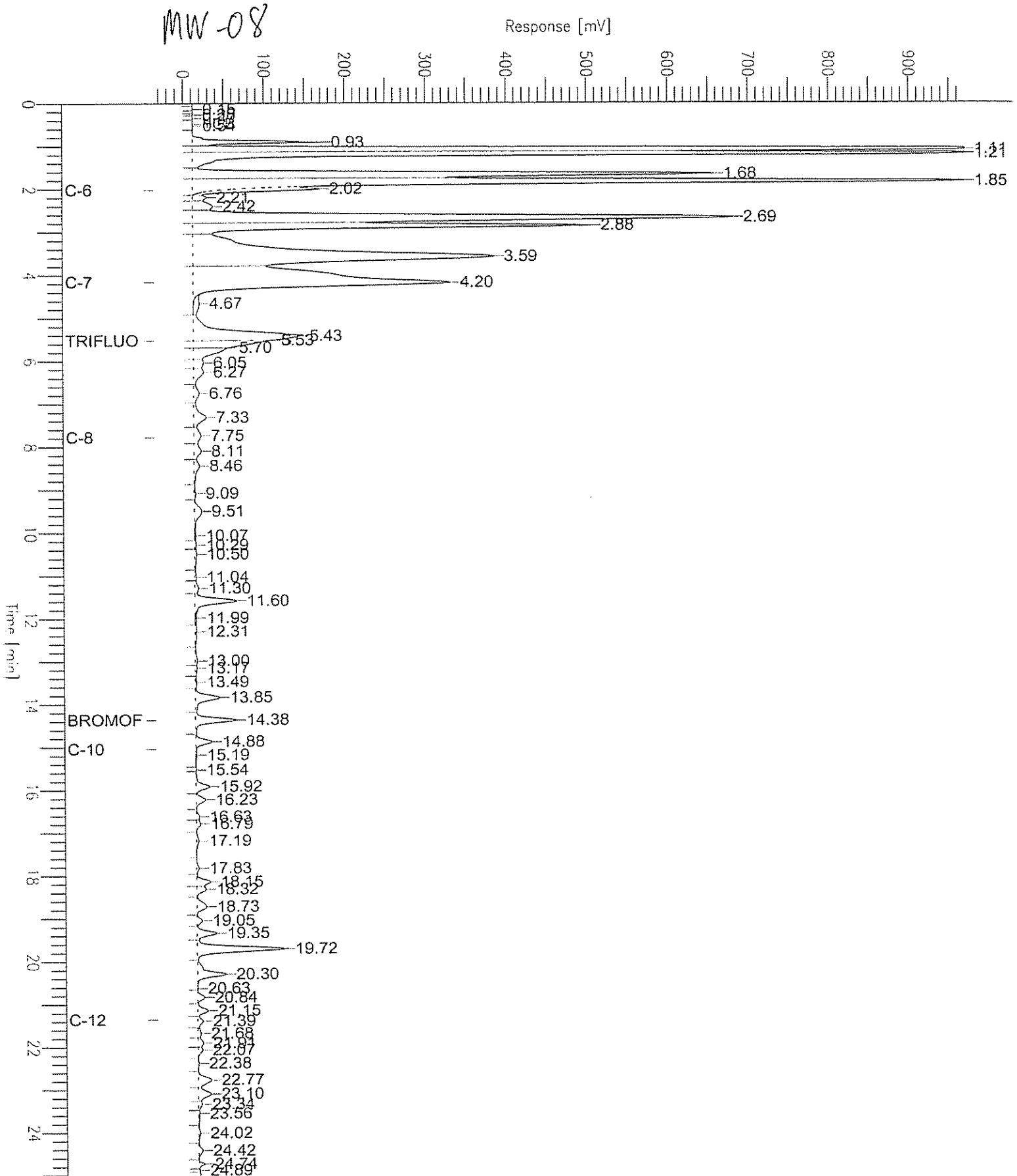

Chromatogram

Sample Name : 185290-006,111015,tvh+btxe
FileName : G:\GC05\DATA\065G007.raw
Method : TVHBTXE
Start Time : 0.00 min
Scale Factor: 1.0

Sample #: d1.3
Date : 3/6/06 05:41 PM
Time of Injection: 3/6/06 05:16 PM
Low Point : -3.31 mV
Plot Scale: 323.9 mV

Page 1 of 1

MW-09

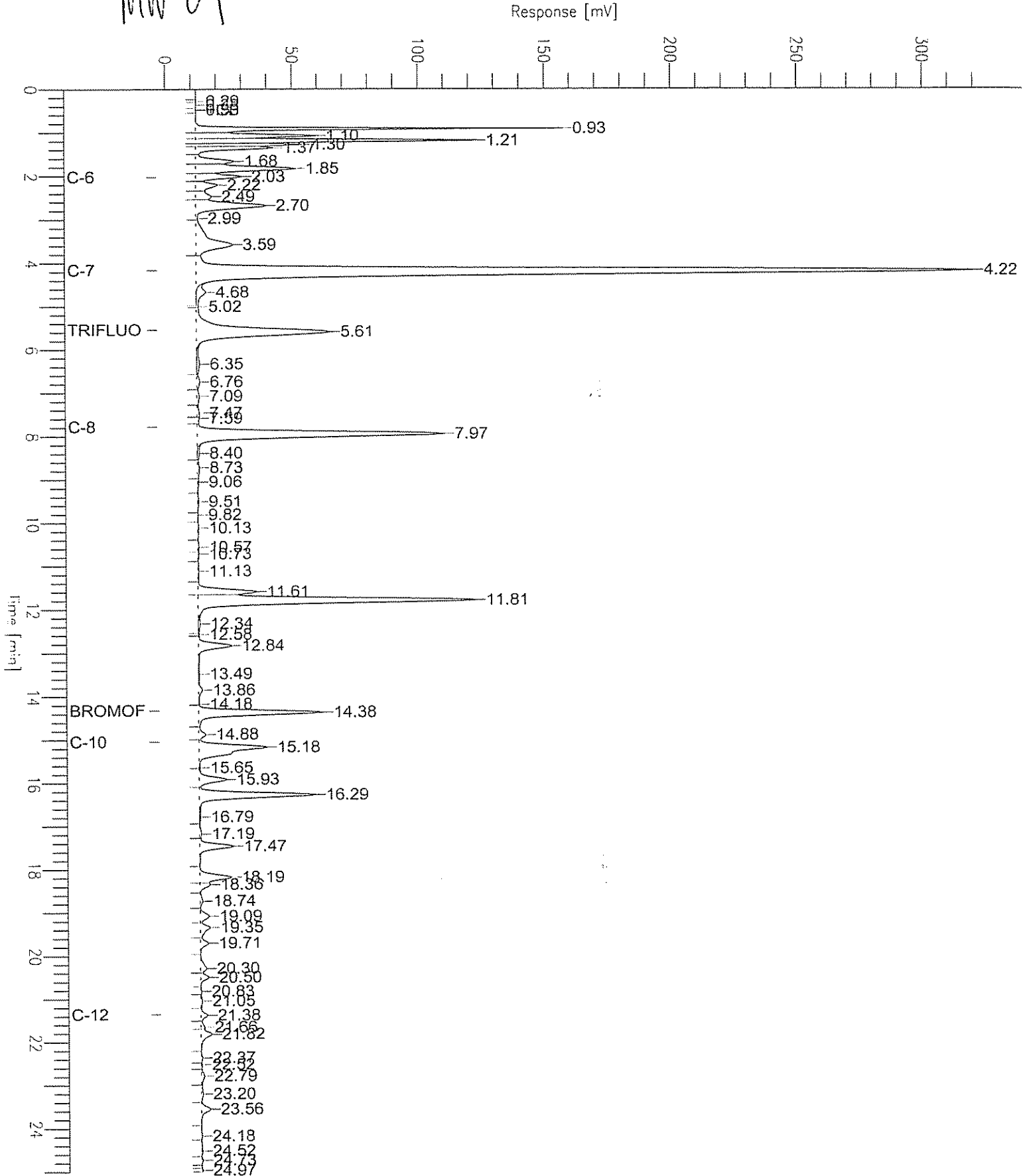



Curtis & Tompkins Laboratories Analytical Report

Lab #:	185290	Location:	Sausage Factory
Client:	Clayton Group Services	Prep:	EPA 5030B
Project#:	70-04578.00		
Matrix:	Water	Sampled:	03/02/06
Units:	ug/L	Received:	03/03/06

Field ID: MW-10 Diln Fac: 1.000
 Type: SAMPLE Batch#: 110959
 Lab ID: 185290-007 Analyzed: 03/03/06

Analyte	Result	RL	Analysis
Gasoline C7-C12	ND	50	EPA 8015B
Benzene	0.74	0.50	EPA 8021B
Toluene	ND	0.50	EPA 8021B
Ethylbenzene	ND	0.50	EPA 8021B
m,p-Xylenes	ND	0.50	EPA 8021B
o-Xylene	ND	0.50	EPA 8021B

Surrogate	%REC	Limits	Analysis
Trifluorotoluene (FID)	100	69-137	EPA 8015B
Bromofluorobenzene (FID)	96	80-133	EPA 8015B
Trifluorotoluene (PID)	97	64-132	EPA 8021B
Bromofluorobenzene (PID)	96	80-120	EPA 8021B

Field ID: MW-11 Diln Fac: 1.000
 Type: SAMPLE Batch#: 110959
 Lab ID: 185290-008 Analyzed: 03/03/06

Analyte	Result	RL	Analysis
Gasoline C7-C12	ND	50	EPA 8015B
Benzene	ND	0.50	EPA 8021B
Toluene	ND	0.50	EPA 8021B
Ethylbenzene	ND	0.50	EPA 8021B
m,p-Xylenes	ND	0.50	EPA 8021B
o-Xylene	ND	0.50	EPA 8021B

Surrogate	%REC	Limits	Analysis
Trifluorotoluene (FID)	100	69-137	EPA 8015B
Bromofluorobenzene (FID)	97	80-133	EPA 8015B
Trifluorotoluene (PID)	95	64-132	EPA 8021B
Bromofluorobenzene (PID)	96	80-120	EPA 8021B

C= Presence confirmed, but RPD between columns exceeds 40%
 L= Lighter hydrocarbons contributed to the quantitation
 Y= Sample exhibits chromatographic pattern which does not resemble standard
 Z= Sample exhibits unknown single peak or peaks
 ND= Not Detected
 RL= Reporting Limit

Chromatogram

Sample Name : 185290-007,110959,tvh+btxe
FileName : G:\GC05\DATA\062G018.raw
Method : TVHBTXE
Start Time : 0.00 min
Scale Factor: 1.0

End Time : 25.00 min
Plot Offset: 5 mV

Sample #: a1.6

Date : 3/3/06 07:00 PM

Time of Injection: 3/3/06 06:35 PM

Low Point : 5.03 mV

Plot Scale: 149.4 mV

Page 1 of 1

High Point : 154.41 mV

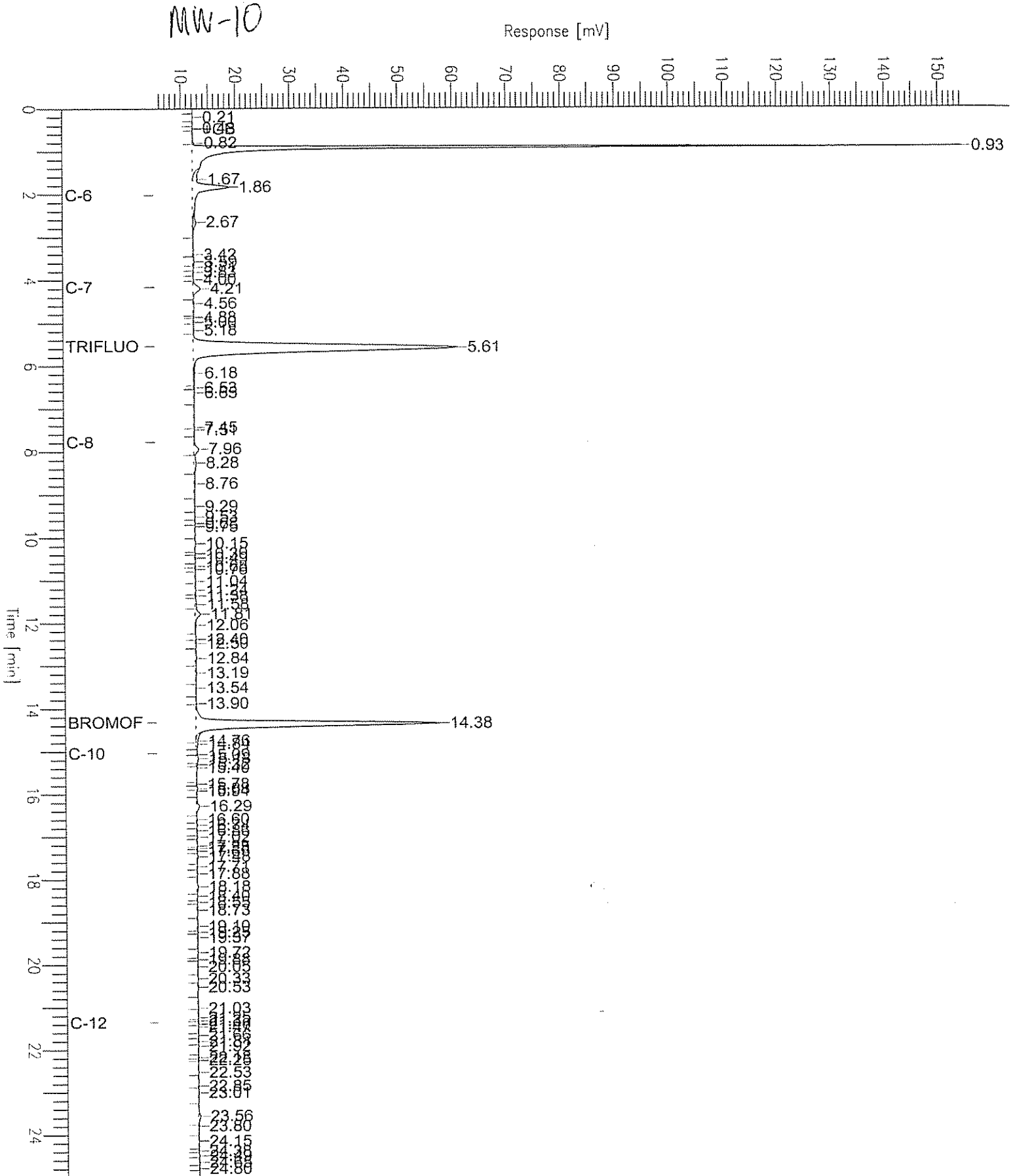



Curtis & Tompkins Laboratories Analytical Report

Lab #:	185290	Location:	Sausage Factory
Client:	Clayton Group Services	Prep:	EPA 5030B
Project#:	70-04578.00		
Matrix:	Water	Sampled:	03/02/06
Units:	ug/L	Received:	03/03/06

Field ID: MW-12 Diln Fac: 1.000
 Type: SAMPLE Batch#: 110959
 Lab ID: 185290-009 Analyzed: 03/03/06

Analyte	Result	RL	Analysis
Gasoline C7-C12	54 Y Z	50	EPA 8015B
Benzene	ND	0.50	EPA 8021B
Toluene	ND	0.50	EPA 8021B
Ethylbenzene	ND	0.50	EPA 8021B
m,p-Xylenes	ND	0.50	EPA 8021B
o-Xylene	ND	0.50	EPA 8021B

Surrogate	%REC	Limits	Analysis
Trifluorotoluene (FID)	98	69-137	EPA 8015B
Bromofluorobenzene (FID)	91	80-133	EPA 8015B
Trifluorotoluene (PID)	99	64-132	EPA 8021B
Bromofluorobenzene (PID)	93	80-120	EPA 8021B

Field ID: MW-13 Diln Fac: 1.000
 Type: SAMPLE Batch#: 110959
 Lab ID: 185290-010 Analyzed: 03/03/06

Analyte	Result	RL	Analysis
Gasoline C7-C12	3,200 L Y	50	EPA 8015B
Benzene	67 C	0.50	EPA 8021B
Toluene	ND	0.50	EPA 8021B
Ethylbenzene	27	0.50	EPA 8021B
m,p-Xylenes	4.2 C	0.50	EPA 8021B
o-Xylene	0.99 C	0.50	EPA 8021B

Surrogate	%REC	Limits	Analysis
Trifluorotoluene (FID)	99	69-137	EPA 8015B
Bromofluorobenzene (FID)	123	80-133	EPA 8015B
Trifluorotoluene (PID)	96	64-132	EPA 8021B
Bromofluorobenzene (PID)	92	80-120	EPA 8021B

C= Presence confirmed, but RPD between columns exceeds 40%
 L= Lighter hydrocarbons contributed to the quantitation
 Y= Sample exhibits chromatographic pattern which does not resemble standard
 Z= Sample exhibits unknown single peak or peaks
 ND= Not Detected
 RL= Reporting Limit

Chromatogram

Sample Name : 185290-009,110959,tvh+btxe
 FileName : G:\GC05\DATA\062G020.raw
 Method : TVHBTXE
 Start Time : 0.00 min
 Scale Factor: 1.0

End Time : 25.00 min
 Plot Offset: 4 mV

Sample #: a1.3
 Date : 3/3/06 08:04 PM
 Time of Injection: 3/3/06 07:38 PM
 Low Point : 4.48 mV
 Plot Scale: 161.3 mV

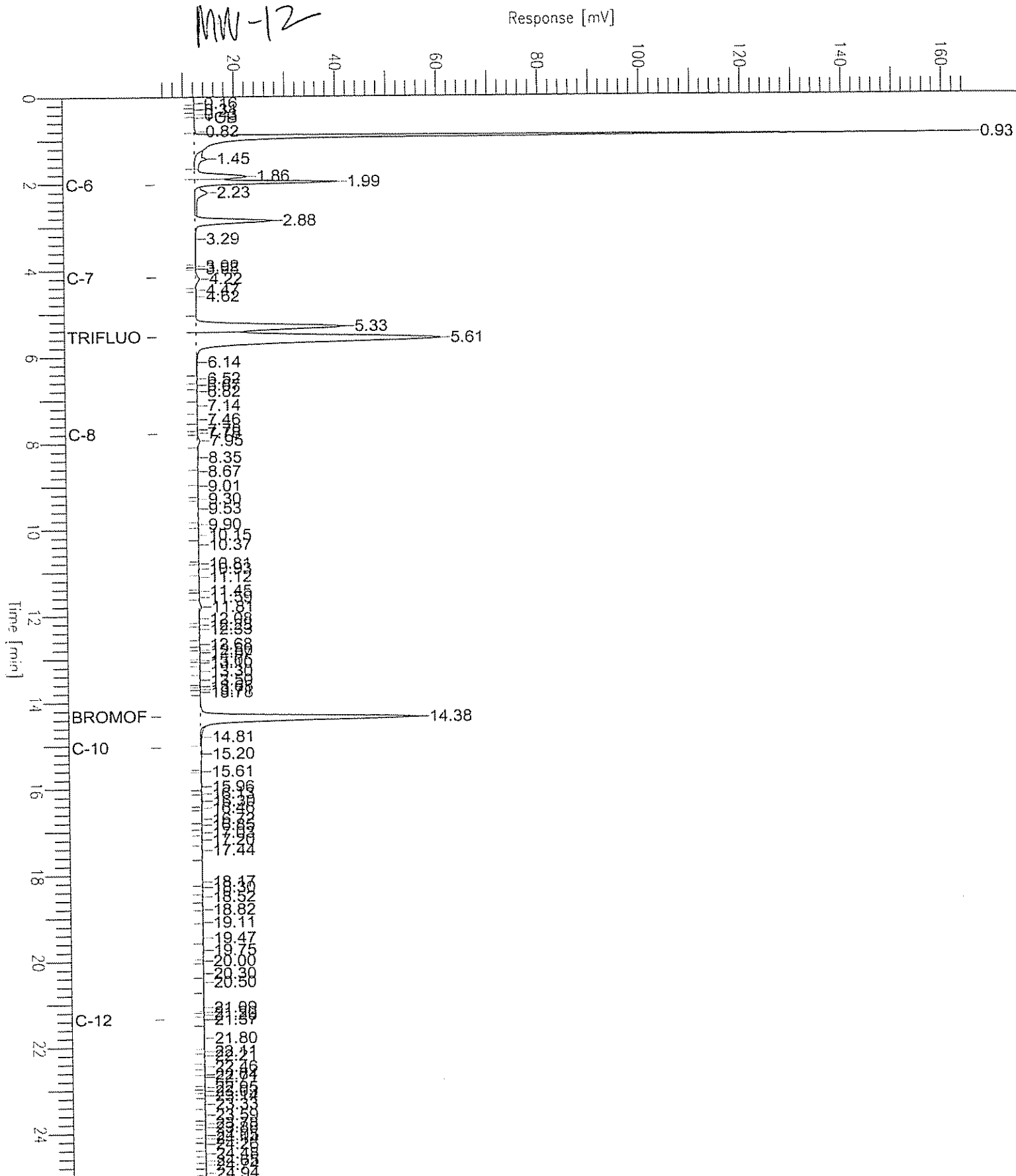

Chromatogram

Sample Name : 185290-010,110959,tvh+btxe
FileName : G:\GC05\DATA\062G027.raw
Method : TVHBTXE
Start Time : 0.00 min
Scale Factor: 1.0

End Time : 25.00 min
Plot Offset: -36 mV

Sample #: cl.3

Page 1 of 1

Date : 3/6/06 03:13 PM

Time of Injection: 3/3/06 11:20 PM

Low Point : -35.51 mV

High Point : 969.36 mV

Plot Scale: 1004.9 mV

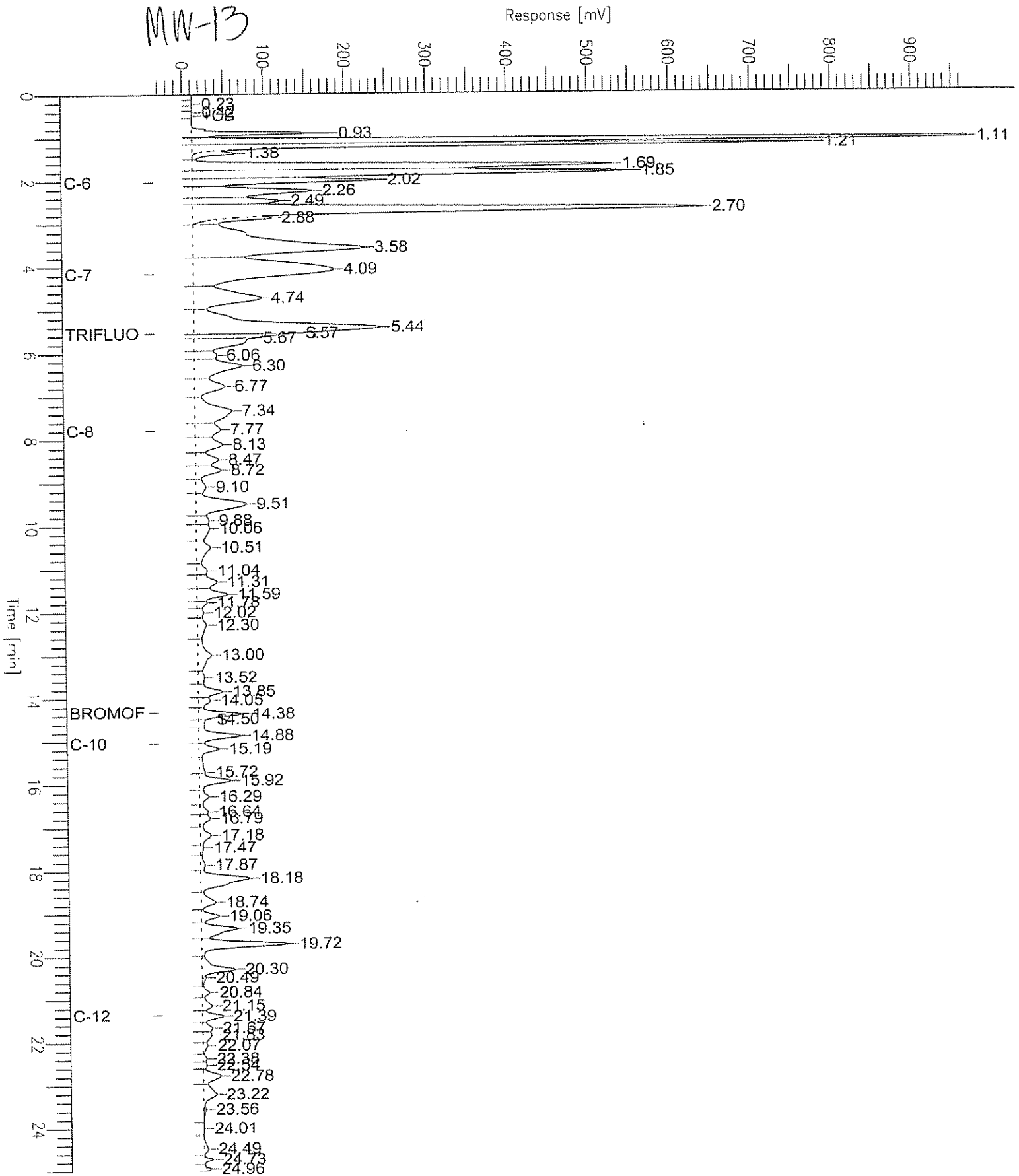

Chromatogram

Sample Name : ccv/lcs,qc330056,110959,s2730,5/5000
FileName : G:\GC05\DATA\062G003.raw
Method : TVHBTXE
Start Time : 0.00 min
Scale Factor: 1.0

End Time : 25.00 min
Plot Offset: -11 mV

Sample #:
Date : 3/3/06 11:43 AM
Time of Injection: 3/3/06 10:28 AM
Low Point : -10.78 mV
Plot Scale: 482.7 mV
High Point : 471.89 mV

Page 1 of 1

Gas/BTEX Standard

Response [mV]

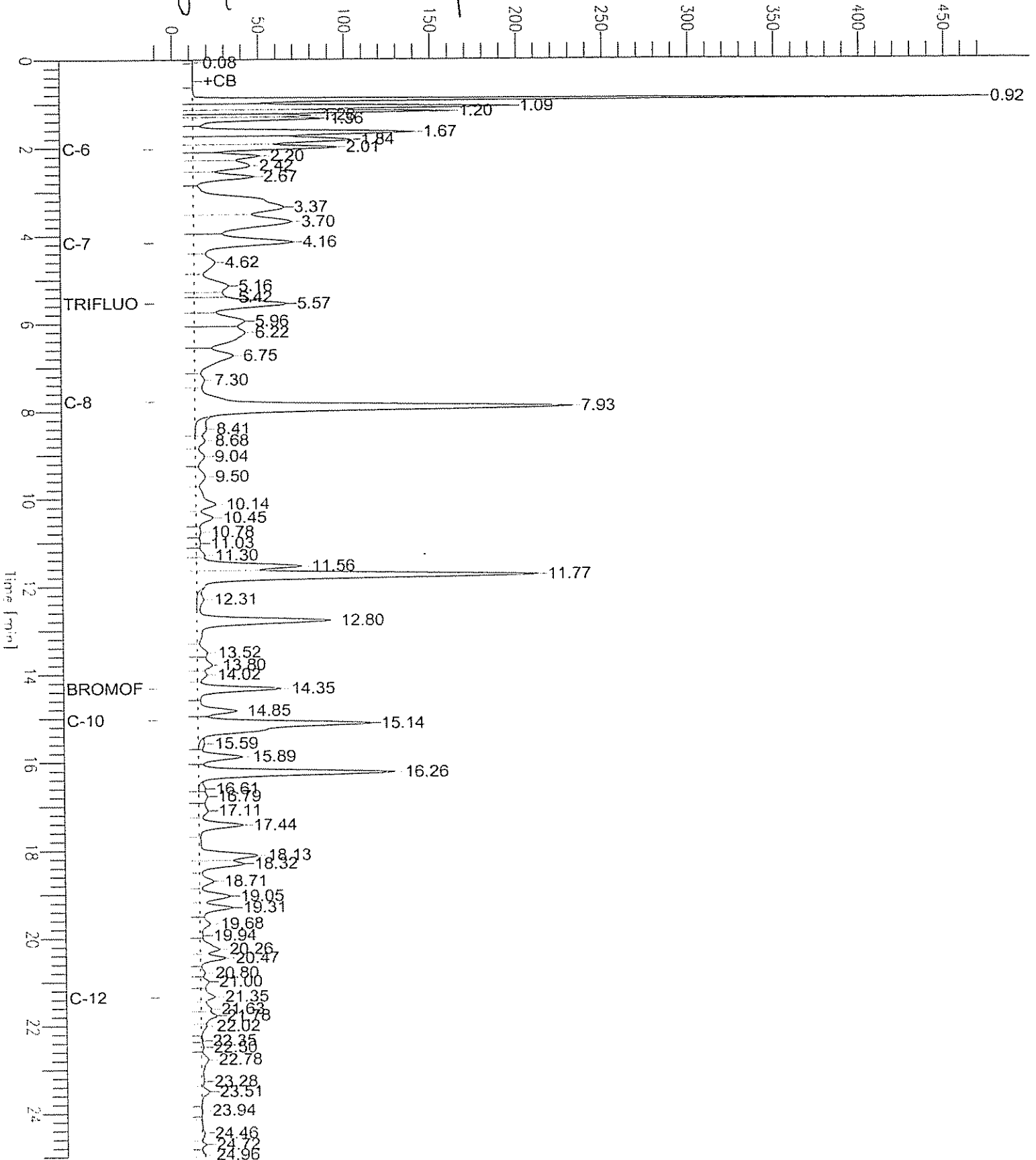



Curtis & Tompkins Laboratories Analytical Report

Lab #:	185290	Location:	Sausage Factory
Client:	Clayton Group Services	Prep:	EPA 5030B
Project#:	70-04578.00		
Matrix:	Water	Sampled:	03/02/06
Units:	uq/L	Received:	03/03/06

Type: BLANK
 Lab ID: QC330054
 Diln Fac: 1.000

Batch#: 110959
 Analyzed: 03/03/06

Analyte	Result	RL	Analysis
Gasoline C7-C12	ND	50	EPA 8015B
Benzene	ND	0.50	EPA 8021B
Toluene	ND	0.50	EPA 8021B
Ethylbenzene	ND	0.50	EPA 8021B
m,p-Xylenes	ND	0.50	EPA 8021B
o-Xylene	ND	0.50	EPA 8021B

Surrogate	%REC	Limits	Analysis
Trifluorotoluene (FID)	99	69-137	EPA 8015B
Bromofluorobenzene (FID)	94	80-133	EPA 8015B
Trifluorotoluene (PID)	81	64-132	EPA 8021B
Bromofluorobenzene (PID)	80	80-120	EPA 8021B

Type: BLANK
 Lab ID: QC330219
 Diln Fac: 1.000

Batch#: 111004
 Analyzed: 03/05/06

Analyte	Result	RL	Analysis
Gasoline C7-C12	ND	50	EPA 8015B
Benzene	ND	0.50	EPA 8021B
Toluene	ND	0.50	EPA 8021B
Ethylbenzene	ND	0.50	EPA 8021B
m,p-Xylenes	ND	0.50	EPA 8021B
o-Xylene	ND	0.50	EPA 8021B

Surrogate	%REC	Limits	Analysis
Trifluorotoluene (FID)	104	69-137	EPA 8015B
Bromofluorobenzene (FID)	100	80-133	EPA 8015B
Trifluorotoluene (PID)	89	64-132	EPA 8021B
Bromofluorobenzene (PID)	86	80-120	EPA 8021B

C= Presence confirmed, but RPD between columns exceeds 40%

L= Lighter hydrocarbons contributed to the quantitation

Y= Sample exhibits chromatographic pattern which does not resemble standard

Z= Sample exhibits unknown single peak or peaks

ND= Not Detected

RL= Reporting Limit

Curtis & Tompkins Laboratories Analytical Report

Lab #:	185290	Location:	Sausage Factory
Client:	Clayton Group Services	Prep:	EPA 5030B
Project#:	70-04578.00		
Matrix:	Water	Sampled:	03/02/06
Units:	ug/L	Received:	03/03/06

Type: BLANK
 Lab ID: QC330265
 Diln Fac: 1.000

Batch#: 111015
 Analyzed: 03/06/06

Analyte	Result	RL	Analysis
Gasoline C7-C12	ND	50	EPA 8015B
Benzene	ND	0.50	EPA 8021B
Toluene	ND	0.50	EPA 8021B
Ethylbenzene	ND	0.50	EPA 8021B
m, p-Xylenes	ND	0.50	EPA 8021B
o-Xylene	ND	0.50	EPA 8021B

Surrogate	%REC	Limits	Analysis
Trifluorotoluene (FID)	104	69-137	EPA 8015B
Bromofluorobenzene (FID)	98	80-133	EPA 8015B
Trifluorotoluene (PID)	87	64-132	EPA 8021B
Bromofluorobenzene (PID)	85	80-120	EPA 8021B

C= Presence confirmed, but RPD between columns exceeds 40%
 L= Lighter hydrocarbons contributed to the quantitation
 Y= Sample exhibits chromatographic pattern which does not resemble standard
 Z= Sample exhibits unknown single peak or peaks
 ND= Not Detected
 RL= Reporting Limit



Batch QC Report

Curtis & Tompkins Laboratories Analytical Report			
Lab #:	185290	Location:	Sausage Factory
Client:	Clayton Group Services	Prep:	EPA 5030B
Project#:	70-04578.00	Analysis:	EPA 8021B
Type:	LCS	Diln Fac:	1.000
Lab ID:	QC330055	Batch#:	110959
Matrix:	Water	Analyzed:	03/03/06
Units:	ug/L		

Analyte	Spiked	Result	%REC	Limits
Benzene	20.00	18.55	93	80-120
Toluene	20.00	19.23	96	80-120
Ethylbenzene	20.00	19.21	96	80-120
m,p-Xylenes	20.00	19.79	99	80-120
o-Xylene	20.00	19.66	98	80-120

Surrogate	%REC	Limits
Trifluorotoluene (PID)	82	64-132
Bromofluorobenzene (PID)	80	80-120

Batch QC Report

Curtis & Tompkins Laboratories Analytical Report			
Lab #:	185290	Location:	Sausage Factory
Client:	Clayton Group Services	Prep:	EPA 5030B
Project#:	70-04578.00	Analysis:	EPA 8015B
Type:	LCS	Diln Fac:	1.000
Lab ID:	QC330056	Batch#:	110959
Matrix:	Water	Analyzed:	03/03/06
Units:	ug/L		

Analyte	Spiked	Result	%REC	Limits
Gasoline C7-C12	2,000	2,028	101	80-120

Surrogate	%REC	Limits
Trifluorotoluene (FID)	124	69-137
Bromofluorobenzene (FID)	106	80-133

Batch QC Report

Curtis & Tompkins Laboratories Analytical Report

Lab #:	185290	Location:	Sausage Factory
Client:	Clayton Group Services	Prep:	EPA 5030B
Project#:	70-04578.00	Analysis:	EPA 8021B
Type:	LCS	Diln Fac:	1.000
Lab ID:	QC330220	Batch#:	111004
Matrix:	Water	Analyzed:	03/05/06
Units:	ug/L		

Analyte	Spiked	Result	%REC	Limits
Benzene	20.00	18.83	94	80-120
Toluene	20.00	19.59	98	80-120
Ethylbenzene	20.00	19.86	99	80-120
m,p-Xylenes	20.00	19.49	97	80-120
o-Xylene	20.00	19.74	99	80-120

Surrogate	%REC	Limits
Trifluorotoluene (PID)	84	64-132
Bromofluorobenzene (PID)	84	80-120



Batch QC Report

Curtis & Tompkins Laboratories Analytical Report			
Lab #:	185290	Location:	Sausage Factory
Client:	Clayton Group Services	Prep:	EPA 5030B
Project#:	70-04578.00	Analysis:	EPA 8015B
Type:	LCS	Diln Fac:	1.000
Lab ID:	QC330221	Batch#:	111004
Matrix:	Water	Analyzed:	03/05/06
Units:	ug/L		

Analyte	Spiked	Result	%REC	Limits
Gasoline C7-C12	2,000	1,937	97	80-120

Surrogate	%REC	Limits
Trifluorotoluene (FID)	119	69-137
Bromofluorobenzene (FID)	108	80-133



Batch QC Report

Curtis & Tompkins Laboratories Analytical Report			
Lab #:	185290	Location:	Sausage Factory
Client:	Clayton Group Services	Prep:	EPA 5030B
Project#:	70-04578.00	Analysis:	EPA 8021B
Type:	LCS	Diln Fac:	1.000
Lab ID:	QC330266	Batch#:	111015
Matrix:	Water	Analyzed:	03/06/06
Units:	ug/L		

Analyte	Spiked	Result	%REC	Limits
Benzene	20.00	20.10	101	80-120
Toluene	20.00	21.04	105	80-120
Ethylbenzene	20.00	21.77	109	80-120
m,p-Xylenes	20.00	20.80	104	80-120
o-Xylene	20.00	21.24	106	80-120

Surrogate	%REC	Limits
Trifluorotoluene (PID)	89	64-132
Bromofluorobenzene (PID)	90	80-120

Batch QC Report

Curtis & Tompkins Laboratories Analytical Report

Lab #:	185290	Location:	Sausage Factory
Client:	Clayton Group Services	Prep:	EPA 5030B
Project#:	70-04578.00	Analysis:	EPA 8015B
Type:	LCS	Diln Fac:	1.000
Lab ID:	QC330267	Batch#:	111015
Matrix:	Water	Analyzed:	03/06/06
Units:	ug/L		

Analyte	Spiked	Result	%REC	Limits
Gasoline C7-C12	2,000	1,966	98	80-120

Surrogate	%REC	Limits
Trifluorotoluene (FID)	119	69-137
Bromofluorobenzene (FID)	114	80-133

Batch QC Report

Curtis & Tompkins Laboratories Analytical Report			
Lab #:	185290	Location:	Sausage Factory
Client:	Clayton Group Services	Prep:	EPA 5030B
Project#:	70-04578.00	Analysis:	EPA 8015B
Field ID:	ZZZZZZZZZZ	Batch#:	110959
MSS Lab ID:	185279-001	Sampled:	03/02/06
Matrix:	Water	Received:	03/02/06
Units:	ug/L	Analyzed:	03/03/06
Diln Fac:	1.000		

Type: MS Lab ID: QC330057

Analyte	MSS Result	Spiked	Result	%REC	Limits
Gasoline C7-C12	13.62	2,000	1,968	98	80-120

Surrogate	%REC	Limits
Trifluorotoluene (FID)	129	69-137
Bromofluorobenzene (FID)	115	80-133

Type: MSD Lab ID: QC330058

Analyte	Spiked	Result	%REC	Limits	RPD	Lim
Gasoline C7-C12	2,000	1,967	98	80-120	0	20

Surrogate	%REC	Limits
Trifluorotoluene (FID)	120	69-137
Bromofluorobenzene (FID)	106	80-133

Batch QC Report

Curtis & Tompkins Laboratories Analytical Report			
Lab #:	185290	Location:	Sausage Factory
Client:	Clayton Group Services	Prep:	EPA 5030B
Project#:	70-04578.00	Analysis:	EPA 8015B
Field ID:	ZZZZZZZZZZ	Batch#:	111004
MSS Lab ID:	185299-002	Sampled:	03/03/06
Matrix:	Water	Received:	03/03/06
Units:	ug/L	Analyzed:	03/05/06
Diln Fac:	1.000		

Type: MS Lab ID: QC330235

Analyte	MSS Result	Spiked	Result	%REC	Limits
Gasoline C7-C12	15.25	2,000	1,952	97	80-120

Surrogate	%REC	Limits
Trifluorotoluene (FID)	129	69-137
Bromofluorobenzene (FID)	111	80-133

Type: MSD Lab ID: QC330236

Analyte	Spiked	Result	%REC	Limits	RPD	Lim
Gasoline C7-C12	2,000	1,982	98	80-120	2	20

Surrogate	%REC	Limits
Trifluorotoluene (FID)	124	69-137
Bromofluorobenzene (FID)	112	80-133

Batch QC Report

Curtis & Tompkins Laboratories Analytical Report			
Lab #:	185290	Location:	Sausage Factory
Client:	Clayton Group Services	Prep:	EPA 5030B
Project#:	70-04578.00	Analysis:	EPA 8015B
Field ID:	ZZZZZZZZZZ	Batch#:	111015
MSS Lab ID:	185329-001	Sampled:	03/06/06
Matrix:	Water	Received:	03/06/06
Units:	ug/L	Analyzed:	03/06/06
Diln Fac:	1.000		

Type: MS Lab ID: QC330339

Analyte	MSS Result	Spiked	Result	%REC	Limits
Gasoline C7-C12	17.39	2,000	1,849	92	80-120

Surrogate	%REC	Limits
Trifluorotoluene (FID)	114	69-137
Bromofluorobenzene (FID)	110	80-133

Type: MSD Lab ID: QC330340

Analyte	Spiked	Result	%REC	Limits	RPD	Lim
Gasoline C7-C12	2,000	1,978	98	80-120	7	20

Surrogate	%REC	Limits
Trifluorotoluene (FID)	115	69-137
Bromofluorobenzene (FID)	112	80-133

Purgeable Halocarbons by GC/MS

Lab #:	185290	Location:	Sausage Factory
Client:	Clayton Group Services	Prep:	EPA 5030B
Project#:	70-04578.00	Analysis:	EPA 8260B
Field ID:	MW-01	Batch#:	110978
Lab ID:	185290-001	Sampled:	03/02/06
Matrix:	Water	Received:	03/03/06
Units:	ug/L	Analyzed:	03/03/06
Diln Fac:	7.143		

Analyte	Result	RL
Chloromethane	ND	7.1
Vinyl Chloride	ND	3.6
Bromomethane	ND	7.1
Chloroethane	ND	7.1
Trichlorofluoromethane	ND	7.1
Freon 113	ND	3.6
1,1-Dichloroethene	ND	3.6
Methylene Chloride	ND	140
trans-1,2-Dichloroethene	ND	3.6
1,1-Dichloroethane	ND	3.6
cis-1,2-Dichloroethene	ND	3.6
Chloroform	ND	7.1
1,1,1-Trichloroethane	ND	3.6
Carbon Tetrachloride	ND	3.6
1,2-Dichloroethane	ND	3.6
Trichloroethene	ND	3.6
1,2-Dichloropropane	ND	3.6
Bromodichloromethane	ND	3.6
cis-1,3-Dichloropropene	ND	3.6
trans-1,3-Dichloropropene	ND	3.6
1,1,2-Trichloroethane	ND	3.6
Tetrachloroethene	ND	3.6
Dibromochloromethane	ND	3.6
Chlorobenzene	ND	3.6
Bromoform	ND	3.6
1,1,2,2-Tetrachloroethane	ND	3.6
1,3-Dichlorobenzene	ND	3.6
1,4-Dichlorobenzene	ND	3.6
1,2-Dichlorobenzene	ND	3.6

Surrogate	%REC	Limits
1,2-Dichloroethane-d4	105	80-130
Toluene-d8	96	80-120
Bromofluorobenzene	98	80-122

ND= Not Detected
 RL= Reporting Limit

Purgeable Halocarbons by GC/MS

Lab #:	185290	Location:	Sausage Factory
Client:	Clayton Group Services	Prep:	EPA 5030B
Project#:	70-04578.00	Analysis:	EPA 8260B
Field ID:	MW-02	Batch#:	110978
Lab ID:	185290-002	Sampled:	03/02/06
Matrix:	Water	Received:	03/03/06
Units:	ug/L	Analyzed:	03/03/06
Diln Fac:	14.29		

Analyte	Result	RL
Chloromethane	ND	14
Vinyl Chloride	ND	7.1
Bromomethane	ND	14
Chloroethane	ND	14
Trichlorofluoromethane	ND	14
Freon 113	ND	7.1
1,1-Dichloroethene	ND	7.1
Methylene Chloride	ND	290
trans-1,2-Dichloroethene	ND	7.1
1,1-Dichloroethane	ND	7.1
cis-1,2-Dichloroethene	ND	7.1
Chloroform	ND	14
1,1,1-Trichloroethane	ND	7.1
Carbon Tetrachloride	ND	7.1
1,2-Dichloroethane	ND	7.1
Trichloroethene	ND	7.1
1,2-Dichloropropane	ND	7.1
Bromodichloromethane	ND	7.1
cis-1,3-Dichloropropene	ND	7.1
trans-1,3-Dichloropropene	ND	7.1
1,1,2-Trichloroethane	ND	7.1
Tetrachloroethene	ND	7.1
Dibromochloromethane	ND	7.1
Chlorobenzene	ND	7.1
Bromoform	ND	7.1
1,1,2,2-Tetrachloroethane	ND	7.1
1,3-Dichlorobenzene	ND	7.1
1,4-Dichlorobenzene	ND	7.1
1,2-Dichlorobenzene	ND	7.1

Surrogate	%REC	Limits
1,2-Dichloroethane-d4	105	80-130
Toluene-d8	99	80-120
Bromofluorobenzene	100	80-122

Purgeable Halocarbons by GC/MS

Lab #:	185290	Location:	Sausage Factory
Client:	Clayton Group Services	Prep:	EPA 5030B
Project#:	70-04578.00	Analysis:	EPA 8260B
Field ID:	MW-06	Batch#:	110978
Lab ID:	185290-003	Sampled:	03/02/06
Matrix:	Water	Received:	03/03/06
Units:	ug/L	Analyzed:	03/03/06
Diln Fac:	1.000		

Analyte	Result	RL
Chloromethane	ND	1.0
Vinyl Chloride	ND	0.5
Bromomethane	ND	1.0
Chloroethane	ND	1.0
Trichlorofluoromethane	ND	1.0
Freon 113	ND	0.5
1,1-Dichloroethene	ND	0.5
Methylene Chloride	ND	20
trans-1,2-Dichloroethene	ND	0.5
1,1-Dichloroethane	ND	0.5
cis-1,2-Dichloroethene	ND	0.5
Chloroform	ND	1.0
1,1,1-Trichloroethane	ND	0.5
Carbon Tetrachloride	ND	0.5
1,2-Dichloroethane	ND	0.5
Trichloroethene	ND	0.5
1,2-Dichloropropane	ND	0.5
Bromodichloromethane	ND	0.5
cis-1,3-Dichloropropene	ND	0.5
trans-1,3-Dichloropropene	ND	0.5
1,1,2-Trichloroethane	ND	0.5
Tetrachloroethene	ND	0.5
Dibromochloromethane	ND	0.5
Chlorobenzene	ND	0.5
Bromoform	ND	0.5
1,1,2,2-Tetrachloroethane	ND	0.5
1,3-Dichlorobenzene	ND	0.5
1,4-Dichlorobenzene	ND	0.5
1,2-Dichlorobenzene	ND	0.5

Surrogate	%REC	Limits
1,2-Dichloroethane-d4	117	80-130
Toluene-d8	96	80-120
Bromofluorobenzene	105	80-122

ND= Not Detected
 RL= Reporting Limit
 Page 1 of 1

Purgeable Halocarbons by GC/MS

Lab #:	185290	Location:	Sausage Factory
Client:	Clayton Group Services	Prep:	EPA 5030B
Project#:	70-04578.00	Analysis:	EPA 8260B
Field ID:	MW-07	Batch#:	110978
Lab ID:	185290-004	Sampled:	03/02/06
Matrix:	Water	Received:	03/03/06
Units:	ug/L	Analyzed:	03/03/06
Diln Fac:	1.000		

Analyte	Result	RL
Chloromethane	ND	1.0
Vinyl Chloride	ND	0.5
Bromomethane	ND	1.0
Chloroethane	ND	1.0
Trichlorofluoromethane	ND	1.0
Freon 113	ND	0.5
1,1-Dichloroethene	ND	0.5
Methylene Chloride	ND	20
trans-1,2-Dichloroethene	ND	0.5
1,1-Dichloroethane	ND	0.5
cis-1,2-Dichloroethene	ND	0.5
Chloroform	ND	1.0
1,1,1-Trichloroethane	ND	0.5
Carbon Tetrachloride	ND	0.5
1,2-Dichloroethane	ND	0.5
Trichloroethene	ND	0.5
1,2-Dichloropropane	ND	0.5
Bromodichloromethane	ND	0.5
cis-1,3-Dichloropropene	ND	0.5
trans-1,3-Dichloropropene	ND	0.5
1,1,2-Trichloroethane	ND	0.5
Tetrachloroethene	ND	0.5
Dibromochloromethane	ND	0.5
Chlorobenzene	ND	0.5
Bromoform	ND	0.5
1,1,2,2-Tetrachloroethane	ND	0.5
1,3-Dichlorobenzene	ND	0.5
1,4-Dichlorobenzene	ND	0.5
1,2-Dichlorobenzene	ND	0.5

Surrogate	%REC	Limits
1,2-Dichloroethane-d4	120	80-130
Toluene-d8	98	80-120
Bromofluorobenzene	107	80-122

ND= Not Detected
 RL= Reporting Limit
 Page 1 of 1

Purgeable Halocarbons by GC/MS

Lab #:	185290	Location:	Sausage Factory
Client:	Clayton Group Services	Prep:	EPA 5030B
Project#:	70-04578.00	Analysis:	EPA 8260B
Field ID:	MW-08	Batch#:	110978
Lab ID:	185290-005	Sampled:	03/02/06
Matrix:	Water	Received:	03/03/06
Units:	ug/L	Analyzed:	03/04/06
Diln Fac:	12.50		

Analyte	Result	RL
Chloromethane	ND	13
Vinyl Chloride	50	6.3
Bromomethane	ND	13
Chloroethane	ND	13
Trichlorofluoromethane	ND	13
Freon 113	ND	6.3
1,1-Dichloroethene	ND	6.3
Methylene Chloride	ND	250
trans-1,2-Dichloroethene	34	6.3
1,1-Dichloroethane	ND	6.3
cis-1,2-Dichloroethene	890	6.3
Chloroform	ND	13
1,1,1-Trichloroethane	ND	6.3
Carbon Tetrachloride	ND	6.3
1,2-Dichloroethane	ND	6.3
Trichloroethene	ND	6.3
1,2-Dichloropropane	ND	6.3
Bromodichloromethane	ND	6.3
cis-1,3-Dichloropropene	ND	6.3
trans-1,3-Dichloropropene	ND	6.3
1,1,2-Trichloroethane	ND	6.3
Tetrachloroethene	ND	6.3
Dibromochloromethane	ND	6.3
Chlorobenzene	ND	6.3
Bromoform	ND	6.3
1,1,2,2-Tetrachloroethane	ND	6.3
1,3-Dichlorobenzene	ND	6.3
1,4-Dichlorobenzene	ND	6.3
1,2-Dichlorobenzene	ND	6.3

Surrogate	%REC	Limits
1,2-Dichloroethane-d4	112	80-130
Toluene-d8	101	80-120
Bromofluorobenzene	104	80-122

ND= Not Detected
 RL= Reporting Limit
 Page 1 of 1

Purgeable Halocarbons by GC/MS

Lab #:	185290	Location:	Sausage Factory
Client:	Clayton Group Services	Prep:	EPA 5030B
Project#:	70-04578.00	Analysis:	EPA 8260B
Field ID:	MW-09	Batch#:	110978
Lab ID:	185290-006	Sampled:	03/02/06
Matrix:	Water	Received:	03/03/06
Units:	ug/L	Analyzed:	03/04/06
Diln Fac:	40.00		

Analyte	Result	RL
Chloromethane	ND	40
Vinyl Chloride	ND	20
Bromomethane	ND	40
Chloroethane	ND	40
Trichlorofluoromethane	ND	40
Freon 113	ND	20
1,1-Dichloroethene	ND	20
Methylene Chloride	ND	800
trans-1,2-Dichloroethene	ND	20
1,1-Dichloroethane	ND	20
cis-1,2-Dichloroethene	ND	20
Chloroform	ND	40
1,1,1-Trichloroethane	ND	20
Carbon Tetrachloride	ND	20
1,2-Dichloroethane	ND	20
Trichloroethene	ND	20
1,2-Dichloropropane	ND	20
Bromodichloromethane	ND	20
cis-1,3-Dichloropropene	ND	20
trans-1,3-Dichloropropene	ND	20
1,1,2-Trichloroethane	ND	20
Tetrachloroethene	ND	20
Dibromochloromethane	ND	20
Chlorobenzene	ND	20
Bromoform	ND	20
1,1,2,2-Tetrachloroethane	ND	20
1,3-Dichlorobenzene	ND	20
1,4-Dichlorobenzene	ND	20
1,2-Dichlorobenzene	ND	20

Surrogate	%REC	Limits
1,2-Dichloroethane-d4	106	80-130
Toluene-d8	97	80-120
Bromofluorobenzene	96	80-122

Purgeable Halocarbons by GC/MS

Lab #:	185290	Location:	Sausage Factory
Client:	Clayton Group Services	Prep:	EPA 5030B
Project#:	70-04578.00	Analysis:	EPA 8260B
Field ID:	MW-10	Batch#:	110978
Lab ID:	185290-007	Sampled:	03/02/06
Matrix:	Water	Received:	03/03/06
Units:	ug/L	Analyzed:	03/03/06
Diln Fac:	1.000		

Analyte	Result	RL
Chloromethane	ND	1.0
Vinyl Chloride	ND	0.5
Bromomethane	ND	1.0
Chloroethane	ND	1.0
Trichlorofluoromethane	ND	1.0
Freon 113	ND	0.5
1,1-Dichloroethene	ND	0.5
Methylene Chloride	ND	20
trans-1,2-Dichloroethene	ND	0.5
1,1-Dichloroethane	ND	0.5
cis-1,2-Dichloroethene	ND	0.5
Chloroform	ND	1.0
1,1,1-Trichloroethane	ND	0.5
Carbon Tetrachloride	ND	0.5
1,2-Dichloroethane	ND	0.5
Trichloroethene	ND	0.5
1,2-Dichloropropane	ND	0.5
Bromodichloromethane	ND	0.5
cis-1,3-Dichloropropene	ND	0.5
trans-1,3-Dichloropropene	ND	0.5
1,1,2-Trichloroethane	ND	0.5
Tetrachloroethene	ND	0.5
Dibromochloromethane	ND	0.5
Chlorobenzene	ND	0.5
Bromoform	ND	0.5
1,1,2,2-Tetrachloroethane	ND	0.5
1,3-Dichlorobenzene	ND	0.5
1,4-Dichlorobenzene	ND	0.5
1,2-Dichlorobenzene	ND	0.5

Surrogate	%REC	Limits
1,2-Dichloroethane-d4	127	80-130
Toluene-d8	99	80-120
Bromofluorobenzene	105	80-122

Purgeable Halocarbons by GC/MS

Lab #:	185290	Location:	Sausage Factory
Client:	Clayton Group Services	Prep:	EPA 5030B
Project#:	70-04578.00	Analysis:	EPA 8260B
Field ID:	MW-11	Batch#:	110978
Lab ID:	185290-008	Sampled:	03/02/06
Matrix:	Water	Received:	03/03/06
Units:	ug/L	Analyzed:	03/03/06
Diln Fac:	1.000		

Analyte	Result	RL
Chloromethane	ND	1.0
Vinyl Chloride	ND	0.5
Bromomethane	ND	1.0
Chloroethane	ND	1.0
Trichlorofluoromethane	ND	1.0
Freon 113	ND	0.5
1,1-Dichloroethene	ND	0.5
Methylene Chloride	ND	20
trans-1,2-Dichloroethene	ND	0.5
1,1-Dichloroethane	ND	0.5
cis-1,2-Dichloroethene	ND	0.5
Chloroform	ND	1.0
1,1,1-Trichloroethane	ND	0.5
Carbon Tetrachloride	ND	0.5
1,2-Dichloroethane	ND	0.5
Trichloroethene	ND	0.5
1,2-Dichloropropane	ND	0.5
Bromodichloromethane	ND	0.5
cis-1,3-Dichloropropene	ND	0.5
trans-1,3-Dichloropropene	ND	0.5
1,1,2-Trichloroethane	ND	0.5
Tetrachloroethene	ND	0.5
Dibromochloromethane	ND	0.5
Chlorobenzene	ND	0.5
Bromoform	ND	0.5
1,1,2,2-Tetrachloroethane	ND	0.5
1,3-Dichlorobenzene	ND	0.5
1,4-Dichlorobenzene	ND	0.5
1,2-Dichlorobenzene	ND	0.5

Surrogate	%REC	Limits
1,2-Dichloroethane-d4	127	80-130
Toluene-d8	101	80-120
Bromofluorobenzene	107	80-122

Purgeable Halocarbons by GC/MS

Lab #:	185290	Location:	Sausage Factory
Client:	Clayton Group Services	Prep:	EPA 5030B
Project#:	70-04578.00	Analysis:	EPA 8260B
Field ID:	MW-12	Batch#:	111052
Lab ID:	185290-009	Sampled:	03/02/06
Matrix:	Water	Received:	03/03/06
Units:	ug/L	Analyzed:	03/07/06
Diln Fac:	1.667		

Analyte	Result	RL
Chloromethane	ND	1.7
Vinyl Chloride	ND	0.8
Bromomethane	ND	1.7
Chloroethane	ND	1.7
Trichlorofluoromethane	ND	1.7
Freon 113	ND	0.8
1,1-Dichloroethene	ND	0.8
Methylene Chloride	ND	33
trans-1,2-Dichloroethene	31	0.8
1,1-Dichloroethane	ND	0.8
cis-1,2-Dichloroethene	27	0.8
Chloroform	ND	1.7
1,1,1-Trichloroethane	ND	0.8
Carbon Tetrachloride	ND	0.8
1,2-Dichloroethane	ND	0.8
Trichloroethene	84	0.8
1,2-Dichloropropane	ND	0.8
Bromodichloromethane	ND	0.8
cis-1,3-Dichloropropene	ND	0.8
trans-1,3-Dichloropropene	ND	0.8
1,1,2-Trichloroethane	ND	0.8
Tetrachloroethene	ND	0.8
Dibromochloromethane	ND	0.8
Chlorobenzene	ND	0.8
Bromoform	ND	0.8
1,1,2,2-Tetrachloroethane	ND	0.8
1,3-Dichlorobenzene	ND	0.8
1,4-Dichlorobenzene	ND	0.8
1,2-Dichlorobenzene	ND	0.8

Surrogate	%REC	Limits
1,2-Dichloroethane-d4	96	80-130
Toluene-d8	97	80-120
Bromofluorobenzene	109	80-122

ND= Not Detected
 RL= Reporting Limit

Purgeable Halocarbons by GC/MS

Lab #:	185290	Location:	Sausage Factory
Client:	Clayton Group Services	Prep:	EPA 5030B
Project#:	70-04578.00	Analysis:	EPA 8260B
Field ID:	MW-13	Batch#:	111052
Lab ID:	185290-010	Sampled:	03/02/06
Matrix:	Water	Received:	03/03/06
Units:	ug/L	Analyzed:	03/07/06
Diln Fac:	1.667		

Analyte	Result	RL
Chloromethane	ND	1.7
Vinyl Chloride	16	0.8
Bromomethane	ND	1.7
Chloroethane	ND	1.7
Trichlorofluoromethane	ND	1.7
Freon 113	ND	0.8
1,1-Dichloroethene	ND	0.8
Methylene Chloride	ND	33
trans-1,2-Dichloroethene	32	0.8
1,1-Dichloroethane	ND	0.8
cis-1,2-Dichloroethene	110	0.8
Chloroform	ND	1.7
1,1,1-Trichloroethane	ND	0.8
Carbon Tetrachloride	ND	0.8
1,2-Dichloroethane	ND	0.8
Trichloroethene	43	0.8
1,2-Dichloropropane	ND	0.8
Bromodichloromethane	ND	0.8
cis-1,3-Dichloropropene	ND	0.8
trans-1,3-Dichloropropene	ND	0.8
1,1,2-Trichloroethane	ND	0.8
Tetrachloroethene	ND	0.8
Dibromochloromethane	ND	0.8
Chlorobenzene	ND	0.8
Bromoform	ND	0.8
1,1,2,2-Tetrachloroethane	ND	0.8
1,3-Dichlorobenzene	ND	0.8
1,4-Dichlorobenzene	ND	0.8
1,2-Dichlorobenzene	ND	0.8

Surrogate	%REC	Limits
1,2-Dichloroethane-d4	97	80-130
Toluene-d8	97	80-120
Bromofluorobenzene	102	80-122

Batch QC Report

Purgeable Halocarbons by GC/MS			
Lab #:	185290	Location:	Sausage Factory
Client:	Clayton Group Services	Prep:	EPA 5030B
Project#:	70-04578.00	Analysis:	EPA 8260B
Type:	BLANK	Diln Fac:	1.000
Lab ID:	QC330138	Batch#:	110978
Matrix:	Water	Analyzed:	03/03/06
Units:	ug/L		

Analyte	Result	RL
Chloromethane	ND	1.0
Vinyl Chloride	ND	0.5
Bromomethane	ND	1.0
Chloroethane	ND	1.0
Trichlorofluoromethane	ND	1.0
Freon 113	ND	0.5
1,1-Dichloroethene	ND	0.5
Methylene Chloride	ND	20
trans-1,2-Dichloroethene	ND	0.5
1,1-Dichloroethane	ND	0.5
cis-1,2-Dichloroethene	ND	0.5
Chloroform	ND	1.0
1,1,1-Trichloroethane	ND	0.5
Carbon Tetrachloride	ND	0.5
1,2-Dichloroethane	ND	0.5
Trichloroethene	ND	0.5
1,2-Dichloropropane	ND	0.5
Bromodichloromethane	ND	0.5
cis-1,3-Dichloropropene	ND	0.5
trans-1,3-Dichloropropene	ND	0.5
1,1,2-Trichloroethane	ND	0.5
Tetrachloroethene	ND	0.5
Dibromochloromethane	ND	0.5
Chlorobenzene	ND	0.5
Bromoform	ND	0.5
1,1,2,2-Tetrachloroethane	ND	0.5
1,3-Dichlorobenzene	ND	0.5
1,4-Dichlorobenzene	ND	0.5
1,2-Dichlorobenzene	ND	0.5

Surrogate	%REC	Limits
1,2-Dichloroethane-d4	117	80-130
Toluene-d8	97	80-120
Bromofluorobenzene	106	80-122

Batch QC Report

Purgeable Halocarbons by GC/MS			
Lab #:	185290	Location:	Sausage Factory
Client:	Clayton Group Services	Prep:	EPA 5030B
Project#:	70-04578.00	Analysis:	EPA 8260B
Type:	BLANK	Diln Fac:	1.000
Lab ID:	QC330418	Batch#:	111052
Matrix:	Water	Analyzed:	03/07/06
Units:	ug/L		

Analyte	Result	RL
Chloromethane	ND	1.0
Vinyl Chloride	ND	0.5
Bromomethane	ND	1.0
Chloroethane	ND	1.0
Trichlorofluoromethane	ND	1.0
Freon 113	ND	0.5
1,1-Dichloroethene	ND	0.5
Methylene Chloride	ND	20
trans-1,2-Dichloroethene	ND	0.5
1,1-Dichloroethane	ND	0.5
cis-1,2-Dichloroethene	ND	0.5
Chloroform	ND	1.0
1,1,1-Trichloroethane	ND	0.5
Carbon Tetrachloride	ND	0.5
1,2-Dichloroethane	ND	0.5
Trichloroethene	ND	0.5
1,2-Dichloropropane	ND	0.5
Bromodichloromethane	ND	0.5
cis-1,3-Dichloropropene	ND	0.5
trans-1,3-Dichloropropene	ND	0.5
1,1,2-Trichloroethane	ND	0.5
Tetrachloroethene	ND	0.5
Dibromochloromethane	ND	0.5
Chlorobenzene	ND	0.5
Bromoform	ND	0.5
1,1,2,2-Tetrachloroethane	ND	0.5
1,3-Dichlorobenzene	ND	0.5
1,4-Dichlorobenzene	ND	0.5
1,2-Dichlorobenzene	ND	0.5

Surrogate	%REC	Limits
1,2-Dichloroethane-d4	98	80-130
Toluene-d8	95	80-120
Bromofluorobenzene	110	80-122

Batch QC Report

Purgeable Halocarbons by GC/MS			
Lab #:	185290	Location:	Sausage Factory
Client:	Clayton Group Services	Prep:	EPA 5030B
Project#:	70-04578.00	Analysis:	EPA 8260B
Type:	LCS	Diln Fac:	1.000
Lab ID:	QC330139	Batch#:	110978
Matrix:	Water	Analyzed:	03/03/06
Units:	ug/L		

Analyte	Spiked	Result	%REC	Limits
1,1-Dichloroethene	25.00	27.46	110	77-128
Trichloroethene	25.00	28.69	115	80-120
Chlorobenzene	25.00	27.76	111	80-120

Surrogate	%REC	Limits
1,2-Dichloroethane-d4	112	80-130
Toluene-d8	101	80-120
Bromofluorobenzene	94	80-122

Batch QC Report

Purgeable Halocarbons by GC/MS			
Lab #:	185290	Location:	Sausage Factory
Client:	Clayton Group Services	Prep:	EPA 5030B
Project#:	70-04578.00	Analysis:	EPA 8260B
Matrix:	Water	Batch#:	111052
Units:	ug/L	Analyzed:	03/07/06
Diln Fac:	1.000		

Type: BS Lab ID: QC330416

Analyte	Spiked	Result	%REC	Limits
1,1-Dichloroethene	25.00	26.46	106	77-128
Trichloroethene	25.00	22.32	89	80-120
Chlorobenzene	25.00	22.83	91	80-120

Surrogate	%REC	Limits
1,2-Dichloroethane-d4	94	80-130
Toluene-d8	96	80-120
Bromofluorobenzene	103	80-122

Type: BSD Lab ID: QC330417

Analyte	Spiked	Result	%REC	Limits	RPD	Lim
1,1-Dichloroethene	25.00	27.18	109	77-128	3	20
Trichloroethene	25.00	24.38	98	80-120	9	20
Chlorobenzene	25.00	24.17	97	80-120	6	20

Surrogate	%REC	Limits
1,2-Dichloroethane-d4	94	80-130
Toluene-d8	96	80-120
Bromofluorobenzene	102	80-122

RPD= Relative Percent Difference

Batch QC Report

Purgeable Halocarbons by GC/MS			
Lab #:	185290	Location:	Sausage Factory
Client:	Clayton Group Services	Prep:	EPA 5030B
Project#:	70-04578.00	Analysis:	EPA 8260B
Field ID:	ZZZZZZZZZZ	Batch#:	110978
MSS Lab ID:	185157-010	Sampled:	02/23/06
Matrix:	Water	Received:	02/24/06
Units:	ug/L	Analyzed:	03/04/06
Diln Fac:	142.9		

Type: MS Lab ID: QC330169

Analyte	MSS Result	Spiked	Result	%REC	Limits
1,1-Dichloroethene	<37.86	3,571	4,074	114	77-129
Trichloroethene	<29.30	3,571	4,165	117	77-123
Chlorobenzene	<14.35	3,571	3,970	111	80-120

Surrogate	%REC	Limits
1,2-Dichloroethane-d4	101	80-130
Toluene-d8	96	80-120
Bromofluorobenzene	102	80-122

Type: MSD Lab ID: QC330170

Analyte	Spiked	Result	%REC	Limits	RPD	Lim
1,1-Dichloroethene	3,571	3,981	111	77-129	2	20
Trichloroethene	3,571	3,901	109	77-123	7	20
Chlorobenzene	3,571	3,879	109	80-120	2	20

Surrogate	%REC	Limits
1,2-Dichloroethane-d4	98	80-130
Toluene-d8	96	80-120
Bromofluorobenzene	93	80-122

RPD= Relative Percent Difference



CHAIN OF CUSTODY

Lab: Curtis&Tompkins

TAT: Standard

185290

Report results to:

Name: Jeremy Wilson
 Company: Clayton Group Services
 Mailing Address: 6920 Koll Center Parkway, Ste. 216
 City, State, Zip: Pleasanton, California 94566
 Telephone No.: (925) 426-2600
 Fax No.: (925) 426-0106
 E-mail: jeremy.wilson@us.bureauveritas.com

Project Information

Project No.: 70-04578.00
 Name: Sausage Factory
 Location: 630 29th Avenue, Oakland
 Global_Id: T0600102114
 Log_code: CGSP

Special instructions and/or specific regulatory requirements:

Analyses Requested

	8021B for TPH-g/BTEX	8260B for HVOCs																
MW-01	X	X																
MW-02	X	X																
MW-06	X	X																
MW-07	X	X																
MW-08	X	X																
MW-09	X	X																
MW-10	X	X																
MW-11	X	X																
MW-12	X	X																
MW-13	X	X																

Sample Condition/Comments

Preservative

-1
-2
-3
-4
-5
-6
-7
-8
-9
-10

Sample Identification	Sample Date	Sample Time	Matrix/Media	No. of Conts.	8021B for TPH-g/BTEX	8260B for HVOCs																
MW-01	3-2-06	1257	GW	6	X	X															HCl	
MW-02		1235		6	X	X																HCl
MW-06		1523		6	X	X																HCl
MW-07		1742		6	X	X																HCl
MW-08		1334		6	X	X																HCl
MW-09		1414		6	X	X																HCl
MW-10		1445		6	X	X																HCl
MW-11		1715		6	X	X																HCl
MW-12		1636		6	X	X																HCl
MW-13		1604		6	X	X																HCl

Received
 On Ice
 Cold Ambient Intact

Collected by: Jeremy Wilson Date/Time 3-2-06 1800
 Relinquished by: [Signature] Date/Time 3-2-06 1950
 Relinquished by: _____ Date/Time _____
 Method of Shipment: _____

Collector's Signature: [Signature] Date/Time 3-2-06 1800
 Received by: [Signature] Date/Time 3/3/06 09:15
 Received by: _____ Date/Time _____
 Sample Condition on Rcpt: _____