

6920 Koll Center Parkway
Suite 216
Pleasanton, CA 94566
925.426.2600
Fax 925.426.0106

Alameda County

AUG 13 2004

Environmental Health



August 11, 2004

Mr. Amir Gholami
Hazardous Materials Specialists
ALAMEDA COUNTY ENVIROMENTAL HEALTH
1131 Harbor Bay Parkway, Suite 250
Alameda, California 94502-6577

RO 334
10/13/04
Amir

Clayton Project No.70-04578.00

Subject: Second Quarter 2004 Groundwater Monitoring Results for the property at
630 29th Avenue in Oakland, California

Dear Mr. Gholami:

Clayton is pleased to present the results for the Second Quarter 2004 groundwater
monitoring event performed at 630 29th Avenue in Oakland, California.

If you have any comments or questions regarding the report please contact Clayton at
(925) 426-2600.

Sincerely,

Mathew Reimer
Staff Environmental Consultant
Environmental Services

Donald A. Ashton
Senior Geologist
Environmental Services
San Francisco Regional Office

DAA/daa

cc: Bob Pender AIG Technical Services
Donna Profit Bank of America
Rita Repko Clayton Group Services

Alameda County

AUG 1 9 2004

Department of Health

**Second Quarter 2004
Groundwater Monitoring Report
for the
Former Lemoine Sausage Facility
630 29th Avenue
Oakland, California**

Clayton Project No. 70-04578.00

August 11, 2004

Prepared by:
CLAYTON GROUP SERVICES, INC.
6920 Koll Center Parkway
Suite 216
Pleasanton, California
925.426.2600

CONTENTS

<u>Section</u>	<u>Page</u>
1.0 INTRODUCTION	1
2.0 SITE DESCRIPTION AND HISTORY	1
3.0 GROUNDWATER MONITORING FIELD ACTIVITIES.....	2
3.1. GROUNDWATER LEVEL MEASUREMENTS	2
3.2. GROUNDWATER PURGING.....	2
3.3. GROUNDWATER SAMPLING	2
3.4. LABORATORY ANALYSES.....	3
4.0 FINDINGS.....	3
4.1. GROUNDWATER FLOW CONDITIONS	3
4.2. PETROLEUM AND AROMATIC HYDROCARBONS.....	3
4.3. HALOGENATED VOLATILE ORGANIC COMPOUNDS	4
5.0 CONCLUSION.....	4

Tables

1. Summary of Groundwater Elevation Data
2. Summary of Groundwater Analytical Results

Figures

1. Site Location Map
2. Groundwater Elevation Contour Map - Second Quarter 2004
- 3a. TPH-g in Groundwater Isoconcentration Contour Map - Second Quarter 2004
- 3b. Benzene in Groundwater Isoconcentration Contour Map - Second Quarter 2004
4. TCE and 1,2-cis DCE in Groundwater - Second Quarter 2004

Appendices

- A. Second Quarter 2004- Groundwater Sampling Logs
- B. Second Quarter 2004- Certified Analytical Data Sheets and Chain-of-Custody Documentation

1.0 INTRODUCTION

Clayton Group Services, Inc., (Clayton) has prepared this quarterly groundwater monitoring report to document the results of the Second Quarter 2004 groundwater monitoring event for the former Lemoine Sausage Facility located at 630 29th Avenue in Oakland, California (Figure 1). The groundwater monitoring is performed pursuant to a request from the Alameda County Environmental Health (ACEH) in a letter dated June 19, 1999. Groundwater monitoring is required due to past releases from a former gasoline underground storage tank (UST) previously located beneath the sidewalk adjacent to the subject property. The purpose of the groundwater monitoring is to determine groundwater flow conditions and water quality beneath the site. Groundwater samples are collected and analyzed for total petroleum hydrocarbons as gasoline (TPH-g) and associated compounds benzene, toluene, ethylbenzene and total xylenes (BTEX), and the former gasoline fuel additive 1,2-Dichloroethane (1,2-DCA).

As directed by the ACEH, groundwater monitoring is being performed on a quarterly basis. This Second Quarter 2004 Groundwater Monitoring Report documents field activities, and presents data used to determine the groundwater elevation and gradient at the site. Laboratory data presented in this report indicate the groundwater concentrations of dissolved hydrocarbons in the vicinity of the subject property.

2.0 SITE DESCRIPTION AND HISTORY

A single 1,000-gallon gasoline UST and associated plumbing/piping were formerly located beneath the sidewalk of 7th Street adjacent (east) to the subject property building. The associated fuel dispenser was located in a "cubby hole" near the building's roll-up door. The UST and associated piping were removed on November 21, 1996 and confirmation soil samples were collected. A petroleum hydrocarbon sheen was noted on groundwater that collected in the tank excavation and petroleum hydrocarbons were detected in the confirmation soil samples collected at the time of the UST removal.

Subsequent groundwater investigations were performed and monitoring well locations selected to define the vertical and lateral extent of petroleum hydrocarbons within groundwater. Ten (10) groundwater monitoring wells currently exist in the first encountered water bearing zone to test groundwater conditions at and near the site. First encountered water beneath the site occurs in predominantly low permeability clayey and sandy silt, at depths ranging from 3.5 to 8.5 feet below street grade.

During testing for 1,2-DCA, several non-gasoline related halogenated volatile organic compounds (VOCs) were detected in the groundwater samples from wells located in the southern portion of the site. The source of non-gasoline related VOCs, which has not been identified, is most likely off-site.

3.0 GROUNDWATER MONITORING FIELD ACTIVITIES

The following discussion describes field methods used to obtain depth to water measurements and collect groundwater samples. Groundwater samples were collected from 10 monitoring wells (MW-1, MW-2, MW-6, MW-7, MW-8, MW-9, MW-10, MW-11, MW-12 and MW-13).

3.1. GROUNDWATER LEVEL MEASUREMENTS

Depth to water was measured in each of the 10 monitoring wells to determine the groundwater elevation, gradient and flow direction. Using an electronic water level probe, the depth to water in each well was measured from the surveyed reference elevation represented as a V-notch at the top of the casing (TOC) to the water surface within the well casing. By subtracting the measured depth to water from the TOC elevation in each monitoring well, the groundwater elevation at each monitoring point was calculated.

3.2. GROUNDWATER PURGING

Two monitoring wells (MW-1 and MW-2) are constructed with ¾-inch diameter PVC well casings and eight monitoring wells (MW-6 through MW-13) are constructed with 2-inch diameter PVC well casings. Prior to collecting a groundwater sample from each monitoring well, approximately four well casing volumes of water were removed or the well casing was purged dry. The ¾-inch diameter wells were purged using a peristaltic pump and ¼-inch polytubing, and the 2-inch diameter wells were purged by hand bailing with a 1-liter Teflon bailer. Water quality parameters (pH, specific conductivity, and temperature) were measured and recorded onto field sampling data sheets. Water quality parameter measurements were taken prior to purging and after removing each well casing volume of water from the monitoring well.

The purge volume from each monitoring well was determined by multiplying the nominal cross-sectional area of the well casing by the water column within each well casing. The water column height in each well was determined by subtracting the depth to water from the well casing depth (reported in well construction details).

Field logs documenting water-level measurements and well purging and sampling for the Second Quarter 2004 monitoring event are presented in Appendix A. Groundwater purged from monitoring wells during sampling was stored onsite in sealed 55-gallon drums meeting U.S. Department of Transportation (USDOT) regulations and labeled with identifying information. The waste was later manifested and removed from the site by a licensed hauler as hazardous waste.

3.3. GROUNDWATER SAMPLING

Prior to collecting a groundwater sample from each monitoring well, the well casing was allowed to recharge to 80-percent of the pre-purged water volume. Groundwater samples for laboratory analyses were retrieved using either a peristaltic pump with polytubing or a new disposable bailer. The groundwater retrieved for analyses was transferred into appropriately sized and preserved laboratory supplied containers. Sample containers

were sealed, labeled with identifying information, logged onto the chain-of-custody, and temporarily stored in a chilled ice-chest while awaiting transportation to the laboratory.

3.4. LABORATORY ANALYSES

Groundwater samples were submitted for analysis to State of California certified laboratory Curtis and Tompkins, Ltd., Analytical Laboratories of Berkeley, California. The samples were analyzed by one or more of the following United States Environmental Protection Agency (USEPA) approved analytical methods:

- USEPA Method 8015B for Total Petroleum Hydrocarbons as Gasoline (TPH-g)
- USEPA Method 8021B for Aromatic Hydrocarbons (Benzene, Toluene, Ethylbenzene, and total Xylenes)
- USEPA Method 8260B for Halogenated Volatile Organic Compounds (VOCs)

Certified analytical data sheets and chain-of-custody documentation for the Second Quarter 2004 groundwater-sampling event are presented in Appendix B.

4.0 FINDINGS

The following discussion presents an interpretation of groundwater flow conditions and water quality at the site based on the results obtained from field measurements and laboratory analyses.

4.1. GROUNDWATER FLOW CONDITIONS

A groundwater elevation contour (water table) map was produced by using the surveyed monitoring well coordinates to produce contouring lines of equal elevation using the groundwater elevation data points for this monitoring event. The magnitude of the local groundwater gradient was determined using groundwater elevations from monitoring wells MW-1 and MW-12. The direction of groundwater flow is inferred to be perpendicular to the piezometric equipotential contours. For the Second Quarter 2004 monitoring event, the groundwater gradient was determined to be 0.013 feet per foot (ft/ft) towards the west-southwest.

Historical depth to water measurements and groundwater elevation data are presented in Table 1. The Second Quarter 2004 groundwater elevation contour map and the approximate groundwater flow direction is presented on Figure 2.

4.2. PETROLEUM AND AROMATIC HYDROCARBONS

The frequency and range of petroleum hydrocarbons detected in groundwater samples are as follows:

- TPH-g was detected in 7 of 10 samples that ranged in concentration from 63 micrograms per liter ($\mu\text{g/L}$) to 53,000 $\mu\text{g/L}$.

- Benzene was detected in 5 of 10 samples that ranged in concentration from 140 µg/L to 12,000 µg/L.
- Toluene was detected in 5 of 10 samples that ranged in concentration from 2.9 µg/L to 2,600 µg/L.
- Ethylbenzene was detected in 5 of 10 samples that ranged in concentration from 88 µg/L to 1,100 µg/L.
- Total xylene was detected in 5 of 10 samples that ranged in concentration from 1.5 µg/L to 4,800 µg/L.

A summary of petroleum hydrocarbons and VOCs detected in groundwater samples is presented in Table 2. The concentrations of TPH-g and benzene detected in groundwater samples and isoconcentration contours for the Second Quarter 2004 monitoring event are presented in Figures 3a and 3b, respectively.

4.3. HALOGENATED VOLATILE ORGANIC COMPOUNDS

The frequency and range of VOCs detected in groundwater samples are as follows:

- 1,2-Dichloroethane (1,2-DCA) was detected only in MW-6, at a concentration of 0.8 µg/L.
- Trichloroethene (TCE) was detected in 2 of 10 samples tested (MW-12 at 200 µg/L and MW-13 at 53 µg/L).
- Cis 1,2-Dichloroethene (cis 1,2-DCE) was detected in 3 of 10 samples tested (MW-8 at 1,300 µg/L, MW-12 at 65 µg/L, and MW-13 at 350 µg/L) .
- Trans 1,2-Dichloroethene (trans 1,2-DCE) was detected in 3 of 10 samples tested (MW-8 at 50 µg/L, MW-12 at 74 µg/L, and MW-13 at 31 µg/L).
- Vinyl Chloride (VC) was detected in 2 of 10 samples tested (80 µg/L at MW-8 and 25 µg/L at MW-13).

The concentrations of TCE and cis 1,2-DCE detected were in groundwater samples for the Second Quarter 2004 monitoring event are presented in Figure 4.

5.0 CONCLUSION

The groundwater gradient determined for the Second Quarter 2004 monitoring event was found to be relatively consistent with past determinations. TPH-g and BTEX in groundwater are within observed historic concentration ranges. The highest concentrations of TPH-g and benzene occur in monitoring wells MW-2 and MW-9, beneath the central portion of the subject building just downgradient of the former UST location. The locations of monitoring wells MW-6, MW-7 and MW-10 define the northern, western, and eastern edge of the hydrocarbon plume.

Chlorinated volatile organic compounds (not a component of gasoline) found in downgradient monitoring well samples (wells MW-8, MW-13, and MW-12) but not near the former UST location, include TCE and its associated degradation compounds of cis-1,2-DCE, trans-1,2-DCE, and VC. These chlorinated compounds appear to be relatively stable with some indications of natural degradation. The source of the chlorinated VOCs is unknown, appears to be originating off-site, and does not appear to be related to the gasoline release.

Report prepared by:



Mathew Reimer
Staff Environmental Consultant

Report reviewed by:



Donald A. Ashton, R.G., REA
Senior Geologist
Environmental Services
San Francisco Regional Office

August 11, 2004

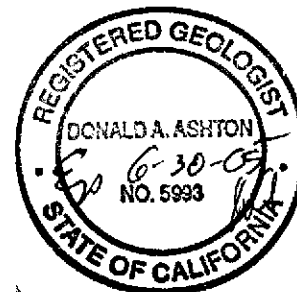

Table 1
Summary of Groundwater Elevation Data
Former Lemoine Sausage Facility
630 29th Avenue
Oakland, California

Well Identification	Date Measured	Top of Casing Elevation (ft.msl)	Depth to Water (feet)	Groundwater Elevation (ft.msl)
MW-1	6/23/2004	16.69	5.96	10.73
	4/6/2004		3.57	13.12
	12/16/2003		NM	
	9/26/2003		6.88	9.81
	6/24/2003		5.29	11.40
	3/28/2003		4.44	12.25
	12/16/2002		3.91	12.78
	9/11/2002		6.17	10.52
	6/28/2002		5.61	11.08
	3/25/2002		2.77	13.92
	12/3/2001		4.17	12.52
	9/25/2001		6.76	9.93
	6/20/2001		5.85	10.84
	3/21/2001		4.29	12.40
	12/19/2000		5.50	11.19
	9/22/2000		6.30	10.39
	6/15/2000		4.82	11.87
2/8/1999	3.60	13.09		
MW-2	6/23/2004	20.79	11.60	9.19
	4/6/2004		9.40	11.39
	12/16/2003		11.50	9.29
	9/26/2003		11.20	9.59
	6/24/2003		10.24	10.55
	3/28/2003		10.27	10.52
	12/16/2002		11.15	9.64
	9/11/2002		10.89	9.90
	6/28/2002		10.65	10.14
	3/25/2002		9.21	11.58
	12/3/2001		11.13	9.66
	9/25/2001		11.78	9.01
	6/20/2001		10.92	9.87
	3/21/2001		10.01	10.78
	12/19/2000		11.38	9.41
	9/22/2000		11.49	9.30
	6/15/2000		10.46	10.33
2/8/1999	14.20	6.59		
MW-3	Removed from monitoring program in October 2001			
	9/25/2001	21.10	10.74	10.36
	6/20/2001		10.14	10.96
	3/21/2001		8.95	12.15
	12/19/2000		9.72	11.38
	9/22/2000		15.30	5.80
	6/15/2000		10.56	10.54
	2/8/1999		7.45	13.65
MW-4	Removed from monitoring program in October 2001			
	9/25/2001	17.78	7.40	10.38
	6/20/2001		6.78	11.00
	3/21/2001		5.77	12.01
	12/19/2000		6.40	11.38
	9/22/2000		6.90	10.88
	6/15/2000		6.30	11.48
2/8/1999		4.13	13.65	

Table 1
Summary of Groundwater Elevation Data
Former Lemoine Sausage Facility
630 29th Avenue
Oakland, California

Well Identification	Date Measured	Top of Casing Elevation (ft.msl)	Depth to Water (feet)	Groundwater Elevation (ft.msl)
MW-5	Removed from monitoring program in October 2001			
		21.12	10.34	10.78
			9.90	11.22
			8.68	12.44
			9.99	11.13
			9.99	11.13
			10.36	10.76
			7.62	13.50
MW-6		16.60	5.76	10.84
			4.85	11.75
			4.99	11.61
			6.70	9.90
			5.52	11.08
			NM	
			3.93	12.67
			5.43	11.17
			5.83	10.77
			3.93	12.67
			4.72	11.88
			6.68	9.92
			6.13	10.47
			4.70	11.90
			5.93	10.67
			6.54	10.06
		5.47	11.13	
MW-7		15.47	6.20	9.27
			5.60	9.87
			5.68	9.79
			7.22	8.25
			6.13	9.34
			5.68	9.79
			5.01	10.46
			6.95	8.52
			6.94	8.53
			6.04	9.43
			6.48	8.99
			7.25	8.22
			6.90	8.57
			5.53	9.94
			7.20	8.27
			7.51	7.96
		6.40	9.07	

Table 1
Summary of Groundwater Elevation Data
Former Lemoine Sausage Facility
630 29th Avenue
Oakland, California

Well Identification	Date Measured	Top of Casing Elevation (ft.msl)	Depth to Water (feet)	Groundwater Elevation (ft.msl)
MW-8	6/23/2004	17.58	7.98	9.60
	4/6/2004		6.74	10.84
	12/16/2003		6.69	10.89
	9/26/2003		8.71	8.87
	6/24/2003		7.44	10.14
	3/28/2003		6.62	10.96
	12/16/2002		5.63	11.95
	9/11/2002		8.40	9.18
	6/28/2002		7.71	9.87
	3/25/2002		5.40	12.18
	12/3/2001		6.58	11.00
	9/25/2001		8.89	8.69
	6/20/2001		7.96	9.62
	3/21/2001		6.40	11.18
	12/19/2000		7.71	9.87
	9/22/2000		8.33	9.25
6/15/2000	7.14	10.44		
MW-9	6/23/2004	17.61	7.80	9.81
	4/6/2004		5.97	11.64
	12/16/2003		6.76	10.85
	9/26/2003		8.14	9.47
	6/24/2003		6.42	11.19
	3/28/2003		6.08	11.53
	12/16/2002		6.58	11.03
	9/11/2002		6.91	10.70
	6/28/2002		7.71	9.90
	3/25/2002		4.98	12.63
	12/3/2001		5.79	11.82
MW-10	6/23/2004	16.92	5.96	10.96
	4/6/2004		4.54	12.38
	12/16/2003		4.94	11.98
	9/26/2003		6.98	9.94
	6/24/2003		5.40	11.52
	3/28/2003		4.54	12.38
	12/16/2002		3.74	13.18
	9/11/2002		6.16	10.76
	6/28/2002		5.65	11.27
	3/25/2002		3.00	13.92
12/3/2001	4.22	12.70		
MW-11	6/23/2004	14.87	5.68	9.19
	4/6/2004		5.49	9.38
	12/16/2003		5.61	9.26
	9/26/2003		7.16	7.71
	6/24/2003		5.86	9.01
	3/28/2003		5.17	9.70
	12/16/2002		3.92	10.95
	9/11/2002		6.91	7.96
	6/28/2002		6.35	8.52
	3/25/2002		4.68	10.19
12/3/2001	5.67	9.20		

Table 1
Summary of Groundwater Elevation Data
Former Lemoine Sausage Facility
630 29th Avenue
Oakland, California

Well Identification	Date Measured	Top of Casing Elevation (ft.msl)	Depth to Water (feet)	Groundwater Elevation (ft.msl)
MW-12	6/23/2004	14.05	5.78	8.27
	4/6/2004		5.04	9.01
	12/16/2003		4.99	9.06
	9/26/2003		6.94	7.11
	6/24/2003		5.73	8.32
	3/28/2003		5.08	8.97
	12/16/2002		4.94	9.11
	9/11/2002		6.82	7.23
	6/28/2002		6.13	7.92
MW-13	6/23/2004	13.39	6.12	7.27
	4/6/2004		5.35	8.04
	12/16/2003		5.01	8.58
	9/26/2003		6.99	6.40
	6/24/2003		5.99	7.40
	3/28/2003		5.34	8.05
	12/16/2002		3.90	9.49
	9/11/2002		6.66	6.73
	6/28/2002		6.21	7.18

Notes:

1. All top of casing elevations referenced to mean sea level (msl) and surveyed with reference to the benchmark located at Peterson Street and East 7th Street.
2. NM = Not Measured

Table 2
Summary of Groundwater Analytical Results
Former Lemoine Sausage Facility
630 29th Avenue, Oakland, California

Sample Location	Date Sampled	TPHG ug/L	MTBE ug/L	Benzene ug/L	Toluene ug/L	Ethyl benzene ug/L	Total Xylenes ug/L	1,2- DCA ug/L	TCE ug/L	cis-1,2 DCE ug/L	trans-1,2- DCE ug/L	VC ug/L
MW-1	6/23/2004	25,000	NA	2,700	1,700	680	2,300	<2.5	<2.5	<2.5	<2.5	<2.5
	4/6/2004	18,000	NA	2,400	1,300	550	1,730	<2.0	<2.0	<2.0	<2.0	<2.0
	12/16/2003	Not Sampled										
	9/26/2003	11,000	NA	1,200	960	370	1,600	<1.0	<1.0	<1.0	<1.0	<1.0
	6/24/2003	14,000	NA	2,400	1,400	500	2,100	<4.2	<4.2	<4.2	<4.2	<4.2
	3/28/2003	20,000	NA	2,700	1,500	650	2,300	<3.6	<3.6	<3.6	<3.6	<3.6
	12/16/2002	20,000	NA	2,800	490	500	2,300	<4.2	<4.2	<4.2	<4.2	<4.2
	9/11/2002	27,000	NA	3,200	1,900	720	3,500	<4.2	<4.2	<4.2	<4.2	<4.2
	6/28/2002	26,000	NA	3,200	1,800	640	2,900	<3.1	<3.1	<3.1	<3.1	<3.1
	3/25/2002	11,000	NA	3,200	1,200	73	1,860	<5	<5	<5	<5	<5
	12/3/2001	15,000	NA	2,800	1,200	310	1,660	<3.1	<3.1	<3.1	<3.1	<3.1
	9/26/2001	16,000	NA	1,100	130	< 10	320	<2.5	<2.5	<2.5	<2.5	<2.5
	6/21/2001	12,000	NA	2,000	880	180	1,180	3.0	<0.5	<0.5	<0.5	<0.5
	3/21/2000	21,000	NA	3,200	1,700	290	2,600	<2.5	<2.5	<2.5	<2.5	<2.5
	12/19/2000	25,000	NA	3,200	1,900	480	3,300	<2.5	<2.5	<2.5	<2.5	<2.5
	9/22/2000	25,000	<500	3,100	1,800	470	3,600	NA	NA	NA	NA	NA
	6/15/2000	29,000	NA	3,900	<100	1,900	4,200	<5.0	<5.0	<5.0	<5.0	<5.0
2/8/1999	48,000	NA	3,900	6,300	970	4,300	<30	NA	NA	NA	NA	
MW-2	6/23/2004	33,000	NA	8,200	1,800	870	1,930	<17	<17	<17	<17	<17
	4/6/2004	27,000	NA	7,600	1,700	630	1,420	<10	<10	<10	<10	<10
	12/16/2003	22,000	NA	10,000	2,700	1,200	2,920	<25	<25	<25	<25	<25
	9/26/2003	20,000	NA	10,000	2,100	960	2,520	<17	<17	<17	<17	<17
	6/24/2003	19,000	NA	10,000	1,700	1,100	2,530	<13	<13	<13	<13	<13
	3/28/2003	30,000	NA	9,300	920	930	2,000	14	<13	<13	<13	<13
	12/16/2002	6,000	NA	1,600	410	150	402	2.7	4.5	69	6.9	<2.5
	9/11/2002	23,000	NA	6,600	1,000	600	1,320	10	<6.3	<6.3	<6.3	<6.3
	6/28/2002	8,400	NA	2,200	680	21	220	8.8	<3.1	<3.1	<3.1	<3.1
	3/25/2002	21,000	NA	11,000	3,700	1,000	2,790	<17	<17	<17	<17	<17
	12/3/2001	45,000	NA	13,000	5,100	950	2,930	14	<7.1	<7.1	<7.1	<7.1
	9/26/2001	26,000	NA	12,000	3,900	590	1,960	11	<10	<10	<10	<10
	6/21/2001	30,000	NA	8,600	2,600	440	1,230	5.6	<0.5	<0.5	<0.5	<0.5
	3/23/2001	34,000	NA	10,000	3,200	410	1,220	14	<13	<13	<13	<13
	12/19/2000	43,000	NA	9,800	4,000	810	2,430	21	<13	<13	<13	<13
	9/22/2000	24,000	<500	10,000	2,700	370	1,200	NA	NA	NA	NA	NA
	6/29/2000	31,000	NA	11,000	930	4,400	250	25	<5.0	<5.0	<5.0	<5.0
2/8/1999	41,000	NA	11,000	4,900	650	1,720	60	NA	NA	NA	NA	

Table 2
Summary of Groundwater Analytical Results
Former Lemoine Sausage Facility
630 29th Avenue, Oakland, California

Sample Location	Date Sampled	TPHG ug/L	MIBE ug/L	Benzene ug/L	Toluene ug/L	Ethyl benzene ug/L	Total Xylenes ug/L	1,2- DCA ug/L	TCE ug/L	cis-1,2 DCE ug/L	trans-1,2- DCE ug/L	VC ug/L
MW-3	Removed from sampling program in October 2001											
	9/26/2001	59,000	NA	12,000	13,000	780	3,680	990	< 8.3	< 8.3	< 8.3	< 8.3
	6/21/2001	34,000	NA	5,900	6,200	340	1,550	120	2.4	0.8	<0.5	<0.5
	3/22/2001	1,300	NA	98	67	51	104	2.3	<0.5	<0.5	<0.5	<0.5
	12/19/2000	50,000	NA	1,200	1,600	510	1,810	350	<8.3	<8.3	<8.3	<8.3
	9/22/2000	83,000	<1,000	16,000	20,000	1,300	7,000	NA	NA	NA	NA	NA
	6/29/2000	39,000	NA	7,800	630	8,000	3,400	600	<5.0	<5.0	<5.0	<5.0
	2/8/1999	35,000	NA	1,200	3,400	1,400	4,900	<30	NA	NA	NA	NA
MW-4	Removed from sampling program in October 2001											
	9/26/2001	17,000	NA	7,900	< 50	440	581	1.9	< 0.5	8.1	< 0.5	< 0.5
	6/21/2001	11,000	NA	2,300	26	570	641	1.4	<0.5	3.3	<0.5	<0.5
	3/22/2001	5,600	NA	1,100	13	310	303	<0.5	<0.5	1.6	<0.5	<0.5
	12/19/2000	2,200	NA	200	2.9	100	81.4	<0.5	<0.5	<0.5	<0.5	<0.5
	9/22/2000	12,000	<500	2,800	82	1,100	1,300	NA	NA	NA	NA	NA
	6/15/2000	2,300	NA	230	<5	10	94	0.88	<0.5	2.1	<0.5	<0.5
	2/8/1999	15,000	NA	670	90	780	940	<30	NA	NA	NA	NA
MW-5	Removed from sampling program in October 2001											
	9/26/2001	5,100	NA	2,400	1,200	< 10	460	22	< 3.6	< 3.6	< 3.6	< 3.6
	6/21/2001	18,000	NA	3,400	2,300	350	1,020	21	<0.5* ^d	<0.5	<0.5	<0.5
	3/22/2001	6,200	NA	1,500	360	310	288	3.3	<0.5	<0.5	<0.5	<0.5
	12/19/2000	21,000	NA	3,200	1,100	1,100	1,300	15	<4.2	<4.2	<4.2	<4.2
	9/27/2000	16,000	<500	4,300	3,100	420	1,600	NA	NA	NA	NA	NA
	6/29/2000	3,900	NA	1,500	28	330	260	36	<0.5	<0.5	<0.5	<0.5
	2/8/1999	4,900	NA	780	440	230	370	<0.5	<0.5	<0.5	<0.5	<0.5
MW-6	6/23/2004	63	NA	< 0.5	< 0.5	< 0.5	< 0.5	< 0.5 ⁺¹³	< 0.5	< 0.5	< 0.5	< 0.5
	4/6/2004	260	NA	< 0.5	< 0.5	< 0.5	< 0.5	< 0.5 ⁺¹²	< 0.5	< 0.5	< 0.5	< 0.5
	12/16/2003	<50	NA	< 0.5	< 0.5	< 0.5	0.88	< 0.5	1.7	0.6	< 0.5	< 0.5
	9/26/2003	<50	NA	< 0.5	< 0.5	< 0.5	< 0.5	0.7* ^g	< 0.5	< 0.5	< 0.5	< 0.5
	6/24/2003	130	NA	< 0.5	< 0.5	< 0.5	< 0.5	< 0.5	< 0.5	< 0.5	< 0.5	< 0.5
	3/28/2003	NS	NS	NS	NS	NS	NS	NS	NS	NS	NS	NS
	12/16/2002	62	NA	< 0.5	0.54	3.0	8.39	1.0* ^g	0.7	< 0.5	< 0.5	< 0.5
	9/11/2002	120	NA	< 0.5	< 0.5	< 0.5	< 0.5	< 0.5* ^g	< 0.5	< 0.5	< 0.5	< 0.5
	6/28/2002	120	NA	< 0.5	< 0.5	< 0.5	< 0.5	0.6	< 0.5	< 0.5	< 0.5	< 0.5
	3/25/2002	1,200	NA	22	8.0	5.7	13.5	< 0.5	< 0.5	< 0.5	< 0.5	< 0.5
	12/3/2001	72	NA	< 0.5	< 0.5	< 0.5	< 0.5	1.6* ^g	< 0.5	< 0.5	< 0.5	< 0.5
	9/25/2001	760	NA	< 0.5	< 0.5	< 0.5	2.9	< 0.5* ^g	< 0.5	< 0.5	< 0.5	< 0.5
	6/21/2001	420	NA	< 0.5	< 0.5	0.59	1.00	0.9	< 0.5	< 0.5	< 0.5	< 0.5
	3/21/2001	820	NA	< 0.5	< 0.5	1.4	0.52	< 0.5* ^z	< 0.5	< 0.5	< 0.5	< 0.5
	12/19/2000	320	NA	< 0.5	< 0.5	< 0.5	< 0.5	< 0.5* ¹	< 0.5	< 0.5	< 0.5	< 0.5
	9/22/2000	71	<5	< 0.5	< 0.5	< 0.5	< 0.5	NA	NA	NA	NA	NA
6/15/2000	1,100	NA	3.8	2.2	2.1	4.8	0.78	< 0.5	< 0.5	< 0.5	< 0.5	

Table 2
Summary of Groundwater Analytical Results
Former Lemolne Sausage Facility
630 29th Avenue, Oakland, California

Sample Location	Date Sampled	TPHG	MTBE	Benzene	Toluene	Ethyl benzene	Total Xylenes	1,2-DCA	TCE	cis-1,2-DCE	trans-1,2-DCE	VC
		ug/L	ug/L	ug/L	ug/L	ug/L	ug/L	ug/L	ug/L	ug/L	ug/L	ug/L
MW-7	6/23/2004	<50	NA	<0.5	<0.5	<0.5	<0.5	<0.5	<0.5	<0.5	<0.5	<0.5
	4/6/2004	<50	NA	<0.5	<0.5	<0.5	<0.5	<0.5	<0.5	<0.5	<0.5	<0.5
	12/16/2003	<50	NA	<0.5	<0.5	<0.5	0.75	<0.5	1.8	0.6	<0.5	<0.5
	9/26/2003	<50	NA	<0.5	<0.5	<0.5	<0.5	<0.5	<0.5	<0.5	<0.5	<0.5
	6/24/2003	<50	NA	<0.5	<0.5	<0.5	<0.5	<0.5	<0.5	<0.5	<0.5	<0.5
	3/28/2003	<50	NA	<0.5	<0.5	<0.5	<0.5	<0.5	<0.5	<0.5	<0.5	<0.5
	12/16/2002	<50	NA	<0.5	<0.5	1.6	3.7	<0.5	0.5	<0.5	<0.5	<0.5
	9/11/2002	<50	NA	<0.5	<0.5	<0.5	<0.5	<0.5	<0.5	<0.5	<0.5	<0.5
	6/28/2002	<50	NA	<0.5	<0.5	<0.5	<0.5	<0.5	<0.5	<0.5	<0.5	<0.5
	3/25/2002	<50	NA	0.56	0.75	<0.5	0.69	<0.5	<0.5	<0.5	<0.5	<0.5
	12/3/2001	82	NA	24	<0.5	<0.5	<0.5	<0.5	<0.5	<0.5	<0.5	<0.5
	9/25/2001	<50	NA	<0.5	<0.5	<0.5	<0.5	<0.5	<0.5	<0.5	<0.5	<0.5
	6/21/2001	<50	NA	<0.5	<0.5	<0.5	<0.5	<0.5	<0.5	<0.5	<0.5	<0.5
	3/21/2001	160	NA	59	<0.5	<0.5	<0.5	<0.5	<0.5	<0.5	<0.5	<0.5
	12/19/2000	<50	NA	1.6	<0.5	<0.5	<0.5	<0.5	<0.5	<0.5	<0.5	<0.5
	9/22/2000	<50	<5	2	<0.5	<0.5	<0.5	<0.5	NA	NA	NA	NA
	6/15/2000	1,000	NA	250	<10	<10	16	<0.5	<0.5	<0.5	<0.5	<0.5
MW-8	6/23/2004	4,600	NA	570	2.9	100	1.5	<8.3	<8.3	1,300	50	80
	4/6/2004	3,800	NA	420	<0.5	53	1.2	3.7	4.4	1,100	39	58
	12/16/2003	1,100	NA	310	<2.5	14	<2.5	4.3	12	1,200	53	110
	9/26/2003	1,300	NA	280	3.9	38	0.85	<3.6	20	890	49	47
	6/24/2003	3,300	NA	520	<0.5	58	0.63	3.7	6.4	1,000	49	61
	3/28/2003	1,500	NA	400	<0.5	50	0.62	<2.5	3.5	700	39	41
	12/16/2002	95	NA	26	<0.5	1	<0.5	2.2	17	330	36	4.7
	9/11/2002	2,000	NA	390	1.6	39	<1.0	<3.6	17	1,000	60	91
	6/28/2002	2,200	NA	410	<1.0	40	<1.0	4.9	18	900	54	80
	3/25/2002	990	NA	280	7.2	1.4	6.8	3.6	10	790	33	49
	12/3/2001	1,200	NA	190	14	2.7	11.3	<2.5	100	650	44	31
	9/25/2001	1,500	NA	170	4.3	1.6	2.7	5.0	36	820	59	53
	6/21/2001	2,400	NA	490	<2.5	29	<2.5	4.9	28	910	48	75
	3/21/2001	3,500	NA	530	<2.5	21	<2.5	<3.6	32	760	39	58
	12/19/2000	2,700	NA	410	<2.5	4.8	<2.5	9.1	130	1,000	67	48
	9/22/2000	1,800	<25	340	<2.5	<2.5	<2.5	<2.5	NA	NA	NA	NA
	6/15/2000	5,400	NA	150	<5	8.9	8.7	<13	210	1,100	73	25

Table 2
Summary of Groundwater Analytical Results
Former Lemoine Sausage Facility
630 29th Avenue, Oakland, California

Sample Location	Date Sampled	TPHG	MTBE	Benzene	Toluene	Ethyl benzene	Total Xylenes	1,2-DCA	TCE	cis-1,2-DCE	trans-1,2-DCE	VC
		ug/L	ug/L	ug/L	ug/L	ug/L	ug/L	ug/L	ug/L	ug/L	ug/L	ug/L
MW-9	6/23/2004	53,000	NA	12,000	2,600	1,100	4,800	<20	<20	<20	<20	<20
	4/6/2004	60,000	NA	14,000	3,100	1,300	5,500	<17	<17	<17	<17	<17
	12/16/2003	34,000	NA	14,000	4,900	940	4,700	<42	<42	<42	<42	<42
	9/26/2003	34,000	NA	12,000	5,600	880	4,700	<17	<17	<17	<17	<17
	6/24/2003	45,000	NA	15,000	9,600	1,100	5,200	10	<5	<5	<5	<5
	3/28/2003	61,000	NA	13,000	8,600	860	4,800	<20	<20	<20	<20	<20
	12/16/2002	29,000	NA	5,500	3,900	300	1,860	8.9	<5	<5	<5	<5
	9/11/2002	57,000	NA	8,300	6,100	340	4,700	18	<10	<10	<10	<10
	6/28/2002	60,000	NA	5,800	7,400	1,100	5,400	<13	<13	<13	<13	<13
	3/25/2002	71,000	NA	15,000	17,000	1,900	8,000	<31	<31	<31	<31	<31
	12/3/2001	90,000	NA	15,000	15,000	2,200	9,100	<10	<10	<10	<10	<10
	MW-10	6/23/2004	<50	NA	<0.5	<0.5	<0.5	<0.5	<0.5	<0.5	<0.5	<0.5
4/6/2004		<50	NA	<0.5	<0.5	<0.5	<0.5	<0.5	<0.5	<0.5	<0.5	<0.5
12/16/2003		<50	NA	<0.5	<0.5	<0.5	<0.5	<0.5	0.6	<0.5	<0.5	<0.5
9/26/2003		<50	NA	<0.5	<0.5	<0.5	<0.5	<0.5	<0.5	<0.5	<0.5	<0.5
6/24/2003		<50	NA	<0.5	<0.5	<0.5	<0.5	<0.5	<0.5	<0.5	<0.5	<0.5
3/28/2003		<50	NA	<0.5	<0.5	<0.5	<0.5	<0.5	<0.5	<0.5	<0.5	<0.5
12/16/2002		<50	NA	<0.5	0.65	3.0	7.53	<0.5	0.8	<0.5	<0.5	<0.5
9/11/2002		<50	NA	<0.5	<0.5	<0.5	<0.5	<0.5	<0.5	<0.5	<0.5	<0.5
6/28/2002		<50	NA	<0.5	<0.5	<0.5	<0.5	<0.5	<0.5	<0.5	<0.5	<0.5
3/25/2002		51	NA	2.5	3.6	0.53	2.27	<0.5	<0.5	<0.5	<0.5	<0.5
12/3/2001		<50	NA	<0.5	<0.5	<0.5	<0.5	<0.5	<0.5	<0.5	<0.5	<0.5
MW-11		6/23/2004	<50	NA	<0.5	<0.5	<0.5	<0.5	<0.5	<0.5	<0.5	<0.5
	4/6/2004	<50	NA	<0.5	<0.5	<0.5	<0.5	<0.5	<0.5	<0.5	<0.5	<0.5
	12/16/2003	91	NA	4.7	<0.5	<0.5	0.51	<0.5	2.9	0.9	0.6	<0.5
	9/26/2003	<50	NA	1.2	0.69	<0.5	<0.5	<0.5	<0.5	<0.5	<0.5	<0.5
	6/24/2003	<50	NA	<0.5	<0.5	<0.5	<0.5	<0.5	<0.5	<0.5	<0.5	<0.5
	3/28/2003	<50	NA	<0.5	<0.5	<0.5	<0.5	<0.5	<0.5	<0.5	<0.5	<0.5
	12/16/2002	160	NA	42	0.89	4.8	11.1	<0.5	3.6	1.1	<0.5	<0.5
	9/11/2002	120	NA	66	<0.5	0.74	<0.5	<0.5	<0.5	0.6	<0.5	<0.5
	6/28/2002	<50	NA	7.7	<0.5	<0.5	<0.5	<0.5	0.6	<0.5	<0.5	<0.5
	3/25/2002	130	NA	11	20	3.3	14.5	<0.5	<0.5	<0.5	<0.5	<0.5
	12/3/2001	1,600	NA	470	<0.5	3.7	<0.5	<0.5	<0.5	<0.5	<0.5	<0.5

Table 2
Summary of Groundwater Analytical Results
Former Lemoine Sausage Facility
630 29th Avenue, Oakland, California

Sample Location	Date Sampled	TPHG	MTBE	Benzene	Toluene	Ethyl benzene	Total Xylenes	1,2-DCA	TCE	cis-1,2 DCE	trans-1,2-DCE	VC
		ug/L	ug/L	ug/L	ug/L	ug/L	ug/L	ug/L	ug/L	ug/L	ug/L	ug/L
MW-12	6/23/2004	99	NA	<0.5	<0.5	<0.5	<0.5	<0.5	200	65	74	<0.5
	4/6/2004	76	NA	<0.5	<0.5	<0.5	<0.5	<0.5	160	49	54	<0.5
	12/16/2003	120	NA	<0.5	<0.5	<0.5	0.65	<0.5	140	44	44	<0.5
	9/26/2003	230	NA	2.9	1.1	3.8	6.71	<0.7	210	60	63	<0.7
	6/24/2003	140	NA	<0.5	<0.5	<0.5	<0.5	<1.0	220	58	66	<1.0
	3/28/2003	110	NA	<0.5	<0.5	<0.5	<0.5	<0.7	190	53	53	0.9
	12/16/2002	130	NA	<0.5	0.9	4.2	9.9	<0.5	200	57	60	0.9
	9/11/2002	89	NA	<0.5	<0.5	<0.5	<0.5	<0.5	180	46	51	0.9
	6/28/2002	71	NA	<0.5	<0.5	<0.5	<0.5	<0.5	170	42	47	0.9
MW-13	6/23/2004	7,000	NA	140	25	88	21	<2.0	53 ^{*14}	350	31	25
	4/6/2004	3,300	NA	22	<1.0	37	9.0	<0.5	90 ^{*11}	190	23	8
	12/16/2003	8,100	NA	120	36	72	26.6	<0.7	66 ^{*10}	240	23	10
	9/26/2003	7,200	NA	150	<1.0	89	57	<1.0	51 ^{*8}	270	23	5.1
	6/24/2003	8,300	NA	100	<0.5	94	12	<1.0	68 ^{*9}	250	19	4.2
	3/28/2003	4,400	NA	55	<0.5	51	14.3	<0.5	85 ^{*8}	150	13	1.8
	12/16/2002	4,800	NA	90	<0.5	85	24	<0.5	76	250	9.4	1.8
	9/11/2002	4,500	NA	58	7.5	150	14	<0.5	63 ^{*7}	410	13	<1.3
	6/28/2002	5,600	NA	120	55	130	9.5	<0.5	61 ^{*6}	430	14	4.4

Notes:

- All results in micrograms per liter (µg/L).
- NA = Not Analyzed.
- NS = Not Sampled
- 1,2-DCA = 1,2-dichloroethane.
- TPHG = Total Petroleum Hydrocarbons as Gasoline.

- MTBE = methyl tert-butyl ether.
- TCE = Trichloroethene.
- DCE = Dichloroethene.
- VC = Vinyl Chloride.

- *¹ 1,1-DCA detected at 1.1 µg/L.
- *² 1,1-DCA detected at 0.9 µg/L.
- *³ Freon -11 detected at 0.6 µg/L.
- *⁴ 1,1-DCA detected at 0.9 µg/L.
- *⁵ 1,1-DCA detected at 0.7 µg/L.
- *⁶ 1,1-DCE detected at 4.7 µg/L.
- *⁷ 1,1-DCE detected at 5.2 µg/L.
- *⁸ 1,1-DCE detected at 1.9 µg/L.
- *⁹ 1,1-DCE detected at 2.8 µg/L.
- *¹⁰ 1,1-DCE detected at 1.8 µg/L.

- *¹¹ 1,1-DCE detected at 1.1 µg/L.
- *¹² 1,1-DCA detected at 0.5 µg/L.
- *¹³ 1,1-DCE detected at 0.8 µg/L.
- *¹⁴ 1,1-DCE detected at 2.8 µg/L.

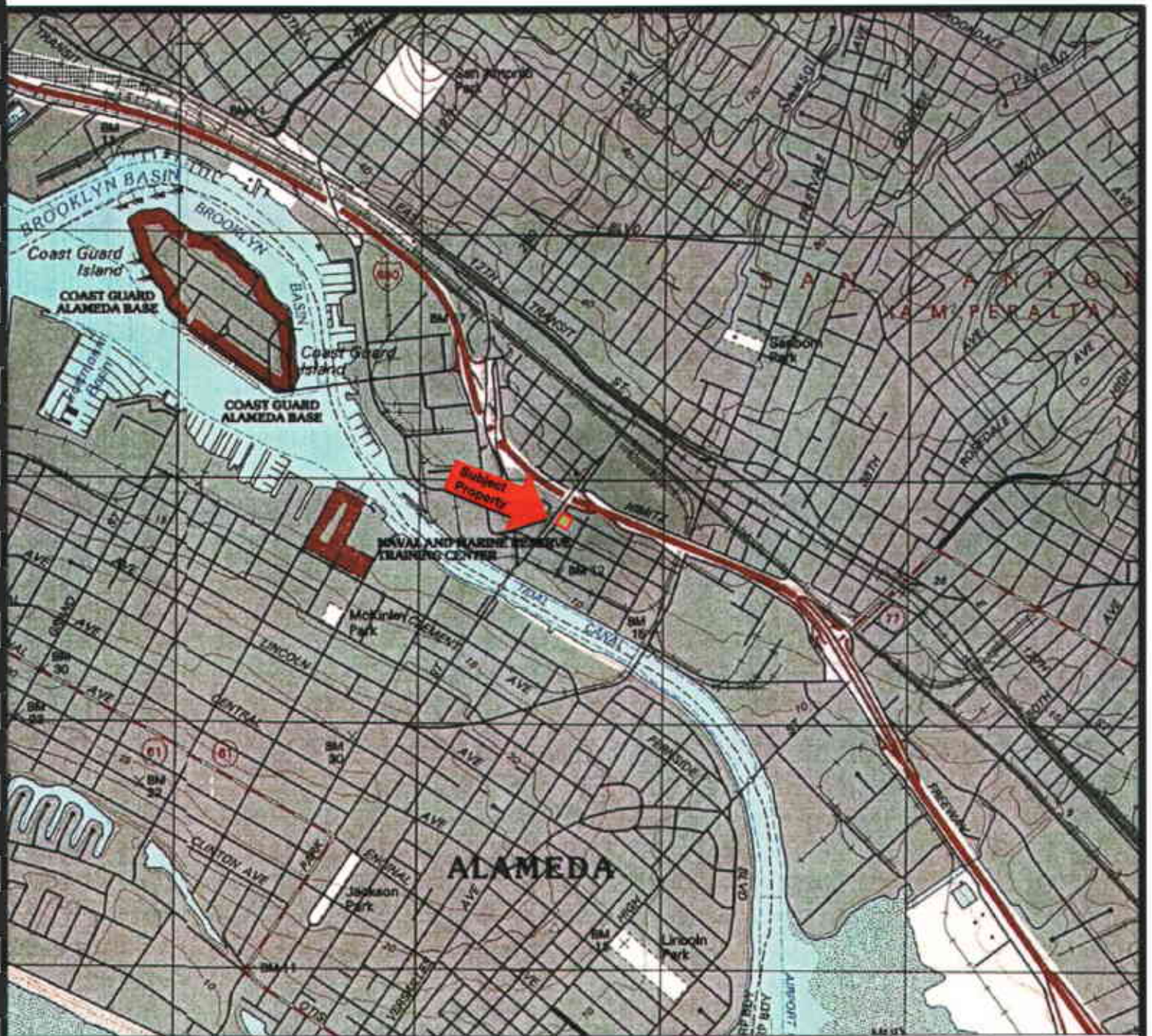

Map Source: TOPO! © 2000 National Geographic Holdings

Note: Boundaries and Location Information is Approximate

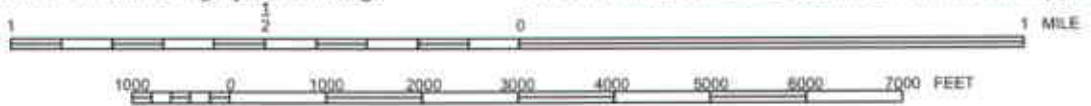

Portion of the 7.5-Minute Series Oakland East, California
 Quadrangle Topographic Map (Datum: NAD 27)
 United States Department of the Interior
 Geological Survey
 1997



PROPERTY LOCATION MAP
 Former Lemoine Sausage Factory
 630 29th Avenue
 Oakland, California
 Clayton Project No. 70-04578.00



Figure

1

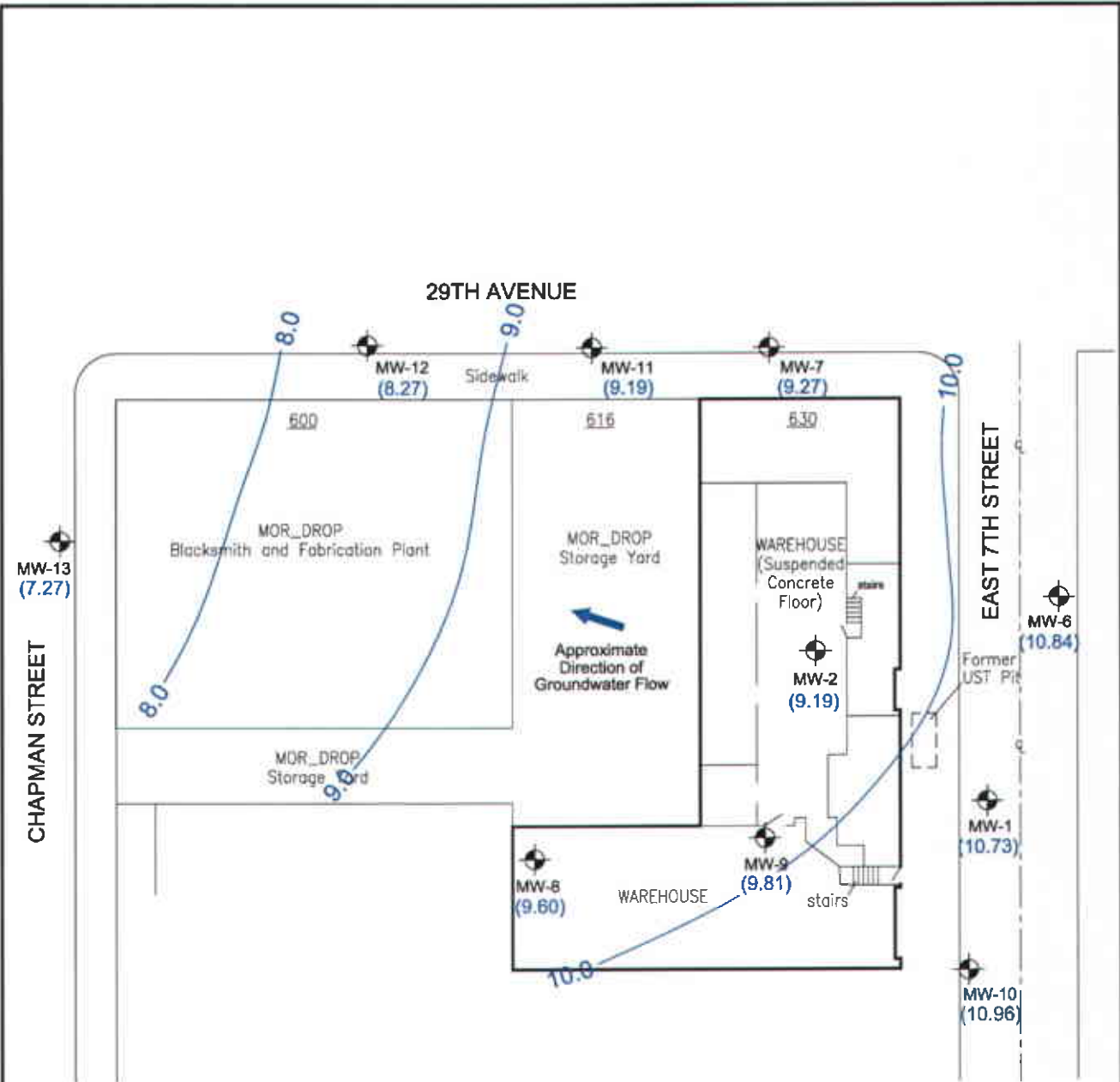



LEGEND:

-  Existing Monitoring Well Location
- (11.39) Groundwater Elevation (ft msl), 06/23/04
- 10  Groundwater Surface Elevation Contour (ft msl)
- ft msl Feet Above Mean Sea Level

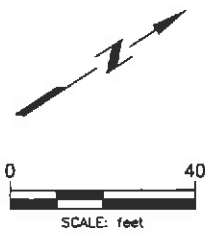

<p>GROUNDWATER ELEVATION CONTOUR MAP, 2ND QUARTER 2004</p> <p>FORMER LEMOINE SAUSAGE FACTORY 830 29TH AVENUE OAKLAND, CALIFORNIA Clayton Project No. 70-04578.00</p>	<p>Figure 2</p> <p>08/03/04 SITE0704.DWG</p>	
--------------------------------------------------------------------------------------------------------------------------------------------------------------------------------------------------------------------	-------------------------------------------------------------	---------------------------------------------------------------------------------------

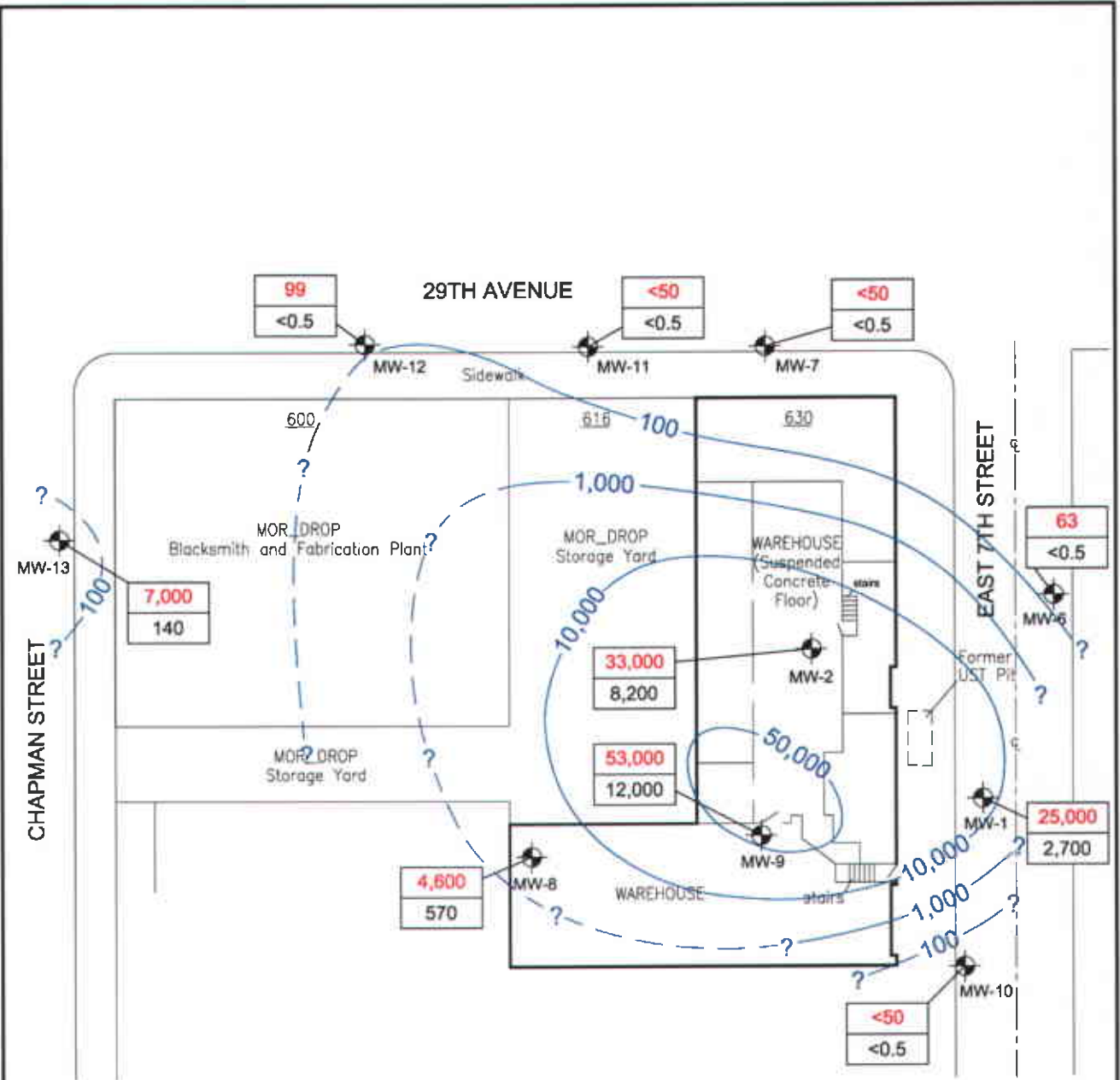

LEGEND:

Existing Monitoring Well Location

33,000 TPH-g Concentration (ug/L), 06/23/04
 8,200 Benzene Concentration (ug/L), 06/23/04

100 TPH-g Isocentration Contour (ug/L)

TPH-g Total Petroleum Hydrocarbons as Gasoline
 ug/L micrograms per liter

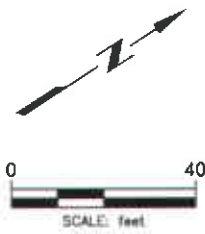

TPH-g CONCENTRATIONS IN GROUNDWATER, 2ND QUARTER 2004

FORMER LEMOINE SAUSAGE FACTORY
 630 29TH AVENUE
 OAKLAND, CALIFORNIA
 Clayton Project No. 70-04578.00

Figure

3a

08/03/04
 SITE0704.DWG



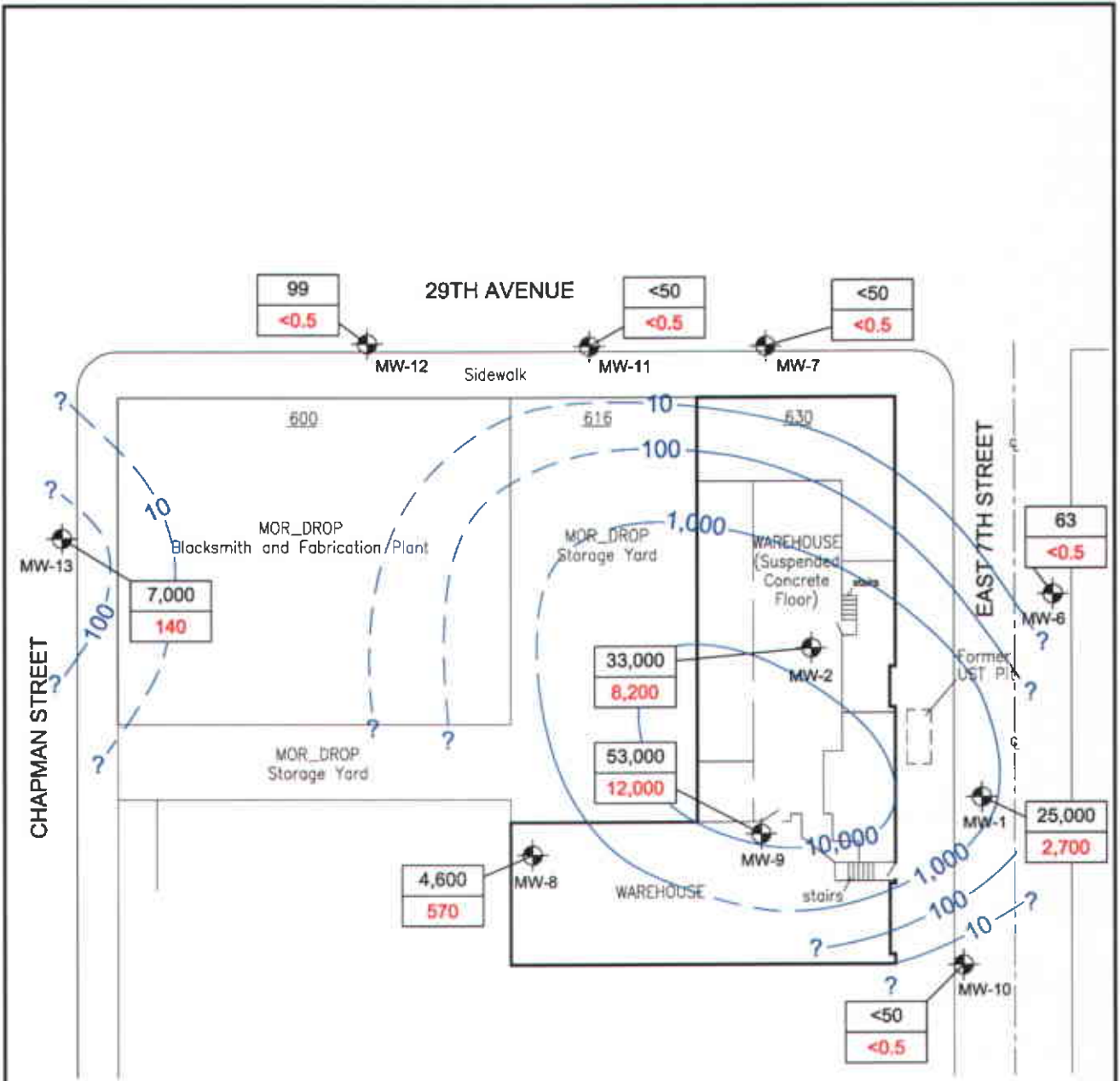

LEGEND:

Existing Monitoring Well Location

TPH-g Concentration (ug/L), 06/23/04

Benzene Concentration (ug/L), 06/23/04

Benzene Isocentration Contour (ug/L)

TPH-g Total Petroleum Hydrocarbons as Gasoline
ug/L micrograms per liter



BENZENE CONCENTRATIONS IN GROUNDWATER, 2ND QUARTER 2004

FORMER LEMOINE SAUSAGE FACTORY
630 29TH AVENUE
OAKLAND, CALIFORNIA
Clayton Project No. 70-04578.00

Figure

3b

08/03/04
SITE0704.DWG



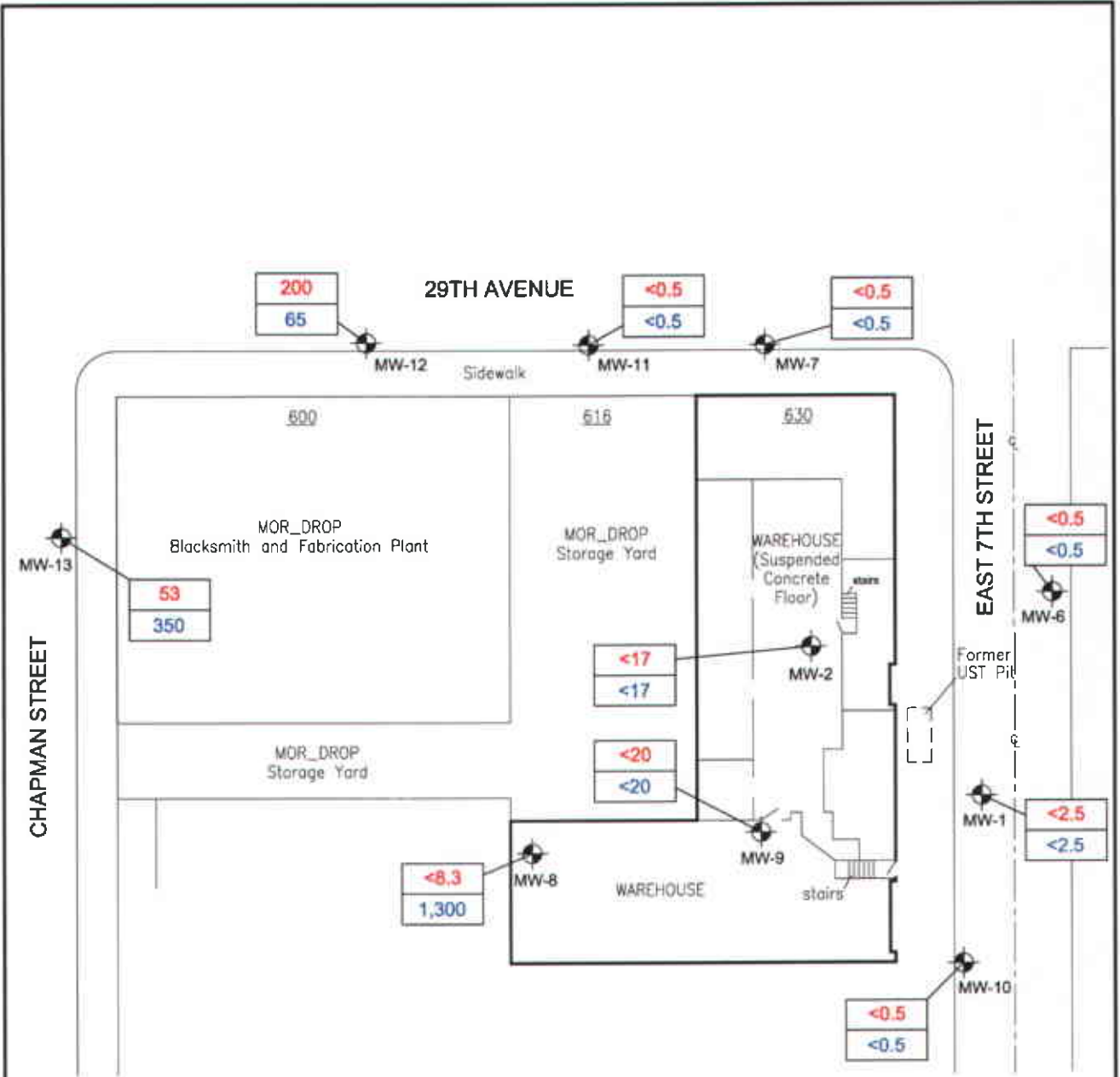

LEGEND:

MW-12 Existing Monitoring Well Location

53 TCE Concentration (ug/L), 06/23/04
 350 cis-1,2-DCE Concentration (ug/L), 06/23/04

TCE Trichloroethene
 cis-1,2-DCE cis-1,2-Dichloroethene
 ug/L micrograms per liter

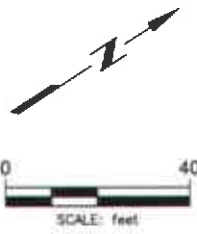

TCE AND cis-1,2-DCE CONCENTRATIONS IN GROUNDWATER, 2ND QUARTER 2004
 FORMER LEMOINE SAUSAGE FACTORY
 630 29TH AVENUE
 OAKLAND, CALIFORNIA
 Clayton Project No. 70-04578.00

Figure

4

08/03/04
 SITE0704.DWG



APPENDIX A

SECOND QUARTER 2004

GROUNDWATER SAMPLING LOGS

FIELD SAMPLING DATA SHEET

Job Location:	Former Lemoine Sausage Factory	Job #:	70-04578.00
	630 29th Avenue	Date Purged:	6/23/2004
	Oakland, California	Purge Method:	peri pump
Sampling Location:	MW-1	Date & Time Samp	6/23/2004 7:50
Top of Casing:	16.69 (ft, msl)	Sampling Method:	peri pump
Depth to Water:	5.96'	Sample Type:	TPHG/BTEX /8010 MS
Groundwater Elevation	10.73'	Preservatives:	HCL
Well Bottom	7.69	# of Containers:	6
Water Column:	3.04'	Field Tech:	MR
Well Casing Volume:	0.03 g (WC* 0.01)	Weather Conditions:	clear +
Casing Volumes Purged:	—		
Purge Rate:			3/4" dia well

Time	Volume Removed (gal)	pH	Specific Conductivity (µmhos/cm)	Redox Potential (mVolts)	Temperature (°F or °C)	Turbidity (Visual)
7:45	0	6.56	1.215	7	20.7	clear
:						
:						
:						
:						
:						
:						
:						
:						
:						
:						
:						
:						
:						
:						
:						

Field Notes:
One set of parameters taken due to small amount of water in well

FIELD SAMPLING DATA SHEET

Job Location:	Former Lemoine Sausage Factory	Job #:	70-04578.00
	630 29th Avenue	Date Purged:	6/23/2004
	Oakland, California	Purge Method:	peri pump
Sampling Location:	MW-2	Date & Time Samp	6/23/2004 9:50
Top of Casing:	20.79 (ft, msl)	Sampling Method:	peri pump
Depth to Water:	11.6'	Sample Type:	TPHG/BTEX /8010 MS
Groundwater Elevation	7.19'	Preservatives:	HCL
Well Bottom	0.79	# of Containers:	6
Water Column:	8.4'	Field Tech:	MR
Well Casing Volume:	0.08 (WC* 0.01)	Weather Conditions:	overcast
Casing Volumes Purged:	—		
Purge Rate:			3/4" dia well

Time	Volume Removed (gal)	pH	Specific Conductivity (µmhos/cm)	Redox Potential (mVolts)	Temperature (°F or °C)	Turbidity (Visual)
7:45	0	6.52	5.77	37	18.0	clear
:						
:						
:						
:						
:						
:						
:						
:						
:						
:						
:						
:						
:						
:						
:						

Field Notes:

One set of parameters taken due to small amount of water in well.

FIELD SAMPLING DATA SHEET

Job Location:	Former Lemoine Sausage Factory	Job #:	70-04578.00
	630 29th Avenue	Date Purged:	6/23/2004
	Oakland, California	Purge Method:	disposable bailer
Sampling Location:	MW-6	Date & Time Samp	6/23/2004 7:00
Top of Casing:	16.6 (ft, msl)	Sampling Method:	disposable bailer
Depth to Water:	5.76'	Sample Type:	TPHG/BTEX /8010 MS
Groundwater Elevation	10.84'	Preservatives:	HCL
Well Bottom	-3.40	# of Containers:	6
Water Column:	14.24'	Field Tech:	MR
Well Casing Volume:	2.28 (WC* 0.16)	Weather Conditions:	
Casing Volumes Purged:	1.1		
Purge Rate:			2" dia well

Time	Volume Removed (gal)	pH	Specific Conductivity (µmhos/cm)	Redox Potential (mVolts)	Temperature (°F or °C)	Turbidity (Visual)
8:35	0	6.93	1.013	16	20.3	clear
8:39	2.5	6.83	1.081	21	21.2	"
8:43	2.5	6.83	1.130	20	20.6	"
8:47	2.5	6.83	1.207	20	20.4	"
8:51	2.5	6.85	1.271	20	19.4	"
:						
:						
:						
:						
:						
:						
:						
:						

Field Notes:

FIELD SAMPLING DATA SHEET

Job Location: Former Lemoine Sausage Factory	Job #: 70-04578.00
630 29th Avenue	Date Purged: 6/23/2004
Oakland, California	Purge Method: disposable bailer
Sampling Location: MW-7	Date & Time Samp: 6/23/2004 11:30
Top of Casing: 15.47 (ft, msl)	Sampling Method: disposable bailer
Depth to Water: 6.20	Sample Type: TPHG/BTEX /8010 MS
Groundwater Elevation: 9.27	Preservatives: HCL
Well Bottom: -4.53	# of Containers: 6
Water Column: 13.8	Field Tech: MR
Well Casing Volume: 2.21 (WC* 0.16)	Weather Conditions: Sunny
Casing Volumes Purged: /	
Purge Rate:	2" dia well

Time	Volume Removed (gal)	pH	Specific Conductivity (µmhos/cm)	Redox Potential (mVolts)	Temperature (°F or °C)	Turbidity (Visual)
11:05	0	7.16	1.976	5	21.0	clear
11:09	2.25	7.13	1.042	0	20.8	"
11:13	2.25	7.17	1.034	1	20.6	"
11:17	2.25	7.26	1.008	3	19.8	"
11:21	2.25	7.15	1.000	7	20.2	"
:						
:						
:						
:						
:						
:						
:						
:						

Field Notes:

FIELD SAMPLING DATA SHEET

Job Location: Former Lemoine Sausage Factory	Job #: 70-04578.00
630 29th Avenue	Date Purged: 6/23/2004
Oakland, California	Purge Method: disposable bailer
Sampling Location: MW-8	Date & Time Samp: 6/23/2004 12:15
Top of Casing: 17.58 (ft, msl)	Sampling Method: disposable bailer
Depth to Water: 7.98'	Sample Type: TPHG/BTEX /8010 MS
Groundwater Elevation: 9.6'	Preservatives: HCL
Well Bottom: -2.42	# of Containers: 6
Water Column: 12.02'	Field Tech: MR
Well Casing Volume: 192 gal (WC* 0.16)	Weather Conditions: sunny
Casing Volumes Purged: 1.04'	
Purge Rate:	2" dia well

Time	Volume Removed (gal)	pH	Specific Conductivity (µmhos/cm)	Redox Potential (mVolts)	Temperature (°F or °C)	Turbidity (Visual)
11:50	0	7.06	1.274	9	17.8	clear
11:54	2	7.06	1.272	8	16.8	"
11:58	2	6.96	1.251	13	16.6	"
12:04	2	6.91	1.263	18	16.6	"
12:08	2	6.90	1.280	19	16.3	"
:						
:						
:						
:						
:						
:						
:						

Field Notes:

FIELD SAMPLING DATA SHEET

Job Location: Former Lemoine Sausage Factory	Job #: 70-04578.00
630 29th Avenue	Date Purged: 6/23/2004
Oakland, California	Purge Method: disposable bailer
Sampling Location: MW-9	Date & Time Samp: 6/23/2004 13:05
Top of Casing: 17.61 (ft, msl)	Sampling Method: disposable bailer
Depth to Water: 1.8	Sample Type: TPHG/BTEX /8010 MS
Groundwater Elevation: 9.81	Preservatives: HCL
Well Bottom: 2.61	# of Containers: 6
Water Column: 12.42	Field Tech: MR
Well Casing Volume: 1.99 (WC* 0.16)	Weather Conditions: sunny
Casing Volumes Purged: 1	
Purge Rate:	2" dia well

Time	Volume Removed (gal)	pH	Specific Conductivity (µmhos/cm)	Redox Potential (mVolts)	Temperature (°F or °C)	Turbidity (Visual)
12:30	0	6.52	7.75	34	17.3	clear
12:34	2	6.48	8.77	40	17.4	clear
12:38	2	6.47	10.02	42	17.1	"
12:43	2	6.52	10.98	40	17.5	clear/cloudy
12:49	2	6.62	10.76	32	17.1	cloud
:						
:						
:						
:						
:						
:						
:						

Field Notes:

FIELD SAMPLING DATA SHEET

Job Location: Former Lemoine Sausage Factory	Job #: 70-04578.00
630 29th Avenue	Date Purged: 6/23/2004
Oakland, California	Purge Method: disposable bailer
Sampling Location: MW-10	Date & Time Samp 6/23/2004 8:20
Top of Casing: 16.92 (ft, msl)	Sampling Method: disposable bailer
Depth to Water: 5.96'	Sample Type: TPHG/BTEX /8010 MS
Groundwater Elevation 10.96'	Preservatives: HCL
Well Bottom 7.92	# of Containers: 6
Water Column: 3.04'	Field Tech: MR
Well Casing Volume: 0.249 gal (WC* 0.16)	Weather Conditions:
Casing Volumes Purged: /	
Purge Rate:	2" dia well

Time	Volume Removed (gal)	pH	Specific Conductivity (µmhos/cm)	Redox Potential (mVolts)	Temperature (°F or °C)	Turbidity (Visual)
8:05	0	6.97	621	13	23.5	clear
8:08	0.5	6.98	633	9	23.6	"
8:11	0.5	6.99	629	12	24.0	"
8:14	0.5	7.02	640	10	24.0	"
8:16	0.5	7.02	636	9	24.1	"
:						
:						
:						
:						
:						
:						
:						
:						

Field Notes:

FIELD SAMPLING DATA SHEET

Job Location: Former Lemoine Sausage Factory	Job #: 70-04578.00
630 29th Avenue	Date Purged: 6/23/2004
Oakland, California	Purge Method: disposable bailer
Sampling Location: MW-11	Date & Time Samp 6/23/2004 13:50
Top of Casing: 14.87 (ft, msl)	Sampling Method: disposable bailer
Depth to Water: 5.08'	Sample Type: TPHG/BTEX /8010 MS
Groundwater Elevation 9.19'	Preservatives: HCL
Well Bottom -0.13	# of Containers: 6
Water Column: 9.32'	Field Tech: MR
Well Casing Volume: 1.49 gal (WC* 0.16)	Weather Conditions: sunny
Casing Volumes Purged: /	
Purge Rate:	2" dia well

Time	Volume Removed (gal)	pH	Specific Conductivity (µmhos/cm)	Redox Potential (mVolts)	Temperature (°F or (C))	Turbidity (Visual)
13:25	0	6.99	1.95	12	23.4	clear
13:29	1.5	7.00	1.637	13	22.6	"
13:33	1.5	6.99	1.624	11	21.2	"
13:37	1.5	7.06	1.655	8	19.4	clear/cloudy
13:41	1.5	7.13	1.686	5	20.0	cloudy/brown
:						
:						
:						
:						
:						
:						
:						

Field Notes:

FIELD SAMPLING DATA SHEET

Job Location: Former Lemoine Sausage Factory	Job #: 70-04578.00
630 29th Avenue	Date Purged: 6/23/2004
Oakland, California	Purge Method: disposable bailer
Sampling Location: MW-12	Date & Time Samp 6/23/2004 9:35
Top of Casing: 14.05 (ft, msl)	Sampling Method: disposable bailer
Depth to Water: 5.78'	Sample Type: TPHG/BTEX /8010 MS
Groundwater Elevation 8.27'	Preservatives: HCL
Well Bottom -0.95	# of Containers: 6
Water Column: 9.22'	Field Tech: MR
Well Casing Volume: 1.48 gal (WC* 0.16)	Weather Conditions:
Casing Volumes Purged: 1	
Purge Rate:	2" dia well

Time	Volume Removed (gal)	pH	Specific Conductivity (µmhos/cm)	Redox Potential (mVolts)	Temperature (°F or °C)	Turbidity (Visual)
9:15	0	6.80	1.914	22	19.9	clear
9:18	1.5	6.83	1.997	20	20.3	"
9:21	1.5	6.92	2.16	16	19.8	"
9:24	1.5	6.93	1.995	16	19.5	"
9:27	1.5	6.95	1.960	14	18.9	clear/brown
:						
:						
:						
:						
:						
:						
:						
:						

Field Notes:

FIELD SAMPLING DATA SHEET

Job Location: Former Lemoine Sausage Factory	Job #: 70-04578.00
630 29th Avenue	Date Purged: 6/23/2004
Oakland, California	Purge Method: disposable bailer
Sampling Location: MW-13	Date & Time Samp 6/23/2004 10:45
Top of Casing: 13.39' (ft, msl)	Sampling Method: disposable bailer
Depth to Water: 6.12'	Sample Type: TPHG/BTEX/8010 MS
Groundwater Elevation 7.27'	Preservatives: HCL
Well Bottom -1.61	# of Containers: 6
Water Column: 8.88'	Field Tech: MR
Well Casing Volume: 1.42 gal (WC* 0.16)	Weather Conditions: overcast
Casing Volumes Purged: 1.1	
Purge Rate:	2" dia well

Time	Volume Removed (gal)	pH	Specific Conductivity (µmhos/cm)	Redox Potential (mVolts)	Temperature (°F or °C)	Turbidity (Visual)
10:25	0	7.57	1.025	21	21.2	clear
10:28	1.5	7.50	.902	17	21.3	"
10:31	1.5	7.47	.883	15	21.2	"
10:35	1.5	7.53	.869	17	20.4	"
10:38	1.5	7.47	.858	12	19.9	clear/clearly
:						
:						
:						
:						
:						
:						
:						
:						

Field Notes:

APPENDIX B

SECOND QUARTER 2004

**LABORATORY ANALYTICAL DATA SHEETS AND CHAIN-OF-
CUSTODY DOCUMENTATION**



Curtis & Tompkins, Ltd., Analytical Laboratories, Since 1878

2323 Fifth Street, Berkeley, CA 94710, Phone (510) 486-0900

A N A L Y T I C A L R E P O R T

Prepared for:

Clayton Group Services
6920 Koll Center Parkway
Suite 216
Pleasanton, CA 94566

Date: 09-JUL-04
Lab Job Number: 173038
Project ID: 70-04578.00
Location: Sausage Factory

This data package has been reviewed for technical correctness and completeness. Release of this data has been authorized by the Laboratory Manager or the Manager's designee, as verified by the following signatures. The results contained in this report meet all requirements of NELAC and pertain only to those samples which were submitted for analysis.

Reviewed by: 
Project Manager

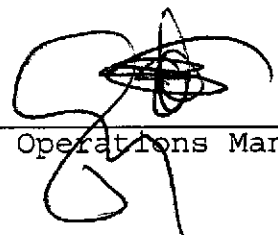
Reviewed by: 
Operations Manager

This package may be reproduced only in its entirety.

Laboratory Number: 173038
Client: Clayton Group Services
Location: Sausage Factory
Project #: 70-04578.00

Receipt Date: 06/23/04

CASE NARRATIVE

This hardcopy data package contains sample and QC results for ten water samples that were received on June 23rd, 2004. The samples were received cold and intact.

Gasoline and BTXE by EPA 8015B/8021B: High surrogate recoveries were observed for Trifluorotoluene and Bromofluorobenzene in sample MW-13 C&T#173038-010 due to coelution with the hydrocarbons peaks. High surrogate recovery was observed for Trifluorotoluene in the LCS and matrix spike (MW-07, C&T#173038-004) due to coelution with the gasoline standard. No other analytical problems were encountered.

Purgeable Halocarbons by GC/MS EPA 8260B: No analytical problems were encountered.

Curtis & Tompkins Laboratories Analytical Report

Lab #:	173038	Location:	Sausage Factory
Client:	Clayton Group Services	Prep:	EPA 5030B
Project#:	70-04578.00		
Matrix:	Water	Sampled:	06/23/04
Units:	ug/L	Received:	06/23/04
Batch#:	92233		

Field ID:	MW-01	Diln Fac:	10.00
Type:	SAMPLE	Analyzed:	06/23/04
Lab ID:	173038-001		

Analyte	Result	RL	Analysis
Gasoline C7-C12	25,000	500	EPA 8015B
Benzene	2,700	5.0	EPA 8021B
Toluene	1,700	5.0	EPA 8021B
Ethylbenzene	680	5.0	EPA 8021B
m,p-Xylenes	1,300	5.0	EPA 8021B
o-Xylene	1,000	5.0	EPA 8021B

Surrogate	%REC	Limits	Analysis
Trifluorotoluene (FID)	126	74-142	EPA 8015B
Bromofluorobenzene (FID)	116	80-139	EPA 8015B
Trifluorotoluene (PID)	104	55-139	EPA 8021B
Bromofluorobenzene (PID)	110	62-134	EPA 8021B

Field ID:	MW-02	Lab ID:	173038-002
Type:	SAMPLE	Analyzed:	06/24/04

Analyte	Result	RL	Diln Fac	Analysis
Gasoline C7-C12	33,000	1,000	20.00	EPA 8015B
Benzene	8,200	20	40.00	EPA 8021B
Toluene	1,800	10	20.00	EPA 8021B
Ethylbenzene	870	10	20.00	EPA 8021B
m,p-Xylenes	1,600	10	20.00	EPA 8021B
o-Xylene	330	10	20.00	EPA 8021B

Surrogate	%REC	Limits	Diln Fac	Analysis
Trifluorotoluene (FID)	110	74-142	20.00	EPA 8015B
Bromofluorobenzene (FID)	107	80-139	20.00	EPA 8015B
Trifluorotoluene (PID)	107	55-139	20.00	EPA 8021B
Bromofluorobenzene (PID)	107	62-134	20.00	EPA 8021B

*= Value outside of QC limits; see narrative
 C= Presence confirmed, but RPD between columns exceeds 40%
 Y= Sample exhibits chromatographic pattern which does not resemble standard
 Z= Sample exhibits unknown single peak or peaks
 ND= Not Detected
 RL= Reporting Limit

Chromatogram

Sample Name : 173038-001,92233

Sample #: a1.0

Page 1 of 1

FileName : G:\GC05\DATA\175G008.raw

Date : 6/25/04 08:19 AM

Method : TVHBTXE

Time of Injection: 6/23/04 08:04 PM

Start Time : 0.00 min End Time : 25.00 min

Low Point : -33.83 mV

High Point : 970.27 mV

Scale Factor: 1.0

Plot Offset: -34 mV

Plot Scale: 1004.1 mV

MW-01

Response [mV]

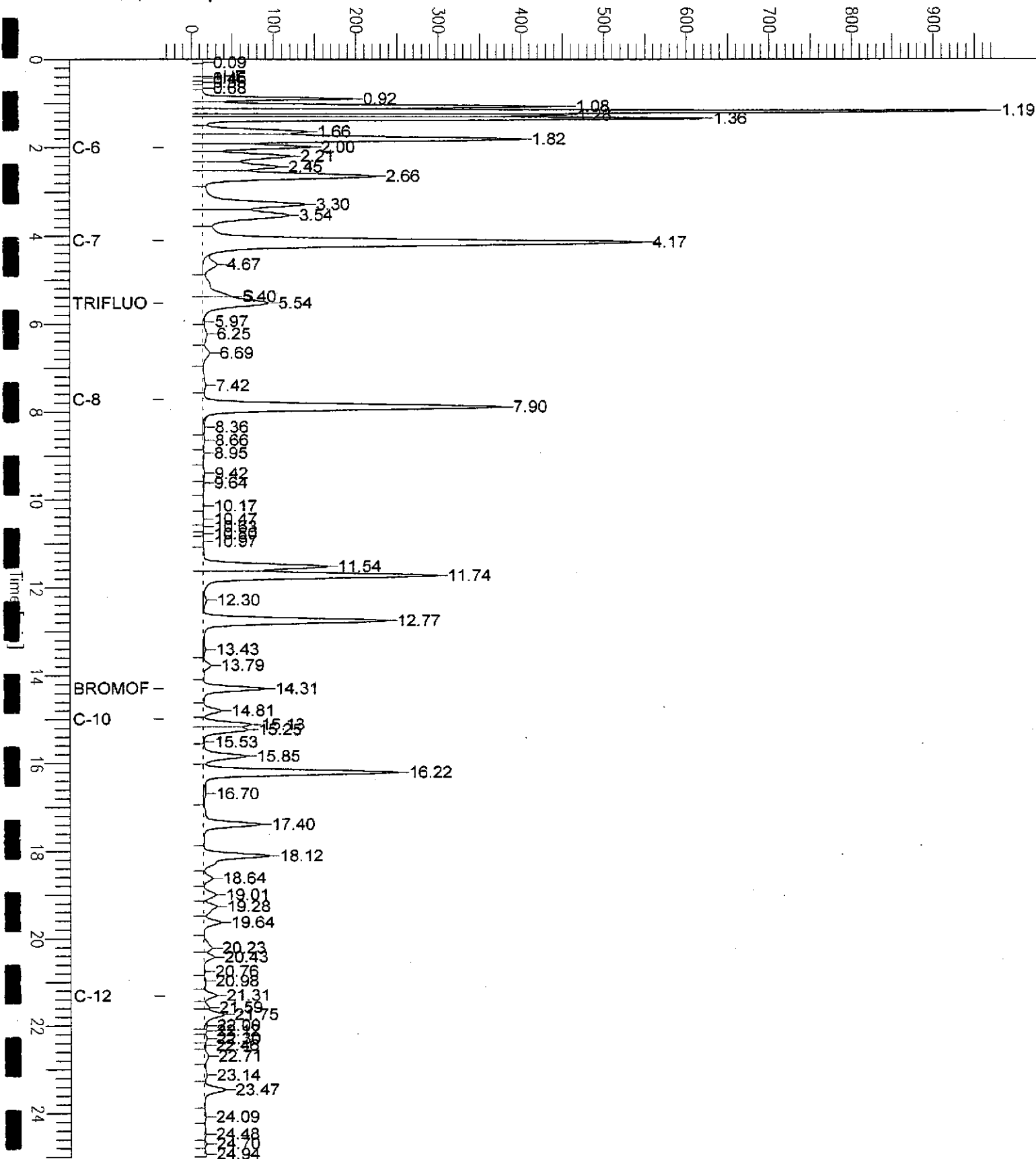

Chromatogram

Sample Name : 173038-002,92233
FileName : G:\GC05\DATA\175G009.raw
Method : TVHBTXE
Start Time : 0.00 min End Time : 25.00 min
Scale Factor: 1.0 Plot Offset: -27 mV

Sample #: a1.0 Page 1 of 1
Date : 6/24/04 08:05 AM
Time of Injection: 6/24/04 07:40 AM
Low Point : -27.16 mV High Point : 837.23 mV
Plot Scale: 864.4 mV

MW-02

Response [mV]

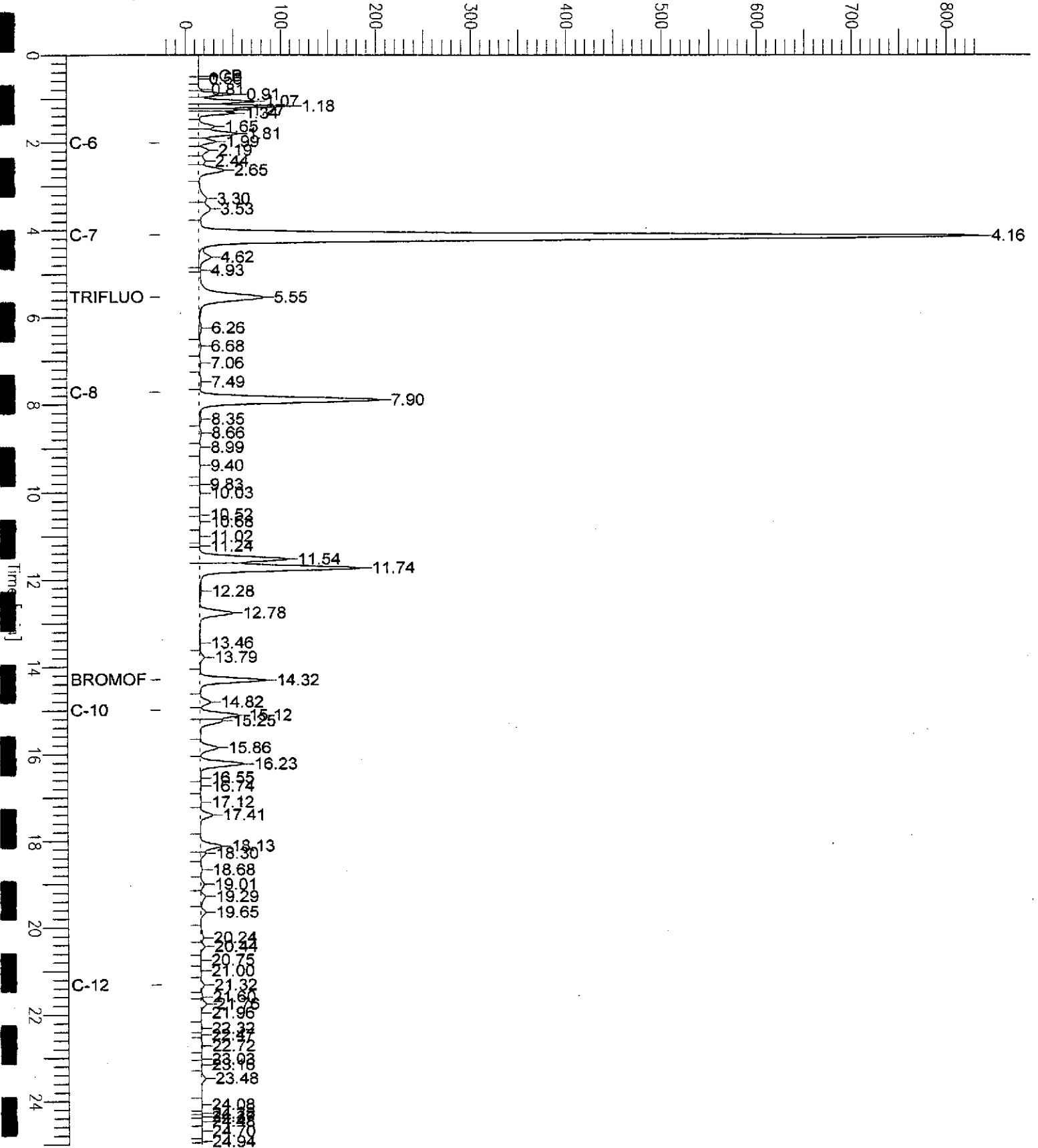

Curtis & Tompkins Laboratories Analytical Report

Lab #:	173038	Location:	Sausage Factory
Client:	Clayton Group Services	Prep:	EPA 5030B
Project#:	70-04578.00		
Matrix:	Water	Sampled:	06/23/04
Units:	ug/L	Received:	06/23/04
Batch#:	92233		

Field ID: MW-06 Diln Fac: 1.000
 Type: SAMPLE Analyzed: 06/23/04
 Lab ID: 173038-003

Analyte	Result	RL	Analysis
Gasoline C7-C12	63	50	EPA 8015B
Benzene	ND	0.50	EPA 8021B
Toluene	ND	0.50	EPA 8021B
Ethylbenzene	ND	0.50	EPA 8021B
m,p-Xylenes	ND	0.50	EPA 8021B
o-Xylene	ND	0.50	EPA 8021B

Surrogate	%REC	Limits	Analysis
Trifluorotoluene (FID)	106	74-142	EPA 8015B
Bromofluorobenzene (FID)	110	80-139	EPA 8015B
Trifluorotoluene (PID)	103	55-139	EPA 8021B
Bromofluorobenzene (PID)	109	62-134	EPA 8021B

Field ID: MW-07 Diln Fac: 1.000
 Type: SAMPLE Analyzed: 06/24/04
 Lab ID: 173038-004

Analyte	Result	RL	Analysis
Gasoline C7-C12	ND	50	EPA 8015B
Benzene	ND	0.50	EPA 8021B
Toluene	ND	0.50	EPA 8021B
Ethylbenzene	ND	0.50	EPA 8021B
m,p-Xylenes	ND	0.50	EPA 8021B
o-Xylene	ND	0.50	EPA 8021B

Surrogate	%REC	Limits	Analysis
Trifluorotoluene (FID)	105	74-142	EPA 8015B
Bromofluorobenzene (FID)	114	80-139	EPA 8015B
Trifluorotoluene (PID)	100	55-139	EPA 8021B
Bromofluorobenzene (PID)	115	62-134	EPA 8021B

*= Value outside of QC limits; see narrative
 C= Presence confirmed, but RPD between columns exceeds 40%
 Y= Sample exhibits chromatographic pattern which does not resemble standard
 Z= Sample exhibits unknown single peak or peaks
 D= Not Detected
 RL= Reporting Limit

Chromatogram

Sample Name : 173038-003,92233

Sample #: a7.0

Page 1 of 1

FileName : G:\GC05\DATA\175G005.raw

Date : 6/23/04 06:54 PM

Method : TVHBTXE

Time of Injection: 6/23/04 06:28 PM

Start Time : 0.00 min End Time : 25.00 min

Low Point : 8.43 mV

High Point : 123.31 mV

Scale Factor: 1.0

Plot Offset: 8 mV

Plot Scale: 114.9 mV

MW-06

Response [mV]

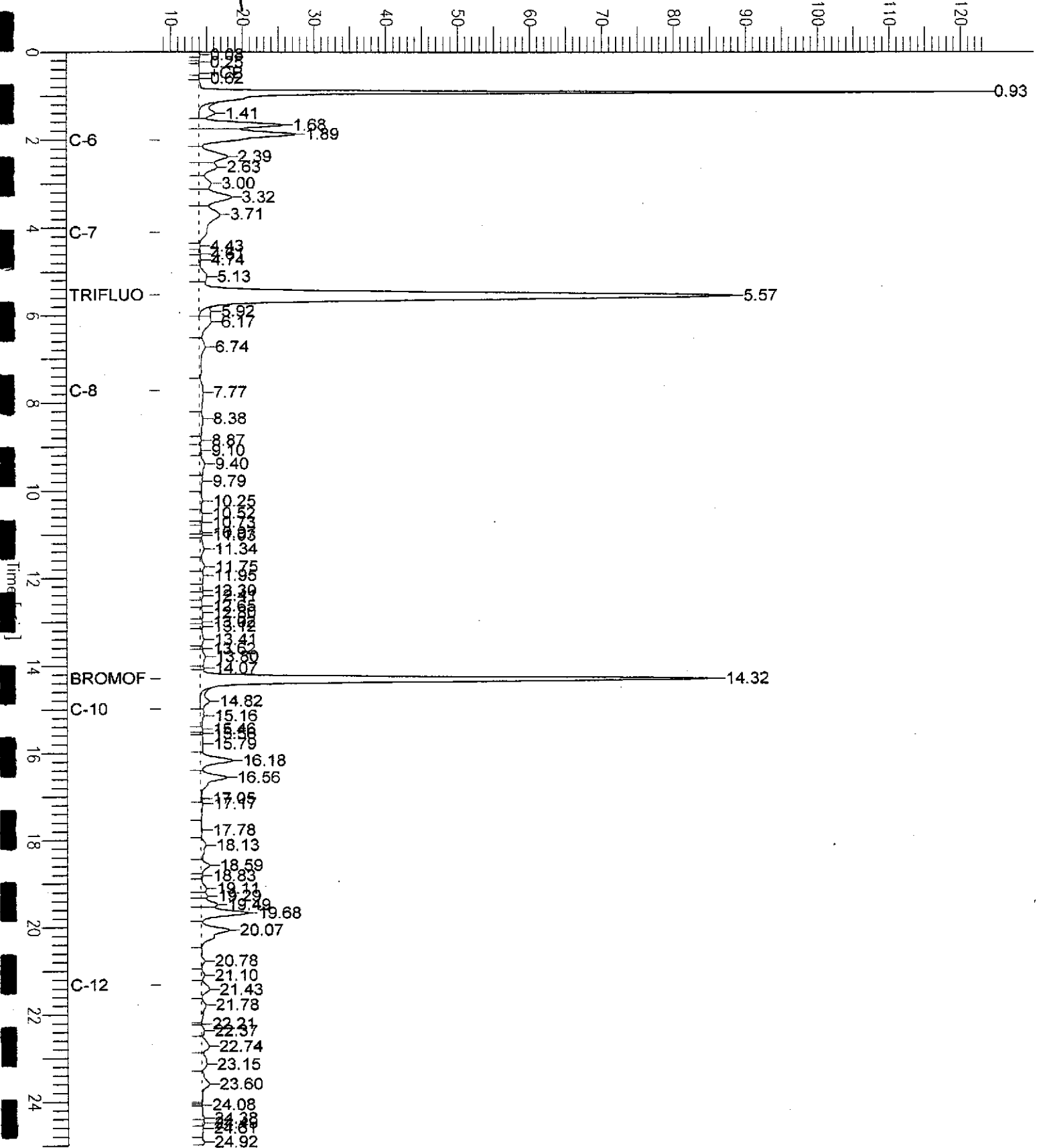

Curtis & Tompkins Laboratories Analytical Report

Lab #:	173038	Location:	Sausage Factory
Client:	Clayton Group Services	Prep:	EPA 5030B
Project#:	70-04578.00		
Matrix:	Water	Sampled:	06/23/04
Units:	ug/L	Received:	06/23/04
Batch#:	92233		

Field ID:	MW-08	Diln Fac:	2.000
Type:	SAMPLE	Analyzed:	06/23/04
Lab ID:	173038-005		

Analyte	Result	RL	Analysis
Gasoline C7-C12	4,600	100	EPA 8015B
Benzene	570	1.0	EPA 8021B
Toluene	2.9	1.0	EPA 8021B
Ethylbenzene	100	1.0	EPA 8021B
m,p-Xylenes	ND	1.0	EPA 8021B
o-Xylene	1.5 C	1.0	EPA 8021B

Surrogate	%REC	Limits	Analysis
Trifluorotoluene (FID)	115	74-142	EPA 8015B
Bromofluorobenzene (FID)	124	80-139	EPA 8015B
Trifluorotoluene (PID)	115	55-139	EPA 8021B
Bromofluorobenzene (PID)	112	62-134	EPA 8021B

Field ID:	MW-09	Diln Fac:	40.00
Type:	SAMPLE	Analyzed:	06/24/04
Lab ID:	173038-006		

Analyte	Result	RL	Analysis
Gasoline C7-C12	53,000	2,000	EPA 8015B
Benzene	12,000	20	EPA 8021B
Toluene	2,600	20	EPA 8021B
Ethylbenzene	1,100	20	EPA 8021B
m,p-Xylenes	3,800	20	EPA 8021B
o-Xylene	1,000	20	EPA 8021B

Surrogate	%REC	Limits	Analysis
Trifluorotoluene (FID)	114	74-142	EPA 8015B
Bromofluorobenzene (FID)	107	80-139	EPA 8015B
Trifluorotoluene (PID)	108	55-139	EPA 8021B
Bromofluorobenzene (PID)	107	62-134	EPA 8021B

*= Value outside of QC limits; see narrative
 C= Presence confirmed, but RPD between columns exceeds 40%
 Y= Sample exhibits chromatographic pattern which does not resemble standard
 Z= Sample exhibits unknown single peak or peaks
 ND= Not Detected
 RL= Reporting Limit

Chromatogram

Sample Name : 173038-005,92233

Sample # : a1.9

Page 1 of 1

FileName : G:\GC05\DATA\175G007.raw

Date : 6/25/04 08:19 AM

Method : TVHBTXE

Time of Injection: 6/23/04 07:32 PM

Start Time : 0.00 min End Time : 25.00 min

Low Point : -33.90 mV

High Point : 969.76 mV

Scale Factor: 1.0

Plot Offset: -34 mV

Plot Scale: 1003.7 mV

MW-08

Response [mV]

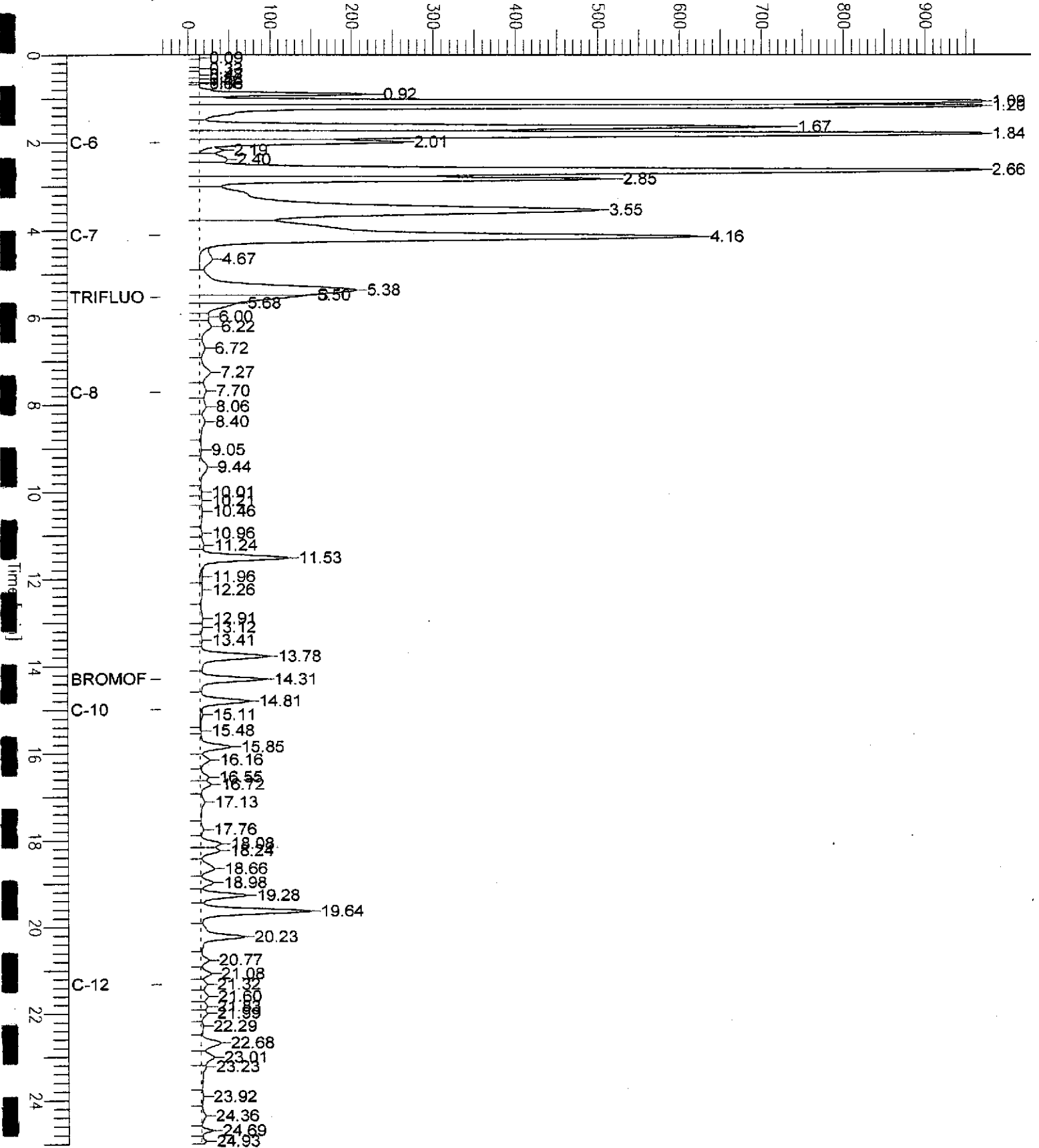

Chromatogram

Sample Name : 173038-006,92233

Sample #: a1.0

Page 1 of 1

FileName : G:\GC05\DATA\175G010.raw

Date : 6/24/04 08:37 AM

Method : TVHBTXE

Time of Injection: 6/24/04 08:12 AM

Start Time : 0.00 min End Time : 25.00 min

Low Point : -13.39 mV

High Point : 564.11 mV

Scale Factor: 1.0

Plot Offset: -13 mV

Plot Scale: 577.5 mV

MW-09

Response [mV]

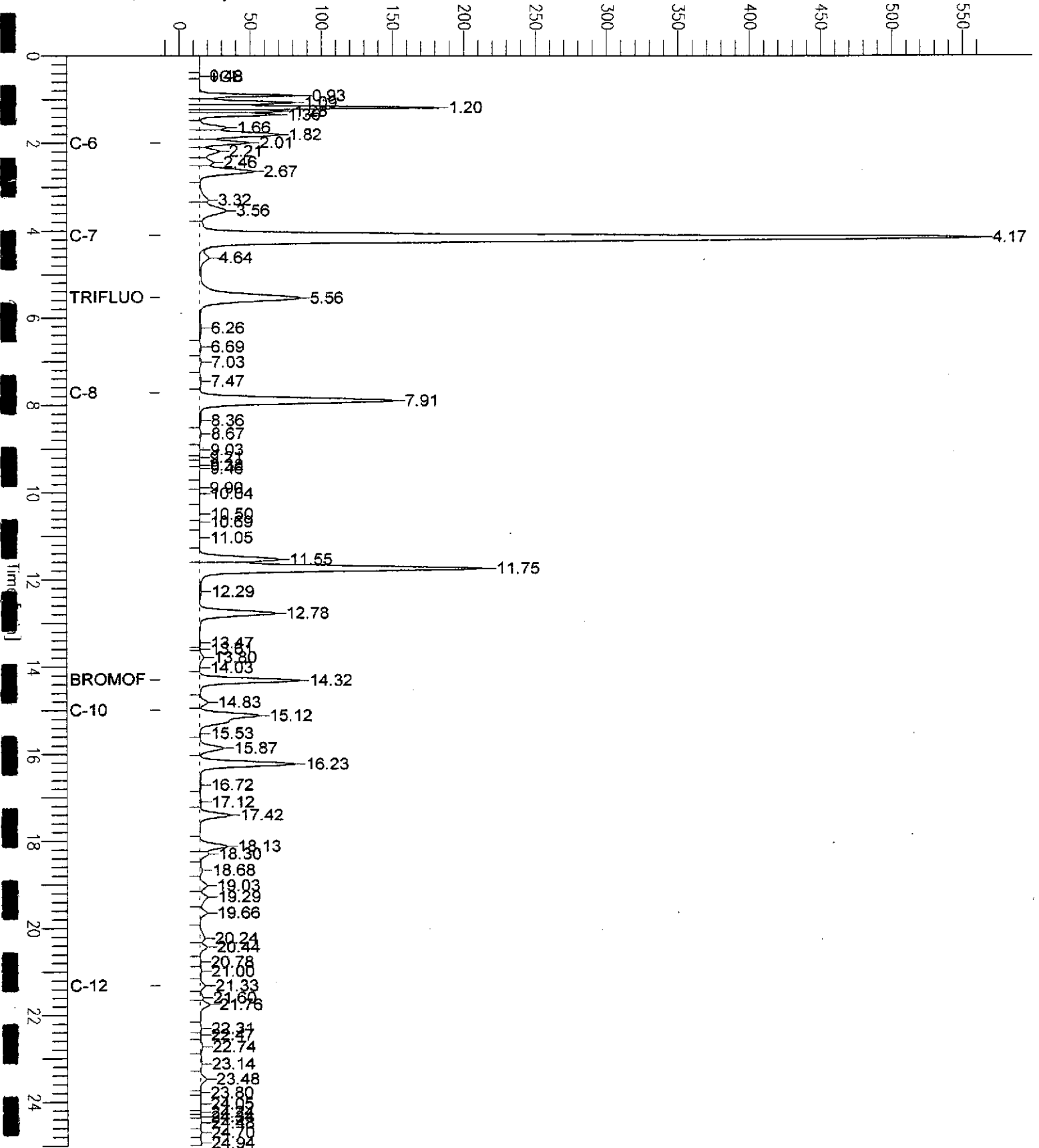

Curtis & Tompkins Laboratories Analytical Report

Lab #:	173038	Location:	Sausage Factory
Client:	Clayton Group Services	Prep:	EPA 5030B
Project#:	70-04578.00		
Matrix:	Water	Sampled:	06/23/04
Units:	ug/L	Received:	06/23/04
Batch#:	92233		

Field ID:	MW-10	Diln Fac:	1.000
Type:	SAMPLE	Analyzed:	06/24/04
Lab ID:	173038-007		

Analyte	Result	RL	Analysis
Gasoline C7-C12	ND	50	EPA 8015B
Benzene	ND	0.50	EPA 8021B
Toluene	ND	0.50	EPA 8021B
Ethylbenzene	ND	0.50	EPA 8021B
m,p-Xylenes	ND	0.50	EPA 8021B
o-Xylene	ND	0.50	EPA 8021B

Surrogate	%REC	Limits	Analysis
Trifluorotoluene (FID)	98	74-142	EPA 8015B
Bromofluorobenzene (FID)	106	80-139	EPA 8015B
Trifluorotoluene (PID)	97	55-139	EPA 8021B
Bromofluorobenzene (PID)	107	62-134	EPA 8021B

Field ID:	MW-11	Diln Fac:	1.000
Type:	SAMPLE	Analyzed:	06/24/04
Lab ID:	173038-008		

Analyte	Result	RL	Analysis
Gasoline C7-C12	ND	50	EPA 8015B
Benzene	ND	0.50	EPA 8021B
Toluene	ND	0.50	EPA 8021B
Ethylbenzene	ND	0.50	EPA 8021B
m,p-Xylenes	ND	0.50	EPA 8021B
o-Xylene	ND	0.50	EPA 8021B

Surrogate	%REC	Limits	Analysis
Trifluorotoluene (FID)	104	74-142	EPA 8015B
Bromofluorobenzene (FID)	113	80-139	EPA 8015B
Trifluorotoluene (PID)	105	55-139	EPA 8021B
Bromofluorobenzene (PID)	113	62-134	EPA 8021B

*= Value outside of QC limits; see narrative
 C= Presence confirmed, but RPD between columns exceeds 40%
 Y= Sample exhibits chromatographic pattern which does not resemble standard
 Z= Sample exhibits unknown single peak or peaks
 ND= Not Detected
 RL= Reporting Limit

Curtis & Tompkins Laboratories Analytical Report

Lab #:	173038	Location:	Sausage Factory
Client:	Clayton Group Services	Prep:	EPA 5030B
Project#:	70-04578.00		
Matrix:	Water	Sampled:	06/23/04
Units:	ug/L	Received:	06/23/04
Batch#:	92233		

Field ID:	MW-12	Diln Fac:	1.000
Type:	SAMPLE	Analyzed:	06/24/04
Lab ID:	173038-009		

Analyte	Result	RL	Analysis
Gasoline C7-C12	99 Y Z	50	EPA 8015B
Benzene	ND	0.50	EPA 8021B
Toluene	ND	0.50	EPA 8021B
Ethylbenzene	ND	0.50	EPA 8021B
m,p-Xylenes	ND	0.50	EPA 8021B
o-Xylene	ND	0.50	EPA 8021B

Surrogate	%REC	Limits	Analysis
Trifluorotoluene (FID)	104	74-142	EPA 8015B
Bromofluorobenzene (FID)	110	80-139	EPA 8015B
Trifluorotoluene (PID)	99	55-139	EPA 8021B
Bromofluorobenzene (PID)	111	62-134	EPA 8021B

Field ID:	MW-13	Diln Fac:	2.000
Type:	SAMPLE	Analyzed:	06/23/04
Lab ID:	173038-010		

Analyte	Result	RL	Analysis
Gasoline C7-C12	7,000	100	EPA 8015B
Benzene	140 C	1.0	EPA 8021B
Toluene	25 C	1.0	EPA 8021B
Ethylbenzene	88	1.0	EPA 8021B
m,p-Xylenes	12 C	1.0	EPA 8021B
o-Xylene	9.1	1.0	EPA 8021B

Surrogate	%REC	Limits	Analysis
Trifluorotoluene (FID)	151 *	74-142	EPA 8015B
Bromofluorobenzene (FID)	163 *	80-139	EPA 8015B
Trifluorotoluene (PID)	158 *	55-139	EPA 8021B
Bromofluorobenzene (PID)	136 *	62-134	EPA 8021B

*= Value outside of QC limits; see narrative
 C= Presence confirmed, but RPD between columns exceeds 40%
 Y= Sample exhibits chromatographic pattern which does not resemble standard
 Z= Sample exhibits unknown single peak or peaks
 D= Not Detected
 RL= Reporting Limit

Chromatogram

Sample Name : 173038-009,92233

Sample #: a7.0

Page 1 of 1

File Name : G:\GC05\DATA\175G017.raw

Date : 6/24/04 03:59 PM

Method : TVHBTXE

Time of Injection: 6/24/04 03:34 PM

Start Time : 0.00 min

End Time : 25.00 min

Low Point : 7.61 mV

High Point : 135.56 mV

Scale Factor: 1.0

Plot Offset: 8 mV

Plot Scale: 128.0 mV

MW-12

Response [mV]

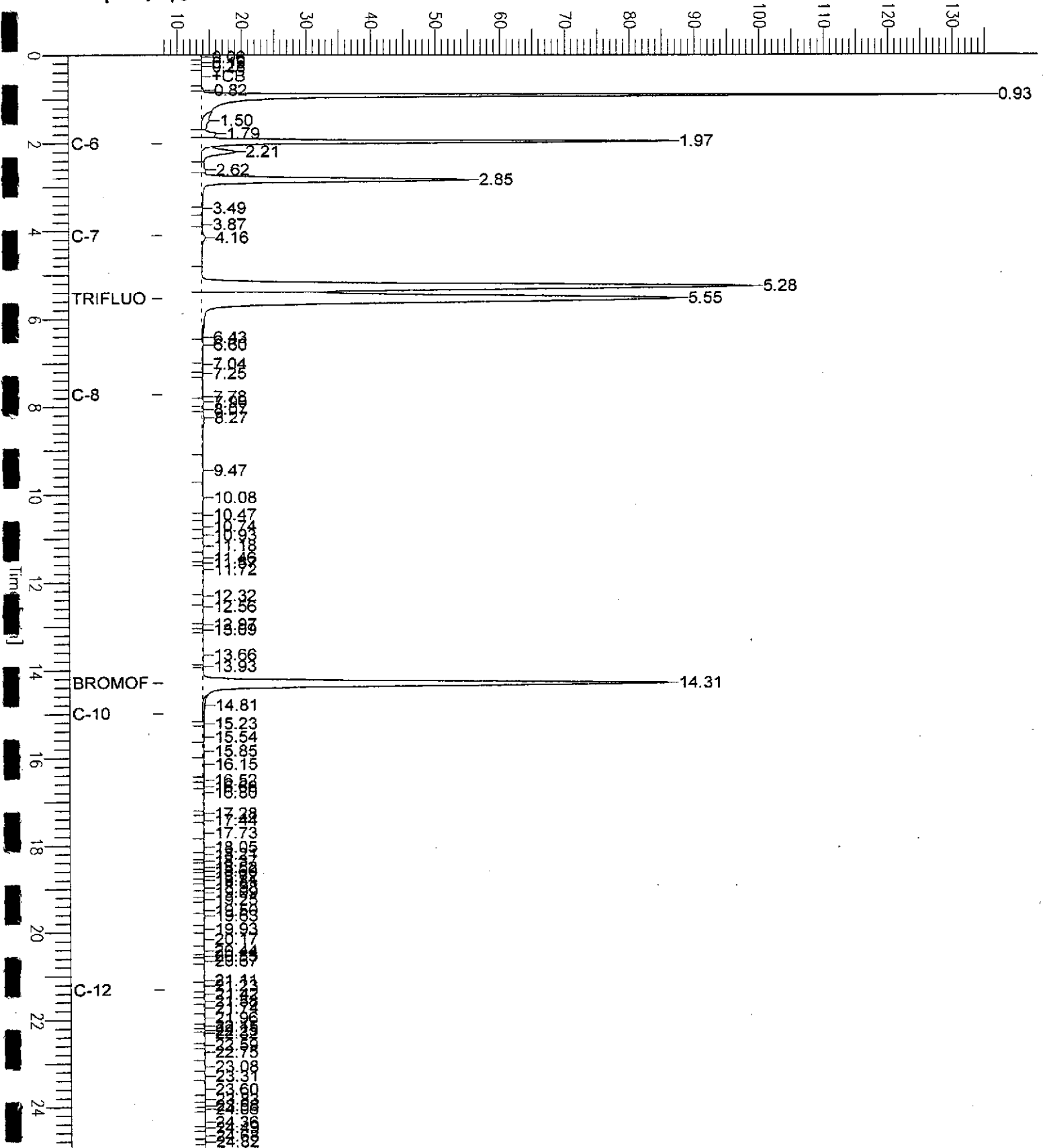

Chromatogram

Sample Name : 173038-010,92233

Sample #: a1.0

Page 1 of 1

FileName : G:\GC05\DATA\175G006.raw

Date : 6/25/04 08:19 AM

Method : TVHBTXE

Time of Injection: 6/23/04 07:00 PM

Start Time : 0.00 min

End Time : 25.00 min

Low Point : -33.88 mV

High Point : 969.68 mV

Scale Factor: 1.0

Plot Offset: -34 mV

Plot Scale: 1003.6 mV

MW-13

Response [mV]

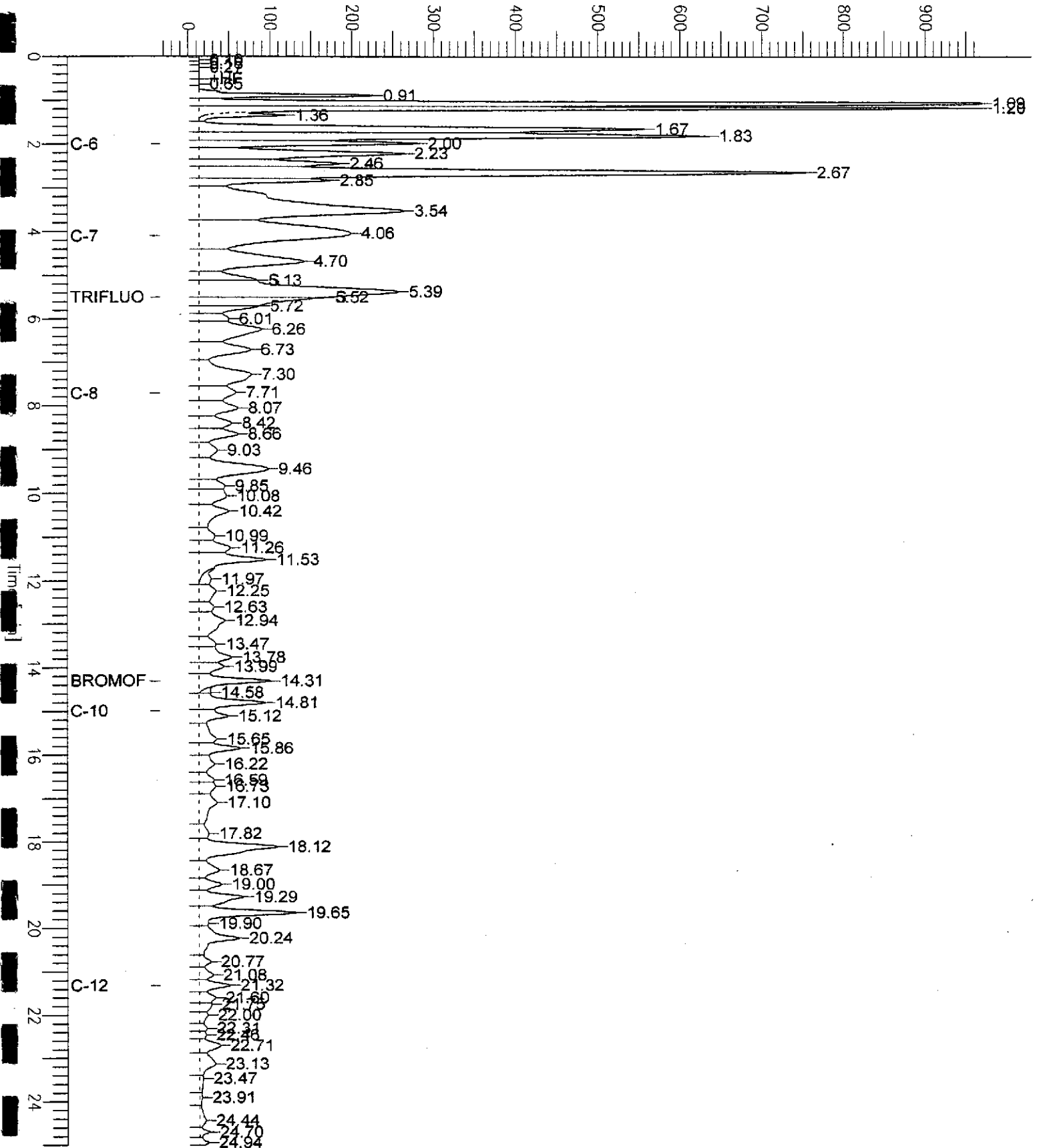

Chromatogram

Sample Name : ccv/lcs.qc255235,92233,04ws1035,5/5000
FileName : G:\GC05\DATA\175g002.raw
Method : TVHBTXE
Start Time : 0.00 min End Time : 25.00 min
Scale Factor : 1.0 Plot Offset : -1 mV

Sample # :
Date : 6/23/04 05:28 PM
Time of Injection: 6/23/04 04:12 PM
Low Point : -0.95 mV High Point : 311.89 mV
Plot Scale: 312.8 mV

BTXE / Gasoline Standard

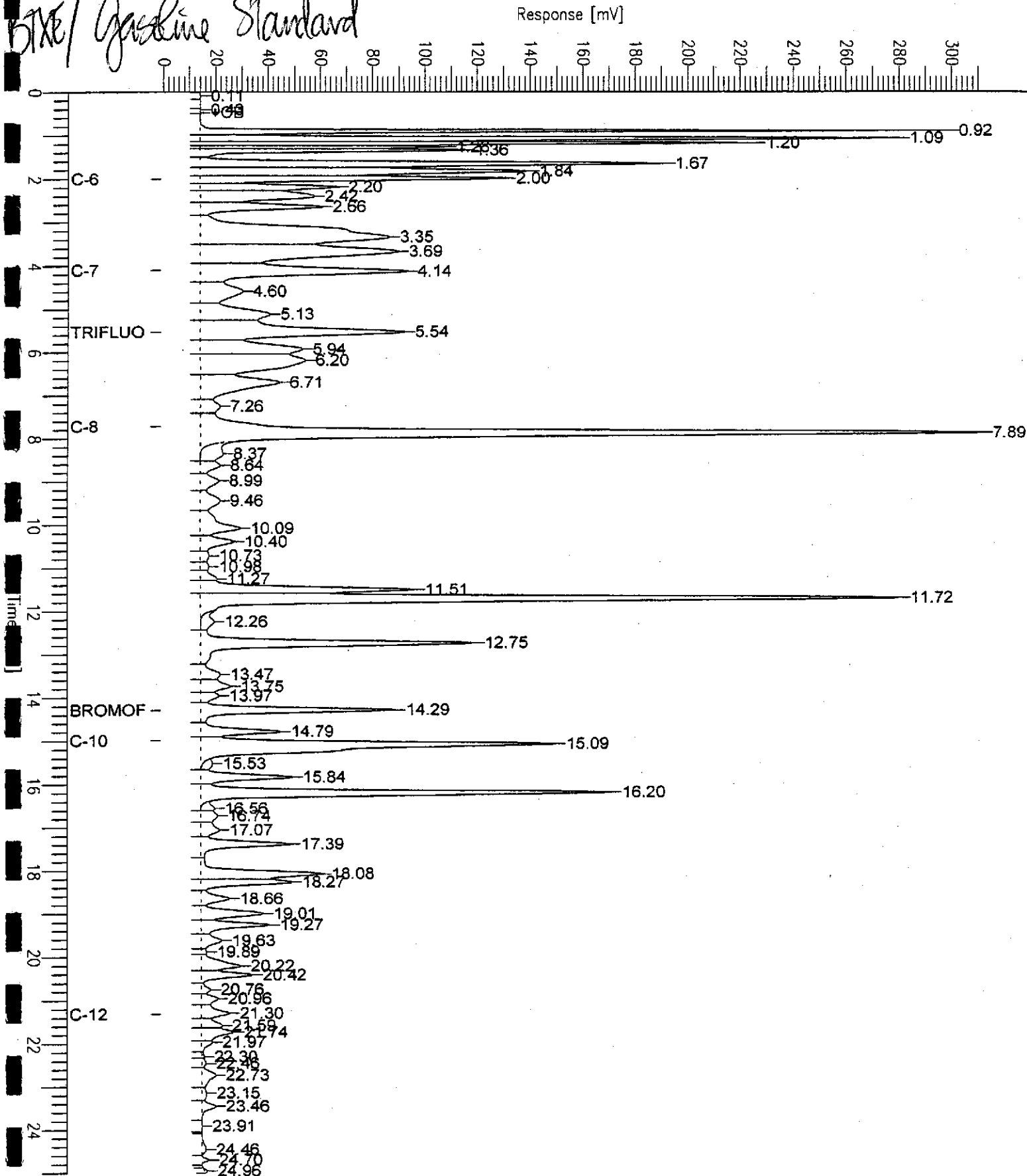

Curtis & Tompkins Laboratories Analytical Report

Lab #:	173038	Location:	Sausage Factory
Client:	Clayton Group Services	Prep:	EPA 5030B
Project#:	70-04578.00		
Matrix:	Water	Sampled:	06/23/04
Units:	ug/L	Received:	06/23/04
Batch#:	92233		

Type: BLANK Diln Fac: 1.000
 Lab ID: QC255233 Analyzed: 06/23/04

Analyte	Result	RL	Analysis
Gasoline C7-C12	ND	50	EPA 8015B
Benzene	ND	0.50	EPA 8021B
Toluene	ND	0.50	EPA 8021B
Ethylbenzene	ND	0.50	EPA 8021B
m,p-Xylenes	ND	0.50	EPA 8021B
o-Xylene	ND	0.50	EPA 8021B

Surrogate	%REC	Limits	Analysis
Trifluorotoluene (FID)	101	74-142	EPA 8015B
Bromofluorobenzene (FID)	100	80-139	EPA 8015B
Trifluorotoluene (PID)	99	55-139	EPA 8021B
Bromofluorobenzene (PID)	101	62-134	EPA 8021B

*= Value outside of QC limits; see narrative
 C= Presence confirmed, but RPD between columns exceeds 40%
 Y= Sample exhibits chromatographic pattern which does not resemble standard
 Z= Sample exhibits unknown single peak or peaks
 D= Not Detected
 RL= Reporting Limit

Batch QC Report

Curtis & Tompkins Laboratories Analytical Report

Lab #:	173038	Location:	Sausage Factory
Client:	Clayton Group Services	Prep:	EPA 5030B
Project#:	70-04578.00	Analysis:	EPA 8021B
Type:	LCS	Diln Fac:	1.000
Lab ID:	QC255234	Batch#:	92233
Matrix:	Water	Analyzed:	06/23/04
Units:	ug/L		

Analyte	Spiked	Result	%REC	Limits
Benzene	20.00	20.51	103	80-120
Toluene	20.00	20.07	100	80-120
Ethylbenzene	20.00	20.23	101	80-120
m,p-Xylenes	20.00	21.43	107	80-120
o-Xylene	20.00	20.89	104	80-120

Surrogate	%REC	Limits
Trifluorotoluene (PID)	101	55-139
Bromofluorobenzene (PID)	107	62-134

Batch QC Report

Curtis & Tompkins Laboratories Analytical Report

Lab #:	173038	Location:	Sausage Factory
Client:	Clayton Group Services	Prep:	EPA 5030B
Project#:	70-04578.00	Analysis:	EPA 8015B
Type:	LCS	Diln Fac:	1.000
Lab ID:	QC255235	Batch#:	92233
Matrix:	Water	Analyzed:	06/23/04
Units:	ug/L		

Analyte	Spiked	Result	%REC	Limits
Gasoline C7-C12	2,000	2,137	107	80-120

Surrogate	%REC	Limits
Trifluorotoluene (FID)	145 *	74-142
Bromofluorobenzene (FID)	120	80-139

Batch QC Report

Curtis & Tompkins Laboratories Analytical Report

Lab #:	173038	Location:	Sausage Factory
Client:	Clayton Group Services	Prep:	EPA 5030B
Project#:	70-04578.00	Analysis:	EPA 8015B
Field ID:	MW-07	Batch#:	92233
MSS Lab ID:	173038-004	Sampled:	06/23/04
Matrix:	Water	Received:	06/23/04
Units:	ug/L	Analyzed:	06/24/04
Diln Fac:	1.000		

Type: MS Lab ID: QC255250

Analyte	MSS Result	Spiked	Result	%REC	Limits
Gasoline C7-C12	13.89	2,000	2,090	104	80-120

Surrogate	%REC	Limits
Trifluorotoluene (FID)	144 *	74-142
Bromofluorobenzene (FID)	124	80-139

Type: MSD Lab ID: QC255251

Analyte	Spiked	Result	%REC	Limits	RPD	Lim
Gasoline C7-C12	2,000	2,048	102	80-120	2	20

Surrogate	%REC	Limits
Trifluorotoluene (FID)	139	74-142
Bromofluorobenzene (FID)	119	80-139

*= Value outside of QC limits; see narrative

RPD= Relative Percent Difference

Purgeable Halocarbons by GC/MS

Lab #:	173038	Location:	Sausage Factory
Client:	Clayton Group Services	Prep:	EPA 5030B
Project#:	70-04578.00	Analysis:	EPA 8260B
Field ID:	MW-01	Batch#:	92251
Lab ID:	173038-001	Sampled:	06/23/04
Matrix:	Water	Received:	06/23/04
Units:	ug/L	Analyzed:	06/24/04
Diln Fac:	5.000		

Analyte	Result	RL
Chloromethane	ND	5.0
Vinyl Chloride	ND	2.5
Bromomethane	ND	5.0
Chloroethane	ND	5.0
Trichlorofluoromethane	ND	5.0
Freon 113	ND	5.0
1,1-Dichloroethene	ND	2.5
Methylene Chloride	ND	100
trans-1,2-Dichloroethene	ND	2.5
1,1-Dichloroethane	ND	2.5
cis-1,2-Dichloroethene	ND	2.5
Chloroform	ND	5.0
1,1,1-Trichloroethane	ND	2.5
Carbon Tetrachloride	ND	2.5
1,2-Dichloroethane	ND	2.5
Trichloroethene	ND	2.5
1,2-Dichloropropane	ND	2.5
Bromodichloromethane	ND	2.5
cis-1,3-Dichloropropene	ND	2.5
trans-1,3-Dichloropropene	ND	2.5
1,1,2-Trichloroethane	ND	2.5
Tetrachloroethene	ND	2.5
Dibromochloromethane	ND	2.5
Chlorobenzene	ND	2.5
Bromoform	ND	2.5
1,1,2,2-Tetrachloroethane	ND	2.5
1,3-Dichlorobenzene	ND	2.5
1,4-Dichlorobenzene	ND	2.5
1,2-Dichlorobenzene	ND	2.5

Surrogate	%REC	Limits
1,2-Dichloroethane-d4	104	80-124
Toluene-d8	98	80-120
Bromofluorobenzene	97	80-120

Purgeable Halocarbons by GC/MS

Lab #:	173038	Location:	Sausage Factory
Client:	Clayton Group Services	Prep:	EPA 5030B
Project#:	70-04578.00	Analysis:	EPA 8260B
Field ID:	MW-02	Batch#:	92285
Lab ID:	173038-002	Sampled:	06/23/04
Matrix:	Water	Received:	06/23/04
Units:	ug/L	Analyzed:	06/26/04
Diln Fac:	33.33		

Analyte	Result	RL
Chloromethane	ND	33
Vinyl Chloride	ND	17
Bromomethane	ND	33
Chloroethane	ND	33
Trichlorofluoromethane	ND	33
Freon 113	ND	33
1,1-Dichloroethene	ND	17
Methylene Chloride	ND	670
trans-1,2-Dichloroethene	ND	17
1,1-Dichloroethane	ND	17
cis-1,2-Dichloroethene	ND	17
Chloroform	ND	33
1,1,1-Trichloroethane	ND	17
Carbon Tetrachloride	ND	17
1,2-Dichloroethane	ND	17
Trichloroethene	ND	17
1,2-Dichloropropane	ND	17
Bromodichloromethane	ND	17
cis-1,3-Dichloropropene	ND	17
trans-1,3-Dichloropropene	ND	17
1,1,2-Trichloroethane	ND	17
Tetrachloroethene	ND	17
Dibromochloromethane	ND	17
Chlorobenzene	ND	17
Bromoform	ND	17
1,1,2,2-Tetrachloroethane	ND	17
1,3-Dichlorobenzene	ND	17
1,4-Dichlorobenzene	ND	17
1,2-Dichlorobenzene	ND	17

Surrogate	%REC	Limits
1,2-Dichloroethane-d4	94	80-124
Toluene-d8	100	80-120
Bromofluorobenzene	95	80-120

ND= Not Detected

RL= Reporting Limit

Purgeable Halocarbons by GC/MS

Lab #:	173038	Location:	Sausage Factory
Client:	Clayton Group Services	Prep:	EPA 5030B
Project#:	70-04578.00	Analysis:	EPA 8260B
Field ID:	MW-06	Batch#:	92251
Lab ID:	173038-003	Sampled:	06/23/04
Matrix:	Water	Received:	06/23/04
Units:	ug/L	Analyzed:	06/24/04
Diln Fac:	1.000		

Analyte	Result	RL
Chloromethane	ND	1.0
Vinyl Chloride	ND	0.5
Bromomethane	ND	1.0
Chloroethane	ND	1.0
Trichlorofluoromethane	ND	1.0
Freon 113	ND	1.0
1,1-Dichloroethene	ND	0.5
Methylene Chloride	ND	20
trans-1,2-Dichloroethene	ND	0.5
1,1-Dichloroethane	0.8	0.5
cis-1,2-Dichloroethene	ND	0.5
Chloroform	ND	1.0
1,1,1-Trichloroethane	ND	0.5
Carbon Tetrachloride	ND	0.5
1,2-Dichloroethane	ND	0.5
Trichloroethene	ND	0.5
1,2-Dichloropropane	ND	0.5
Bromodichloromethane	ND	0.5
cis-1,3-Dichloropropene	ND	0.5
trans-1,3-Dichloropropene	ND	0.5
1,1,2-Trichloroethane	ND	0.5
Tetrachloroethene	ND	0.5
Dibromochloromethane	ND	0.5
Chlorobenzene	ND	0.5
Bromoform	ND	0.5
1,1,2,2-Tetrachloroethane	ND	0.5
1,3-Dichlorobenzene	ND	0.5
1,4-Dichlorobenzene	ND	0.5
1,2-Dichlorobenzene	ND	0.5

Surrogate	%REC	Limits
1,2-Dichloroethane-d4	93	80-124
Toluene-d8	97	80-120
Bromofluorobenzene	97	80-120

Purgeable Halocarbons by GC/MS

Lab #:	173038	Location:	Sausage Factory
Client:	Clayton Group Services	Prep:	EPA 5030B
Project#:	70-04578.00	Analysis:	EPA 8260B
Field ID:	MW-07	Batch#:	92251
Lab ID:	173038-004	Sampled:	06/23/04
Matrix:	Water	Received:	06/23/04
Units:	ug/L	Analyzed:	06/24/04
Diln Fac:	1.000		

Analyte	Result	RL
Chloromethane	ND	1.0
Vinyl Chloride	ND	0.5
Bromomethane	ND	1.0
Chloroethane	ND	1.0
Trichlorofluoromethane	ND	1.0
Freon 113	ND	1.0
1,1-Dichloroethene	ND	0.5
Methylene Chloride	ND	20
trans-1,2-Dichloroethene	ND	0.5
1,1-Dichloroethane	ND	0.5
cis-1,2-Dichloroethene	ND	0.5
Chloroform	ND	1.0
1,1,1-Trichloroethane	ND	0.5
Carbon Tetrachloride	ND	0.5
1,2-Dichloroethane	ND	0.5
Trichloroethene	ND	0.5
1,2-Dichloropropane	ND	0.5
Bromodichloromethane	ND	0.5
cis-1,3-Dichloropropene	ND	0.5
trans-1,3-Dichloropropene	ND	0.5
1,1,2-Trichloroethane	ND	0.5
Tetrachloroethene	ND	0.5
Dibromochloromethane	ND	0.5
Chlorobenzene	ND	0.5
Bromoform	ND	0.5
1,1,2,2-Tetrachloroethane	ND	0.5
1,3-Dichlorobenzene	ND	0.5
1,4-Dichlorobenzene	ND	0.5
1,2-Dichlorobenzene	ND	0.5

Surrogate	%REC	Limits
1,2-Dichloroethane-d4	94	80-124
Toluene-d8	98	80-120
Bromofluorobenzene	95	80-120

ND= Not Detected
 RL= Reporting Limit
 Page 1 of 1

Purgeable Halocarbons by GC/MS

Lab #:	173038	Location:	Sausage Factory
Client:	Clayton Group Services	Prep:	EPA 5030B
Project#:	70-04578.00	Analysis:	EPA 8260B
Field ID:	MW-08	Batch#:	92285
Lab ID:	173038-005	Sampled:	06/23/04
Matrix:	Water	Received:	06/23/04
Units:	ug/L	Analyzed:	06/26/04
Diln Fac:	16.67		

Analyte	Result	RL
Chloromethane	ND	17
Vinyl Chloride	80	8.3
Bromomethane	ND	17
Chloroethane	ND	17
Trichlorofluoromethane	ND	17
Freon 113	ND	17
1,1-Dichloroethene	ND	8.3
Methylene Chloride	ND	330
trans-1,2-Dichloroethene	50	8.3
1,1-Dichloroethane	ND	8.3
cis-1,2-Dichloroethene	1,300	8.3
Chloroform	ND	17
1,1,1-Trichloroethane	ND	8.3
Carbon Tetrachloride	ND	8.3
1,2-Dichloroethane	ND	8.3
Trichloroethene	ND	8.3
1,2-Dichloropropane	ND	8.3
Bromodichloromethane	ND	8.3
cis-1,3-Dichloropropene	ND	8.3
trans-1,3-Dichloropropene	ND	8.3
1,1,2-Trichloroethane	ND	8.3
Tetrachloroethene	ND	8.3
Dibromochloromethane	ND	8.3
Chlorobenzene	ND	8.3
Bromoform	ND	8.3
1,1,2,2-Tetrachloroethane	ND	8.3
1,3-Dichlorobenzene	ND	8.3
1,4-Dichlorobenzene	ND	8.3
1,2-Dichlorobenzene	ND	8.3

Surrogate	REC	Limits
1,2-Dichloroethane-d4	96	80-124
Toluene-d8	98	80-120
Bromofluorobenzene	96	80-120

Purgeable Halocarbons by GC/MS

Lab #:	173038	Location:	Sausage Factory
Client:	Clayton Group Services	Prep:	EPA 5030B
Project#:	70-04578.00	Analysis:	EPA 8260B
Field ID:	MW-09	Batch#:	92285
Lab ID:	173038-006	Sampled:	06/23/04
Matrix:	Water	Received:	06/23/04
Units:	ug/L	Analyzed:	06/26/04
Diln Fac:	40.00		

Analyte	Result	RL
Chloromethane	ND	40
Vinyl Chloride	ND	20
Bromomethane	ND	40
Chloroethane	ND	40
Trichlorofluoromethane	ND	40
Freon 113	ND	40
1,1-Dichloroethene	ND	20
Methylene Chloride	ND	800
trans-1,2-Dichloroethene	ND	20
1,1-Dichloroethane	ND	20
cis-1,2-Dichloroethene	ND	20
Chloroform	ND	40
1,1,1-Trichloroethane	ND	20
Carbon Tetrachloride	ND	20
1,2-Dichloroethane	ND	20
Trichloroethene	ND	20
1,2-Dichloropropane	ND	20
Bromodichloromethane	ND	20
cis-1,3-Dichloropropene	ND	20
trans-1,3-Dichloropropene	ND	20
1,1,2-Trichloroethane	ND	20
Tetrachloroethene	ND	20
Dibromochloromethane	ND	20
Chlorobenzene	ND	20
Bromoform	ND	20
1,1,2,2-Tetrachloroethane	ND	20
1,3-Dichlorobenzene	ND	20
1,4-Dichlorobenzene	ND	20
1,2-Dichlorobenzene	ND	20

Surrogate	%REC	Limits
1,2-Dichloroethane-d4	95	80-124
Toluene-d8	99	80-120
Bromofluorobenzene	97	80-120

Purgeable Halocarbons by GC/MS

Lab #:	173038	Location:	Sausage Factory
Client:	Clayton Group Services	Prep:	EPA 5030B
Project#:	70-04578.00	Analysis:	EPA 8260B
Field ID:	MW-10	Batch#:	92251
Lab ID:	173038-007	Sampled:	06/23/04
Matrix:	Water	Received:	06/23/04
Units:	ug/L	Analyzed:	06/24/04
Diln Fac:	1.000		

Analyte	Result	RL
Chloromethane	ND	1.0
Vinyl Chloride	ND	0.5
Bromomethane	ND	1.0
Chloroethane	ND	1.0
Trichlorofluoromethane	ND	1.0
Freon 113	ND	1.0
1,1-Dichloroethene	ND	0.5
Methylene Chloride	ND	20
trans-1,2-Dichloroethene	ND	0.5
1,1-Dichloroethane	ND	0.5
cis-1,2-Dichloroethene	ND	0.5
Chloroform	ND	1.0
1,1,1-Trichloroethane	ND	0.5
Carbon Tetrachloride	ND	0.5
1,2-Dichloroethane	ND	0.5
Trichloroethene	ND	0.5
1,2-Dichloropropane	ND	0.5
Bromodichloromethane	ND	0.5
cis-1,3-Dichloropropene	ND	0.5
trans-1,3-Dichloropropene	ND	0.5
1,1,2-Trichloroethane	ND	0.5
Tetrachloroethene	ND	0.5
Dibromochloromethane	ND	0.5
Chlorobenzene	ND	0.5
Bromoform	ND	0.5
1,1,2,2-Tetrachloroethane	ND	0.5
1,3-Dichlorobenzene	ND	0.5
1,4-Dichlorobenzene	ND	0.5
1,2-Dichlorobenzene	ND	0.5

Surrogate	%REC	Limits
1,2-Dichloroethane-d4	93	80-124
Toluene-d8	99	80-120
Bromofluorobenzene	97	80-120

Purgeable Halocarbons by GC/MS

Lab #:	173038	Location:	Sausage Factory
Client:	Clayton Group Services	Prep:	EPA 5030B
Project#:	70-04578.00	Analysis:	EPA 8260B
Field ID:	MW-11	Batch#:	92251
Lab ID:	173038-008	Sampled:	06/23/04
Matrix:	Water	Received:	06/23/04
Units:	ug/L	Analyzed:	06/24/04
Diln Fac:	1.000		

Analyte	Result	RL
Chloromethane	ND	1.0
Vinyl Chloride	ND	0.5
Bromomethane	ND	1.0
Chloroethane	ND	1.0
Trichlorofluoromethane	ND	1.0
Freon 113	ND	1.0
1,1-Dichloroethene	ND	0.5
Methylene Chloride	ND	20
trans-1,2-Dichloroethene	ND	0.5
1,1-Dichloroethane	ND	0.5
cis-1,2-Dichloroethene	ND	0.5
Chloroform	ND	1.0
1,1,1-Trichloroethane	ND	0.5
Carbon Tetrachloride	ND	0.5
1,2-Dichloroethane	ND	0.5
Trichloroethene	ND	0.5
1,2-Dichloropropane	ND	0.5
Bromodichloromethane	ND	0.5
cis-1,3-Dichloropropene	ND	0.5
trans-1,3-Dichloropropene	ND	0.5
1,1,2-Trichloroethane	ND	0.5
Tetrachloroethene	ND	0.5
Dibromochloromethane	ND	0.5
Chlorobenzene	ND	0.5
Bromoform	ND	0.5
1,1,2,2-Tetrachloroethane	ND	0.5
1,3-Dichlorobenzene	ND	0.5
1,4-Dichlorobenzene	ND	0.5
1,2-Dichlorobenzene	ND	0.5

Surrogate	%REC	Limits
1,2-Dichloroethane-d4	94	80-124
Toluene-d8	98	80-120
Bromofluorobenzene	98	80-120

ND= Not Detected
 RL= Reporting Limit
 Page 1 of 1

Purgeable Halocarbons by GC/MS

Lab #:	173038	Location:	Sausage Factory
Client:	Clayton Group Services	Prep:	EPA 5030B
Project#:	70-04578.00	Analysis:	EPA 8260B
Field ID:	MW-12	Units:	ug/L
Lab ID:	173038-009	Sampled:	06/23/04
Matrix:	Water	Received:	06/23/04

Analyte	Result	RL	Diln Fac	Batch#	Analyzed
Chloromethane	ND	1.0	1.000	92251	06/24/04
Vinyl Chloride	ND	0.5	1.000	92251	06/24/04
Bromomethane	ND	1.0	1.000	92251	06/24/04
Chloroethane	ND	1.0	1.000	92251	06/24/04
Trichlorofluoromethane	ND	1.0	1.000	92251	06/24/04
Freon 113	ND	1.0	1.000	92251	06/24/04
1,1-Dichloroethene	ND	0.5	1.000	92251	06/24/04
Methylene Chloride	ND	20	1.000	92251	06/24/04
trans-1,2-Dichloroethene	74	0.5	1.000	92251	06/24/04
1,1-Dichloroethane	ND	0.5	1.000	92251	06/24/04
cis-1,2-Dichloroethene	65	0.5	1.000	92251	06/24/04
Chloroform	ND	1.0	1.000	92251	06/24/04
1,1,1-Trichloroethane	ND	0.5	1.000	92251	06/24/04
Carbon Tetrachloride	ND	0.5	1.000	92251	06/24/04
1,2-Dichloroethane	ND	0.5	1.000	92251	06/24/04
Trichloroethene	200	1.0	2.000	92285	06/26/04
1,2-Dichloropropane	ND	0.5	1.000	92251	06/24/04
Bromodichloromethane	ND	0.5	1.000	92251	06/24/04
cis-1,3-Dichloropropene	ND	0.5	1.000	92251	06/24/04
trans-1,3-Dichloropropene	ND	0.5	1.000	92251	06/24/04
1,1,2-Trichloroethane	ND	0.5	1.000	92251	06/24/04
Tetrachloroethene	ND	0.5	1.000	92251	06/24/04
Dibromochloromethane	ND	0.5	1.000	92251	06/24/04
Chlorobenzene	ND	0.5	1.000	92251	06/24/04
Bromoform	ND	0.5	1.000	92251	06/24/04
1,1,2,2-Tetrachloroethane	ND	0.5	1.000	92251	06/24/04
1,3-Dichlorobenzene	ND	0.5	1.000	92251	06/24/04
1,4-Dichlorobenzene	ND	0.5	1.000	92251	06/24/04
1,2-Dichlorobenzene	ND	0.5	1.000	92251	06/24/04

Surrogate	%REC	Limits	Diln Fac	Batch#	Analyzed
1,2-Dichloroethane-d4	94	80-124	1.000	92251	06/24/04
Toluene-d8	96	80-120	1.000	92251	06/24/04
Bromofluorobenzene	97	80-120	1.000	92251	06/24/04

ND= Not Detected
 RL= Reporting Limit
 Page 1 of 1

Purgeable Halocarbons by GC/MS

Lab #:	173038	Location:	Sausage Factory
Client:	Clayton Group Services	Prep:	EPA 5030B
Project#:	70-04578.00	Analysis:	EPA 8260B
Field ID:	MW-13	Batch#:	92285
Lab ID:	173038-010	Sampled:	06/23/04
Matrix:	Water	Received:	06/23/04
Units:	ug/L	Analyzed:	06/26/04
Diln Fac:	4.000		

Analyte	Result	RL
Chloromethane	ND	4.0
Vinyl Chloride	25	2.0
Bromomethane	ND	4.0
Chloroethane	ND	4.0
Trichlorofluoromethane	ND	4.0
Freon 113	ND	4.0
1,1-Dichloroethene	2.8	2.0
Methylene Chloride	ND	80
trans-1,2-Dichloroethene	31	2.0
1,1-Dichloroethane	ND	2.0
cis-1,2-Dichloroethene	350	2.0
Chloroform	ND	4.0
1,1,1-Trichloroethane	ND	2.0
Carbon Tetrachloride	ND	2.0
1,2-Dichloroethane	ND	2.0
Trichloroethene	53	2.0
1,2-Dichloropropane	ND	2.0
Bromodichloromethane	ND	2.0
cis-1,3-Dichloropropene	ND	2.0
trans-1,3-Dichloropropene	ND	2.0
1,1,2-Trichloroethane	ND	2.0
Tetrachloroethene	ND	2.0
Dibromochloromethane	ND	2.0
Chlorobenzene	ND	2.0
Bromoform	ND	2.0
1,1,2,2-Tetrachloroethane	ND	2.0
1,3-Dichlorobenzene	ND	2.0
1,4-Dichlorobenzene	ND	2.0
1,2-Dichlorobenzene	ND	2.0

Surrogate	%REC	Limits
1,2-Dichloroethane-d4	99	80-124
Toluene-d8	98	80-120
Bromofluorobenzene	98	80-120

Batch QC Report

Purgeable Halocarbons by GC/MS

Lab #:	173038	Location:	Sausage Factory
Client:	Clayton Group Services	Prep:	EPA 5030B
Project#:	70-04578.00	Analysis:	EPA 8260B
Type:	BLANK	Diln Fac:	1.000
Lab ID:	QC255313	Batch#:	92251
Matrix:	Water	Analyzed:	06/24/04
Units:	ug/L		

Analyte	Result	RL
Chloromethane	ND	1.0
Vinyl Chloride	ND	0.5
Bromomethane	ND	1.0
Chloroethane	ND	1.0
Trichlorofluoromethane	ND	1.0
Freon 113	ND	1.0
1,1-Dichloroethene	ND	0.5
Methylene Chloride	ND	20
trans-1,2-Dichloroethene	ND	0.5
1,1-Dichloroethane	ND	0.5
cis-1,2-Dichloroethene	ND	0.5
Chloroform	ND	1.0
1,1,1-Trichloroethane	ND	0.5
Carbon Tetrachloride	ND	0.5
1,2-Dichloroethane	ND	0.5
Trichloroethene	ND	0.5
1,2-Dichloropropane	ND	0.5
Bromodichloromethane	ND	0.5
cis-1,3-Dichloropropene	ND	0.5
trans-1,3-Dichloropropene	ND	0.5
1,1,2-Trichloroethane	ND	0.5
Tetrachloroethene	ND	0.5
Dibromochloromethane	ND	0.5
Chlorobenzene	ND	0.5
Bromoform	ND	0.5
1,1,2,2-Tetrachloroethane	ND	0.5
1,3-Dichlorobenzene	ND	0.5
1,4-Dichlorobenzene	ND	0.5
1,2-Dichlorobenzene	ND	0.5

Surrogate	%REC	Limits
1,2-Dichloroethane-d4	93	80-124
Toluene-d8	99	80-120
Bromofluorobenzene	97	80-120

ND= Not Detected
 RL= Reporting Limit
 Page 1 of 1

Batch QC Report

Purgeable Halocarbons by GC/MS

Lab #:	173038	Location:	Sausage Factory
Client:	Clayton Group Services	Prep:	EPA 5030B
Project#:	70-04578.00	Analysis:	EPA 8260B
Type:	BLANK	Diln Fac:	1.000
Lab ID:	QC255475	Batch#:	92285
Matrix:	Water	Analyzed:	06/25/04
Units:	ug/L		

Analyte	Result	RL
Chloromethane	ND	1.0
Vinyl Chloride	ND	0.5
Bromomethane	ND	1.0
Chloroethane	ND	1.0
Trichlorofluoromethane	ND	1.0
Freon 113	ND	1.0
1,1-Dichloroethene	ND	0.5
Methylene Chloride	ND	20
trans-1,2-Dichloroethene	ND	0.5
1,1-Dichloroethane	ND	0.5
cis-1,2-Dichloroethene	ND	0.5
Chloroform	ND	1.0
1,1,1-Trichloroethane	ND	0.5
Carbon Tetrachloride	ND	0.5
1,2-Dichloroethane	ND	0.5
Trichloroethene	ND	0.5
1,2-Dichloropropane	ND	0.5
Bromodichloromethane	ND	0.5
cis-1,3-Dichloropropene	ND	0.5
trans-1,3-Dichloropropene	ND	0.5
1,1,2-Trichloroethane	ND	0.5
Tetrachloroethene	ND	0.5
Dibromochloromethane	ND	0.5
Chlorobenzene	ND	0.5
Bromoform	ND	0.5
1,1,2,2-Tetrachloroethane	ND	0.5
1,3-Dichlorobenzene	ND	0.5
1,4-Dichlorobenzene	ND	0.5
1,2-Dichlorobenzene	ND	0.5

Surrogate	%REC	Limits
1,2-Dichloroethane-d4	96	80-124
Toluene-d8	100	80-120
Bromofluorobenzene	95	80-120

ND= Not Detected

RL= Reporting Limit

Page 1 of 1

Batch QC Report

Purgeable Halocarbons by GC/MS

Lab #:	173038	Location:	Sausage Factory
Client:	Clayton Group Services	Prep:	EPA 5030B
Project#:	70-04578.00	Analysis:	EPA 8260B
Matrix:	Water	Batch#:	92251
Units:	ug/L	Analyzed:	06/24/04
Diln Fac:	1.000		

Type: BS Lab ID: QC255310

Analyte	Spiked	Result	%REC	Limits
1,1-Dichloroethene	50.00	50.34	101	76-120
Trichloroethene	50.00	54.50	109	80-120
Chlorobenzene	50.00	53.09	106	80-120

Surrogate	%REC	Limits
1,2-Dichloroethane-d4	97	80-124
Toluene-d8	101	80-120
Bromofluorobenzene	97	80-120

Type: BSD Lab ID: QC255311

Analyte	Spiked	Result	%REC	Limits	RPD	Lim
1,1-Dichloroethene	50.00	48.59	97	76-120	4	20
Trichloroethene	50.00	51.82	104	80-120	5	20
Chlorobenzene	50.00	52.54	105	80-120	1	20

Surrogate	%REC	Limits
1,2-Dichloroethane-d4	97	80-124
Toluene-d8	100	80-120
Bromofluorobenzene	97	80-120

Batch QC Report

Purgeable Halocarbons by GC/MS

Lab #:	173038	Location:	Sausage Factory
Client:	Clayton Group Services	Prep:	EPA 5030B
Project#:	70-04578.00	Analysis:	EPA 8260B
Matrix:	Water	Batch#:	92285
Units:	ug/L	Analyzed:	06/25/04
Diln Fac:	1.000		

Type: BS Lab ID: QC255472

Analyte	Spiked	Result	%REC	Limits
1,1-Dichloroethene	50.00	45.82	92	76-120
Trichloroethene	50.00	50.76	102	80-120
Chlorobenzene	50.00	49.79	100	80-120

Surrogate	%REC	Limits
1,2-Dichloroethane-d4	97	80-124
Toluene-d8	100	80-120
Bromofluorobenzene	97	80-120

Type: BSD Lab ID: QC255473

Analyte	Spiked	Result	%REC	Limits	RPD	Lim
1,1-Dichloroethene	50.00	40.35	81	76-120	13	20
Trichloroethene	50.00	43.17	86	80-120	16	20
Chlorobenzene	50.00	43.29	87	80-120	14	20

Surrogate	%REC	Limits
1,2-Dichloroethane-d4	98	80-124
Toluene-d8	101	80-120
Bromofluorobenzene	97	80-120