



KAPREALIAN ENGINEERING
INCORPORATED

April 13, 1995

Alameda County Health Care
Service Agency
1131 Harbor Bay Parkway, Room 250
Alameda, California 94502-6577

Attention: Ms. Eva Chu

RE: Unocal Service Station #6034
4700 First Street
Livermore, California

ENVIRONMENTAL
PROTECTION
95 APR 17 PM 2:52

Dear Ms. Chu:

This letter is a follow-up to the recent Non-Attainment Area (NAA) Management Plan dated April 6, 1995 (prepared by Pacific Environment Group, Inc.) that was submitted by Unocal Corporation for the referenced site. In response to your concerns regarding the levels of petroleum hydrocarbons detected in monitoring well MW2, Kaprealian Engineering, Inc. (KEI) has conducted a review of remedial options.

Since the petroleum hydrocarbons detected at the Unocal site appear to be limited to the vicinity of well MW2, **enhanced bioremediation** was selected as a feasible means of ground water remediation. This option will also minimize the potential to cause contamination to migrate onto the Unocal site. The bioremediation program will consist of the addition of an oxygen-releasing compound (magnesium peroxide) to monitoring well MW2.

Unocal is currently negotiating with the manufacturer (Regenesis) of the oxygen-releasing compound to provide the necessary supplies needed to implement the bioremediation program at the Unocal site. Unocal anticipates that the oxygen-releasing compound will be installed no later than May 15, 1995.

If you have any questions, please feel free to contact me at (510) 602-5112.

Sincerely,

Kaprealian Engineering, Inc.

Thomas J. Berkins
Project Manager

cc: Tina Berry, Unocal Corporation

MONITORING
PURGING
DISPOSING
SAMPLING

MPDS

SERVICES, INCORPORATED

sho 2465

February 21, 1995

when well out to the demand of roots

Alameda County Health Care Services
1131 Harbor Bay Parkway
Alameda, California 94501

RE: Unocal Service Station #6034
4700 First Street
Livermore, California

Per the request of the Unocal Corporation Project Manager, Ms. Tina R. Berry, enclosed please find our report (MPDS-UN6034-05) dated February 13, 1995 for the above referenced site.

Should you have any questions regarding the reporting of data, please feel free to call our office at (510) 602-5120. Any other questions may be directed to the Project Manager at (510) 277-2321.

Sincerely,

MPDS Services, Inc.



Jarrel F. Crider

/jfc

Enclosure

cc: Ms. Tina R. Berry

RECEIVED
FEB 22 1995
ENVIRONMENTAL HEALTH SERVICES
NORTH COUNTY

925 2465 0.2

MPDS-UN6034-05
February 13, 1995

Unocal Corporation
2000 Crow Canyon Place, Suite 400
P.O. Box 5155
San Ramon, California 94583

Attention: Ms. Tina R. Berry

RE: Quarterly Data Report
Unocal Service Station #6034
4700 First Street
Livermore, California

Dear Ms. Berry:

This data report presents the results of the most recent quarter of monitoring and sampling of the monitoring wells at the referenced site by MPDS Services, Inc.

RECENT FIELD ACTIVITIES

The Unocal monitoring wells that were monitored and sampled during this quarter are indicated in Table 1. Prior to sampling, the Unocal wells were checked for depth to water and the presence of free product or sheen. The monitoring data and the ground water elevations for the Unocal wells are summarized in Table 1. The ground water flow direction at the Unocal site during the most recent quarter is shown on the attached Figure 1.

A joint monitoring and sampling event was conducted with the consultant for the nearby Chevron site on January 18, 1995. The monitoring data collected for the Chevron monitoring wells (provided by Blaine Tech Services, Inc.) are summarized in Table 2. The ground water flow direction at the Chevron site during the most recent quarter is also shown on the attached Figure 1.

Ground water samples were collected from the Unocal wells on January 18, 1995. Prior to sampling, the wells were each purged of between 6.5 and 8.5 gallons of water. Samples were then collected using a clean Teflon bailer. The samples were decanted into clean VOA vials and/or one-liter amber bottles, as appropriate, which were then sealed with Teflon-lined screw caps, labeled, and stored in a cooler, on ice, until delivery to a state-certified laboratory. MPDS Services, Inc. transported the purged ground water to the Unocal Refinery located in Rodeo, California, for treatment and discharge to San Pablo Bay under NPDES permit.

ANALYTICAL RESULTS

The ground water samples collected from the Unocal wells were analyzed at Sequoia Analytical Laboratory and were accompanied by properly

executed Chain of Custody documentation. The analytical results of the ground water samples collected from the Unocal wells to date are summarized in Table 3. The concentrations of Total Petroleum Hydrocarbons (TPH) as gasoline and benzene detected in the ground water samples collected from the Unocal wells this quarter are shown on the attached Figure 2. Copies of the laboratory analytical results and the Chain of Custody documentation for the Unocal wells are attached to this report.

LIMITATIONS

Environmental changes, either naturally-occurring or artificially-induced, may cause changes in ground water levels and flow paths, thereby changing the extent and concentration of any contaminants.

DISTRIBUTION

A copy of this report should be sent to the Alameda County Health Care Services Agency.

If you have any questions regarding this report, please do not hesitate to call Mr. Nubar Srabian at (510) 602-5120.

Sincerely,

MPDS Services, Inc.

Sarkis A. Karkarian
Staff Engineer

Joel G. Greger, C.E.G.
Senior Engineering Geologist

License No. EG 1633
Exp. Date 8/31/96

/bp

Attachments: Tables 1, 2 & 3
Location Map
Figures 1 & 2
Laboratory Analyses
Chain of Custody documentation

cc: Mr. Thomas J. Berkins, Kaprealian Engineering, Inc.



TABLE 1

**SUMMARY OF MONITORING DATA
UNOCAL MONITORING WELLS**

Well #	Ground Water Elevation (feet)	Depth to Water (feet)♦	Total Well Depth (feet)♦	Product Thickness (feet)	Sheen	Water Purged (gallons)
(Monitored and Sampled on January 18, 1995)						
MW1*	506.08	14.56	27.93	0	--	0
MW2	505.72	14.10	25.63	0	No	8
MW3*	506.43	13.23	25.40	0	--	0
MW4	506.45	13.16	25.46	0	No	8.5
MW5	505.75	14.52	23.56	0	No	6.5
MW6	WELL WAS OBSTRUCTED BY ROOTS					
MW7	505.49	13.34	23.63	0	No	7
(Monitored and Sampled on October 19, 1994)						
MW1*	505.36	15.28	27.92	0	--	0
MW2	505.02	14.80	25.65	0	No	7.5
MW3	505.58	14.08	25.42	0	No	8
MW4	505.66	13.95	25.47	0	No	8
MW5	505.07	15.20	23.57	0	No	6
MW6	WELL WAS OBSTRUCTED BY ROOTS					
MW7	504.78	14.05	23.65	0	No	7
(Monitored and Sampled on July 21, 1994)						
MW1*	505.02	15.62	27.91	0	--	0
MW2	504.83	14.99	25.64	0	No	7.5
MW3*	505.32	14.34	25.41	0	--	0
MW4	505.35	14.26	25.47	0	No	8
MW5	504.72	15.55	23.60	0	No	5.5
MW6	504.63	14.12	23.35	0	No	6.5
MW7	504.62	14.21	23.65	0	No	6.5
(Monitored and Sampled on April 21, 1994)						
MW1	505.06	15.58	27.93	0	No	8.5
MW2	504.86	14.96	25.65	0	No	7.5
MW3	505.36	14.30	25.43	0	No	8
MW4	505.48	14.13	25.48	0	No	8
MW5	504.86	15.41	23.61	0	No	6
MW6	504.65	14.10	23.27	0	No	6.5
MW7	504.66	14.17	23.66	0	No	6.5

TABLE 1 (Continued)

SUMMARY OF MONITORING DATA
UNOCAL MONITORING WELLS

<u>Well #</u>	<u>Well Casing Elevation (feet)**</u>
MW1	520.64
MW2	519.82
MW3	519.66
MW4	519.61
MW5	520.27
MW6	518.75
MW7	518.83

- ◆ The depth to water level and total well depth measurements were taken from the top of the well casings.
- * Monitored only.
- ** The elevations of the top of the well casings are relative to Mean Sea Level (MSL), per the City of Livermore Benchmark No. C-18-5 (elevation = 551.77 feet MSL).
- Sheen determination was not performed.

TABLE 2

SUMMARY OF MONITORING DATA
CHEVRON MONITORING WELLS

(Provided by Blaine Tech Services, Inc.)

Well #	Ground Water Elevation (feet)	Depth to Water (feet)	Well Casing Elevation (feet)*
(Monitored on January 18, 1995)			
C-1	508.67	11.72	520.39
C-2	508.94	11.82	520.76
C-5	508.55	12.27	520.82
C-6	508.61	11.01	519.62
C-7	508.71	11.59	520.30
C-8	WELL WAS DRY		519.74
C-9	508.57	11.15	519.72
C-10	506.77	13.64	520.41
C-11	506.81	13.23	520.04
C-14	WELL WAS DRY		520.08
C-16	WELL PAVED OVER		519.68
C-17	507.12	13.70	520.82
C-18	WELL ABANDONED		518.96
C-19	506.97	14.02	520.99

* Relative to Mean Sea Level (MSL).

TABLE 3

**SUMMARY OF LABORATORY ANALYSES
 WATER
 UNOCAL MONITORING WELLS**

<u>Date</u>	<u>Well #</u>	<u>TPH as Gasoline</u>	<u>Benzene</u>	<u>Toluene</u>	<u>Ethyl- benzene</u>	<u>Xylenes</u>
1/18/95	MW1	SAMPLED ANNUALLY				
	MW2	5,100	6.8	7.3	100	1,500
	MW3	SAMPLED SEMI-ANNUALLY				
	MW4	790	1.5	3.3	1.2	2.6
	MW5	ND	ND	ND	ND	ND
	MW6	WELL WAS OBSTRUCTED BY ROOTS				
	MW7	ND	ND	ND	ND	ND
10/19/94	MW1	SAMPLED ANNUALLY				
	MW2	4,100	16	3.5	8.6	1,100
	MW3	ND	ND	0.61	ND	0.51
	MW4	750	ND	3.6	4.2	3.4
	MW5	ND	ND	0.71	ND	0.57
	MW6	WELL WAS OBSTRUCTED BY ROOTS				
	MW7	ND	ND	0.87	ND	0.61
7/21/94	MW1	SAMPLED ANNUALLY				
	MW2	31,000	58	29	940	6,200
	MW3	SAMPLED SEMI-ANNUALLY				
	MW4	320	0.51	1.4	1.0	1.6
	MW5	ND	ND	ND	ND	ND
	MW6	ND	ND	ND	ND	ND
	MW7	ND	ND	ND	ND	ND
4/21/94	MW1*	ND	ND	ND	ND	ND
	MW2	27,000	85	65	880	5,300
	MW3	ND	ND	ND	ND	ND
	MW4	380	0.83	1.2	1.2	1.7
	MW5	ND	ND	ND	ND	ND
	MW6	ND	ND	ND	ND	ND
	MW7	ND	ND	ND	ND	ND

TABLE 3 (Continued)

SUMMARY OF LABORATORY ANALYSES
 WATER
 UNOCAL MONITORING WELLS

<u>Date</u>	<u>Well #</u>	<u>TPH as Gasoline</u>	<u>Benzene</u>	<u>Toluene</u>	<u>Ethyl-benzene</u>	<u>Xylenes</u>
1/20/94	MW2	20,000	ND	ND	270	3,300
	MW3	SAMPLED SEMI-ANNUALLY				
	MW4	1,200	ND	2.6	4.7	7.4
	MW5	ND	ND	ND	ND	ND
	MW6	ND	ND	ND	ND	ND
	MW7	ND	ND	ND	ND	ND
	10/20/93	MW2	12,000	27	10	100
MW3		ND	ND	ND	ND	ND
MW4		640	ND	2.5	2.3	1.9
MW5		110	0.80	ND	ND	ND
MW6		ND	ND	ND	ND	ND
MW7		ND	ND	ND	ND	ND
7/20/93		MW2	25,000	68	94	1,000
	MW3	ND	ND	ND	ND	ND
	MW4	NOT SAMPLED - SAMPLING ACCESS DENIED				
	MW5▲	89	1.1	0.51	ND	1.8
	MW6	WELL WAS OBSTRUCTED				
	MW7	ND	ND	ND	ND	ND
	4/22/93	MW2	49,000	150	1,000	3,000
MW3		ND	ND	ND	ND	ND
MW4		1,100	8.8	1.0	7.2	6.0
MW5▲		94	1.2	ND	ND	1.3
MW6		WELL WAS OBSTRUCTED				
MW7		ND	ND	ND	ND	ND
1/14/93		MW2	19,000	75	430	900
	MW3	ND	ND	ND	ND	ND
	MW4	920	ND	6.3	12	3.9
	MW5▲	91	ND	0.53	1.2	11
	MW6	WELL WAS OBSTRUCTED				
	MW7	ND	ND	ND	ND	ND

TABLE 3 (Continued)

SUMMARY OF LABORATORY ANALYSES
WATER
UNOCAL MONITORING WELLS

<u>Date</u>	<u>Well #</u>	<u>TPH as Gasoline</u>	<u>Benzene</u>	<u>Toluene</u>	<u>Ethyl-benzene</u>	<u>Xylenes</u>
10/16/92	MW2	290	2.3	ND	5.1	15
	MW3	ND	ND	ND	ND	ND
	MW4	300	2.1	ND	4.8	13
	MW5▲	180	7.8	1.1	17	6.4
	MW6	WELL WAS OBSTRUCTED				
	MW7	ND	ND	ND	ND	ND
	7/07/92	MW2	44,000	160	1,100	1,000
MW3		ND	ND	ND	ND	ND
MW4		340	ND	2.2	2.4	2.4
MW5▲		76	0.48	1.1	0.32	1.3
MW6		ND	ND	ND	ND	ND
MW7		ND	ND	ND	ND	ND
4/06/92		MW2	760	6.3	2.1	ND
	MW3	ND	ND	ND	ND	ND
	MW4	660	1.3	3.8	2.9	4.1
	MW5	240◆	ND	ND	0.35	ND
	MW6	ND	ND	ND	ND	ND
	MW7	ND	ND	ND	ND	ND
	1/14/92	MW2	5,600	36	120	450
MW3		ND	ND	ND	ND	ND
MW4		1,500	4.2	7.1	18	9.2
MW5		99	1.0	1.2	ND	0.32
MW6		ND	ND	ND	ND	ND
MW7		ND	ND	ND	ND	ND
10/14/91		MW2	11,000	79	130	660
	MW3	ND	ND	ND	ND	ND
	MW4	880	3.8	2.2	8.6	5.8
	MW5	660	55	4.4	50	66
	MW6	ND	ND	ND	ND	ND
	MW7	ND	ND	ND	ND	ND

TABLE 3 (Continued)

SUMMARY OF LABORATORY ANALYSES
WATER
UNOCAL MONITORING WELLS

<u>Date</u>	<u>Well #</u>	<u>TPH as Gasoline</u>	<u>Benzene</u>	<u>Toluene</u>	<u>Ethyl-benzene</u>	<u>Xylenes</u>
7/10/91	MW1*	ND	ND	ND	ND	ND
	MW2	14,000	70	160	570	5,400
	MW3	ND	ND	ND	ND	ND
	MW4	830	8.4	19	7.7	7.2
	MW5	220	5.1	8.7	9.1	9.7
	MW6	ND	ND	ND	ND	ND
	MW7	ND	ND	ND	ND	ND
4/10/91	MW1*	ND	ND	ND	ND	ND
	MW2	22,000	170	190	490	6,200
	MW3	ND	ND	ND	ND	ND
	MW4	950	0.84	4.3	9.6	5.0
	MW5	630	35	14	47	30
	MW6	ND	ND	ND	ND	ND
	MW7	ND	ND	ND	ND	ND
12/24/90	MW1*	ND	ND	ND	ND	0.40
	MW2	32,000	440	340	460	13,000
	MW3	ND	ND	ND	ND	ND
	MW4	1,400	ND	8.7	15	10
9/07/90	MW1*	ND	ND	1.2	ND	ND
	MW2	ND	ND	1.5	ND	ND
	MW3	1,100	11	ND	6.6	16
	MW4	15,000	100	140	210	4,600
6/05/90	MW1*	ND	ND	ND	ND	ND
	MW2	31,000	250	460	950	9,200
	MW3	ND	ND	ND	ND	ND
	MW4	1,400	1.2	4.7	24	12
3/08/90	MW1**	ND	ND	ND	ND	ND
	MW2	26,000	230	410	1,300	2,100
	MW3	ND	ND	ND	ND	ND
	MW4	1,200	18	8.4	37	28

TABLE 3 (Continued)

SUMMARY OF LABORATORY ANALYSES
WATER
UNOCAL MONITORING WELLS

Date	Well #	TPH as Gasoline	Benzene	Toluene	Ethylbenzene	Xylenes
11/18/89	MW1***	ND	ND	ND	ND	ND
	MW2	53,000	540	500	130	22,000
	MW3	ND	0.35	ND	ND	ND
	MW4	990	9.8	10	7.1	4.7

- ◆ Sequoia Analytical Laboratory reported that the hydrocarbons detected did not appear to be gasoline.
- * Total Oil & Grease (TOG) and all EPA method 8010 constituents were non-detectable.
- ** TOG was detected at 4.7 milligrams per liter (mg/L). All EPA method 8010 compounds were non-detectable.
- *** TOG was detected at 3.1 mg/L. All EPA method 8010 compounds were non-detectable, except for trichloroethene at 0.55 µg/L.
- ▲ Methyl tert butyl ether was detected at a concentration of 2.2 µg/L on July 20, 1993, 0.82 µg/L on April 22, 1993, 1.2 µg/L on January 14, 1994, 2.0 µg/L on October 16, 1992, and 1.5 µg/L on July 7, 1992.

ND = Non-detectable.

-- Indicates analysis was not performed.

Results are in micrograms per liter (µg/L), unless otherwise indicated.

Note: Laboratory analyses data prior to January 20, 1994, were provided by Kaprealian Engineering, Inc.

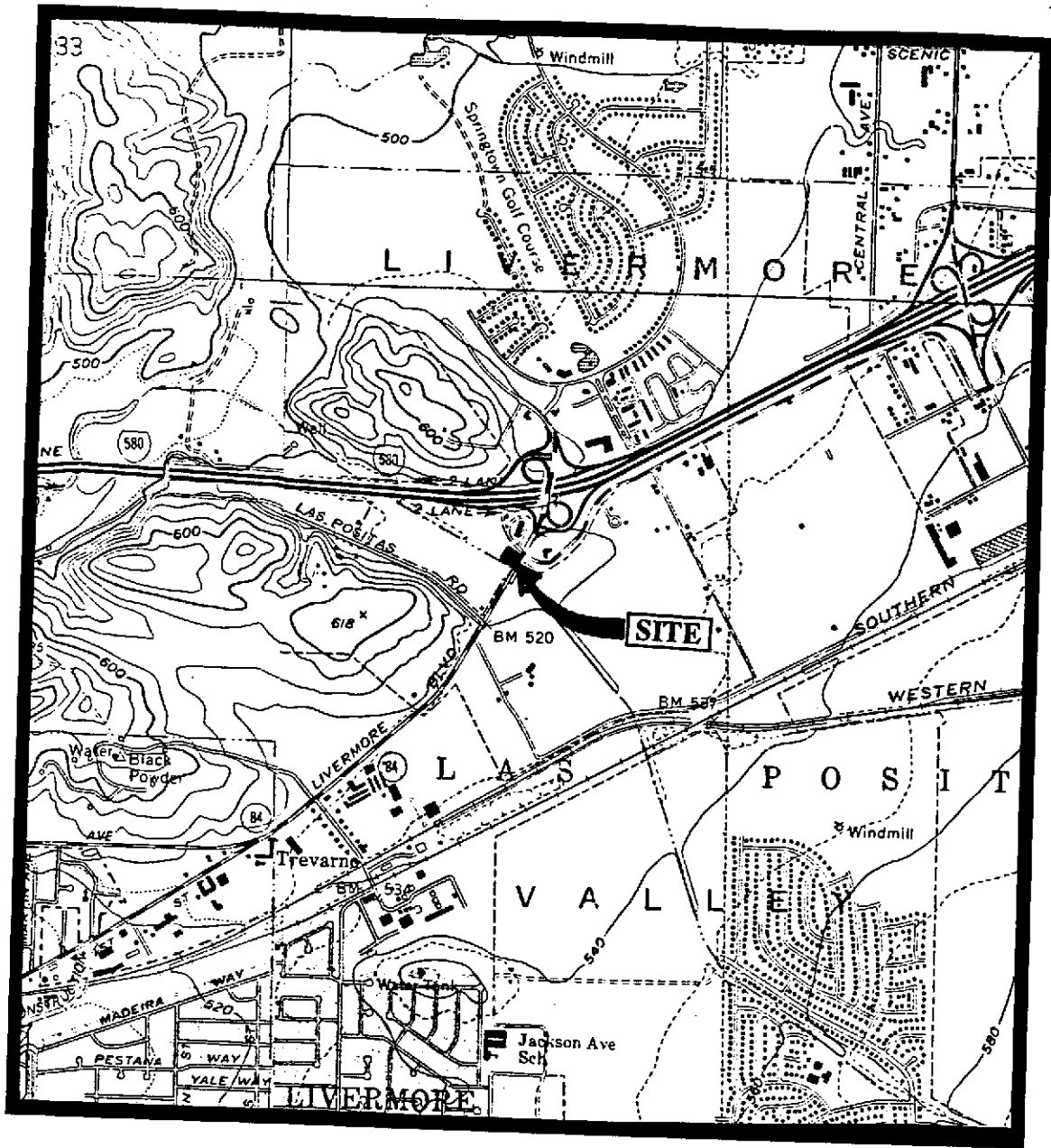

Base modified from 7.5 minute U.S.G.S. Livermore and Altamont Quadrangles
 (photorevised 1980 and 1981, respectively)

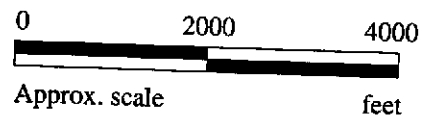

MPDS SERVICES, INCORPORATED

UNOCAL SERVICE STATION # 6034
 4700 FIRST STREET
 LIVERMORE, CALIFORNIA

LOCATION
 MAP

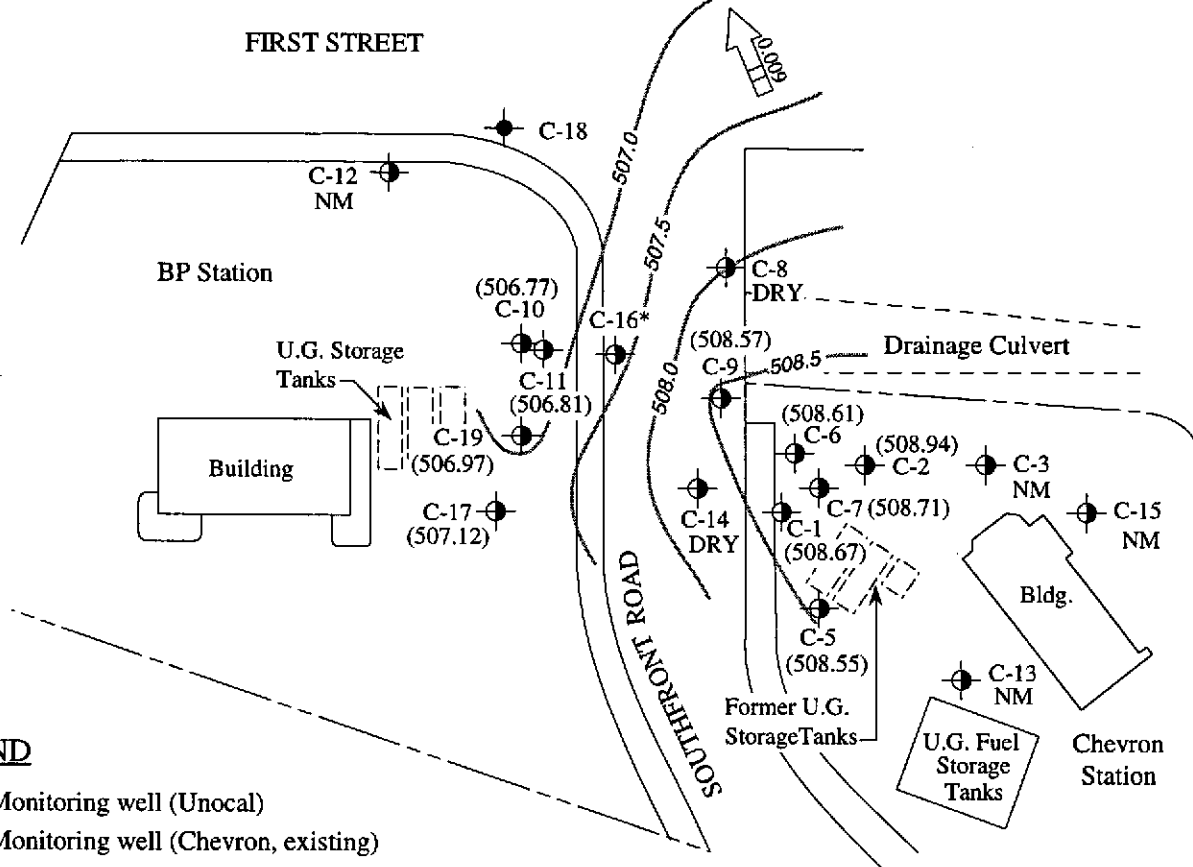
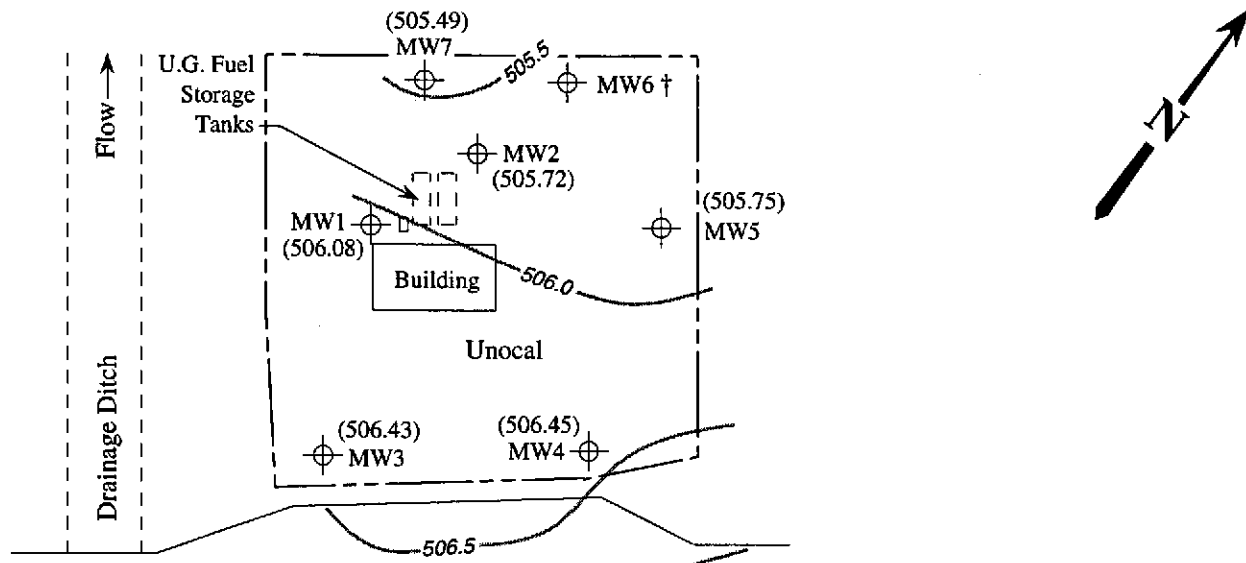

LEGEND

- ⊕ Monitoring well (Unocal)
- ⊙ Monitoring well (Chevron, existing)
- Monitoring well (Chevron, abandoned)
- () Ground water elevation in feet above Mean Sea Level
- ➔ Direction of ground water flow with approximate hydraulic gradient
- Contours of ground water elevation
- * Well was paved over
- † Well was inaccessible.
- NM = Not monitored

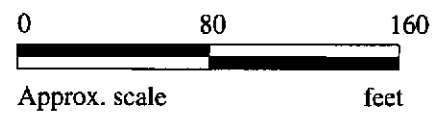

POTENTIOMETRIC SURFACE MAP FOR THE JANUARY 18, 1995 JOINT MONITORING EVENT



**UNOCAL SERVICE STATION # 6034
4700 FIRST STREET
LIVERMORE, CALIFORNIA**

**FIGURE
1**

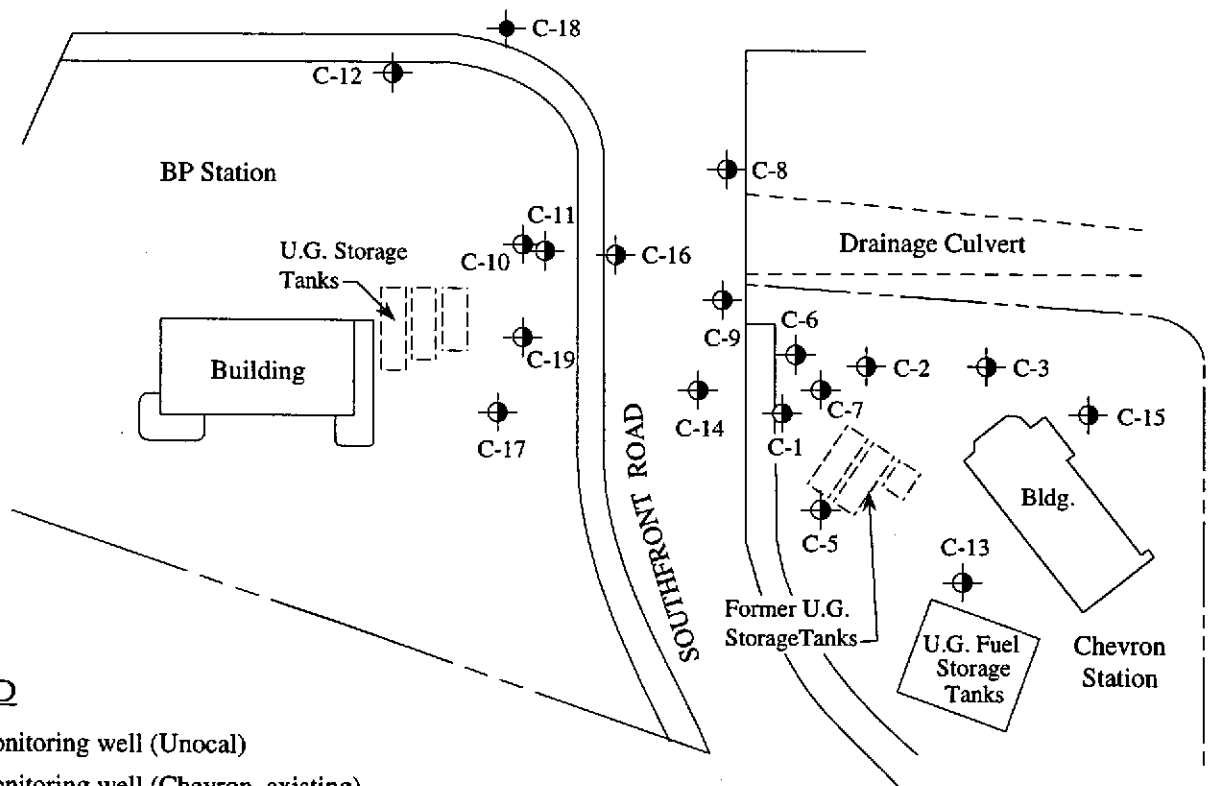
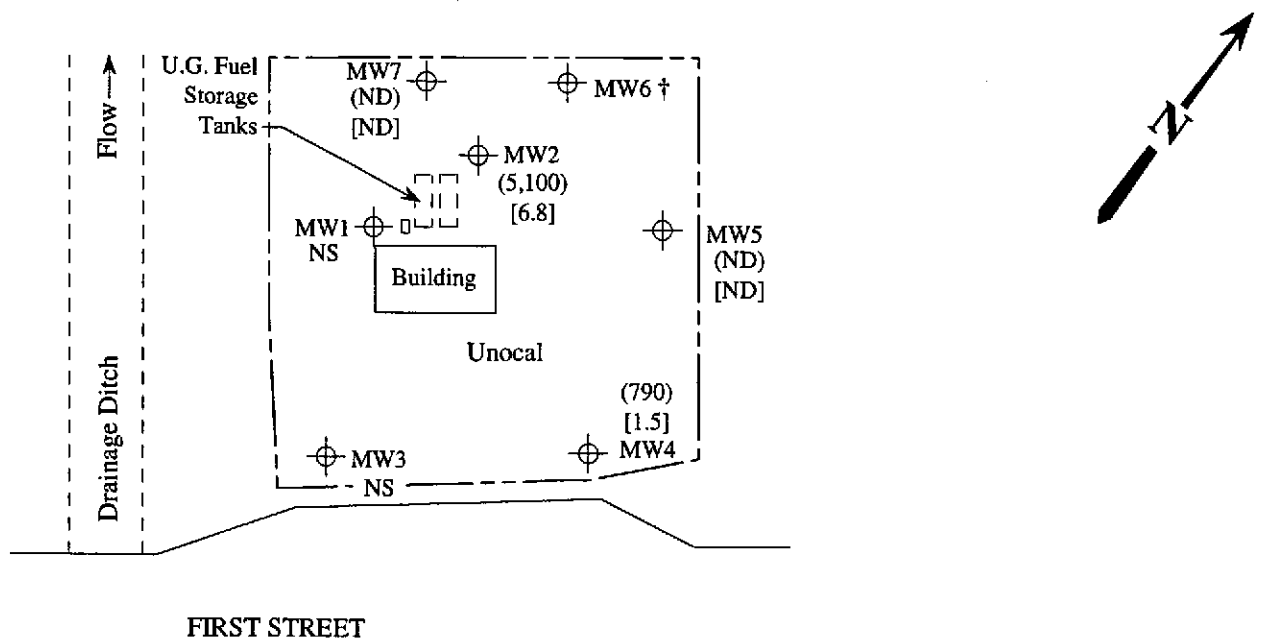

LEGEND

- ⊕ Monitoring well (Unocal)
- ⊙ Monitoring well (Chevron, existing)
- Monitoring well (Chevron, abandoned)
- () Concentration of TPH as gasoline in $\mu\text{g/L}$
- [] Concentration of benzene in $\mu\text{g/L}$
- ND = Non-detectable, NS = Not sampled
- † Well was inaccessible.



PETROLEUM HYDROCARBON CONCENTRATIONS IN GROUND WATER ON JANUARY 18, 1995



MPDS Services	Client Project ID: Unocal #6034, 4700 1st St., Livermore	Sampled: Jan 18, 1995
2401 Stanwell Dr., Ste. 400	Matrix Descript: Water	Received: Jan 18, 1995
Concord, CA 94520	Analysis Method: EPA 5030/8015/8020	Reported: Feb 2, 1995
Attention: Avo Avedissian	First Sample #: 501-0855	

TOTAL PURGEABLE PETROLEUM HYDROCARBONS with BTEX DISTINCTION

Sample Number	Sample Description	Purgeable Hydrocarbons µg/L	Benzene µg/L	Toluene µg/L	Ethyl Benzene µg/L	Total Xylenes µg/L
501-0855	MW-2	5,100	6.8	7.3	100	1,500
501-0856	MW-4	790	1.5	3.3	1.2	2.6
501-0857	MW-5	ND	ND	ND	ND	ND
501-0858	MW-7	ND	ND	ND	ND	ND

Detection Limits:	50	0.50	0.50	0.50	0.50
--------------------------	-----------	-------------	-------------	-------------	-------------

Total Purgeable Petroleum Hydrocarbons are quantitated against a fresh gasoline standard.
 Analytes reported as ND were not present above the stated limit of detection.

SEQUOIA ANALYTICAL, #1271

Signature on File

Alan B. Kemp
 Project Manager





Sequoia Analytical

680 Chesapeake Drive Redwood City, CA 94063 (415) 364-9600 FAX (415) 364-9233
 1900 Bates Avenue, Suite L Concord, CA 94520 (510) 686-9600 FAX (510) 686-9689
 819 Striker Avenue, Suite 8 Sacramento, CA 95834 (916) 921-9600 FAX (916) 921-0100

MPDS Services	Client Project ID: Unocal #6034, 4700 1st St., Livermore	Sampled: Jan 18, 1995
2401 Stanwell Dr., Ste. 400	Matrix Descript: Water	Received: Jan 18, 1995
Concord, CA 94520	Analysis Method: EPA 5030/8015/8020	Reported: Feb 2, 1995
Attention: Avo Avedissian	First Sample #: 501-0855	

TOTAL PURGEABLE PETROLEUM HYDROCARBONS with BTEX DISTINCTION

Sample Number	Sample Description	Chromatogram Pattern	DL Mult. Factor	Date Analyzed	Instrument ID	Surrogate Recovery, % QC Limits: 70-130
501-0855	MW-2	Gasoline	10	1/31/95	HP-4	80
501-0856	MW-4	Gasoline	1.0	2/1/95	HP-5	84
501-0857	MW-5	--	1.0	1/31/95	HP-4	96
501-0858	MW-7	--	1.0	1/31/95	HP-4	81

SEQUOIA ANALYTICAL, #1271

Signature on File

Alan B. Kemp
Project Manager





MPDS Services Client Project ID: Unocal #6034, 4700 1st St., Livermore
 2401 Stanwell Dr., Ste. 400 Matrix: Liquid
 Concord, CA 94520
 Attention: Avo Avedissian QC Sample Group: 5010855-858 Reported: Feb 7, 1995

QUALITY CONTROL DATA REPORT

ANALYTE	Benzene	Toluene	Ethyl Benzene	Xylenes
Method:	EPA 8020	EPA 8020	EPA 8020	EPA 8020
Analyst:	A. Tuzon	A. Tuzon	A. Tuzon	A. Tuzon

MS/MSD Batch#:	5011264	5011264	5011264	5011264
Date Prepared:	2/1/95	2/1/95	2/1/95	2/1/95
Date Analyzed:	2/1/95	2/1/95	2/1/95	2/1/95
Instrument I.D.#:	HP-5	HP-5	HP-5	HP-5
Conc. Spiked:	20 µg/L	20 µg/L	20 µg/L	60 µg/L
Matrix Spike % Recovery:	90	105	105	107
Matrix Spike Duplicate % Recovery:	90	105	110	108
Relative % Difference:	0.0	0.0	4.7	0.93

LCS Batch#:	3LCS020195	3LCS020195	3LCS020195	3LCS020195
Date Prepared:	2/1/95	2/1/95	2/1/95	2/1/95
Date Analyzed:	2/1/95	2/1/95	2/1/95	2/1/95
Instrument I.D.#:	HP-5	HP-5	HP-5	HP-5
LCS % Recovery:	94	108	112	111

% Recovery Control Limits:	71-133	72-128	72-130	71-120
-----------------------------------	--------	--------	--------	--------

Please Note:
 The LCS is a control sample of known, interferent free matrix that is analyzed using the same reagents, preparation, and analytical methods employed for the samples. The matrix spike is an aliquot of sample fortified with known quantities of specific compounds and subjected to the entire analytical procedure. If the recovery of analytes from the matrix spike does not fall within specified control limits due to matrix interference, the LCS recovery is to be used to validate the batch.

SEQUOIA ANALYTICAL, #1271

Signature on File
 Alan B. Kemp
 Project Manager





MPDS Services
 2401 Stanwell Dr., Ste. 400
 Concord, CA 94520
 Attention: Avo Avedissian

Client Project ID: Unocal #6034, 4700 1st St., Livermore
 Matrix: Liquid

QC Sample Group: 5010855-858

Reported: Feb 7, 1995

QUALITY CONTROL DATA REPORT

ANALYTE	Benzene	Toluene	Ethyl Benzene	Xylenes
Method:	EPA 8020	EPA 8020	EPA 8020	EPA 8020
Analyst:	M. Creusere	M. Creusere	M. Creusere	M. Creusere

MS/MSD				
Batch#:	5011141	5011141	5011141	5011141
Date Prepared:	1/31/95	1/31/95	1/31/95	1/31/95
Date Analyzed:	1/31/95	1/31/95	1/31/95	1/31/95
Instrument I.D.#:	HP-4	HP-4	HP-4	HP-4
Conc. Spiked:	20 µg/L	20 µg/L	20 µg/L	60 µg/L
Matrix Spike				
% Recovery:	75	95	95	100
Matrix Spike Duplicate %				
Recovery:	75	95	100	100
Relative %				
Difference:	0.0	0.0	5.1	0.0

LCS Batch#:	2LCS013195	2LCS013195	2LCS013195	2LCS013195
Date Prepared:	1/31/95	1/31/95	1/31/95	1/31/95
Date Analyzed:	1/31/95	1/31/95	1/31/95	1/31/95
Instrument I.D.#:	HP-4	HP-4	HP-4	HP-4
LCS %				
Recovery:	72	92	96	98

% Recovery				
Control Limits:	71-133	72-128	72-130	71-120

Please Note:
 The LCS is a control sample of known, interferent free matrix that is analyzed using the same reagents, preparation, and analytical methods employed for the samples. The matrix spike is an aliquot of sample fortified with known quantities of specific compounds and subjected to the entire analytical procedure. If the recovery of analytes from the matrix spike does not fall within specified control limits due to matrix interference, the LCS recovery is to be used to validate the batch.

SEQUOIA ANALYTICAL, #1271

Signature on File

Alan B. Kemp
 Project Manager



M P D S Services, Inc.

2401 Stanwell Drive, Suite 400, Concord, CA 94520

Tel: (510) 602-5120 Fax: (510) 689-1918

CHAIN OF CUSTODY

SAMPLER			UNOCAL					ANALYSES REQUESTED							TURN AROUND TIME:		
(JOE) HOVSIA AJEMIAN			S/S # <u>6034</u> CITY: <u>Livermore</u>					TPH-GAS BTEX	TPH-DIESEL	TOG	8010						Regular
WITNESSING AGENCY			ADDRESS: <u>4700 1st St.</u>														REMARKS
SAMPLE ID NO.	DATE	TIME	WATER	LSAB	COMP	NO OF CONT	SAMPLING LOCATION										
MW-2	1-18-95	10:12 A.M.	/	/		2 (VOA)	Wells	/						5010855	A,B	VOA's preserved	
MW-4	"	9:47 A.M.	/	/		"	"	/						5010856			
MW-5	"	8:42 A.M.	/	/		"	"	/						5010857			
MW-7	"	9:15 A.M.	/	/		"	"	/						5010858			
RELINQUISHED BY:			DATE/TIME			RECEIVED BY:			THE FOLLOWING <u>MUST BE</u> COMPLETED BY THE LABORATORY ACCEPTING SAMPLES FOR ANALYSES:								
[Signature]			1:50 P.M. 1-18-95			[Signature]			1. HAVE ALL SAMPLES RECEIVED FOR ANALYSIS BEEN STORED ON ICE? YES (1°C)								
[Signature]			1/19/95, 3:00 8:00 AM			[Signature]			2. WILL SAMPLES REMAIN REFRIGERATED UNTIL ANALYZED? YES								
[Signature]			1-19			[Signature]			3. DID ANY SAMPLES RECEIVED FOR ANALYSIS HAVE HEAD SPACE? NO								
[Signature]						[Signature]			4. WERE SAMPLES IN APPROPRIATE CONTAINERS AND PROPERLY PACKAGED? YES								
[Signature]						[Signature]			SIGNATURE: [Signature] TITLE: OM DATE: 1-18-95								