



3315 Almaden Expressway, Suite 34
San Jose, CA 95118
Phone: (408) 264-7723
Fax: (408) 264-2435

ADDENDUM TWO TO WORK PLAN
FOR INTERIM SOIL AND
GROUNDWATER REMEDIATION

at
ARCO Station 374
6407 Telegraph Avenue
Oakland, California

60025.08

Prepared for

ARCO Products Company
P.O. Box 5811
San Mateo, California 94402

by

RESNA Industries, Inc.



March 5, 1992



92 MAR 3 11 03 24

3315 Almaden Expressway, Suite 34
San Jose, CA 95118
Phone: (408) 264-7723
Fax: (408) 264-2435

TRANSMITTAL

TO: MR. LARRY SETO
HAZARDOUS MATERIALS SPECIALIST
ACHCSA-DEH
80 SWAN WAY, ROOM 200
OAKLAND, CALIFORNIA 94621

DATE: 3/6/92
PROJECT NUMBER: 60025.08
SUBJECT: ARCO STATION 374,
6407 TELEGRAPH AVENUE, OAKLAND,
CALIFORNIA.

FROM: JOEL COFFMAN
TITLE: PROJECT GEOLOGIST

WE ARE SENDING YOU Attached Under separate cover via _____ the following items:

 Shop drawings Prints Reports Specifications

 Letters Change Orders _____

COPIES	DATED	NO.	DESCRIPTION
1	3/5/92		FINAL-ADDENDUM TWO TO WORK PLAN FOR INTERIM SOIL AND GROUNDWATER REMEDIATION AT THE ABOVE SUBJECT SITE.

THESE ARE TRANSMITTED as checked below:

- For review and comment Approved as submitted Resubmit ___ copies for approval
- As requested Approved as noted Submit ___ copies for distribution
- For approval Return for corrections Return ___ corrected prints
- For your files _____

REMARKS: THIS ADDENDUM HAS BEEN FORWARDED TO YOU AT THE REQUEST
OF MR. CHUCK CARMEL, ARCO PRODUCTS COMPANY.

Copies: 1 to project file no. 60025.08

*Revision Date: 11/21/91
*File Name: TRANSMT.PRJ



3315 Almaden Expressway, Suite 34
San Jose, CA 95118
Phone: (408) 264-7723
Fax: (408) 264-2435

March 5, 1992
60025.08

Mr. Chuck Carmel
ARCO Products Company
P.O. Box 5811
San Mateo, California 94402

Subject: Addendum Two to Work Plan for Interim Soil and Groundwater Remediation
at ARCO Station 374, 6407 Telegraph Avenue, Oakland, California.

Dear Mr. Carmel:

At the request of ARCO Products Company (ARCO), RESNA Industries, Inc. (RESNA) has prepared this Addendum Two to the Work Plan for interim remediation of onsite hydrocarbon-impacted soils and groundwater at the above subject site. The Work Plan for Subsurface Investigations and Remediation was submitted to ARCO and governing regulatory agencies on May 15, 1991. The location of the subject site is shown on the Site Vicinity Map, Plate 1.

This Addendum Two, a Remedial Action Plan (RAP), is being prepared for submittal to and approval by the Regional Water Quality Control Board (RWQCB) and the Alameda County Health Care Services Agency (ACHCSA), prior to installation and operation of the proposed interim soil and groundwater remediation system.

The proposed scope of work under this RAP consists primarily of the engineering design, permitting, construction, and start-up of a soil and groundwater remediation system at the above subject site. The proposed interim remediation system is intended to extract and treat petroleum hydrocarbon bearing soil and groundwater and constrain the migration of hydrocarbon constituents.

PREVIOUS WORK

A summary of previous work performed at this site by RESNA (formerly Applied GeoSystems [AGS]) and others is included in the Work Plan for Subsurface Investigations and Remediation referenced above (RESNA/AGS, May 15, 1991). Addendum One to this Work Plan detailing the proposed offsite subsurface investigation to be performed was also

submitted for review and approval to ARCO, RWQCB and ACHCSA (RESNA, May 15, 1991). RESNA is currently in the process of obtaining an encroachment permit to install an offsite well to further delineate the extent of hydrocarbon-impacted soil and groundwater. Results will be summarized in a report on completion of the offsite subsurface investigation. The Generalized Site Plan, Plate 2, shows the location of the existing onsite and offsite wells and other pertinent site features. Table 1 summarizes cumulative results of laboratory analyses of water samples collected during quarterly monitoring of onsite wells since July 1989. These analytical results combined with the groundwater treatment system efficiency are used later in the text to estimate the average concentration of hydrocarbons discharged to the sewer.

Briefly summarized, based on results of previous investigations conducted by RESNA and others, RESNA concluded the following:

- o The majority of gasoline hydrocarbons in the soil at the site appeared to be limited to the immediate area of the former gasoline underground storage tanks (USTs); the lateral and vertical extents of gasoline hydrocarbons in the soil associated with the former gasoline-storage tanks at the site have not been delineated to below laboratory detection limits, with the exception of the northwestern portion of the site (the new tank pit). The highest concentration of total petroleum hydrocarbons reported as gasoline (TPHg) in soil (795 parts per million [ppm]) appeared to be in the area of the former gasoline USTs at depths of ten feet below grade (RESNA/AGS, June and August 1988).
- o Laboratory analysis of soil samples obtained from borings B-1/MW-1, B-2/MW-2, B-3/MW-3 and B-4/MW-4 reported TPHg concentrations that ranged from below laboratory detection limit of 1 ppm to 560 ppm. Analyses of groundwater samples collected from monitoring wells MW-2, MW-3 and MW-4 located upgradient, immediately downgradient, and offsite in the downgradient direction (south/southwest) of the former gasoline USTs reported elevated concentrations of TPHg, up to 69 ppm (RESNA/AGS, March 1991).
- o Groundwater samples collected from MW-4 reported nondetectable levels of total oil and grease (TOG) and purgeable halocarbons on analysis. Water samples collected from MW-1 for mineral analysis indicated that the native water is of relatively low quality, with manganese and total dissolved solids concentrations exceeding the maximum contaminant levels (MCLs)

- established for secondary drinking water supplies (RESNA/AGS, March 1991).
- o A preliminary records search conducted at the RWQCB regarding a former gasoline service station located upgradient of the subject site revealed that three gasoline USTs and one waste-oil UST were removed from the site in March 1986. Each tank pit was reported to contain water with floating product residue (Aqua Science Engineers, May 1986). No additional subsurface investigations were conducted to assess the possible impact on downgradient sites. (RESNA/AGS, March 1991).
 - o The lateral and vertical extent of hydrocarbons in the groundwater have not been delineated at the site, with the exception of the nondetectable levels of TPHg reported in the new tank pit wells W-3 and W-4, upgradient (north) of the former tank pit.
 - o Based on static water level data collected from on and offsite wells, groundwater beneath the site occurs within silty clay soils interbedded with sands and gravels at an average depth of eight feet below grade. The groundwater gradient has consistently been to the south/southwest. Shallow water observed in tank pit observation wells W-1 and W-2 (four feet below grade) may be the result of excavation of native soil above the wet clayey silt to silty sand layer and replacement with the more permeable gravel backfill (RESNA/AGS, April 1991).
 - o A step drawdown test performed on MW-1 indicated that the rate of recharge in the upper water bearing zone was 0.9 gallon per minute (gpm) (RESNA/AGS, March 1991).
 - o The aquifer pump and recovery test performed in April 1991 using W-2 located in the gravel backfill indicated that the maximum sustainable pumping rate of the well was 0.24 gpm. Drawdown at the gravel backfill reached four feet over the first ten hours of the pump test. The calculated capture zone is sufficiently large to capture the high concentrations portion of the plume, but will not capture portions of the plume which may have migrated offsite (RESNA, July 1991).

DESCRIPTION OF PROPOSED INTERIM SOIL AND GROUNDWATER REMEDIATION SYSTEM

The purpose of the proposed interim soil and groundwater remediation system is to contain and capture the onsite hydrocarbon plume, and to remediate the hydrocarbon-impacted soils and groundwater beneath the site to hydrocarbon concentration levels acceptable to the RWQCB and ACHCSA for closure of the site. In order to avoid delaying groundwater remediation for approval to install an offsite extraction well, one onsite pumping well will initially be brought online. After the interim soil and groundwater remediation system is installed, the adequacy of the zone of capture achieved with the interim system will be reassessed. Additional on and offsite groundwater recovery wells may then be installed and plumbed to the interim groundwater remediation system.

Groundwater Remediation System

The proposed interim groundwater remediation system is a one well (either W-1 or W-2) groundwater extraction, diffused aeration tank, and activated carbon treatment system. At any given time, only one of the existing wells W-1 or W-2 will be extracting groundwater while the other well will be used as a vapor extraction well. Plate 3 shows the location of the proposed extraction well (W-1 or W-2), the proposed location of the remediation compound and the proposed sewer lateral connection. Plate 4 depicts a schematic of the proposed soil and groundwater remediation system.

Groundwater will be extracted from a single existing recovery well (W-1 or W-2) using a submersible pump. Results of the pump test conducted indicated that a single well extracting at a flowrate of 0.24 gpm should capture the high concentrations of the dissolved hydrocarbon plume onsite. Existing well W-2 will be fitted at the well vault with a submersible pump, mechanical flow meter, overheating circuit breaker (since the pump may be cycling frequently at this low flow), sample port, flow control valve, and well vault with a traffic rated cover. Existing well W-1 will also be fitted with necessary water lines and associated instrumentation and electrical controls so that it can be used as a groundwater recovery well at a later date by installing a submersible pump in the well.

Extracted water will be pumped to the groundwater treatment system which will consist of a diffused aeration tank and two in-series 200 pound liquid phase activated carbon canisters. It is estimated that the groundwater treatment system will need to operate for a minimum of two to five years. An effective way of removing volatile and some semi-volatile compounds from groundwater is to utilize an enclosed aeration treatment tank. Water containing hydrocarbons is pumped into a tank where a diffused air stream passes through the hydrocarbon-bearing water. The air removes the volatile compounds from the water and

the off-gases are then subjected to secondary treatment (vapor phase carbon) to meet the Bay Area Air Quality Management District (BAAQMD) emission requirements. The vapor phase carbon adsorption system is described in detail in the ensuing section entitled "Vapor Extraction System". Enclosed in Attachment A are manufacturer's specifications for aeration tanks, liquid and vapor phase carbon. Carbon vessels to be used will be Sun-Ag, Inc. 200 and 1,200 pound vessels filled with West States "Aqua and Vapor Carb" or equivalent carbon. Information is also provided on removal efficiencies that the aeration tank can achieve for several contaminants of concern. Typical removal rates for aeration systems are greater than 95 percent for TPHg. The removal rates for using a system containing both the aeration system and activated carbon are greater than 99 percent. Attachment B summarizes results of water balance calculations that predict a liquid phase carbon changeout frequency greater than one year per canister.

The aerated water flows from the aeration tank to two, 200 pound liquid phase activated carbon canisters in series, to meet the discharge requirements set forth by the East Bay Municipal Utility District (EBMUD) as shown on Plate 4. Effluent water from the carbon canisters is discharged to an onsite sewer lateral as shown on Plate 3.

As a part of spill prevention and containment the aeration tank and the two liquid-phase carbon canisters will be installed on double containment pallets with overflow protection. Other spill prevention measures will include: a pressure indicator installed on the first carbon canister to prevent over-pressurizing the carbon canisters; high and low level indicators, and a pressure switch and indicator in the aeration tank; the control of the transfer pump by level indicators to transfer water from the diffused aeration tank through the two carbon canisters and to the sewer; a pressure shutoff valve set at approximately eight pounds per square inch (psi) to limit the output of the transfer pump; and a remote monitoring system to continuously monitor and periodically report the process variables which can influence the systems' performance and cause an alarm or shut-down condition. When any of these conditions are triggered the remote monitoring system will notify RESNA's San Jose office personnel by facsimile so the condition can be readily rectified prior to system restart. Any system failure causing a release will be reported immediately to the EBMUD and a written report will be filed with EBMUD within five working days of any such release.

Vapor Extraction System

To enhance groundwater cleanup, a vapor extraction system (VES) will be installed so that soils in the vicinity of the gravel backfill exposed as a result of the drawdown achieved by groundwater extraction can be remediated.

The VES will consist of a one well, either W-1 or W-2, and a vapor-phase activated carbon system for off-gas abatement. Plate 4 shows the process flow schematic of the VES. At any given time, only one of the existing wells W-1 or W-2 will extract vapors from subsurface soils, while the other well will be used as a groundwater recovery well. The use of wells W-1 and W-2 either as a groundwater recovery or as a vapor extraction well and vice versa, give the remediation system the flexibility to impact different areas of concern, thus enhancing remediation.

The well used for vapor extraction will be equipped with a vacuum gage, a sample port and a shut-off valve so that flow through the well can be adjusted to maximize the total pounds of petroleum hydrocarbons being extracted from the soil. The well will be piped underground and will terminate to the off-gas abatement unit. Other components of the VES will be located at the remediation compound and will include a vacuum blower that will extract vapors from the well, a flow indicator that measures extracted flow, a condensate separator to remove any moisture in extracted vapors, two 1,200 pound vapor phase carbon canisters, a set of associated piping, control valves, instrumentation and controls, a remote monitoring system, and a fenced remediation compound to preclude public access. Off-gas from the groundwater remediation system (the aeration tank) will also be abated by the vapor phase carbon canisters as shown in Plate 4. The off-gas abatement unit will ensure that vapors discharged to the atmosphere will meet BAAQMD emission requirements. Existing groundwater recovery well W-2 will be fitted with necessary vapor lines and associated controls to enable the well to be used as a vapor well, if necessary at a later date by plumbing to the existing VES.

An internal combustion (I.C.) engine may be used to reduce high initial hydrocarbon concentrations. The I.C. engine will be operated for a maximum two week period under the existing BAAQMD guidelines. No vapor extraction test has been performed due to the shallow groundwater table at the site. Hence, an evaluation of the vapor phase carbon breakthrough rate is not presented at this time but will be made after start-up of the groundwater remediation system, and the VES.

Spill prevention measures will include: a pressure indicator installed on the first carbon canister to prevent over-pressurizing the carbon canisters; lower explosivity limit (LEL) monitoring; a low pressure switch and indicator influent to the blower to shut the VES off in event of blower failure; and a remote monitoring system to continuously monitor and periodically report the process variables which can influence the systems' performance and cause an alarm or shut-down condition. When any alarm conditions are triggered the remote monitoring system will notify RESNA's San Jose office personnel by facsimile so the condition can be readily rectified prior to system restart.

PROPOSED SCOPE OF WORK

Based on results of previous subsurface investigations, RESNA proposes the following project Tasks 1 through 7, listed below, as a method of approach to remediate hydrocarbon-impacted soils and groundwater at the site. These tasks outlined below are described in detail in ensuing sections:

- o Task 1. Remedial Action Work Plan
- o Task 2. Design of Plans and Specifications
- o Task 3. Building and Discharge Permits
- o Task 4. Bid Package and Evaluation
- o Task 5. Systems Installation
- o Task 6. Systems Startup and Operation
- o Task 7. Systems Startup Report.

Task 1. Remedial Action Work Plan

Submit this Remedial Action Plan (RAP, Addendum Two to the Work Plan) to the RWQCB and ACHCSA for approval, prior to soil and groundwater remediation system installation and operation. This RAP describes the proposed interim soil and groundwater remediation system detailed above, its design, installation and proposed operation and maintenance. A preliminary schedule of work, including a construction schedule, is presented. Engineering drawings are included as appropriate.

Task 2. Design of Plans and Specifications

Work under this task includes: engineering calculations; bill of materials; preparation of approximately 70 % complete Plans and Specifications including site and remediation compound layouts; trench and section details, process and instrumentation diagram (P&ID), and a one line electrical diagram; in-house plan check and review; and one set of revisions to the Plans and Specifications by ARCO. Upon receipt of the BAAQMD air permit and the EBMUD wastewater discharge permit, and on completion of the Plans and Specifications, the Plans will be ready to be submitted to the local City Building Department for approval, prior to installation. One set of revisions to the Plans and Specifications is planned, to incorporate changes by the City Building Department, BAAQMD and EBMUD. Also under this task, RESNA personnel will meet with Pacific Gas & Electric Company (PG & E) and City of Oakland personnel to discuss electrical service requirements, the proposed discharge point and City requirements for sewer hookup.

Task 3. Building and Discharge Permits

An EBMUD Sewer Discharge Permit will be completed and submitted to the Industrial Waste Department of EBMUD for approval, in order to discharge treated groundwater to the sewer. The sewer permit application will include a site history, analytical results for heavy metals, purgeable halocarbons, petroleum hydrocarbons, and any other suspected pollutants.

An Authority to Construct and Permit to Operate Application will be completed and submitted to the BAAQMD to allow for construction of the proposed soil and groundwater remediation system. The application will include a site history, VES specifications, and sample analytical results for known and suspected pollutants.

The complete set of Plans and Specifications will be submitted to the City of Oakland Building, Planning and Fire Departments for approval prior to construction and installation of the remediation systems. As a part of the permit approval process, the City Building Department will inspect all open utility trenches carrying water and vapor lines prior to their closure and tie-in to the above ground VES and groundwater remediation systems.

Task 4. Bid Package and Bid Evaluation

After the design is completed, a bid package will be prepared for submittal to construction contractors. A minimum of three pre-qualified contractors will receive the bid package. One meeting with each contractor is included under this task, as well as time to answer contractor questions. This will not be a publicly advertised bid. One site visit with each contractor is also planned. Contractor bids will be evaluated and recommendations made.

Task 5. Systems Installation

Upon approval of the RAP, and after having secured the City Building, Fire and Planning Department Permits, and OIL selection of a general contractor, system installation in accordance with the approved Plans and Specifications will be initiated. System installation will include: capital equipment procurement (liquid and vapor phase carbon, blower, pumps and the aeration tank); construction of utility trenches to contain all necessary water, vapor and electrical lines; installation of necessary underground pipes and electrical conduits to and from the proposed treatment compound; pressure testing of lines for leaks; City inspection of utility trenches prior to closure; construction of the remediation compound; electrical service and sewer hookups; and installation and plumbing of all soil and groundwater remediation equipment.

Task 6. System Startup and Operation

System Monitoring

After completion of system installation, operation of the proposed interim soil and groundwater remediation system will be initiated in compliance with all applicable regulatory agencies. Startup procedures will include system monitoring, maintenance and sampling for the first five days of operation. System monitoring will be conducted based on the requirements of the self-monitoring program set forth by EBMUD and the BAAQMD. Operation and maintenance of the soil and groundwater remediation systems, described previously, typically include: daily site inspections the first five days of operation; site visits once every week for the first month; and once every two weeks for the next one month. The remote monitoring system will be online 24 hours per day throughout system operation. After the first two months of operation site visits will be made at a minimum, once every month for the remainder of the life of the remediation system. Modifications to this typical schedule will be made if additional requirements are specified by the guidelines set forth by EBMUD and the BAAQMD, and as necessary.

Site inspections will include: monitoring and adjustment of systems parameters to optimize soil and groundwater remediation system efficiencies; periodic sampling of influent and effluent to the VES and groundwater remediation system as required by the BAAQMD and EBMUD permits; other periodic maintenance procedures including inspection and cleaning of all lines, process equipment, carbon changeout, etc. Parameters monitored and adjusted in the field will include: groundwater extraction rates to ensure that an adequate capture zone is achieved; and field measurement of vapor extraction flowrates, induced vacuum responses at on and offsite wells, and hydrocarbon vapor concentrations, to ensure that an adequate radius of influence is achieved, and that BAAQMD emission requirements are being met.

System Sampling

In accordance with typical EBMUD and BAAQMD permit guidelines, during the start-up phase, influent and effluent samples to the VES and groundwater remediation system will be taken daily for the first five days of operation and every week thereafter for the next one month after which sample collection will be performed once every two weeks for the second month of operation. After the first two months of operation, sample collection will be made on a monthly basis for the life of the remediation system. Water samples collected will be analyzed for BTEX and TPHg and other required constituents as set by EBMUD in the wastewater discharge permit. With the exception of influent and effluent air samples collected and analyzed as detailed above, during the first day of operation and later on a

monthly basis, all other sampling of the VES will be conducted using a field organic vapor monitoring instrument approved by the BAAQMD (typically a photo- or a flame-ionization detector). If at any time the results of laboratory analysis or field monitoring readings indicate that discharge parameters have been exceeded, a confirmation sample will be taken immediately and analyzed on a 24 hour turnaround basis. If discharge parameters are still exceeded, the system will be shut down and any necessary corrective action will be performed before repeating the start-up sequence. EBMUD and BAAQMD will be notified that discharge parameters were exceeded within 24 hours of such indication. It is estimated that the groundwater remediation system operation and monthly monitoring will continue for a minimum of 2 to 5 years. Modifications to the above sampling schedule will be made if additional requirements are set forth by EBMUD and BAAQMD in the wastewater discharge and air permits for this site, and as necessary for efficient operation of the system.

During the first day of operation of the groundwater remediation system, treated water will be stored in a above-ground tank. Effluent samples will be collected and analyzed on a 24-hour basis to demonstrate that treated water meets EBMUD discharge requirements, prior to restart of the system with direct discharge to the sewer.

Results of periodic sampling of system influent and effluent water as required by EBMUD and BAAQMD during the startup phase and later months of operation will be used as an indication of the frequency of carbon changeout required. A totalizing flow meter will be installed to determine the quantity of treated ground water discharged to the sewer. A remote monitoring system will be installed to continuously monitor and periodically report the variables which can influence the systems' performance and cause an alarm condition. The monitoring system will also notify RESNA's San Jose office when an alarm condition exists.

Task 7 System Startup Report

An initial startup report will be prepared and submitted to ARCO, and state agencies. This report will document all field data collected, laboratory results of influent and effluent air and water samples collected and analyzed, carbon breakthrough calculations, and other data. Based on results obtained, recommendations will be made to further optimize system performance and expedite remediation of subsurface impacted soils and groundwater. Recommendations may include tie-in of additional groundwater recovery wells to the remediation system, upgrading of the off-gas abatement unit, etc.

SCHEDULE

Plate 5 shows the preliminary schedule to complete Tasks 1 through 7. This schedule is contingent upon obtaining regulatory agencies approval within the estimated time frames shown on Plate 5. The permitting time frame is expected to take as long as the engineering time frame.

DISTRIBUTION

It is recommended that a copy of this Addendum Two to the Work Plan be submitted for review and approval to:

Mr. Lester Feldman
Regional Water Quality Control Board
San Francisco Bay Region
2101 Webster Street, Suite 500
Oakland, California 94612

Mr. Larry Seto
Hazardous Materials Specialist
Alameda County Health Care Services Agency
Department of Environmental Health
80 Swan Way, Room 200
Oakland, California 94621

Please call us at (408) 264-7723 if you have any questions or comments regarding this Addendum Two to the Work Plan.

Sincerely,
RESNA



Valli Voruganti
Project Engineer

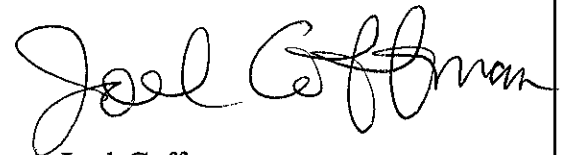

Joel Coffman
Project Geologist

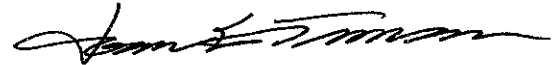

Joan E. Tiernan, Ph.D., P.E.
Engineering Manager

cc: Mr. H.C. Winsor, ARCO Products Company

Attachments: List of References Cited

Plate 1, Site Vicinity Map
Plate 2, Generalized Site Plan and Area Map
Plate 3, Proposed Remediation Site Plan
Plate 4, Process Flow Schematic
Plate 5, Preliminary Time Schedule

Table 1, Results of Laboratory Analyses of Water Samples

Attachment A, Manufacturer's Specifications on Aeration Tanks,
Liquid and Vapor Phase Carbon
Attachment B, Water Balance Calculations

LIST OF REFERENCES CITED

Aqua Science Engineers, May 27, 1986, Walnut Creek, California.

RESNA/Applied GeoSystems (AGS). June 15, 1988. Report Limited Environmental Site Assessment at ARCO Station 374, 6407 Telegraph Avenue, Oakland, California. AGS 18039.01.

RESNA/AGS. August 1, 1988. Report Environmental Investigation Related to Underground Tank Removal at ARCO Station 374, 6407 Telegraph Avenue, Oakland, California. AGS 18039.02.

RESNA/AGS March 27, 1991. Report Limited Subsurface Environmental Investigation at ARCO Station 374, 6407 Telegraph Avenue, Oakland, California. AGS 18039.03.

RESNA/AGS. July 31, 1991. Report of Pumping and Recovery Test Results at ARCO Station 374, 6407 Telegraph Avenue, Oakland, California. AGS 60025.04.

RESNA/AGS. October 30, 1991. Letter Report Quarterly Groundwater Monitoring Third Quarter 1991 at ARCO Station 374, 6407 Telegraph Avenue, Oakland, California.



Base: U.S. Geological Survey
 7.5-Minute Quadrangles
 Oakland West/East, California
 Photorevised 1980

LEGEND

○ = Site Location

Approximate Scale



RESNA

SITE VICINITY MAP
ARCO Station 374
6407 Telegraph Avenue
Oakland, California

PLATE

1

PROJECT

60025.08

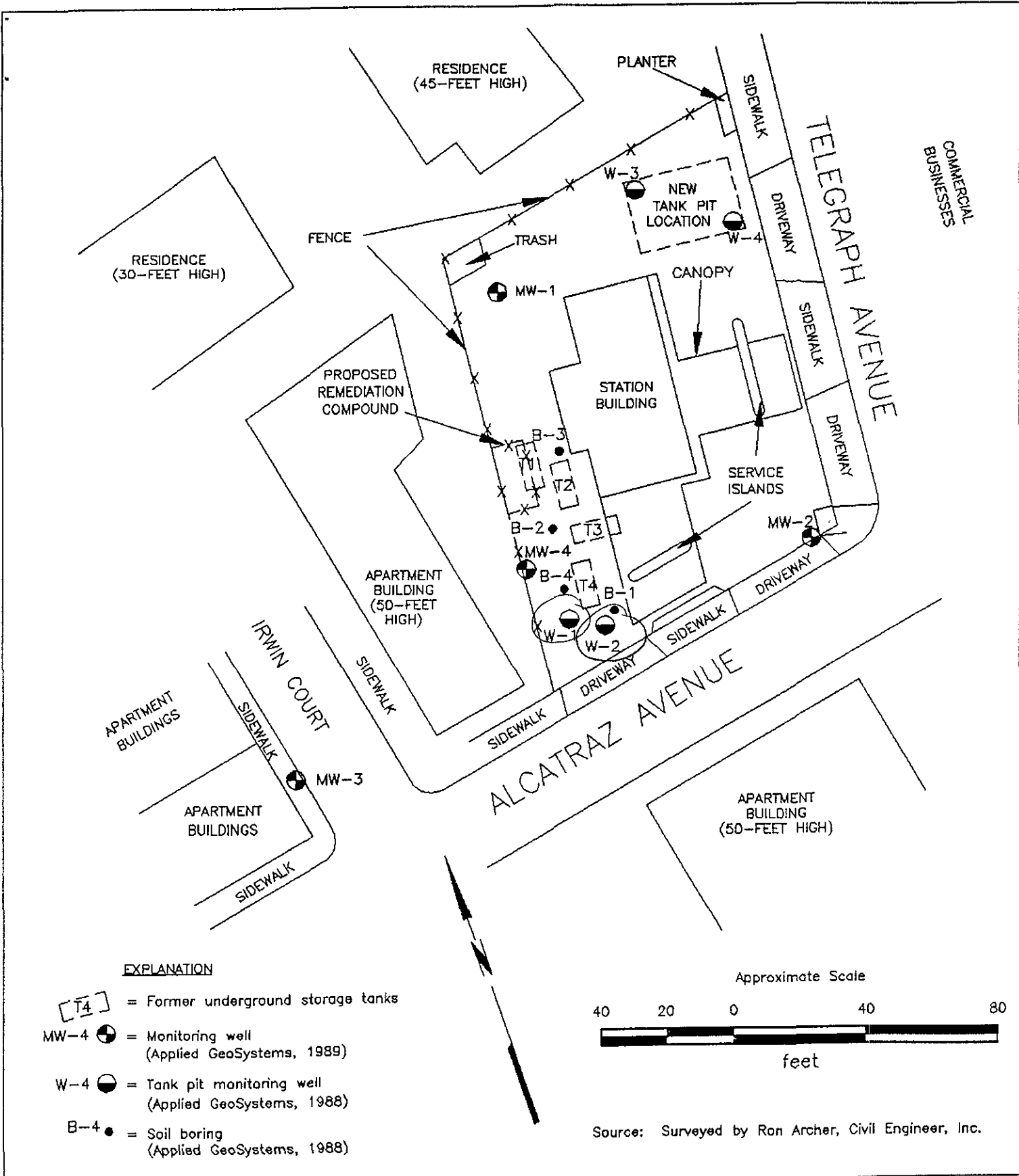

EXPLANATION

- [T4] = Former underground storage tanks
- MW-4 ● = Monitoring well (Applied GeoSystems, 1989)
- W-4 ● = Tank pit monitoring well (Applied GeoSystems, 1988)
- B-4 ● = Soil boring (Applied GeoSystems, 1988)

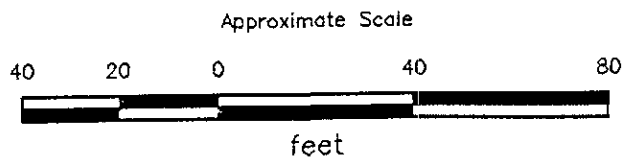

Source: Surveyed by Ron Archer, Civil Engineer, Inc.

<h1>RESNA</h1>	GENERALIZED SITE PLAN AND AREA MAP ARCO Station 374 6407 Telegraph Avenue Oakland, California	PLATE 2
	PROJECT 60025.08	

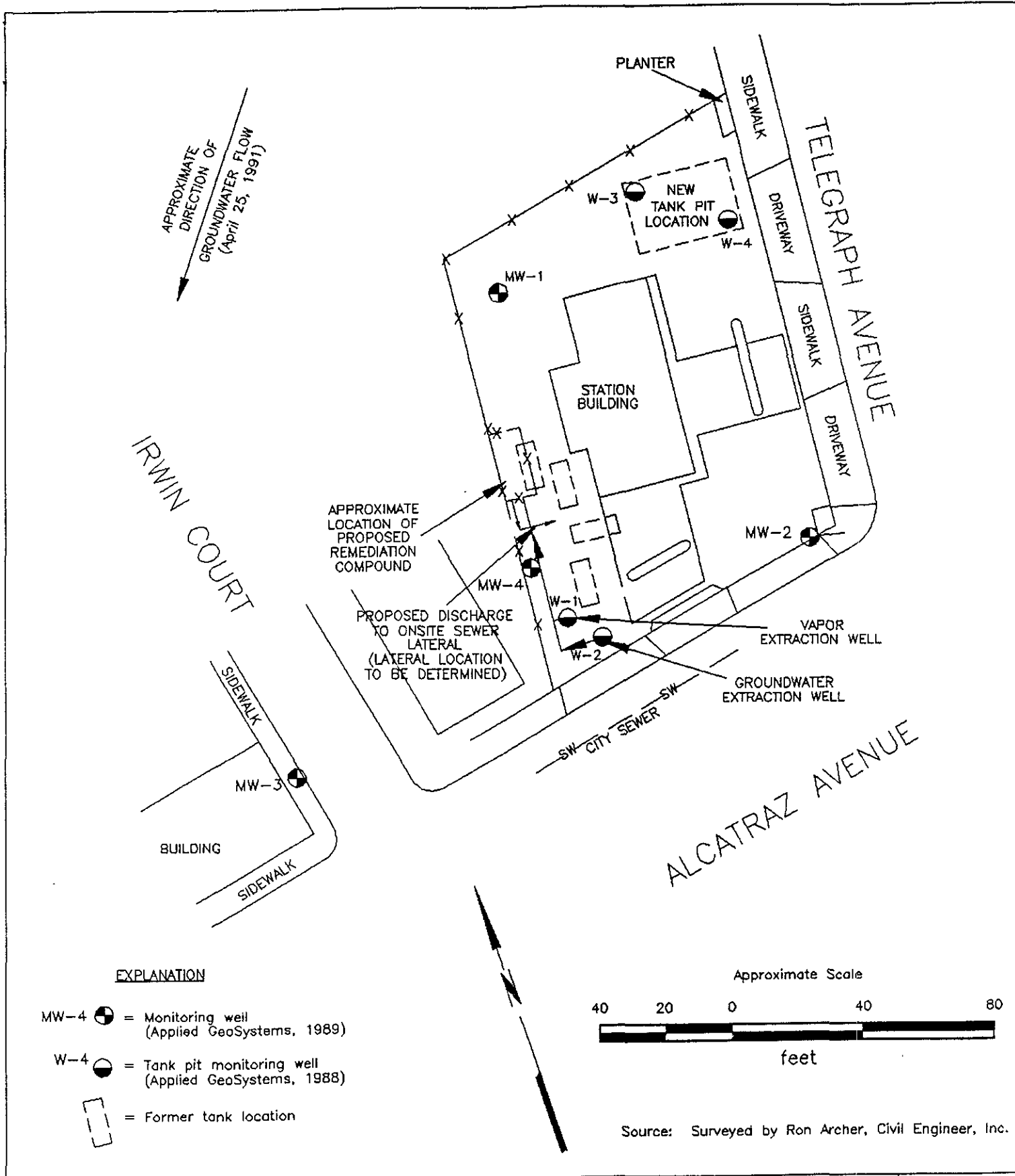

RESNA

PROJECT

60025.08

**PROPOSED
REMEDATION SITE PLAN
ARCO Station 374
6407 Telegraph Avenue
Oakland, California**

PLATE

3

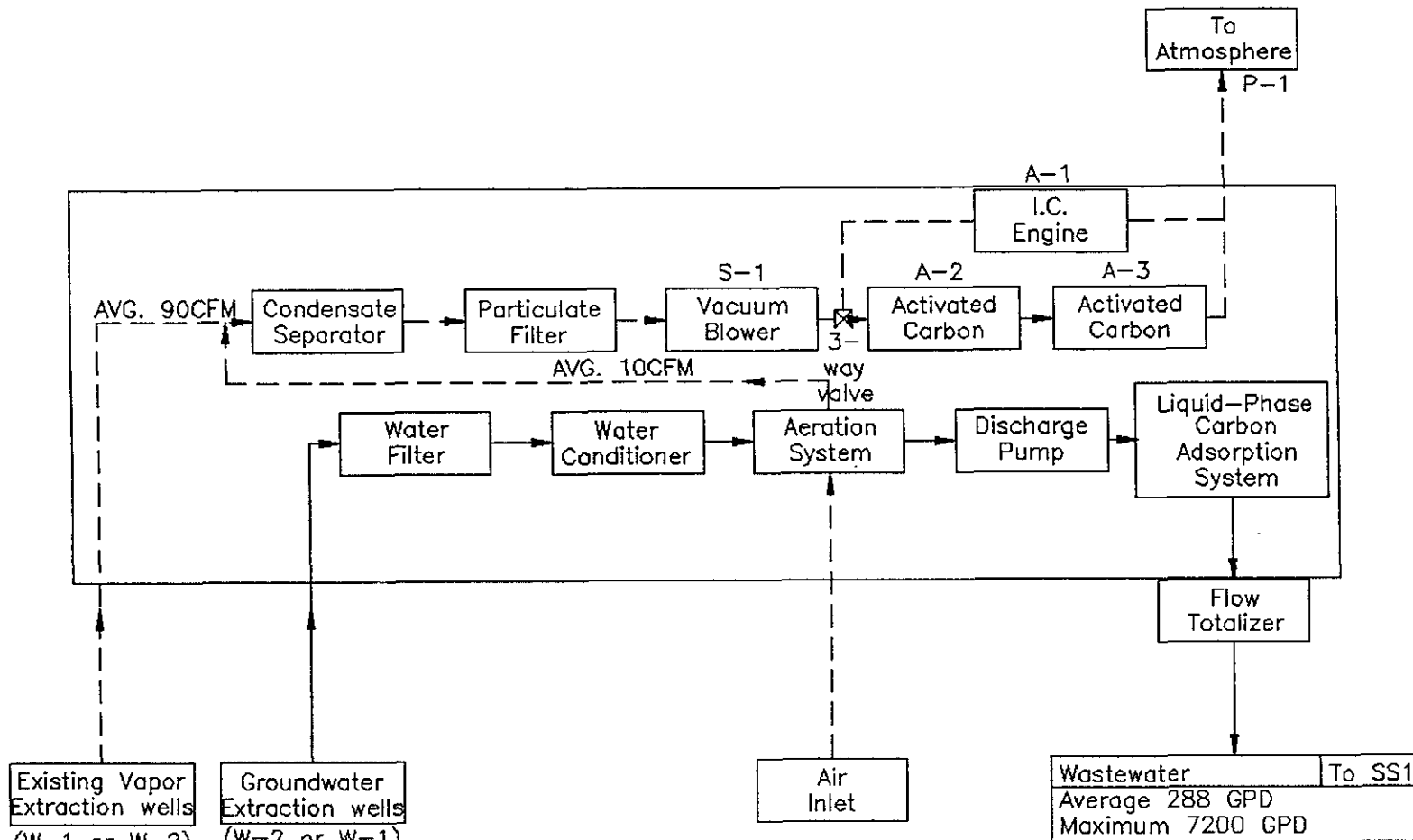

EXPLANATION

S-1 = 1.5 Horsepower high vacuum blower

A-1 = 300-cubic inch I.C. engine (used during the first two weeks of system operation)

A-2, A-3 = 1200-pound vapor phase carbon

P-1 = 15-foot high exhaust stack (2-inches diameter)

—————> = Water flow

- - - - -> = Air flow

EXPLANATION

CFM = Cubic feet per minute

SS1 = Sanitary sewer #1

GPD = Gallons per day

PLATE

4

**PROCESS FLOW SCHEMATIC
ARCO Station 374
6407 Telegraph Avenue
Oakland, California**

RESNA

PROJECT

60025.08

TASK 1:
Remedial Action
Work Plan

TASK 2:
Design of plans and
specifications

TASK 3:
1) Discharge permits
2) Building permits

TASK 4:
Bid package and
Bid evaluation





TASK 5:
System installation

TASK 6:
System start up

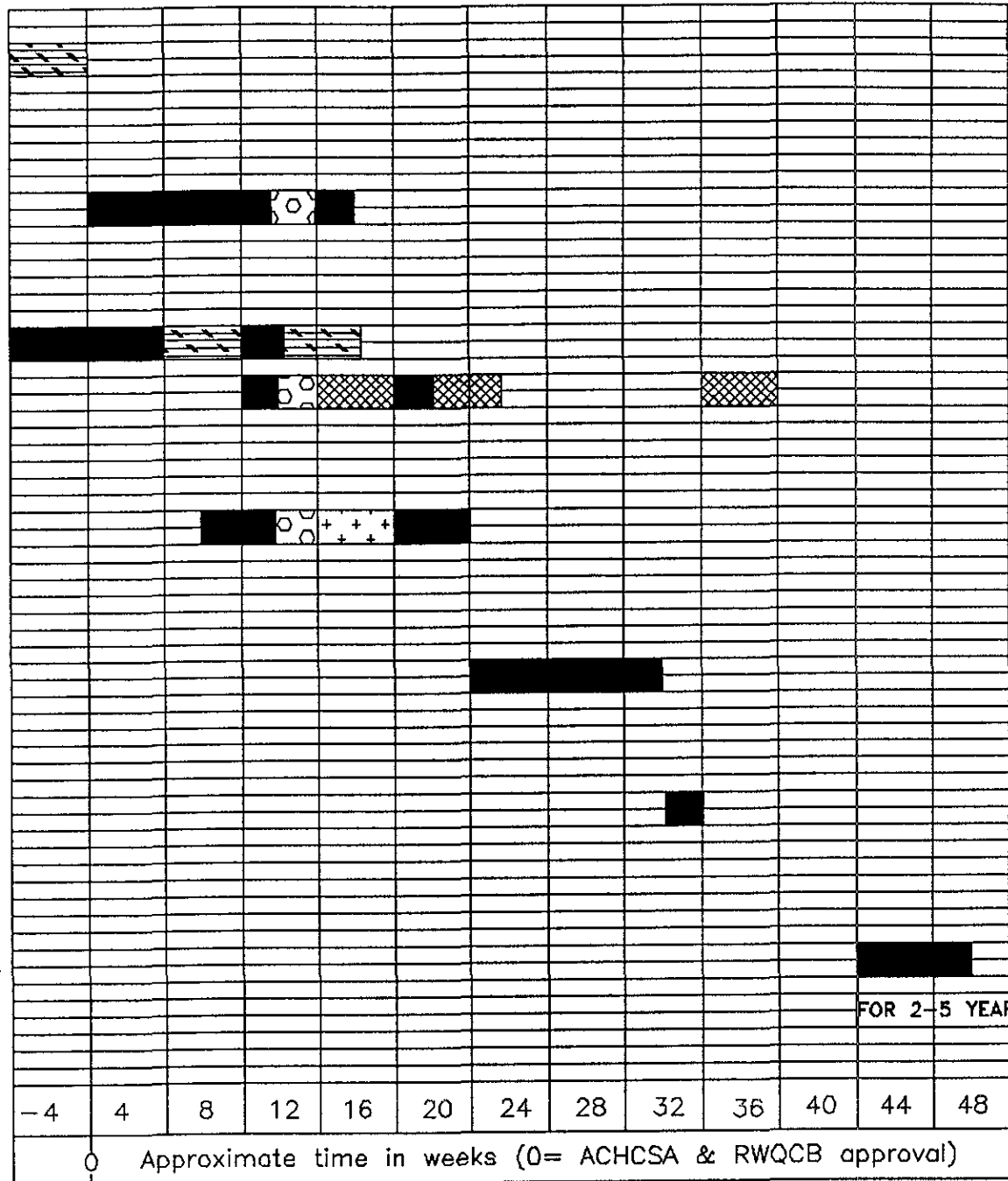
TASK 7:
System start up report

System operation



-  Engineering
-  ARCO review time
-  Regulatory review time (RWQCB, ACHCSA, EBMUD, BAAQMD)
-  City of Oakland review time
-  Contractor bid preparation

RESNA

PROJECT 60025.08

PRELIMINARY TIME SCHEDULE
ARCO Station 374
6407 Telegraph Avenue
Oakland, California

PLATE
5

TABLE 1
 RESULTS OF LABORATORY ANALYSES OF WATER SAMPLES--TPHg, TPHd, BTEX, AND TOG
 ARCO Service Station 374
 Oakland, California
 (Page 1 of 3)

Date/Well	TPHg	TPHd	B	T	E	X	TOG
<u>MW-1</u>							
07/21/89	33	NA	0.77	1.6	1.5	5.0	NA
08/30/89	<20	NA	<0.50	<0.50	<0.50	<0.50	NA
10/04/89	<20	NA	<0.50	<0.50	<0.50	<0.50	NA
01/10/90	<20	NA	<0.50	<0.50	<0.50	<0.50	NA
08/07/90	<20	NA	<0.50	<0.50	<0.50	<0.50	NA
12/06/90	<50	NA	3.6	2.7	0.60	5.80	NA
02/20/91	<50	NA	<0.50	<0.50	<0.50	<0.50	NA
07/08/91	<30	NA	<0.30	<0.30	<0.30	<0.30	NA
09/25/91	<30	NA	0.57	0.57	0.54	1.7	NA
11/20/91	57	NA	9.2	3.7	0.63	2.5	NA
<u>MW-2</u>							
07/21/89	4,200	NA	280	210	38	24	NA
08/30/89	4,200	NA	160	260	45	240	NA
10/04/89	4,300	NA	860	300	29	330	NA
01/10/90	8,000	NA	890	710	120	760	NA
08/07/90	6,000	NA	880	76	25	80	NA
12/06/90	1,600	NA	330	69	18	63	NA
02/20/91	1,300	NA	160	46	13	48	NA
07/08/91	310	NA	76	18	7.7	24	NA
09/25/91	83	NA	17	0.69	2.2	4.1	NA
11/20/91	180	NA	46	6.1	3.0	8.7	NA
<u>MW-3</u>							
07/21/89	430	NA	9	4.8	<0.50	50	NA
08/30/89	1,200	NA	85	46	8.4	55	NA
10/04/89	7,000	NA	580	900	120	670	NA
01/10/90	940	NA	130	59	21	73	NA
08/07/90	2,300	NA	180	64	59	120	NA
12/06/90	460	350	52	55	14	39	NA
02/20/91	470	<100	36	30	9.3	31	<5,000
07/08/91	2,500	NA	240	470	74	320	NA
09/25/91	1,100	NA	120	110	34	120	NA
11/20/91	1,000	NA	180	140	43	140	NA
<u>MW-4</u>							
07/21/89	8,700	NA	720	360	120	640	NA
08/30/89	7,300	NA	630	220	72	320	NA
10/04/89	21,000	NA	2,300	1,300	280	1,300	NA
01/10/90	4,300	NA	470	250	63	430	NA
08/07/90	69,000	28,000	8,700	4,200	540	4,600	<5,000
12/06/90	Not sampled--product sheen						
02/20/91	5,200	<100	690	200	95	580	<5,000
07/08/91	1,700	NA	280	68	37	170	NA

See notes on page 2 of 2

TABLE 1
 RESULTS OF LABORATORY ANALYSES OF WATER SAMPLES--TPHg, TPHd, BTEX, AND TOG
 ARCO Service Station 374
 Oakland, California
 (Page 2 of 3)

Date/Well	TPHg	TPHd	B	T	E	X	TOG
<u>MW-4 Continued</u>							
09/25/91	6,300	NA	2,100	290	210	590	NA
11/20/91	2,700	NA	1,200	200	110	320	NA
MCL:	--	--	1	--	680	1,750	--
AL:	--	--	--	100	--	--	--

Results in micrograms per liter (ug/L) = parts per billion (ppb).

TPHg: Total petroleum hydrocarbons as gasoline by EPA method 5030/8015.

TPHd: Total petroleum hydrocarbons as diesel by EPA method 3510/8015.

BTEX: B: Benzene, T: Toluene, E: Ethylbenzene, T: Total Xylene isomers; measured by EPA method 8020/602.

TOG: Total oil and grease measured by Standard Method 5520 B/F.

<: Results reported as less than the detection limit.

NA: Not analyzed

*: Unregulated by California DHS, October 24, 1990.

MCL: State Maximum Contaminant Level.

AL: State recommended Action Level.

TABLE 1
 RESULTS OF LABORATORY ANALYSES OF WATER SAMPLES—VOCs and Metals
 ARCO Service Station 374
 Oakland, California
 (Page 3 of 3)

Date/Well	VOC (ppb)	Cd (ppm)	Cr (ppm)	Pb (ppm)	Ni (ppm)	Zn (ppm)
<u>MW-4</u> 07/31/90	Nondetectable for thirty one compounds tested (<1.0)	NA	NA	NA	NA	NA
02/20/91	Chloromethane* 3.4; nondetectable for twenty eight other compounds tested (<0.5)	NA	NA	NA	NA	NA
11/20/91	NA	<0.010	<0.010	<0.0050	<0.050	0.019

VOC results in micrograms per liter (ug/L) = parts per billion (ppb).
 Metal results in milligrams per liter (mg/L) = parts per million (ppm).
 Halogenated Volatile Organics measured by EPA method 601/8010.

ATTACHMENT A

**MANUFACTURER'S SPECIFICATIONS ON AERATION TANKS,
LIQUID AND VAPOR-PHASE CARBON**



AEROMIX SYSTEMS
BREEZE INFORMATION

BREEZE STRIPPING SYSTEM SPECIFICATION

A. General

Provide a total of _____ BREEZE stripping systems as manufactured by AEROMIX SYSTEMS, INCORPORATED of Minneapolis, Minnesota. Each system shall consist of a sealed polypropylene baffled tank with air diffusers and air blower. The tank shall incorporate inlet and outlet fittings to allow contaminated water to be fed in, purified water to be drawn off, and vented gas to be discharged.

B. Tank Construction

1. The tank shall be constructed of high strength, heat resistant polypropylene with a minimum 0.375" wall thickness. All joints shall be welded and completely water tight.
2. An air tight sealed cover shall be provided constructed of high strength, heat resistant polypropylene with a minimum 0.375" wall thickness. Removable stainless steel bolts shall be supplied to lock cover in sealed position. Cover shall be capable of being completely removed for servicing.
3. Inner baffles shall be provided to direct the flow in a tortuous path maximizing air to water contact. A total of _____ baffled sections shall be provided. Baffles shall be welded to the inner tank walls and shall be constructed of high strength, heat resistant polypropylene with a minimum 0.25" wall thickness.
4. The overall tank configuration shall provide a nearly even water level throughout all baffled sections in order to maximize aeration and detention time. Units with different water level sections will not be acceptable.

C. Tank Fittings

The tank shall be provided with at least one _____" PVC bulkhead fitting (FPT) for each of the inlet, outlet, and vent gas.

D. Air Header

A minimum _____" diameter schedule 40 PVC air header shall be supplied external to the aeration tank so it can be serviced and accessed if necessary. Units with internal headers will not be acceptable. Headers shall incorporate tees to feed air into the diffusers in the aeration tank. A water and air tight seal shall be provided as the header tee passes through the aeration tank wall.

E. Air Diffusers

1. Each baffled section in the aeration tank shall incorporate two CYCLONE stainless steel diffusers as manufactured by AEROMIX SYSTEMS INCORPORATED. Each diffuser shall be designed to provide wide band aeration. Air shall be released through a series of ports on the diffuser.

2. The diffuser shall be diamond shaped with a series of small air outlet ports on the top of the diamond and a series of large air outlet ports on the lower portion of the diamond. The diamond construction is critical to promote bubble shear and rapid gas transfer into the liquid.

3. The body of the diffuser shall be constructed of 304L stainless steel. A heavy wall end cap shall be provided with an integral 3/4" NPT male pipe connection equivalent to schedule 80 pipe.

4. A balancing orifice shall be provided as required within the 3/4" NPT male pipe connection to assure proper head loss and uniform distribution of air throughout the system.

5. The diffuser shall be easily removable for replacement or servicing by unscrewing it from the air header.

F. Air Blower

A total of _____ regenerative air blower(s) shall be provided. Normal blower location is remote from the aeration tank. Each blower shall be _____ Hp, _____ VAC, _____ Hertz, _____ Phase and produce up to _____ scfm at _____" of water head. Normal motor is TEFC. Explosion proof motors can be supplied if specified.

2" FPT VENT CONNECTION

SEALED COVER

2" FPT
OUTLET
CONN

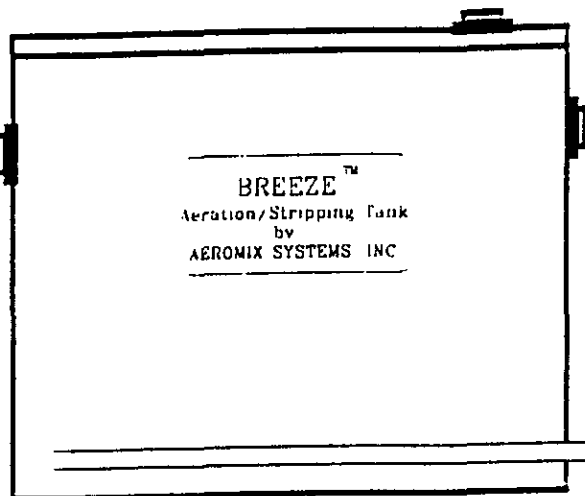

BLOWER

(REMOTE LOCATION)

SIDE VIEW

APPROXIMATE TANK DIMENSIONS 36" L X 22" H X 30" W

APPROXIMATE OVERALL DIMENSIONS 40" L X 24" H X 36" W (WITHOUT BLOWER)

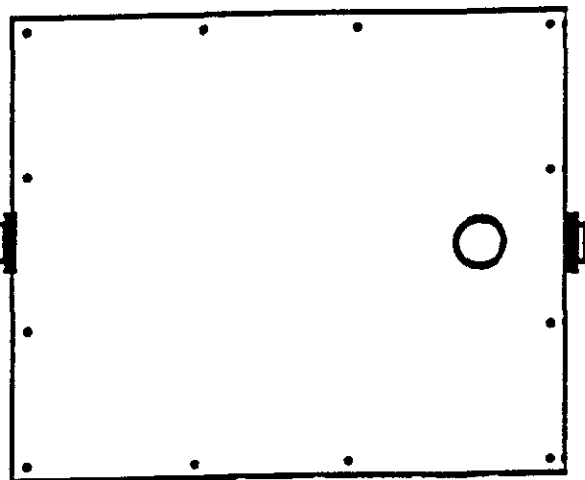

1.5" PVC AIR HEADER

TOP VIEW

AEROMIX SYSTEMS, INCORPORATED
2611 North Second Street
Minneapolis, Minnesota 55411

BREEZE SERIES 1

FLOWS UP TO 75 GPM

Date 5/30/91

Notes: All drawings are preliminary and intended for informational purposes only. All dimensions are approximate and subject to change without notice. All drawings are the property of AEROMIX SYSTEMS, INC. and shall remain the property of AEROMIX SYSTEMS, INC. unless otherwise indicated.

2" FPT VENT CONNECTION

SEALED COVER

2" FPT
OUTLET
CONN

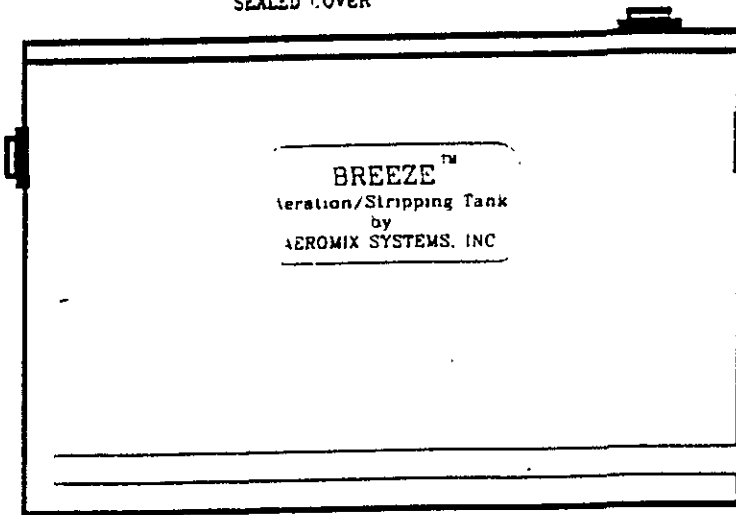

2" FPT INLET CONNECTION

BLOWER

(REMOTE LOCATION)

SIDE VIEW

APPROXIMATE TANK DIMENSIONS 45" L X 32" H X 30" W

APPROXIMATE OVERALL DIMENSIONS 55" L X 34" H X 36" W (WITHOUT BLOWER)

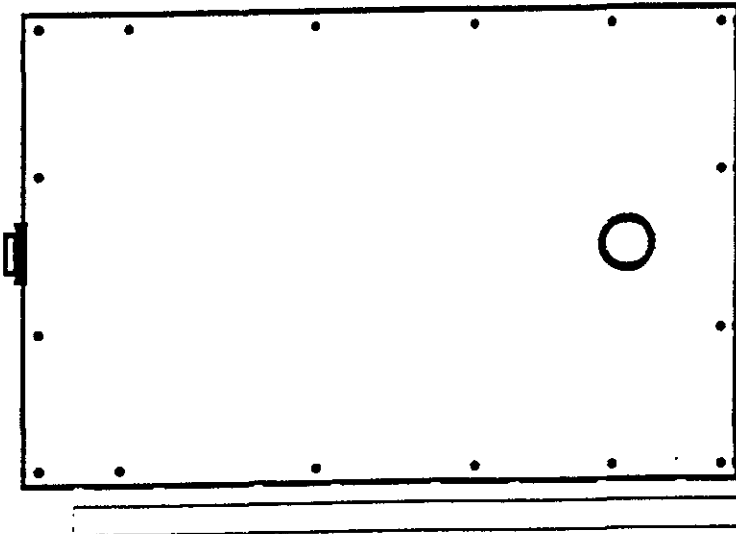

2" PVC AIR HEADER

TOP VIEW

AEROMIX SYSTEMS, INCORPORATED
2611 North Second Street
Minneapolis Minnesota 55411

BREEZE SERIES 4

FLOWS UP TO 100 GPM

Notes: This drawing is confidential and provided solely for the use of the recipient. No other use, reproduction, or distribution is permitted without the written consent of AEROMIX. All rights reserved. © 1991 AEROMIX SYSTEMS, INC. AEROMIX SYSTEMS, INC. is a registered trademark of AEROMIX SYSTEMS, INC.

Date: 07/30/91

SEALED COVER

3" FPT VENT CONNECTION

3" FPT
OUTLET
CONN

3" FPT INLET CONNECTION

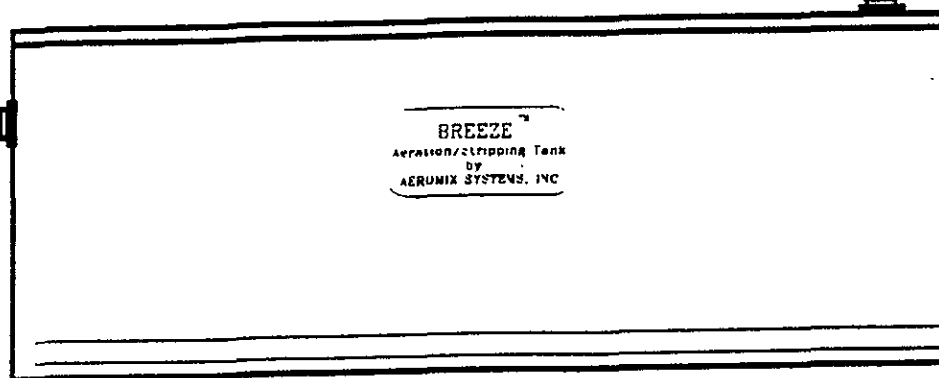

BREEZE™
Aeration/Stripping Tank
by
AEROMIX SYSTEMS, INC

BLOWER

(REMOTE LOCATION)

SIDE VIEW

APPROXIMATE TANK DIMENSIONS: 80" L x 22" H x 20" W

APPROXIMATE OVERALL DIMENSIONS: 80" L x 24" H x 26" W (WITHOUT BLOWER)

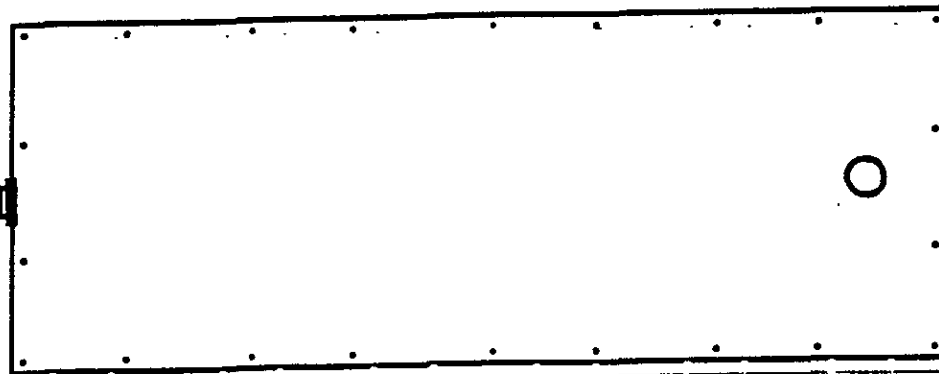

3" PVC A.R. HEADER

TOP VIEW

AEROMIX SYSTEMS, INCORPORATED
2611 North Second Street
Minneapolis Minnesota 55411

Notes: This drawing is confidential and should not be used for decision making by the customer. It is to be copied, stored or in any way provided to other parties without the written consent of AEROMIX.
Final placement and layout of equipment should be determined by an AEROMIX factory representative.

BREEZE SERIES 6

FLOWS UP TO 200 GPM

Date: 5/30/91

BREEZE PERFORMANCE

Contaminate removal rates vary considerably and depend on relative Henry's Constants, water flow rate, air to water ratio (A/W), and the make-up of the contaminated water. A/W ratio is:

$$A/W = (\text{blower scfm} \times 7.48) / \text{water flow in gpm}$$

The following table and curves provide a method for approximating removal percentages. Exact performance on specific streams can be determined through on site pilot testing. Pilot plants are available from AEROMIX.

Contact AEROMIX toll free at 1-800-879-3677 for assistance in configuring BREEZE systems and estimating performance.

<u>Contaminant</u>	<u>To Estimate Performance</u>
Benzene	Use Benzene curve
BTEX	Use Benzene curve
Carbon Tetrachloride	Use PCE curve
Chlorobenzene	Use the Benzene curve
Hydrogen Sulfide	Use the TCE curve
Methylene Chloride	Use an average of the MTBE Benzene curves
MTBE	Use MTBE curve
Perchloroethylene (PCE) (Tetrachloroethylene)	Use PCE curve
Toluene	Use Toluene curve
Trichloroethylene (TCE)	Use TCE curve
Vinyl Chloride	Use Radon curve
Xylene	Use Xylene curve
1,2-Dichloroethane	Use MTBE curve
1,2-Dichlorobenzene	Use MTBE curve
1,1,1-Trichloroethane (TCA)	Use TCE curve



VOC REMOVAL QUESTIONNAIRE

AEROMIX SYSTEMS, INCORPORATED has an experienced Applications Engineering Department to assist in sizing and configuring aeration stripping tanks at no charge to your company. We urge you to take advantage of this service by filling out this questionnaire and returning it to us. Call us toll free at 1-800-879-3677 with any questions.

Is data actual or assumed? _____

Contaminated water flow (gpm): _____

Water Temp.: _____ (C or F) Ambient Temp.: _____ (C or F)

Elevation: _____

Source of contaminated water: _____

Purified water will be used for: _____

Available Power
Voltage: _____ Phase: _____ Hertz: _____

Contaminates and concentrations: be sure to indicate concentrations in ppm or ppb and state which is being used.

<u>Contaminate</u>	<u>Feed Concentration (ppm or ppb)</u>	<u>Discharge Water Conc. Requirement (ppm or ppb)</u>
_____	_____	_____
_____	_____	_____
_____	_____	_____
_____	_____	_____
_____	_____	_____

* Attach chemical analysis if one exists.

Do you expect or require carbon polishing on discharge water: _____

Do you expect or require carbon polishing or other treatment on vent gas: _____

Attach sketch showing where aeration tank will be located. Use the back of this sheet if necessary.

TRICHLOROETHYLENE (TCE)

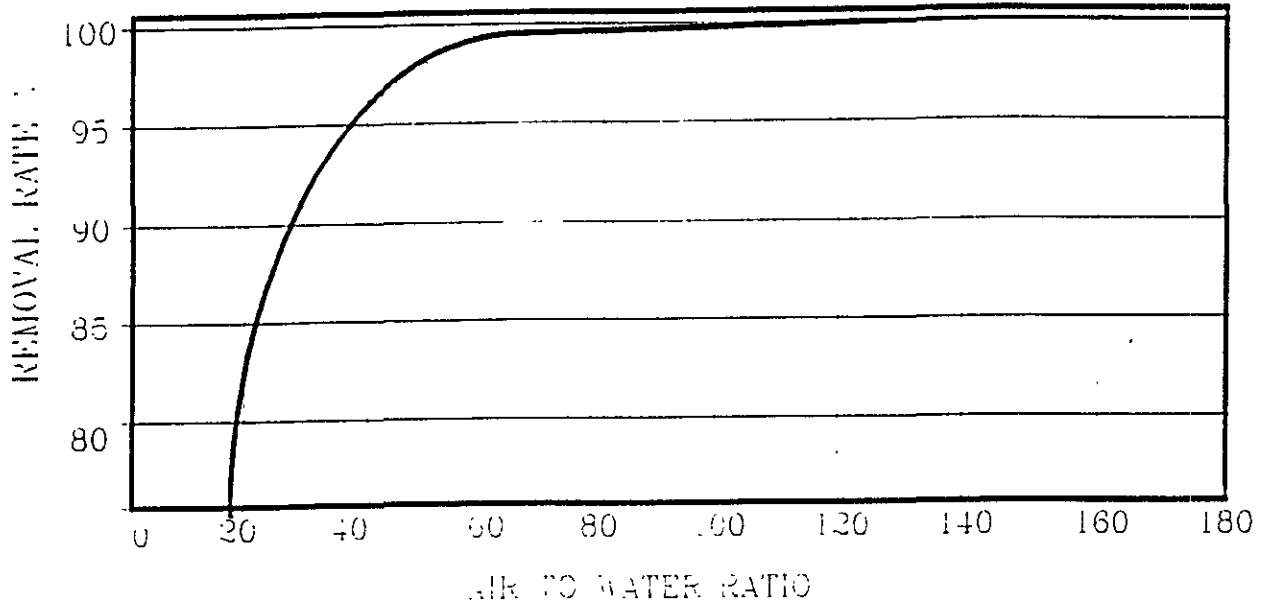

MIBE

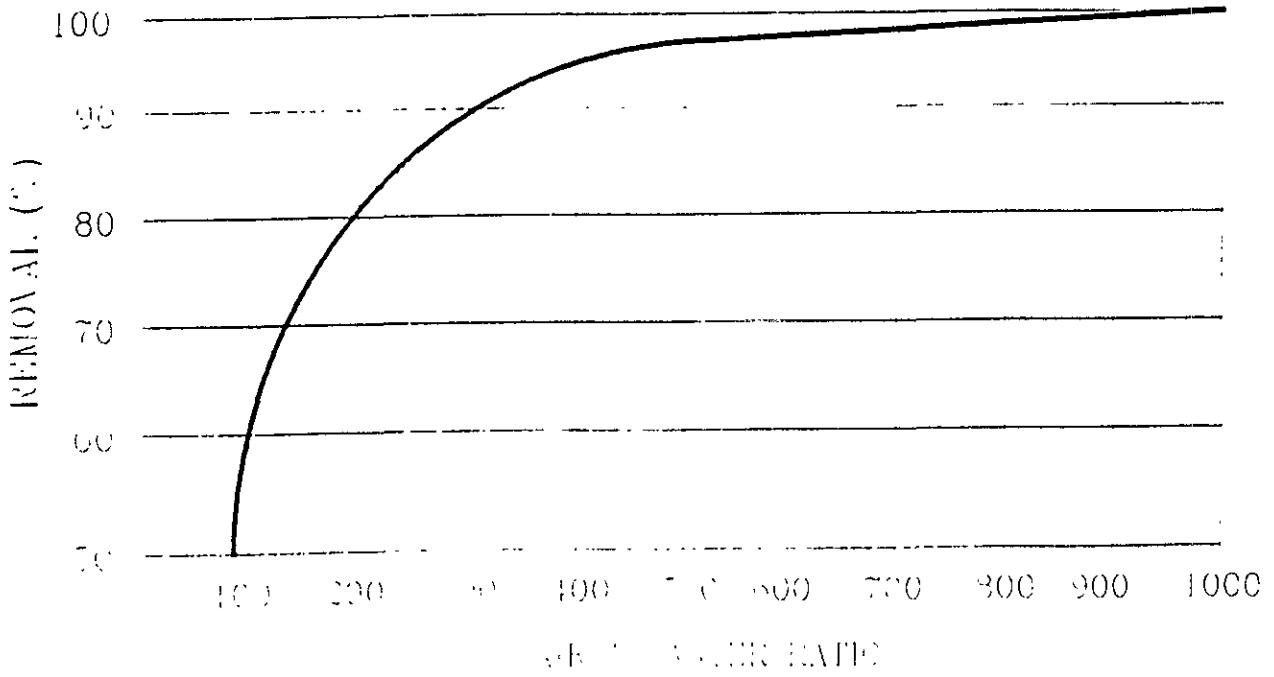

BENZENE

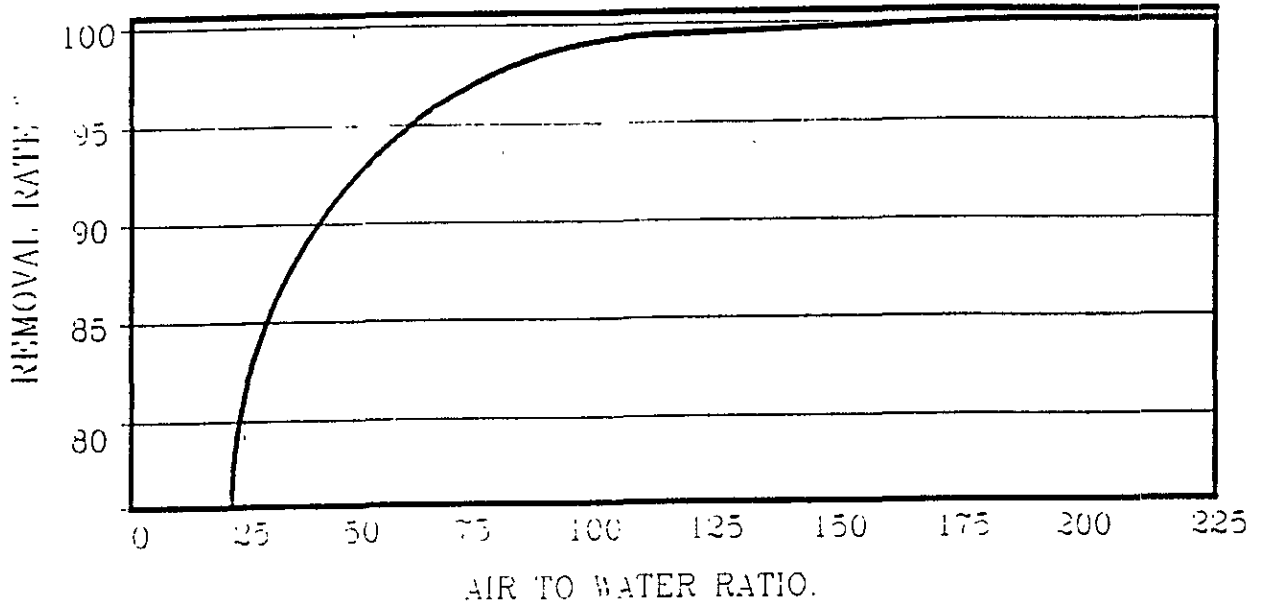

PCE

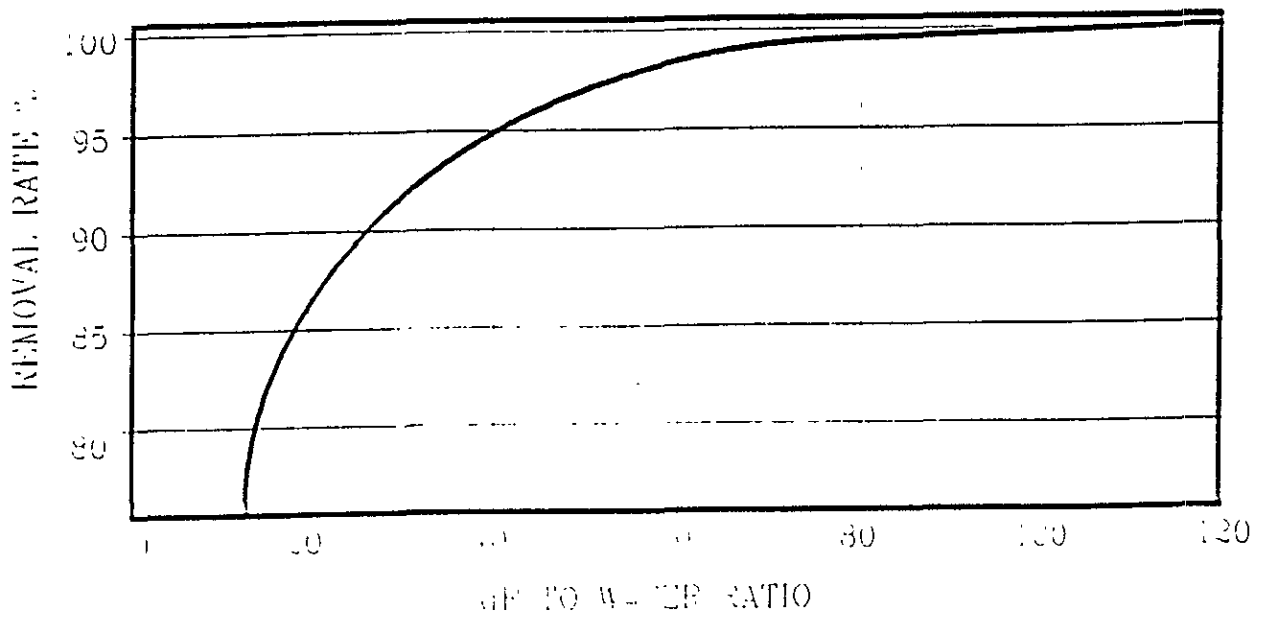

TOLUENE

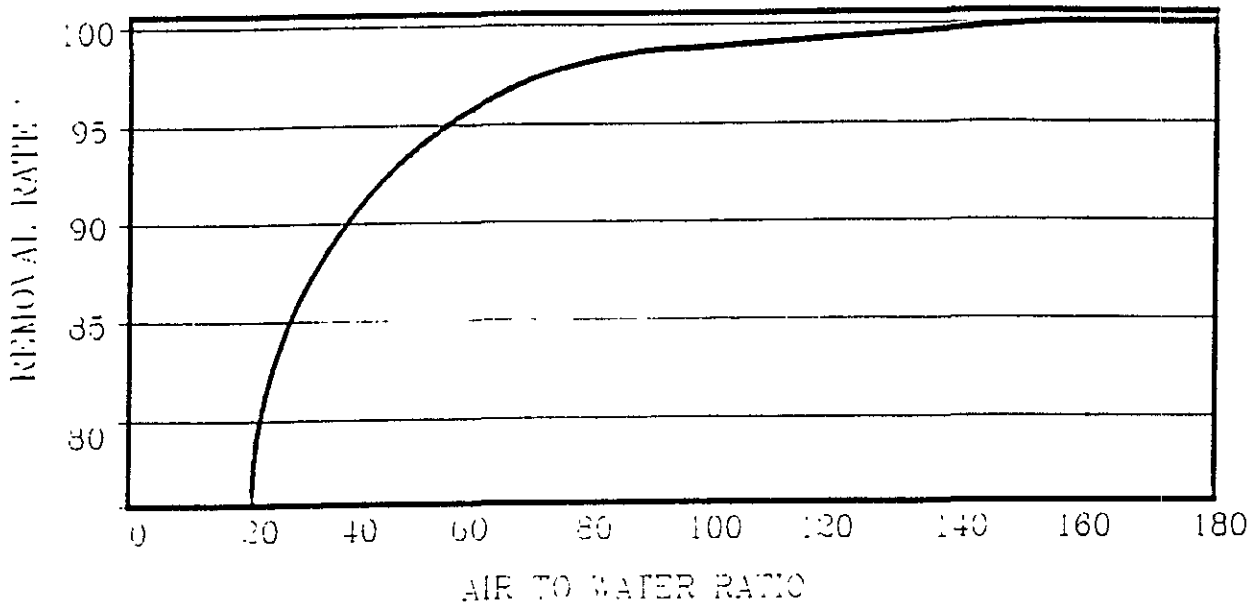

XYLENE

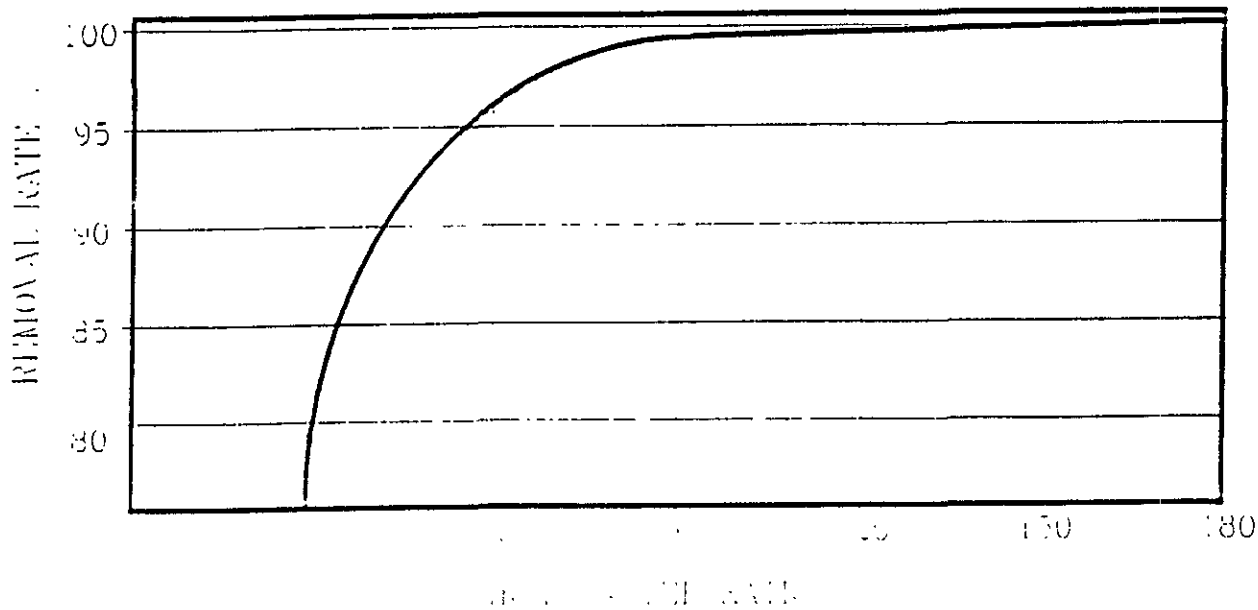



"Specialists in Aeration and Mixing Equipment"

BREEZE™ Competitive Comparison

The BREEZE is a compact self-contained aeration tank for removal and clean-up of VOC (volatile organic compounds). This is an application where packed stripping towers have been commonly applied. The following steps through the substantial advantages of the BREEZE over packed towers.

<u>BREEZE</u>	<u>Packed Towers</u>
A. Compact size - typically less than 4' tall.	A. Requires tall tower and must either be mounted outdoors or in a high headroom area. Can have height restrictions in urban areas.
B. High removal rates.	B. Requires significant tower height to achieve high containment removals.
C. Low cost.	C. Complex construction and large size mean high capital and installation costs.
D. Low maintenance and non-fouling due to use of CYCLONE stainless steel diffusers. Diffusers can be easily replaced is ever needed at low cost.	D. Packing can become clogged with dissolved minerals in water. This requires packing replacement or messy acid clean-up.
E. Small size makes BREEZE easily accessible. Includes removable top for easy access.	E. Tower can not be easily accessed due to height.
F. Can easily be mounted indoors and out of sight. More publicly acceptable.	F. Size of equipment limits where it can be mounted. Site generally looks under construction.
G. Well suited for small flows (less than 500 gpm).	G. Equipment size remains large even at low flows.
H. Portable light weight design allows BREEZE to be easily relocated.	H. Requires disassembly for transport. Tower height can make transportation difficult.
I. Can be easily vented to carbon or catalytic converter.	I. Typically more plumbing is needed.

Quality Certified

VOCarb™

Air Purification Carbon

DESCRIPTION

Westates' VOCarb™ activated carbon is the premier activated carbon for air purification applications. VOCarb activated carbon's high retentivity results in VOC adsorption capacities as much as 40% greater than coal based activated carbons. This high retentivity combined with exceptional hardness makes VOCarb activated carbon the best choice for most vapor phase adsorption applications.

QUALITY CERTIFIED

The manufacturing process for activated carbons is a procedure with many variables that require strict quality control. Westates maintains a modern ASTM quality control laboratory to certify that Westates products meet or exceed the required specifications.

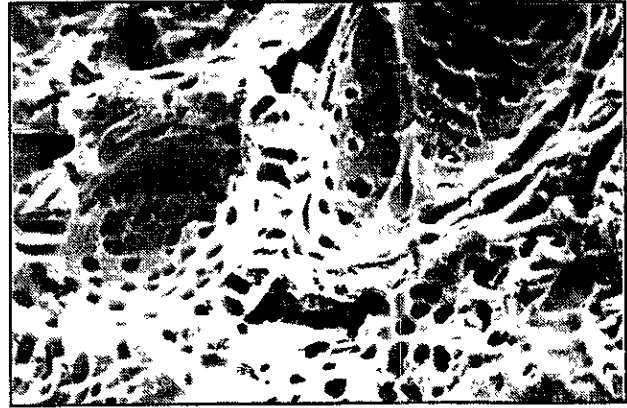

Westates VOCarb at 2.2 Kx mag.

PRESSURE DROP

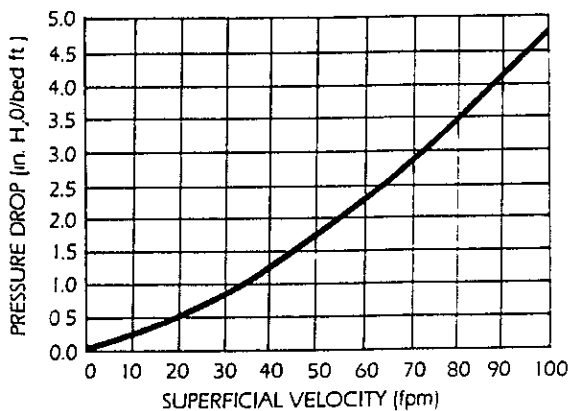

SAFETY

Under certain conditions, some chemical compounds may oxidize, decompose, or polymerize in the presence of activated carbon. This could result in temperature increases sufficient to cause ignition. As a result, particular care must be taken with compounds having peroxide-forming tendencies.

WESTATES CAPABILITIES

Westates manufactures, regenerates and tests activated carbon in our own facilities, in addition to selecting carbon from other sources. The company has more than 20 years experience in the design of activated carbon adsorption systems. Our technical staff provides expert guidance in selecting the appropriate system for your needs. Our in-house laboratory is fully equipped to provide complete quality control and a continuing analysis of your carbon to maintain maximum adsorption efficiency.

SPECIFICATIONS

Size (U.S. Sieve)	4 x 8
Type	Coconut Shell
CTC - Typical	65%
Retentivity - Typical	39%
Pore Volume - Typical	55 cc/gm
Surface Area (B.E.T) Min	1250 m ² /g
Ash Max	2%
Hardness Min	97%
Abrasion Min	98%
Moisture Max	2%
Mean Particle Diameter	3.4mm
Apparent Density - Typical	48 gm/cc 29 lb/ft ³

APPLICATIONS

- VOC Adsorption Tanks
- Industrial Air Cleaners
- HVAC Adsorption Filters
- Odor Control Systems
- Clean Room Air Purifiers
- VOC Vapor Capture Systems

All information presented here is believed to be reliable and in accordance with accepted engineering practice. However, Westates makes no warranties as to the completeness of the information. Users should evaluate the suitability of each product to their own particular application. In no case will Westates be liable for any special, indirect, or consequential damages arising from the sale, resale, or misuse of its products.



WESTATES CARBON, INC.
2130 Leo Ave., Los Angeles, CA 90040
PHONE: (213) 722-7500
FAX: (213) 722-8207 TWX 910-321-2355

Quality Certified

AQUA-Carb™

Water Treatment Carbons

DESCRIPTION

Westates' AQUA-CARB™ activated carbons are high performance adsorbents specifically designed for water treatment. Manufactured from unique high quality substrates, AQUA-CARB activated carbons feature internal pore structures that are ideally suited to remove organic compounds from water. High removal efficiency coupled with their very low water soluble ash content make AQUA-CARB activated carbons the best value for your water treatment needs.

QUALITY CERTIFIED

The process for manufacturing activated carbons involves procedures with many variables that require strict quality control. Westates maintains a modern ASTM quality control laboratory to certify that Westates products meet or exceed all required specifications.

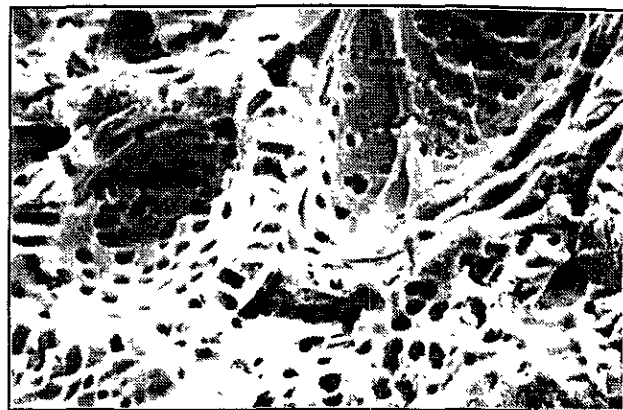

Coconut Shell at 2.2kx mag

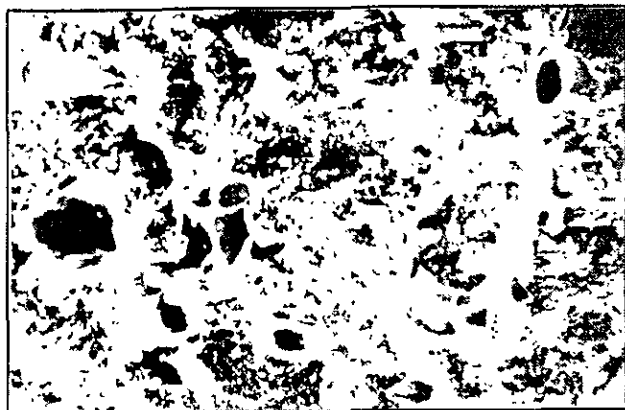

Bituminous Coal at 250x mag.

SAFETY

Wet activated carbon readily adsorbs atmospheric oxygen. Dangerously low oxygen levels may exist in closed vessels or poorly ventilated storage areas. Workers should follow all applicable state and federal safety guidelines for entering oxygen depleted areas.

WESTATES CAPABILITIES

Westates has the facilities for manufacturing, regenerating and characterizing activated carbon. Selected high quality carbons are also available from other sources giving Westates the capability of supplying the best carbon for your treatment needs. We have more than 20 years experience in the design of activated carbon adsorption systems. Our technical staff provides expert guidance in selecting the right system for your needs. Our laboratory is fully equipped to provide complete quality control and a continuing analysis of your carbon to maintain maximum efficiency.

All information presented here is believed to be reliable and in accordance with accepted engineering practice. However, Westates makes no warranties as to the completeness of the information. Users should evaluate the suitability of each product to their own particular application. In no case will Westates be liable for any special, indirect, or consequential damages arising from the sale, resale, or misuse of its products.

SPECIFICATIONS	CO-401	KP-401	CC-601	CC-401
Size (U.S. Sieve)	8 x 30	-	12 x 40	12 x 30
Iodine No. (Min)	900	850	1100	900
Hardness No. (Min)	97	92	99	99
Abrasion No. (Min)	76	76	99	99
Moisture (Max)	2%	2%	2%	2%
Mean Particle Diam.	1.45mm	1.9mm	1.1mm	1.2mm
Shape	Granule	Pellet	Granule	Granule
Ph Water Extract	7.5	7.5	9.5	9.5
Soluble Phosphate	N.D.*	N.D.	N.D.	N.D.
Ash (Water Soluble)	< 1%	1%	1%	1%
Apparent Density (g/cc)	49		49	52
(lb/ft ³)	30.5	30.5	30.5	32

(Refer to selection guide on reverse)



**ACTIVATED
CARBON
SYSTEMS**

WESTATES CARBON, INC.
2130 Leo Ave., Los Angeles, CA 90040
PHONE: (213) 722-7500
FAX: (213) 722-8207 TWX: 910-321-2355

SUN-AG INC.

ENVIRONMENTAL PRODUCTS & SERVICES

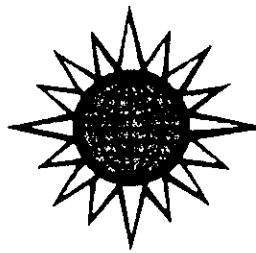

SUN-AG

105 AVENIDA DE LA ESTRELLA
SUITE 3
SAN CLEMENTE, CALIF. 92672
(714) 498-4834
FAX # (714) 498-3847
TELEX # 681338

Activated Carbon Adsorption Vessel

Model SA1000-V

Vapor Phase

- * Mild-steel construction
- * 1000 pounds total activated carbon capacity
- * Standard 2-part epoxy internal coating
- * Optional fused epoxy internal coating
- * Standard 6" flanged inlet/outlet
- * Skid mounted for simplified maneuverability
- * PVC manifold system - high efficiency
- * Low pressure drop/high flow
- * Fully serviceable for on-site change out and replacement of adsorption media.

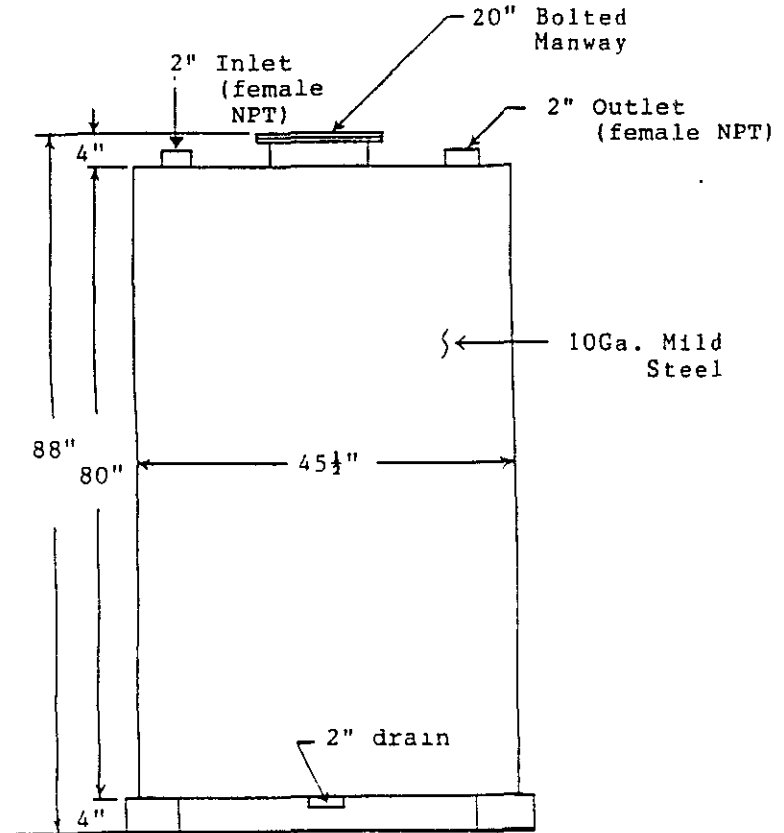

Typical Applications:

- * Vapor extraction systems
- * Tank venting
- * VOC control
- * Post air stripper

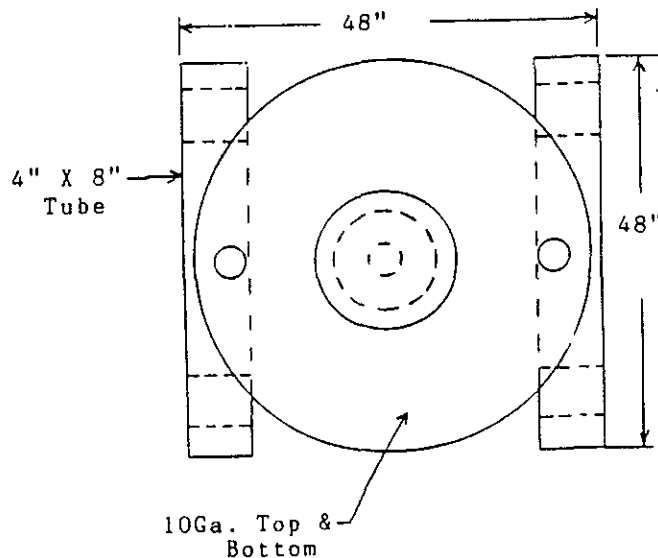

SA190L Water Sorb 55 Gallon Sized Water Phase Carbon Unit

SA190L SUN-AG, Inc.'s Water Sorb, liquid purification system is a prefabricated activated carbon filtration system that makes use of the adsorptive properties of activated carbon to eliminate liquid pollution problems, caused by chemical contaminants.

The Water Sorb is designed to provide an efficient, economical way to control contaminant levels in process streams, waste water systems, and other liquid pollution situations.

Water Sorb internals consist of a proprietary PVC underdrain engineered to ensure even flow distribution and complete carbon bed use. A few of the use for Water Sorb are listed below:

- | | |
|----------------------|-----------------------|
| Waste water | Solvent recirculation |
| Laboratory wastes | Process streams |
| Wet Scrubber liquids | Toxic spills |

The Water Sorb is supplied ready for immediate use. It is easily connected to an existing system using the 2" NPT couplers, that are supplied on the inlet and outlet.

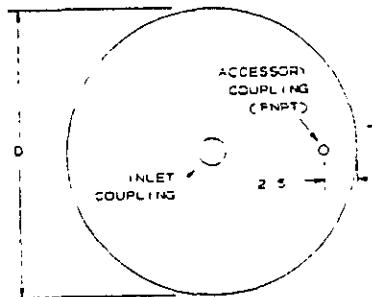

SPECIFICATIONS

Height	36"
Diameter	24"
Max Flow (gpm)	5
Max Pressure psi	12
Max Temp °F	125
Carbon Capacity	
Weight (Lbs)	190
Volume (ft³)	6.5
Shipping Weight (Lbs)	250

Pressure Drop SA190L Water Sorb

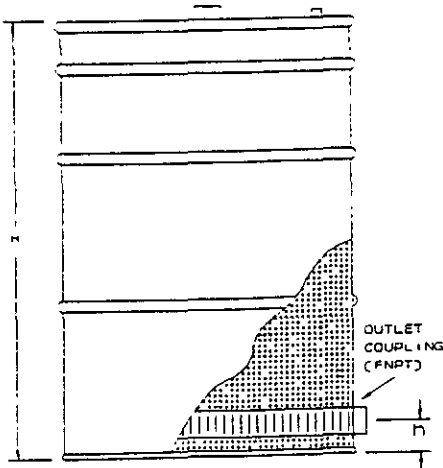
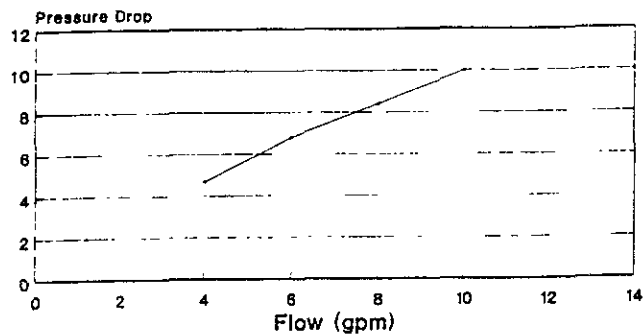

SUN-AG INC.

ENVIRONMENTAL PRODUCTS & SERVICES

105 S Ave de la Estrella, Ste. 3, San Clemente, California 92672
(800) 468-4671 • FAX (714) 498-3847



SA4X8CCV Vapor Phase Activated Carbon 4X8 Mesh Virgin Coconut Shell Based

Description SUN-AG's virgin coconut shell based vapor carbon is made from selected coconut shell to insure positive quality control during the manufacturing process. Virgin raw material is activated thermally in a rotary kiln steam atmosphere. By maintaining these quality control standards, the customer is able to anticipate high adsorption of molecular impurities.

These activated carbon granules are an adsorbent with well developed pore structure allowing a wide range of retention. The high hardness number allows for minimal granular breakage and the kindling point of this carbon is unusually high. This carbon is particularly well suited for removal of organic contaminants and precious metals recovery.

PHYSICAL PROPERTIES

Carbon tetrachloride Activity	62% Minimum
Apparent Density	0.44-0.49 g/m ³
Hardness	97 Typically
Moisture	5% Maximum
Ash Content	3% Maximum
Surface Area	1100 - 1250 m ² /gr
Pore Volume	0.50 ml/gr

This information has been gathered from standard reference materials and/or test data, that is believed to be accurate and reliable. Nothing herein shall be deemed to be a warranty or representation, expressed or implied, with respect to the use of the goods described for any particular purpose alone or in combination with other goods and/or processes, or that their use does not conflict with existing patent rights. No license is granted to practice any patented invention. It is offered for your consideration, investigation, and verification.

SUN-AG INC.

ENVIRONMENTAL PRODUCTS & SERVICES

105 S. Ave de la Estrella, Ste. 3, San Clemente, California 92672
(800) 468-4671 • FAX (714) 498-3847

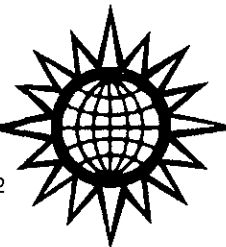

SA-PPP Vapor Phase Activated Carbon Impregnated Granular Activated Carbon

Description SA-PPP is a high activity, specially treated granular activated carbon designed for use in vapor phase odor control. Applications for SA-PPP carbon include the removal of hydrogen sulfide, methyl mercaptans, general acid gases, and other odors typical in the treatment of sewage wastes, pulp and mills, and chemical plants.

PHYSICAL PROPERTIES

Apparent Density	32 Maximum
Hardness Number	95 Minimum
Moisture	10% Maximum
Time to 0.1 ppm H ₂ S	851 hours
Mesh sizes available	4X6; 4X10
H ₂ S Adsorption, minimum	23% (.14g/cc)

This information has been gathered from standard reference materials and/or test data, that is believed to be accurate and reliable. Nothing herein shall be deemed to be a warranty or representation, expressed or implied, with respect to the use of the goods described for any particular purpose alone or in combination with other goods and/or processes, or that their use does not conflict with existing patent rights. No license is granted to practice any patented invention. It is offered for your consideration, investigation, and verification.

SUN-AG INC.

ENVIRONMENTAL PRODUCTS & SERVICES

105 S. Ave de la Estrella Ste 3, San Clemente California 92672
(800) 468-4671 • FAX (714) 498-3847

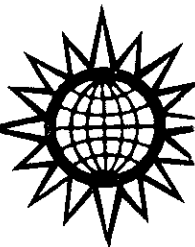

SA-CCPPP

Impregnated Coconut Shell Based Activated Carbon

Description SA-CCPPP is a high activity, specially treated granular activated carbon designed for use in vapor phase odor control. Applications for SA-CCPPP carbon include the removal of hydrogen sulfide, methyl mercaptans, general acid gases, and other odors typical in the treatment of sewage wastes, pulp and paper mills, and chemical plants.

PHYSICAL PROPERTIES

Apparent Density	0.55 g/cc, ASTM D-2854
Hardness	95%, ASTM D-3802
Moisture, max	15%
Mean particle diameter, min	3.6 mm, ASTM D-2862
Uniformity coefficient, max	1.9, ASTM AWWA-B-604-74
Maximum head loss at 50 FPM velocity	1.2" w.c/ft bed depth
H ₂ S minimum breakthrough capacity *	0.14 g H ₂ S/cc carbon

* H₂S breakthrough capacity is determined by passing a moist air stream (85% R.H.) containing 1% H₂S at a rate of 1,450 cc/min. through a 1.0" diameter X 9" deep bed of uniformly packed activated carbon and monitored to 50 ppm breakthrough. Results are reported as grams H₂S removed per cc of carbon.

This information has been gathered from standard reference materials and/or test data, that is believed to be accurate and reliable. Nothing herein shall be deemed to be a warranty or representation, expressed or implied, with respect to the use of the goods described for any particular purpose alone or in combination with other goods and/or processes, or that their use does not conflict with existing patent rights. No license is granted to practice any patented invention. It is offered for your consideration, investigation, and verification.

SUN-AG INC.

ENVIRONMENTAL PRODUCTS & SERVICES

105 S. Ave de la Estrella, Ste 3, San Clemente California 92672
(800) 468-4671 • FAX (714) 498-3847

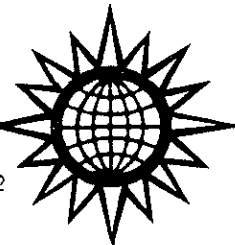

ATTACHMENT B
WATER BALANCE CALCULATIONS

WATER BALANCE CALCULATIONS

Design Criteria

Average pumping flowrate	=	0.24 gallons per minute (gpm)
Avg. Influent TPHg Concentration	=	6,500 $\mu\text{g/l}$ (based on cumulative results of laboratory analyses of water samples (July 1989 to present Table 1)
Avg. Influent Benzene Concentration	=	729 $\mu\text{g/l}$ (micrograms per liter/parts per billion [ppb])
Avg. Infl. Toluene Concentration	=	373 $\mu\text{g/l}$
Avg. Infl. Ethyl benzene Conc.	=	68.9 $\mu\text{g/l}$
Avg. Infl. Total Xylenes Conc.	=	422 $\mu\text{g/l}$
Avg. Influent TPHd Concentration	=	100 $\mu\text{g/l}$
Aeration flow rate	=	10 cubic feet per minute (cfm, based on manufacturer's specifications, Attachment A)
Liquid-Phase Carbon	=	Two, 200-lb activated liquid-phase carbon canisters

Assumptions

- 1) Based on manufacturer's specifications on aeration tanks (Attachment A), achievable aeration efficiencies are greater than 95% for all constituents listed above with the exception of TPHd.
- 2) Based on manufacturer's specifications, liquid-phase carbon has an adsorption capacity of:
$$5 \text{ pounds (lbs) TPHg/100 lbs carbon} = 10 \text{ lbs TPHg/200-lb carbon canister}$$
- 3) The carbon adsorption system together has an efficiency of greater than 99%.
- 4) Breakthrough is said to have occurred when the first reported detectable levels of hydrocarbons are discharged to the sewer.

Sewer Discharge Requirements

The treatment system must be designed to meet the sewer discharge requirements. Preliminary discharge requirements for treated groundwater have been established by EBMUD to be:

<u>Pollutant</u>	<u>Limit</u>
TPH	50 ppb
Lead	2 ppm
Benzene	5 ppb
Toluene	15 ppb
Ethylbenzene	5 ppb
Total xylenes	14 ppb

Calculations for TPHg and Carbon Usage

The average amount of TPHg in pounds per gallon, before aeration or activated carbon treatment, is calculated below:

$$\frac{5,600 \mu\text{grams TPHg}}{1 \ell \text{ H}_2\text{O}} \frac{1 \text{ gram}}{\text{gallon}} = \frac{4.7 \times 10^{-5} \text{ lbs TPHg}}{1 \text{ gallon H}_2\text{O}}$$

The amount of TPHg in pounds per day, before aeration or activated carbon treatment is calculated below:

$$\frac{4.7 \times 10^{-5} \text{ lbs TPH}}{1 \text{ gallon H}_2\text{O}} \frac{0.24 \text{ gallons}}{\text{One minute}} \frac{1440 \text{ minutes}}{\text{One day}} = \frac{0.016 \text{ lbs TPH}}{\text{One day}}$$

The amount of TPHg remaining in the water after aeration is calculated as follows:

$$\frac{0.016 \text{ lbs TPHg}}{\text{One day}} (1 - 0.95) = \frac{8.1 \times 10^{-4} \text{ lb TPH}}{\text{One day}}$$

Carbon breakthrough rate is calculated as follows:

$$\frac{5 \text{ lb TPHg}}{100 \text{ lbs Carbon}} \frac{200 \text{ lb Carbon}}{\text{One Canister}} \frac{1 \text{ day}}{8.1 \times 10^{-4} \text{ lb TPHg}} = \frac{12395 \text{ days}}{\text{One Canister}}$$

Thus at the design criteria detailed above, liquid-phase carbon changeout will be at a minimum greater than one year.

Based on an aeration tank efficiency of 95%, and a 99% efficiency for carbon, effluent dissolved concentrations of contaminants discharged to the City sewer will be:

<u>Pollutant</u>	<u>Limit</u>
TPHg	$5,600 \times (1 - 0.95) \times (1 - 0.99) = 2.8 \text{ ppb}$
Benzene	0.36 ppb
Toluene	0.18 ppb
Ethylbenzene	0.034 ppb
Total xylenes	0.21 ppb
TPHd	$100 \times (1 - 0.99) = 1.0 \text{ ppb}$

These effluent concentrations are below EBMUD sewer discharge limits. Influent concentrations of purgeable halocarbons, and TOG are either all nondetectable and/or below EBMUD discharge limits (Table 1).

No vapor extraction test has been performed due to the shallow groundwater table at the site. Hence, an evaluation of the vapor phase carbon breakthrough rate is not presented at this time but will be made after start-up of operation of the groundwater remediation system, and the VES.