

A Report Prepared for

California Regional Water Quality Control Board  
San Francisco Bay Region  
1111 Jackson Street, Room 6000  
Oakland, California 94607

**REPORT OF SYSTEM MONITORING  
JUNE 1989  
SOIL TREATMENT SYSTEM  
PACIFIC RENAISSANCE PLAZA  
OAKLAND, CALIFORNIA**

HLA Job No. 9382,040.02

Submitted on behalf of:

City of Oakland Redevelopment Agency  
1417 Clay Street  
Oakland, California 94612

by



John D. Skalbeck  
John D. Skalbeck  
Project Hydrogeologist



David F. Leland  
David F. Leland  
Associate Hydrologist

Harding Lawson Associates  
7655 Redwood Boulevard  
P.O. Box 578  
Novato, California 94948  
415/892-0821

August 2, 1989

TABLE OF CONTENTS

---

LIST OF TABLES.....	iii
LIST OF ILLUSTRATIONS .....	iv
1.0    INTRODUCTION.....	1
2.0    BACKGROUND.....	2
2.1    Previous Reports.....	2
2.2    Objective of the Treatment System .....	2
2.3    Treatment System Description.....	3
3.0    TREATMENT SYSTEM OPERATIONS .....	5
4.0    TREATMENT SYSTEM MONITORING .....	6
4.1    Flow and Water-Level Monitoring.....	6
4.2    Sample Collection and Analysis.....	6
4.3    Numerical Modeling of Ground-Water Flow.....	8
5.0    RESULTS .....	9
5.1    Hydraulic Analysis .....	9
5.2    Distribution of Inorganic Constituents and Microbial Populations in Ground Water .....	10
5.3    Distribution of Petroleum Hydrocarbons in Ground Water..	11
6.0    ACTIVITIES PLANNED: JULY 1989.....	12
7.0    REFERENCES.....	13

TABLES

ILLUSTRATIONS

APPENDIX

    A    LABORATORY ANALYTICAL RESULTS FOR WATER SAMPLES

DISTRIBUTION

LIST OF TABLES

---

Table 1	Schedule for Sampling, Measurement, and Analysis
Table 2	Injection Well Flow Rates - June 1989
Table 3	Extraction Well Flow Rates - June 1989
Table 4	Water-Level Elevations
Table 5	Results of Inorganic Chemical and Microbial Analyses of Ground-Water Samples from System Wells
Table 6	Results of Inorganic Chemical and Microbial Analyses of Ground-Water Monitoring Well Samples
Table 7	Results of Organic Chemical Analyses of Ground-Water Monitoring Well Samples

LIST OF ILLUSTRATIONS

---

- Plate 1      Site Plan and Treatment System Well Locations
- Plate 2      Schematic Diagram
- Plate 3      Observed and Simulated Ground-Water Elevations - June 5, 1989
- Plate 4      Observed and Simulated Ground-Water Elevations - July 5, 1989
- Plate 5      Concentrations of Nitrate in Ground Water - July 6, 1989
- Plate 6      Concentrations of Phosphate in Ground Water - July 6, 1989
- Plate 7      Concentrations of Petroleum Hydrocarbons in Ground Water - July 5-7, 1989

## 1.0 INTRODUCTION

This report presents and discusses the operation and monitoring data for the in situ soil treatment system at the Pacific Renaissance Plaza (PRP) site in Oakland, California, from June 5 to July 6, 1989. The PRP site is bounded by 9th, Franklin, and Webster streets and the East Bay Municipal Utilities District (EBMUD) property line approximately 100 feet north of the centerline of 10th Street (Plate 1). The site is part of the Oakland Chinatown Redevelopment Project Area. The soil treatment system is designed to remove petroleum hydrocarbons from soil within site boundaries before it is excavated during construction of the Pacific Renaissance Plaza complex. Construction is scheduled to begin in September 1989.

This report was prepared by Harding Lawson Associates (HLA) on behalf of the City of Oakland Redevelopment Agency (Agency). It is submitted in accordance with monitoring and reporting requirements originally set forth by the California Regional Water Quality Control Board, San Francisco Bay Region (RWQCB), in a letter to the City of Oakland dated February 22, 1989, and amended by a letter dated March 17, 1989, from HLA to the RWQCB, that clarified several items, including reporting periods and report submittal dates.

## 2.0 BACKGROUND

### 2.1 Previous Reports

Site history and characterization activities completed by HLA in 1988 are reported in *Site Characterization, Pacific Renaissance Plaza, Chinatown Redevelopment Project Area, Oakland, California (HLA, 1988)*. The site characterization report also presents a preliminary screening of soil treatment alternatives and an evaluation of the potential for biodegradation to effectively remove hydrocarbons from soil at the site. The *Report of Waste Discharge, Pacific Renaissance Plaza, Chinatown Redevelopment Project Area, Oakland, California (HLA, 1989a)* discusses soil treatment system design and presents the results of the biodegradation treatability study and the proposed operations and monitoring plan for the system. Site background, environmental setting, and previous investigations are also discussed in the report.

Characterization of the extent of soil contamination at the PRP site was updated in the *Report of System Monitoring: March 1989, Soil Treatment System, Pacific Renaissance Plaza, Oakland, California (HLA, 1989b)* using results of analysis of soil samples collected during system well installation activities. The operation and monitoring of the system in March, April, and May are described in *HLA (1989b)*, *HLA (1989c)*, *HLA (1989d)*.

### 2.2 Objective of the Treatment System

A portion of the soil at the PRP site contains elevated levels of petroleum hydrocarbons (identified as gasoline) and benzene, toluene, ethylbenzene and xylenes (BTEX). Guidance used by the RWQCB classifies soil with total petroleum hydrocarbon (TPH) values exceeding 1,000 parts per million (ppm) as hazardous waste (*Leaking Underground Fuel Tank Task Force, 1987*) and soil with TPH values between 100 and 1,000 ppm as designated waste. There is soil at this site which falls into both categories

and would require landfill disposal at Class I (hazardous waste), Class II (designated waste), or Class III facilities (less than 100 ppm TPH).

The Agency wishes to treat soils in place prior to excavation to reduce concentrations to levels acceptable for Class III disposal. In situ biological treatment using a system of injection and extraction wells was the treatment method selected to accomplish this objective.

### 2.3 Treatment System Description

The soil treatment process involves circulating nutrient- and oxygen-enriched water through the contaminated soil to enhance the growth of microorganisms existing in soils at the site. These microorganisms utilize hydrocarbons as an energy source, producing carbon dioxide and water as by-products. This process reduces the concentration of petroleum hydrocarbons in the subsurface.

The treatment system, shown schematically on Plate 2, consists of:

- o A 3,000-gallon mixing tank and appurtenances for addition of nutrients and hydrogen peroxide to water to stimulate indigenous microorganisms capable of degrading petroleum hydrocarbons.
- o Eleven injection wells, to introduce the nutrient-enriched and oxygenated water to the contaminated zone, and 22 extraction wells, to hydraulically contain and collect ground water after it passes through the contaminated zone.
- o Associated piping and controls.
- o The existing carbon treatment system, which is used to treat extracted ground water to reduce petroleum hydrocarbons and other organic compounds to discharge limits specified in the Agency's existing NPDES permit number CA 0029394.

The system can operate in two basic modes. In the start-up operational mode, which began on March 4, 1989, the PRP biotreatment system operates in an "open loop". The source of freshwater to the system in start-up mode is an EBMUD fire hydrant located at 10th and Webster streets. The water supply is piped through a backflow

preventer and a water meter to the mixing tank. Separate solutions of nutrients (nitrate, ammonia, and phosphates) and hydrogen peroxide are injected in measured quantities into the water as it enters a mixing tank. The nutrients and hydrogen peroxide are stored in separate 300-gallon tanks adjacent to the mixing tank, and are injected into the influent water stream as necessary to achieve target concentrations in injection water.

A pump delivers the water, nutrients, and hydrogen-peroxide solution from the mixing tank to the injection wells for introduction to the subsurface. A solenoid valve at each wellhead is controlled by liquid level probes in the well and regulates the flow of water into the well. The flow within the well itself is by gravity; once water is inside the well casing, it is no longer under pressure from the pump.

Injected water travels from the injection wells to the extraction wells through the soil. Submersible pumps in the extraction wells surrounding the injection wells on the site are also controlled by liquid level probes. All extracted water is collected and then pumped to the first of five 21,000-gallon storage tanks (Baker tanks) at the site, filtered to remove fine sediments, and treated by carbon adsorption to reduce hydrocarbon concentrations to NPDES permit limits. Treated extraction water is either discharged to the storm drain ("open loop" mode) or pumped to the nutrient mixing tank to be used for reinjection.

The long-term system operation mode returns water treated by the carbon adsorption system to the mixing/injection system. Recycling ground water in this manner enhances the potential for growth of microbial populations and reduces the quantity of potable water required for operation. Operation in this "closed loop" mode began during the latter part of April 1989.



### 3.0 TREATMENT SYSTEM OPERATIONS

System operational activities and adjustments made in June are summarized

below:

- o Extraction Wells EW-1 through EW-12 and EW-20 were reconditioned by pulling the pumps from the wells and running them in a chlorine/soap bath. Flowmeters for each well were also cleaned. The pump intakes were lowered 1 foot in Wells EW-2 through EW-10.
- o Injection Wells IW-5, IW-10, and IW-11 were redeveloped to increase flow.
- o Baker tanks were treated with chlorine and hydrogen peroxide to reduce accumulated biomass.
- o Two infiltration basins, designated BA-1 and BA-3, were constructed and filled at the east end of the system, as shown on Plate 1. Hydrant water was used to fill the basins, and nutrients are added manually.

#### 4.0 TREATMENT SYSTEM MONITORING

##### 4.1 Flow and Water-Level Monitoring

Each extraction well (EW series) and injection well (IW series) except EW-22 is equipped with a Neptune totalizing flowmeter to monitor water volume extracted or injected. Meter accuracy is reported by the manufacturer to be within plus/minus 1-1/2 percent down to flows of 1/4 gallon per minute (gpm). Totalizing meter readings in gallons, along with time in minutes, are recorded daily by an HLA engineering technician on a Daily Maintenance Data Sheet (DMDS). The previous totalizer reading, the elapsed time between readings, and the calculated daily average flow rate (gpm) for each well are also recorded on the DMDS.

Depths to water are measured daily at Monitoring Wells MW-15, MW-16, and MW-17 and weekly at the other monitoring wells on site and in the vicinity of the site (Plate 1). Depth to water is measured using a graduated steel tape and repeated until two measurements with a difference of no more than 0.02 feet are obtained. Water-level elevations are calculated using depth-to-water data and surveyed top-of-casing elevations.

##### 4.2 Sample Collection and Analysis

Water samples are collected from selected extraction wells, injection wells, and monitoring wells and analyzed for inorganic and organic constituents and microbial populations. For each well, the frequency of sampling during the reporting period, analytical parameters, and EPA Test Methods (for organic constituents) are presented in Table 1. Samples are collected from extraction wells using the sampling port at each wellhead. Representative samples of the water distributed to the injection wells are collected from the nutrient and hydrogen peroxide mixing tank on a weekly basis.

The sampling schedule may be modified in subsequent months in response to the operation of the system and the need for monitoring data.

#### 4.3 Numerical Modeling of Ground-Water Flow

A numerical model of ground-water flow at the site, developed during the design phase of the project, is described in the *Report of Waste Discharge (HLA, 1989a)*. The model is based on the USGS ground-water flow computer code MODFLOW (McDonald and Harbaugh, 1984). The set of input parameters for results reported in the *Report of Waste Discharge* assumed a single value of -1 foot MSL for the elevation of the bottom of the A-aquifer. Data collected during well installation activities indicate local variations in the elevation of the bottom of the A-aquifer from +2 to -7 feet MSL. To improve the model's representation of the ground-water flow system, and to improve the agreement between observed and simulated ground-water elevation, the bottom elevations input to the model were modified to more closely reflect field observations and to better simulate the effect of varying aquifer thickness on the flow regime. The revised model was used to calculate ground-water elevation contours for June 5 and July 5, 93 and 123 days, respectively, after system start-up. Injection and pumping rates used as input to the model were based on totalizer readings from individual injection and extraction wells, averaged over the time periods from May 2 to June 5, and June 5 to July 5.

## 5.0 RESULTS

### 5.1 Hydraulic Analysis

Average injection and extraction rates for June are presented in Tables 2 and 3. From June 5 to July 5, the average total flow rate for all injection wells was 33.99 gallons per minute (gpm). The flow rate for injection wells located south of 10th Street, Wells IW-1 to IW-9, was 31.75 gpm. During the same period, the average total flow rate for all extraction wells was 30.98 gpm. The flow rate for Wells EW-1 to EW-20 was 30.63 gpm, and for Well EW-21 was 0.35 gpm. Extraction Well EW-22 was operational, but is not equipped with a separate totalizing flowmeter. All flow rates were calculated based on readings from the flowmeters on the wellheads. For wells located south of 10th Street, the extraction rate was approximately 95 percent of the injection rate.

Measurements of depth to water and calculated water-level elevations from January 3 to July 5, 1989, are presented in Table 4. Ground-water elevations for June 5 and July 5, 1989, are presented on Plates 3 and 4. June 5 and July 5 elevations describe conditions approximately 93 and 123 days after start-up, respectively.

Contours of ground-water elevations simulated using the numerical model are also presented on Plates 3 and 4. In some cases, locations of injection and extraction points used in the model differ slightly from actual well locations because of the nature of discretization of the modeled area. A slightly reduced pumping rate for EW-16 was used in the July 5 simulation to improve the agreement of the simulation results with the observed conditions.

In general, the calculated contours show good agreement with elevations measured at monitoring wells. For July 5, differences between observed and simulated elevations are generally less than 1 foot for wells located outside of the treatment area with the exception of MW-5 and MW-18, which show differences of less than

6.0 ACTIVITIES PLANNED: JULY 1989

On the basis of observed performance, selected injection wells will be redeveloped to improve the injection rate efficiency. Wells will be swabbed over the entire screen interval to remove silt from the slotted sections. The wells will be bailed to remove the silt and then pumped until the water is clear.

Confirmation soil samples will be collected to assess the progress of treatment on the contaminated soils. Borings will be drilled and samples collected, screened in the field for volatile organic compounds, and sent to a state-certified laboratory for TPH and BTEX analyses.

Infiltration Basins BA-2, BA-4, BA-5, BA-6, and BA-7, as shown on Plate 1, will be constructed and filled in July.

7.0 REFERENCES

- Harding Lawson Associates, 1988. *Site Characterization, Pacific Renaissance Plaza, Chinatown Redevelopment Project Area, Oakland, California.* December.
- Harding Lawson Associates, 1989a. *Report of Waste Discharge, Pacific Renaissance Plaza, Chinatown Redevelopment Area, Oakland, California.* February.
- Harding Lawson Associates, 1989b. *Report of System Monitoring: March 1989, Soil Treatment System, Pacific Renaissance Plaza, Oakland, California.* May 4.
- Harding Lawson Associates, 1989c. *Report of System Monitoring: April 1989, Soil Treatment System, Pacific Renaissance Plaza, Oakland, California.* May 31.
- Harding Lawson Associates, 1989d. *Report of System Monitoring: March through May 1989, Soil Treatment System, Pacific Renaissance Plaza, Oakland, California.* July 10.
- Leaking Underground Fuel Tank Task Force, 1987. *Leaking Underground Fuel Tank Field Manual: Guidelines for Site Assessment, Cleanup, and Underground Storage Tank Closure.* December.
- McDonald, D.G., and A.W. Harbaugh, 1984. *A Modular Three-Dimensional Finite Difference Ground-Water Flow Model.* U.S. Geological Survey, Open-File Report 83-875.

Table 1. Schedule for Sampling, Measurement, and Analysis  
 Soil Treatment System  
 Pacific Renaissance Plaza

Harding Lawson Associates

Sampling Station	Flow/Water Levels	Measurement/Analysis								
		Nitrate	Ammonia	Phosphate	Microbial Enumeration	Dissolved Iron	Dissolved Oxygen	EPA 8015 (TPH)	EPA 8010	EPA 8020 (BTEX)
EW-6	D	--	--	--	--	--	W	--	--	--
EW-7	D	--	--	--	--	--	W	M	--	M
EW-8	D	W	W	W	W	--	W	M	--	M
EW-9	D	--	--	--	--	--	W	--	--	--
EW-10	D	--	--	--	--	--	W	--	--	--
EW-11	D	--	--	--	--	--	W	--	--	--
EW-12	D	W	W	W	W	--	W	M	--	M
EW-13	D	--	--	--	--	--	W	--	--	--
EW-14	D	B	B	B	B	--	W	M	--	M
EW-15	D	B	B	B	B	--	W	M	--	M
EW-16	D	W	W	W	W	B	B	M	--	M
EW-17	D	M	M	M	W	--	W	--	--	--
EW-18	D	M	M	M	M	--	W	--	--	--
EW-19	D	M	M	M	M	--	W	M	--	M
EW-20	D	--	--	--	--	--	W	--	--	--
EW-21	D	W	W	W	W	--	--	M	--	M
EW-22	D	--	--	--	--	--	--	--	--	--
Monitoring Wells										
MW-2	W	--	--	--	--	--	--	--	Q	Q
MW-3	W	--	--	--	--	--	--	--	Q	Q

Table 2. Injection Well Flow Rates - June 1989

Harding Lawson Associates

Meter No.	05-Jul-89 Totalizer Reading	05-Jun-89 Totalizer Reading	Elapsed Time (min)	Average Flow Rate (gpm)
IW-1	602280	466788	43105	3.14
IW-2	605917	403085	43105	4.71
IW-3	513995	345199	43105	3.92
IW-4	491939	299193	43105	4.47
IW-5	162295	89546	43105	1.69
IW-6	371056	254974	43105	2.69
IW-7	771313	508644	43105	6.09
IW-8	268101	182214	43105	1.99
IW-9	419045	287649	43105	3.05
IW-10	89688	66921	43105	0.53
IW-11	200658	126930	43105	1.71
Total (1-9)	4205941	2837292	43105	31.75
Total (10,11)	290346	193851	43105	2.24
Total (1-11)	4496287	3031143	43105	33.99

Note: Totalizer readings in gallons.



Table 3. Extration Well Flow Rates: June 1989

Harding Lawson Associates

Meter No.	05-Jul-89 Totalizer Reading	05-Jun-89 Totalizer Reading	Elapsed Time (min)	Average Flow Rate (gpm)
EW-1	125818	77049	43105	1.13
EW-2	147709	84876	43105	1.46
EW-3	197949	109131	43105	2.06
EW-4	162934	85262	43105	1.80
EW-5	215389	140324	43105	1.74
EW-6	92080	61277	43105	0.71
EW-7	90634	60719	43105	0.69
EW-8	133649	77697	43105	1.30
EW-9	156017	100790	43105	1.28
EW-10	135601	94758	43105	0.95
EW-11	129544	80219	43105	1.14
EW-12	116032	76046	43105	0.93
EW-13	135566	89490	43105	1.07
EW-14	115978	69940	43105	1.07
EW-15	159570	94578	43105	1.51
EW-16	396415	221331	43105	4.06
EW-17	314573	214111	43105	2.33
EW-18	384150	278484	43105	2.45
EW-19	224785	148117	43105	1.78
EW-20	107795	57636	43105	1.16
EW-21	19550	4598	43105	0.35
EW-22 *				0.00
Total (1-20)	3542188	2221835	43105	30.63
Total (21-22) *	19550	4598	43105	0.35
Total (1-22)	3561738	2226433	43105	30.98

Note: Totalizer readings in gallons.

\* Well EW-22 is not equipped with a totalizer flow meter.

Table 4. Water-Level Elevations: January through June, 1989

Harding Lawson Associates

Well No.	MW-2		MW-3		MW-5		MW-6		MW-7		MW-8		MW-9	
	GROUND SURFACE 40.05	TOP OF CASING 39.55	GROUND SURFACE 39.02	TOP OF CASING 38.35	GROUND SURFACE 38.45	TOP OF CASING 37.86	GROUND SURFACE 39.95	TOP OF CASING 39.59	GROUND SURFACE 39.35	TOP OF CASING 39.10	GROUND SURFACE 40.63	TOP OF CASING 40.47	GROUND SURFACE 38.65	TOP OF CASING 38.50
DATE	Depth to Water	Elevation	Depth to Water	Elevation	Depth to Water	Elevation	Depth to Water	Elevation	Depth to Water	Elevation	Depth to Water	Elevation	Depth to Water	Elevation
03-Jan-89	33.10	6.45	32.35	6.00	33.00	4.86	30.22	9.37	31.15	7.95	32.78	7.69	30.58	7.92
05-Jan-89	-	-	32.35	6.00	33.00	4.86	30.22	9.37	31.15	7.95	32.78	7.69	30.58	7.92
02-Feb-89	33.05	6.50	33.01	5.34	31.82	6.04	30.23	9.36	30.51	8.59	32.62	7.85	31.67	6.83
08-Feb-89	33.83	5.72	32.21	6.14	32.02	5.84	31.05	8.54	31.44	7.66	33.03	7.44	30.65	7.85
15-Feb-89	-	-	-	-	-	-	-	-	-	-	-	-	-	-
18-Feb-89	30.59	8.96	29.26	9.09	31.90	5.96	30.05	9.54	30.21	8.89	31.96	8.51	30.16	8.34
25-Feb-89	29.85	9.70	28.68	9.67	30.32	7.54	30.57	9.02	31.10	8.00	31.90	8.57	30.80	7.70
02-Mar-89	-	-	-	-	-	-	-	-	-	-	-	-	30.05	8.45
11-Mar-89	-	-	-	-	-	-	-	-	-	-	-	-	23.06	15.44
18-Mar-89	-	-	32.20	6.15	32.01	5.85	-	-	31.52	7.58	-	-	22.45	16.05
25-Mar-89	-	-	27.76	10.59	27.53	10.33	-	-	30.08	9.02	-	-	22.62	15.88
30-Mar-89	-	-	-	-	-	-	-	-	-	-	-	-	23.00	15.50
04-Apr-89	28.52	11.03	27.56	10.79	-	-	28.00	11.59	29.00	10.10	30.45	10.02	22.61	15.89
08-Apr-89	-	-	-	-	-	-	-	-	-	-	-	-	23.12	15.38
11-Apr-89	-	-	-	-	-	-	-	-	-	-	-	-	23.37	15.13
12-Apr-89	28.59	10.96	27.63	10.72	-	-	27.17	12.42	28.96	10.14	30.45	10.02	-	-
18-Apr-89	-	-	-	-	-	-	-	-	-	-	-	-	-	-
19-Apr-89	-	-	-	-	-	-	-	-	28.13	10.97	-	-	23.36	15.14
25-Apr-89	-	-	-	-	-	-	-	-	-	-	-	-	22.80	15.70
02-May-89	28.71	10.84	26.84	11.51	-	-	27.49	12.10	28.54	10.56	29.80	10.67	22.73	15.77
09-May-89	27.99	11.56	26.58	11.77	26.11	11.75	27.34	12.25	28.34	10.76	29.68	10.79	23.04	15.46
17-May-89	27.80	11.75	26.62	11.73	-	-	27.11	12.48	28.16	10.94	29.27	11.20	23.33	15.17
22-May-89	27.52	12.03	28.17	10.18	25.98	11.88	26.89	12.70	27.69	11.41	28.68	11.79	23.94	14.56
31-May-89	27.99	11.56	26.28	12.07	-	-	27.11	12.48	28.28	10.82	29.31	11.16	24.17	14.33
05-Jun-89	27.60	11.95	25.83	12.52	24.96	12.90	27.00	12.59	28.18	10.92	29.41	11.06	19.72	18.78
14-Jun-89	27.58	11.97	26.00	12.35	25.52	12.34	26.88	12.71	28.09	11.01	29.20	11.27	20.53	17.97
19-Jun-89	-	-	-	-	-	-	-	-	-	-	-	-	20.31	18.19
28-Jun-89	-	-	27.88	10.47	25.39	12.47	-	-	-	-	-	-	21.26	17.24
05-Jul-89	27.34	12.21	25.92	12.43	25.50	12.36	26.66	12.93	27.68	11.42	28.99	11.48	21.88	16.62

Notes:

Elevations are in feet above Mean Sea Level (MSL).  
 Depth to water measured from top of casing.

Table 4. Water-Level Elevations: January through June, 1989

Harding Lawson Associates

Well No.	MW-10		MW-11		MW-12		MW-13		MW-14		MW-15		MW-16	
	GROUND SURFACE	TOP OF CASING	GROUND SURFACE	TOP OF CASING	GROUND SURFACE	TOP OF CASING	GROUND SURFACE	TOP OF CASING	GROUND SURFACE	TOP OF CASING	GROUND SURFACE	TOP OF CASING	GROUND SURFACE	TOP OF CASING
	36.74	36.35	37.98	37.55	37.70	37.00	39.79	40.77	39.27	40.26	39.69	40.73	39.55	40.53
DATE	Depth to Water	Elevation	Depth to Water	Elevation	Depth to Water	Elevation	Depth to Water	Elevation	Depth to Water	Elevation	Depth to Water	Elevation	Depth to Water	Elevation
03-Jan-89	27.34	9.01	30.30	7.25	-	-	-	-	-	-	-	-	-	-
05-Jan-89	27.34	9.01	30.30	7.25	-	-	-	-	-	-	-	-	-	-
02-Feb-89	28.11	8.24	30.03	7.52	-	-	-	-	-	-	-	-	-	-
08-Feb-89	27.65	8.70	29.52	8.03	-	-	-	-	-	-	-	-	-	-
15-Feb-89	-	-	-	-	28.89	8.11	-	-	-	-	-	-	-	-
18-Feb-89	27.65	8.70	28.02	9.53	-	-	-	-	-	-	-	-	-	-
25-Feb-89	27.12	9.23	29.05	8.50	30.87	6.13	32.63	8.14	31.07	9.19	32.83	7.90	32.43	8.10
02-Mar-89	27.23	9.12	28.98	8.57	28.46	8.54	32.79	7.98	32.28	7.98	32.40	8.33	32.50	8.03
11-Mar-89	23.59	12.76	28.93	8.62	28.22	8.78	30.12	10.65	28.64	11.62	27.10	13.63	25.64	14.89
18-Mar-89	23.17	13.18	27.79	9.76	27.85	9.15	30.29	10.48	28.20	12.06	26.62	14.11	24.74	15.79
25-Mar-89	23.19	13.16	28.10	9.45	27.47	9.53	29.76	11.01	27.79	12.47	26.28	14.45	24.88	15.65
30-Mar-89	23.56	12.79	28.48	9.07	27.43	9.57	30.12	10.65	27.99	12.27	26.50	14.23	25.48	15.05
04-Apr-89	23.34	13.01	28.61	8.94	28.44	8.56	29.60	11.17	27.84	12.42	26.84	13.89	25.53	15.00
08-Apr-89	23.50	12.85	29.31	8.24	-	-	30.49	10.28	27.81	12.45	26.81	13.92	25.74	14.79
11-Apr-89	23.64	12.71	29.45	8.10	-	-	30.62	10.15	28.04	12.22	27.21	13.52	26.24	14.29
12-Apr-89	-	-	-	-	28.64	8.36	-	-	-	-	-	-	-	-
18-Apr-89	-	-	-	-	-	-	-	-	-	-	27.08	13.65	26.02	14.51
19-Apr-89	23.41	12.94	26.77	10.78	26.98	10.02	30.19	10.58	27.13	13.13	-	-	-	-
25-Apr-89	23.39	12.96	29.18	8.37	27.47	9.53	30.40	10.37	27.75	12.51	27.01	13.72	25.97	14.56
02-May-89	23.54	12.81	28.44	9.11	27.36	9.64	29.42	11.35	27.50	12.76	25.91	14.82	26.42	16.11
09-May-89	23.86	12.49	27.09	10.46	26.85	10.15	29.86	10.91	27.38	12.88	26.63	14.10	25.37	15.16
17-May-89	23.63	12.72	28.88	8.67	27.63	9.37	29.10	11.67	27.73	12.53	27.25	13.48	26.23	14.30
22-May-89	23.54	12.81	28.56	8.99	27.62	9.38	30.24	10.53	27.95	12.31	27.25	13.48	26.34	14.19
31-May-89	24.54	11.81	29.18	8.37	28.16	8.84	30.34	10.43	27.99	12.27	27.42	13.31	26.31	14.22
05-Jun-89	23.22	13.13	28.92	8.63	28.08	8.92	29.88	10.89	26.18	14.08	25.83	14.90	24.67	15.86
14-Jun-89	22.66	13.69	28.66	8.89	27.97	9.03	29.31	11.46	26.54	13.72	24.54	16.19	24.73	15.80
19-Jun-89	22.74	13.61	28.20	9.35	27.47	9.53	29.06	11.71	26.21	14.05	24.11	16.62	22.06	18.47
28-Jun-89	22.66	13.69	28.57	8.98	27.83	9.17	29.47	11.30	26.65	13.61	24.97	15.76	23.01	17.52
05-Jul-89	23.41	12.94	27.61	9.94	27.10	9.90	29.15	11.62	26.78	13.48	25.23	15.50	23.52	17.01

## Notes:

Elevations are in feet above Mean Sea Level (MSL).  
Depth to water measured from top of casing.

Table 4. Water-Level Elevations: January through June, 1989

Harding Lawson Associates

Well No.	MW-17		MW-18	
	GROUND SURFACE	TOP OF CASING	GROUND SURFACE	TOP OF CASING
	39.16	40.16	36.56	35.88
DATE	Depth to Water	Elevation	Depth to Water	Elevation
03-Jan-89	-	-	-	-
05-Jan-89	-	-	-	-
02-Feb-89	-	-	-	-
08-Feb-89	-	-	-	-
15-Feb-89	-	-	26.89	8.99
18-Feb-89	-	-	-	-
25-Feb-89	32.02	8.14	26.90	8.98
02-Mar-89	-	-	26.66	9.22
11-Mar-89	23.45	16.71	26.28	9.60
18-Mar-89	23.35	16.81	26.18	9.70
25-Mar-89	23.35	16.81	25.70	10.18
30-Mar-89	-	-	-	-
04-Apr-89	24.18	15.98	26.10	9.78
08-Apr-89	24.28	15.88	25.82	10.06
11-Apr-89	24.83	15.33	-	-
12-Apr-89	-	-	26.16	9.72
18-Apr-89	24.64	15.52	-	-
19-Apr-89	-	-	25.89	9.99
25-Apr-89	24.57	15.59	27.91	7.97
02-May-89	22.71	17.45	25.76	10.12
09-May-89	23.89	16.27	25.38	10.50
17-May-89	26.85	15.31	25.59	10.29
22-May-89	25.28	14.88	25.27	10.61
31-May-89	24.91	15.25	26.04	9.84
05-Jun-89	22.62	17.54	25.98	9.90
14-Jun-89	20.44	19.72	25.89	9.99
19-Jun-89	19.72	20.44	25.91	9.97
28-Jun-89	20.89	19.27	25.76	10.12
05-Jul-89	21.56	18.60	25.68	10.20

## Notes:

Elevations are in feet above Mean Sea Level (MSL).  
 Depth to water measured from top of casing.

Table 5. Results of Inorganic Chemical and Microbial Analyses of Ground-Water Samples from System Wells

Harding Lawson Associates

WELL	DATE	NITRATE	PHOSPHATE	DISSOLVED	DISSOLVED	AMMONIA	MICROBIAL	
				OXYGEN	IRON		TC	HCU
LOD		0.5(ppm)	0.5(ppm)	0.1(ppm)	0.1(ppm)	0.5(ppm)	NA (CFU/ml)	NA (CFU/ml)
EW-1	15-Mar-89	17.6	ND	NT	ND	ND	7.8E+6	1.2E+2
	29-Mar-89	9.7	3.5	NT	NT	ND	1.8E+6	3.8E+2
	04-Apr-89	13.2	3.8	NT	ND	ND	3.3E+5	2.2E+2
	11-Apr-89	24.6	2.8	NT	NT	ND	NT	NT
	18-Apr-89	30.8	1.0	4.1	ND	ND	3.3E+5	7.8E+1
	25-Apr-89	33.4	3.0	4.8	NT	ND	6.8E+4	2.1E+1
	02-May-89	37.0	5.0	4.9	NT	ND	4.5E+5	9.5E+1
	09-May-89	22.9	2.5	9.8*	NT	ND	5.2E+5	7.0E+2
	17-May-89	37.0	1.5	7.5	NT	ND	2.6E+5	1.4E+2
	23-May-89	15.8	5.3	11.1	NT	ND	NT	NT
	31-May-89	52.8	2.8	5.9	NT	ND	7.6E+5	4.6E+2
	05-Jun-89	25.9	ND	14.5	NT	ND	--	--
	14-Jun-89	17.6	2.3	12.6	NT	ND	--	--
	20-Jun-89	NT	NT	19.3	NT	NT	NT	NT
27-Jun-89	52.8	NT	16.5	NT	NT	NT	NT	
06-Jul-89	47.3	4.0	13.3	NT	ND	--	--	
EW-2	23-May-89	NT	NT	15.8	NT	NT	NT	NT
	31-May-89	NT	NT	12.7	NT	NT	NT	NT
	05-Jun-89	NT	NT	16.3	NT	NT	NT	NT
	14-Jun-89	NT	NT	15.6	NT	NT	NT	NT
	20-Jun-89	NT	NT	19.6	NT	NT	NT	NT
	27-Jun-89	NT	NT	18.9	NT	NT	NT	NT
06-Jul-89	NT	NT	16.5	NT	NT	NT	NT	
EW-3	23-May-89	NT	NT	20.0	NT	NT	NT	NT
	31-May-89	NT	NT	18.3	NT	NT	NT	NT
	05-Jun-89	NT	NT	>20.0	NT	NT	NT	NT
	14-Jun-89	NT	NT	>20.0	NT	NT	NT	NT
	20-Jun-89	NT	NT	19.7	NT	NT	NT	NT
	27-Jun-89	NT	NT	NT	NT	NT	NT	NT
06-Jul-89	NT	NT	14.0	NT	NT	NT	NT	
EW-4	15-Mar-89	16.7	0.6	NT	ND	ND	5.1E+6	9.5E+1
	29-Mar-89	25.5	2.8	NT	NT	ND	5.3E+5	1.7E+2
	04-Apr-89	31.7	4.0	NT	ND	ND	2.5E+5	6.8E+1
	11-Apr-89	34.1	3.3	NT	NT	ND	4.3E+4	4.5E+1
	18-Apr-89	43.6	5.3	7.9	ND	ND	4.3E+4	1.1E+2
	25-Apr-89	49.3	5.0	4.8	NT	ND	9.0E+4	1.7E+2
	02-May-89	48.4	9.0	4.9	NT	ND	2.5E+5	2.0E+3
	09-May-89	70.4	11.8	9.8*	NT	ND	NT	NT
	17-May-89	50.6	16.0	7.5	NT	ND	NT	NT
	23-May-89	52.8	17.0	NT	NT	ND	5.8E+6	7.8E+1
	31-May-89	47.9	17.0	18.9	NT	ND	NT	NT
	05-Jun-89	49.1	16.6	>20.0	NT	ND	1.3E+5	4.9E+2

Table 5. Results of Inorganic Chemical and Microbial Analyses of Ground-Water Samples from System Wells

Harding Lawson Associates

WELL	DATE	NITRATE	PHOSPHATE	DISSOLVED	DISSOLVED	AMMONIA	MICROBIAL	
				OXYGEN	IRON		TC	HCU
LOD		0.5(ppm)	0.5(ppm)	0.1(ppm)	0.1(ppm)	0.5(ppm)	NA (CFU/ml)	NA (CFU/ml)
EW-5	14-Jun-89	27.1	17.0	14.5	NT	ND	6.1E+5	2.4E+5
	20-Jun-89	48.4	17.0	18.5	NT	ND	2.3E+6	2.2E+4
	27-Jun-89	NT	18.0	16.8	NT	ND	8.0E+5	--
	06-Jul-89	48.4	17.0	13.9	NT	ND	--	--
	29-Mar-89	28.0	3.8	NT	NT	ND	NT	NT
	18-Apr-89	NT	NT	8.6	NT	NT	NT	NT
	25-Apr-89	NT	NT	12.8	NT	NT	NT	NT
	02-May-89	NT	NT	NT	NT	NT	NT	NT
	09-May-89	NT	NT	15.0*	NT	NT	NT	NT
	17-May-89	NT	NT	NT	NT	NT	NT	NT
	23-May-89	NT	NT	>20.0	NT	NT	NT	NT
	31-May-89	NT	NT	17.8	NT	NT	NT	NT
	05-Jun-89	NT	NT	>20.0	NT	NT	NT	NT
	14-Jun-89	NT	NT	>20.0	NT	NT	NT	NT
20-Jun-89	NT	NT	19.9	NT	NT	NT	NT	
27-Jun-89	NT	NT	19.6	NT	NT	NT	NT	
06-Jul-89	NT	NT	19.0	NT	NT	NT	NT	
EW-6	23-May-89	NT	NT	7.6	NT	NT	NT	NT
	31-May-89	NT	NT	17.5	NT	NT	NT	NT
	05-Jun-89	NT	NT	14.5	NT	NT	NT	NT
	14-Jun-89	NT	NT	12.3	NT	NT	NT	NT
	20-Jun-89	NT	NT	19.5	NT	NT	NT	NT
	27-Jun-89	NT	NT	12.0	NT	NT	NT	NT
	06-Jul-89	NT	NT	8.2	NT	NT	NT	NT
EW-7	23-May-89	NT	NT	1.8	NT	NT	NT	NT
	31-May-89	NT	NT	11.2	NT	NT	NT	NT
	05-Jun-89	NT	NT	5.3	NT	NT	NT	NT
	14-Jun-89	NT	NT	5.6	NT	NT	NT	NT
	20-Jun-89	NT	NT	1.9	NT	NT	NT	NT
	27-Jun-89	NT	NT	8.0	NT	NT	NT	NT
	06-Jul-89	37.4	3.3	6.2	NT	ND	NT	NT
EW-8	15-Mar-89	11.4	0.5	NT	ND	ND	NT	NT
	29-Mar-89	28.0	3.5	NT	NT	ND	NT	NT
	04-Apr-89	33.0	3.8	NT	ND	ND	3.1E+5	1.4E+2
	11-Apr-89	37.8	2.8	NT	NT	ND	2.0E+4	4.5E+1
	18-Apr-89	33.4	3.8	4.0	NT	ND	4.1E+5	1.4E+2
	25-Apr-89	47.5	8.0	10.9	NT	ND	3.4E+4	9.5E+1
	02-May-89	39.6	11.0	9.8	NT	ND	6.8E+4	5.6E+2
	09-May-89	39.6	15.5	12.1*	NT	ND	6.5E+5	1.8E+2
	17-May-89	57.2	14.3	6.9	NT	ND	NT	NT
	23-May-89	47.5	13.3	14.9	NT	ND	NT	NT
	31-May-89	57.2	13.0	NT	NT	ND	2.5E+5	3.8E+2

Table 5. Results of Inorganic Chemical and Microbial Analyses of Ground-Water Samples from System Wells

Harding Lawson Associates

WELL	DATE	NITRATE	PHOSPHATE	DISSOLVED OXYGEN	DISSOLVED IRON	AMMONIA	MICROBIAL ENUMERATION	
							TC	HCU
LOD		0.5(ppm)	0.5(ppm)	0.1(ppm)	0.1(ppm)	0.5(ppm)	NA (CFU/ml)	NA (CFU/ml)
	05-Jun-89	57.2	15.8	15.9	NT	ND	--	--
	14-Jun-89	39.6	15.0	16.9	NT	ND	--	--
	20-Jun-89	NT	NT	>20.0	NT	NT	NT	NT
	27-Jun-89	55.0	15.5	15.6	NT	0.5	--	--
	06-Jul-89	36.4	16.4	10.7	NT	0.6	--	--
EW-9	23-May-89	NT	NT	11.9	NT	NT	NT	NT
	31-May-89	NT	NT	17.2	NT	NT	NT	NT
	05-Jun-89	NT	NT	12.7	NT	NT	NT	NT
	14-Jun-89	NT	NT	19.1	NT	NT	NT	NT
	20-Jun-89	NT	NT	NT	NT	NT	NT	NT
	27-Jun-89	NT	NT	15.3	NT	NT	NT	NT
	06-Jul-89	NT	NT	12.8	NT	NT	NT	NT
EW-10	23-May-89	NT	NT	10.7	NT	NT	NT	NT
	31-May-89	NT	NT	11.1	NT	NT	NT	NT
	05-Jun-89	NT	NT	13.0	NT	NT	NT	NT
	14-Jun-89	NT	NT	16.0	NT	NT	NT	NT
	20-Jun-89	NT	NT	NT	NT	NT	NT	NT
	27-Jun-89	NT	NT	16.4	NT	NT	NT	NT
	06-Jul-89	NT	NT	13.5	NT	NT	NT	NT
EW-11	23-May-89	NT	NT	11.9	NT	NT	NT	NT
	31-May-89	NT	NT	15.5	NT	NT	NT	NT
	05-Jun-89	NT	NT	16.5	NT	NT	NT	NT
	14-Jun-89	NT	NT	17.4	NT	NT	NT	NT
	20-Jun-89	NT	NT	15.9	NT	NT	NT	NT
	27-Jun-89	NT	NT	12.9	NT	NT	NT	NT
	06-Jul-89	NT	NT	14.8	NT	NT	NT	NT
EW-12	15-Mar-89	13.2	1.0	NT	ND	ND	NT	NT
	29-Mar-89	22.0	3.3	NT	NT	ND	NT	NT
	04-Apr-89	22.9	3.8	NT	ND	ND	NT	NT
	11-Apr-89	20.2	3.8	NT	NT	ND	NT	NT
	18-Apr-89	28.6	1.3	5.6	NT	ND	NT	NT
	25-Apr-89	39.2	2.8	2.6	NT	ND	NT	NT
	02-May-89	33.4	3.0	4.9	NT	ND	1.0E+6	3.5E+2
	09-May-89	31.7	2.3	5.1*	NT	ND	4.6E+5	2.4E+2
	17-May-89	52.0	1.0	3.5	NT	ND	NT	NT
	23-May-89	34.3	1.3	9.1	NT	ND	NT	NT
	31-May-89	30.3	2.5	11.3	NT	ND	NT	NT
	05-Jun-89	26.4	ND	13.6	NT	ND	NT	NT
	14-Jun-89	45.1	ND	14.1	NT	ND	5.3E+6	2.4E+5
	20-Jun-89	39.2	1.3	16.3	NT	ND	NT	NT
	27-Jun-89	11.0	2.8	NT	NT	ND	6.8E+6	--
	06-Jul-89	41.8	3.8	NT	NT	ND	--	--

Table 5. Results of Inorganic Chemical and Microbial Analyses of Ground-Water Samples from System Wells

Harding Lawson Associates

WELL	DATE	NITRATE	PHOSPHATE	DISSOLVED	DISSOLVED	AMMONIA	MICROBIAL	
				OXYGEN	IRON		TC	HCU
LOD		0.5(ppm)	0.5(ppm)	0.1(ppm)	0.1(ppm)	0.5(ppm)	NA (CFU/ml)	NA (CFU/ml)
EW-13								
	23-May-89	NT	NT	14.6	NT	NT	NT	NT
	31-May-89	NT	NT	16.4	NT	NT	NT	NT
	05-Jun-89	NT	NT	17.9	NT	NT	NT	NT
	14-Jun-89	NT	NT	14.5	NT	NT	NT	NT
	20-Jun-89	NT	NT	>20.0	NT	NT	NT	NT
	27-Jun-89	NT	NT	14.5	NT	NT	NT	NT
	06-Jul-89	NT	NT	>20.0	NT	NT	NT	NT
EW-14								
	18-Apr-89	NT	NT	NT	NT	NT	1.1E+7	1.4E+3
	25-Apr-89	NT	NT	4.9	NT	NT	NT	NT
	02-May-89	NT	NT	NT	NT	NT	NT	NT
	09-May-89	NT	NT	9.6*	NT	NT	NT	NT
	17-May-89	48.4	5.0	7.0	NT	ND	2.5E+5	1.1E+3
	23-May-89	39.2	5.8	14.6	NT	ND	3.3E+5	7.9E+2
	31-May-89	44.0	6.8	14.1	NT	ND	NT	NT
	05-Jun-89	46.2	4.8	14.3	NT	ND	3.4E+6	3.5E+4
	14-Jun-89	48.4	5.8	14.3	NT	ND	1.3E+7	1.6E+5
	20-Jun-89	NT	NT	12.9	NT	NT	NT	NT
	27-Jun-89	NT	NT	11.9	NT	NT	NT	NT
	06-Jul-89	63.8	8.0	14.9	NT	ND	--	--
EW-15								
	18-Apr-89	NT	NT	NT	NT	NT	1.1E+6	1.4E+2
	25-Apr-89	45.8	23.0	1.1	ND	NT	1.6E+5	4.7E+2
	02-May-89	NT	NT	NT	NT	NT	NT	NT
	09-May-89	58.1	26.5	>20.0*	NT	1.2	1.8E+6	1.6E+4
	17-May-89	45.4	22.4	8.9	NT	1.8	3.9E+6	3.5E+3
	23-May-89	41.0	19.1	>20.0	NT	2.7	1.3E+7	1.3E+4
	31-May-89	63.8	21.5	>20.0	NT	3.5	6.6E+6	2.4E+5
	05-Jun-89	43.6	28.1	>20.0	NT	3.7	6.4E+6	1.6E+5
	14-Jun-89	48.4	15.8	18.2	NT	2.0	9.2E+6	2.4E+5
	20-Jun-89	NT	NT	>20.0	NT	NT	NT	NT
	27-Jun-89	NT	NT	18.5	NT	NT	NT	NT
	06-Jul-89	52.8	25.7	19.3	NT	2.5	--	--
EW-16								
	15-Mar-89	1.8	0.5	NT	ND	ND	NT	NT
	29-Mar-89	18.4	3.0	NT	NT	ND	NT	NT
	04-Apr-89	31.7	5.0	NT	ND	ND	5.7E+5	3.9E+2
	11-Apr-89	28.6	4.8	NT	NT	ND	1.2E+5	2.2E+2
	18-Apr-89	37.8	14.0	1.0	ND	1.2	3.2E+6	1.4E+3
	25-Apr-89	47.5	11.0	NT	NT	ND	8.4E+5	7.0E+2
	02-May-89	46.2	15.0	9.3	NT	ND	3.5E+5	1.4E+4
	09-May-89	46.2	18.5	14.7*	NT	0.6	2.2E+6	1.3E+3
	17-May-89	36.3	13.3	3.7	NT	ND	4.4E+5	2.2E+3
	23-May-89	29.7	11.8	10.1	NT	ND	8.6E+5	1.4E+3
	31-May-89	35.2	11.8	11.1	NT	0.7	5.9E+6	3.5E+3



Table 5. Results of Inorganic Chemical and Microbial Analyses of Ground-Water Samples from System Wells

Harding Lawson Associates

WELL	DATE	NITRATE	PHOSPHATE	DISSOLVED	DISSOLVED	AMMONIA	MICROBIAL	
				OXYGEN	IRON		TC	HCU
LOD		0.5(ppm)	0.5(ppm)	0.1(ppm)	0.1(ppm)	0.5(ppm)	NA (CFU/ml)	NA (CFU/ml)
EW-17	05-Jun-89	31.5	12.5	12.6	NT	ND	1.8E+6	2.2E+3
	14-Jun-89	29.7	13.3	11.8	NT	ND	3.7E+7	2.4E+5
	20-Jun-89	8.8	13.5	15.8	NT	ND	2.0E+7	3.5E+4
	27-Jun-89	42.9	13.3	19.7	NT	ND	9.5E+5	--
	06-Jul-89	55.0	16.0	15.8	NT	ND	--	--
	18-Apr-89	NT	NT	16.8	NT	NT	NT	NT
	25-Apr-89	6.2	8.3	NT	ND	ND	NT	NT
	02-May-89	NT	NT	NT	NT	NT	NT	NT
	09-May-89	66.0	19.8	18.0*	NT	ND	1.2E+6	1.6E+4
	17-May-89	46.2	15.8	7.8	NT	ND	8.5E+5	3.5E+3
EW-18	23-May-89	44.0	14.2	18.0	NT	ND	6.5E+5	9.5E+2
	31-May-89	46.2	14.0	19.6	NT	ND	6.5E+5	2.8E+3
	05-Jun-89	52.8	13.2	18.2	NT	ND	--	--
	14-Jun-89	45.1	14.2	17.0	NT	ND	--	--
	20-Jun-89	NT	NT	18.5	NT	NT	NT	NT
	27-Jun-89	NT	NT	16.1	NT	NT	--	--
	06-Jul-89	NT	NT	16.4	NT	NT	--	--
	18-Apr-89	NT	NT	10.5	NT	NT	NT	NT
	25-Apr-89	6.2	NT	9.2	NT	NT	NT	NT
	02-May-89	NT	NT	NT	NT	NT	NT	NT
EW-19	09-May-89	NT	NT	18.2*	NT	NT	NT	NT
	17-May-89	38.4	13.3	8.0	NT	ND	NT	NT
	23-May-89	37.0	13.3	17.8	NT	ND	7.0E+5	NT
	31-May-89	46.2	13.0	17.8	NT	ND	5.4E+6	1.7E+3
	05-Jun-89	NT	NT	19.1	NT	NT	NT	NT
	14-Jun-89	42.9	16.0	14.5	NT	ND	--	--
	20-Jun-89	NT	NT	>20.0	NT	NT	NT	NT
	27-Jun-89	NT	NT	>20.0	NT	NT	NT	NT
	06-Jul-89	NT	NT	>20.0	NT	NT	NT	NT
	15-Mar-89	NT	NT	NT	NT	NT	NT	NT
29-Mar-89	NT	NT	NT	NT	NT	NT	NT	
04-Apr-89	18.5	4.0	NT	ND	ND	NT	NT	
11-Apr-89	33.4	4.0	NT	NT	ND	NT	NT	
18-Apr-89	41.8	7.0	9.0	NT	ND	NT	NT	
25-Apr-89	NT	NT	7.2	NT	NT	NT	NT	
02-May-89	50.6	2.5	7.2	NT	ND	NT	NT	
09-May-89	NT	6.8	13.5*	NT	NT	NT	NT	
17-May-89	38.4	3.3	8.3	NT	ND	1.1E+6	1.6E+4	
23-May-89	37.0	2.5	16.5	NT	ND	NT	NT	
31-May-89	NT	NT	>20.0	NT	NT	NT	NT	
05-Jun-89	46.2	3.5	18.5	NT	ND	7.9E+5	1.1E+4	
14-Jun-89	NT	NT	>20.0	NT	NT	NT	NT	
20-Jun-89	NT	NT	>20.0	NT	NT	NT	NT	

Table 5. Results of Inorganic Chemical and Microbial Analyses of Ground-Water Samples from System Wells

Harding Lawson Associates

WELL	DATE	NITRATE	PHOSPHATE	DISSOLVED	DISSOLVED	AMMONIA	MICROBIAL		
				OXYGEN	IRON		TC	HCU	
LOD		0.5(ppm)	0.5(ppm)	0.1(ppm)	0.1(ppm)	0.5(ppm)	NA (CFU/ml)	NA (CFU/ml)	
EW-20	27-Jun-89	NT	NT	19.5	NT	NT	NT	NT	
	06-Jul-89	56.8	8.5	>20.0	--	ND	--	--	
	14-Jun-89	NT	NT	19.1	NT	NT	NT	NT	
	20-Jun-89	NT	NT	17.9	NT	NT	NT	NT	
	27-Jun-89	NT	NT	17.5	NT	NT	NT	NT	
	06-Jul-89	NT	NT	16.7	NT	NT	NT	NT	
EW-21	23-May-89	NT	NT	NT	NT	NT	NT	NT	
	31-May-89	17.6	5.0	NT	NT	ND	3.7E+4	2.4E+4	
	05-Jun-89	17.6	1.3	NT	NT	ND	9.3E+4	7.9E+3	
	14-Jun-89	26.0	1.0	NT	NT	ND	5.8E+4	2.4E+4	
	20-Jun-89	29.0	0.8	NT	NT	ND	1.5E+5	7.0E+3	
	27-Jun-89	27.1	0.8	NT	NT	ND	--	--	
	06-Jul-89	43.6	0.5	NT	NT	ND	--	--	
	Injection Composite								
		21-Mar-89	26	42	NT	NT	15	NT	NT
	18-Apr-89	37.8	110	NT	NT	37.4	NT	NT	
	24-Apr-89	24.6	45.0	NT	NT	22.0	NT	NT	
	01-May-89	23.2	40.0	NT	NT	8.3	NT	NT	
	09-May-89	29.9	13.5	NT	NT	1.5	NT	NT	
	17-May-89	24.6	37.5	NT	NT	6.1	NT	NT	
	23-May-89	31.7	42.5	NT	NT	9.1	NT	NT	
	31-May-89	45.1	50.0	NT	NT	14.5	NT	NT	
	06-Jun-89	35.9	30.0	NT	NT	10.2	NT	NT	
	20-Jun-89	35.9	35.0	NT	NT	8.8	NT	NT	
	27-Jun-89	26.4	29.0	NT	NT	9.8	NT	NT	
	06-Jul-89	34.8	42.5	NT	NT	9.4	NT	NT	
Extraction Composite									
	21-Mar-89	NT	NT	NT	NT	NT	NT	NT	
	18-Apr-89	NT	NT	NT	NT	NT	NT	NT	
	24-Apr-89	55	6.8	NT	NT	ND	NT	NT	
	01-May-89	NT	NT	NT	NT	NT	NT	NT	
	09-May-89	44.0	15.6	NT	NT	ND	NT	NT	
	17-May-89	44.0	13.0	NT	NT	0.5	NT	NT	
	23-May-89	45.4	15.5	NT	NT	ND	NT	NT	
	31-May-89	48.4	11.0	NT	NT	ND	NT	NT	
	06-Jun-89	38.5	12.0	NT	NT	ND	NT	NT	
	20-Jun-89	27.1	14.0	NT	NT	ND	NT	NT	
	27-Jun-89	50.6	13.6	NT	NT	ND	NT	NT	
	06-Jul-89	66.0	16.6	NT	NT	0.5	NT	NT	

Table 5. Results of Inorganic Chemical and Microbial Analyses of  
Ground-Water Samples from System Wells

Harding Lawson Associates

WELL	DATE	NITRATE	PHOSPHATE	DISSOLVED	DISSOLVED	AMMONIA	MICROBIAL	
				OXYGEN	IRON		ENUMERATION	TC
LOD		0.5(ppm)	0.5(ppm)	0.1(ppm)	0.1(ppm)	0.5(ppm)	NA (CFU/ml)	NA (CFU/ml)

## NOTES:

HCU: Hydrocarbon Utilizers

TC: Total Count

LOD: Limit of Detection.

NA: Limit of Detection not applicable.

ND: Not detected at or above LOD.

NT: Not tested.

\*: Dissolved oxygen samples collected on 5/12/89.

--: Results not available.

Inorganic constituents are reported in parts per million (ppm).

Microbial counts are reported in colony-forming units per milliliter of water (CFU/ml).

Analysis performed by HLA Laboratory.

Table 6. Results of Inorganic Chemical and Microbial Analyses of Ground-Water Monitoring Well Samples

Harding Lawson Associates

WELL	DATE	NITRATE	PHOSPHATE	DISSOLVED OXYGEN	DISSOLVED IRON (Fe)	AMMONIA	MICROBIAL ENUMERATION	
							TC	HCU
LOD		0.5(ppm)	0.5(ppm)	0.5(mg/l)	0.1(ppm)	0.5(ppm)	NA (CFU/ml)	NA (CFU/ml)
MW-5	06-Jun-89	10.1	2.5	1.7	NT	ND	--	--
	06-Jul-89	NT	2.5	1.7	NT	ND	NT	NT
MW-7	06-Jun-89	ND	4.8	1.8	NT	ND	--	--
	06-Jul-89	ND	ND	1.8	NT	ND	NT	NT
MW-8	06-Jun-89	NT	NT	4.2	--	--	--	--
	06-Jul-89	NT	NT	4.2	NT	NT	NT	NT
MW-9	03-Mar-89	37.0/32.0*	1.5	1.0**	ND	ND	5.3E+5	9.5E+2
	15-Mar-89	6.0	6.0	NT	ND	ND	5.9E+6	1.8E+2
	29-Mar-89	37.0	32.0	NT	NT	ND	1.8E+6	2.1E+2
	04-Apr-89	41.8	36.0	NT	ND	ND	3.6E+5	1.1E+2
	11-Apr-89	42.1	60.0	NT	NT	ND	3.6E+5	1.4E+2
	18-Apr-89	56.3	60.0	8.4	ND	0.9	1.2E+6	2.2E+2
	25-Apr-89	88.0	50.0	>20.0	NT	2.9	9.9E+5	3.5E+3
	02-May-89	74.8	62.5	18.2	NT	4.8	3.5E+6	5.4E+3
	09-May-89	44.0	37.5	16.6	NT	6.2	NT	NT
	17-May-89	41.0	21.3	8.5	NT	5.6	NT	NT
	23-May-89	54.1	20.0	NT	NT	3.9	NT	NT
	31-May-89	NT	NT	NT	NT	NT	NT	NT
	06-Jun-89	46.2	34.0	NT	NT	10.8	--	--
	14-Jun-89	63.8	14.0	13.9	NT	3.3	--	--
	06-Jul-89	56.8	30.0	NT	NT	NT	--	--
MW-10	03-Mar-89	8.4/5.5*	1.0	4.0**	ND	ND	2.3E+5	3.5E+2
	15-Mar-89	5.5	1.2	NT	ND	ND	NT	NT
	29-Mar-89	11.4	4.5	NT	NT	ND	NT	NT
	04-Apr-89	15.0	1.3	NT	ND	ND	NT	NT
	11-Apr-89	16.5	2.3	NT	NT	ND	NT	NT
	18-Apr-89	16.0	5.3	5.0	NT	ND	NT	NT
	25-Apr-89	14.1	2.0	2.2	NT	ND	NT	NT
	02-May-89	19.4	6.5	2.6	NT	ND	NT	NT
	09-May-89	17.6	1.8	3.1	NT	ND	NT	NT
	17-May-89	21.1	1.5	1.9	NT	ND	NT	NT
	23-May-89	17.6	1.3	NT	NT	ND	NT	NT
	31-May-89	NT	NT	NT	NT	NT	NT	NT
	06-Jun-89	17.6	2.3	2.0	NT	ND	--	--
	14-Jun-89	23.1	ND	2.1	NT	NT	--	--
	06-Jul-89	20.9	ND	--	--	--	--	--
MW-11	03-Mar-89	ND/ND*	0.8	2.0**	ND	ND	1.1E+6	2.8E+3
	15-Mar-89	ND	1.0	NT	ND	ND	NT	NT
	29-Mar-89	31.7	4.3	NT	NT	ND	NT	NT
	04-Apr-89	37.0	5.0	NT	ND	ND	NT	NT
	11-Apr-89	40.7	24.0	NT	NT	ND	3.8E+5	1.1E+2
	18-Apr-89	56.3	26.0	5.7	ND	ND	1.2E+6	1.7E+2

Table 6. Results of Inorganic Chemical and Microbial Analyses of Ground-Water Monitoring Well Samples

Harding Lawson Associates

WELL	DATE	NITRATE	PHOSPHATE	DISSOLVED	DISSOLVED	AMMONIA	MICROBIAL	
				OXYGEN	IRON (Fe)		ENUMERATION	TC
LOD		0.5(ppm)	0.5(ppm)	0.5(mg/l)	0.1(ppm)	0.5(ppm)	NA (CFU/ml)	NA (CFU/ml)
	25-Apr-89	44.0	29.7	11.8	NT	ND	4.7E+5	1.1E+3
	02-May-89	74.8	41.3	17.1	NT	ND	2.4E+6	5.4E+3
	09-May-89	57.2	29.7	12.5	NT	ND	1.4E+6	5.4E+3
	17-May-89	46.2	21.5	9.9	NT	ND	3.5E+6	1.6E+4
	23-May-89	52.8	15.8	NT	NT	ND	2.0E+6	3.3E+3
	31-May-89	58.3	29.7	>20.0	NT	ND	7.0E+5	2.4E+5
	06-Jun-89	66.0	33.0	NT	NT	ND	5.0E+6	2.8E+4
	14-Jun-89	52.8	25.7	14.9	NT	0.5	1.2E+7	2.4E+5
	20-Jun-89	61.6	24.8	12.8	NT	0.9	7.1E+6	1.1E+4
	06-Jul-89	56.8	32.8	NT	NT	NT	--	--
MW-12								
	03-Mar-89	11.4/6.2*	1.0	5.8**	ND	ND	7.1E+5	1.1E+1
	15-Mar-89	12.3	1.1	NT	ND	ND	NT	NT
	29-Mar-89	13.6	4.8	NT	NT	ND	NT	NT
	04-Apr-89	11.4	1.5	NT	ND	ND	NT	NT
	11-Apr-89	7.5	5.0	NT	NT	ND	NT	NT
	18-Apr-89	9.2	6.8	2.1	ND	ND	NT	NT
	25-Apr-89	3.5	1.8	1.4	NT	ND	NT	NT
	02-May-89	12.3	5.0	2.3	NT	ND	NT	NT
	09-May-89	9.7	2.5	2.2	NT	ND	NT	NT
	17-May-89	9.6	2.5	3.5	NT	ND	NT	NT
	23-May-89	8.3	1.3	1.8	NT	ND	NT	NT
	31-May-89	10.3	2.5	2.1	NT	ND	NT	NT
	06-Jun-89	9.2	2.8	NT	NT	ND	--	--
	20-Jun-89	8.4	1.0	4.0	NT	ND	--	--
	06-Jul-89	4.8	ND	NT	NT	--	--	--
MW-13								
	03-Mar-89	11.4/8.6*	1.0	2.0**	0.25	ND	4.1E+6	1.7E+2
	15-Mar-89	9.2	1.1	NT	ND	ND	NT	NT
	29-Mar-89	8.8	6.3	NT	NT	ND	NT	NT
	04-Apr-89	9.7	3.5	NT	ND	ND	NT	NT
	11-Apr-89	13.2	2.8	NT	NT	ND	NT	NT
	18-Apr-89	15.0	8.5	6.0	NT	ND	NT	NT
	25-Apr-89	20.2	2.5	NT	NT	ND	NT	NT
	02-May-89	37.8	2.3	6.8	NT	ND	NT	NT
	09-May-89	42.1	1.5	9.9	NT	ND	NT	NT
	17-May-89	37.0	1.5	10.3	NT	ND	NT	NT
	23-May-89	33.4	1.3	NT	NT	ND	NT	NT
	06-Jun-89	40.5	3.0	NT	NT	ND	--	--
	27-Jun-89	57.2	0.8	18.5	NT	ND	5.9E+5	--
	06-Jul-89	36.5	ND	NT	NT	NT	--	--
MW-14								
	03-Mar-89	37.0/22.0*	0.8	3.0**	ND	ND	3.6E+5	2.2E+2
	15-Mar-89	37.0	1.0	NT	ND	ND	NT	NT
	29-Mar-89	22.8	3.8	NT	NT	ND	NT	NT
	04-Apr-89	29.9	3.8	NT	ND	ND	NT	NT
	11-Apr-89	37.4	2.8	NT	NT	ND	NT	NT
	18-Apr-89	43.6	5.8	NT	NT	ND	NT	NT

Table 6. Results of Inorganic Chemical and Microbial Analyses of Ground-Water Monitoring Well Samples

Harding Lawson Associates

WELL	DATE	NITRATE	PHOSPHATE	DISSOLVED OXYGEN	DISSOLVED IRON (Fe)	AMMONIA	MICROBIAL ENUMERATION	
							TC	HCU
LOD		0.5(ppm)	0.5(ppm)	0.5(mg/l)	0.1(ppm)	0.5(ppm)	NA (CFU/ml)	NA (CFU/ml)
	25-Apr-89	35.2	1.3	NT	NT	ND	NT	NT
	02-May-89	40.5	5.3	6.7	NT	ND	NT	NT
	09-May-89	45.8	1.8	11.7	NT	ND	NT	NT
	17-May-89	51.0	1.5	9.2	NT	ND	NT	NT
	23-May-89	52.4	1.5	NT	NT	ND	NT	NT
	31-May-89	70.4	2.5	16.2	NT	ND	4.2E+5	2.4E+5
	06-Jun-89	44.7	2.0	NT	NT	ND	--	--
	27-Jun-89	4.84	0.8	12.0	NT	ND	5.9E+5	--
	06-Jul-89	22.5	ND	NT	NT	NT	--	--
MW-15								
	03-Mar-89	42.2/19.0*	0.9	4.0**	ND	ND	4.5E+5	2.8E+2
	10-Mar-89	40.5	2.2	NT	NT	NT	1.0E+6	2.8E+2
	15-Mar-89	35.2	1.2	NT	ND	ND	6.9E+6	2.8E+2
	29-Mar-89	20.2	4.2	NT	NT	ND	9.1E+5	2.1E+2
	04-Apr-89	24.6	5.3	NT	ND	ND	4.4E+5	1.4E+2
	11-Apr-89	23.1	4.0	NT	NT	ND	2.7E+6	1.7E+2
	18-Apr-89	31.9	1.3	6.3	ND	ND	3.1E+6	2.9E+1
	25-Apr-89	42.2	1.8	9.6	ND	ND	2.2E+5	4.6E+1
	02-May-89	50.6	3.5	11.4	NT	ND	8.5E+5	1.2E+2
	09-May-89	33.0	1.8	9.6	NT	ND	2.4E+6	2.4E+3
	17-May-89	48.4	2.3	12.1	NT	ND	4.6E+5	2.8E+3
	23-May-89	48.4	1.8	11.3	NT	ND	1.0E+6	3.3E+2
	06-Jun-89	53.9	2.5	NT	NT	ND	--	--
	06-Jul-89	46.9	7.5	NT	NT	ND	--	--
MW-16								
	03-Mar-89	49.3/17.0*	1.2	2.0**	ND	ND	8.4E+5	1.4E+2
	10-Mar-89	14.5	2.2	NT	ND	ND	1.4E+5	1.2E+3
	15-Mar-89	11.4	3.0	NT	ND	ND	6.0E+6	1.1E+3
	29-Mar-89	33.4	7.2	NT	NT	ND	1.6E+6	3.5E+3
	04-Apr-89	39.6	11.5	NT	0.2	NT	2.2E+6	1.2E+3
	11-Apr-89	37.8	16.0	NT	NT	ND	6.7E+5	1.4E+3
	18-Apr-89	52.8	20.0	14.0	ND	ND	1.3E+6	2.3E+2
	25-Apr-89	49.3	22.0	>20.0	ND	ND	5.1E+5	2.2E+2
	02-May-89	57.2	31.3	14.6	NT	ND	2.2E+6	1.7E+3
	09-May-89	59.4	23.6	15.3	NT	ND	4.0E+6	9.5E+2
	17-May-89	41.8	16.5	9.5	NT	ND	6.8E+5	1.4E+3
	23-May-89	46.2	23.9	17.3	NT	ND	1.0E+6	2.2E+3
	31-May-89	61.6	15.7	16.2	NT	ND	4.4E+5	4.9E+3
	06-Jun-89	43.6	18.2	NT	NT	ND	4.0E+6	2.8E+4
	20-Jun-89	61.6	7.6	5.3	--	ND	1.1E+7	5.4E+4
	06-Jul-89	55.4	23.1	--	--	1.5	--	--
MW-17								
	03-Mar-89	NT	NT	NT	NT	NT	NT	NT
	10-Mar-89	12.3	0.8	NT	ND	ND	1.6E+5	1.1E+3
	15-Mar-89	7.5	3.1	NT	ND	ND	1.1E+7	3.5E+3
	29-Mar-89	25.5	3.8	NT	NT	ND	2.6E+6	1.1E+3
	04-Apr-89	35.2	3.5	NT	ND	ND	3.3E+6	6.8E+2
	11-Apr-89	49.4	8.0	NT	NT	ND	1.5E+6	3.9E+2

Table 6. Results of Inorganic Chemical and Microbial Analyses of Ground-Water Monitoring Well Samples

							Harding Lawson Associates	
WELL	DATE	NITRATE	PHOSPHATE	DISSOLVED OXYGEN	DISSOLVED IRON (Fe)	AMMONIA	MICROBIAL ENUMERATION	
							TC	HCU
LOD		0.5(ppm)	0.5(ppm)	0.5(mg/l)	0.1(ppm)	0.5(ppm)	NA (CFU/ml)	NA (CFU/ml)
	18-Apr-89	52.8	16.0	11.8	ND	ND	1.2E+6	1.4E+2
	25-Apr-89	51.0	11.6	13.5	ND	ND	6.0E+5	1.7E+2
	02-May-89	52.8	17.0	13.3	NT	ND	5.1E+6	3.5E+2
	09-May-89	44.9	5.0	6.6	NT	ND	6.5E+6	9.5E+2
	17-May-89	47.7	17.6	8.4	NT	ND	3.0E+6	5.4E+3
	23-May-89	57.2	14.5	17.0	NT	ND	1.1E+6	3.9E+2
	06-Jun-89	46.2	16.0	NT	NT	ND	3.0E+6	3.5E+4
	14-Jun-89	42.9	18.0	15.4	NT	ND	3.0E+6	4.3E+4
	27-Jun-89	56.8	11.0	NT	NT	ND	1.1E+7	--
	06-Jul-89	50.6	13.0	NT	NT	ND	--	--
MW-18	03-Mar-89	15.4/9.3*	0.5	2.9**	ND	ND	1.3E+6	7.9E+1
	15-Mar-89	4.0	1.1	NT	ND	ND	NT	NT
	29-Mar-89	8.8	3.0	NT	NT	ND	NT	NT
	04-Apr-89	6.6	2.8	NT	ND	ND	NT	NT
	11-Apr-89	6.6	3.8	NT	NT	ND	NT	NT
	18-Apr-89	6.6	5.8	5.0	NT	ND	NT	NT
	25-Apr-89	2.2	1.3	3.0	NT	ND	NT	NT
	02-May-89	8.8	4.5	3.4	NT	ND	NT	NT
	09-May-89	11.6	1.8	4.1	NT	ND	NT	NT
	17-May-89	5.8	1.8	3.3	NT	ND	NT	NT
	23-May-89	14.5	1.5	3.9	NT	ND	NT	NT
	31-May-89	NT	NT	NT	NT	NT	NT	NT
	06-Jun-89	17.1	1.3	NT	NT	ND	--	--
	27-Jun-89	8.8	0.8	NT	NT	ND	--	--
	06-Jul-89	15.7	ND	NT	NT	--	--	--

NOTES-HCU: Hydrocarbon Utilizers

TC: Total Count

LOD: Limit of Detection.

NA: Limit of Detection not applicable.

ND: Not detected at or above LOD.

NT: Not tested.

\* : First value from HLA laboratory  
Second value from Pace Laboratories, Inc.

\*\* : Results from Pace Laboratories, Inc.

-- : Results not available.

Inorganic constituents reported in parts per million (ppm).

Microbial counts reported in colony-forming units per milliliter of water (CFU/ml).

Analyses performed by HLA laboratory unless otherwise indicated.

Table 7. Results of Organic Chemical Analyses of Monitoring and System Well Samples

Harding Lawson Associates

Purgeable Aromatics (EPA Method 8020) Petroleum Hydrocarbons (EPA Method 8015)						
WELL	DATE	BENZENE	TOLUENE	ETHYL- BENZENE	XYLENES, TOTAL	TPH AS GASOLINE
LOD		(mg/l) 0.0005	0.0005	0.0005	0.0005	0.25/0.05**
MW-5	03-May-89	ND	ND	ND	0.029	ND
	06-Jun-89	ND	ND	ND	ND	ND
MW-7	04-Apr-89	ND	0.0007	0.0010	0.0012	ND
	03-May-89	ND	0.0012	0.0018	0.0048	0.27
	06-Jun-89	0.001	0.001	0.0022	0.0011	0.4
	07-Jul-89	0.0002	0.001	0.00034	0.0059	0.56
MW-9	02-Mar-89	NT	NT	NT	NT	1.2
	04-Apr-89	0.19	0.35	0.041	0.36	1.5
	01-May-89	0.43	0.60	0.033	0.64	4.6
	06-Jun-89	0.36	0.106	0.110	0.10	1.6
	06-Jul-89	0.16	0.084	0.052	1.8	5.2
MW-10	02-Mar-89	NT	NT	NT	NT	2.8
	04-Apr-89	1.6	0.76	0.13	0.68	4.2
	01-May-89	1.2	0.67	0.16	0.67	3.4
	06-Jun-89 *	0.66/0.64	0.14/0.14	0.11/0.10	0.24/0.14	4.8/4.3
	06-Jul-89	2.0	2.2	0.54	1.8	12
MW-11	02-Mar-89	NT	NT	NT	NT	15
	04-Apr-89	2.5	3.8	0.17	2.4	10
	19-Apr-89	3.8	2.8	ND	5.7	14
	01-May-89	1.3	1.7	0.069	1.7	5.2
	07-Jun-89	0.082	0.097	0.045	0.167	12
	06-Jul-89 *	2.1/2.3	2.5/2.8	0.14/0.16	2.6/3.0	15/15
MW-12	15-Feb-89	ND	ND	ND	ND	ND
	03-Mar-89	NT	NT	NT	NT	ND
	05-Apr-89	0.0014	0.0023	ND	0.0054	ND
	02-May-89	0.026	0.0033	ND	0.0063	0.10
	07-Jun-89	0.034	0.0037	ND	0.012	0.18
	06-Jul-89	0.029	0.0025	ND	0.0059	0.12
MW-13	02-Mar-89	NT	NT	NT	NT	1.4
	04-Apr-89	0.041	0.039	0.0038	0.28	0.71
	01-May-89	0.048	0.049	0.013	0.13	0.34
	07-Jun-89	0.051	0.037	0.02	0.082	0.98
	06-Jul-89	0.210	0.054	0.013	0.109	0.76
MW-14	02-Mar-89	NT	NT	NT	NT	ND
	04-Apr-89	0.44	0.063	ND	0.27	1.4
	01-May-89	0.35	0.011	ND	0.094	0.94
	07-Jun-89 *	0.057/ND	0.0022/ND	0.0005/ND	0.043/ND	1.1/0.64



Table 7. Results of Organic Chemical Analyses of Monitoring and System Well Samples

Harding Lawson Associates

Purgeable Aromatics (EPA Method 8020)  
 Petroleum Hydrocarbons (EPA Method 8015)

WELL	DATE	BENZENE (mg/l)	TOLUENE	ETHYL- BENZENE	XYLENES, TOTAL	TPH AS GASOLINE
LOD		0.0005	0.0005	0.0005	0.0005	0.25/0.05**
MW-15	06-Jul-89	3.0	1.7	0.050	3.6	14
	03-Mar-89	NT	NT	NT	NT	3.9
	04-Apr-89	0.88	0.97	0.11	0.93	3.7
	02-May-89	1.5	1.1	0.086	0.74	2.7
	07-Jun-89	5.7	4.3	0.3	2.4	22
	05-Jul-89	2.0	3.0	0.26	2.0	12
MW-16	02-Mar-89	NT	NT	NT	NT	2.1
	04-Apr-89	2.1	2.2	0.18	1.4	6.7
	02-May-89	0.74	0.94	0.11	0.95	2.7
	07-Jun-89	0.37	0.56	0.51	0.35	14
	05-Jul-89	1.9	2.7	1.8	--	16
MW-17	04-Apr-89	3.1	2.9	0.27	3.9	12
	02-May-89	1.2	1.0	0.11	1.4	3.9
	07-Jun-89	1.2	1.2	ND	1.3	6.3
	05-Jul-89	3.0	3.3	2.7	3.9	18
MW-18	15-Feb-89	ND	ND	ND	ND	ND
	03-Mar-89	NT	NT	NT	NT	ND
	05-Apr-89	ND	ND	ND	ND	ND
	02-May-89	ND	ND	ND	ND	ND
	07-Jun-89	ND	ND	ND	ND	ND
	06-Jul-89	ND	ND	ND	ND	ND
EW-1	04-Apr-89	1.6	1.0	0.087	1.8	5.9
	01-May-89	3.2	1.2	0.15	1.4	6.3
	05-Jun-89	7.7	5.0	0.2	3.5	24
	05-Jul-89	4.4	5.1	0.32	3.8	24
EW-4	04-Apr-89	NT	NT	NT	NT	2.5
	01-May-89	0.56	0.28	0.034	0.72	2.0
	05-Jun-89	0.4	0.2	ND	0.6	3.1
	05-Jul-89	0.29	0.15	0.021	1.2	4.3
EW-7	05-Jul-89	18	16	0.67	10	74
EW-8	01-May-89	1.1	0.49	0.021	0.30	2.3
	05-Jun-89	2.5	2.0	ND	1.4	8.3
	05-Jul-89	3.3	2.9	0.22	3.1	19
EW-12	01-May-89	1.8	0.66	0.048	0.62	3.6
	05-Jun-89	25	20	0.8	11	71
	05-Jul-89	5.2	5.6	0.38	3.4	25

Table 7. Results of Organic Chemical Analyses of Monitoring and System Well Samples **Harding Lawson Associates**

Purgeable Aromatics (EPA Method 8020) Petroleum Hydrocarbons (EPA Method 8015)						
WELL	DATE	BENZENE	TOLUENE	ETHYL- BENZENE	XYLENES, TOTAL	TPH AS GASOLINE
LOD	(mg/l)	0.0005	0.0005	0.0005	0.0005	0.25/0.05**
EW-13	19-Apr-89	0.068	0.0064	ND	0.20	0.79
EW-14	05-Jul-89	1.8	1.7	0.08	1.1	8.7
EW-15	19-Apr-89 #	13080	61000	16000	140000	660000
	05-Jul-89	2.0	2.8	0.26	2.9	19
EW-16	04-Apr-89 *	2.8/3.3	2.0/2.6	0.10/0.14	0.99/1.2	8.9/8.8
	19-Apr-89	0.002	0.0027	ND	0.0021	0.57
	01-May-89	5.0	4.6	0.34	2.5	12
	05-Jun-89	2.5	2.6	ND	1.8	9.5
	05-Jul-89	2.8	3.6	0.28	1.8	16
EW-19	01-May-89	1.4	1.2	0.068	0.77	3.4
	05-Jun-89	0.9	0.6	ND	0.6	2.9
	05-Jul-89 *	2.2/1.4	0.62/0.71	0.041/0.043	0.72/0.8	4.8/5.3
EW-21	05-Jun-89	ND	ND	ND	0.3	3.2
	05-Jul-89	0.0026	0.015	0.017	0.095	1.1
BLANK	05-Apr-89	0.5	ND	ND	ND	ND
	01-May-89	ND	ND	ND	ND	ND
	06-Jun-89	ND	ND	ND	ND	ND
	06-Jul-89	ND	ND	ND	ND	ND

## NOTES:

LOD: Limit of Detection.

ND: Not detected at or above LOD.

NT: Not tested.

\*: Two values indicate results of duplicate samples

\*\*: LOD Changed to 0.05 after 4/19/89

#: Free product observed in well.

Organic constituents reported in milligrams per liter.

Analyses performed by PACE Laboratories, Inc.

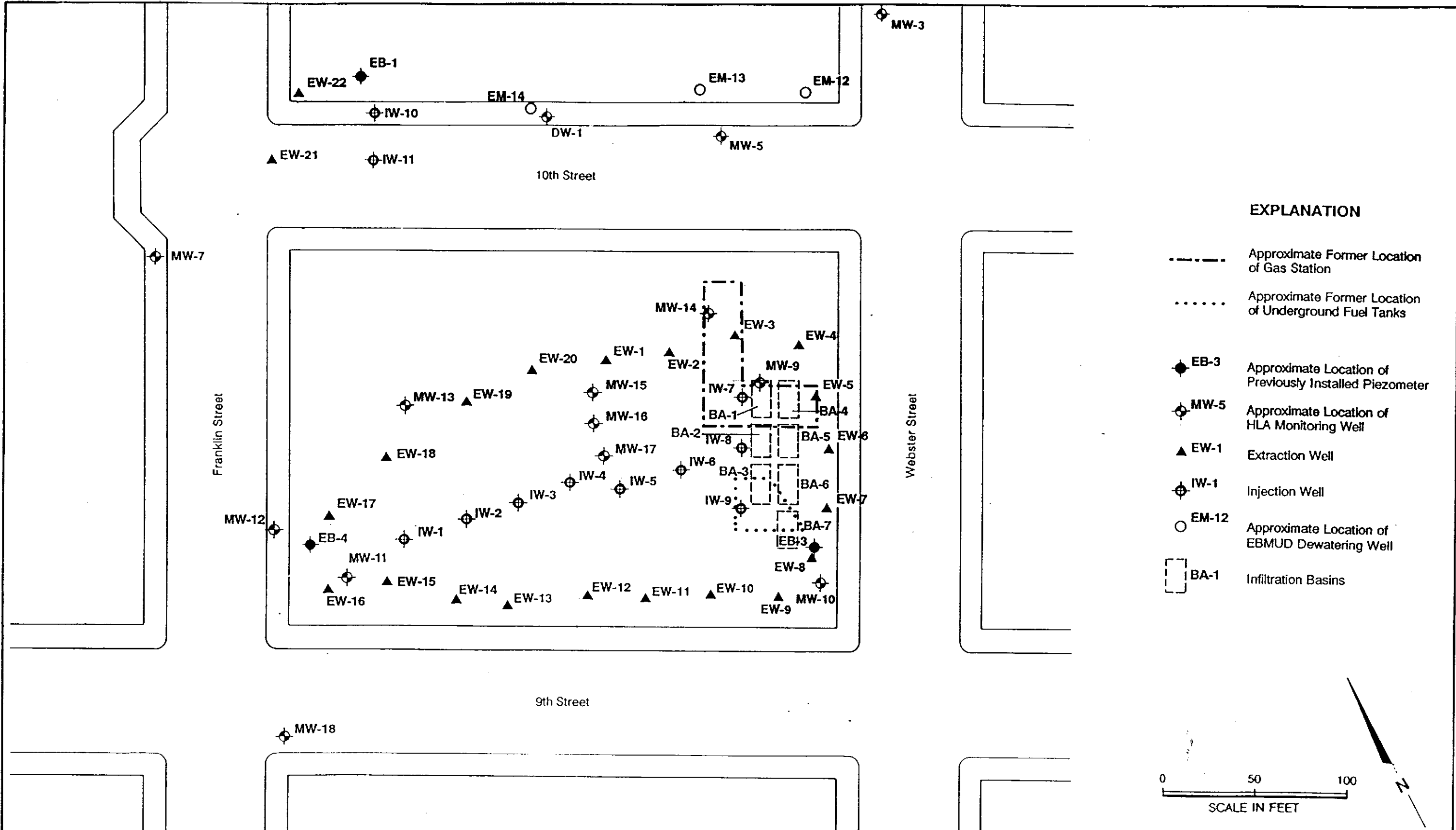

**EXPLANATION**



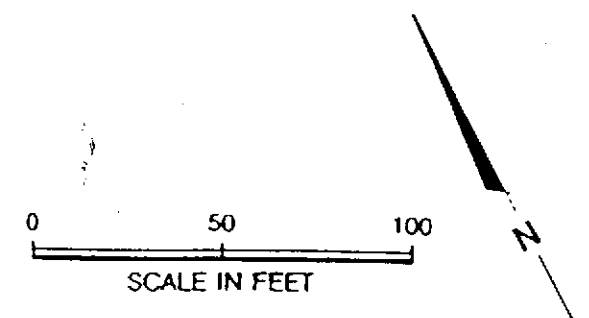

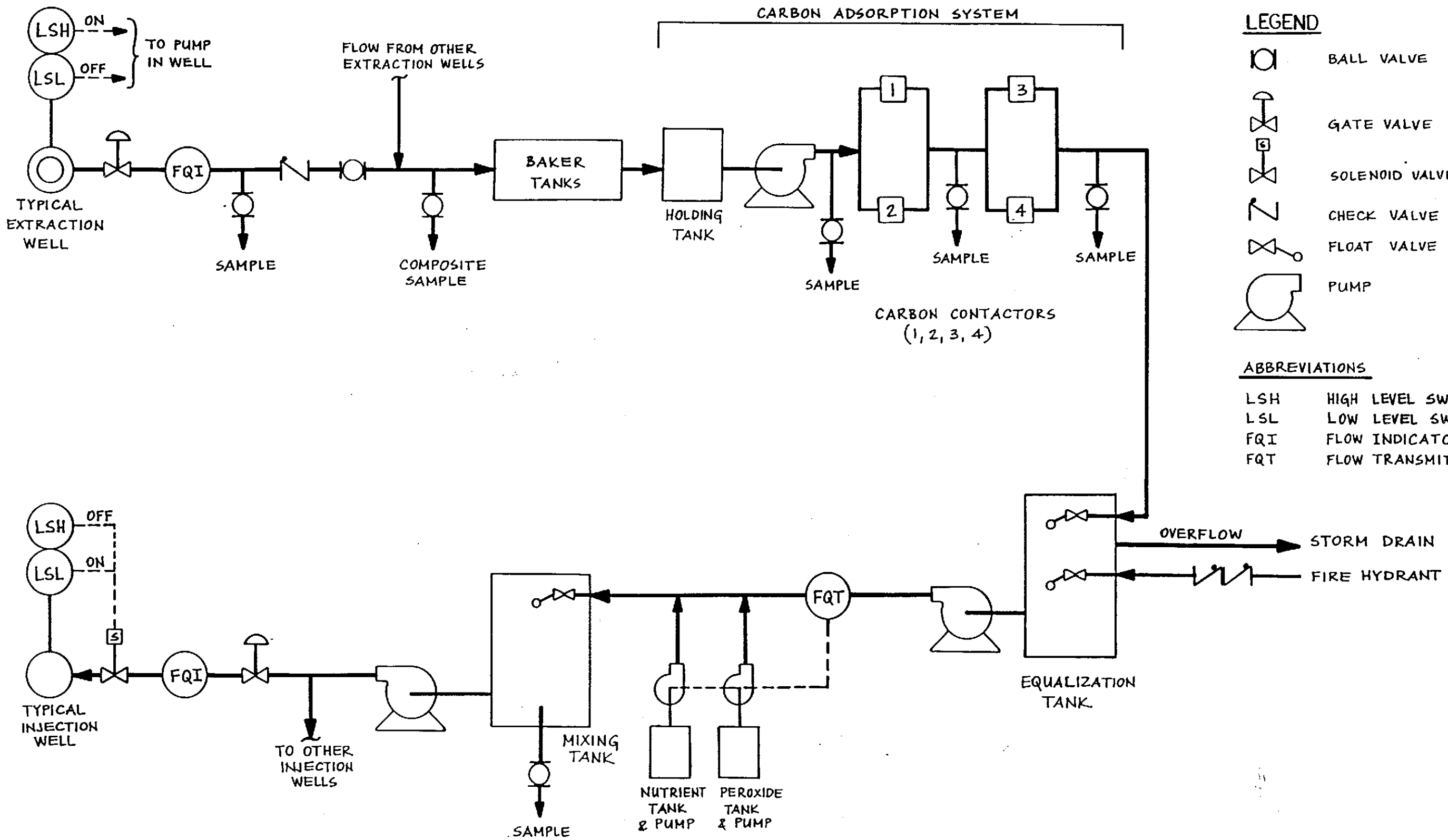

- Approximate Former Location of Gas Station
- ..... Approximate Former Location of Underground Fuel Tanks
- ◆ EB-3 Approximate Location of Previously Installed Piezometer
- ⊕ MW-5 Approximate Location of HLA Monitoring Well
- ▲ EW-1 Extraction Well
- ⊕ IW-1 Injection Well
- EM-12 Approximate Location of EBMUD Dewatering Well
- BA-1 Infiltration Basins



 <b>Harding Lawson Associates</b> Engineers, Geologists & Geophysicists	<b>Site Plan</b> Soil Treatment System Pacific Renaissance Plaza Oakland, California		PLATE <b>1</b>
	DRAWN LZ	JOB NUMBER 09382,040.02	APPROVED DFL
		REVISED DATE	





**LEGEND**

-  BALL VALVE
-  GATE VALVE
-  SOLENOID VALVE
-  CHECK VALVE
-  FLOAT VALVE
-  PUMP

**ABBREVIATIONS**

- LSH HIGH LEVEL SWITCH
- LSL LOW LEVEL SWITCH
- FQI FLOW INDICATOR
- FQT FLOW TRANSMITTER

	<b>Harding Lawson Associates</b> Engineers and Geoscientists	<b>Schematic Diagram</b> Soil Treatment System Pacific Renaissance Oakland, California	PLATE <b>2</b>
	DRAWN AK	JOB NUMBER 09382,040.02	APPROVED 

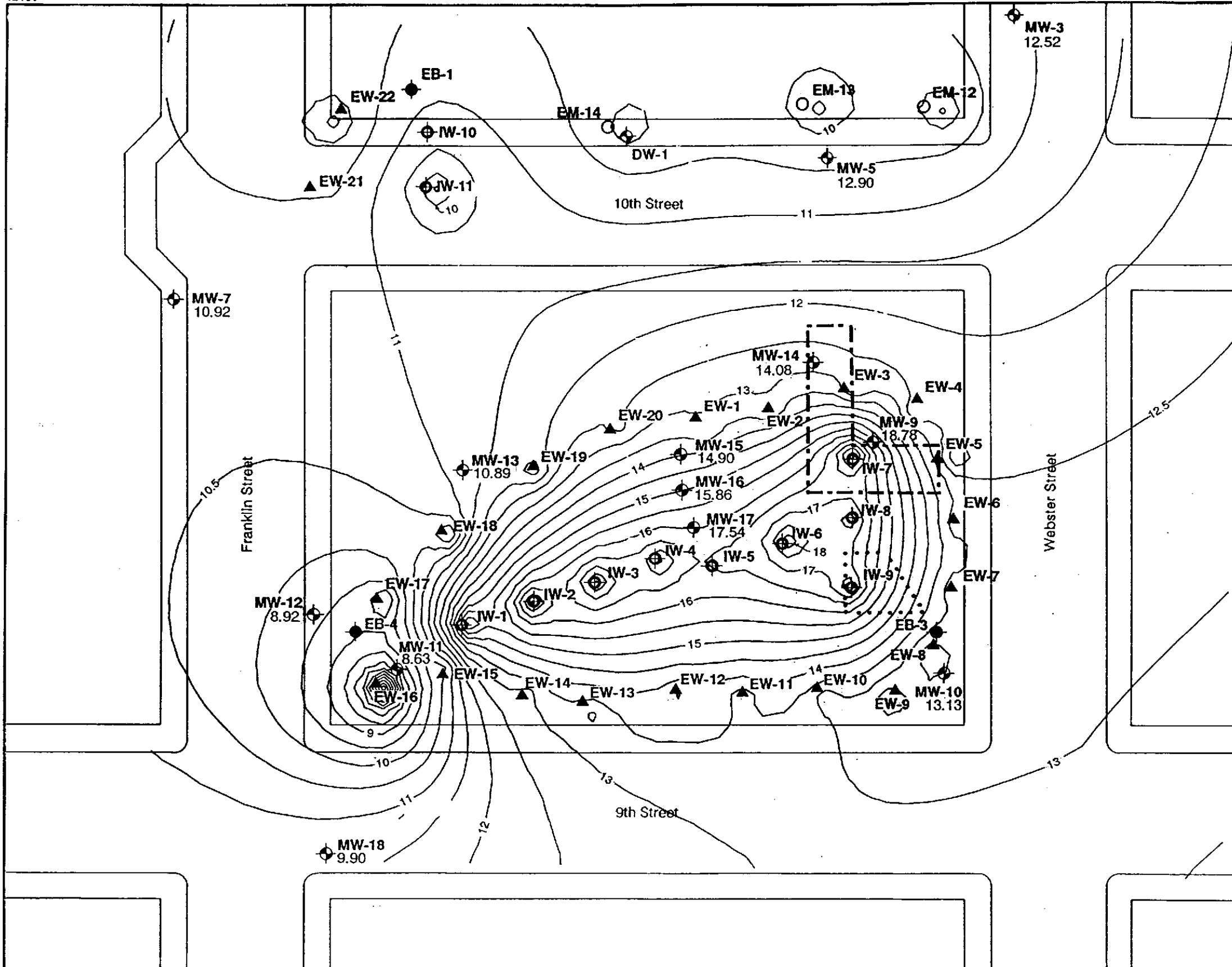

**EXPLANATION**

- Approximate Former Location of Gas Station
- ..... Approximate Former Location of Underground Fuel Tanks
- EB-3 Approximate Location of Previously Installed Piezometer
- ⊕ MW-5 Approximate Location of HLA Monitoring Well
- ▲ EW-1 Extraction Well
- ⊕ IW-1 Injection Well
- EM-12 Approximate Location of EBMUD Dewatering Well
- 18.78 Observed Ground-Water Elevation (feet above MSL)
- Simulated Ground-Water Elevation Contour (contour interval 0.5 feet)

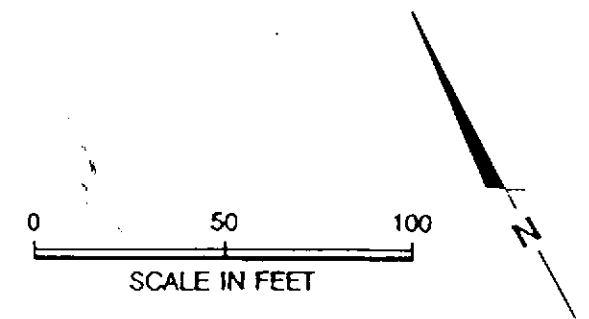

	<b>Harding Lawson Associates</b> Engineers, Geologists & Geophysicists		Observed and Simulated Ground-Water Elevations - June 5, 1989 Soil Treatment System Pacific Renaissance Plaza Oakland, California		PLATE <b>3</b>
	DRAWN LZ	JOB NUMBER 09382,040.02	APPROVED DFL	DATE 7/89	REVISED

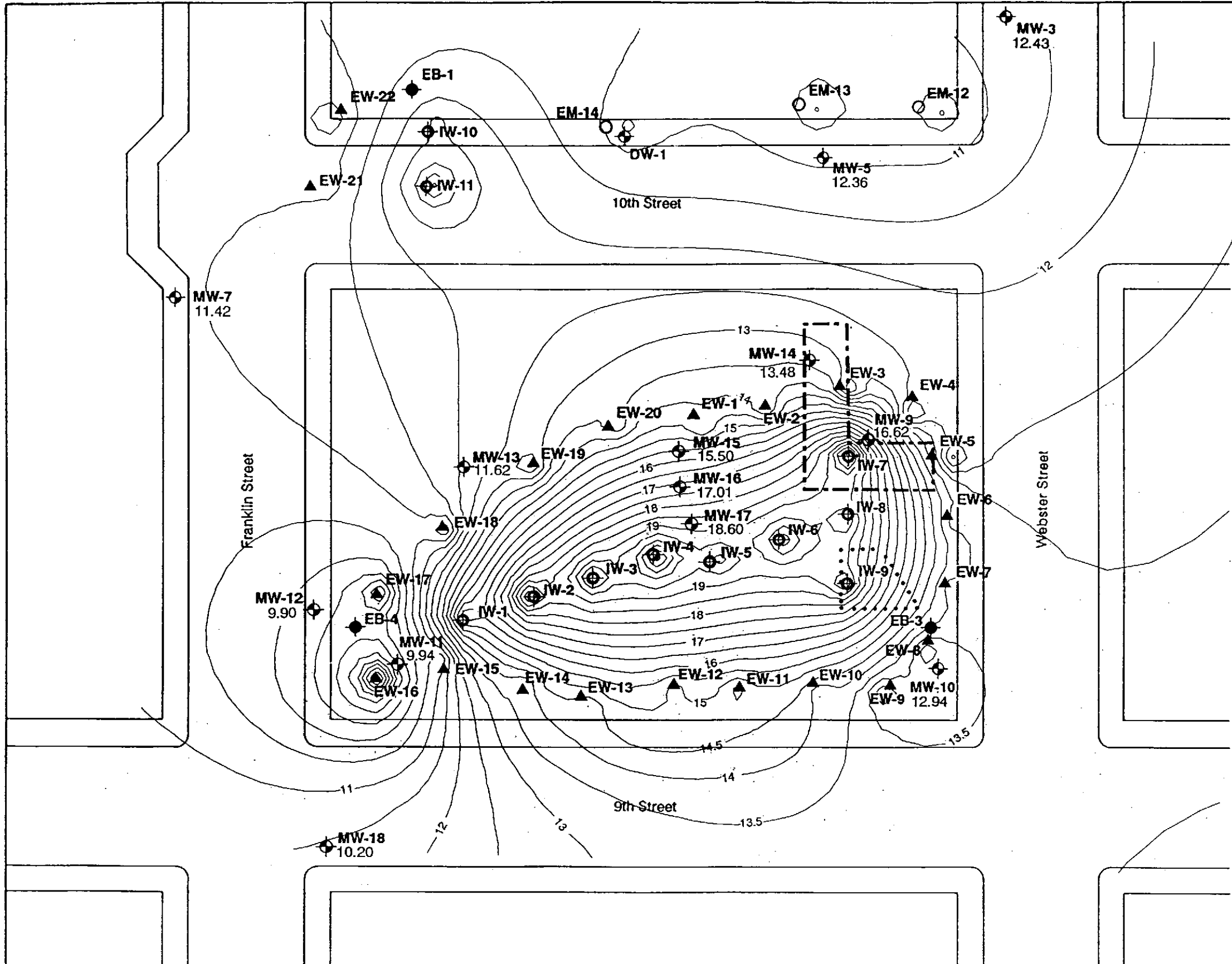

EXPLANATION

- Approximate Former Location of Gas Station
- ..... Approximate Former Location of Underground Fuel Tanks
- ◆ EB-3 Approximate Location of Previously Installed Piezometer
- ◆ MW-5 Approximate Location of HLA Monitoring Well
- ▲ EW-1 Extraction Well
- ⊕ IW-1 Injection Well
- EM-12 Approximate Location of EBMUD Dewatering Well
- 18.78 Observed Ground-Water Elevation (feet above MSL)
- ⊖ 13 Simulated Ground-Water Elevation Contour (contour interval 0.5 feet)

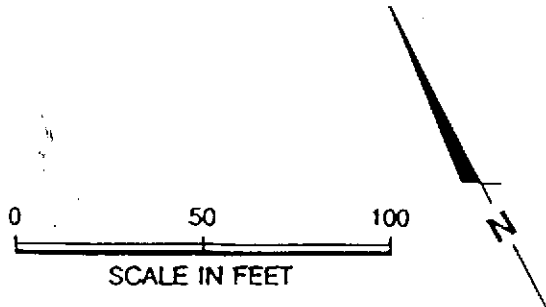

**HLA** **Harding Lawson Associates**  
Engineers and Geoscientists

**Observed and Simulated Ground-Water Elevations - July 5, 1989**  
Soil Treatment System  
Pacific Renaissance Plaza  
Oakland, California

PLATE **4**

DRAWN	JOB NUMBER	APPROVED	DATE	REVISED	DATE
ML	9382,040.02	DFL	7/89		

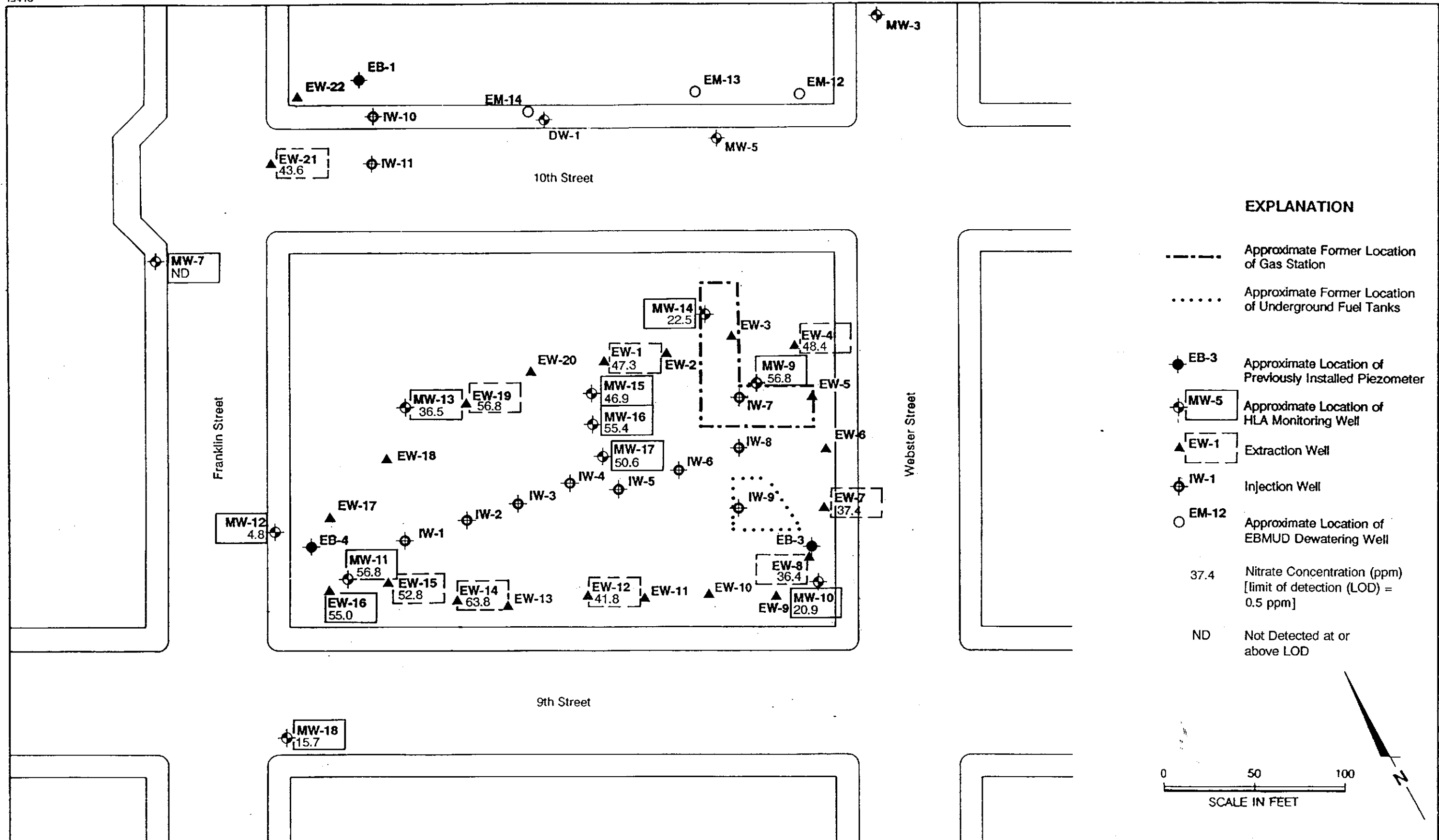

<p><b>Harding Lawson Associates</b> Engineers and Geoscientists</p>	<p><b>Concentrations of Nitrate in Ground-Water - July 6, 1989</b></p> <p>Pacific Renaissance Plaza Oakland, California</p>		<p>PLATE</p> <p><b>5</b></p>
	<p>DRAWN ML</p>	<p>JOB NUMBER 9382,040.02</p>	<p>APPROVED DXL</p>

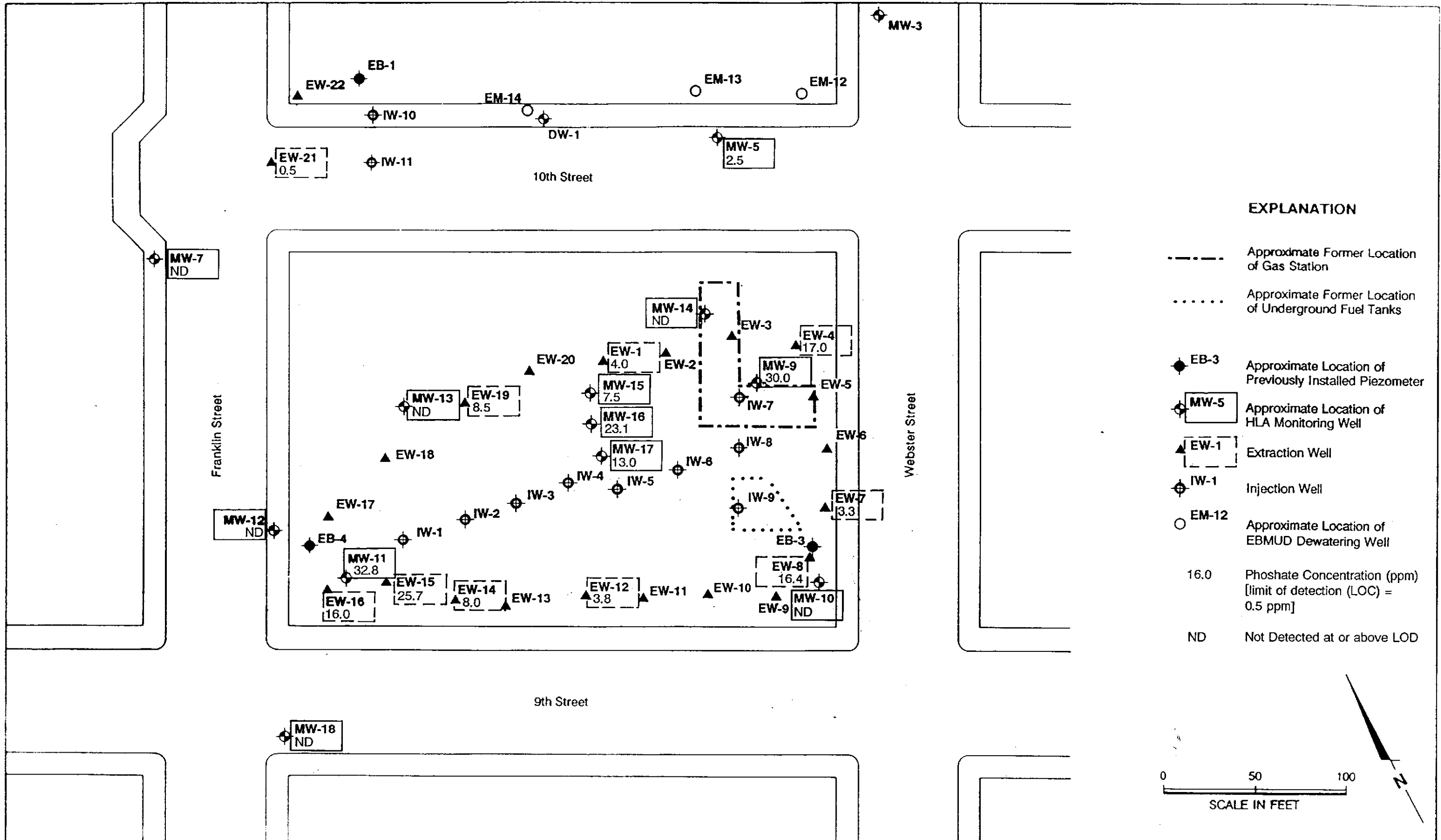

**EXPLANATION**

- Approximate Former Location of Gas Station
- ..... Approximate Former Location of Underground Fuel Tanks
- ◆ EB-3 Approximate Location of Previously Installed Piezometer
- ◆ MW-5 Approximate Location of HLA Monitoring Well
- ▲ EW-1 Extraction Well
- ⊕ IW-1 Injection Well
- EM-12 Approximate Location of EBMUD Dewatering Well
- 16.0 Phosphate Concentration (ppm) [limit of detection (LOD) = 0.5 ppm]
- ND Not Detected at or above LOD

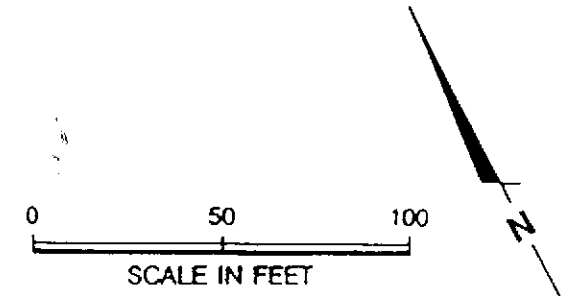

**HLA** Harding Lawson Associates  
Engineers and Geoscientists

**Concentrations of Phosphate in  
Ground-Water - July 6, 1989**  
Pacific Renaissance Plaza  
Oakland, California

PLATE  
**6**

DRAWN ML	JOB NUMBER 9382,040.02	APPROVED DFL	DATE 7/89	REVISED	DATE
-------------	---------------------------	-----------------	--------------	---------	------



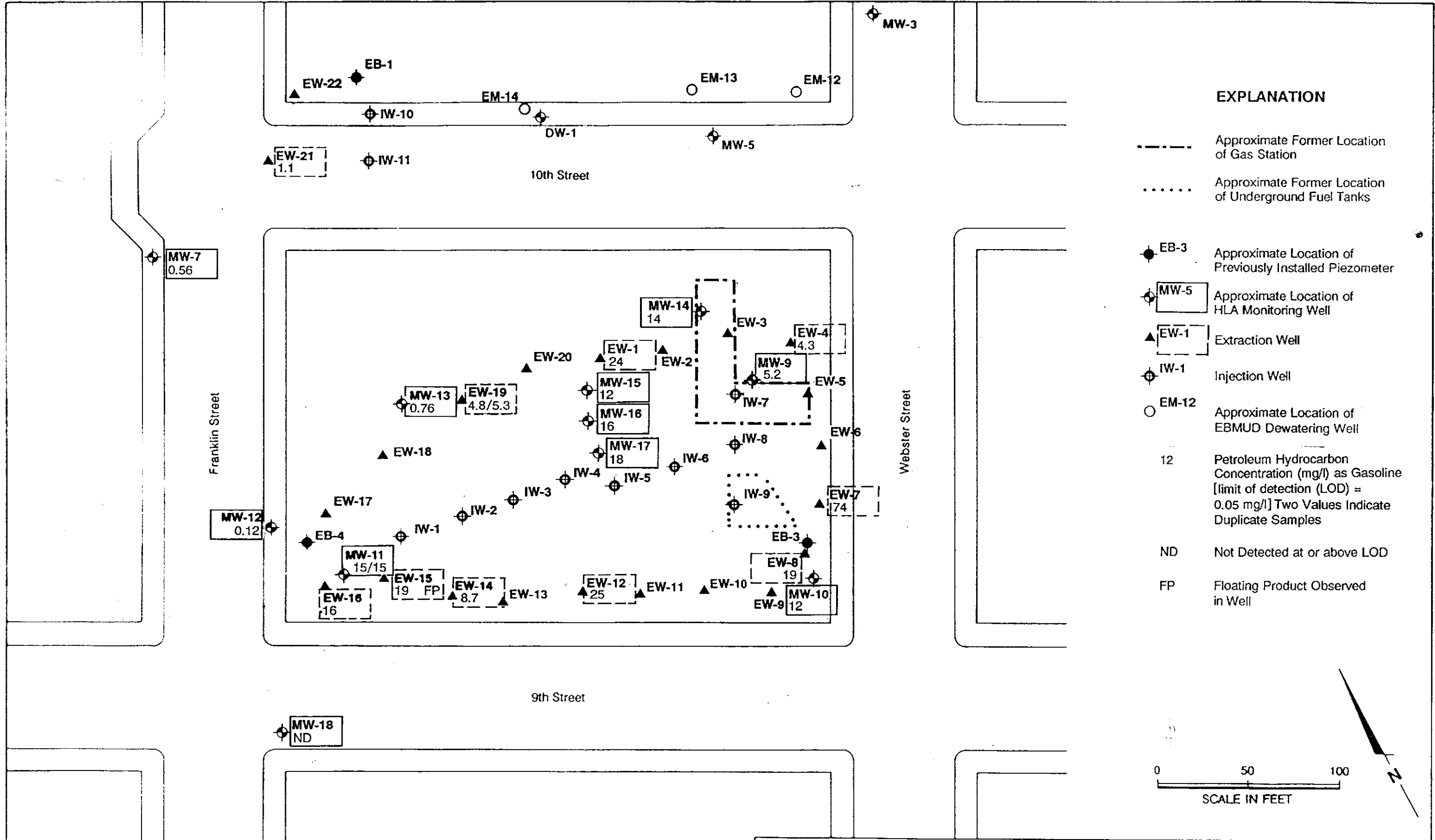

**EXPLANATION**

- Approximate Former Location of Gas Station
- ..... Approximate Former Location of Underground Fuel Tanks
- EB-3 Approximate Location of Previously Installed Piezometer
- ⊕ MW-5 Approximate Location of HLA Monitoring Well
- ▲ EW-1 Extraction Well
- ⊕ IW-1 Injection Well
- EM-12 Approximate Location of EBMUD Dewatering Well
- 12 Petroleum Hydrocarbon Concentration (mg/l) as Gasoline [limit of detection (LOD) = 0.05 mg/l] Two Values Indicate Duplicate Samples
- ND Not Detected at or above LOD
- FP Floating Product Observed in Well

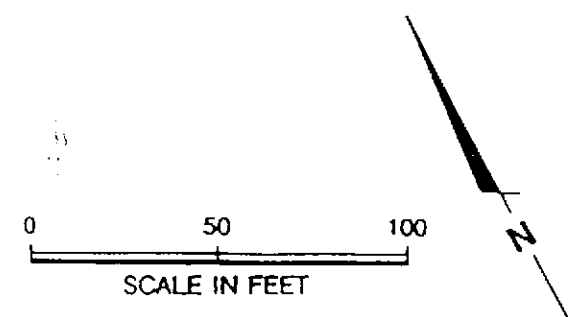

 <b>Harding Lawson Associates</b> Engineers and Geoscientists	<b>Concentrations of Petroleum Hydrocarbons in Ground-Water - July 5-6, 1989</b>		PLATE <b>7</b>
	Pacific Renaissance Plaza Oakland, California		
DRAWN ML	JOB NUMBER 9382,040.02	APPROVED DFL	DATE 7/89
		REVISED	DATE

Appendix A

LABORATORY ANALYTICAL RESULTS FOR WATER SAMPLES

July 25, 1989

Mr. David Leland  
Harding Lawson Associates  
200 Rush Landing Road  
Novato, CA 94945

Dear Mr. Leland:

Enclosed is the report of laboratory analyses for samples received  
07/05/89.

If you have any questions concerning this report, please feel free  
to contact us.

Sincerely,

  
Stephen F. Nackord  
Director, Sampling and Analytical Services

Enclosures

Mr. David Leland  
Page 3

July 25, 1989  
PACE Project Number: 490705504

PACE Sample Number:  
Parameter

Units	MDL	743200 89270504	743210 89270505	743220 89270506
		EW-1	EW-4	EW-7

ORGANIC ANALYSIS

INDIVIDUAL PARAMETERS

Purgeable Fuels, as Gasoline (EPA 8015)	mg/L	0.05	24	4.3	74
AROMATIC VOLATILE COMPOUNDS EPA 8020					
Benzene	ug/L	0.2	4400	290	18000
Toluene	ug/L	0.2	5100	150	16000
Chlorobenzene	ug/L	0.2	LT 40	LT 4.0	LT 80
Ethylbenzene	ug/L	0.2	320	21	670
Xylenes, Total	ug/L	0.2	3800	1200	10000
1,3-Dichlorobenzene	ug/L	0.2	LT 10	LT 4	LT 80
1,4-Dichlorobenzene	ug/L	0.2	LT 10	LT 4	LT 80
1,2-Dichlorobenzene	ug/L	0.2	LT 10	LT 4.0	LT 80
Fluorobenzene (Surrogate Recovery)			96%	100%	100%

MDL Method Detection Limit  
LT Less than.

Mr. David Leland  
Page 4

July 25, 1989  
PACE Project Number: 490705504

PACE Sample Number:  
Parameter

Units	MDL	743230 89270507	743240 89270508	743250 89270509
		EW-8	EW-12	EW-14

ORGANIC ANALYSIS

INDIVIDUAL PARAMETERS

Purgeable Fuels, as Gasoline (EPA 8015)	mg/L	0.050	19	25	8.7
---	------	-------	----	----	-----

AROMATIC VOLATILE COMPOUNDS EPA 8020

Benzene	ug/L	0.2	3300	5200	1800
Toluene	ug/L	0.2	2900	5600	1700
Chlorobenzene	ug/L	0.2	LT 10	LT 50	LT 20
Ethylbenzene	ug/L	0.2	220	380	80
Xylenes, Total	ug/L	0.2	3100	3400	1100
1,3-Dichlorobenzene	ug/L	0.2	LT 10	LT 50	LT 20
1,4-Dichlorobenzene	ug/L	0.2	LT 10	LT 50	LT 20
1,2-Dichlorobenzene	ug/L	0.2	LT 10	LT 50	LT 20
Fluorobenzene (Surrogate Recovery)			112%	98%	101%

MDL Method Detection Limit  
LT Less than.

Mr. David Leland  
Page 5

July 25, 1989  
PACE Project Number: 490705504

PACE Sample Number:  
Parameter

Units	MDL	743260 89270510	743270 89270511	743280 89270512
-------	-----	--------------------	--------------------	--------------------

ORGANIC ANALYSIS

EW-15 EW-16 EW-19

INDIVIDUAL PARAMETERS

Purgeable Fuels, as Gasoline (EPA 8015) mg/L

0.050	19	16	4.8
-------	----	----	-----

AROMATIC VOLATILE COMPOUNDS EPA 8020

Benzene	ug/L	0.2	2000	2800	1200
Toluene	ug/L	0.2	2800	3600	620
Chlorobenzene	ug/L	0.2	LT 10	LT 50	LT 4.0
Ethylbenzene	ug/L	0.2	260	280	41
Xylenes, Total	ug/L	0.2	2900	1800	720
1,3-Dichlorobenzene	ug/L	0.2	LT 10	LT 50	LT 4.0
1,4-Dichlorobenzene	ug/L	0.2	LT 10	LT 50	LT 4.0
1,2-Dichlorobenzene	ug/L	0.2	LT 10	LT 50	LT 4.0
Fluorobenzene (Surrogate Recovery)			106%	98%	109%

MDL Method Detection Limit  
LT Less than.

Mr. David Leland  
Page 6

July 25, 1989  
PACE Project Number: 490705504

PACE Sample Number:  
Parameter

Units	MDL	743290 89270513	743300 89270514	743310 89270515
-------	-----	--------------------	--------------------	--------------------

ORGANIC ANALYSIS

INDIVIDUAL PARAMETERS

	Units	MDL	EW-19 Duplicate	EW-21	Field Blank
Purgeable Fuels, as Gasoline (EPA 8015)	mg/L	0.050	5.3	1.1	ND

AROMATIC VOLATILE COMPOUNDS EPA 8020

Benzene	ug/L	0.2	1400	2.6	ND
Toluene	ug/L	0.2	710	15	ND
Chlorobenzene	ug/L	0.2	LT 8.0	2.4	ND
Ethylbenzene	ug/L	0.2	43	17	ND
Xylenes, Total	ug/L	0.2	800	95	ND
1,3-Dichlorobenzene	ug/L	0.2	LT 8.0	LT 1	ND
1,4-Dichlorobenzene	ug/L	0.2	LT 8.0	LT 1	ND
1,2-Dichlorobenzene	ug/L	0.2	LT 8.0	LT 1	ND
Fluorobenzene (Surrogate Recovery)			101%	99%	97%

MDL Method Detection Limit  
ND Not detected at or above the MDL.  
LT Less than.

Mr. David Leland  
Page 7

July 25, 1989  
PACE Project Number: 490705504

PACE Sample Number:  
Parameter

Units	MDL	743320 89270518	743330 89270519	743340 89270520
-------	-----	--------------------	--------------------	--------------------

ORGANIC ANALYSIS

MW-15      MW-16      MW-17

INDIVIDUAL PARAMETERS

Purgeable Fuels, as Gasoline (EPA 8015)	mg/L	0.050	12	16	18
---	------	-------	----	----	----

AROMATIC VOLATILE COMPOUNDS EPA 8020

Benzene	ug/L	0.2	2000	1900	3000
Toluene	ug/L	0.2	3000	2700	3300
Chlorobenzene	ug/L	0.2	LT 20	LT 20	LT 25
Ethylbenzene	ug/L	0.2	260	180	270
Xylenes, Total	ug/L	0.2	2000	4500	3900
1,3-Dichlorobenzene	ug/L	0.2	LT 20	LT 20	LT 25
1,4-Dichlorobenzene	ug/L	0.2	LT 20	LT 20	LT 25
1,2-Dichlorobenzene	ug/L	0.2	LT 20	LT 20	LT 25
Fluorobenzene (Surrogate Recovery)			95%	102%	95%

MDL Method Detection Limit  
LT Less than.

The data contained in this report were obtained using EPA or other approved methodologies. All analyses were performed by me or under my direct supervision.

  
Stephen F. Nackord  
Director, Sampling and Analytical Services

  
Douglas E. Oram, Ph.D.  
Organic Chemistry Manager







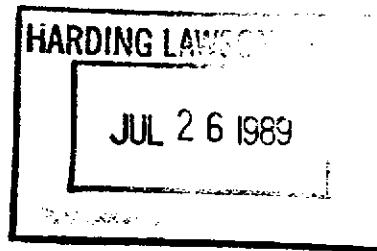

July 20, 1989

Mr. David Leland  
Harding Lawson Associates  
200 Rush Landing Road  
Novato, CA 94945

Dear Mr. Leland:

Enclosed is the report of laboratory analyses for samples received 07/06/89.

Confirmation of dichlorobenzene isomer content is complete and the results have been amended accordingly. None of the dichlorobrenzenes were present in the samples.

If you have any questions concerning this report, please feel free to contact us.

Sincerely,

A handwritten signature in cursive script that reads "Stephen Nackord".

Stephen F. Nackord  
Director, Sampling and Analytical Services

Enclosures

Harding Lawson Associates  
200 Rush Landing Road  
Novato, CA 94945

July 20, 1989 (Rev.07/25/89)  
PACE Project Number: 490706501  
PACE WP Number: WPPLAB #933

Attn: Mr. David Leland

Pacific Ren. Plaza

Date Sample(s) Collected: 07/06/89  
Date Sample(s) Received: 07/06/89

PACE Sample Number:  
Parameter

<u>Parameter</u>	<u>Units</u>	<u>MDL</u>	743360 89270601	743370 89270602	743380 89270603
<u>ORGANIC ANALYSIS</u>			<i>mw-18</i>	<i>mw-12</i>	<i>mw-7</i>
<u>INDIVIDUAL PARAMETERS</u>					
Purgeable Fuels, as Gasoline (EPA 8015)	mg/L	0.05	ND	0.12	0.56
<u>AROMATIC VOLATILE COMPOUNDS EPA 8020</u>					
Benzene	ug/L	0.2	ND	29	0.20
Toluene	ug/L	0.2	ND	2.5	1.0
Chlorobenzene	ug/L	0.2	ND	ND	1.6
Ethylbenzene	ug/L	0.2	ND	ND	0.34
Xylenes, Total	ug/L	0.2	ND	5.9	5.9
1,3-Dichlorobenzene	ug/L	0.2	ND	ND	ND
1,4-Dichlorobenzene	ug/L	0.2	ND	ND	ND
1,2-Dichlorobenzene	ug/L	0.2	ND	ND	ND
Fluorobenzene (Surrogate Recovery)			95%	109%	100%

ND Not detected at or above the MDL.  
MDL Method Detection Limit

Mr. David Leland  
Page 2

July 20, 1989  
PACE Project Number: 490706501

PACE Sample Number: Parameter	Units	MDL	743390 89270604	743400 89270605	743410 89270606
<u>ORGANIC ANALYSIS</u>			<i>MW-13</i>	<i>MW-11</i>	<i>MW-11 Duplicate</i>
<u>INDIVIDUAL PARAMETERS</u>					
Purgeable Fuels, as Gasoline (EPA 8015)	mg/L	0.05	0.76	15.0	15.0
<u>AROMATIC VOLATILE COMPOUNDS EPA 8020</u>					
Benzene	ug/L	0.2	210	2100	2300
Toluene	ug/L	0.2	54	2500	2800
Chlorobenzene	ug/L	0.2	LT 0.5	LT 10	LT 8.0
Ethylbenzene	ug/L	0.2	13	140	160
Xylenes, Total	ug/L	0.2	109	2600	3000
1,3-Dichlorobenzene	ug/L	0.2	ND	LT 10	LT 8.0
1,4-Dichlorobenzene	ug/L	0.2	ND	LT 10	LT 8.0
1,2-Dichlorobenzene	ug/L	0.2	ND	LT 10	LT 8.0
Fluorobenzene (Surrogate Recovery)			114%	102%	109%

MDL Method Detection Limit  
LT Less than (sample dilution required for analysis).

Mr. David Leland  
Page 3

July 20, 1989  
PACE Project Number: 490706501

PACE Sample Number: Parameter	Units	MDL	743420 89270607	743430 89270608	743440 89270609
<u>ORGANIC ANALYSIS</u>			<i>mw-10</i>	<i>Field Blank</i>	<i>mw-9</i>
<u>INDIVIDUAL PARAMETERS</u>					
Purgeable Fuels, as Gasoline (EPA 8015)	mg/L	0.05	12.0	ND	5.2
<u>AROMATIC VOLATILE COMPOUNDS EPA 8020</u>					
Benzene	ug/L	0.2	2000	ND	160
Toluene	ug/L	0.2	2200	ND	84
Chlorobenzene	ug/L	0.2	LT 20	ND	LT 20
Ethylbenzene	ug/L	0.2	540	ND	52
Xylenes, Total	ug/L	0.2	1800	ND	1800
1,3-Dichlorobenzene	ug/L	0.2	LT 20	ND	LT 20
1,4-Dichlorobenzene	ug/L	0.2	LT 20	ND	LT 20
1,2-Dichlorobenzene	ug/L	0.2	LT 20	ND	LT 20
Fluorobenzene (Surrogate Recovery)			101%	99%	96%

MDL Method Detection Limit  
 ND Not detected at or above the MDL.  
 LT Less than (sample dilution required for analysis).

Mr. David Leland  
Page 4

July 20, 1989  
PACE Project Number: 490706501

PACE Sample Number: 743450  
Parameter Units MDL 89270610

ORGANIC ANALYSIS

*MW-14*

INDIVIDUAL PARAMETERS

Purgeable Fuels, as Gasoline (EPA 8015)	mg/L	0.05	14
AROMATIC VOLATILE COMPOUNDS EPA 8020			
Benzene	ug/L	0.2	3000
Toluene	ug/L	0.2	1700
Chlorobenzene	ug/L	0.2	LT 8.0
Ethylbenzene	ug/L	0.2	50
Xylenes, Total	ug/L	0.2	3600
1,3-Dichlorobenzene	ug/L	0.2	LT 8.0
1,4-Dichlorobenzene	ug/L	0.2	LT 8.0
1,2-Dichlorobenzene	ug/L	0.2	LT 8.0
Fluorobenzene (Surrogate Recovery)			99%

MDL Method Detection Limit  
LT Less than (sample dilution required for analysis).

The data contained in this report were obtained using EPA or other approved methodologies. All analyses were performed by me or under my direct supervision.

*Douglas E. Oram*  
Douglas E. Oram, Ph.D.  
Organic Chemistry Manager



7655 Redwood Boulevard  
 P.O. Box 578  
 Novato, California 94948  
 415/892-0821  
 Telecopy: 415/892-0831  
 Telex: 340523

# CHAIN OF CUSTODY FORM

Lab: PACE

Job Number: 9382,039,02  
 Name/Location: PRP - OAKLAND  
 Project Manager: D. LELAND

Samplers: DL HARMS  
TM DRINKARD  
 Recorder: *[Signature]*  
(Signature Required)

SOURCE CODE	MATRIX				#CONTAINERS & PRESERV.			SAMPLE NUMBER OR LAB NUMBER			DATE				
	Water	Sediment	Soil	Oil	Unpres.	H <sub>2</sub> SO <sub>4</sub>	HNO <sub>3</sub>	HCL	Yr	Wk	Seq	Yr	Mo	Dy	Time
23	X						2	89	27	0601	89	07	06	07	55
										02					0825
										03					0850
										04					0920
										05					0945
										06					0950
										07					1025
										08					1010
										09					1105
										10					1125

STATION DESCRIPTION/NOTES
PACE #
74336
337
338
339
340
341
342
343
344
345

ANALYSIS REQUESTED			
EPA 601/8010	EPA 602/8020	EPA 624/8240	EPA 625/8270
X	X	X	X
Priority Pestic. Metals	Benzene/Toluene/Xylene	Total Petrol. Hydrocarb.	EPA 8015
X	X	X	X

LAB NUMBER			DEPTH IN FEET	COL MTD CD	QA CODE	MISCELLANEOUS
Yr	Wk	Seq				
						9/3

CHAIN OF CUSTODY RECORD		
RELINQUISHED BY: <i>[Signature]</i>	RECEIVED BY: <i>[Signature]</i>	DATE/TIME
RELINQUISHED BY: <i>[Signature]</i>	RECEIVED BY: <i>[Signature]</i>	DATE/TIME
RELINQUISHED BY: <i>[Signature]</i>	RECEIVED BY: <i>[Signature]</i>	DATE/TIME
RELINQUISHED BY: <i>[Signature]</i>	RECEIVED BY: <i>[Signature]</i>	DATE/TIME
DISPATCHED BY: <i>[Signature]</i>	DATE/TIME	RECEIVED FOR LAB BY: <i>[Signature]</i> DATE/TIME
METHOD OF SHIPMENT		



DISTRIBUTION

REPORT OF SYSTEM MONITORING  
JUNE 1989  
SOIL TREATMENT SYSTEM  
PACIFIC RENAISSANCE PLAZA  
OAKLAND, CALIFORNIA  
August 2, 1989

Copy No. 4

		<u>Copy No.</u>
1 copy:	California Regional Water Quality Control Board San Francisco Bay Region 1111 Jackson Street, Room 6000 Oakland, California 94607  Attention: Mr. Vijay B. Patel	1
2 copies:	City of Oakland Redevelopment Agency One City Hall Plaza Oakland, California 94612  Attention: Mr. Peter Chen	2-3
1 copy:	Alameda County Department of Environmental Health 80 Swan Way, Room 200 Oakland, California 94621  Attention: Mr. Lowell Miller	4

JDS/DFL/TLW/jjh/D8909-H

QUALITY CONTROL REVIEWER

Tamara L. Williams  
Tamara L. Williams  
Geologist - 3954

Harding Lawson Associates

8/3/89



Transmittal/Memorandum

---

**To:** Alameda County Department of Environmental Health  
80 Swan Way, Room 200  
Oakland, California 94621

Attention: Mr. Lowell Miller

---

**From:** David Leland DL  
**Date:** August 2, 1989  
**Subject:** June 1989 Soil Treatment System Monitoring Report  
**Job No.:** 09382,040.02

---

**Remarks:** Please find attached a copy of the "Report of System Monitoring: June 1989, Soil Treatment System, Pacific Renaissance Plaza, Oakland, California", describing the operations and monitoring of the in situ soil treatment system located at the Pacific Renaissance Plaza site in Oakland.

DFL/dc/df1011#1

---

**cc:**