

RECEIVED

10:44 am, May 10, 2011

Alameda County
Environmental Health

February 28, 2011
Project No. 07-131

Alameda County Department of Environmental Health
1131 Harbor Bay Park Way
Alameda, California 94502

Attention: Mark Detterman, PG, CEG
Hazardous Materials Specialist

SITE: FORMER EZ-SERVE LOCATION 100877
525 WEST A STREET
HAYWARD, CALIFORNIA
FUEL LEAK CASE NO. RO0000023

RE: Site Conceptual Model and Preferential Pathway Study

Dear Mr. Detterman:

I declare under penalty of perjury that to the best of my knowledge, the information and/or recommendations contained in the attached report is/are true and correct.

Please contact us with questions at (813) 636-8111 #100 or jackc@edifl.com.

Sincerely,
Restructure Petroleum Marketing Services of California



Jack Ceccarelli
President

**REVISED SITE CONCEPTUAL MODEL
AND
PREFERENTIAL PATHWAY STUDY**

**FORMER EZ-SERVE 100877
525 WEST A STREET
HAYWARD, CALIFORNIA**

Submitted to:
ALAMEDA COUNTY ENVIRONMENTAL HEALTH DEPARTMENT

Prepared for:
RESTRUCTURE PETROLEUM MARKETING SERVICES of CALIFORNIA

FEBRUARY 2011

February 28, 2011
Project No. 07-131

Alameda County Environmental Health Department
1131 Harbor Bay Park Way
Alameda, California 94502

Attention: Mark Detterman, P.G., C.E.G

Subject: Revised Site Conceptual Model and Preferential Pathway Study
Former EZ-Serve 100877, 525 West A Street, Hayward, CA
Alameda County Case No. R0000023

GeoEnviro Services, Inc. (GESI) on behalf of Restructure Petroleum Marketing Services of California (RPMS) is pleased to present this report describing a site conceptual model and preferential pathway study for the LUFT project identified as the former EZ-Serve Station No. 100877 located at 525 West A Street, Hayward, California (Site).

The only revision to the previous version of the report is the deletion of the last sentence in Section 6.2 that incorrectly referred to the operation of a soil vapor extraction system onsite.

Should you have questions or comments regarding this report, please contact us at (805) 642-1668 or email to jschaaf@geoenviroservices.com.

Sincerely,

GEOENVIRO SERVICES, INC.

Joseph P. Schaaf, P.G., C.Hg.
Principal Geologist



cc: Mr. Jack Ceccarelli, RPMS
SWRCB – Geotracker Database

TABLE OF CONTENTS

	Page
1.0 INTRODUCTION.....	1
2.0 ENVIRONMENTAL SETTING.....	2
2.1 SITE LOCATION	2
2.2 PHYSICAL SETTING	2
2.3 GEOLOGY / HYDROGEOLOGY.....	3
3.0 SUMMARY OF UST REMOVAL, SITE ASSESSMENT AND REMEDIATION ACTIVITIES.....	3
3.1 INITIAL SITE ASSESSMENT, CONVERSE ENVIRONMENTAL CONSULTANTS 1986, 1987.....	3
3.2 UST REMOVAL, 1990.....	3
3.3 ADDITIONAL ASSESSMENT, ASSOCIATED SOILS ANALYSIS, 1992	4
3.4 ADDITIONAL ASSESSMENT, ASSOCIATED SOILS ANALYSIS, 1993	4
3.5 ADDITIONAL ASSESSMENT, BROWN AND CALDWELL, 1995.....	4
3.6 RISK ASSESSMENT, BROWN AND CALDWELL, 1995.....	4
3.7 REMEDIATION WELL INSTALLATION, ATC ASSOCIATES, 2002.....	5
3.8 CORRECTIVE ACTION PLAN, ATC ASSOCIATES, 2002.....	5
3.9 SOIL EXCAVATION DURING UST INSTALLATION ACTIVITIES, 2008	5
3.10 ADDITIONAL SITE ASSESSMENT, GEOENVIRO SERVICES, INC. ...	5
3.11 GROUNDWATER MONITORING ACTIVITIES 1992 TO 2011.....	6
4.0 PREFERENTIAL PATHWAY STUDY	6
4.1 UTILITY SURVEY	6
4.2 WELL SURVEY	7
5.0 EXTENT OF IMPACT IN SOIL AND GROUNDWATER	8
5.1 EXTENT OF IMPACTS IN SOIL.....	8
5.2 EXTENT OF IMPACTS IN GROUNDWATER.....	9
6.0 SENSITIVE RECEPTORS	10
6.1 SENSITIVE RECEPTORS	10
6.2 SOIL RECEPTORS	10
6.3 GROUNDWATER RECEPTORS	10
6.3.1 Human Receptor	10
6.3.2 Irrigation Wells.....	10
7.0 CONCLUSIONS.....	11
8.0 LIMITATIONS.....	11

TABLE OF CONTENTS (CONTINUED)

	Page
TABLES	
Summary of Historical Groundwater Elevation Data.....	1
Summary of Historical Laboratory Analysis of Groundwater Samples from Wells.....	2
FIGURES	
Site Location Map	1
Site Map.....	2
Site Map Showing Subsurface Utilities in the Vicinity of the Site.....	3
Site Map with Locations of Vertical Cross Sections.....	4
Vertical Cross Section A – A'	5
Vertical Cross Section B – B	6
Site Map with Contours of Groundwater Elevation, First Quarter 2011	7
Site Map with Contours of TPHg Concentrations in Groundwater, First Quarter 2011.	8
Site Map with Contours of Benzene Concentrations in Groundwater, First Quarter 2011	9
Site Map with Contours of MTBE Concentrations in Groundwater, First Quarter 2011	10
APPENDICES	
Agency Correspondence – Directive Letter Dated May 8, 2009.....	A
City Of Hayward Utility Maps	B
Boring Logs	C
Historical Soil and Hydropunch Groundwater Analytical Data	D
Prime Properties 3Q10 Groundwater Monitoring Data	E
Hydrographs Of Groundwater Data	F
Geotracker Submittal Receipt.....	G

REVISED SITE CONCEPTUAL MODEL AND PREFERENTIAL PATHWAY STUDY

Former EZ Serve 100877
525 West A Street
Hayward, California
February 28, 2011

1.0 INTRODUCTION

GeoEnviro Services, Inc. has prepared this Site Conceptual Model (SCM) and Preferential Pathway Study (PPS) report on behalf of Restructure Petroleum Marketing Service of California (RPMS) for the LUFT project identified as the former EZ-Serve 100877 located at 525 West A Street, Hayward, California (Site). The location of the Site is shown on Figure 1 - Site Location Map. The SCM and PPS have been prepared as requested by the Alameda County Environmental Health Department (ACEHD) in their letters dated August 16, 2010 and December 9, 2010. A time extension request was approved by the ACEHD in an email dated January 19, 2011. Copies of the ACEHD letters and email are included in Appendix A.

A. LUFT Site Information:

Site Name: EZ SERVE #100877
Global ID: T0600100483
ACEHD File No.: RO0000023
APN: 432-0016-026-03
STR: Township 3 South, Range 2 West, Mt. Diablo Base and Meridian

B. Facility Address:

525 West A Street
Hayward, CA 94541

C. Responsible Party:

Restructure Petroleum Marketing Services of California
1101 Marbella Plaza Dr.
Tampa, FL 33619
Attn: Jack Ceccarelli
Phone: (813) 636-8111 #100
Email: jackc@edifl.com

D. Property Owner/Operator:

Azizolah Kandahari
Himalaya Trading Company, Inc.
5196 Grayhawk Lane
Dublin, CA 94568-7764
Phone: (510) 332-3383
Email: kbchevron96150@sbcglobal.net

E. Lead Enforcement Agency:

Alameda County Health Care Services
Environmental Health Department, Environmental Protection
1131 Harbor Bay Parkway, Suite 250
Alameda, CA 93402-6577
Mark E. Detterman, PF, CEG, Hazardous Materials Specialist
Phone: (510) 567-6876
Email: mark.detterman@acgov.org

F. Environmental Consultant:

GeoEnviro Services, Inc.
P.O. Box 7330
Ventura, CA 93003
Joseph P. Schaaf, PG. CHG, Principal Geologist
Phone: (805) 642-1668
Email: jschaaf@geoenviroservices.com

2.0 ENVIRONMENTAL SETTING

2.1 SITE LOCATION

The Site is an active gasoline service station and contains one building utilized as a convenience store. The previous gas station and USTs were removed in 1990. The site remained an empty lot prior to the new station construction in 2008. The new station included new USTs and system components, new fuel dispenser islands and canopy, and a store building. The Site is located on the northwest corner of West A Street and Garden Street in the City of Hayward (Figure 2). The area to the north and northeast of the Site is utilized for residential housing. Commercial property is located to the east and south of the Site. The property located adjacent to the Site to the west is developed for mixed use as residential and retail/commercial.

The Site is an approximate rectangular parcel measuring approximately 160 feet east to west by approximately 90 feet north to south. The Site contains two active underground storage tanks (USTs) used for gasoline and diesel fuel storage on the western portion of the Site and one UST used for bio-diesel fuel storage on the southern portion of the Site. Two fuel dispenser islands are located in the central portion of the Site. The existing USTs were installed in late 2007 and 2008. A map of the Site is shown on Figure 2. Four USTs were formerly located in the northwestern portion of the Site and were removed in 1990.

2.2 PHYSICAL SETTING

The Site is in the East Bay Area of the San Francisco Bay Area of California. The elevation of the Site is approximately 46 feet above mean sea level. The area slopes gradually to the west. The Hayward Airport is located approximately 0.5 miles west and State Route 880 is located approximately 500 feet east. The nearest surface water includes Lorenzo Creek located

approximately 1.5 mile north and the San Francisco Bay located approximately 2.5 miles to the west.

2.3 GEOLOGY / HYDROGEOLOGY

The Site is located within the San Leandro Cone, a low gradient alluvial fan originating at the mouth of Castro Valley and spreads westward onto the Bay Plain. This alluvial cone overlies marine clay and intertidal deposits of sands and silts. Based upon soil samples collected from previous soil borings, the shallow soils consist of clay, silt, silty sand, and sand to 35 feet below ground surface (bgs), the maximum depth explored during previous assessment activities at the Site.

The most shallow regional aquifer utilized for municipal use is the Newark Aquifer that begins approximately 200 feet bgs. The Newark Aquifer consists of a series of laterally discontinuous lenses of fine to coarse sediments ranging from 10 feet to 100 feet in thickness. The regional hydraulic gradient is to the west towards San Francisco Bay.

Near surface groundwater is present under unconfined conditions. Between February 1992 and January 2011 the depth to groundwater has ranged from a minimum of approximately 10.5 feet (June 1998) to a maximum depth of approximately 21.7 feet (February 1992). During the groundwater monitoring event completed in January 2011, the depth to groundwater ranged from approximately 13.28 feet (MW-13) to 15.71 feet (MW-12). The groundwater flow direction has been variable and ranging in direction from the southeast to the northwest. The predominant flow direction is to the west. The hydraulic groundwater gradient has historically been approximately 0.01 feet per foot or less.

3.0 SUMMARY OF UST REMOVAL, SITE ASSESSMENT, AND REMEDIATION ACTIVITIES

3.1 INITIAL SITE ASSESSMENT, CONVERSE ENVIRONMENTAL CONSULTANTS 1986, 1987

In 1986, Converse Environmental Consultants of California (CECC) conducted an initial environmental site assessment. Three soil borings were drilled to a depth of 30 feet and completed as groundwater monitoring wells MW-1 through MW-3. In June 1997, CECC drilled three additional soil borings to depths ranging between 30 feet and 31 feet and completed these borings as groundwater monitoring wells MW-4 through MW-6.

3.2 UST REMOVAL, 1990

The Site was formerly a Mobil Oil Station with four 10,000-gallon USTs located in the northwest corner of the property (Figure 2). It is our understanding a fuel system leak was discovered in November 1986 as a result of an inventory discrepancy. The USTs were removed in June 1990. During UST removal and site grading activities, monitoring wells MW-2, MW-5, and MW-6 were destroyed and monitoring wells MW-1, MW-3, and MW-4 were damaged.

3.3 ADDITIONAL ASSESSMENT, ASSOCIATES SOILS ANALYSIS, 1992

Additional assessment activities were conducted by Associated Soils Analysis (ASA) in January 1992. Six groundwater monitoring wells were drilled, sampled, and installed (MW-1 through MW-6). Former CECC wells MW-2 and MW-4 were properly abandoned. CECC wells MW-3, MW-5, and MW-6 could not be located. CECC well MW-1 (installed in 1987) was reconstructed and re-designated as MW-1A (well MW-1 referred to herein was installed in 1992 by ASA).

3.4 ADDITIONAL ASSESSMENT, ASSOCIATED SOILS ANALYSIS, 1993

ASA conducted an environmental assessment in June 1993 that included the installation of four additional groundwater monitoring wells to a depth of 30 feet (MW-7 through MW-10).

3.5 ADDITIONAL ASSESSMENT, BROWN AND CALDWELL, 1995

Brown and Caldwell (BAC) conducted an environmental assessment in February 1995 that included the collection of 17 groundwater samples utilizing a Hydropunch in-situ sampler and the installation of four additional groundwater monitoring wells (MW-11 through MW-14). The BAC assessment also included an offsite underground utility survey and a survey of local private, municipal, and agricultural wells located within a ½-mile radius of the site.

The subsurface utility survey identified the presence of a water utility pipeline beneath the sidewalk to the south of the site along A Street and a water main vault in the sidewalk near the southwest corner of the Site. Subsurface electric and sewer lines were identified beneath Garden Street to the east of the Site.

The results of the well survey were not provided in the available BAC draft report reviewed by GESI. A copy of the final report was available for review.

3.6 RISK ASSSSMENT, BROWN AND CALDWELL, 1995

BAC prepared a human health risk assessment for petroleum hydrocarbons in the soil and groundwater in the vicinity of the Site. The initial report was dated May 8, 1995. After receipt of comments from the ACEHD, BAC prepared a response document dated September 12, 1995.

According to the May 1995, BAC report, the risk assessment indicates that current and future use of the site by children and adults does not represent a concern for adverse health effects. The current risk of 1×10^{-6} for adults, associated with inhalation of vapors from groundwater migrating through the soil and into a house, is within USEPA's acceptable risk range. The future risk of 4×10^{-6} for adults, which includes direct contact with soil, is within EPA's acceptable risk range. However, there is an unacceptable risk associated with the residential use of groundwater. The probability of an increase in the individual cancer risk for these pathways is 1×10^{-2} for adults. These risks are well above the range of acceptable risk established for the Superfund program by the EPA.

The information provided in the September 1995 document indicated there was no significant change in the risk results.

3.7 REMEDIATION WELL INSTALLATION, ATC ASSOCIATES, 2002

In June 2002, ATC Associates, Inc. (ATC) installed three dual completion wells (VEAS-1 through VEAS-3) each consisting of a 4-inch diameter PVC soil vapor extraction (SVE) well screened between 5 and 15 feet and a 2-inch diameter groundwater air sparge (GAS) well screened between 28 and 30 feet. ATC also installed a 6-inch diameter groundwater extraction well (EX-1) to a depth of 25 feet using stainless steel casing.

3.8 CORRECTIVE ACTION PLAN, ATC ASSOCIATES, 2002

ATC prepared a Corrective Action Plan (CAP) dated September 4, 2002. The report included the results of soil vapor extraction and groundwater air sparge field pilot testing, and aquifer pumping testing.

The results of SVE and GAS field pilot testing indicated the radius of influence from the SVE was less than the well spacing ranging between 12 to 26 feet while extracting at 10 to 11 inches of mercury and 64 to 100 standard cubic feet per minute (scfm). No zone of influence was observed during the GAS test.

The maximum pumping rate during the 22-hour aquifer pumping test was 11.25 gallons per minute. Drawdown in observation wells ranged from 0.9 ft at a distance of 17 feet to 0.48 feet at a distance of 42 feet. The calculated values of hydraulic conductivity ($K=1,440$ ft/d) and storativity ($S=0.1$) from the test suggest the groundwater extraction was too high to allow exposure of saturated soils in the smear zone for SVE. Groundwater extraction rates to control plume migration were considered to be too high to be economically feasible.

Based upon the results of the SVE / GAS pilot testing and aquifer pumping test, ATC recommended site remediation of the source area be completed by excavation. ATC estimated 3,700 cubic yards of soil to maximum depths ranging from 15 to 20 feet below ground surface would need to be excavated and transported offsite for disposal. ATC recommended oxygen release compound (ORC) be placed in the bottom of the open excavation area to help promote natural biodegradation of residual petroleum hydrocarbons.

3.9 SOIL EXCAVATION DURING UST INSTALLATION ACTIVITIES, 2008

New UST's were installed in 2008 during the construction of a new gasoline service station at the Site. Between January and July 2008 approximately 988 cubic yards of soil were excavated from the west and central areas of the Site and transported offsite for recycling.

3.10 ADDITIONAL SITE ASSESSMENT, GEOENVIRO SERVICES, INC., 2009

On September 24, 2009, GESI collected soil samples from six Geoprobe® direct-push drill holes (SB-1 through SB-6) and Hydropunch groundwater samples from six locations (SB-1 through SB-3, SB-4A, SB-5, and SB-6).

3.11 GROUNDWATER MONITORING ACTIVITIES 1992 TO 2011

Historical groundwater monitoring data are summarized on Tables 3 and 4. Several observations concerning groundwater monitoring data collected between 1992 and 2009 are provided below:

- The groundwater gradient has historically been approximately 0.01 feet per foot or less and ranging in direction from the southeast to the northwest with the predominant flow direction to the west.
- The historical depth to groundwater has generally ranged from approximately 10.5 feet (32.5 feet amsl) in April 1997 to 21.7 feet (21.5 feet amsl) in February 1992.
- There are 15 groundwater monitoring wells present at the project site (MW-1A, MW-1 through MW-14). Five of these 15 wells are no longer accessible and have not been recently located (MW-6, MW-8, MW-9, MW-10, and MW-11). Well MW-13 was recently located during field reconnaissance in January 2011. One well (MW-1A) contains a cracked casing and is filled with dirt. Well MW-2 was properly abandoned in March 2006 in preparation of site development.
- During the most recent groundwater monitoring activities on January 25, 2011, the average depth to groundwater in onsite wells was 14.6 feet.
- During groundwater sampling activities on January 25, 2011 well MW-1 contained the maximum dissolved phase concentration of total petroleum hydrocarbons as gasoline (TPHg) and benzene of 3,530 micrograms per liter (ug/L) and 30 ug/L, respectively. Well MW-4 contained the highest concentration of MTBE of 161 ug/L.

4.0 PREFERENTIAL PATHWAY STUDY

4.1 UTILTY SURVEY

GESI obtained subsurface utility maps from the City of Hayward for water mains, storm drains, and sanitary sewer pipelines. Copies of the maps are included in Appendix B. Subsurface utilities in the vicinity are summarized in Figure 3.

As shown on Figure 3, subsurface utilities including cable TV, electric, and natural gas are present beneath the sidewalk located along West A Street to the south of the site. Water supply, sewer, and storm drain pipeline are located beneath West A Street. A storm drain surface outlet is present near the southwest corner of the Site on West A Street.

Upon review of the subsurface utilities present in the vicinity of the site, pipelines and drains located to the south of the site could provide preferential pathways for the migration of dissolved phase hydrocarbons from the site.

REVISED SITE CONCEPTUAL MODEL AND PREFERENTIAL PATHWAY STUDY

FORMER EZ-SERVE 100877, 525 WEST A STREET, HAYWARD, CA

FEBRUARY 2011

The results of the preferential pathway study indicate West A Street and sidewalk along the southern boundary of the Site are major east-west subsurface utility corridors. Typically, utility piping routes for water, gas, electric, and cable TV are relatively shallow (less than 5 feet below grade). Pipeline routes for sanitary sewer and storm drain can be at greater depths as gravity is used to allow fluids to flow in these pipelines. For these utility piping routes to become preferential pathways for hydrocarbons to migrate in the *vadose zone*, they would need to be located in close proximity to the source of the former UST/fuel line leak at the Site. As shown on Figure 2, the former USTs were located in the northwest corner of the Site and utility piping routes to the south of the site would not be in close proximity to the former source.

Subsurface pipeline routes in the capillary fringe and saturated zone could be considered preferential pathways for fluid migration from the former source. As the known historical depth to groundwater has ranged between approximately 10.5 feet and 21.7 feet below grade, piping routes for water, gas, electric, and cable would be too shallow to provide preferential pathways. The depth to the sanitary sewer and storm drain beneath West A Street is not known and could potentially provide preferential pathways for fluid migration if these pipelines are greater than 10 feet below grade.

4.2 WELL SURVEY

A listing of known groundwater wells within a ½-mile of the Site was provided by the Alameda County Public Works Agency (ACPWA). The listing included the locations of domestic, irrigation, industrial, cathodic, and test wells. Test wells included geotechnical borings, monitoring wells, extraction/vapor wells, and piezometers.

In review of the well listing, special attention was given to wells described as being utilized for domestic water supply. Twelve domestic supply wells were identified as being present within a ½-mile of the Site. The majority of these wells are located to the north and east (general up-gradient direction) at distances greater than 2,000 feet from the Site. The closest domestic supply well is located approximately 1,800 feet to the northwest. Based on the distance, the dissolved phase plume located in the shallow unconfined zone is not likely to migrate to these well locations.

There are additional groundwater wells used for irrigation in the vicinity of the Site. Based upon the listing, the closest irrigation well is located approximately 900 feet to the north-northwest.

The ACPWA listing did not include irrigation wells located to the south-southwest along Victory Drive. As described in reports prepared by Hydro Analytics of El Cerrito, California for the Prime Properties LUFT site located at 580 West A Street, Hayward, CA, there are two irrigation wells located immediately to the south of the Prime Properties location. The Khan well (21943 Victory Drive) is located approximately 300 feet from the EZ Serve site and the Lagomarsino well (21961 Victory Drive) is located approximately 330 feet from the EZ Serve site. Pumping from these wells could increase local gradient and cause groundwater to preferentially migrate in that direction. Hydro Analytics conducted groundwater sampling of these two irrigation wells in 2009 and 2010. Sample data indicates concentrations of TPHg (<50 ug/l to 63 ug/l) and

ethylbenzene (<0.5 to 1.7 ug/l) have been detected in the water sample collected from the 21961 Victory Drive well (Lagomarsino) and concentrations of TPHg (<50 to 52 ug/l) and MTBE (28 to 68 ug/l) have been detected in the 21943 Victory Drive well (Khan).

5.0 EXTENT OF IMPACTS IN SOIL AND GROUNDWATER

5.1 EXTENT OF IMPACTS IN SOIL

To evaluate the extent of impacts in the soil, east-west and north-south vertical lithological cross sections were constructed using available soil boring logs and soil sample laboratory analytical data. Soil boring logs for the Site are included in Appendix C. Data tables of previous soil sample analytical data are included in Appendix D. The locations of the cross sections are shown on Figure 3. The cross sections are shown on Figures 4 and 5. As shown on the cross sections, alluvial materials are present beneath the site. The majority of these materials consist of clay and silty clay. Discontinuous layers of silt and clayey silt are present in the upper 10 feet. Several thin layers consisting of silty sand with minor sand zones are present at between approximately 10 feet and 22 feet. Shallow, unconfined groundwater is present at 14.7 feet as measured in January 2011. As previously discussed, groundwater has fluctuated between approximately 10.5 feet and 21.7 feet between 1992 and 2010. The predominant groundwater flow is towards the west at gradient on the order of 0.01 ft/ft or less.

The majority of the soil samples analyzed contained concentrations of TPHg of <100 mg/kg. With the exception of the soil samples collected from well bore MW-4, no significant soil impacts were detected onsite at depths less than 15 feet. Petroleum hydrocarbons were detected in the soil sample collected from MW-4 at a depth of 6.0-6.5 feet indicating this well was close to a near surface source such as a former fuel line leak. The highest concentrations of petroleum hydrocarbons were detected in soil samples collected from depths ranging between 20 and 25 feet. The highest TPH concentration detected in the soil was from sample VEAS-1-20' (670 mg/kg). The highest benzene concentration detected in soil was from sample MW-4-16-16.5' (2.7 mg/kg). It should be noted that soil sampling was limited to a depth of 15 feet or 16-16.5 feet during the installation of well bores MW-1 through MW-14. Soil data from wells VEAS-1 through VEAS-3 and EX-1 indicate there are no significant concentrations of petroleum hydrocarbons in the soil below approximately 25 feet in depth (slightly greater than the known historical groundwater fluctuation ranging between approximately 10.5 feet and 21.7 feet in depth).

As shown on cross section A-A', petroleum hydrocarbons have migrated laterally below the adjacent property to the west in soils close to the water table. Soil impacts on the adjacent property are expected as the former USTs were located in the northwest corner of the Site and the predominant groundwater flow direction is to the west. On the adjacent property, soil samples collected from SB-2 and SB-5 contained concentrations of TPHg of 101 mg/kg and 102 mg/kg, respectively. Soil samples collected from other soil borings on the adjacent property (SB-3, SB-4, and SB-6) contained lower concentrations indicating the approximate lateral extent of hydrocarbons to the west is generally defined.

As shown on cross section B-B', no significant concentrations of petroleum hydrocarbons were detected in soil samples collected from well bores to the north and south of well MW-4. However as discussed above, soil sampling from the majority of these well bores was limited to 15 feet or 16-16.5 feet. Based upon groundwater sample results from wells MW-1 and MW-5, it is likely soil impacts maybe present on the southern and/or southwestern portion of the site at depths up to approximately 25 feet.

5.2 EXTENT OF IMPACTS IN GROUNDWATER

Historical fluid monitoring data and groundwater sample laboratory analytical data are summarized on Tables 1 and 2. Hydropunch groundwater sample results collected by BAC in February 1995 and by GESI in September 2009 are summarized on data tables included in Appendix D. Groundwater gradient maps and dissolved phase iso-concentration contour maps as measured/sampled in January 2011 are included on Figures 7 through 10.

As shown on Figure 7, the groundwater gradient is towards the southwest and the gradient is a very flat 0.005 ft/ft. Figure 7 includes a rose diagram depicting the historical flow direction. As shown by the rose diagram, the historical trend is to the west.

Figures 8 and 9 show iso-concentrations contours of dissolved phase TPHg and benzene as sampled in January 2011. As shown on these maps, the highest concentrations of TPHg and benzene are in well MW-1 located on the southwest corner of the Site. Dissolved phase MTBE ion-concentrations contours are shown on Figure 10. As shown on Figure 10, the highest concentration of MTBE is in well MW-4 located on the north-central portion of the site.

Based upon the predominant groundwater flow and groundwater concentrations, the extent dissolved phase hydrocarbons and MTBE is not well defined to the southwest or west. Previous Hydropunch sample data and well MW-10 (paved over) data indicates groundwater impacts extend to the west onto the adjacent property and to the south beneath West A Street.

Available groundwater data from Prime Properties (580 West A Street) located southwest of the site indicates the hydrocarbon plumes from these two sites maybe co-mingled. A copy of the most recent groundwater data from the Prime Properties site is included in Appendix E. Groundwater gradient information included in the Prime Properties report indicates the groundwater flows toward irrigation wells located on the properties to the south along Victory Drive. Concentrations of petroleum hydrocarbons and/or MTBE detected in the irrigation wells indicate they are extracting groundwater that is in communication to the shallow unconfined water table aquifer. It is reasonable to conclude the use of these irrigation wells is acting to pull the hydrocarbon plumes from the Prime Properties and possibly the EZ Serve site in this direction.

Concentrations in the groundwater at the EZ Serve site have steadily decreased since groundwater monitoring was initiated in 1992. Benzene concentrations vs. time in groundwater samples collected from wells MW-1, MW-4, and MW-5 are plotted on data graphs along with depth to groundwater data vs. time. These graphs are included in Appendix F.

6.0 SENSITIVE RECEPTORS

6.1 SENSITIVE RECEPTORS

The Site is an active gas station and the majority of the site is paved with concrete. There are no plans to change the property use. Identified impacts to soil and groundwater are generally located deeper than 10 feet below ground surface. The properties to the north and west are developed for residential use. Offsite exposure through vapor intrusion would be limited in risk as the soil impacts are at greater depths (15 to 25 feet in depth) and of lesser concentration. The presence of low permeable clayey soil further reduces vapor intrusion risk. GESI concludes potential receptors of contaminants originating at the Site are limited to groundwater use and workers exposure during future excavation activities.

6.2 SOIL RECEPTORS

Soil excavation activities are not likely to be completed onsite in the near future as a new gasoline service station was constructed in 2008. Excavation work could be required if the existing USTs were removed for replaced. Human exposure to impacted soil can be controlled using basic personal exposure precautions such as Site ventilation, proper personal protective equipment (PPE), and proper excavation/waste handling. These basic precautions would reduce the risk of exposure to the residual hydrocarbon concentrations in soil.

6.3 GROUNDWATER RECEPTORS

6.3.1 Human Receptor

Petroleum hydrocarbons in groundwater are present in the central/south/west portions of the Site and have migrated offsite to the south/southwest. The physical depth of the groundwater (14.5 feet below ground surface) decreases the likelihood that impacted groundwater would come in contact with surface waters or that any potential subsurface excavation would result in exposure to impacted groundwater. There are no surface water bodies within a ½-mile of the Site. In review of groundwater wells used for domestic supply, there are no wells likely to be affected by the dissolved phase hydrocarbon plume originating from the Site.

6.3.2 Domestic/Irrigation Wells

The most likely route for human exposure to impacted groundwater originating from the Site would be from the extraction of groundwater by an irrigation well. As discussed above, there are two irrigation wells located less than 350 feet to the south. It is already known that these wells are impacted with low concentrations of petroleum hydrocarbons and/or MTBE. The source of hydrocarbon in these wells can be contributed to releases at the Prime Properties site at 580 West A Street and possibly from the former EZ Serve Station release at 525 West A Street or both. GESI concludes these wells provide a pathway for the migration of contaminants through the groundwater to potential sensitive human or environmental receptors.

7.0 CONCLUSIONS

Based upon the development of the Site Conceptual Model and findings of the Preferential Pathway Study, GESI provides the following conclusions.

- Subsurface utilities beneath West A Street could potentially provide preferential pathways for the migration of petroleum hydrocarbons and/or fuel oxygenates in the groundwater.
- Previous assessment activities indicate petroleum hydrocarbons and fuel oxygenates have migrated offsite to the west in the soil and to the west and southwest in the groundwater.
- Operation of irrigation wells to the south of Prime Properties (580 West A Street) may have resulted in the movement of hydrocarbons plumes from the Prime Properties and possibly the EZ Serve site towards the south.
- The irrigation wells to the south of the Prime Properties LUFT site may provide a pathway for the migration of contaminants through the groundwater to potential sensitive human or environmental receptors.
- As described in the approved work plan addendum dated November 18, 2010, field activities for the identification of missing wells should be implemented as soon as possible. An encroachment permit application to access well locations on West A Street is in the process of being obtained from the City of Hayward.
- The need for additional assessment to the south and west will be based upon the results of the well identification activities.

8.0 LIMITATIONS

This report has been prepared for the sole benefit of Restructure Petroleum Marketing Services for submittal to the Alameda County Department of Environmental Health. No other persons may rely on the findings of this report without the expressed written consent of the client and GeoEnviro Services, Inc. In performing our professional services, we have attempted to apply present engineering and scientific judgment and use a level of effort consistent with the standard of practice measured on the date of work and in locale of the Site for similar type studies. GeoEnviro Services, Inc makes no warranty, express or implied.

The analyses and interpretations presented in this report have been developed based on the results from the review of existing information pertaining to the Site, soil and groundwater sampling at discrete locations at the Site, and the results from the laboratory analyses of soil and groundwater samples. It should be recognized that soil contamination can vary between sampling locations and between areas

TABLES

TABLE 1
FLUID LEVEL MONITORING DATA
February 1992 through January 2011
EZ Serve 100877, 525 West A Street, Hayward, CA

Well ID	Date Monitored	Top of Casing Elevation* (feet)	Screen Interval (fbg)	Free Product	Depth to Water (feet)	Groundwater Elevation (feet)
MW-1	2/5/92	41.75	15-29	--	20.82	20.93
MW-1	9/11/92	41.75	15-29	--	20.08	21.67
MW-1	12/22/92	41.75	15-29	--	19.79	21.96
MW-1	3/3/93	41.75	15-29	--	16.23	25.52
MW-1	6/23/93	41.75	15-29	--	16.86	24.89
MW-1	9/30/93	41.75	15-29	--	18.04	23.71
MW-1	2/6/94	41.75	15-29	--	18.15	23.60
MW-1	5/2/94	41.75	15-29	--	17.26	24.49
MW-1	7/1/94	41.75	15-29	--	17.60	24.15
MW-1	9/20/94	41.75	15-29	--	20.59	21.16
MW-1	12/5/92	41.75	15-29	--	17.83	23.92
MW-1	3/10/95	41.75	15-29	--	14.67	27.08
MW-1	3/15/95	41.75	15-29	--	14.43	27.32
MW-1	9/23/96	41.75	15-29	--	14.92	26.83
MW-1	12/4/96	41.75	15-29	--	15.61	26.14
MW-1	4/8/97	41.75	15-29	--	13.25	28.50
MW-1	6/30/97	41.75	15-29	--	14.68	27.07
MW-1	11/25/97	41.75	15-29	--	15.99	25.76
MW-1	6/1/98	41.75	15-29	--	9.98	31.77
MW-1	6/14/01	41.75	15-29	--	15.05	26.70
MW-1	11/7/01	41.75	15-29	--	16.31	25.44
MW-1	1/30/02	41.75	15-29	--	14.15	27.60
MW-1	5/29/02	41.75	15-29	--	14.55	27.20
MW-1	8/14/02	41.75	15-29	--	15.56	26.19
MW-1	11/15/02	41.75	15-29	--	16.10	25.65
MW-1	10/25/04	41.75	15-29	--	15.99	25.76
MW-1	12/23/04	41.75	15-29	--	15.64	26.11
MW-1	2/25/05	41.75	15-29	--	12.79	28.96
MW-1	5/19/05	41.75	15-29	--	12.27	29.48
MW-1	9/15/05	41.75	15-29	--	14.30	27.45
MW-1	3/20/06	41.75	15-29	--	11.44	30.31
MW-1	5/25/06	41.75	15-29	--	11.05	30.70
MW-1	8/23/06	41.75	15-29	--	12.75	29.00
MW-1	3/14/07	41.75	15-29	--	13.12	28.63
MW-1	6/11/07	41.75	15-29	--	14.42	27.33
MW-1	8/1/07	41.75	15-29	--	14.97	26.78
MW-1	2/27/08	41.75	15-29	--	13.35	28.40
MW-1	5/13/08	41.75	15-29	--	14.51	27.24
MW-1	8/27/08	41.75	15-29	--	15.37	26.38
MW-1	11/18/08	41.75	15-29	--	15.88	25.87
MW-1	3/11/09	41.75	15-29	--	13.65	28.10
MW-1	9/22/09	41.75	15-29	--	16.41	25.34
MW-1	3/9/10	41.75	15-29	--	13.84	27.91
MW-1	9/9/10	41.75	15-29	--	14.96	26.79
MW-1	1/25/11	41.75	15-29	--	13.85	27.90

TABLE 1
FLUID LEVEL MONITORING DATA
February 1992 through January 2011
EZ Serve 100877, 525 West A Street, Hayward, CA

Well ID	Date Monitored	Top of Casing Elevation* (feet)	Screen Interval (fbg)	Free Product	Depth to Water (feet)	Groundwater Elevation (feet)
MW-1A	06/23/93	43.40	--	0.21	17.80	25.75
MW-1A	09/30/93	43.40	--	--	--	--
MW-1A	02/06/94	43.40	--	--	18.89	24.51
MW-1A	05/02/94	43.40	--	0.09	18.35	38.40
MW-1A	07/01/94	43.40	--	--	18.45	24.95
MW-1A	09/20/94	43.40	--	0.22	21.72	21.84
MW-1A	12/05/94	43.40	--	0.07	18.87	24.58
MW-1A	03/10/95	43.40	--	--	15.83	27.57
MW-1A	03/15/95	43.40	--	0.05	15.55	27.89
MW-1A	09/23/96	43.40	--	0.01	16.00	27.41
MW-1A	12/04/96	43.40	--	--	16.55	26.85
MW-1A	04/08/97	43.40	--	SHEEN	14.15	29.25
MW-1A	06/30/97	43.40	--	--	15.57	27.83
MW-1A	11/25/97	43.40	--	--	16.91	26.49
MW-1A	06/01/98	43.40	--	--	10.78	32.62
MW-1A	06/14/01	43.40	--	0.01	15.93	27.48
MW-1A	11/07/01	43.40	--	--	17.32	26.08
MW-1A	01/30/02	43.40	--	--	15.05	28.35
MW-1A	05/29/02	43.40	--	--	15.49	27.91
MW-1A	08/14/02	43.40	--	--	16.50	26.90
MW-1A	11/15/02	43.40	--	--	17.04	26.36
MW-1A	10/25/04	43.40	--	--	16.90	26.50
MW-1A	12/23/04	43.40	--	--	16.60	26.80
MW-1A	02/25/05	43.40	--	--	13.75	29.65
MW-1A	05/19/05	43.40	--	--	13.12	30.28
MW-1A	09/15/05	43.40	--	--	15.16	28.24
MW-1A	11/10/05	43.40	--	--	15.78	27.62
MW-1A	03/20/06	43.40	--	--	12.64	30.76
MW-1A	05/25/06	43.40	--	--	11.85	31.55
MW-1A	08/23/06	43.40	--	--	13.55	29.85
MW-1A	03/14/07	43.40	--	--	14.00	29.40
MW-1A	06/12/07	43.40	--	--	15.30	28.10
MW-1A	08/01/07	43.40	--	--	15.84	27.56
MW-1A	02/27/08	43.40	--	--	14.10	29.30
MW-1A	05/13/08	43.40	Well Not Accessable	--	--	--
MW-1A	08/27/08	43.40	Well Dry	--	--	--
MW-1A	11/18/08	43.40	Well Dry	--	--	--
MW-1A	03/11/09	43.40	Well Dry	--	--	--
MW-1A	09/22/09	43.40	Well Dry	--	--	--
MW-1A	03/09/10	43.40	Well Dry	--	--	--
MW-1A	09/09/10	43.40	Well Dry	--	--	--
MW-1A	01/25/11	43.40	Well Dry	--	--	--
MW-2	02/05/92	43.26	15-29	--	22.35	20.91
MW-2	09/11/92	43.26	15-29	--	21.67	21.59
MW-2	12/22/92	43.26	15-29	--	21.39	21.87
MW-2	03/03/93	43.26	15-29	--	17.75	25.51

TABLE 1
FLUID LEVEL MONITORING DATA
February 1992 through January 2011
EZ Serve 100877, 525 West A Street, Hayward, CA

Well ID	Date Monitored	Top of Casing Elevation* (feet)	Screen Interval (fbg)	Free Product	Depth to Water (feet)	Groundwater Elevation (feet)
MW-2	06/23/93	43.26	15-29	--	18.42	24.84
MW-2	09/30/93	43.26	15-29	--	19.63	23.63
MW-2	02/06/94	43.26	15-29	--	19.61	23.65
MW-2	05/02/94	43.26	15-29	--	19.84	23.42
MW-2	07/01/94	43.26	15-29	--	19.18	24.08
MW-2	09/20/94	43.26	15-29	--	22.17	21.09
MW-2	12/06/94	43.26	15-29	--	19.37	23.89
MW-2	03/10/95	43.26	15-29	--	16.33	26.93
MW-2	03/15/95	43.26	15-29	--	16.89	26.37
MW-2	09/23/96	43.26	15-29	--	16.61	26.65
MW-2	12/04/96	43.26	15-29	--	17.19	26.07
MW-2	04/08/97	43.26	15-29	--	14.86	28.40
MW-2	06/30/97	43.26	15-29	--	16.28	26.98
MW-2	11/25/97	43.26	15-29	--	17.56	25.70
MW-2	06/01/98	43.26	15-29	--	11.58	31.68
MW-2	06/14/01	43.26	15-29	--	16.63	26.63
MW-2	11/07/01	43.26	15-29	--	17.85	25.41
MW-2	01/30/02	43.26	15-29	--	15.65	27.61
MW-2	05/29/02	43.26	15-29	--	16.12	27.14
MW-2	08/14/02	43.26	15-29	--	17.20	26.06
MW-2	11/15/02	43.26	15-29	--	17.63	25.63
MW-2	10/25/04	43.26	15-29	--	17.53	25.73
MW-2	12/23/04	43.26	15-29	--	17.15	26.11
MW-2	02/25/05	43.26	15-29	--	14.30	28.96
MW-2	05/19/05	43.26	15-29	--	13.81	29.45
MW-2	09/15/05	43.26	15-29	Inaccessible due to temporary habitat		
MW-2	11/10/05	43.26	15-29	--	16.39	26.87
MW-2	03/20/06	43.26	15-29	--	13.00	30.26
MW-2	05/25/06	43.26	15-29	Destroyed on March 2, 2006		
MW-3	02/05/92	43.89	15-29	--	21.85	22.04
MW-3	09/11/92	43.89	15-29	--	21.13	22.76
MW-3	12/22/92	43.89	15-29	--	20.88	23.01
MW-3	03/03/93	43.89	15-29	--	17.29	26.60
MW-3	06/23/93	43.89	15-29	--	17.88	26.01
MW-3	09/30/93	43.89	15-29	--	19.18	24.71
MW-3	02/06/94	43.89	15-29	--	19.21	24.68
MW-3	05/02/94	43.89	15-29	--	18.30	25.59
MW-3	07/01/94	43.89	15-29	--	18.63	25.26
MW-3	09/20/94	43.89	15-29	--	21.64	22.25
MW-3	12/06/94	43.89	15-29	--	19.15	24.74
MW-3	03/10/95	43.89	15-29	--	16.33	27.56
MW-3	03/15/95	43.89	15-29	--	16.89	27.00
MW-3	09/23/96	43.89	15-29	--	16.11	27.78
MW-3	12/04/96	43.89	15-29	--	16.63	27.26
MW-3	04/08/97	43.89	15-29	--	14.25	29.64
MW-3	06/30/97	43.89	15-29	--	15.70	28.19

TABLE 1
FLUID LEVEL MONITORING DATA
February 1992 through January 2011
EZ Serve 100877, 525 West A Street, Hayward, CA

Well ID	Date Monitored	Top of Casing Elevation* (feet)	Screen Interval (fbg)	Free Product	Depth to Water (feet)	Groundwater Elevation (feet)
MW-3	11/25/97	43.89	15-29	--	16.99	26.90
MW-3	06/01/98	43.89	15-29	--	--	--
MW-3	06/14/01	43.89	15-29	--	16.02	27.87
MW-3	11/07/01	43.89	15-29	--	17.33	26.56
MW-3	01/30/02	43.89	15-29	--	15.10	28.79
MW-3	05/29/02	43.89	15-29	--	15.63	28.26
MW-3	08/14/02	43.89	15-29	--	16.63	27.26
MW-3	11/15/02	43.89	15-29	--	17.10	26.79
MW-3	10/25/04	43.89	15-29	--	17.01	26.88
MW-3	12/20/04	43.89	15-29	--	16.64	27.25
MW-3	02/25/05	43.89	15-29	Could not locate, VEAS-2 sampled instead		
MW-3	05/19/05	43.89	15-29	Could not locate, VEAS-2 sampled instead		
MW-3	09/15/05	43.89	15-29	--	Couldn't locate	--
MW-3	11/10/05	43.89	15-29	--	Couldn't locate	--
MW-3	03/20/06	43.89	15-29	--	12.44	31.45
MW-3	05/25/06	43.89	15-29	--	12.05	31.84
MW-3	08/23/06	43.89	15-29	--	13.75	30.14
MW-3	03/14/07	43.89	15-29	--	14.11	29.78
MW-3	06/12/07	43.89	15-29	--	15.43	28.46
MW-3	08/01/07	43.89	15-29	--	15.97	27.92
MW-3	02/27/08	43.89	15-29	--	14.40	29.49
MW-3	05/13/08	43.89	15-29	--	15.52	28.37
MW-3	08/27/08	43.89	15-29	--	16.79	27.10
MW-3	11/18/08	43.89	15-29	--	17.30	26.59
MW-3	03/11/09	43.89	15-29	--	15.37	28.52
MW-3	09/22/09	43.89	15-29	--	17.86	26.03
MW-3	03/09/10	43.89	15-29	--	15.11	28.78
MW-3	09/09/10	43.89	15-29	--	16.39	27.50
MW-3	01/25/11	43.89	15-29	--	15.19	28.70
MW-4	2/5/92	42.76	15-29	--	21.31	21.45
MW-4	9/11/92	42.76	15-29	--	20.62	22.14
MW-4	12/22/92	42.76	15-29	--	20.37	22.39
MW-4	3/3/93	42.76	15-29	--	16.78	25.98
MW-4	6/23/93	42.76	15-29	--	17.45	25.31
MW-4	9/30/93	42.76	15-29	--	18.64	24.12
MW-4	2/6/94	42.76	15-29	--	18.59	24.17
MW-4	5/2/94	42.76	15-29	--	17.81	24.95
MW-4	7/1/94	42.76	15-29	--	18.13	24.63
MW-4	9/20/94	42.76	15-29	--	21.13	21.63
MW-4	12/6/94	42.76	15-29	--	18.36	24.40
MW-4	3/10/95	42.76	15-29	--	15.25	27.51
MW-4	3/15/95	42.76	15-29	--	14.89	27.87
MW-4	9/23/96	42.76	15-29	--	15.56	27.20
MW-4	12/4/96	42.76	15-29	--	16.11	26.65
MW-4	4/8/97	42.76	15-29	--	13.73	29.03
MW-4	6/30/97	42.76	15-29	--	15.19	27.57

TABLE 1
FLUID LEVEL MONITORING DATA
February 1992 through January 2011
EZ Serve 100877, 525 West A Street, Hayward, CA

Well ID	Date Monitored	Top of Casing Elevation* (feet)	Screen Interval (fbg)	Free Product	Depth to Water (feet)	Groundwater Elevation (feet)
MW-4	11/25/97	42.76	15-29	--	16.49	26.27
MW-4	6/1/98	42.76	15-29	--	10.42	32.34
MW-4	6/14/01	42.76	15-29	--	15.55	27.21
MW-4	11/7/01	42.76	15-29	--	16.81	25.95
MW-4	1/30/02	42.76	15-29	--	14.60	28.16
MW-4	5/29/02	42.76	15-29	--	15.14	27.62
MW-4	8/14/02	42.76	15-29	--	16.07	26.69
MW-4	11/15/02	42.76	15-29	--	16.61	26.15
MW-4	10/25/04	42.76	15-29	--	16.50	26.26
MW-4	12/23/04	42.76	15-29	--	16.20	26.56
MW-4	2/25/05	42.76	15-29	--	13.30	29.46
MW-4	5/19/05	42.76	15-29	--	12.74	30.02
MW-4	9/15/05	42.76	15-29	--	14.80	27.96
MW-4	11/10/06	42.76	15-29	--	15.45	27.31
MW-4	3/20/06	42.76	15-29	--	11.93	30.83
MW-4	5/25/06	42.76	15-29	--	11.49	31.27
MW-4	8/23/06	42.76	15-29	--	13.23	29.53
MW-4	3/14/07	42.76	15-29	--	13.65	29.11
MW-4	6/12/07	42.76	15-29	--	14.92	27.84
MW-4	8/1/07	42.76	15-29	--	15.48	27.28
MW-4	2/27/08	42.76	15-29	--	Could not locate well	
MW-4	5/13/08	42.76	15-29	--	15.02	27.74
MW-4	8/27/08	42.76	15-29	--	16.28	26.48
MW-4	11/18/08	42.76	15-29	--	16.81	25.95
MW-4	3/11/09	42.76	15-29	--	14.87	27.89
MW-4	9/22/09	42.76	15-29	--	17.33	25.43
MW-4	3/9/10	42.76	15-29	--	14.60	28.16
MW-4	9/9/10	42.76	15-29	--	15.88	26.88
MW-4	1/25/11	42.76	15-29	--	14.47	28.29
MW-5	2/5/92	42.10	15-29	--	20.93	21.17
MW-5	9/11/92	42.10	15-29	--	20.27	21.83
MW-5	12/22/92	42.10	15-29	--	19.99	22.11
MW-5	3/3/93	42.10	15-29	--	16.49	25.61
MW-5	6/23/93	42.10	15-29	--	17.02	25.08
MW-5	9/30/93	42.10	15-29	--	18.25	23.85
MW-5	2/6/94	42.10	15-29	--	18.26	23.84
MW-5	5/2/94	42.10	15-29	--	17.50	24.60
MW-5	7/1/94	42.10	15-29	--	17.79	24.31
MW-5	9/20/94	42.10	15-29	--	20.77	21.33
MW-5	15/5/92	42.10	15-29	--	18.02	24.08
MW-5	3/10/95	42.10	15-29	--	14.93	27.17
MW-5	3/15/95	42.10	15-29	--	14.70	27.40
MW-5	9/23/96	42.10	15-29	--	15.19	26.91
MW-5	12/4/96	42.10	15-29	--	15.78	26.32
MW-5	4/8/97	42.10	15-29	--	13.39	28.71
MW-5	6/30/97	42.10	15-29	--	14.83	27.27

TABLE 1
FLUID LEVEL MONITORING DATA
February 1992 through January 2011
EZ Serve 100877, 525 West A Street, Hayward, CA

Well ID	Date Monitored	Top of Casing Elevation* (feet)	Screen Interval (fbg)	Free Product	Depth to Water (feet)	Groundwater Elevation (feet)
MW-5	11/25/97	42.10	15-29	--	16.14	25.96
MW-5	6/1/98	42.10	15-29	--	10.10	32.00
MW-5	6/14/01	42.10	15-29	--	15.19	26.91
MW-5	11/7/01	42.10	15-29	--	16.47	25.63
MW-5	1/30/02	42.10	15-29	--	14.27	27.83
MW-5	5/29/02	42.10	15-29	--	14.73	27.37
MW-5	8/14/02	42.10	15-29	--	15.73	26.37
MW-5	11/15/02	42.10	15-29	--	16.27	25.83
MW-5	10/25/04	42.10	15-29	--	16.15	25.95
MW-5	12/23/04	42.10	15-29	--	15.88	26.22
MW-5	2/25/05	42.10	15-29	--	12.97	29.13
MW-5	5/19/05	42.10	15-29	--	12.48	29.62
MW-5	9/15/05	42.10	15-29	--	15.47	26.63
MW-5	11/10/08	42.10	15-29	--	15.03	27.07
MW-5	3/20/06	42.10	15-29	--	11.79	30.31
MW-5	5/25/06	42.10	15-29	--	11.15	30.95
MW-5	8/23/06	42.10	15-29	--	12.88	29.22
MW-5	3/14/07	42.10	15-29	--	13.28	28.82
MW-5	6/11/07	42.10	15-29	--	14.56	27.54
MW-5	8/1/07	42.10	15-29	--	15.11	26.99
MW-5	2/27/08	42.10	15-29	--	13.49	28.61
MW-5	5/13/08	42.10	15-29	--	14.64	27.46
MW-5	8/27/08	42.10	15-29	--	15.93	26.17
MW-5	11/18/08	42.10	15-29	--	16.43	25.67
MW-5	3/11/09	42.10	15-29	--	14.53	27.57
MW-5	9/22/09	42.10	15-29	--	16.95	25.15
MW-5	3/9/10	42.10	15-29	--	14.25	27.85
MW-5	9/9/10	42.10	15-29	--	15.50	26.60
MW-5	1/25/11	42.10	15-29	--	14.42	27.68
MW-6	02/05/92	42.33	15-29	--	21.29	21.04
MW-6	09/11/92	42.33	15-29	--	20.56	21.77
MW-6	12/22/92	42.33	15-29	--	20.31	22.02
MW-6	03/03/93	42.33	15-29	--	16.83	25.50
MW-6	06/23/93	42.33	15-29	--	17.30	25.03
MW-6	09/30/93	42.33	15-29	--	19.05	23.28
MW-6	02/06/94	42.33	15-29	--	18.55	23.78
MW-6	05/02/94	42.33	15-29	--	17.74	24.59
MW-6	07/01/94	42.33	15-29	--	18.09	24.24
MW-6	09/20/94	42.33	15-29	--	21.05	21.28
MW-6	12/06/94	42.33	15-29	--	18.33	24.00
MW-6	03/10/95	42.33	15-29	--	15.35	26.98
MW-6	03/15/95	42.33	15-29	--	14.91	27.42
MW-6	09/23/96	42.33	15-29	--	15.50	26.83
MW-6	12/04/96	42.33	15-29	--	16.06	26.27
MW-6	04/08/97	42.33	15-29	--	13.64	28.69
MW-6	06/30/97	42.33	15-29	--	15.08	27.25

TABLE 1
FLUID LEVEL MONITORING DATA
February 1992 through January 2011
EZ Serve 100877, 525 West A Street, Hayward, CA

Well ID	Date Monitored	Top of Casing Elevation* (feet)	Screen Interval (fbg)	Free Product	Depth to Water (feet)	Groundwater Elevation (feet)
MW-6	11/25/97	42.33	15-29	--	16.40	25.93
MW-6	06/01/98	42.33	15-29	--	10.31	32.02
MW-6	06/14/01	42.33	15-29	--	15.46	26.87
MW-6	11/07/01	42.33	15-29	--	16.71	25.62
MW-6	01/30/02	42.33	15-29	--	14.60	27.73
MW-6	05/29/02	42.33	15-29	--	14.99	27.34
MW-6	08/14/02	42.33	15-29	--	16.03	26.30
MW-6	11/15/02	42.33	15-29	--	16.53	25.80
MW-6	10/25/04	42.33	15-29	--	16.43	25.90
MW-6	12/23/04	42.33	15-29	--	16.12	26.21
MW-6	02/25/05	42.33	15-29	--	13.13	29.20
MW-6	05/19/05	42.33	15-29	--	12.61	29.72
MW-6	09/15/05	42.33	15-29	--	14.69	27.64
MW-6	11/10/05	42.33	15-29	--	15.30	27.03
MW-6	03/20/06	42.33	15-29	--	11.88	30.45
MW-6	05/25/06	42.33	15-29	--	11.38	30.95
MW-6	08/23/06	42.33	15-29	--	13.10	29.23
MW-6	03/14/07	42.33	15-29	--	13.52	28.81
MW-6	06/12/07	42.33	15-29	--	14.80	27.53
MW-6	08/01/07	42.33	15-29	--	15.38	26.95
MW-6	02/27/08	42.33	15-29	--	13.79	28.54
MW-6	05/13/08	42.33	15-29	--	14.93	27.40
MW-6	08/27/08	42.33	15-29	--	Well Not Accessable	
MW-6	11/18/08	42.33	15-29	--	Well Not Accessable	
MW-6	03/11/09	42.33	15-29	--	Well Not Accessable	
MW-6	09/22/09	42.33	15-29	--	Well Not Accessable	
MW-6	03/09/10	42.33	15-29	--	Well Not Accessable	
MW-6	09/09/10	42.33	15-29	--	Well Not Accessable	
MW-6	01/25/11	42.33	15-29	--	Well Not Accessable	
MW-7	06/23/93	42.70	10-29	--	17.87	24.83
MW-7	09/30/93	42.70	10-29	--	18.94	23.76
MW-7	02/06/94	42.70	10-29	0.06	19.11	23.63
MW-7	05/02/94	42.70	10-29	--	18.11	24.59
MW-7	07/01/94	42.70	10-29	--	18.72	23.98
MW-7	09/20/94	42.70	10-29	--	21.41	21.29
MW-7	12/05/94	42.70	10-29	--	18.66	24.04
MW-7	03/10/95	42.70	10-29	--	15.72	26.98
MW-7	03/14/95	42.70	10-29	--	15.23	27.47
MW-7	09/23/96	42.70	10-29	--	15.94	26.76
MW-7	12/04/96	42.70	10-29	--	16.43	26.27
MW-7	04/08/97	42.70	10-29	--	14.10	28.60
MW-7	06/30/97	42.70	10-29	--	15.51	27.19
MW-7	11/25/97	42.70	10-29	--	16.80	25.90
MW-7	06/01/98	42.70	10-29	--	10.31	32.39
MW-7	06/14/01	42.70	10-29	--	15.46	27.24
MW-7	11/07/01	42.70	10-29	--	--	--

TABLE 1
FLUID LEVEL MONITORING DATA
February 1992 through January 2011
EZ Serve 100877, 525 West A Street, Hayward, CA

Well ID	Date Monitored	Top of Casing Elevation* (feet)	Screen Interval (fbg)	Free Product	Depth to Water (feet)	Groundwater Elevation (feet)
MW-7	01/30/02	42.70	10-29	--	14.97	27.73
MW-7	05/29/02	42.70	10-29	--	15.49	27.21
MW-7	08/14/02	42.70	10-29	--	16.44	26.26
MW-7	11/15/02	42.70	10-29	--	16.91	25.79
MW-7	10/25/04	42.70	10-29		Could not locate	
MW-7	05/19/05	42.70	10-29	--	13.06	29.64
MW-7	09/15/05	42.70	10-29		Could not locate	
MW-7	11/10/05	42.70	10-29	--	15.78	26.92
MW-7	03/20/06	42.70	10-29		Could not locate	
MW-7	05/25/06	42.70	10-29		Well was blocked by debris	
MW-7	08/23/06	42.70	10-29	--	13.60	29.10
MW-7	03/14/07	42.70	10-29	--	14.00	28.70
MW-7	06/12/07	42.70	10-29		Well not safe to access due to dog	
MW-7	08/01/07	42.70	10-29	--	15.82	26.88
MW-7	02/27/08	42.70	10-29	--	14.24	28.46
MW-7	05/13/08	42.70	10-29	--	14.37	28.33
MW-7	08/27/08	42.70	10-29	--	16.62	26.08
MW-7	11/18/08	42.70	10-29	--	17.12	25.58
MW-7	03/11/09	42.70	10-29	--	15.28	27.42
MW-7	09/22/09	42.70	10-29	--	17.65	25.05
MW-7	03/09/10	42.70	10-29	--	14.95	27.75
MW-7	09/09/10	42.70	10-29	--	16.23	26.47
MW-7	01/25/11	42.70	10-29	--	15.02	27.68
MW-8	06/23/93	97.61	10-29	--	17.64	79.97
MW-8	09/30/93	97.61	10-29	--	18.85	78.76
MW-8	02/06/94	97.61	10-29	--	18.91	78.70
MW-8	05/02/94	97.61	10-29	--	18.11	79.50
MW-8	07/01/94	97.61	10-29	--	18.43	79.18
MW-8	09/20/94	97.61	10-29	--	21.43	76.18
MW-8	12/05/94	97.61	10-29	--	18.72	78.89
MW-8	03/10/95	97.61	10-29	--	18.69	78.92
MW-8	03/15/95	97.61	10-29	--	14.83	82.78
MW-8	09/23/96	97.61	10-29	--	15.83	81.78
	Not sampled, well inaccessible since 4th quarter, 1996					
MW-9	06/23/93	95.41	10-29	--	15.94	79.47
MW-9	09/30/93	95.41	10-29	--	17.05	78.36
MW-9	02/06/94	95.41	10-29	--	17.07	78.34
MW-9	05/02/94	95.41	10-29	--	16.24	79.17
MW-9	07/01/94	95.41	10-29	--	15.59	79.82
MW-9	09/20/94	95.41	10-29	--	16.61	78.80
MW-9	12/05/94	95.41	10-29	--	16.58	78.83
MW-9	03/10/95	95.41	10-29	--	--	--
MW-9	03/15/95	95.41	10-29	--	14.18	81.23
	Not sampled, well inaccessible since 1st quarter, 1995					

TABLE 1
FLUID LEVEL MONITORING DATA
February 1992 through January 2011
EZ Serve 100877, 525 West A Street, Hayward, CA

Well ID	Date Monitored	Top of Casing Elevation* (feet)	Screen Interval (fbg)	Free Product	Depth to Water (feet)	Groundwater Elevation (feet)
MW-10	06/23/93	97.11	10-29	--	17.39	79.72
MW-10	09/30/93	97.11	10-29	--	18.58	78.53
MW-10	02/06/94	97.11	10-29	--	18.61	78.50
MW-10	05/02/94	97.11	10-29	--	17.83	79.28
MW-10	07/01/94	97.11	10-29	--	18.17	78.94
MW-10	09/20/94	97.11	10-29	--	21.15	75.96
MW-10	12/05/94	97.11	10-29	--	18.43	78.68
MW-10	03/10/95	97.11	10-29	--	15.37	81.74
MW-10	03/15/95	97.11	10-29	--	15.97	81.14
MW-10	09/23/96	97.11	10-29	--	15.59	81.52
MW-10	12/04/96	97.11	10-29	--	16.15	80.96
Not sampled, well inaccessible since 4th quarter, 1996						
MW-11	02/10/95	92.68	5-29	--	11.80	80.88
MW-11	03/10/95	92.68	5-29	--	11.58	81.10
MW-11	03/15/95	92.68	5-29	--	13.96	78.72
MW-11	09/23/96	92.68	5-29	--	12.29	80.39
MW-11	12/04/96	92.68	5-29	--	--	--
MW-11	04/08/97	92.68	5-29	--	10.51	82.17
Not sampled, well inaccessible since 2nd quarter, 1997						
MW-12	02/10/95	43.25	10-30	--	16.30	26.95
MW-12	03/10/95	43.25	10-30	--	16.37	26.88
MW-12	03/14/95	43.25	10-30	--	15.69	27.56
MW-12	09/23/96	43.25	10-30	--	16.67	26.58
MW-12	12/04/96	43.25	10-30	--	17.16	26.09
MW-12	04/08/97	43.25	10-30	--	14.88	28.37
MW-12	06/30/97	43.25	10-30	--	16.33	26.92
MW-12	11/25/97	43.25	10-30	--	17.61	25.64
MW-12	06/01/98	43.25	10-30	--	11.58	31.67
MW-12	06/14/01	43.25	10-30	--	16.62	26.63
MW-12	11/07/01	43.25	10-30	--	17.91	25.34
MW-12	01/30/02	43.25	10-30	--	15.60	27.65
MW-12	05/29/02	43.25	10-30	--	16.24	27.01
MW-12	08/14/02	43.25	10-30	--	17.20	26.05
MW-12	11/15/02	43.25	10-30	--	17.62	25.63
MW-12	10/25/04	43.25	10-30	Well not sampled, cars parked on well		
MW-12	02/25/05	43.25	10-30	--	14.72	28.53
MW-12	05/19/05	43.25	10-30	--	13.80	29.45
MW-12	09/15/05	43.25	10-30	--	15.94	27.31
MW-12	11/10/05	43.25	10-30	--	16.51	26.74
MW-12	03/20/06	43.25	10-30	--	13.04	30.21
MW-12	05/25/06	43.25	10-30	--	12.65	30.60
MW-12	08/23/06	43.25	10-30	--	14.44	28.81
MW-12	03/14/07	43.25	10-30	--	14.70	28.55
MW-12	06/11/07	43.25	10-30	--	16.02	27.23
MW-12	08/01/07	43.25	10-30	--	16.57	26.68

TABLE 1
FLUID LEVEL MONITORING DATA
February 1992 through January 2011
EZ Serve 100877, 525 West A Street, Hayward, CA

Well ID	Date Monitored	Top of Casing Elevation* (feet)	Screen Interval (fbg)	Free Product	Depth to Water (feet)	Groundwater Elevation (feet)
MW-12	02/27/08	43.25	10-30	--	14.99	28.26
MW-12	05/13/08	43.25	10-30	--	16.12	27.13
MW-12	08/27/08	43.25	10-30	--	17.37	25.88
MW-12	11/18/08	43.25	10-30	--	17.82	25.43
MW-12	03/11/09	43.25	10-30	--	15.88	27.37
MW-12	09/22/09	43.25	10-30	--	18.33	24.92
MW-12	03/09/10	43.25	10-30	--	15.61	27.64
MW-12	01/25/11	43.25	10-30	--	15.71	27.54
MW-13	02/10/95	40.97	10-30	--	14.45	26.52
MW-13	03/10/95	40.97	10-30	--	14.30	26.67
MW-13	03/14/95	40.97	10-30	--	15.81	25.16
MW-13	09/23/96	40.97	10-30	--	14.60	26.37
MW-13	12/04/96	40.97	10-30	--	--	--
MW-13	04/08/97	40.97	10-30	--	12.75	28.22
MW-13	06/30/97	40.97	10-30	--	14.13	26.84
MW-13	11/25/97	40.97	10-30	--	15.48	25.49
MW-13	06/01/98	40.97	10-30	--	9.58	31.39
MW-13	06/14/01	40.97	10-30	--	14.51	26.46
MW-13	11/07/01	40.97	10-30	--	15.85	25.12
MW-13	01/30/02	40.97	10-30	--	13.65	27.32
MW-13	05/29/02	40.97	10-30	--	14.10	26.87
MW-13	08/14/02	40.97	10-30	--	15.13	25.84
MW-13	11/15/02	40.97	10-30	--	--	--
MW-13	10/25/04	40.97	Well not sampled. Unable to locate well since 10/25/04			
MW-13	01/25/11	40.97	10-30	--	13.28	27.69
MW-14	02/10/95	43.19	10-30	--	16.28	26.91
MW-14	03/10/95	43.19	10-30	--	16.33	26.86
MW-14	03/14/95	43.19	10-30	--	14.87	28.32
MW-14	09/23/96	43.19	10-30	--	16.67	26.52
MW-14	12/04/96	43.19	10-30	--	17.06	26.13
MW-14	04/08/97	43.19	10-30	--	14.77	28.42
MW-14	06/30/97	43.19	10-30	--	16.22	26.97
MW-14	11/25/97	43.19	10-30	--	17.52	25.67
MW-14	06/01/98	43.19	10-30	--	11.46	31.73
MW-14	06/14/01	43.19	10-30	--	16.53	26.66
MW-14	11/07/01	43.19	10-30	--	17.84	25.35
MW-14	01/30/02	43.19	10-30	--	15.55	27.64
MW-14	05/29/02	43.19	10-30	--	16.14	27.05
MW-14	08/14/02	43.19	10-30	--	17.12	26.07
MW-14	11/15/02	43.19	10-30	--	17.56	25.63
MW-14	10/25/04	43.19	Well not sampled. Unable to locate well due to parked cars			
MW-14	02/25/05	43.19	10-30	--	14.20	28.99
MW-14	05/19/05	43.19	10-30	--	13.71	29.48
MW-14	09/15/05	43.19	10-30	Well not sampled due to lack of traffic control		
MW-14	11/10/05	43.19	10-30	Well not sampled due to lack of traffic control		

TABLE 1
FLUID LEVEL MONITORING DATA
February 1992 through January 2011
EZ Serve 100877, 525 West A Street, Hayward, CA

Well ID	Date Monitored	Top of Casing Elevation* (feet)	Screen Interval (fbg)	Free Product	Depth to Water (feet)	Groundwater Elevation (feet)
MW-14	03/20/06	43.19	10-30	--	12.94	30.25
MW-14	05/25/06	43.19	10-30	--	12.68	30.51
MW-14	08/23/06	43.19	10-30	--	15.32	27.87
MW-14	03/14/07	43.19	10-30	--	14.58	28.61
MW-14	06/11/07	43.19	10-30	--	15.95	27.24
MW-14	08/01/07	43.19	10-30	--	16.47	26.72
MW-14	02/27/08	43.19	10-30	--	14.91	28.28
MW-14	05/13/08	43.19	10-30	--	16.03	27.16
MW-14	08/27/08	43.19	10-30	--	17.28	25.91
MW-14	11/18/08	43.19	10-30	--	17.75	25.44
MW-14	03/11/09	43.19	10-30	--	15.83	27.36
MW-14	09/22/09	43.19	10-30	--	18.28	24.91
MW-14	03/09/10	43.19	10-30	--	15.54	27.65
MW-14	01/25/11	43.19	10-30	--	15.63	27.56
EX-1	08/14/02	--	10-35	--	16.58	--
EX-1	11/15/02	--	10-35	--	17.02	--
EX-1	10/25/04	--	10-35	--	16.91	--
EX-1	12/23/04	--	10-35	--	16.60	--
EX-1	02/25/05	--	10-35	--	13.72	--
EX-1	05/19/05	--	10-35	--	13.13	--
EX-1	09/15/05	--	10-35	--	15.20	--
EX-1	11/10/05	--	10-35	--	15.80	--
EX-1	03/20/06	--	10-35	--	12.35	--
EX-1	05/25/06	--	10-35	--	11.88	--
EX-1	08/23/06	--	10-35	--	13.62	--
EX-1	03/14/07	--	10-35	--	14.00	--
EX-1	06/11/07	--	10-35	--	15.34	--
EX-1	08/01/07	--	10-35	--	15.89	--
EX-1	02/27/08	--	10-35	--	Could not locate well	--
EX-1	05/13/08	--	10-35	--	Could not locate well	--
EX-1	08/27/08	--	10-35	--	16.70	--
EX-1	11/18/08	--	10-35	--	17.20	--
EX-1	03/11/09	--	10-35	--	15.38	--
EX-1	09/22/09	--	10-35	--	17.71	--
EX-1	03/09/10	--	10-35	--	15.00	--
EX-1	09/09/10	--	10-35	--	16.38	--
VEAS-2	02/25/05	--	5-15/28-30	--	13.68	--
VEAS-2	05/19/05	--	5-15/28-30	--	13.11	--
VEAS-2	11/10/05	--	5-15/28-30	--	DRY	--

Elevations are in feet above mean sea level. Free Product = liquid-phase hydrocarbons
-- = not encountered or no data av fbg = feet below grade
Note: No known groundwater sampling was conducted between June 1, 1998 and June 14, 2001 or June 14, 2001 and November 7, 2001. Wellhead elevations resurveyed on January 30, 2002.

TABLE 2
RESULTS OF LABORATORY ANALYSIS OF GROUNDWATER SAMPLES
October 1992 through March 2010
EZ Serve 100877, 525 West A Street, Hayward, CA

Well Number	Date Sampled	TPH-G (ug/l)	TPH-D (mg/L)	Benzene (ug/l)	Toluene (ug/l)	Ethyl-benzene (ug/l)	Total Xylenes (ug/l)	DIPE (ug/l)	ETBE (ug/l)	MTBE (ug/l)	TAME (ug/l)	TBA (ug/l)	1,2-DCA (ug/l)	EDB (ug/l)
MW-1	02/05/92	46,000	--	7,600	2,300	2,400	6,500	--	--	--	--	--	--	--
MW-1	09/11/92	48,000	--	9,000	1,200	1,800	4,600	--	--	--	--	--	--	--
MW-1	12/22/92	84,000	--	22,000	1,600	4,800	17,000	--	--	--	--	--	--	--
MW-1	03/03/93	54,000	--	16,000	1,600	1,900	4,300	--	--	--	--	--	--	--
MW-1	06/23/93	30,000	--	18,000	1,100	1,400	3,700	--	--	--	--	--	--	--
MW-1	09/30/93	33,000	--	10,000	440	940	1,700	--	--	--	--	--	--	--
MW-1	02/06/94	64,000	--	18,000	1,600	4,700	12,000	--	--	--	--	--	--	--
MW-1	05/02/94	7,200	--	2,100	29	490	520	--	--	--	--	--	--	--
MW-1	07/01/94	13,000	--	3,700	150	550	12,000	--	--	--	--	--	--	--
MW-1	09/20/94	10,000	--	3,100	75	440	870	--	--	--	--	--	--	--
MW-1	12/05/92	8,700	--	3,700	87	520	950	--	--	--	--	--	--	--
MW-1	03/10/95	--	--	--	--	--	--	--	--	--	--	--	--	--
MW-1	03/15/95	290	--	56	2	12	47	--	--	--	--	--	--	--
MW-1	09/23/96	20,000	--	5,200	860	700	1,100	--	--	270	--	--	--	--
MW-1	12/04/96	17,000	--	3,100	64	610	1,200	--	--	280	--	--	--	--
MW-1	04/08/97	2,100	--	430	15	52	85	--	--	100	--	--	--	--
MW-1	06/30/97	10,000	--	2,100	<	<	320	--	--	<	--	--	--	--
MW-1	11/25/97	16,000	--	2,100	23	76	240	--	--	<	--	--	--	--
MW-1	06/01/98	19,000	--	6,100	460	1,100	2,300	--	--	420	--	--	--	--
MW-1	06/14/01	6,000	--	380	8.4	260	180	--	--	<25	--	--	--	--
MW-1	11/07/01	12,000	--	1,000	30	1,000	740	<5.0	<5.0	11	<5.0	<50	--	--
MW-1	01/30/02	8,800	--	690	16	480	270	<5.0	<5.0	14	<5.0	<50	--	--
MW-1	05/29/02	6,400	--	330	13	250	260	2.5	<2.0	12	<2.0	<20	--	--
MW-1	08/14/02	5,500	--	470	14	360	160	<10	<10	10	<10	<100	--	--
MW-1	11/15/02	10,000	--	440	16	310	150	<10	<10	15	<10	<100	--	--
MW-1	10/25/04	4,300	--	260	3.3	150	32	<0.90	<0.90	14	<0.90	5.8	--	--
MW-1	12/23/04	11,000	--	860	6.1	880	280	<0.90	<0.90	16	<0.90	11	--	--
MW-1	02/25/05	11,000	--	710	6.7	720	330	<1.5	<1.5	24	<1.5	11	--	--
MW-1	05/19/05	7,500	--	610	12	370	140	<1.5	<1.5	20	<1.5	11	--	--
MW-1	09/15/05	6,100	--	300	3.5	280	71	<0.90	<0.90	12	<0.90	7.8	--	--
MW-1	03/20/06	6,400	--	290	3.2	330	61	<0.90	<0.90	8.8	<0.90	6	--	--
MW-1	05/25/06	4,200	--	300	6.4	100	40	<0.90	<0.90	11	<0.90	6.7	--	--
MW-1	08/23/06	3,400	--	140	1.9	92	9.2	<0.50	<0.50	4.2	<0.50	<5.0	--	--
MW-1	03/14/07	5,600	--	75	0.83	160	20	<0.50	<0.50	2.5	<0.50	<5.0	--	--
MW-1	06/11/07	5,400	--	90	<1.0	220	12	<1.0	<1.0	2.4	<1.0	<5.0	--	--
MW-1	08/01/07	5,300	--	130	<0.74	450	36	<0.60	<0.63	<0.77	<0.83	<35	--	--
MW-1	02/27/08	1,090	--	11	<0.24	40	9.1	<0.18	<0.23	<0.19	<0.19	<10	--	--
MW-1	05/13/08	4,530	--	77	<0.25	457	56	<2.5	<2.5	6.9	<2.5	<25.0	--	--
MW-1	08/27/08	3,350	--	45	1.1	261	16	<0.5	<0.5	12	<0.5	9.1	--	--
MW-1	11/18/08	4,680	--	42	0.7	266	6.9	<0.5	<0.5	15	<0.5	6.9	--	--
MW-1	03/11/09	5,180	--	69	2.0	440	10	<0.5	<0.5	20	<0.5	<5.0	--	--
MW-1	09/22/09	6,600	--	54	0.7	137	2.7	<0.5	<0.5	18	<0.5	<5.0	--	--
MW-1	03/09/10	4,670	--	70	<0.5	83	2.9	<0.5	<0.5	50	<0.5	<5.0	--	--
MW-1	09/09/10	4,750	1.7	39	0.7	46	2.4	<1.0	<1.0	85	<1.0	<10.0	<0.5	<0.5
MW-1	01/25/11	3,530	--	30	<0.5	85	1.7	<0.5	<0.5	50	<0.5	<5.0	<0.5	<0.5
MW-1A	06/23/93	--	--	--	--	--	--	--	--	--	--	--	--	--
MW-1A	09/30/93	--	--	--	--	--	--	--	--	--	--	--	--	--
MW-1A	02/06/94	8,900	--	1,700	42	1,000	400	--	--	--	--	--	--	--
MW-1A	05/02/94	--	--	--	--	--	--	--	--	--	--	--	--	--
MW-1A	07/01/94	12,000	--	1,100	<1	920	1,100	--	--	--	--	--	--	--
MW-1A	09/20/94	--	--	--	--	--	--	--	--	--	--	--	--	--
MW-1A	12/05/94	--	--	--	--	--	--	--	--	--	--	--	--	--
MW-1A	03/10/95	--	--	--	--	--	--	--	--	--	--	--	--	--
MW-1A	03/15/95	--	--	--	--	--	--	--	--	--	--	--	--	--
MW-1A	09/23/96	--	--	--	--	--	--	--	--	--	--	--	--	--
MW-1A	12/04/96	52,000	--	420	140	1,000	3,500	--	--	130	--	--	--	--
MW-1A	04/08/97	--	--	--	--	--	--	--	--	--	--	--	--	--
MW-1A	06/30/97	17,000	--	180	<	140	1,100	--	--	<	--	--	--	--
MW-1A	11/25/97	19,000	--	110	37	290	910	--	--	<	--	--	--	--
MW-1A	06/01/98	18,000	--	200	17	230	820	--	--	91	--	--	--	--

TABLE 2
RESULTS OF LABORATORY ANALYSIS OF GROUNDWATER SAMPLES
October 1992 through March 2010
EZ Serve 100877, 525 West A Street, Hayward, CA

Well Number	Date Sampled	TPH-G (ug/l)	TPH-D (mg/L)	Benzene (ug/l)	Toluene (ug/l)	Ethyl-benzene (ug/l)	Total Xylenes (ug/l)	DIPE (ug/l)	ETBE (ug/l)	MTBE (ug/l)	TAME (ug/l)	TBA (ug/l)	1,2-DCA (ug/l)	EDB (ug/l)
MW-1A	06/14/01	27,000	--	29	<5.0	620	520	--	--	<50	--	--	--	--
MW-1A	11/07/01	21,000	--	51	<5.0	700	510	<5.0	<5.0	<5.0	<5.0	<50	--	--
MW-1A	01/30/02	24,000	--	22	<5.0	390	330	<5.0	<5.0	<5.0	<5.0	<50	--	--
MW-1A	05/29/02	12,000	--	32	<5.0	550	270	<5.0	<5.0	<5.0	<5.0	<50	--	--
MW-1A	08/14/02	14,000	--	22	<2.0	510	240	<2.0	<2.0	<2.0	<2.0	<20	--	--
MW-1A	11/15/02	17,000	--	59	2.4	630	250	<2.0	<2.0	<2.0	<2.0	<20	--	--
MW-1A	10/25/04	2,200	--	1.3	<0.50	58	3.7	<0.50	<0.50	<0.50	<0.50	<5.0	--	--
MW-1A	12/23/04	3,100	--	2.2	<0.50	96	5.4	<0.50	<0.50	<0.50	<0.50	<5.0	--	--
MW-1A	02/25/05	7,300	--	4.7	1.1	140	24	<0.50	<0.50	<0.50	<0.50	<5.0	--	--
MW-1A	05/19/05	13,000	--	3.1	1.7	190	50	<1.5	<1.5	<1.5	<1.5	<7.0	--	--
MW-1A	09/15/05	4,000	--	0.84	<0.50	52	2.5	<0.50	<0.50	<0.50	<0.50	<5.0	--	--
MW-1A	11/10/05	12,000	--	<2.0	0.76	130	3.6	<0.50	<0.50	<0.50	<0.50	<5.0	--	--
MW-1A	03/20/06	3,300	--	1.1	<0.50	17	1	<0.50	<0.50	<0.50	<0.50	<5.0	--	--
MW-1A	05/25/06	1,600	--	0.79	<0.50	22	0.94	<0.50	<0.50	<0.50	<0.50	<5.0	--	--
MW-1A	08/23/06	4,700	--	1.6	1.1	84	1.8	<0.50	<0.50	<0.50	<0.50	<5.0	--	--
MW-1A	03/14/07	610	--	<0.50	<0.50	12	<0.50	<0.50	<0.50	7.5	<0.50	<5.0	--	--
MW-1A	06/12/07	3,200	--	1.1	0.84	79	0.76	<0.50	<0.50	20	<0.50	<5.0	--	--
MW-1A	08/01/07	440	--	0.31	<0.15	6.2	<0.34	<0.12	<0.13	79	<0.17	<6.9	--	--
MW-1A	02/27/08	1,660	--	<0.18	<0.24	50	<0.45	<0.20	<0.23	21	<0.19	<10	--	--
MW-1A	11/18/08	Dry Well	† Dry Well	No Sample	Collector	--	--	--	--	--	--	--	--	--
MW-1A	03/11/09	Dry Well	† Dry Well	No Sample	Collector	--	--	--	--	--	--	--	--	--
MW-2	02/05/92	67,000	--	13,000	4,700	820	1,300	--	--	--	--	--	--	--
MW-2	09/11/92	57,000	--	9,000	1,400	1,200	8,400	--	--	--	--	--	--	--
MW-2	12/22/92	31,000	--	9,900	350	2,000	4,100	--	--	--	--	--	--	--
MW-2	03/03/93	17,000	--	5,100	1,300	720	1,900	--	--	--	--	--	--	--
MW-2	06/23/93	60,000	--	23,000	1,500	4,500	17,000	--	--	--	--	--	--	--
MW-2	09/30/93	38,000	--	12,000	780	1,500	6,500	--	--	--	--	--	--	--
MW-2	02/06/94	34,000	--	8,900	450	2,000	5,500	--	--	--	--	--	--	--
MW-2	05/02/94	18,000	--	3,800	260	1,100	3,500	--	--	--	--	--	--	--
MW-2	07/01/94	18,000	--	3,700	510	870	2,600	--	--	--	--	--	--	--
MW-2	09/20/94	19,000	--	4,500	300	1,200	4,000	--	--	--	--	--	--	--
MW-2	12/06/94	22,000	--	4,700	340	1,400	4,500	--	--	--	--	--	--	--
MW-2	03/10/95	--	--	--	--	--	--	--	--	--	--	--	--	--
MW-2	03/15/95	29,000	--	5,600	350	1,900	6,300	--	--	--	--	--	--	--
MW-2	09/23/96	29,000	--	3,700	150	1,000	4,300	--	--	860	--	--	--	--
MW-2	12/04/96	31,000	--	3,800	140	2,000	5,100	--	--	690	--	--	--	--
MW-2	04/08/97	20,000	--	2,500	80	1,300	3,400	--	--	880	--	--	--	--
MW-2	06/30/97	41,000	--	2,700	130	1,200	4,000	--	--	890	--	--	--	--
MW-2	11/25/97	51,000	--	2,900	140	1,800	7,000	--	--	1,200	--	--	--	--
MW-2	06/01/98	33,000	--	2,700	130	1,800	5,700	--	--	610	--	--	--	--
MW-2	06/14/01	18,000	--	860	14	1,100	2,200	--	--	<100	--	--	--	--
MW-2	11/07/01	20,000	--	880	20	1,100	2,600	<5.0	<5.0	21	<5.0	<50	--	--
MW-2	01/30/02	19,000	--	880	19	1,100	2,400	<5.0	<5.0	56	<5.0	<50	--	--
MW-2	05/29/02	8,100	--	390	16	560	1,400	<5.0	<5.0	32	<5.0	<50	--	--
MW-2	08/14/02	19,000	--	820	21	1,200	2,600	<20	<20	29	<20	<200	--	--
MW-2	11/15/02	34,000	--	910	31	1,000	1,400	<20	<20	39	<20	<200	--	--
MW-2	10/25/04	9,300	--	280	3.8	500	980	<2.0	<2.0	8.2	<2.0	<9.0	--	--
MW-2	12/23/04	10,000	--	310	3.9	470	840	<2.0	<2.0	9.5	<2.0	<9.0	--	--
MW-2	02/25/05	15,000	--	320	4.8	860	1,600	<2.0	<2.0	7.7	<2.0	<9.0	--	--
MW-2	05/19/05	15,000	--	300	3.6	770	1,200	<2.5	<2.5	9.2	<2.5	<15	--	--
MW-2	09/15/05	--	--	--	--	--	--	--	--	--	--	--	--	--
MW-2	11/10/05	14,000	--	230	2.6	530	1,000	<2.5	<2.5	6.2	<2.5	<15	--	--
MW-2	03/20/06	8,700	--	170	<1.5	360	530	<1.5	<1.5	3.8	<1.5	<7.0	--	--
MW-2	05/25/06	--	--	--	--	--	--	--	--	--	--	--	--	--
MW-3	02/05/92	16,000	--	2,700	410	<1	3,400	--	--	--	--	--	--	--
MW-3	09/11/92	43,000	--	7,600	1,600	1,400	4,100	--	--	--	--	--	--	--
MW-3	12/22/92	29,000	--	8,800	1,200	1,500	3,700	--	--	--	--	--	--	--
MW-3	03/03/93	17,000	--	5,000	1,500	680	1,700	--	--	--	--	--	--	--
MW-3	06/23/93	5,700	--	3,000	120	560	790	--	--	--	--	--	--	--

TABLE 2
RESULTS OF LABORATORY ANALYSIS OF GROUNDWATER SAMPLES
October 1992 through March 2010
EZ Serve 100877, 525 West A Street, Hayward, CA

Well Number	Date Sampled	TPH-G (ug/l)	TPH-D (mg/L)	Benzene (ug/l)	Toluene (ug/l)	Ethyl-benzene (ug/l)	Total Xylenes (ug/l)	DIPE (ug/l)	ETBE (ug/l)	MTBE (ug/l)	TAME (ug/l)	TBA (ug/l)	1,2-DCA (ug/l)	EDB (ug/l)
MW-3	09/30/93	21,000	--	7,000	2,100	970	2,600	--	--	--	--	--	--	--
MW-3	02/06/94	24,000	--	7,200	1,600	990	3,200	--	--	--	--	--	--	--
MW-3	05/02/94	10,000	--	2,200	440	470	1,200	--	--	--	--	--	--	--
MW-3	07/01/94	8,200	--	2,000	370	350	930	--	--	--	--	--	--	--
MW-3	09/20/94	7,200	--	2,000	360	380	1,000	--	--	--	--	--	--	--
MW-3	12/06/94	9,000	--	2,300	400	440	1,100	--	--	--	--	--	--	--
MW-3	03/10/95	--	--	--	--	--	--	--	--	--	--	--	--	--
MW-3	03/15/95	4,300	--	980	47	370	780	--	--	--	--	--	--	--
MW-3	09/23/96	10,000	--	950	20	700	780	--	--	80	--	--	--	--
MW-3	12/04/96	13,000	--	1,100	25	1,000	1,100	--	--	67	--	--	--	--
MW-3	04/08/97	3,800	--	210	4.6	270	280	--	--	56	--	--	--	--
MW-3	06/30/97	3,500	--	280	<	32	180	--	--	<	--	--	--	--
MW-3	11/25/97	6,800	--	230	<	370	290	--	--	130	--	--	--	--
MW-3	06/01/98	--	--	--	--	--	--	--	--	--	--	--	--	--
MW-3	06/14/01	2,100	--	9	<0.5	78	43	--	--	<5.0	--	--	--	--
MW-3	11/07/01	7,700	--	75	<5.0	410	150	<5.0	<5.0	<5.0	<5.0	<5.0	--	--
MW-3	01/30/02	3,600	--	27	<5.0	120	34	<5.0	<5.0	<5.0	<5.0	<5.0	--	--
MW-3	05/29/02	2,000	--	18	<5.0	53	13	<5.0	<5.0	<5.0	<5.0	<5.0	--	--
MW-3	08/14/02	2,400	--	19	<0.5	50	6.5	<0.5	<0.5	<0.5	<0.5	<5.0	--	--
MW-3	11/15/02	4,300	--	7.5	<0.5	22	1.1	0.5	0.5	0.5	0.5	<5.0	--	--
MW-3	10/25/04	460	--	0.6	<0.50	9.6	1.7	<0.50	<0.50	<0.50	<0.50	<5.0	--	--
MW-3	12/20/04	5,400	--	9	<0.50	280	74	<0.50	<0.50	<0.50	<0.50	<5.0	--	--
MW-3	02/25/05	Could not locate, VEAS-2 sampled insteac						--	--	--	--	--	--	--
MW-3	05/19/05	Could not locate, VEAS-2 sampled insteac						--	--	--	--	--	--	--
MW-3	09/15/05	Could not locate well						--	--	--	--	--	--	--
MW-3	11/10/05	Could not locate well						--	--	--	--	--	--	--
MW-3	03/20/06	800	--	0.76	<0.50	19	3.7	<0.50	<0.50	<0.50	<0.50	<5.0	--	--
MW-3	05/25/06	500	--	0.59	<0.50	3.8	0.96	<0.50	<0.50	<0.50	<0.50	<5.0	--	--
MW-3	08/23/06	550	--	<0.50	<0.50	2.2	<0.50	<0.50	<0.50	<0.50	<0.50	<5.0	--	--
MW-3	03/14/07	660	--	0.85	<0.50	22	3.7	<0.50	<0.50	1.3	<0.50	<5.0	--	--
MW-3	06/12/07	540	--	<0.50	<0.50	14	2.2	<0.50	<0.50	6.0	<0.50	<5.0	--	--
MW-3	08/01/07	2,300	--	2.3	<0.15	87	13	<0.12	<0.13	<0.15	<0.17	<6.9	--	--
MW-3	02/27/08	1,360	--	<0.18	<0.24	32	3	<0.20	<0.23	7.7	<0.19	<10	--	--
MW-3	05/13/08	1,160	--	1.2	0.6	28	2.2	<0.5	<0.5	31	<0.5	<5.0	--	--
MW-3	08/27/08	2,790	--	1.4	<0.5	56	4.0	<0.5	<0.5	40	<0.5	18	--	--
MW-3	11/18/08	1,800	--	0.8	<0.5	50	1.4	<0.5	<0.5	31	<0.5	13	--	--
MW-3	03/11/09	957	--	1.2	0.9	37	4.0	<0.5	<0.5	155	<0.5	<5.0	--	--
MW-3	09/22/09	533	--	1.6	<0.5	8.8	<0.5	<0.5	<0.5	238	<0.5	<5.0	--	--
MW-3	03/09/10	537	--	<0.5	<0.5	8.8	<0.5	<0.5	<0.5	114	<0.5	<5.0	--	--
MW-3	09/09/10	272	<0.1	<0.5	<0.5	1.5	<0.5	<1.0	<1.0	36	<1.0	<10	<0.5	<0.5
MW-3	01/25/11	377	--	<0.5	<0.5	8.5	<0.5	<0.5	<0.5	5.1	<0.5	<5.0	<0.5	<0.5
MW-4	02/05/92	16,000	--	2,700	410	<1	3,400	--	--	--	--	--	--	--
MW-4	09/11/92	43,000	--	7,600	1,600	1,400	4,100	--	--	--	--	--	--	--
MW-4	12/22/92	29,000	--	8,800	1,200	1,500	3,700	--	--	--	--	--	--	--
MW-4	03/03/93	17,000	--	5,000	1,500	680	1,700	--	--	--	--	--	--	--
MW-4	06/23/93	5,700	--	3,000	120	560	790	--	--	--	--	--	--	--
MW-4	09/30/93	21,000	--	7,000	2,100	970	2,600	--	--	--	--	--	--	--
MW-4	02/06/94	24,000	--	7,200	1,600	990	3,200	--	--	--	--	--	--	--
MW-4	05/02/94	10,000	--	2,200	440	470	1,200	--	--	--	--	--	--	--
MW-4	07/01/94	8,200	--	2,000	370	350	930	--	--	--	--	--	--	--
MW-4	09/20/94	7,200	--	2,000	360	380	1,000	--	--	--	--	--	--	--
MW-4	12/06/94	9,000	--	2,300	400	440	1,100	--	--	--	--	--	--	--
MW-4	03/10/95	--	--	--	--	--	--	--	--	--	--	--	--	--
MW-4	03/15/95	15,000	--	4,400	600	770	2,660	--	--	--	--	--	--	--
MW-4	09/23/96	32,000	--	7,400	540	1,500	2,800	--	--	2,100	--	--	--	--
MW-4	12/04/96	23,000	--	7,800	140	1,200	1,200	--	--	1,900	--	--	--	--
MW-4	04/08/97	16,000	--	3,900	680	850	2,300	--	--	980	--	--	--	--
MW-4	06/30/97	63,000	--	7,000	430	1,400	4,400	--	--	1,700	--	--	--	--
MW-4	11/25/97	30,000	--	4,300	61	810	1,500	--	--	880	--	--	--	--
MW-4	06/01/98	33,000	--	5,700	710	1,700	2,900	--	--	720	--	--	--	--

TABLE 2
RESULTS OF LABORATORY ANALYSIS OF GROUNDWATER SAMPLES
October 1992 through March 2010
EZ Serve 100877, 525 West A Street, Hayward, CA

Well Number	Date Sampled	TPH-G (ug/l)	TPH-D (mg/L)	Benzene (ug/l)	Toluene (ug/l)	Ethyl-benzene (ug/l)	Total Xylenes (ug/l)	DIPE (ug/l)	ETBE (ug/l)	MTBE (ug/l)	TAME (ug/l)	TBA (ug/l)	1,2-DCA (ug/l)	EDB (ug/l)
MW-4	06/14/01	9,500	--	690	45	560	600	<5.0	<5.0	<50	<5.0	<50	--	--
MW-4	11/07/01	6,000	--	710	20	630	190	<5.0	<5.0	27	<5.0	<50	--	--
MW-4	01/30/02	4,800	--	830	16	600	61	<20	<20	42	<20	<200	--	--
MW-4	05/29/02	5,300	--	720	57	600	200	<2.0	<2.0	35	<2.0	<20	--	--
MW-4	08/14/02	5,000	--	640	15	550	35	<2.0	<2.0	28	<2.0	<20	--	--
MW-4	11/15/02	3,700	--	330	10	260	200	<0.50	<0.50	20	<0.50	<5.0	--	--
MW-4	10/25/04	4,000	--	180	15	200	190	<0.90	<0.90	4.1	<0.90	<5.0	--	--
MW-4	12/23/04	7,400	--	280	24	340	340	<0.90	<0.90	7.9	<0.90	<5.0	--	--
MW-4	02/25/05	4,200	--	160	15	280	420	<4.0	<4.0	6.2	<4.0	<20	--	--
MW-4	05/19/05	15,000	--	480	76	1,100	1,600	<0.90	<0.90	14	<0.90	5.4	--	--
MW-4	09/15/05	5,400	--	220	22	250	430	<0.50	<0.50	10	<0.50	<5.0	--	--
MW-4	11/10/06	8,000	--	320	37	530	670	<0.50	<0.50	9.3	<0.50	<5.0	--	--
MW-4	03/20/06	3,900	--	91	26	5.8	360.0	<0.50	<0.50	5.7	<0.50	<5.0	--	--
MW-4	05/25/06	8,300	--	300	77	570	730	<0.50	<0.50	5.4	<0.50	<5.0	--	--
MW-4	08/23/06	9,400	--	240	79	490	860	<0.50	<0.50	6.1	<0.50	<5.0	--	--
MW-4	03/14/07	4,600	--	100	20	350	570	<0.50	<0.50	2.3	<0.50	<5.0	--	--
MW-4	06/12/07	3,700	--	120	14	150	230	<0.50	<0.50	2.5	<0.50	<5.0	--	--
MW-4	08/01/07	3,700	--	120	15	280	310	<0.60	<0.63	<0.77	<0.83	<35	--	--
MW-4	02/27/08	Could not locate well			--	--	--	--	--	--	--	--	--	--
MW-4	05/13/08	2,800	--	102	18	329	343	<2.5	<2.5	8.0	<2.5	<25.0	--	--
MW-4	08/27/08	4,730	--	72	12	318	233	<0.5	<0.5	33	<0.5	18	--	--
MW-4	11/18/08	2,430	--	39	6.6	163	102	<0.5	<0.5	29	<0.5	8.1	--	--
MW-4	03/11/09	3,470	--	67	12	402	340	<0.5	<0.5	86	<0.5	<5.0	--	--
MW-4	09/22/09	1,590	--	25	<0.5	84	52	<0.5	<0.5	116	<0.5	<5.0	--	--
MW-4	03/09/10	1,790	--	21	4.3	94	65	<0.5	<0.5	220	<0.5	<5.0	--	--
MW-4	09/09/10	77,300	0.1	15,800	2,980	2,770	6,490	<10.0	<10.0	<5.0	<10.0	506	112	<5.0
MW-4	11/22/10	2,160	--	27	5	82	57	<5.0	<5.0	384	<5.0	<50	<5.0	<5.0
MW-4	01/25/11	651	--	4.6	2.2	5.9	3.5	<1.0	<1.0	161	<1.0	116	<1.0	<1.0
MW-5	02/05/92	78,000	--	7,900	5,000	2,900	1,800	--	--	--	--	--	--	--
MW-5	09/11/92	49,000	--	4,700	400	1,400	4,100	--	--	--	--	--	--	--
MW-5	12/22/92	34,000	--	8,600	340	2,200	4,800	--	--	--	--	--	--	--
MW-5	03/03/93	22,000	--	7,500	640	1,300	3,400	--	--	--	--	--	--	--
MW-5	06/23/93	15,000	--	5,800	120	1,100	2,100	--	--	--	--	--	--	--
MW-5	09/30/93	25,000	--	7,600	410	1,000	4,400	--	--	--	--	--	--	--
MW-5	02/06/94	23,000	--	6,000	180	2,000	5,900	--	--	--	--	--	--	--
MW-5	05/02/94	8,000	--	1,300	29	440	770	--	--	--	--	--	--	--
MW-5	07/01/94	10,000	--	1,700	97	600	1,400	--	--	--	--	--	--	--
MW-5	09/20/94	8,400	--	1,600	54	650	1,400	--	--	--	--	--	--	--
MW-5	15/5/92	10,000	--	1,800	<50	620	1,400	--	--	--	--	--	--	--
MW-5	03/10/95	--	--	--	--	--	--	--	--	--	--	--	--	--
MW-5	03/15/95	5,300	--	1,100	11	180	320	--	--	--	--	--	--	--
MW-5	09/23/96	9,800	--	1,800	11	470	510	--	--	100	--	--	--	--
MW-5	12/04/96	10,000	--	2,200	9	550	430	--	--	70	--	--	--	--
MW-5	04/08/97	11,000	--	1,300	15	450	720	--	--	180	--	--	--	--
MW-5	06/30/97	3,800	--	500	<	75	84	--	--	<	--	--	--	--
MW-5	11/25/97	8,200	--	1,300	14	310	220	--	--	<	--	--	--	--
MW-5	06/01/98	3,600	--	290	12	52	52	--	--	81	--	--	--	--
MW-5	06/14/01	5,100	--	44	0.71	110	23	--	--	<5.0	--	--	--	--
MW-5	11/07/01	7,600	--	220	<5.0	550	30	<5.0	<5.0	<5.0	<5.0	<50	--	--
MW-5	01/30/02	6,200	--	180	<20	310	130	<20	<20	<20	<20	<200	--	--
MW-5	05/29/02	3,900	--	66	0.8	110	7.4	2	<0.5	0.9	<0.5	<5.0	--	--
MW-5	08/14/02	4,300	--	80	0.9	150	12	<0.5	<0.5	1.1	<0.5	<5.0	--	--
MW-5	11/15/02	7,000	--	99	<5.0	250	500	<5.0	<5.0	<5.0	<5.0	<5.0	--	--
MW-5	10/25/04	4,800	--	27	0.5	50	3.7	<0.50	<0.50	0.79	<0.50	<5.0	--	--
MW-5	12/23/04	6,300	--	55	<0.90	140	5.6	<0.90	<0.90	<0.90	<0.90	<5.0	--	--
MW-5	02/25/05	4,700	--	44	0.59	110	4.8	<0.50	<0.50	0.85	<0.50	<5.0	--	--
MW-5	05/19/05	3,800	--	32	0.61	66	4.4	<0.50	<0.50	1	<0.50	<5.0	--	--
MW-5	09/15/05	4,500	--	22	0.65	78	4	<0.50	<0.50	9.5	<0.50	<5.0	--	--
MW-5	11/10/08	4,000	--	19	0.52	77	4.3	<0.50	<0.50	0.8	<0.50	<5.0	--	--
MW-5	03/20/06	4,000	--	9.5	<0.50	4.9	4	<0.50	<0.50	1.5	<0.50	<5.0	--	--

TABLE 2
RESULTS OF LABORATORY ANALYSIS OF GROUNDWATER SAMPLES
October 1992 through March 2010
EZ Serve 100877, 525 West A Street, Hayward, CA

Well Number	Date Sampled	TPH-G (ug/l)	TPH-D (mg/L)	Benzene (ug/l)	Toluene (ug/l)	Ethyl-benzene (ug/l)	Total Xylenes (ug/l)	DIPE (ug/l)	ETBE (ug/l)	MTBE (ug/l)	TAME (ug/l)	TBA (ug/l)	1,2-DCA (ug/l)	EDB (ug/l)
MW-5	05/25/06	3,400	--	12	<0.50	46	3.8	<0.50	<0.50	1.6	<0.50	<5.0	--	--
MW-5	08/23/06	4,000	--	5.6	0.75	42	3.6	<0.50	<0.50	1.3	<0.50	<5.0	--	--
MW-5	03/14/07	3,500	--	3.1	1	31	1.6	<0.50	<0.50	1.8	<0.50	<5.0	--	--
MW-5	06/11/07	2,500	--	3.0	0.83	14	1.4	<0.50	<0.50	1.9	<0.50	<5.0	--	--
MW-5	08/01/07	2,700	--	3.6	1.1	21	1.1	<0.12	<0.12	<0.15	<0.12	<6.9	--	--
MW-5	02/27/08	628	--	1.5	<0.24	8.9	4.2	<0.20	<0.23	1.6	<0.19	<10	--	--
MW-5	05/13/08	752	--	1.3	1.1	1.9	1.8	<0.5	<0.5	7.9	<0.5	<5.0	--	--
MW-5	08/27/08	3,100	--	2.9	2.9	12	6.8	<0.5	<0.5	64	<0.5	30	--	--
MW-5	11/18/08	2,490	--	1.9	0.7	8.7	2.4	<0.5	<0.5	60	<0.5	27	--	--
MW-5	03/11/09	2,210	--	3.3	1.1	8.5	1.3	<0.5	<0.5	72	<0.5	<5.0	--	--
MW-5	09/22/09	2,870	--	4.4	1.1	11	2.9	<0.5	<0.5	88	<0.5	<5.0	--	--
MW-5	03/09/10	103	--	<0.5	<0.5	<0.5	<0.5	<0.5	<0.5	7.8	<0.5	<5.0	--	--
MW-5	09/09/10	31,700	0.2	9,730	333	905	848	<10.0	<10.0	<5.0	<10.0	199	91	<5.0
MW-5	11/22/10	3,500	--	2.7	<1.0	4.6	<1.0	<1.0	<1.0	136	<1.0	<10	<1.0	<1.0
MW-5	01/25/11	1,140	--	1.8	<0.5	2.9	<0.5	<0.5	<0.5	84	<0.5	<5.0	<0.5	<0.5
MW-6	02/05/92	51,000	--	5,400	3,500	3,600	10,000	--	--	--	--	--	--	--
MW-6	09/11/92	24,000	--	2,500	830	1,400	2,300	--	--	--	--	--	--	--
MW-6	12/22/92	23,000	--	5,100	630	2,000	3,100	--	--	--	--	--	--	--
MW-6	03/03/93	18,000	--	4,400	820	1,400	2,400	--	--	--	--	--	--	--
MW-6	06/23/93	18,000	--	4,600	850	2,700	3,400	--	--	--	--	--	--	--
MW-6	09/30/93	--	--	--	--	--	--	--	--	--	--	--	--	--
MW-6	02/06/94	20,000	--	4,600	690	2,100	2,500	--	--	--	--	--	--	--
MW-6	05/02/94	5,300	--	930	54	610	240	--	--	--	--	--	--	--
MW-6	07/01/94	10,000	--	1,500	160	850	690	--	--	--	--	--	--	--
MW-6	09/20/94	11,000	--	2,000	140	1,200	760	--	--	--	--	--	--	--
MW-6	12/06/94	8,600	--	1,300	87	980	610	--	--	--	--	--	--	--
MW-6	03/10/95	--	--	--	--	--	--	--	--	--	--	--	--	--
MW-6	03/15/95	9,800	--	1,600	110	1,000	1,000	--	--	--	--	--	--	--
MW-6	09/23/96	12,000	--	520	55	930	350	--	--	51	--	--	--	--
MW-6	12/04/96	11,000	--	390	25	680	170	--	--	130	--	--	--	--
MW-6	04/08/97	17,000	--	700	92	1,400	900	--	--	2,700	--	--	--	--
MW-6	06/30/97	11,000	--	270	37	590	450	--	--	<	--	--	--	--
MW-6	11/25/97	9,100	--	130	26	500	150	--	--	310	--	--	--	--
MW-6	06/01/98	14,000	--	190	50	680	400	--	--	160	--	--	--	--
MW-6	06/14/01	6,400	--	29	6.3	200	55	--	--	<20	--	--	--	--
MW-6	11/07/01	7,200	--	34	8.7	180	31	<5.0	<5.0	<5.0	<5.0	<50	--	--
MW-6	01/30/02	6,600	--	32	7.2	130	28	<5.0	<5.0	<5.0	<5.0	<50	--	--
MW-6	05/29/02	5,200	--	26	7	150	27	<0.5	<0.5	<5.0	<0.5	<50	--	--
MW-6	08/14/02	5,300	--	24	6.6	120	22	<2.0	<2.0	<2.0	<2.0	<20	--	--
MW-6	11/15/02	5,000	--	19	4.7	70	38	<0.5	<0.5	<0.5	<0.5	<5.0	--	--
MW-6	10/25/04	3,600	--	9.8	2.1	83	16	<0.50	<0.50	2.3	<0.50	<5.0	--	--
MW-6	12/23/04	2,100	--	8.2	1.3	10	2.4	<0.90	<0.90	1.5	<0.90	<5.0	--	--
MW-6	02/25/05	2,500	--	6.6	1.4	29	5.2	<0.50	<0.50	0.74	<0.50	<5.0	--	--
MW-6	05/19/05	3,800	--	7.5	2.2	54	12	<0.50	<0.50	3.1	<0.50	<5.0	--	--
MW-6	09/15/05	1,900	--	2.9	0.88	12	2.7	<0.50	<0.50	0.94	<0.50	<5.0	--	--
MW-6	11/10/05	1,700	--	2.1	0.6	5.4	1.7	<0.50	<0.50	0.81	<0.50	<5.0	--	--
MW-6	03/20/06	2,300	--	3.6	1.0	12	3.9	<0.50	<0.50	1.1	<0.50	<5.0	--	--
MW-6	05/25/06	2,400	--	5	1.8	31	14	<0.50	<0.50	3	<0.50	<5.0	--	--
MW-6	08/23/06	2,300	--	2.3	0.84	7.8	4.2	<0.50	<0.50	1.7	<0.50	<5.0	--	--
MW-6	03/14/07	3,300	--	2.8	0.7	49	6.5	<0.50	<0.50	10	<0.50	<5.0	--	--
MW-6	06/12/07	2,000	--	1.4	0.54	3.2	2.1	<0.50	<0.50	32	<0.50	<5.0	--	--
MW-6	08/01/07	1,500	--	0.99	0.4	2.1	1.2	<0.12	<0.13	50	<0.17	<6.9	--	--
MW-6	02/27/08	1,520	--	<0.18	<0.24	2.4	1.3	<0.20	<0.23	140	<0.19	<10	--	--
MW-6	05/13/08	1,530	--	1.0	0.8	4.0	1.5	<0.5	<0.5	127	<0.5	<5.0	--	--
MW-6	08/27/08	Could not locate	--	--	--	--	--	--	--	--	--	--	--	--
MW-6	11/18/08	Could not locate	--	--	--	--	--	--	--	--	--	--	--	--
MW-6	03/11/09	Could not locate	--	--	--	--	--	--	--	--	--	--	--	--
MW-6	03/09/10	Could not locate	--	--	--	--	--	--	--	--	--	--	--	--

TABLE 2
RESULTS OF LABORATORY ANALYSIS OF GROUNDWATER SAMPLES
October 1992 through March 2010
EZ Serve 100877, 525 West A Street, Hayward, CA

Well Number	Date Sampled	TPH-G (ug/l)	TPH-D (mg/L)	Benzene (ug/l)	Toluene (ug/l)	Ethyl-benzene (ug/l)	Total Xylenes (ug/l)	DIPE (ug/l)	ETBE (ug/l)	MTBE (ug/l)	TAME (ug/l)	TBA (ug/l)	1,2-DCA (ug/l)	EDB (ug/l)
MW-7	06/23/93	29,000	--	4,200	71	4,400	5,600	--	--	--	--	--	--	--
MW-7	09/30/93	30,000	--	3,200	71	2,800	3,400	--	--	--	--	--	--	--
MW-7	02/06/94	--	--	--	--	--	--	--	--	--	--	--	--	--
MW-7	05/02/94	5,700	--	630	13	660	400	--	--	--	--	--	--	--
MW-7	07/01/94	3,100	--	180	99	160	520	--	--	--	--	--	--	--
MW-7	09/20/94	6,100	--	540	6	750	730	--	--	--	--	--	--	--
MW-7	12/05/94	3,700	--	280	<10	430	350	--	--	--	--	--	--	--
MW-7	03/10/95	3,900	--	310	<10	540	540	--	--	--	--	--	--	--
MW-7	03/14/95	1,900	--	290	4	26	296	--	--	--	--	--	--	--
MW-7	09/23/96	6,300	--	76	<	420	270	--	--	15	--	--	--	--
MW-7	12/04/96	7,800	--	67	<	600	350	--	--	22	--	--	--	--
MW-7	04/08/97	5,600	--	42	<	240	96	--	--	<	--	--	--	--
MW-7	06/30/97	5,500	--	<	79	<	44	--	--	280	--	--	--	--
MW-7	11/25/97	2,400	--	23	5.4	<	54	--	--	120	--	--	--	--
MW-7	06/01/98	14,000	--	190	50	680	400	--	--	160	--	--	--	--
MW-7	06/14/01	6,400	--	29	6	200	55	--	--	<20	--	--	--	--
MW-7	11/07/01	--	--	--	--	--	--	--	--	--	--	--	--	--
MW-7	01/30/02	6,200	--	1.5	<0.50	96	4.6	<0.5	<0.5	<0.5	<0.5	<50	--	--
MW-7	05/29/02	1,600	--	1	<0.50	3.4	1.9	<0.5	<0.5	<0.5	<0.5	<5.0	--	--
MW-7	08/14/02	4,100	--	1.3	<0.50	74	1.3	<0.5	<0.5	<0.5	<0.5	<5.0	--	--
MW-7	11/15/02	1,000	--	0.6	<0.50	<0.5	0.6	<0.5	<0.5	<0.5	<0.5	<5.0	--	--
MW-7	10/25/04	Could not locate well	--	--	--	--	--	--	--	--	--	--	--	--
MW-7	05/19/05	660	--	<0.50	<0.50	1.8	<0.50	<0.50	<0.50	<0.50	<0.50	<5.0	--	--
MW-7	09/15/05	Could not locate well	--	--	--	--	--	--	--	--	--	--	--	--
MW-7	11/10/05	340	--	<0.50	<0.50	<0.50	<0.50	<0.50	<0.50	<0.50	<0.50	<5.0	--	--
MW-7	03/20/06	Could not locate well	--	--	--	--	--	--	--	--	--	--	--	--
MW-7	05/25/06	Could not locate well	--	--	--	--	--	--	--	--	--	--	--	--
MW-7	08/23/06	380	--	<0.50	<0.50	<0.50	<0.50	<0.50	<0.50	<0.50	<0.50	<5.0	--	--
MW-7	03/14/07	170	--	<0.50	<0.50	<0.50	<0.50	<0.50	<0.50	<0.50	<0.50	<5.0	--	--
MW-7	06/12/07	Could not locate well	--	--	--	--	--	--	--	--	--	--	--	--
MW-7	08/01/07	470	--	<0.12	<0.15	1.7	0.5	<0.12	<0.13	<0.15	<0.17	<6.9	--	--
MW-7	02/27/08	257	--	<0.18	<0.24	<0.21	<0.45	<0.20	<0.23	<0.19	<0.19	<10	--	--
MW-7	05/13/08	241	--	<0.5	<0.5	<0.5	<0.5	<0.5	<0.5	<0.5	<0.5	<5.0	--	--
MW-7	08/27/08	514	--	<0.5	<0.5	0.9	<0.5	<0.5	<0.5	<0.5	<0.5	<5.0	--	--
MW-7	11/18/08	281	--	<0.5	<0.5	0.7	<0.5	<0.5	<0.5	<0.5	<0.5	<5.0	--	--
MW-7	03/11/09	327	--	<0.5	<0.5	1.2	<0.5	<0.5	<0.5	<0.5	<0.5	<5.0	--	--
MW-7	09/22/09	216	--	<0.5	<0.5	<0.5	<0.5	<0.5	<0.5	<0.5	<0.5	<5.0	--	--
MW-7	03/09/10	143	--	<0.5	<0.5	<0.5	<0.5	<0.5	<0.5	<0.5	<0.5	<5.0	--	--
MW-7	09/09/10	100	<0.1	<0.5	<0.5	<0.5	<0.5	<1.0	<1.0	0.5	<1.0	<10	<0.5	<0.5
MW-7	01/25/11	218	--	<0.5	<0.5	<0.5	<0.5	<0.5	<0.5	0.7	<0.5	<5.0	<0.5	<0.5
MW-8	06/23/93	350	--	43	9	35	67	--	--	--	--	--	--	--
MW-8	09/30/93	2,700	--	190	340	170	720	--	--	--	--	--	--	--
MW-8	02/06/94	<100	--	<1	1	1	2	--	--	--	--	--	--	--
MW-8	05/02/94	<100	--	<1	3	<1	7	--	--	--	--	--	--	--
MW-8	07/01/94	300	--	18	48	19	37	--	--	--	--	--	--	--
MW-8	09/20/94	<100	--	<1	<1	<1	<1	--	--	--	--	--	--	--
MW-8	12/05/94	<50	--	<0.5	<0.5	<0.5	<0.5	--	--	--	--	--	--	--
MW-8	03/10/95	--	--	--	--	--	--	--	--	--	--	--	--	--
MW-8	03/15/95	<50	--	<0.5	<0.5	<0.5	1	--	--	--	--	--	--	--
MW-8	09/23/96	<	--	<	<	<	<	<	<	<	<	<	<	<
Not sampled, well inaccessible since 4th quarter, 1996														
MW-9	06/23/93	45,000	--	14,000	1,200	2,800	12,000	--	--	--	--	--	--	--
MW-9	09/30/93	86,000	--	22,000	1,100	3,300	15,000	--	--	--	--	--	--	--
MW-9	02/06/94	43,000	--	10,000	460	2,100	7,500	--	--	--	--	--	--	--
MW-9	05/02/94	17,000	--	5,400	270	1,300	4,700	--	--	--	--	--	--	--
MW-9	07/01/94	10,000	--	2,100	120	450	1,300	--	--	--	--	--	--	--
MW-9	09/20/94	7,500	--	2,200	97	400	1,200	--	--	--	--	--	--	--
MW-9	12/05/94	10,000	--	2,700	130	530	1,600	--	--	--	--	--	--	--
MW-9	03/10/95	--	--	--	--	--	--	--	--	--	--	--	--	--
MW-9	03/15/95	18,000	--	5,900	270	1,200	3,680	--	--	--	--	--	--	--
Not sampled, well inaccessible since 1st quarter, 1995														

TABLE 2
RESULTS OF LABORATORY ANALYSIS OF GROUNDWATER SAMPLES
October 1992 through March 2010
EZ Serve 100877, 525 West A Street, Hayward, CA

Well Number	Date Sampled	TPH-G (ug/l)	TPH-D (mg/L)	Benzene (ug/l)	Toluene (ug/l)	Ethyl-benzene (ug/l)	Total Xylenes (ug/l)	DIPE (ug/l)	ETBE (ug/l)	MTBE (ug/l)	TAME (ug/l)	TBA (ug/l)	1,2-DCA (ug/l)	EDB (ug/l)
MW-10	06/23/93	35,000	--	980	640	3,500	12,000	--	--	--	--	--	--	--
MW-10	09/30/93	4,000	--	230	12	100	680	--	--	--	--	--	--	--
MW-10	02/06/94	2,000	--	69	12	220	120	--	--	--	--	--	--	--
MW-10	05/02/94	710	--	16	6	85	62	--	--	--	--	--	--	--
MW-10	07/01/94	2,000	--	52	43	120	210	--	--	--	--	--	--	--
MW-10	09/20/94	2,800	--	34	16	270	560	--	--	--	--	--	--	--
MW-10	12/05/94	2,700	--	30	13	260	430	--	--	--	--	--	--	--
MW-10	03/10/95	--	--	--	--	--	--	--	--	--	--	--	--	--
MW-10	03/15/95	1,400	--	18	6	200	239	--	--	--	--	--	--	--
MW-10	09/23/96	3,800	--	4	2.9	220	170	--	--	397	--	--	--	--
MW-10	12/04/96	4,600	--	1.6	7.7	260	150	--	--	20	--	--	--	--
Not sampled, well inaccessible since 4th quarter, 1996														
MW-11	02/10/95	7,000	--	140	22	600	1,000	--	--	--	--	--	--	--
MW-11	03/10/95	--	--	--	--	--	--	--	--	--	--	--	--	--
MW-11	03/15/95	6,000	--	200	17	750	1,276	--	--	--	--	--	--	--
MW-11	09/23/96	27,000	--	55	81	300	3,500	--	--	40	--	--	--	--
MW-11	12/04/96	--	--	--	--	--	--	--	--	--	--	--	--	--
MW-11	04/08/97	24,000	--	280	130	3,000	3,700	--	--	<	--	--	--	--
Not sampled, well inaccessible since 2nd quarter, 1997														
MW-12	02/10/95	<50	--	<0.5	<0.5	<0.5	<0.5	--	--	--	--	--	--	--
MW-12	03/10/95	--	--	--	--	--	--	--	--	--	--	--	--	--
MW-12	03/14/95	<50	--	<0.5	<0.5	<0.5	0.9	--	--	--	--	--	--	--
MW-12	09/23/96	<	--	<	1.6	<	<	--	--	--	--	--	--	--
MW-12	12/04/96	<	--	3.2	<	1.9	3.4	--	--	--	--	--	--	--
MW-12	04/08/97	<	--	<	<	<	<	--	--	--	--	--	--	--
MW-12	06/30/97	--	--	--	--	--	--	--	--	--	--	--	--	--
MW-12	11/25/97	--	--	--	--	--	--	--	--	--	--	--	--	--
MW-12	06/01/98	--	--	--	--	--	--	--	--	--	--	--	--	--
MW-12	06/14/01	<50	--	<0.50	<0.50	<0.50	<0.50	--	--	<5.0	--	--	--	--
MW-12	11/07/01	<50	--	<0.5	<0.5	<0.5	<0.5	<0.5	<0.5	<0.5	<0.5	<5.0	--	--
MW-12	01/30/02	<50	--	<0.5	<0.5	<0.5	<0.5	<0.5	<0.5	<0.5	<0.5	<5.0	--	--
MW-12	05/29/02	<50	--	<0.5	<0.5	<0.5	<0.5	<0.5	<0.5	<0.5	<0.5	<5.0	--	--
MW-12	08/14/02	<50	--	<0.5	<0.5	<0.5	<0.5	<0.5	<0.5	<0.5	<0.5	<5.0	--	--
MW-12	11/15/02	<50	--	<0.5	<0.5	<0.5	<0.5	<0.5	<0.5	<0.5	<0.5	<5.0	--	--
MW-12	10/25/04	Not Accessible												
MW-12	02/25/05	<50	--	<0.5	<0.5	<0.5	<0.5	<0.5	<0.5	<0.5	<0.5	<5.0	--	--
MW-12	05/19/05	<50	--	<0.5	<0.5	<0.5	<0.5	<0.5	<0.5	<0.5	<0.5	<5.0	--	--
MW-12	09/15/05	<50	--	<0.5	<0.5	<0.5	<0.5	<0.5	<0.5	<0.5	<0.5	<5.0	--	--
MW-12	11/10/05	<50	--	<0.50	<0.50	<0.50	<0.50	<0.50	<0.50	<0.50	<0.50	<5.0	--	--
MW-12	03/20/06	<50	--	<0.50	<0.50	<0.50	<0.50	<0.50	<0.50	<0.50	<0.50	<5.0	--	--
MW-12	05/25/06	<50	--	<0.50	<0.50	<0.50	<0.50	<0.50	<0.50	<0.50	<0.50	<5.0	--	--
MW-12	08/23/06	<50	--	<0.50	<0.50	<0.50	<0.50	<0.50	<0.50	<0.50	<0.50	<5.0	--	--
MW-12	03/14/07	<50	--	<0.50	<0.50	<0.50	<0.50	<0.50	<0.50	<0.50	<0.50	<5.0	--	--
MW-12	06/11/07	<50	--	<0.50	<0.50	<0.50	<0.50	<0.50	<0.50	<0.50	<0.50	<5.0	--	--
MW-12	08/01/07	45	--	<0.12	<0.15	<0.17	<0.34	<0.12	<0.13	<0.15	<0.17	<6.9	--	--
MW-12	02/27/08	<6.6	--	<0.18	<0.24	<0.21	<0.45	<0.20	<0.23	<0.19	<0.19	<10	--	--
MW-12	05/13/08	<50	--	<0.5	<0.5	<0.5	<0.5	<0.5	<0.5	<0.5	<0.5	<5.0	--	--
MW-12	08/27/08	<50	--	<0.5	<0.5	<0.5	<0.5	<0.5	<0.5	<0.5	<0.5	<5.0	--	--
MW-12	11/18/08	<50	--	<0.5	<0.5	<0.5	<0.5	<0.5	<0.5	<0.5	<0.5	<5.0	--	--
MW-12	03/11/09	<50	--	<0.5	<0.5	<0.5	<0.5	<0.5	<0.5	<0.5	<0.5	<5.0	--	--
MW-12	09/22/09	<50	--	<0.5	<0.5	<0.5	<0.5	<0.5	<0.5	<0.5	<0.5	<5.0	--	--
MW-12	03/09/10	<50	--	<0.5	<0.5	<0.5	<0.5	<0.5	<0.5	<0.5	<0.5	<5.0	--	--
MW-12	01/25/11	<50	--	<0.5	<0.5	<0.5	<0.5	<0.5	<0.5	<0.5	<0.5	<5.0	<0.5	<0.5
MW-13	02/10/95	<50	--	<0.5	<0.5	<0.5	<0.5	--	--	--	--	--	--	--
MW-13	03/10/95	--	--	--	--	--	--	--	--	--	--	--	--	--
MW-13	03/14/95	<50	--	<0.5	<0.5	<0.5	1	--	--	--	--	--	--	--
MW-13	09/23/96	<	--	<	0.8	1	<	--	--	<	--	--	--	--
MW-13	12/04/96	--	--	--	--	--	--	--	--	--	--	--	--	--

TABLE 2
RESULTS OF LABORATORY ANALYSIS OF GROUNDWATER SAMPLES
October 1992 through March 2010
EZ Serve 100877, 525 West A Street, Hayward, CA

Well Number	Date Sampled	TPH-G (ug/l)	TPH-D (mg/L)	Benzene (ug/l)	Toluene (ug/l)	Ethyl-benzene (ug/l)	Total Xylenes (ug/l)	DIPE (ug/l)	ETBE (ug/l)	MTBE (ug/l)	TAME (ug/l)	TBA (ug/l)	1,2-DCA (ug/l)	EDB (ug/l)	
MW-13	04/08/97	<	--	<	<	<	<	--	--	<	--	--	--	--	
MW-13	06/30/97	--	--	--	--	--	--	--	--	--	--	--	--	--	
MW-13	11/25/97	--	--	--	--	--	--	--	--	--	--	--	--	--	
MW-13	06/01/98	--	--	--	--	--	--	--	--	--	--	--	--	--	
MW-13	06/14/01	<50	--	<0.50	<0.50	<0.50	<0.50	--	--	<5.0	--	--	--	--	
MW-13	11/07/01	<50	--	<0.5	<0.5	<0.5	<0.5	<0.5	<0.5	<0.5	<0.5	<5.0	--	--	
MW-13	01/30/02	<50	--	<0.5	<0.5	<0.5	<0.5	<0.5	<0.5	<0.5	<0.5	<5.0	--	--	
MW-13	05/29/02	<50	--	<0.5	<0.5	<0.5	<0.5	<0.5	<0.5	<0.5	<0.5	<5.0	--	--	
MW-13	08/14/02	<50	--	<0.5	<0.5	<0.5	<0.5	<0.5	<0.5	<0.5	<0.5	<5.0	--	--	
MW-13	11/15/02	--	--	--	--	--	--	--	--	--	--	--	--	--	
MW-13	10/25/04	Not sampled since 4th quarter, 2004						--	--	--	--	--	--	--	--
MW-14	02/10/95	12,000	--	42	8	740	2,100	--	--	--	--	--	--	--	
MW-14	03/10/95	--	--	--	--	--	--	--	--	--	--	--	--	--	
MW-14	03/14/95	1,400	--	6	2	36	298	--	--	--	--	--	--	--	
MW-14	09/23/96	6,400	--	2.8	<	690	96	--	--	9.6	--	--	--	--	
MW-14	12/04/96	9,500	--	6.3	<	1,100	400	--	--	30	--	--	--	--	
MW-14	04/08/97	2,900	--	<	2.7	220	21	--	--	<	--	--	--	--	
MW-14	06/30/97	74	--	1.3	<	0.51	0.68	--	--	<	--	--	--	--	
MW-14	11/25/97	<	--	<	<	<	<	--	--	<	--	--	--	--	
MW-14	06/01/98	<50	--	<0.5	<0.5	<0.5	<0.5	--	--	<5	--	--	--	--	
MW-14	06/14/01	470	--	<0.5	<0.5	2.8	1	--	--	<5	--	--	--	--	
MW-14	11/07/01	<50	--	<0.5	<0.5	<0.5	<0.5	<0.5	<0.5	<0.5	<0.5	<5.0	--	--	
MW-14	01/30/02	<50	--	<0.5	<0.5	<0.5	<0.5	<0.5	<0.5	<0.5	<0.5	<5.0	--	--	
MW-14	05/29/02	<50	--	<0.5	<0.5	<0.5	<0.5	<0.5	<0.5	<0.5	<0.5	<5.0	--	--	
MW-14	08/14/02	<50	--	<0.5	<0.5	<0.5	<0.5	<0.5	<0.5	<0.5	<0.5	<5.0	--	--	
MW-14	11/15/02	<50	--	<0.5	<0.5	<0.5	<0.5	<0.5	<0.5	<0.5	<0.5	<5.0	--	--	
MW-14	10/25/04	Not Accessible		--	--	--	--	--	--	--	--	--	--	--	
MW-14	02/25/05	210	--	<0.5	<0.5	<0.5	<0.5	<0.5	<0.5	<0.5	<0.5	<5.0	--	--	
MW-14	05/19/05	230	--	<0.5	<0.5	<0.5	<0.5	<0.5	<0.5	<0.5	<0.5	<5.0	--	--	
MW-14	09/15/05	Not Accessible		--	--	--	--	--	--	--	--	--	--	--	
MW-14	11/10/05	Not Accessible		--	--	--	--	--	--	--	--	--	--	--	
MW-14	03/20/06	180	--	<0.5	<0.5	<0.5	<0.5	<0.5	<0.5	<0.5	<0.5	<5.0	--	--	
MW-14	05/25/06	<50	--	<0.5	<0.5	<0.5	<0.5	<0.5	<0.5	<0.5	<0.5	<5.0	--	--	
MW-14	08/23/06	99	--	<0.5	<0.5	<0.5	<0.5	<0.5	<0.5	<0.5	<0.5	<5.0	--	--	
MW-14	03/14/07	<50	--	<0.5	<0.5	<0.5	<0.5	<0.5	<0.5	<0.5	<0.5	<5.0	--	--	
MW-14	06/11/07	<50	--	<0.5	<0.5	<0.5	<0.5	<0.5	<0.5	<0.5	<0.5	<5.0	--	--	
MW-14	08/01/07	53	--	<0.12	<0.15	<0.17	<0.34	<0.12	<0.13	<0.15	<0.17	<6.9	--	--	
MW-14	02/27/08	<6.6	--	<0.18	<0.24	<0.21	<0.45	<0.20	<0.23	<0.19	<0.19	<10	--	--	
MW-14	05/13/08	<50	--	<0.5	<0.5	<0.5	<0.5	<0.5	<0.5	<0.5	<0.5	<5.0	--	--	
MW-14	08/27/08	<50	--	<0.5	<0.5	<0.5	<0.5	<0.5	<0.5	<0.5	<0.5	<5.0	--	--	
MW-14	11/18/08	<50	--	<0.5	<0.5	<0.5	<0.5	<0.5	<0.5	<0.5	<0.5	<5.0	--	--	
MW-14	03/11/09	<50	--	<0.5	<0.5	<0.5	<0.5	<0.5	<0.5	<0.5	<0.5	<5.0	--	--	
MW-14	09/22/09	<50	--	<0.5	<0.5	<0.5	<0.5	<0.5	<0.5	<0.5	<0.5	<5.0	--	--	
MW-14	03/09/10	<50	--	<0.5	<0.5	<0.5	<0.5	<0.5	<0.5	<0.5	<0.5	<5.0	--	--	
MW-14	01/25/11	<50	--	<0.5	<0.5	<0.5	<0.5	<0.5	<0.5	<0.5	<0.5	<5.0	<0.5	<0.5	
EX-1	08/14/02	250	--	31	<0.5	<0.5	4	<0.5	<0.5	1.4	<0.5	<5.0	--	--	
EX-1	11/15/02	67	--	4.1	<0.5	<0.5	<0.5	<0.5	<0.5	0.7	<0.5	<5.0	--	--	
EX-1	10/25/04	96	--	2.1	<0.50	4.9	1.8	<0.5	<0.5	<0.5	<0.5	<5.0	--	--	
EX-1	12/23/04	<50	--	<0.50	<0.50	0.87	<0.50	<0.50	<0.50	<0.50	<0.50	<5.0	--	--	
EX-1	02/25/05	59	--	1.4	<0.50	2	0.87	<0.50	<0.50	<0.50	<0.50	<5.0	--	--	
EX-1	05/19/05	200	--	3.4	<0.50	3.7	1.8	<0.50	<0.50	1.3	<0.50	<5.0	--	--	
EX-1	09/15/05	290	--	7.5	<0.50	2.8	0.66	<0.50	<0.50	1.2	<0.50	<5.0	--	--	
EX-1	11/10/05	270	--	5.1	<0.50	9.2	1.5	<0.50	<0.50	0.94	<0.50	<5.0	--	--	
EX-1	03/20/06	820	--	7.5	<0.50	15	7.2	<0.50	<0.50	0.94	<0.50	<5.0	--	--	
EX-1	05/25/06	100	--	<0.50	<0.50	1	0.9	<0.50	<0.50	0.79	<0.50	<5.0	--	--	
EX-1	08/23/06	440	--	7.3	<0.50	0.72	0.61	<0.50	<0.50	1.2	<0.50	<5.0	--	--	
EX-1	03/14/07	360	--	1.6	<0.50	8.8	1.8	<0.50	<0.50	1.7	<0.50	<5.0	--	--	
EX-1	06/11/07	240	--	1.1	<0.50	6.0	1.4	<0.50	<0.50	4.3	<0.50	<5.0	--	--	
EX-1	08/01/07	410	--	2.5	<0.15	4.2	0.92	<0.12	<0.13	3.6	<0.17	<6.9	--	--	

TABLE 2
RESULTS OF LABORATORY ANALYSIS OF GROUNDWATER SAMPLES
October 1992 through March 2010
EZ Serve 100877, 525 West A Street, Hayward, CA

Well Number	Date Sampled	TPH-G (ug/l)	TPH-D (mg/L)	Benzene (ug/l)	Toluene (ug/l)	Ethyl-benzene (ug/l)	Total Xylenes (ug/l)	DIPE (ug/l)	ETBE (ug/l)	MTBE (ug/l)	TAME (ug/l)	TBA (ug/l)	1,2-DCA (ug/l)	EDB (ug/l)
EX-1	02/27/08	Not Accessible			--	--	--	--	--	--	--	--	--	--
EX-1	08/27/08	348	--	0.9	<0.5	0.8	<0.5	<0.5	<0.5	94	<0.5	22	--	--
EX-1	11/18/08	459	--	0.8	<0.5	<0.5	<0.5	<0.5	<0.5	16	<0.5	7.9	--	--
EX-1	03/11/09	371	--	<0.5	<0.5	3.6	<0.5	<0.5	<0.5	151	<0.5	<5.0	--	--
EX-1	09/22/09	295	--	<0.5	<0.5	<0.5	<0.5	<0.5	<0.5	79	<0.5	<5.0	--	--
EX-1	03/09/10	344	--	0.5	<0.5	1.2	<0.5	<0.5	<0.5	239	<0.5	<5.0	--	--
EX-1	09/09/10	759	<0.1	2.1	<1.0	1.3	<1.0	<2.0	<2.0	217	<2.0	<20.0	<1.0	<1.0
EX-1	01/25/11	Not Sampled												
VEAS-2	02/25/05	90	--	1.1	<0.50	0.7	1.3	<0.50	<0.50	1.4	<0.50	<5.0	--	--
VEAS-2	05/19/05	<50	--	<0.50	<0.50	<0.50	<0.50	<0.50	<0.50	<0.50	<0.50	<5.0	--	--
VEAS-2	11/10/05	--	--	--	--	--	--	--	--	--	--	--	--	--

Notes:

TPH-G = total petroleum hydrocarbons with gasoline distinctic

MTBE = methyl tertiary butyl ethe

DIPE = di-isopropyl ethe

ETBE = ethyl-tert-butyl ethe

TAME = tert-amyl methyl ethe

TBA = tert butano

1,2-DCA = 1,2-Dichloroethane

EDB = 1,2-Dibromoethane

ug/l = micrograms per liter

mg/L = milligrams per liter

-- = not analyzed, measured, or collected

< = Sample reported as "not detected", in previous tables, reporting limit not known (Delta Environment

Note: No known groundwater sampling was conducted between June 1, 1998 and June 14, 2001, June 14, 2001 and November 7, 2001

Wellhead elevations resurveyed on January 30, 2002.

FIGURES

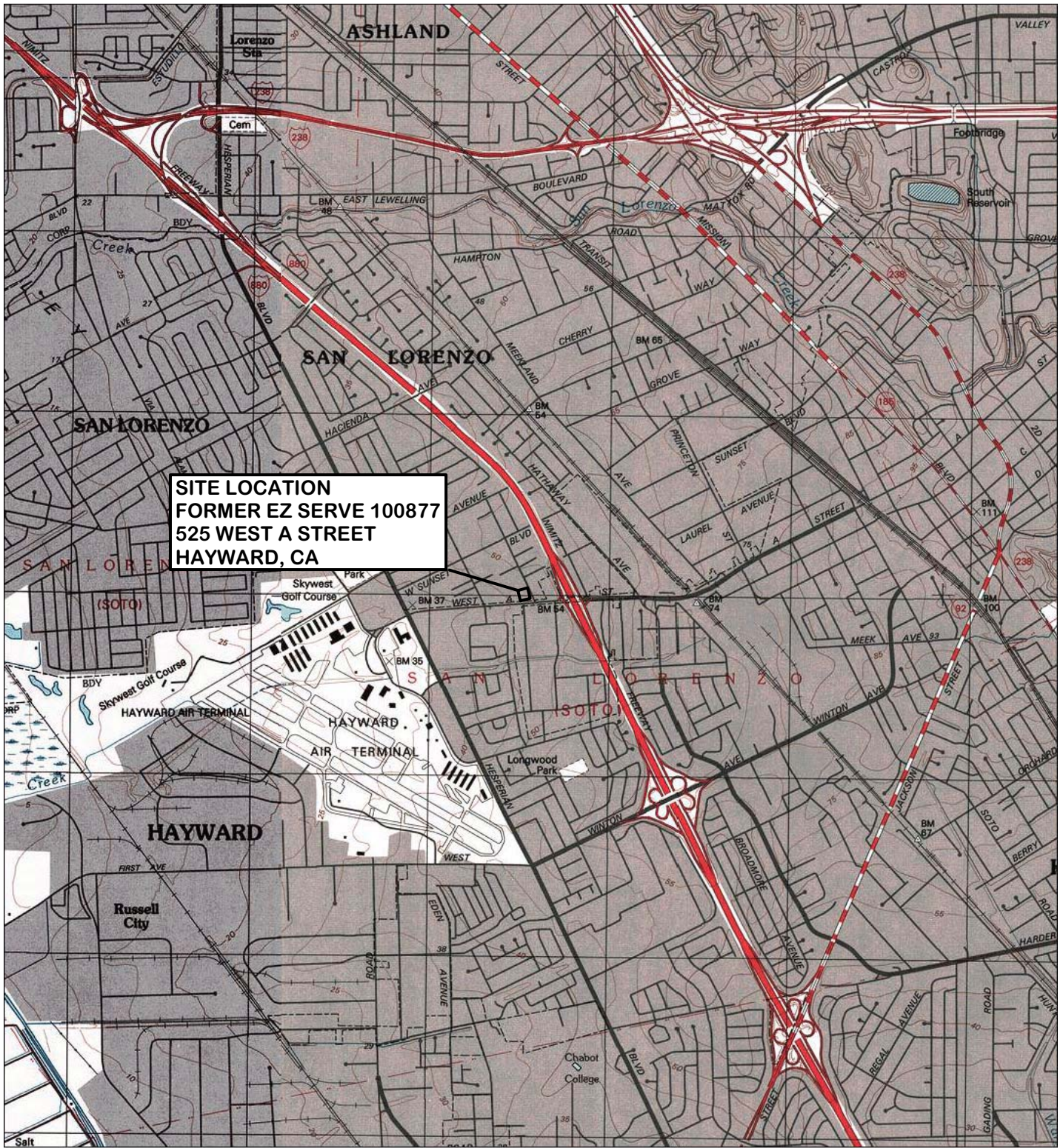

0 1000 FEET 0 500 1000 METERS
 0 5 1 MILE
 Printed from TOPO! ©2001 National Geographic Holdings (www.topo.com)

GEOENVIRO SERVICES, INC.

SITE LOCATION MAP

FORMER EZ SERVE STATION NO. 100877
 525 WEST A STREET
 HAYWARD, CA

FEBRUARY 2011

FIGURE 1

DRAWN BY: JPS

CLIENT: RPMS
 JOB No.: 07-131



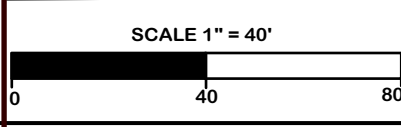
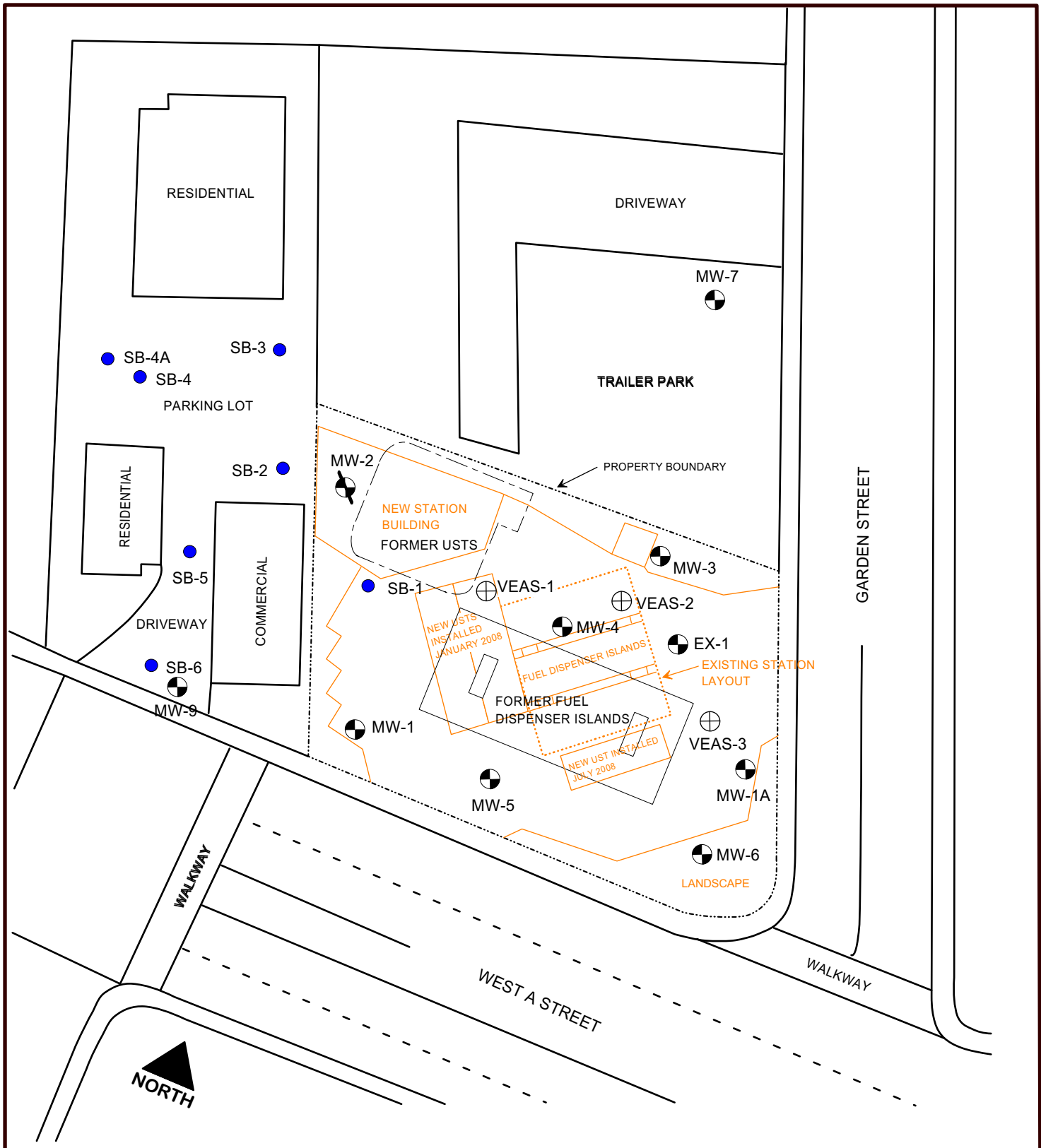

DRAWN BY: JPS
 REVISION DATE: February 28, 2011
 CLIENT: RPMS OF CA
 PROJECT No: 07-131

LEGEND	
MW-1	GROUNDWATER MONITORING WELL
EX-1	GROUNDWATER EXTRACTION WELL
VEAS-2	REMEDIATION WELL
MW-2	DESTROYED GROUNDWATER MONITORING WELL
SB-1	GEOPROBE BORING LOCATION

GEOENVIRO SERVICES, INC.
SITE MAP
FORMER EZ SERVE STATION NO. 100877 525 WEST A STREET HAYWARD, CA ACEHD SITE NO. R0000023
FEBRUARY 2011 FIGURE 2

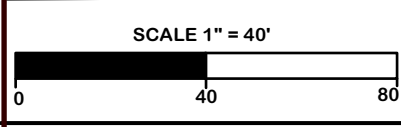
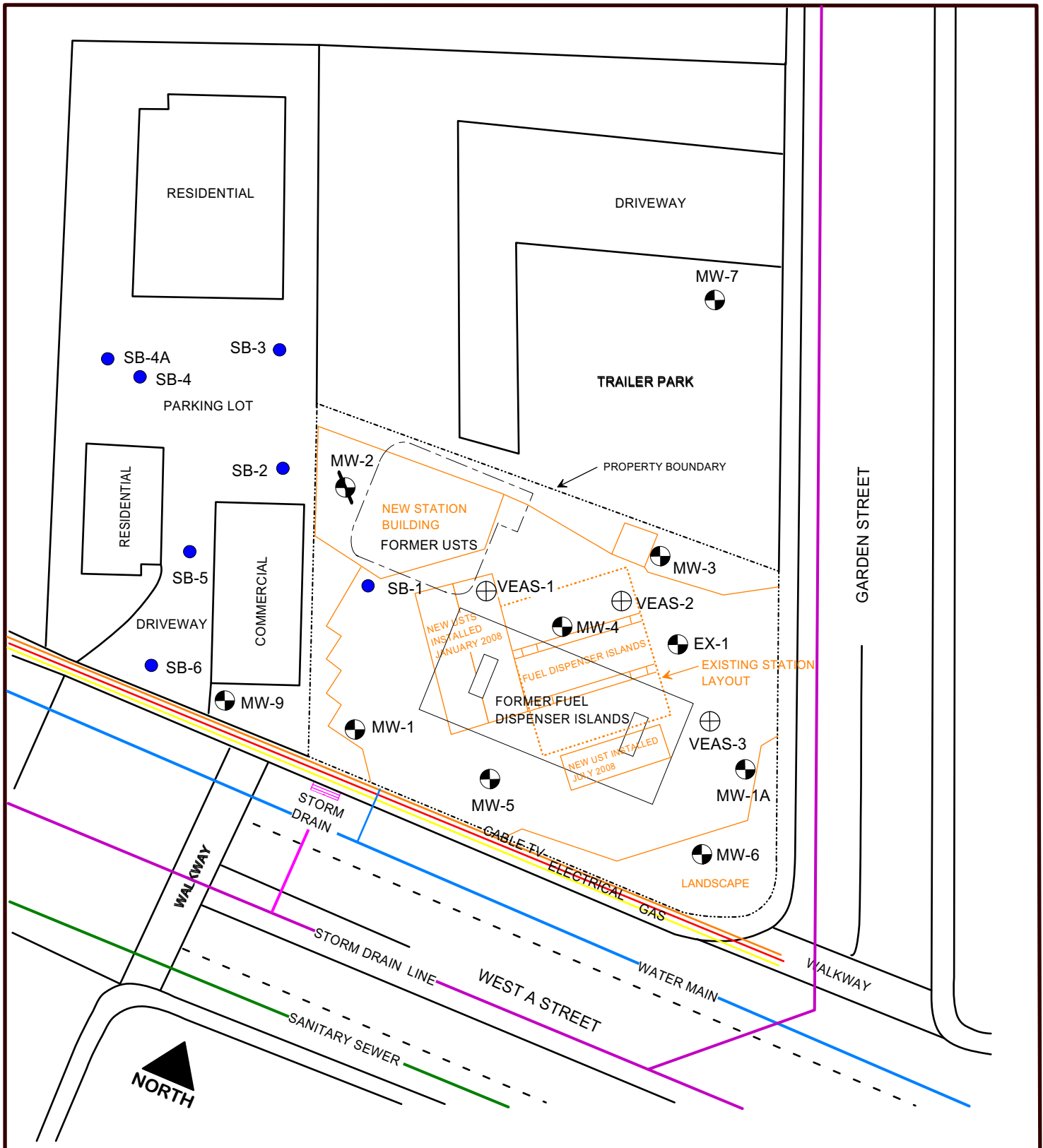

DRAWN BY: JPS
 REVISION DATE: February 28, 2011
 CLIENT: RPMS OF CA
 PROJECT No: 07-131

LEGEND	
MW-1	GROUNDWATER MONITORING WELL
EX-1	GROUNDWATER EXTRACTION WELL
VEAS-2	REMEDIATION WELL
MW-2	DESTROYED GROUNDWATER MONITORING WELL
SB-1	GEOPROBE BORING LOCATION

GEOENVIRO SERVICES, INC.

SITE MAP SHOWING SUBSURFACE UTILITIES IN THE VICINITY OF THE SITE

FORMER EZ SERVE STATION NO. 100877
 525 WEST A STREET
 HAYWARD, CA
 ACEHD SITE NO. R0000023

FEBRUARY 2011 FIGURE 3

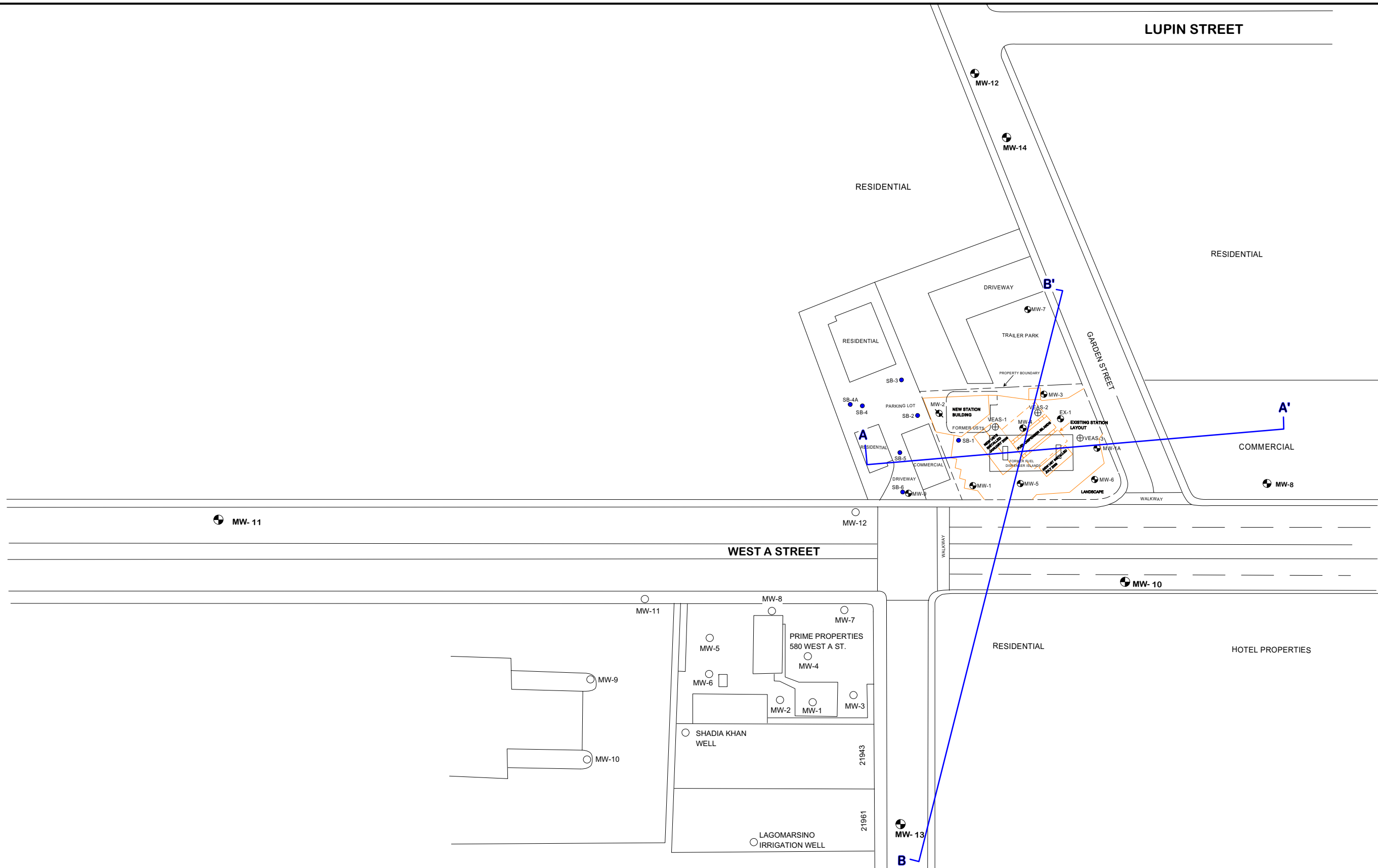

DRAWN BY: JPS
 REVISION DATE: FEBRUARY 15, 2011

CLIENT: RPMS OF CA
 JOB NO.: 07-131

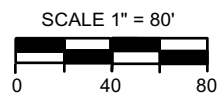

LEGEND	
MW 1	GROUNDWATER MONITORING WELL
SB 1	GROUNDWATER AIR SPARGE WELL
MW-1	PRIME PROPERTIES MONITORING WELL LOCATION 580 WEST A STREET, HAYWARD
VEAS-1	VAPOR EXTRACTION WELL
A A'	LOCATION OF VERTICAL CROSS SECTION A - A'

GEOENVIRO SERVICES, INC.

**SITE MAP WITH LOCATION OF
 VERTICAL CROSS SECTION A - A'**

FORMER EZ SERVE 100877
 525 WEST A STREET, HAYWARD, CA
 ACEHD R0000023

FEBRUARY 2011 **FIGURE 4**

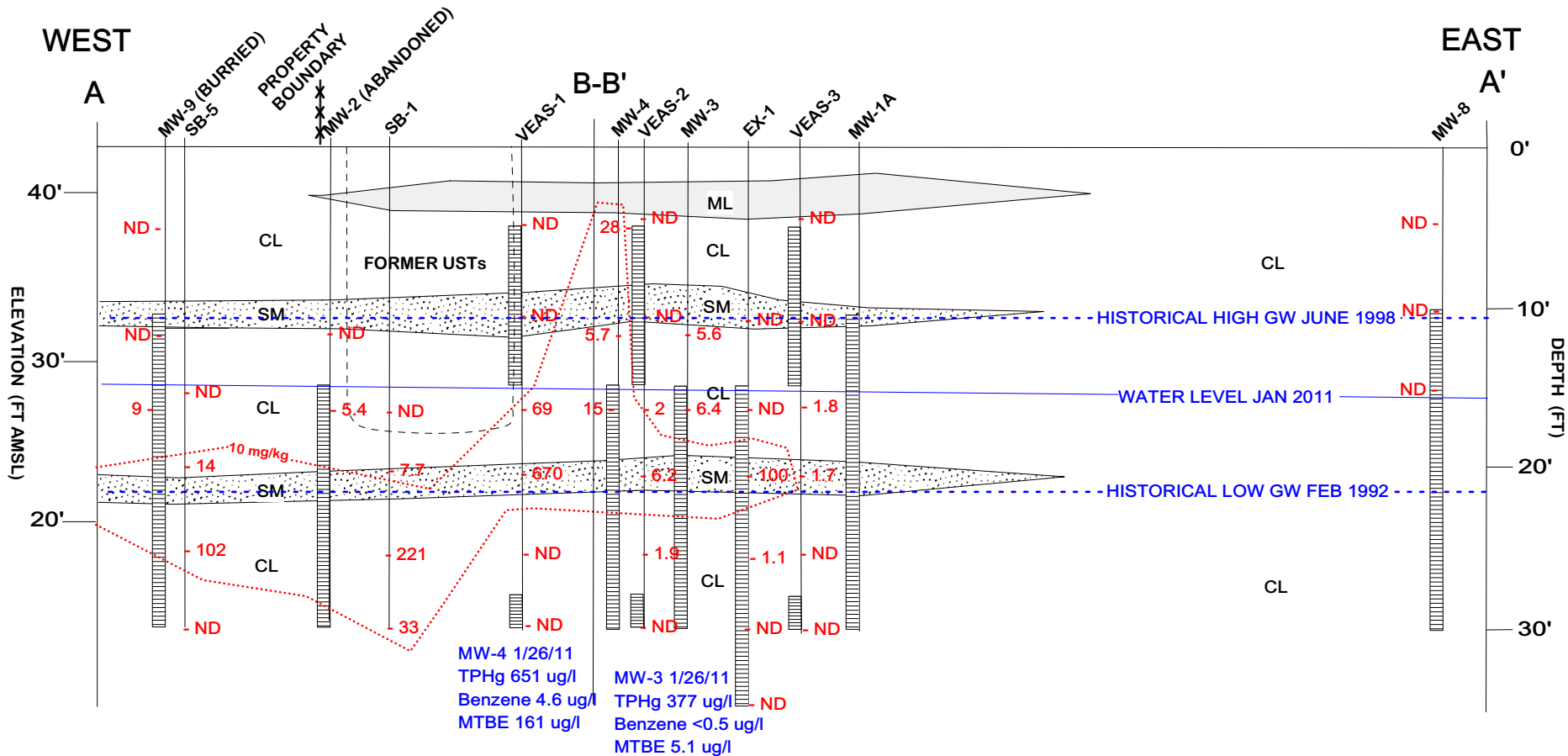

MW-4 1/26/11
 TPHg 651 ug/l
 Benzene 4.6 ug/l
 MTBE 161 ug/l

MW-3 1/26/11
 TPHg 377 ug/l
 Benzene <0.5 ug/l
 MTBE 5.1 ug/l

DRAWN BY: JPS
 REVISION FEBRUARY 25, 2011
 CLIENT: RPMS of CA
 JOB No. 07-131

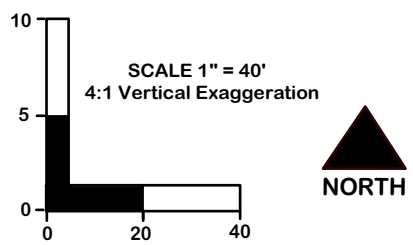

LEGEND		GEOENVIRO SERVICES, INC.
222	SOIL SAMPLE TPHg CONCENTRATION IN mg/kg (ppm)	CROSS SECTION A-A'
- - -	SOIL TPHg CONCENTRATION CONTOUR 10 mg/kg (ppm)	
MW-3 1/26/11 TPHg 377 ug/l Benzene <0.5 ug/l MTBE 5.1 ug/l	GW SAMPLE CONCENTRATION IN ug/L (ppb) COLLECTED IN FIRST QUARTER 2011	FORMER EZ SERVE STATION NO. 100877 525 WEST A STREET HAYWARD, CA
ML	SILT/CLAYEY SILT	FEBRUARY 2011 FIGURE 5
CL	CLAY/SILTY CLAY	
SM	SILTY SAND/SAND	

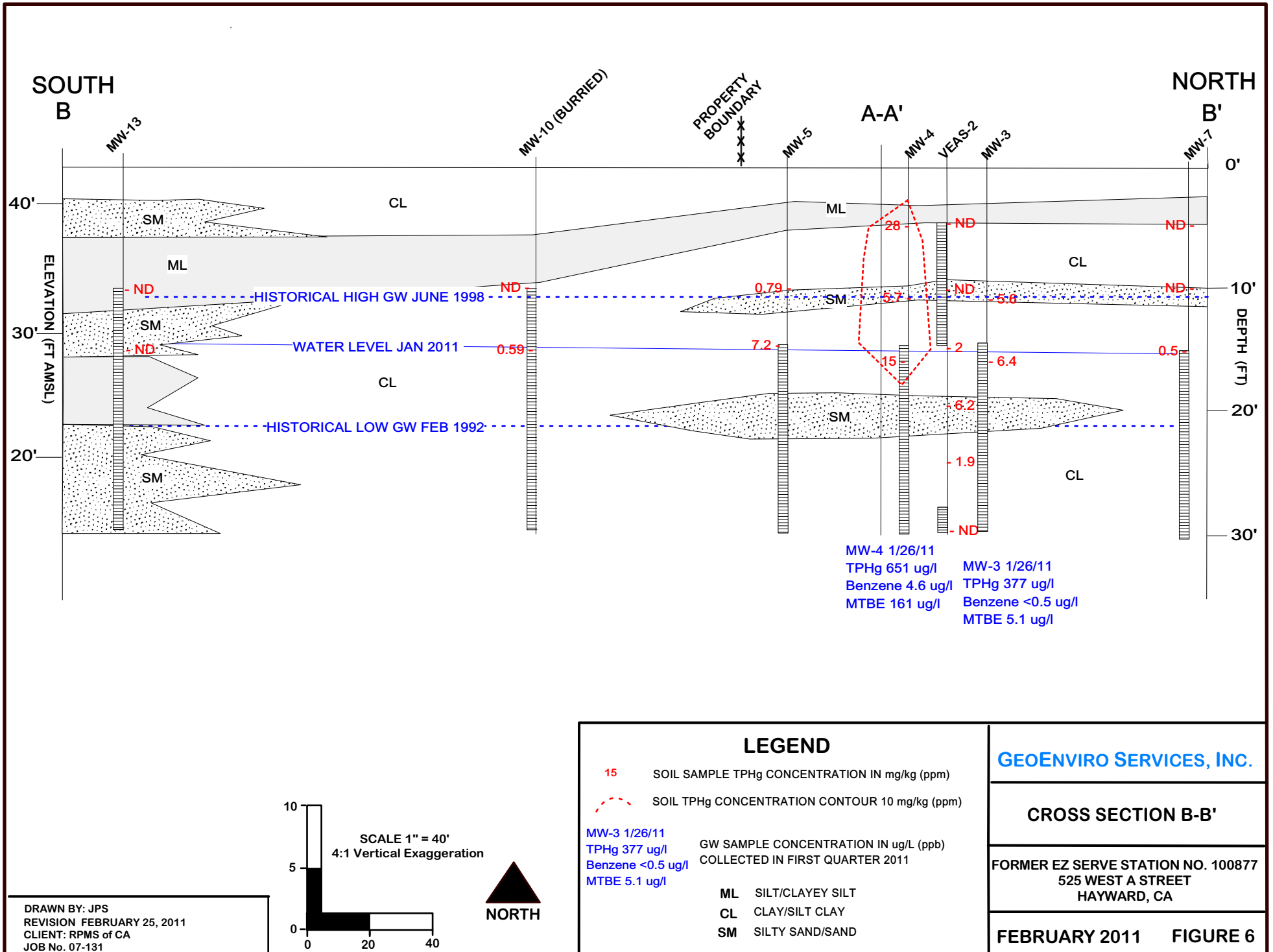

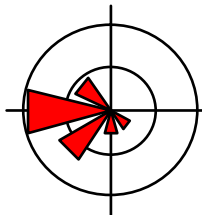
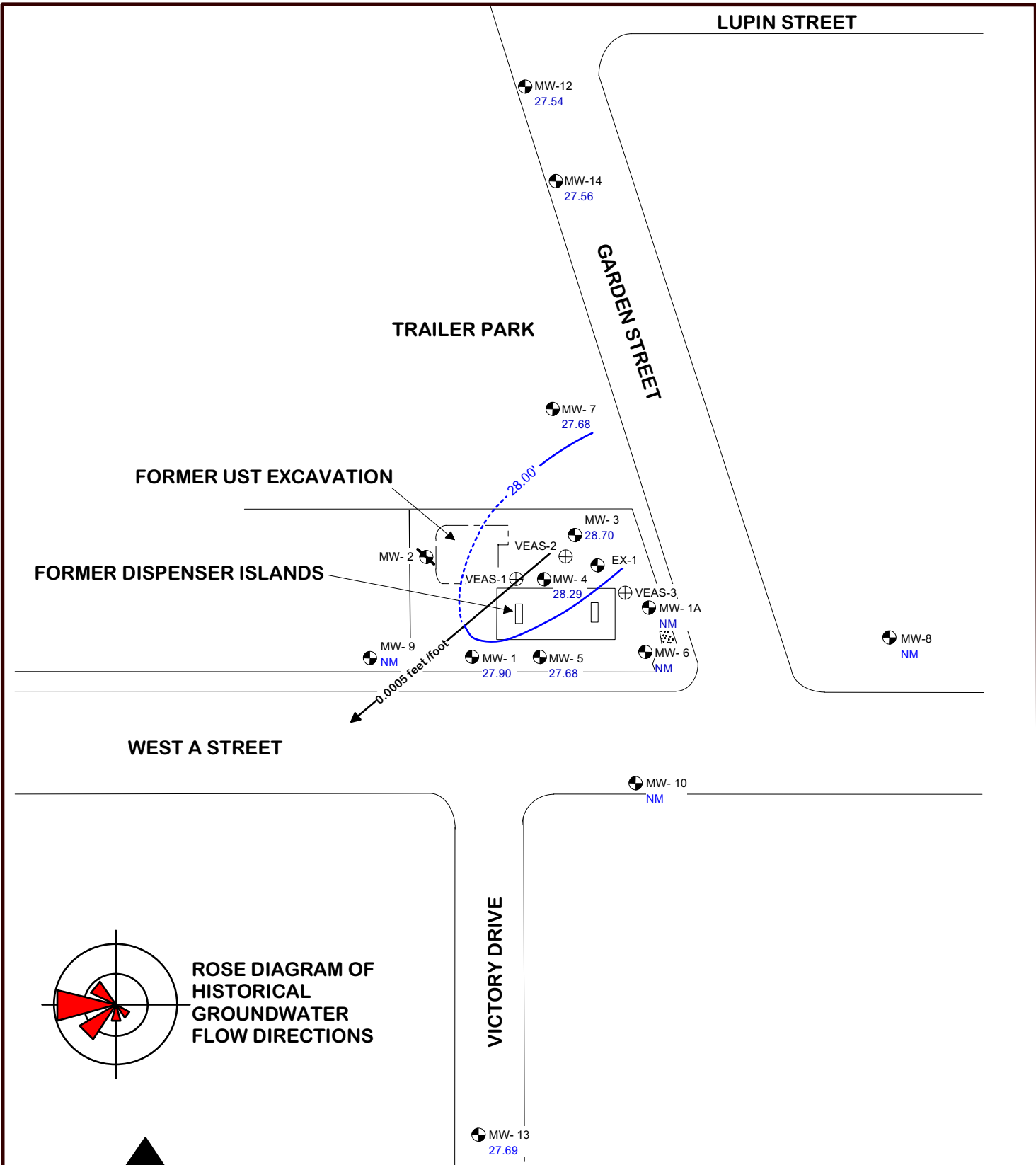

ROSE DIAGRAM OF HISTORICAL GROUNDWATER FLOW DIRECTIONS



SCALE 1" = 80'



DRAWN BY: GRS
 REVISION DATE: FEBRUARY 25, 2011
 CLIENT: RPMS
 JOB No.: 07-131

LEGEND

- MW-1 27.90 GROUNDWATER MONITORING WELL WITH GROUNDWATER ELEVATION IN FEET AMSL AS MEASURED ON 01/25/2011
- EX-1 GROUNDWATER EXTRACTION WELL
- VEAS-2 REMEDIATION WELL NM NOT MEASURED
- MW-2 DESTROYED GROUNDWATER MONITORING WELL
- (28.00') GROUNDWATER ELEVATION CONTOUR IN FEET ABOVE MEAN SEA LEVEL AS MEASURED 01/25/2011

GEOENVIRO SERVICES, INC.

SITE MAP WITH CONTOURS OF GROUNDWATER ELEVATION FIRST QUARTER 2011

FORMER EZ SERVE STATION NO. 100877
 525 WEST A STREET
 HAYWARD, CA

FEBRUARY 2011 FIGURE 7

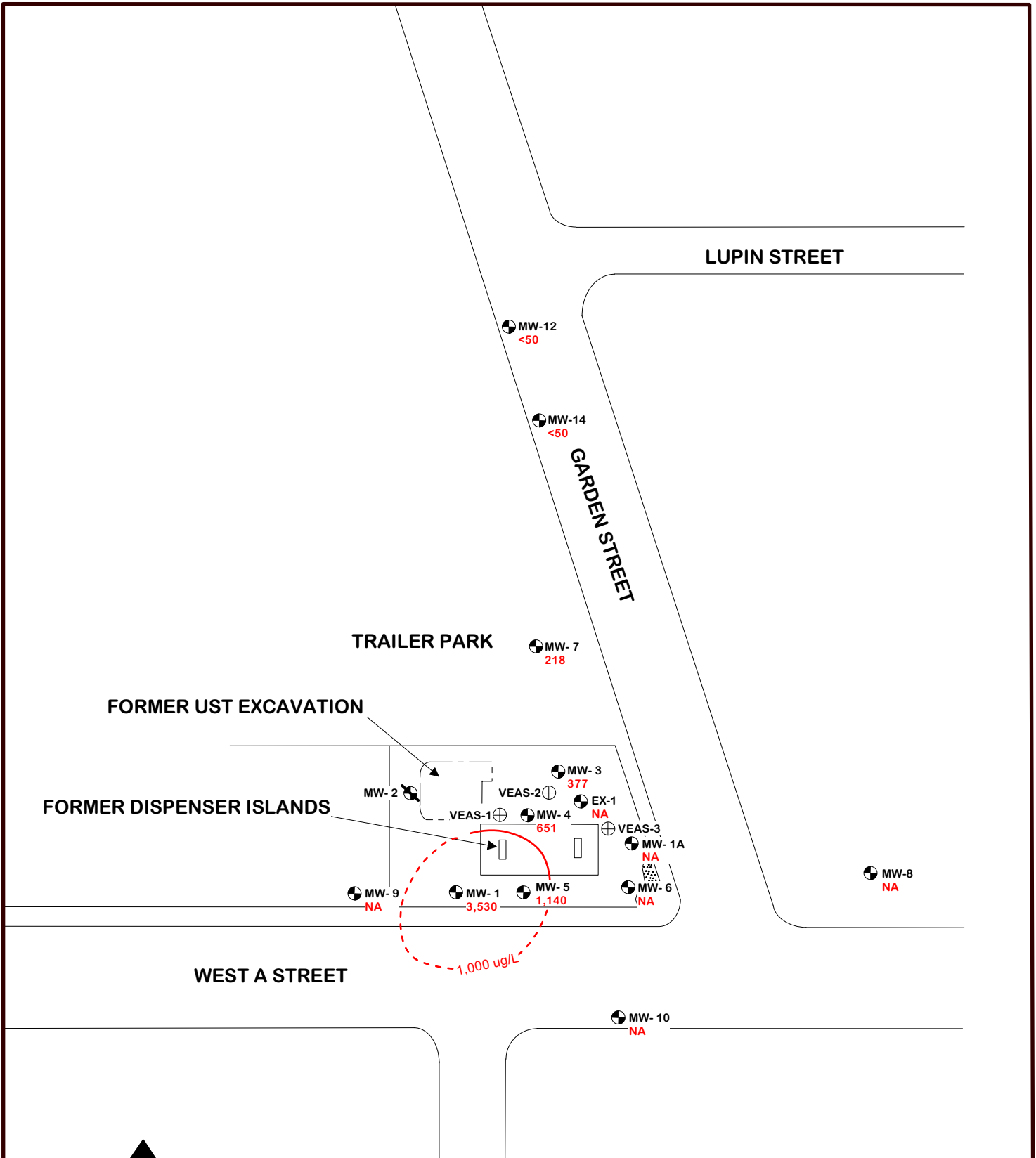

SCALE 1" = 80'

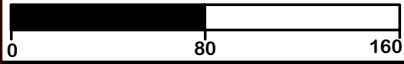

DRAWN BY: JPS
 REVISION DATE: FEBRUARY 25, 2011
 CLIENT: RPMS
 JOB No.: 07-131

LEGEND

- MW-1 3,530 GROUNDWATER MONITORING WELL WITH TPHg CONCENTRATIONS IN ug/L AS MEASURED ON 1/25/2011
- EX-1 NA GROUNDWATER EXTRACTION WELL
- VEAS-2 REMEDIATION WELL NA - NOT ANALYZED
- MW-2 DESTROYED GROUNDWATER MONITORING WELL
- 1,000 ug/L TPHg IN GROUNDWATER CONCENTRATION CONTOUR AS MEASURED ON 1/25/11

GEOENVIRO SERVICES, INC.

SITE MAP WITH CONTOURS OF TPHg CONCENTRATIONS IN GROUNDWATER FIRST QUARTER 2011

FORMER EZ SERVE STATION NO. 100877
 525 WEST A STREET
 HAYWARD, CA

FEBRUARY 2011 FIGURE 8

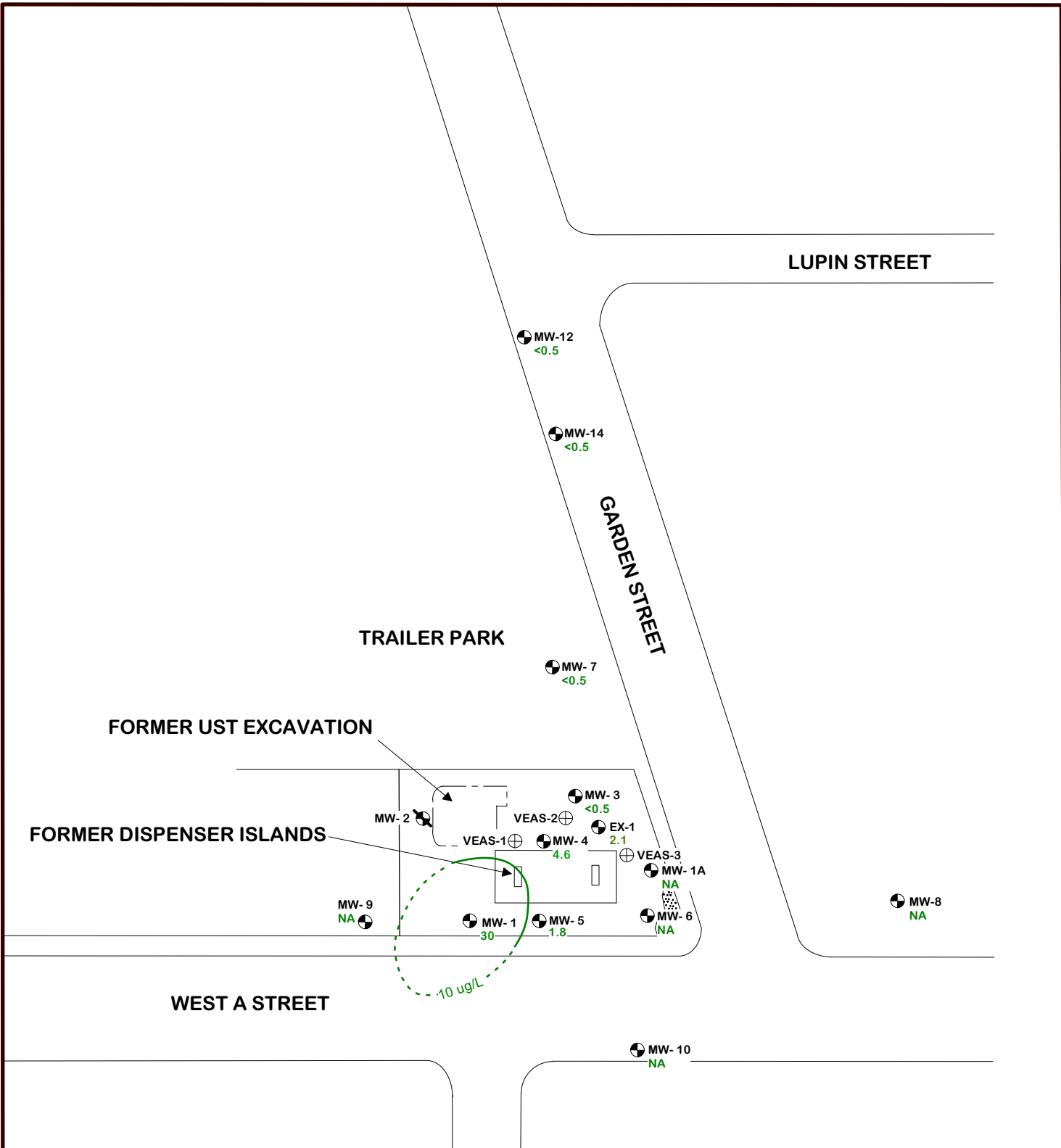

SCALE 1" = 80'



DRAWN BY: JPS
 REVISION DATE: FEBRUARY 25, 2011
 CLIENT: RPMS
 JOB No.: 07-131

LEGEND

- MW-1 30 GROUNDWATER MONITORING WELL WITH BENZENE CONCENTRATIONS IN ug/L AS MEASURED ON 1/25/2011
- EX-1 NA GROUNDWATER EXTRACTION WELL
- VEAS-2 NA - NOT ANALYZED
- MW-2 DESTROYED GROUNDWATER MONITORING WELL
- 10 ug/L BENZENE IN GROUNDWATER CONCENTRATION CONTOUR AS MEASURED ON 1/25/11

GEOENVIRO SERVICES, INC.

SITE MAP WITH CONTOURS OF BENZENE CONCENTRATIONS IN GROUNDWATER FIRST QUARTER 2011

FORMER EZ SERVE STATION NO. 100877
 525 WEST A STREET
 HAYWARD, CA

FEBRUARY 2011 FIGURE 9

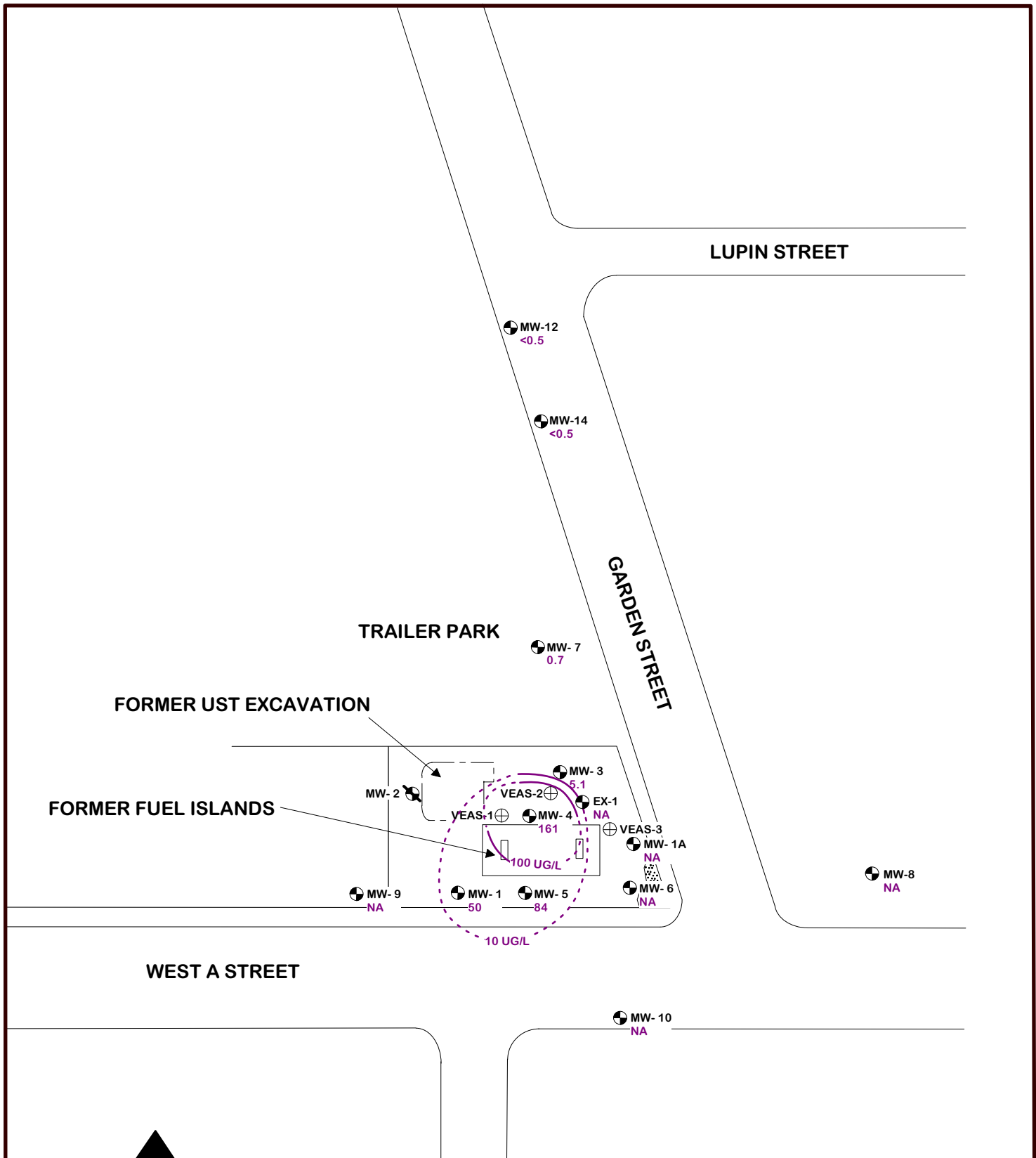

SCALE 1" = 80'



DRAWN BY: GRS
 REVISION DATE: FEBRUARY 25, 2011
 CLIENT: RPMS
 JOB No.: 07-131

LEGEND

- MW-1 50 GROUNDWATER MONITORING WELL WITH MTBE CONCENTRATIONS IN ug/L AS MEASURED ON 1/25/2011
- EX-1 NA GROUNDWATER EXTRACTION WELL
- VEAS-2 REMEDIATION WELL
- MW-2 DESTROYED GROUNDWATER MONITORING WELL
- 10 ug/L MTBE IN GROUNDWATER CONCENTRATION CONTOUR AS MEASURED ON 1/25/11
- NA - NOT ANALYZED

GEOENVIRO SERVICES, INC.

SITE MAP WITH CONTOURS OF MTBE CONCENTRATIONS IN GROUNDWATER FIRST QUARTER 2011

FORMER EZ SERVE STATION NO. 100877
 525 WEST A STREET
 HAYWARD, CA

FEBRUARY 2011 FIGURE 10

APPENDIX A
AGENCY CORRESPONDENCE

ALAMEDA COUNTY
HEALTH CARE SERVICES
AGENCY
ALEX BRISCOE, Director



August 16, 2010

ENVIRONMENTAL HEALTH DEPARTMENT
ENVIRONMENTAL PROTECTION
1131 Harbor Bay Parkway, Suite 250
Alameda, CA 94502-6577
(510) 567-6700
FAX (510) 337-9335

Jack Ceccarelli
Restructure Petroleum Marketing Service
205 S. Hoover Blvd., Suite 101
Tampa, FL 33609-905
(sent via electronic mail to jackc@edifl.com)

Brian Cobb
EZ Serve Petroleum Marketing
100700 North I45, Suite 500
Houston, TX 77037-1187

Azizolah Kandahari
Himalaya Trading Company, Inc.
5196 Grayhawk Lane
Dublin, CA 94568-7764

Margaret S. Thompson
PO Box 16290,
Houston, TX 77222

Vinod & Janak Bansal
1777 Beach Park Blvd.
Foster City, CA 94404-1403

Subject: Request for Work Plan Addendum, Preferential Pathway Study, and SCM; Fuel Leak Case No. RO0000023 and GeoTracker Global ID T0600100483, EZ Serve #100877, 525 West A Street, Hayward, CA 94541

Dear Responsible Parties:

Alameda County Environmental Health (ACEH) staff has reviewed the case file including the *Report of Additional Site Assessment Activities and Technical Workplan for Additional Well Installation Activities*, dated October 29, 2009, and submitted on your behalf by GeoEnviro Services, Inc. (GES). The work plan that accompanied the investigation report proposed the installation of four groundwater wells in the site vicinity.

Based on ACEH staff review of the work plan is not currently approved; however, a work plan addendum is requested. The addendum is requested in order to allow the collection of additional data prior to the installation of wells. ACEH is in agreement that additional wells are required to adequately monitor the site; however, the collection of the additionally requested data will allow better well placement. Additionally, to understand the subject site it is crucial to understand the larger regional context, and to understand and monitor the progress of work at an adjacent site. That site is known as Prime Properties, with an address of 580 West A Street, located southwest of the subject site across West A Street. It appears that the plumes associated with the two sites have comeingled. As a consequence, ACEH requests that you address the following technical comments and send us the documents requested below.

TECHNICAL COMMENTS

1. **Well Rehabilitation or Decommissioning** – Part of the purpose of the four recently proposed wells is to further define the extent of the soil and groundwater plumes in the site vicinity; however, there does not appear to have been an effort to relocate five wells that have been lost that would greatly help to define these plumes. As a consequence ACEH requests a significant effort to relocate the

wells and to either repair, or to destroy the wells, if rehabilitation is not appropriate. Wells MW-6, MW-8, MW-9, MW-10, and MW-11 have been lost due to road widening, site redevelopment, or site repaving. Because an effort to relocate each of these wells must ultimately be undertaken prior to site closure, it is appropriate to undertake these tasks at the present time. As proposed in the work plan, an effort to repair well MW-1A is also appropriate; however, it may be reasonable to delay this task and combine it with the repair, if any, of the additional wells.

Please note that wells MW-1A and MW-6 were surveyed to Geotracker survey standards and thus should be relatively easy to relocate. Please submit a work plan addendum to undertake tasks associated with well relocation, repair, or decommissioning, by date requested below.

2. **Groundwater Monitoring** – Review of the case file has resulted in a number of requests associated with groundwater monitoring at the site:
 - a. In the directive letter dated September 26, 2008, ACEH requested joint groundwater plume monitoring between the subject site and the Prime Properties site at 580 West A Street. A spot check of the last two groundwater monitoring events indicates this has not been acted upon. This site is out of compliance with this request and it remains a valid and useful request. Contact information for the consultant handling the Prime Properties site can be found at the end of this letter; please initiate coordination of the two sites.
 - b. As a consequence of joint groundwater monitoring, ACEH requests data sharing between the two sites be undertaken in order to facilitate site investigations. ACEH requests that gradient and concentration contour maps for the two sites be combined and depicted on site vicinity maps.
 - c. The site is currently being monitored for TPH as gas, BTEX, five fuel oxygenates, and has been monitored once for EDC and EDB. Please continue analyzing for these analytes. Additionally, groundwater at the site does not appear to have been monitored for TPH as diesel, despite the former presence of a diesel UST, and the detection of TPH as diesel in soil at elevated concentrations at the time of UST removals. ACEH requests the inclusion of TPH as diesel in the analytical suite, for both groundwater as well as soil, until it is apparent it is unnecessary. Cost savings may be achievable if a fuel fingerprint analysis is undertaken to determine how best to analyze soil or groundwater in the future so that the site is adequately characterized.
 - d. Wells MW-12 and MW-14 have been monitored discontinuously at various intervals since well installation in February 1995. Since approximately November 2001 the wells have essentially yielded nondetectable results. It is appropriate to reduce the sampling interval to an annual basis during the September groundwater monitoring event, until otherwise determined.

ACEH requests confirmation that these changes be acknowledged either in the next semi-annual groundwater monitoring event, or in the work plan addendum by the date identified below.

- 3 **Request for Preferential Pathway Study** – As currently mapped by consultants for Prime Properties, a large comingled vicinity plume appears to encompass both referenced sites. The large plume, including earlier elevated groundwater data from missing well MW-11 located at an estimated distance of 500 feet downgradient of the subject site, may be the result of preferential pathways in the site vicinity. Although some attempts at determining utility locations in the vicinity of the site has previously occurred, a complete preferential pathway study does not appear to have been conducted at the subject site previously. A previous well survey conducted in June 1988 does not appear to have located the five residential irrigation wells that have been documented to be impacted by the comingled plume (see March 2010 groundwater monitoring report and the December 2008 preferential pathway study for Prime Properties; both are available on Geotracker).

The purpose of the preferential pathway study is to locate potential migration pathways and conduits and determine the probability of a NAPL and/or a groundwater plume encountering preferential pathways and conduits that could spread contamination. We request that you perform a preferential pathway study that details the potential migration pathways and potential conduits (wells, utilities, utility laterals, pipelines, and etc.) for vertical and lateral migration that may be present in the vicinity of the site.

Discuss your analysis and interpretation of the results of the preferential pathway study (including the detailed well survey and utility survey requested below) and report your results in the report requested below. The results of your study shall contain all information required by California Code of Regulations, Title 23, Division 3, Chapter 16, §2654(b).

a. Utility Survey

An evaluation of all utility lines, utility laterals, and trenches (including sewers, storm drains, pipelines, trench backfill, etc.) within and near the site and plume area(s) is required as part of your study. Please assimilate, reduce, and synthesize available information and maps, and generate appropriate (vicinity and / or site specific) maps and cross-sections illustrating the location and depth of all utility lines and trenches within and near the site and plume areas(s) as part of your study.

b. Well Survey

The preferential pathway study shall include a detailed well survey of all wells (monitoring and production wells: active, inactive, standby, decommissioned (sealed with concrete), abandoned (improperly decommissioned or lost); and dewatering, drainage, and cathodic protection wells) within a ¼ mile radius of the subject site. Please use DWR as well as Alameda County Public Works Agency resources. As part of your detailed well survey, please perform a background study of the historical land uses of the site and properties in the vicinity of the site. Use the results of your background study to determine the existence of unrecorded/unknown (abandoned) wells, which can act as contaminant migration pathways at or from your site.

Please submit a preferential pathway study by the date identified below.

4 **Request for an SCM** - At this juncture, it may be advantageous to develop a site conceptual model (SCM), which synthesizes all the analytical data and evaluates all potential exposure pathways and potential receptors that may exist at the site, including identifying or developing site cleanup objectives and goals. At a minimum, the SCM should include:

- a. Local and regional plan view maps that illustrate the location of sources (former facilities, piping, tanks, etc.) extent of contamination, direction and rate of groundwater flow, potential preferential pathways, and locations of receptors;
- b. A concise discussion of the on-site and off-site geology, hydrogeology, release history, source zone, plume development and migration, attenuation mechanisms, preferential pathways, and potential threat to down-gradient and above-ground receptors (e.g. contaminant fate and transport). Please include the contaminant volatilization from the subsurface to indoor/outdoor air exposure route (i.e. vapor pathway) in the analysis.
- c. The SCM shall include an analysis of the hydraulic flow system down-gradient from the site. Include rose diagrams for depicting groundwater gradients. The rose diagram shall be plotted on the groundwater contour maps and updated in all future reports submitted for your site. Include an analysis of vertical hydraulic gradients. Please note that these may change due to seasonal precipitation and groundwater pumping.

- d. Geologic cross section maps shall illustrate subsurface features, man-made conduits, and lateral and vertical extent of contamination;
- e. Plots of chemical concentrations versus time;
- f. Plots of chemical concentrations versus distance from the source;
- g. Summary tables of all chemical concentrations in different media (i.e. soil, groundwater, and soil vapor); and
- h. Well logs, boring logs, and well survey maps;
- i. Discussion of likely contaminant fate and transport.
- j. Identification and listing of specific data gaps that require further investigation during subsequent phases of work.
- k. Proposed activities to investigate and fill data gaps identified above (a work plan).
- l. Several other contaminant release sites exist in the vicinity of your site. Hydrogeologic and contaminant data from those sites may prove helpful in testing certain hypotheses for the SCM. Include a summary of work and technical findings from nearby release sites, in particular the Prime Properties site located down-gradient.

Please submit an SCM by the date identified below.

TECHNICAL REPORT REQUEST

Please submit the following deliverables and technical reports to ACEH (Attention: Mark Detterman), according to the following schedule:

- **October 18, 2010** – Work Plan Addendum and incorporation of groundwater monitoring changes
- **November 1, 2010** – SCM with Preferential Pathway Study
- **April 22, 2011** – Semi-Annual Groundwater Monitoring Report

These reports are being requested pursuant to California Health and Safety Code Section 25296.10. 23 CCR Sections 2652 through 2654, and 2721 through 2728 outline the responsibilities of a responsible party in response to an unauthorized release from a petroleum UST system, and require your compliance with this request.

Should you have any questions, please contact me at (510) 567--6876 or send me an electronic mail message at mark.detterman@acgov.org.

Sincerely,

Mark E. Detterman, PG, CEG
Hazardous Materials Specialist

Responsible Parties
RO0000023
August 16, 2010, Page 5

Enclosures: Attachment 1 – Responsible Party (ies) Legal Requirements / Obligations
Electronic Report Upload (ftp) Instructions

cc: Joseph Schaaf, GeoEnviro Services, Inc., 5529 Kailas Street, Ventura, CA 93003
(sent via electronic mail to jschaaf@geoenviroservices.com)

Hugh Murphy, City of Hayward Fire Dept., 777 B Street, Hayward, CA 94541
(sent via electronic mail to Hugh.Murphy@hayward-ca.gov)

Danny Galang, City of Hayward Fire Dept., 777 B Street, Hayward, CA 94541
(sent via electronic mail to: Danny.Galang@hayward-ca.gov)

Robert Trujillo, Prime Properties, 916 Silver Spur Road, Suite 210, Rolling Hills Estates, CA 90274

Gary Aguilar, Hydro Analysis, Inc., 11100 San Pablo Ave., Suite 200-A, El Cerrito, CA 94530
(sent via electronic mail to gary@hydroanalysis.com)

Cherie McCaulou; 1515 Clay St, Suite 1400, Oakland, CA 94612
(sent via electronic mail to cmccaulou@waterboards.ca.gov)

Donna Drogos, ACEH, (sent via electronic mail to donna.drogos@acgov.org)
Mark Detterman, ACEH, (sent via electronic mail to mark.detterman@acgov.org)
Geotracker, e-File



ENVIRONMENTAL HEALTH DEPARTMENT
ENVIRONMENTAL PROTECTION
1131 Harbor Bay Parkway, Suite 250
Alameda, CA 94502-6577
(510) 567-6700
FAX (510) 337-9335

December 9, 2010

Jack Ceccarelli
Restructure Petroleum Marketing Service
205 S. Hoover Blvd., Suite 101
Tampa, FL 33609-905
(sent via electronic mail to jackc@edifl.com)

Brian Cobb
EZ Serve Petroleum Marketing
100700 North I45, Suite 500
Houston, TX 77037-1187

Azizolah Kandahari
Himalaya Trading Company, Inc.
5196 Grayhawk Lane
Dublin, CA 94568-7764

Margaret S. Thompson
PO Box 16290,
Houston, TX 77222

Vinod & Janak Bansal
1777 Beach Park Blvd.
Foster City, CA 94404-1403

Subject: Approval with Modifications to Work Plan Addendum; Fuel Leak Case No. RO0000023 and GeoTracker Global ID T0600100483, EZ Serve #100877, 525 West A Street, Hayward, CA 94541

Dear Responsible Parties:

Alameda County Environmental Health (ACEH) staff has reviewed the case file including the *Work Plan Addendum to Locate Buried Groundwater Monitoring Wells MW-6, MW-8 through MW-11, and MW-13*, dated November 18, 2010, and submitted on your behalf by GeoEnviro Services, Inc. (GES).

Based on ACEH staff review of the work plan addendum the proposed scope of work is conditionally approved for implementation provided that the technical comments below are incorporated during the proposed field investigation. Submittal of a revised work plan or a work plan addendum is not required unless an alternate scope of work outside that described in the work plan or technical comments below is proposed. We request that you address the following technical comments, perform the proposed work, and send us the reports described below. Please provide 72-hour advance written notification to this office (e-mail preferred to: mark.detterman@acgov.org) prior to the start of field activities.

TECHNICAL COMMENTS

1. **Clarification of Well Rehabilitation or Decommissioning Procedures** – Two potential concerns were noted in review of the referenced work plan and to preclude misunderstandings the following comments are provided:
 - a. **Well Survey** – While the work plan discusses marking of the relocated wells on the ground surface for a resurvey, it does not discuss the resurvey of the Top of Casings (TOCs) elevations for the wells after exhumation and / or repair. Both events can affect the TOCs of wells, and for wells not surveyed to Geotracker standards elevations can also change due to the change in standards. Please ensure this occurs in the planned work.

- b. **Level of Relocation Effort** – The work plan indicates that an attempt will be made to relocate wells without well vaults. Due to the number of currently missing wells and their potential usefulness to the ongoing investigation, ACEH requests this be a significant effort that can start with a shovel, but must rise in scope if wells remain missing (e.g. potentially employing Bobcat or other excavation tools).
 - c. **Scope of Work Clarification** – To preclude potential confusion, this work plan approval does not include approval of the installation of additional wells covered in the original work plan. Installation of additional wells is pending the current scope of work as well as the results of the Site Conceptual Model (SCM) and preferential pathway study.
2. **SCM with Preferential Pathway Study** – ACEH requests a status update regarding this now overdue document. This letter does not include an extension to the due date, but reiterates the necessity of the document. If an extension is due to a reasonable explanation, please request one.

TECHNICAL REPORT REQUEST

Please submit the following deliverables and technical reports to ACEH (Attention: Mark Detterman), according to the following schedule:

- **November 1, 2010 – (Late)** SCM with Preferential Pathway Study
- **April 22, 2011** – Semi-Annual Groundwater Monitoring Report

These reports are being requested pursuant to California Health and Safety Code Section 25296.10. 23 CCR Sections 2652 through 2654, and 2721 through 2728 outline the responsibilities of a responsible party in response to an unauthorized release from a petroleum UST system, and require your compliance with this request.

Should you have any questions, please contact me at (510) 567--6876 or send me an electronic mail message at mark.detterman@acgov.org.

Sincerely,

Mark E. Detterman, PG, CEG
Hazardous Materials Specialist

Enclosures: Attachment 1 – Responsible Party (ies) Legal Requirements / Obligations
Electronic Report Upload (ftp) Instructions

cc: Joseph Schaaf, GeoEnviro Services, Inc., 5529 Kailas Street, Ventura, CA 93003
(sent via electronic mail to jschaaf@geoenviroservices.com)

Hugh Murphy, City of Hayward Fire Dept., 777 B Street, Hayward, CA 94541
(sent via electronic mail to Hugh.Murphy@hayward-ca.gov)

Danny Galang, City of Hayward Fire Dept., 777 B Street, Hayward, CA 94541
(sent via electronic mail to: Danny.Galang@hayward-ca.gov)

Robert Trujillo, Prime Properties, 916 Silver Spur Road, Suite 210, Rolling Hills Estates, CA 90274

Gary Aguilar, Hydro Analysis, Inc., 11100 San Pablo Ave., Suite 200-A, El Cerrito, CA 94530
(sent via electronic mail to gary@hydroanalysis.com)

Cherie McCaulou; 1515 Clay St, Suite 1400, Oakland, CA 94612
(sent via electronic mail to cmccaulou@waterboards.ca.gov)

Donna Drogos, ACEH, (sent via electronic mail to donna.drogos@acgov.org)
Mark Detterman, ACEH, (sent via electronic mail to mark.detterman@acgov.org)
Geotracker, e-File

APPENDIX B
CITY OF HAYWARD UTILITY MAPS



NOTE: THIS MAP IS BASED ON THE CALIF. COORD. SYSTEM. ZONE II. ALL MEASUREMENTS ARE BASED ON U.S.C.A. & S.L. DATA. INFORMATION IS FOR REFERENCE USE ONLY AND THE CITY OF HAYWARD ASSUMES NO RESPONSIBILITY FOR ITS ACCURACY.

1533D428 Date Printed: 5/16/2008



CITY OF HAYWARD BASE MAP MAY 08
 STREET ADDRESSES MAY 08
 STORM DRAIN MAINS MAY 08



SCALE IN FEET
 0 100 200 300 400 500 600 700

NOTE: THIS MAP IS BASED ON THE CALIF. COOR. SYSTEM, ZONE III. ELEVATIONS ARE BASED ON U.S.C. & G.S. M.S.L. DATUM. INFORMATION IS FOR REFERENCE USE ONLY AND THE CITY OF HAYWARD ASSUMES NO RESPONSIBILITY FOR ITS ACCURACY.

1533W426

U.S.G.S. QUAD. HAYWARD

1533W428

Date Printed: 6/5/2008

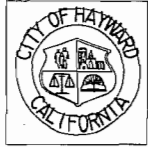



SCALE IN FEET
 0 100 200 300 400 500 600 700

NOTE: THIS MAP IS BASED ON THE CALIF. COORD. SYSTEM, ZONE 11. THE CITY OF HAYWARD ASSUMES NO RESPONSIBILITY FOR ITS ACCURACY.

U.S.G.S. QUAD. HAYWARD

1533S428

Date Printed: 5/20/2008



CITY OF HAYWARD BASE MAP MAY 08
 STREET ADDRESSES MAY 08
 SANITARY SEWER MAINS MAY 08

**APPENDIX C
BORING LOGS**

PROJECT: E-Z Serve, Loc # 100877
525 W. "A" Street
Hayward, California



Associated Soils Analysis
 1141 Batavia Court • Tulare, California 93274
 (209) 688-1011 • FAX (209) 688-1195

JOB NO.: 238-91
 DATE: 01/28/92
 BY: G. Sullivan
 ELEV.: 99.91'

BORING LOG NUMBER MW1 RENAMED MW-1A page 1 of 1

DEPTH	% REC	BLOW COUNTS	SAMPLE NO.	HNU METER	SOIL GROUP	SOIL DESCRIPTION
0'						0" - 1" Baserock
					ML	1" - 4' <u>Clayey silt</u> ; dark brownish grey, moist, dense to hard, moderately cohesive, moderately plastic silt with moderately plastic clay, highly organic. No petroleum odor.
					ML	4' - 10' <u>Clayey silt</u> ; moderate yellowish brown, moist, medium dense, slight to moderate cohesive, moderately plastic silt with moderately cohesive clay. Soil is stained light olive grey below 8 feet. Slight petroleum odor below 8 feet.
10'		5 7 8	1	50	SP	10'-14' <u>Sand</u> : light yellowish brown, moist, medium dense very fine to fine, poorly graded, sub-rounded to rounded sand. Stained light olive grey. Slight to moderate petroleum odor.
15'		5 9 19	2	10	CH	14'-23' <u>Clay</u> : moderate yellowish brown, moist, stiff, moderate to highly cohesive, moderate to highly plastic clay. Slight petroleum odor. Localized dark grey petroleum staining.
20'		7 15 15	3	18	SW	23'-28' <u>Sand</u> : light yellowish brown, moist, medium dense, very fine to medium, well graded, sub-rounded to rounded sand, slightly silty. Slight to moderate petroleum odor.
25'					CH	28'-30' <u>Clay</u> : moderate yellowish brown, very moist to saturated, medium dense, highly cohesive, highly plastic clay. Slight to moderate petroleum odor.
30'						Boring terminated at 30 feet. Freestanding groundwater encountered at 21 feet.

LOCATION: See testhole boring location map

EQUIPMENT: Mobile B80 drill rig with 11 inch O.D. and 6.25 I.D and 2.5 inch split spoon sampler.

NOTES: _____

WELL DETAILS

RENAMED MW-1A

PROJECT NUMBER <u>238-91</u>	BORING / WELL NO. <u>MW1</u>
PROJECT NAME <u>EZ Serve location #100877</u>	TOP OF CASING ELEV. <u>99.91'</u>
<u>525 West A Street, Hayward, California</u>	GROUND SURFACE ELEV. <u>NA</u>
LOCATION <u>See Testhole Boring location map</u>	DATUM <u>Temporary Bench Mark</u>
WELL PERMIT NO. <u>N/A</u>	INSTALLATION DATE <u>1/28/92</u>

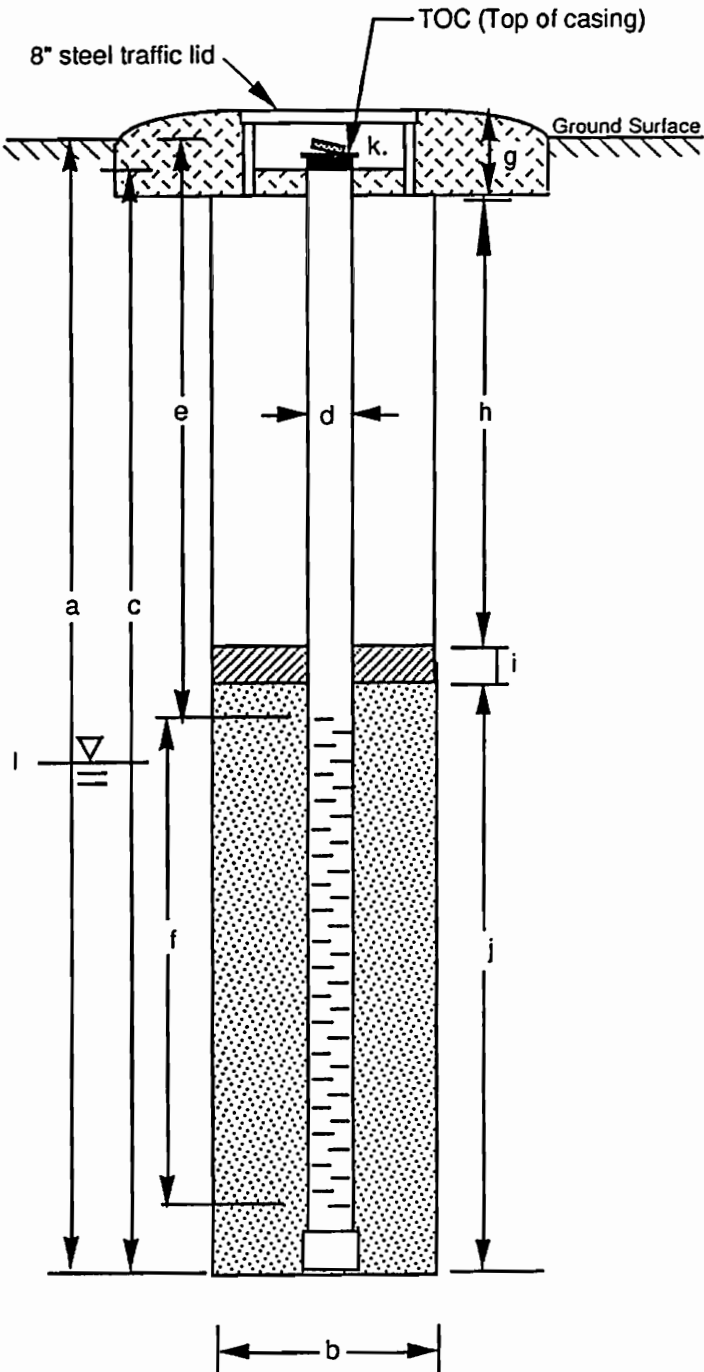

EXPLORATORY BORING

a. Total depth 30 ft.
 b. Diameter 11 in.
 Drilling method Hollow stem auger

WELL CONSTRUCTION

c. Total casing length 29.5 ft.
 Material Schedule 40 PVC

d. Diameter 4 in.

e. Depth to top perforations 14.5 ft.

f. Perforated length 14 ft.
 Perforated interval from 14.5 to 28.5 ft.
 Perforation type Slotted
 Perforation size 0.02 in.

g. Surface seal 0.5 ft.
 Material Concrete

h. Backfill 10.5 ft.
 Material 7 sack cement slurry with 3% bentonite

i. Seal 2.5 ft.
 Material 3/8" Bentonite pellets

J. Gravel pack 16.5 ft.
 Gravel pack interval from 13.5 to 30 ft.
 Material #3 Silica Sand

k. Locking wellcap

l. Depth to groundwater 20.82 ft.

PROJECT: E-Z Serve, Loc # 100877
525 W. "A" Street
Hayward, California



Associated Soils Analysis
 1141 Batavia Court • Tulare, California 93274
 (209) 688-1011 • FAX (209) 688-1195

JOB NO.: 238-91
 DATE: 01/28/92
 BY: G. Sullivan
 ELEV.: 101.45'

BORING LOG NUMBER MW2

page 1 of 1

DEPTH	% REG	BLOW COUNTS	SAMPLE NO.	HNU METER	SOIL GROUP	SOIL DESCRIPTION
0'						0" - 1" Baserock
					ML	1" - 5' <u>Clay silt</u> : dark grey, moist, dense, moderately cohesive, moderately plastic silt, with moderately plastic clay. No petroleum odor.
5'					ML	5' - 10' <u>Clayey silt</u> : moderate yellowish brown, moist, medium dense, moderately cohesive, moderately plastic silt with approximately 20-30% moderately cohesive clay. Soil is stained light grey below 9 feet. Slight petroleum odor below 9 feet.
10'	2 3 6		4	15	SM	10'-13' <u>Silty sand</u> : light yellow brown, moist, loose, very fine to fine, poorly graded, rounded sand with approximately 5-15% very slight cohesive silt. Soil is stained light olive grey. Slight to moderate petroleum odor.
15'	4 9 9		5	55	CH	13'-23' <u>Clay</u> : dark yellowish brown, moist to saturated, medium dense to stiff, highly cohesive, moderately to highly plastic clay. Locally stained light olive grey. Slight to moderate petroleum odor.
20'	8 15 19		6	130	SM	23'-30' <u>Silty sand</u> : light olive grey, saturated, loose to medium dense, very fine to fine, poorly graded, rounded sand, with approximately 25-35% slight cohesive silt. Moderate petroleum odor.
25'						
30'						Boring terminated at 30 feet. Freestanding groundwater encountered at 21 feet.

LOCATION: See testhole boring location map

EQUIPMENT: Mobile B80 drill rig with 11 inch O.D. and 6.25 I.D and 2.5 inch split spoon sampler.

NOTES: _____

PROJECT: E-Z Serve, Loc # 100877
525 W. "A" Street
Hayward, California



Associated Soils Analysis
 1141 Batavia Court • Tulare, California 93274
 (209) 688-1011 • FAX (209) 688-1195

JOB NO.: 238-91
 DATE: 01/28/92
 BY: G. Sullivan
 ELEV.: 101.5'

BORING LOG NUMBER MW3

page 1 of 1

DEPTH	3/4" REC	BLOW COUNTS	SAMPLE NO.	HNU METER	SOIL GROUP	SOIL DESCRIPTION
0'						0" - 2" Baserock
					ML	1" -3.5' <u>Clayey silt</u> : dark greyish brown, moist, medium dense, slight to moderately cohesive, slight to medium plastic silt, with medium cohesive clay. No petroleum odor.
5'					ML/MH	3.5' - 10.5' <u>Clayey silt</u> : moderate yellowish brown, moist, medium dense, moderate to highly cohesive, moderate to highly plastic silt with highly cohesive clay. Soil is stained light olive grey below 6 feet. Slight to moderate petroleum odor below 7 feet.
10'		4 5 7	7	10	SM	10.5'-14' <u>Silty sand</u> : light yellowish brown, moist, loose, very fine to fine, poorly graded, rounded sand with approximately 10-20% slight cohesive silt. Slight petroleum odor. Soil is stained light olive grey.
15'		8 11 13	8	40	CL/CH	14'-22' <u>Silty clay</u> : moderate yellowish brown, moist, stiff, moderately to highly cohesive, moderately to highly plastic clay with silt. Slight petroleum odor.
20'		10 18 25	9	25	SM	22'-30' <u>Silty sand</u> : light olive grey, saturated, loose to medium density, very fine to fine, poorly graded, rounded sand, with approximately 23-30% slight cohesive silt. Moderate petroleum odor.
25'						
30'						Boring terminated at 30 feet. Freestanding groundwater encountered at 21 feet.

LOCATION: See testhole boring location map

EQUIPMENT: Mobile B80 drill rig with 11 inch O.D. and 6.25 I.D and 2.5 inch split spoon sampler.

NOTES: _____

PROJECT: E-Z Serve, Loc # 100877
525 W. "A" Street
Hayward, California



Associated Soils Analysis
 1141 Batavia Court • Tulare, California 93274
 (209) 688-1011 • FAX (209) 688-1195

JOB NO.: 238-91
 DATE: 01/28/92
 BY: G. Sullivan
 ELEV.: 100.50'

BORING LOG NUMBER MW4

page 1 of 1

DEPTH	% REG	BLOW COUNTS	SAMPLE NO.	LNJ METER	SOIL GROUP	SOIL DESCRIPTION
0'					SW	0" - 2" Baserock 2" - 2' <u>Gravelly sand</u> : light yellowish brown, moist, medium density, very fine to very coarse, well graded, sub-rounded sand, with granules to 3 cm. No petroleum odor. (Backfill?).
					ML	2'-7' <u>Clayey silt</u> : Moderate yellowish brown, moist, medium density, moderately cohesive, moderately plastic silt, with moderately cohesive clay. Slight petroleum odor below 6 feet.
5'	4 16 14		10	5	SM	7'-14' <u>Silty sand</u> : Light yellowish brown, moist very fine to fine, poorly graded, rounded sand, with approximately 5-15% very slightly cohesive silt. Slight petroleum odor. Stained light olive grey from 8 feet and below.
10'	4 3 5		11	20		
15'	5 8 13		12	180	CH	14'-22' <u>Clay</u> : dark yellowish brown, moist to saturated, medium dense, highly cohesive, highly plastic clay. Locally stained medium olive grey. Slight to moderate petroleum odor.
20'	7 15 18		13	150	SM	22'-30' <u>Silty sand</u> : light olive grey, saturated, loose to medium dense, very fine to medium, well graded, sub rounded sand. Slight petroleum odor.
25'						
30'						Boring terminated at 30 feet. Freestanding groundwater encountered at 21 feet.

LOCATION: See testhole boring location map

EQUIPMENT: Mobile B80 drill rig with 11 inch O.D. and 6.25 I.D and 2.5 inch split spoon sampler.

NOTES: _____

PROJECT: E-Z Serve, Loc # 100877
525 W. "A" Street
Hayward, California



Associated Soils Analysis
 1141 Batavia Court - Tulare, California 93274
 (209) 688-1011 • FAX (209) 688-1195

JOB NO.: 238-91
 DATE: 01/29/92
 BY: G. Sullivan
 ELEV.: 100.48'

BORING LOG NUMBER MW5

page 1 of 1

DEPTH	% REC	BLOW COUNTS	SAMPLE NO.	HNU METER	SOIL GROUP	SOIL DESCRIPTION
0'						0" - 2" Baserock
					ML	2"-4.5' <u>Clayey silt</u> : dark brownish grey, moist, medium dense, moderately cohesive, moderately plastic silt with clay, highly organic. No petroleum odor.
					ML	4.5'-10' <u>Clayey silt</u> : Moderate yellowish brown, moist, medium to stiff, moderately cohesive, moderately plastic silt with clay. Soil is stained light olive grey below 6.5 feet. Slight petroleum odor below 6.5 feet.
10'		4 6 8	14	15	SM	10'-16' <u>Silty sand</u> : light yellowish brown, moist, loose to medium dense, very fine to fine, poorly graded, rounded sand, with approximately 5-20% slightly cohesive silt. Soil is stained a light olive grey. Slight to moderate petroleum odor.
15'		7 12 18	15	70	CH	16'-22' <u>Clay</u> : moderate yellowish brown, moist to very moist, stiff, moderate to highly cohesive, moderate to highly plastic clay. Slight to moderate petroleum odor. Localized staining (medium gray).
20'		7 10 18	16	130	SM	22'-29' <u>Silty sand</u> : light yellowish brown, very moist to saturated, very fine to medium, well graded, sub-rounded sand with approximately 10-20% slightly cohesive silt. Slight to moderate petroleum odor, stained light olive grey.
25'					CH	29'-30' <u>Clay</u> : moderate yellowish brown, saturated, stiff, highly cohesive, highly plastic clay. Slight petroleum odor. Stained light olive grey.
30'						Boring terminated at 30 feet. Freestanding groundwater encountered at 21 feet.

LOCATION: See testhole boring location map
 EQUIPMENT: Mobile B80 drill rig with 11 inch O.D. and 6.25 I.D and 2.5 inch split spoon sampler.
 NOTES: _____

PROJECT: E-Z Serve, Loc # 100877
525 W. "A" Street
Hayward, California



Associated Soils Analysis
 1141 Batavia Court • Tulare, California 93274
 (209) 688-1011 • FAX (209) 688-1195

JOB NO.: 238-91
 DATE: 01/29/92
 BY: G. Sullivan
 ELEV.: 100.97'

BORING LOG NUMBER MW6

page 1 of 1

DEPTH	% REC	BLOW COUNTS	SAMPLE NO.	HNJ METER	SOIL GROUP	SOIL DESCRIPTION
0'						0" - 1" Baserock
					ML	1"-4' <u>Clayey silt</u> : dark brownish grey, moist, medium dense to dense, moderately cohesive, moderately plastic, sity with clay. No petroleum odor.
5'					ML	4'-10.5' <u>Clayey silt</u> : Moderate yellowish brown, moist, medium dense, slight to moderately plastic, moderate cohesive silt with clay. Stained light olive grey below 7.5 feet. Slight petroleum odor below 7.5 feet.
10'		4 7 10	17	25	SM	10.5'-15.5' <u>Silty sand</u> : light yellowish brown, moist, loose to medium dense, very fine to fine, poorly graded, rounded sand, with approximately 15-20% slightly cohesive silt. Soil is stained a moderate olive grey. Slight to moderate petroleum odor.
15'		6 9 20	18	40	CL / CH	15.5'-24' <u>Clay</u> : moderate yellowish brown, moist to saturated, stiff, moderate to highly cohesive, moderate to highly plastic. Slight to moderate petroleum odor. Localized petroleum staining.
20'		7 8 18	19	110	≡	
25'					SM	24'-30' <u>Silty sand</u> : light yellowish brown, saturated, medium dense, very fine to medium, well-graded, sub-rounded to rounded sand with slight cohesive silt. Slight petroleum odor. Soil is stained light olive grey.
30'						Boring terminated at 30 feet . Freestanding groundwater encountered at 21 feet.

LOCATION: See testhole boring location map

EQUIPMENT: Mobile B80 drill rig with 11 inch O.D. and 6.25 I.D and 2.5 inch split spoon sampler.

NOTES: _____

PROJECT: E-Z Serve #100877
525 West "A" Street
Hayward, CA



Associated Soils Analysis
 1141 Batavia Court • Tulare, California 93274
 (209) 688-1011 • FAX (109) 688-1195

JOB NO.: 238-91
 DATE: 06/21/93
 BY: G. Sullivan
 ELEV.: N/A

BORING LOG NUMBER MW7

DEPTH	% REC	BLOW COUNTS	SAMPLE NO.	HNU METER	SOIL GROUP	SOIL DESCRIPTION
0'					MH	0'-4' <u>CLAYEY SILT</u> : Strong brown; dry to moist; dense; moderately to highly cohesive, moderately to highly plastic silt with clay.
5'		15 24 28		1	CH	4'-11' <u>CLAY</u> : Moderate yellowish brown; moist; dense; moderately to highly cohesive; moderately to highly plastic clay. No petroleum odor.
10'		4 5 7		2	SM	11'-13' <u>SILTY SAND</u> : Light gray; moist; medium dense; very fine to medium, well graded, sub-rounded sand with approximately 10-20% slightly cohesive silt. No petroleum odor. A "sewage" like odor was detectable from 11 to 17 ft.
15'		7 7 8		6	CH	13'-30' <u>SILTY CLAY</u> : Light olive gray; moist to saturated; medium dense; highly cohesive, highly plastic clay with silt. No petroleum odor.
20'						
25'						
30'						Boring terminated at 30' below grade. Freestanding groundwater was encountered at approximately 18' below grade.

LOCATION: See testhole boring location map
 EQUIPMENT: Mobile B80 drill rig with 8.5 inch O.D. and 4.25 inch I.D. hollow-stem auger and 2.0 inch split spoon sampler.
 NOTES: Drilled approximately 80-85 feet north of site.

WELL DETAILS

PROJECT NUMBER 238-91
 PROJECT NAME E-Z Serve Hayward
525 W. "A" Street, Hayward, California
 LOCATION See monitoring well location map
 WELL PERMIT NO. N/A

BORING / WELL NO. MW7
 TOP OF CASING ELEV. N/A
 GROUND SURFACE ELEV. N/A
 DATUM N/A
 INSTALLATION DATE 6/21/93

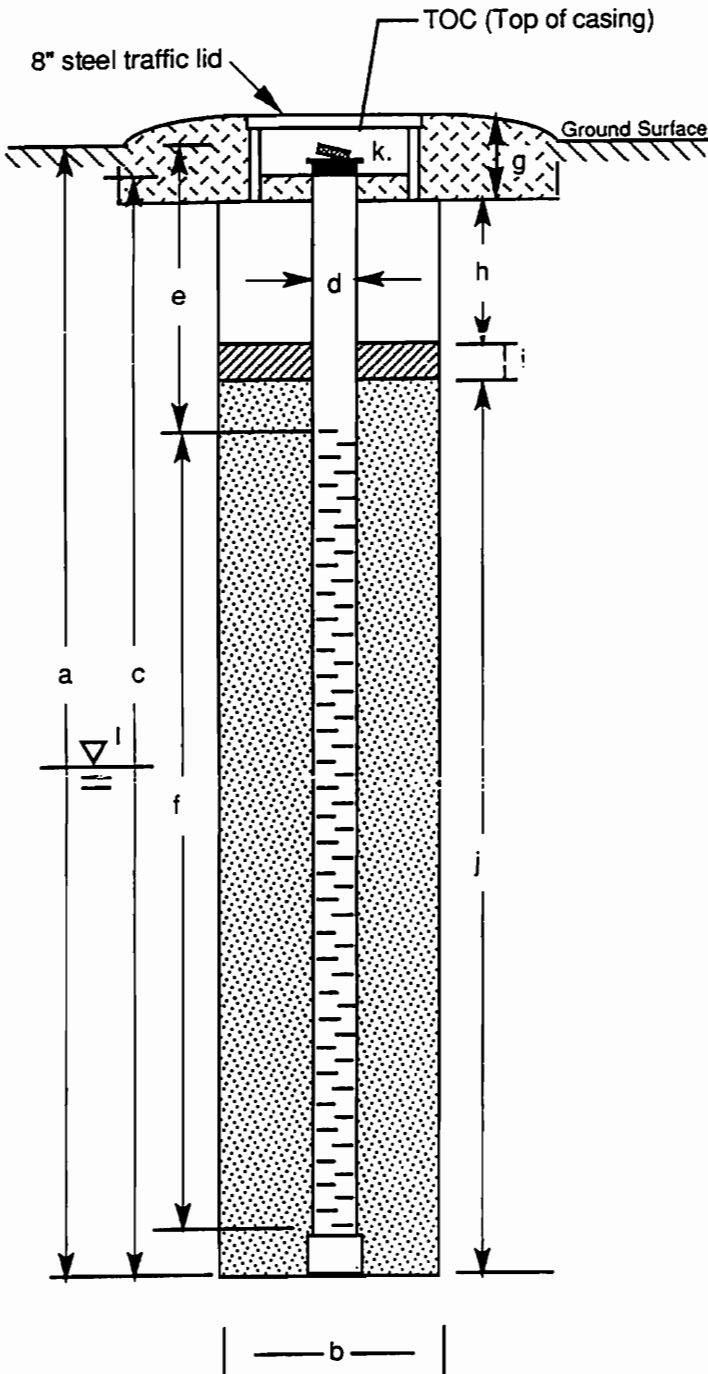

EXPLORATORY BORING

a. Total depth 30 ft.
 b. Diameter 8.5 in.
 Drilling method Hollow stem auger

WELL CONSTRUCTION

c. Total casing length 29.5 ft.
 Material Schedule 40 PVC
 d. Diameter 2 in.
 e. Depth to top perforations 10 ft.
 f. Perforated length 19 ft.
 Perforated interval from 10 to 29 ft.
 Perforation type Slotted
 Perforation size 0.02 in.
 g. Surface seal 0.5 ft.
 Material Concrete
 h. Backfill 5.5 ft.
 Material Volclay grout
 i. Seal 3 ft.
 Material 3/8" bentonite pellets
 j. Gravel pack 21 ft.
 Gravel pack interval from 9 to 30 ft.
 Material #3 Silica Sand
 k. Locking wellcap
 l. Depth to groundwater 17.67 ft.

PROJECT: E-Z Serve #100877
525 west "A" Street
Hayward, CA



Associated Soils Analysis
 1141 Batavia Court • Tulare, California 93274
 (209) 688-1011 • FAX (109) 688-1195

JOB NO.: 238-91
 DATE: 06/22/93
 BY: G. Sullivan
 ELEV.: N/A

BORING LOG NUMBER MW8

DEPTH	% REC	BLOW COUNTS	SAMPLE NO.	HNU METER	SOIL GROUP	SOIL DESCRIPTION
0'					CH	0-3" Asphalt 3"-5" <u>SILTY CLAY</u> : Dark yellowish brown, moist, medium dense, moderately to highly cohesive, moderately to highly plastic clay with silt.
5'		4 5 8		0	CH	5'-30" <u>SILTY CLAY</u> : moderate yellowish brown, moist, medium dense, highly cohesive, highly plastic clay with silt.
10'		11 11 13		0		
15'		10 11 14		1		
20'						
25'						
30'						

Boring terminated at 30' below grade
 Freestanding groundwater encountered at approximately 17' below grade.

LOCATION: See testhole boring location map
 EQUIPMENT: Mobile B80 drill rig with 8.5 inch O.D. and 4.25 inch I.D. hollow-stem auger and 2.0 inch split spoon sampler.
 NOTES: _____

WELL DETAILS

PROJECT NUMBER 238-91

BORING / WELL NO. MW8

PROJECT NAME E-Z Serve Hayward
525 W. "A" Street, Hayward, California

TOP OF CASING ELEV. N/A

GROUND SURFACE ELEV. N/A

LOCATION See monitoring well location map

DATUM N/A

WELL PERMIT NO. N/A

INSTALLATION DATE 6/22/93

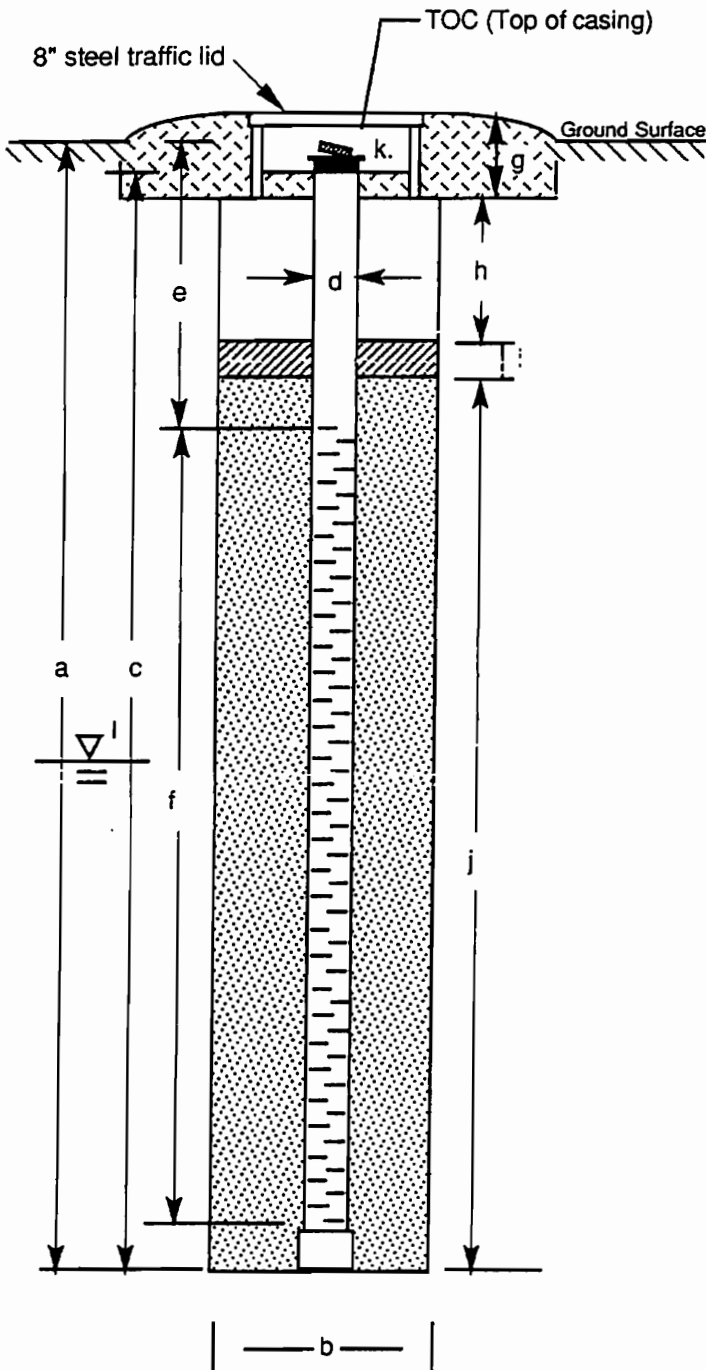

EXPLORATORY BORING

- a. Total depth 30 ft.
- b. Diameter 8.5 in.
- Drilling method Hollow stem auger

WELL CONSTRUCTION

- c. Total casing length 29.5 ft.
Material Schedule 40 PVC
- d. Diameter 2 in.
- e. Depth to top perforations 10 ft.
- f. Perforated length 19 ft.
Perforated interval from 10 to 29 ft.
Perforation type Slotted
Perforation size 0.02 in.
- g. Surface seal 0.5 ft.
Material Concrete
- h. Backfill 5.5 ft.
Material Volclay grout
- i. Seal 3 ft.
Material 3/8" bentonite pellets
- J. Gravel pack 21 ft.
Gravel pack interval from 9 to 30 ft.
Material #3 Silica Sand
- k. Locking wellcap
- l. Depth to groundwater 17.63 ft.

PROJECT: E-Z Serve #100877
525 West "A" Street
Hayward, CA



Associated Soils Analysis
 1141 Batavia Court • Tulare, California 93274
 (209) 688-1011 • FAX (109) 688-1195

JOB NO.: 288-91
 DATE: 06/22/93
 BY: G. Sullivan
 ELEV.: N/A

BORING LOG NUMBER MW9

DEPTH	BLOW COUNTS	SAMPLE NO.	HNU METER	SOIL GROUP	SOIL DESCRIPTION
0'				CH	0'-11' <u>SILTY CLAY</u> : Moderate yellowish brown; moist; stiff; highly cohesive, highly plastic clay with silt. No petroleum odor. Localized sand and gravel lenses to 1 foot thick.
5'	8 11 15		0		
10'	4 7 9		0	SM	11'-12' <u>SILTY SAND</u> : Light olive gray; moist; medium dense; very fine to fine, poorly graded sand with silt.
				CH	12'-30' <u>CLAY</u> : Moderately yellowish brown; moist to saturated, medium dense to stiff, highly cohesive, highly plastic clay.
15'	8 8 16				
20'					
25'					
30'					

Boring terminated at 30' below grade.
 Freestanding groundwater was encountered at approximately 16' below grade.

LOCATION: See testhole boring location map
 EQUIPMENT: Mobile B80 drill rig with 8.5 inch O.D. and 4.25 inch I.D. hollow-stem auger and 2.0 inch split spoon sampler.

NOTES: Drilled approximately 75-80 feet west of monitoring well MW1

WELL DETAILS

PROJECT NUMBER 238-91
 PROJECT NAME E-Z Serve Hayward
525 W. "A" Street, Hayward, California
 LOCATION See monitoring well location map
 WELL PERMIT NO. N/A

BORING / WELL NO. MW9
 TOP OF CASING ELEV. N/A
 GROUND SURFACE ELEV. N/A
 DATUM N/A
 INSTALLATION DATE 6/22/93

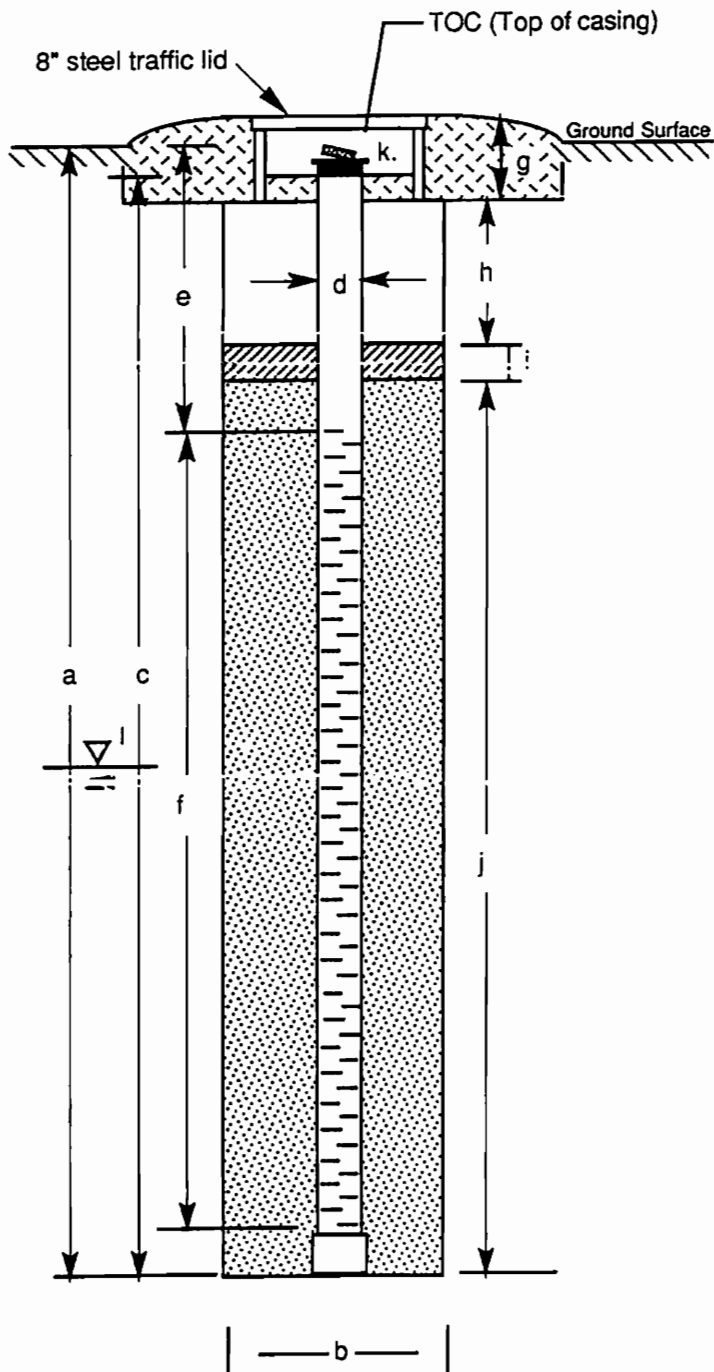

EXPLORATORY BORING

a. Total depth 30 ft.
 b. Diameter 8.5 in.
 Drilling method Hollow stem auger

WELL CONSTRUCTION

c. Total casing length 29.5 ft.
 Material Schedule 40 PVC
 d. Diameter 2 in.
 e. Depth to top perforations 10 ft.
 f. Perforated length 19 ft.
 Perforated interval from 10 to 29 ft.
 Perforation type Slotted
 Perforation size 0.02 in.
 g. Surface seal 0.5 ft.
 Material Concrete
 h. Backfill 5.5 ft.
 Material Volclay grout
 i. Seal 3 ft.
 Material 3/8" bentonite pellets
 j. Gravel pack 21 ft.
 Gravel pack interval from 9 to 30 ft.
 Material #3 Silica Sand
 k. Locking wellcap
 l. Depth to groundwater 15.84 ft.

PROJECT: E-Z Serve #100877
525 West "A" Street
Hayward, CA



Associated Soils Analysis
 1141 Batavia Court • Tulare, California 93274
 (209) 688-1011 • FAX (109) 688-1195

JOB NO.: 238-91
 DATE: 06/22/93
 BY: G. Sullivan
 ELEV.: N/A

BORING LOG NUMBER MW10

DEPTH	3/8" REC BLOW COUNTS	SAMPLE NO.	HNU METER	SOIL GROUP	SOIL DESCRIPTION
0'				CH	0"-1" 1"-8" Asphalt <u>SILTY CLAY</u> ; Moderate to dark yellowish brown; moist; medium dense to dense; moderate to highly cohesive; moderate to highly plastic clay with silt. No petroleum odor.
5'	7 14 17		0	ML	8'-10' <u>SANDY SILT</u> ; Light gray, moist; medium dense; moderately cohesive; moderately plastic silt with approximately 5-10% very fine sand. No petroleum odor.
10'	6 6 13		4	CH	10'-30' <u>CLAY</u> ; Light yellowish brown to light olive brown; moist to saturated; highly cohesive, highly plastic clay. Slight petroleum odor from 9-11 feet below grade. No petroleum odor below 11 feet.
15'	10 10 12		0		
20'					
25'					
30'					

Boring terminated at 30' below grade.
 Freestanding groundwater encountered at approximately 18' below grade.

LOCATION: See testhole boring location map
 EQUIPMENT: Mobile B80 drill rig with 8.5 inch O.D. and 4.25 inch I.D. hollow-stem auger and 2.0 inch split spoon sampler.

NOTES: Drilled on south side of "A" Street, approximately 2' inside curb.

WELL DETAILS

PROJECT NUMBER 238-91

BORING / WELL NO. MW10

PROJECT NAME E-Z Serve Hayward

TOP OF CASING ELEV. N/A

525 W. "A" Street, Hayward, California

GROUND SURFACE ELEV. N/A

LOCATION See monitoring well location map

DATUM N/A

WELL PERMIT NO. N/A

INSTALLATION DATE 6/22/93

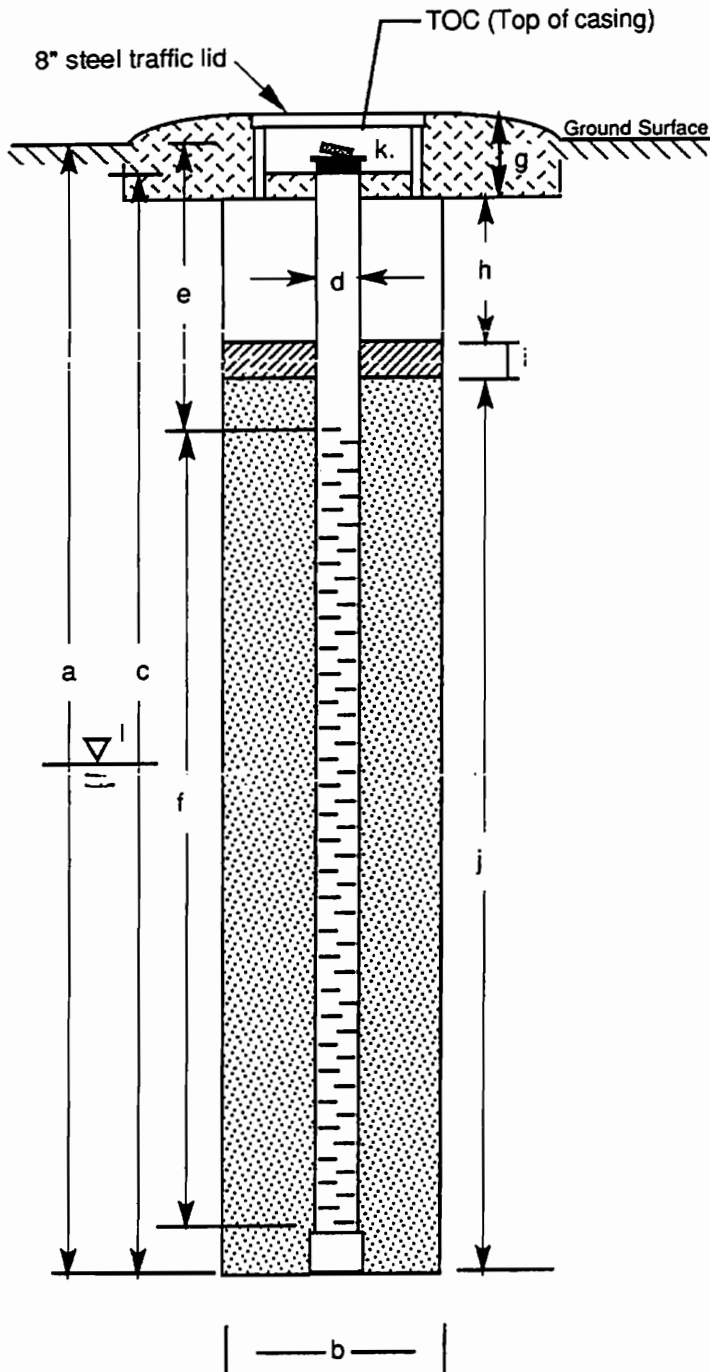

EXPLORATORY BORING

a. Total depth 30 ft.
 b. Diameter 8.5 in.
 Drilling method Hollow stem auger

WELL CONSTRUCTION

c. Total casing length 29.5 ft.
 Material Schedule 40 PVC
 d. Diameter 2 in.
 e. Depth to top perforations 10 ft.
 f. Perforated length 19 ft.
 Perforated interval from 10 to 29 ft.
 Perforation type Slotted
 Perforation size 0.02 in.
 g. Surface seal 0.5 ft.
 Material Concrete
 h. Backfill 5.5 ft.
 Material Volclay grout
 i. Seal 3 ft.
 Material 3/8" bentonite pellets
 j. Gravel pack 21 ft.
 Gravel pack interval from 9 to 30 ft.
 Material #3 Silica Sand
 k. Locking wellcap
 l. Depth to groundwater 17.39 ft.

LOCATION OF BORING

CLIENT				BORING NO.	
LOCATION			JOB NO.		
	AT TIME OF DRILLING	SECOND	THIRD	FOURTH	SHEET OF
WATER LEVEL					DRILLING
TIME					START TIME
DATE					FINISH TIME
DRILLING CONTRACTOR				WELL CONSTR.	
RIG TYPE				START DATE	
DRILLING METHOD, FLUID USED				FINISH DATE	

MW11
p2/2

WELL CONSTRUCTION	SOIL SAMPLING				DEPTH IN FEET	INSTRUMENT READING (ppm)	ESTIMATED PERCENT			MUNSELL COLOR NO.	USCS GROUP SYMBOL
	CASING	ANNULUS	SAMPLER TYPE	BLOWS/8" INTERVAL			INTERVAL SAMPLED	GRAVEL	SAND		
			3		20	1800	60	40		SM	
			4		1						
			5		2						
		2 1/2 sand			3						
					4						
			4		25	420	85	15		SP	
			7		6						
			10		7						
					8						
					9						
					10						
					1						
					2						
					3						
					4						
					5						
					6						
					7						
					8						
					9						
					0						

SOIL SAMPLING METHOD	SURFACE ELEV.
MONITORING INSTRUMENT	
SURFACE CONDITIONS	
DESCRIPTION: Group Name, Moisture, Color, Consistency, Density, Other	
<p>silty SAND, non plastic, wet, brown-grey, med dense to loose, fine-very fine grained, H.C. addn.</p>	
<p>SAND, wet, med dense to loose, brown to greyish brown, due to med. graind (pred. fine) trace coarse sand, sl. H.C. addn.</p>	
<p>1000 finish drilling, TD=25'</p>	
<p>Drum # 1 0-20 # 2 20-25 + clean-up</p>	
<p>Sch. 40 PVC: 20' x .02" slot - 10' 10' blank - 5' cut off</p>	
<p>2 1/2 Longstar sand (Lop. & Lu. line) pour sand slowly (no 2" Swab) - 7 bags</p>	
<p>3/8" bentonite chips, Baroid Holeplug top bent 1.5'</p>	
<p>10' water to surface push mounted EMCO Water box at surface</p>	

LOCATION OF BORING

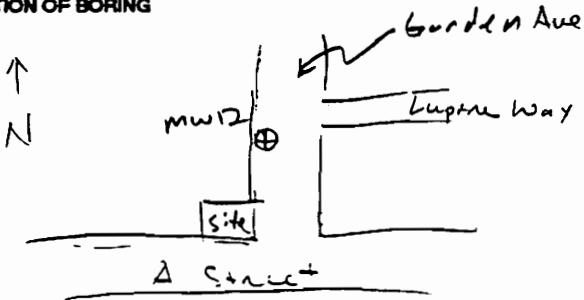

CLIENT EZ Some - Hayward				BORING NO. MW-12	
LOCATION Garden/Lupine, Hayward				JOB NO.	
	AT TIME OF DRILLING	SECOND	THIRD	FOURTH	SHEET 1 OF 2
WATER LEVEL	~13'				DRILLING
TIME	~1:40				START
DATE	2/6/95				FINISH
DRILLING CONTRACTOR Tonko				WELL CONSTR.	
RIG TYPE Mdl 361				START	
DRILLING METHOD, FLUID USED				FINISH	
Hollow stem, 8" auger				TIME	
				DATE	
				DATE	
				DATE	

WELL CONSTRUCTION	SOIL SAMPLING				DEPTH IN FEET	INSTRUMENT READING (ppm)	ESTIMATED PERCENT			MUNSELL COLOR NO.	USCS GROUP SYMBOL	DESCRIPTION: Group Name, Moisture, Color, Consistency, Density, Other
	CASING	ANNULUS	SAMPLER TYPE	BLOWS/INTERVAL			INTERVAL SAMPLED RECOVERY ANALYTICAL SAMPLE	GRAVEL	SAND			
					0							1725 begin breaking asphalt
					1							pool hole to clean up utilities to 4'
					2		60	40		SC		3" asphalt + ~6" road base
					3		50	50		EL		clayey SAND, light brown, gray mottle, sl. moist, lens, SL plastic
					4					SC		sandy CLAY, sl. moist, hard stiff to stiff,
					5							dark grey, fine to med fine grained sand
					6		5	60	35	SC		mix with SC as above
					7		0	80	20	SP		clayey sand, sl. moist, med. dense, fine to coarse sand, poorly sorted Red-brown, some dark grey mottle, some gravel
					8							SAND, sl. moist, med. dense, Red-brown, fine gr.
					9							mod. well sorted No odor
					10					SP		as above, moist
					11		0	10	85	SC		sandy CLAY, Red-brown, orange ox. bands, moist, soft to med stiff, some veg. fragments
					12							
					13							
					14							
					15							inc. gw 10-15 (?) - drill sampler in
					16							
					17							
					18		0	20	80	SC		sandy clay, sl. moist, light gray, Red-brown mottle, mod. plastic, fine grained sand stiff to very stiff
					19							moist lower
					20							

DRILLER **S. Mulvaney**
 DATE **2/6/95**
 CHECKED BY **S. Mulvaney**
 LOGGED BY **S. Mulvaney**

LOCATION OF BORING

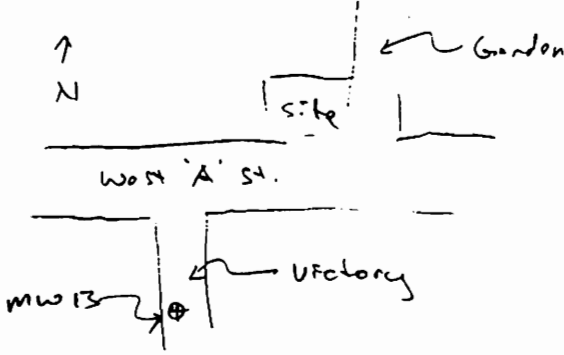

CLIENT E2 Serve Hayward				BORING NO. MW-13	
LOCATION Victoria St, Hayward			JOB NO.		
AT-TIME OF DRILLING	SECOND	THIRD	FOURTH	SHEET 1 of 2	
WATER LEVEL	~17'				
TIME	0815				
DATE	2/7/95				
DRILLING CONTRACTOR Tonto				DRILLING START TIME: 7:40am FINISH TIME: 8:30	
RIG TYPE Mobil RG1				DATE: 2/7/95	
DRILLING METHOD, FLUID USED Hollow stem, 8" auger				WELL CONSTR. START TIME: 8:30 FINISH TIME: 10:30am	
				DATE: 2/7/95	

WELL CONST-RUCTION	SOIL SAMPLING				DEPTH IN FEET	INSTRUMENT READING (ppm)	ESTIMATED PERCENT			MUNSELL COLOR NO.	USCS GROUP SYMBOL	DESCRIPTION: Group Name, Moisture, Color, Consistency, Density, Other
	SAMPLER TYPE	BLOWS/8" INTERVAL	INTERVAL SAMPLED	RECOVERY ANALYTICAL SAMPLE			GRAVEL	SAND	FINES			
	Well bot				0							7:40 am - begin breaking asphalt
	concrete				1			10	90		CL	~4" asphalt, ~4" sand base - part hole to 4" sandy CLAY, sl. moist, dark grey, med stiff to stiff very fine SAND, no odor
					2							
					3							
					4							
					5			60	40		SC	Clayey sand, fine gr sand, sl. plast. sl. moist, dense, brown grades to
					6			70	30		SM	Stiff SAND, yell-brn, sl. moist, non-plast. med. dense No odor, fine-gr.
					7							
					8							
					9							
					10			30	70		ML	sandy silt, light br-grey, sl. moist to moist, sl. plastic, med dense, fine-gr. sand, No odor some orange mottle (as oxid.)
					11							
					12							
					13							
					14							
					15			60	40		SC	clayey SAND, light grey with red-brown mottle, sl. plastic, dense to very dense, sl. moist, very fine sand, No odor
					16							
					17							
					18							
					19							
					20							

Blank →

low between 16.5-20

LOCATION OF BORING



CLIENT <i>EZ Serve Hayward</i>				BORING NO. <i>MW-14</i>	
LOCATION <i>S of Lunaria on Garden</i>			JOB NO.		
	AT TIME OF DRILLING	SECOND	THIRD	FOURTH	SHEET <i>1</i> OF <i>1</i>
WATER LEVEL	<i>2/3'</i>				DRILLING START TIME <i>11:00 am</i> FINISH TIME <i>12:25</i>
TIME	<i>12:15</i>				DATE <i>2/7/94</i> DATE <i>2/7/95</i>
DATE	<i>2/7/95</i>				DRILLING CONTRACTOR <i>Tonto</i>
RIG TYPE <i>Mobil 1561</i>				WELL CONSTR. START TIME FINISH TIME	
DRILLING METHOD, FLUID USED <i>Hollow stem, 8" auger</i>				DATE DATE	

WELL CONSTRUCTION	SOIL SAMPLING				DEPTH IN FEET	INSTRUMENT READING (ppm)	ESTIMATED PERCENT			MUNSELL COLOR NO.	USCS GROUP SYMBOL	DESCRIPTION: Group Name, Moisture, Color, Consistency, Density, Other
	CASING	ANNULUS	SAMPLER TYPE	BLOWS/B INTERVAL			INTERVAL SAMPLED RECOVERY ANALYTICAL SAMPLE	GRAVEL	SAND			
					0							4" asphalt, 24" road base post hole for 4"
					1			70	30		SC	Clayey SAND, dark grey, sl. moist, med dense to dense fine to very fine sand, non-plastic to sl. plastic.
					2							
					3							
					4							
					5			75	25		SC	clayey Sand, red-brown, sl. moist, med dense, non plastic, fine grained
					6	0						
					7							
					8							
					9							
					10			60	40		SM	silty SAND, moist, brown, red-brown mottle, med dense, fine grained
					11	0						
					12							
					13							
					14							
					15			60	40		SM	silty SAND, moist to wet, grey, med dense, non plastic
					16	0		15	85		CL	Clay, moist to wet grey, med stiff, med. plastic. some sand, fine grained
					17							
					18							
					19							
					20							

LOCATION OF BORING

CLIENT					BORING NO.	
LOCATION			JOB NO.			
	AT TIME OF DRILLING	SECOND	THIRD	FOURTH	SHEET OF	
WATER LEVEL					DRILLING	
TIME					START	FINISH
DATE					TIME	TIME
DRILLING CONTRACTOR					DATE	DATE
RIG TYPE					WELL CONSTR.	
DRILLING METHOD, FLUID USED					START	FINISH
					TIME	TIME
					DATE	DATE

WELL CONSTRUCTION	SOIL SAMPLING				DEPTH IN FEET	INSTRUMENT READING (ppm)	ESTIMATED PERCENT			MUNSELL COLOR NO.	USCS GROUP SYMBOL
	CASING	ANNULUS	SAMPLER TYPE	BLOWS/8" INTERVAL			INTERVAL SAMPLED RECOVERY ANALYTICAL SAMPLE	GRAVEL	SAND		
			14	1	20		65	35		SC	
			17	1	1	2000					
			22	1	1		70	30		SM	
					2						
					3						
					4						
					5						
			6	1	25		20	80		CL	
			6	1	6	200				CL	
			12	1	6		60	40		SC	
					7						
					8						
					9						
					10						
			5	1	30		70	30		SM	
			7	1	1	165					
			10	1	1						
					2						
					3						
					4						
					5						
					6						
					7						
					8						
					9						
					10						

SOIL SAMPLING METHOD _____ SURFACE ELEV. _____

MONITORING INSTRUMENT _____

SURFACE CONDITIONS _____

DESCRIPTION: Group Name, Moisture, Color, Consistency, Density, Other

Clayey SAND, moist, Red-brown, dense to very dense, fine gr. sand, moderate HC (gas) odor

silty SAND, wet, grey, med dense, fine gr. sand, med. to strong odor

CL sandy CLAY, wet, grey, med stiff, sl. HC odor

SC clayey SAND, red-brn, moist to wet, dense

silty SAND, Red-brn, wet, med dense, sl. HC odor, grey mottle, fine sand

20' 102" slot, 2" φ, sch 40 PVC
10' blank
2 1/2 sand - top 8'
12 55 seal in, 3/8" bentonite top at 5'

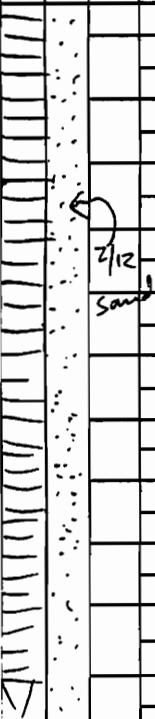









PROJECT: E-Z SERVE LOCATION NO. 100877
 LOCATOIN: VEAS-2
 BORING DATE: 06-20-02

SOIL BORING / WELL LOG

DATUM: GROUND SURFACE

DIP: VERTICAL

LOGGED: SCOTT LEVIN

DEPTH SCALE		SOIL PROFILE			SAMPLIES				CONCENTRATION		
FEET	10" HOLLOW STEM AUGERS	DESCRIPTION	STRATA PLOT	DEPTH B.G.S. (ft)	ID	SOIL TYPE	BLOWS / FOOT	ODOR / STAIN	OVA (PPM) TPHg ANALYTICAL RESULTS (mg/kg)		
0		UNPAVED SURFACE									
2		SANDY SILT ORGANIC (ML), BLACK (10yr 2/1), LOOSE, MOIST, NO HYDROCARBON (HC) ODOR.									
4		SANDY SILT (ML), DARK GRAYISH BROWN (10yr 4/2), INELASTIC SILT, FINE GRAINED SAND, MEDIUM DENSE, SLIGHTLY DAMP, NO HC ODOR.									
6		CLAYEY SAND-SANDY CLAY (CL-SC), BROWN (7.5yr 5/4), VERY FINE GRAINED SAND, LOW PLASTIC CLAY, TRACE SILT, VERY STIFF, SLIGHTLY DAMP, NO HC ODOR.			VEAS-2/5	CL	20	NN	1.1 N/A		
8											
10		SANDY SILT (ML), STRONG BROWN (7.5yr 5/6), SILT, VERY FINE GRAINED SAND, FIRM, MOIST, NO HC ODOR.			VEAS-2/10	ML	5	NN	1.3 N/A		
12											
14		LEAN CLAY (CL), STRONG BROWN (7.5yr 5/6), LOW TO MEDIUM PLASTIC CLAY, VERY STIFF, VERY MOIST, HC ODOR AND STAIN.			VEAS-2/15	ML	18	YY	225 N/A		
16											
18											
20		SILTY CLAY (CL), STRONG BROWN (7.5yr 5/6), LOW TO MEDIUM PLASTIC CLAY, SILT, TRACE VERY FINE GRAINED SAND, VERY STIFF, WET, HC ODOR AND STAIN.			VEAS-2/20	CL	22	Y/N	223 N/A		
22											
24											
26		BECOMES YELLOWISH BROWN (10yr 5/4), LESS CLAY, MORE SILT, TRACE FINE GRAINED SAND, STIFF, WET, HC ODOR, NO STAIN.			VEAS-2/25	CL	9	YY	17.5 N/A		
28											
30		CLAYEY SILT (ML), BROWN (7.5yr 5/4), ELASTIC SILT, LOW PLASTIC CLAY, TRACE FINE GRAINED SAND, STIFF, WET, NO HC ODOR.			VEAS-2/30	ML	11	Y/N	3.4 N/A		
32		TOTAL DRILLING DEPTH = 30.5' BGS									
34		BOREHOLE COMPLETED AS DUAL COMPLETION VAPOR EXTRACTION /AIR SPARGE WELL WITH 4-INCH DIAMETER PVC CASING, SLOTTED SCREEN (0.020") FROM 5 TO 15 FEET BGS, AND A TWO FOOT LONG, 1-INCH DIAMETER STAINLESS STEEL AIR SPARGE POINT SET FROM 28 TO 30 FEET BGS.									
36											
38											
40											
42											
44											
46											
48											
50											

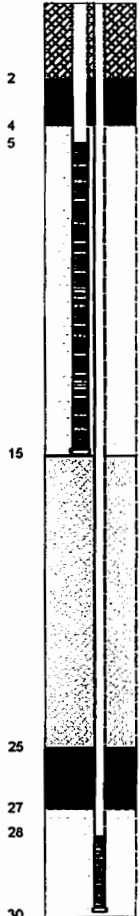

PROJECT: E-Z SERVE LOCATION NO. 100877

LOCATION: VEAS-3









BORING DATE: 09-20-02

SOIL BORING / WELL LOG

DATUM: GROUND SURFACE

DIP: VERTICAL

LOGGED: SCOTT LEVIN

DEPTH SCALE		1" HOLLOW-STEM AUGERS	SOIL PROFILE		SAMPLES				CONCENTRATION	
FEET			DESCRIPTION	STRATA PLOT	ID	SOIL TYPE	BLOWS / FOOT	ODOR / STAIN	OVA (PPM) TPHg ANALYTICAL RESULTS (mg/kg)	
0			UNPAVED SURFACE							
2			SANDY SILT WITH ORGANIC (ML-OL), BLACK (10yr 2/1), LOOSE, MOIST, NO HYDROCARBON (HC) ODOR							
4			SANDY SILT (ML), DARK GRAYISH BROWN (10yr 4/2), INELASTIC SILT, FINE GRAINED SAND, MEDIUM DENSE, SLIGHTLY DAMP, NO HC ODOR.		VEAS-3/5	ML	19	NN	1.1 N/A	
6										
8			SILTY CALY (CL), STRONG BROWN (7.5yr 5/6), LOW TO MEDIUM PLASTIC CLAY, ELASTIC SILT, TRACE VERY FINE GRAINED SAND, STIFF, VERY MOIST, NO HC ODOR.		VEAS-3/10	CL	9	NN	1.3 N/A	
10										
12										
14			LEAN CLAY (CL), STRONG BROWN (7.5yr 5/6), LOW TO MEDIUM PLASTIC CLAY, VERY STIFF, SLIGHTLY DAMP TO DAMP, NO HC ODOR.		VEAS-3/15	CL	21	YY	5.9 N/A	
16										
18										
20			SILTY CLAY (CL), STRONG BROWN (7.5yr 5/6), LOW PLASTIC CLAY, INELASTIC SILT, TRACE VERY FINE GRAINED SAND, VERY STIFF, MOIST TO VERY MOIST, HC ODOR AND HC STAIN.		VEAS-3/20	CL	29	YY	51.5 N/A	
22										
24										
26			BECOMES GRAY (5yr 5/1), LESS CLAY, SILT INCREASES, FIRM, WET, STRONG HC ODOR AND HC STAIN.		VEAS-3/25	CL	7	YY	3.2 N/A	
28										
28			CLAYEY SILT (ML), YELLOWISH BROWN (10yr 5/4), ELASTIC SILT, LOW PLASTIC CLAY, TRACE VERY FINE GRAINED SAND, VERY STIFF, VERY MOIST, NO HC ODOR.		VEAS-3/30	CL	22	NN	3.2 N/A	
30			TOTAL DRILLING DEPTH = 30.5' BGS							
32			BOREHOLE COMPLETED AS DUAL COMPLETION VAPOR EXTRACTION /AIR SPARGE WELL WITH 4-INCH DIAMETER PVC CASING, SLOTTED SCREEN (0.020") FROM 5 TO 15 FEET BGS, AND A TWO FOOT LONG, 1-INCH DIAMETER STAINLESS STEEL AIR SPARGE POINT SET FROM 28 TO 30 FEET BGS.							
34										
36										
38										
40										
42										
44										
46										
48										
50										

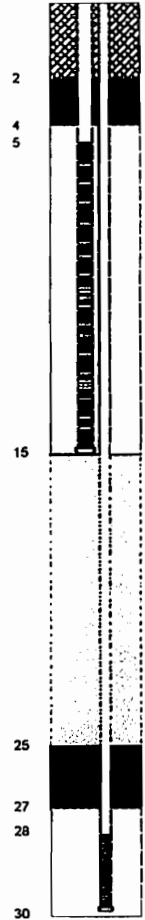

PROJECT: E-Z SERVE LOCATION NO. 100877
 LOCATOIN: EX-1
 BORING DATE: 06-24-02

SOIL BORING / WELL LOG

DRILLING COMP.: BAY AREA EXPLORATION
 DRILLER: SCOTT FITCHIE

DATUM: GROUND SURFACE

DIP: VERTICAL

LOGGED: SCOTT LEVIN

DEPTH SCALE		SOIL PROFILE			SAMPLES				CONCENTRATION	
FEET	17" HOLLOW-STEM AUGERS	DESCRIPTION	STRATA PLOT	DEPTH B.G.S. (ft)	ID	SOIL TYPE	BLOWS / FOOT	ODOR / STAIN	OVA (PPM) TPHg ANALYTICAL RESULTS (mg/kg)	
0		UNPAVED SURFACE								
2										
4		SANDY SILT WITH GRAVEL (ML), DARY GRAYISH BROWN (2.5y 4/2), INELASTIC SILT, FINE GRAINED SAND, FINE SUBROUNDED GRAVEL, FIRM, DRY, NO HYDROCARBON (HC) ODOR.			EX-1/5'	ML			N/A N/A	
6										
8										
10		LEAN CLAY WITH SILT (CL), STRONG BROWN (7.5yr 5/6), VERY FINE GRAINED, LOW PLASTIC CLAY, SILT, STIFF, MOIST, NO HC ODOR, HC STAIN.			EX-1/10'	CL	8	NY	1.0 ppm <0.5	
12										
14										
16		BECOMES LESS SILT, VERY STIFF, MOIST, NO HC ODOR, HC STAIN.			EX-1/15'	CL	20	NY	11.7 ppm <0.5	
18										
20		SILTY CLAY WITH SAND (CL), BROWN (7.5yr 5/4), CLAY WITH LOW PLASTICITY, SEMI-ELASTIC SILT, VERY FINE GRAINED SAND, VERY STIFF, WET, NO HC ODOR.			EX-1/20'	CL	23	NN	846 ppm 100	
22										
24										
26		BECOMES DARK YELLOWISH BROWN (10yr 4/4), LESS CLAY, MORE SILT, FIRM, WET, NO HC ODOR.			EX-1/25'	CL	7	NN	2.5 ppm 1.1	
28										
30		CLAYEY SILT (ML), BROWN (7.5yr 5/4), ELASTIC SILT, CLAY WITH LOW PLASTICITY, TRACE FINE GRAINED SAND, STIFF, WET, NO HC ODOR.			EX-1/30'	ML	12	NN	3.7 ppm <0.5	
32										
34					EX-1/35'	ML	18	NN	5.8 ppm <0.5	
36		TOTAL DRILLING 35.5' BGS.								
38		BOREHOLE COMPLETED AS 6-INCH DIAMETER GROUNDWATER EXTRACTION WELL, SCREENED FROM 10 TO 35 FEET BGS.								
40										
42										
44										
46										
48										
50										

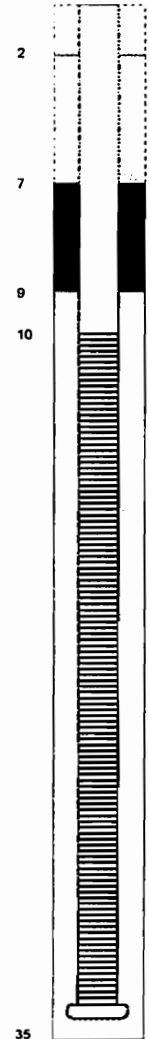



BORING LOG

Driller: Vironex - Direct Push

Date: 9/24/09

Logged By:

Boring Dia: 2.5 Inches

Boring ID: SB1

Joe Schaaf

Sample	Blow Counts	PID (ppm)	Depth Feet	Lithology	Description
					Asphalt Base Hand auger to 5 feet.
	-	0	5		Silty CLAY (CL), dark brown, dry, no hydrocarbon odor or stain.
	--	0	10		moderate yellowish brown, moist, non plastic, no hydrocarbon odor or stain.
	--	0	15		CLAY (CL), greenish brown, moist, moderate plasticity, no hydrocarbon odor or stain.
	--	5	20		Silty CLAY (CL), moderate brown, moist, moderate plasticity, no hydrocarbon odor or stain.
	--	260	25		CLAY (CL), greenish gray, moist, moderate plasticity, hydrocarbon odor, hydrocarbon stain.
	--	5	30		Silty CLAY (CL), greenish gray, wet Total Boring Depth 30 Feet. Initial Groundwater at 25 Feet.

Completion Notes:

Soil Boring (SB1) completed to a depth of approximately 30 feet and backfilled with cement / bentonite grout from 6-inches to total depth. Ground surface was patched with 6-inches of black colored concrete. Initial groundwater encountered at 25 feet. A temporary 3/4-inch PVC casing was insert in to the open borehole with 5 foot screen and 1/4-inch polyethylene tubing to collect groundwater sample prior to backfill.

Site:

Former EZ 100877
525 West A St.
Hayward, CA

Project No.: 07-131

Page 1



BORING LOG

Driller: Vironex - Direct Push

Date: 9/24/09

Logged By:

Boring Dia: 2.5 Inches

Boring ID: SB2

Joe Schaaf

Sample	Blow Counts	PID (ppm)	Depth Feet	Lithology	Description
					Asphalt Base Hand auger to 5 feet.
			5		Silty CLAY (CL), moderate brown, moist, moderate plasticity, no hydrocarbon odor or stain.
	-	0	10		
	-	0	15		CLAY (CL), moderate brown, slightly moist, moderate plasticity, no hydrocarbon odor or stain.
	-	30	20		CLAY (CL), greenish brown, slightly moist, moderate plasticity, slight hydrocarbon odor and stain.
	-	40	25		CLAY (CL), greenish brown, wet, moderate plasticity, slight hydrocarbon odor, no hydrocarbon stain.
	-	0	30		CLAY (CL), moderate brown, wet, moderate plasticity, no hydrocarbon odor or stain. Total Boring Depth 30 Feet. Initial Groundwater at 25'

Completion Notes:

Soil Boring (SB2) completed to a depth of approximately 30 feet and backfilled with cement / bentonite grout from 6-inches to total depth. Ground surface was patched with 6-inches of black colored concrete. Initial groundwater encountered at 25 feet. A temporary 3/4-inch PVC casing was insert in to the open borehole with 5 foot screen and 1/4-inch polyethylene tubing to collect groundwater sample prior to backfill.

Site:

Former EZ 100877
525 West A St.
Hayward, CA

Project No.: 07-131

Page 1



BORING LOG

Driller: Vironex - Direct Push

Date: 9/24/09

Logged By:

Boring Dia: 2.5 Inches

Boring ID: SB3

Joe Schaaf

Sample	Blow Counts	PID (ppm)	Depth Feet	Lithology	Description
			0		Asphalt Base Hand auger to 5 feet.
	-	0	5		CLAY (CL), moderate brown, dry, low plasticity, no hydrocarbon odor or stain.
	-	0	10		
	-	0	15		CLAY (CL), greenish brown, moist, moderate plasticity, no hydrocarbon odor or stain.
	-	10	20		CLAY (CL), greenish brown, moist, moderate plasticity, no hydrocarbon odor or stain.
	-	50	25		CLAY (CL), greenish brown, moist, moderate plasticity, slight hydrocarbon odor, no hydrocarbon stain.
	-	0	30		CLAY (CL), moderate brown, wet, moderate plasticity, no hydrocarbon odor or stain. Total Boring Depth 30 Feet. Initial Groundwater at 25'

Completion Notes:

Soil Boring (SB3) completed to a depth of approximately 30 feet and backfilled with cement / bentonite grout from 6-inches to total depth. Ground surface was patched with 6-inches of black colored concrete. Initial groundwater encountered at 25 feet. A temporary 3/4-inch PVC casing was insert in to the open borehole with 5 foot screen and 1/4-inch polyethylene tubing to collect groundwater sample prior to backfill.

Site:

Former EZ 100877
525 West A St.
Hayward, CA

Project No.: 07-131

Page 1



BORING LOG

Driller: Vironex - Direct Push

Date: 9/24/09

Logged By:

Boring Dia: 2.5 Inches

Boring ID: SB4

Joe Schaaf

Sample	Blow Counts	PID (ppm)	Depth Feet	Lithology	Description
					Asphalt Base
					Silty SAND (SM), dark brown, fill material, void from 2 to 4 feet (septic?), saturated soil at 4 feet.
			5		CLAY (CL), moderate brown, dry, moderate plasticity, no hydrocarbon odor or stain.
	--	0	10		CLAY (CL), greenish brown, moist, moderate plasticity, no hydrocarbon odor or stain.
	--	0	15		CLAY (CL), greenish brown, moist, moderate plasticity, no hydrocarbon odor or stain.
	--	20	20		CLAY (CL), greenish brown, wet, moderate plasticity, hydrocarbon odor and stain.
	--	350	25		CLAY (CL), moderate brown, wet, moderate plasticity, no hydrocarbon odor or stain.
			30		Total Boring Depth 30 Feet. Initial Groundwater at 4' No groundwater sample collected, moved over to SB4A location to collect groundwater sample.

Completion Notes:

Soil Boring (SB4) completed to a depth of approximately 30 feet and backfilled with cement / bentonite grout from 6-inches to total depth. Ground surface was patched with 6-inches of black colored concrete. Initial groundwater encountered at 4 feet. Could not collect water sample from water table.

Site:

Former EZ 100877
525 West A St.
Hayward, CA

Project No.: 07-131

Page 1



BORING LOG

Driller: Vironex - Direct Push

Date: 9/24/09

Logged By:

Boring Dia: 2.5 Inches

Boring ID: SB4A

Joe Schaaf

Sample	Blow Counts	PID (ppm)	Depth Feet	Lithology	Description
			5		Boring SB4A was completed adjacent to SB4 for groundwater sample collection purposes, no soil samples collected.
			10		
			15		
			20		
			25		
			30		
					Total Boring Depth 30 Feet. Initial Groundwater at 25'

Completion Notes:

Soil Boring (SB4A) completed to a depth of approximately 30 feet and backfilled with cement / bentonite grout from 6-inches to total depth. Ground surface was patched with 6-inches of black colored concrete. Initial groundwater encountered at 25 feet. A temporary 3/4-inch PVC casing was insert in to the open borehole with 5 foot screen and 1/4-inch polyethylene tubing to collect groundwater sample prior to backfill.

Site:

Former EZ 100877
 525 West A St.
 Hayward, CA

Project No.: 07-131

Page 1



BORING LOG

Driller: Vironex - Direct Push

Date: 9/24/09

Logged By:

Boring Dia: 2.5 Inches

Boring ID: SB5

Joe Schaaf

Sample	Blow Counts	PID (ppm)	Depth Feet	Lithology	Description
			5		Asphalt Base Hand auger to 5 feet.
	--	0	10		Silty CLAY (CL), moderate yellowish brown, slightly moist, moderate plasticity, no hydrocarbon odor or stain.
	--	0	15		CLAY (CL), greenish brown, slightly moist, moderate plasticity, no hydrocarbon odor or stain.
	--	30	20		CLAY (CL), greenish brown, slightly moist, moderate plasticity, no hydrocarbon odor or stain.
	--	60	25		CLAY (CL), greenish gray, wet, moderate plasticity, hydrocarbon odor and stain.
	--	5	30		CLAY (CL), moderate brown, wet, moderate plasticity, no hydrocarbon odor or stain. Total Boring Depth 30 Feet. Initial Groundwater at 25'

Completion Notes:

Soil Boring (SB5) completed to a depth of approximately 30 feet and backfilled with cement / bentonite grout from 6-inches to total depth. Ground surface was patched with 6-inches of black colored concrete. Initial groundwater encountered at 25 feet. A temporary 3/4-inch PVC casing was insert in to the open borehole with 5 foot screen and 1/4-inch polyethylene tubing to collect groundwater sample prior to backfill.

Site:

Former EZ 100877
525 West A St.
Hayward, CA

Project No.: 07-131

Page 1



BORING LOG

Driller: Vironex - Direct Push

Date: 9/24/09

Logged By:

Boring Dia: 2.5 Inches

Boring ID: SB6

Joe Schaaf

Sample	Blow Counts	PID (ppm)	Depth Feet	Lithology	Description
			5		Asphalt Base Hand auger to 5 feet.
	-	0	10		Silty CLAY (CL), greenish brown, dry, low plasticity, no hydrocarbon odor or stain.
	--	0	15		CLAY (CL), greenish gray, moist, moderate plasticity, no hydrocarbon odor or stain.
	--	30	20		CLAY (CL), greenish brown, slightly moist, low plasticity, no hydrocarbon odor or stain.
	--	60	25		CLAY (CL), greenish gray, wet, moderate plasticity, hydrocarbon odor and stain.
	--	5	30		CLAY (CL), greenish brown, wet, moderate plasticity, no hydrocarbon odor or stain. Total Boring Depth 30 Feet. Initial Groundwater at 25'

Completion Notes:

Soil Boring (SB6) completed to a depth of approximately 30 feet and backfilled with cement / bentonite grout from 6-inches to total depth. Ground surface was patched with 6-inches of black colored concrete. Initial groundwater encountered at 25 feet. A temporary 3/4-inch PVC casing was insert in to the open borehole with 5 foot screen and 1/4-inch polyethylene tubing to collect groundwater sample prior to backfill.

Site:

Former EZ 100877
525 West A St.
Hayward, CA

Project No.: 07-131

Page 1

**APPENDIX D
HISTORICAL SOIL AND HYDROPUNCH
GROUNDWATER ANALYTICAL DATA**

TABLE 1
PREVIOUS SITE INVESTIGATION
GROUNDWATER MONITOR WELLS
SOIL SAMPLE ANALYTICAL RESULTS (ASA, January 1992/June 1993; BC, February 1995)
FORMER EZ-SERVE FACILITY NO. 100877
ATC JOB NO. 43.25827.0024
(Results in milligrams per kilogram (mg/kg))

Sample Identification	Sample Depth (feet)	Sampling Date	Lithology	TPH EPA 8015	Benzene EPA 8020	Toluene EPA 8020	Ethylbenzene EPA 8020	Total Xylenes EPA 8020
MW-1	11.0-11.5	1/28/1992	Sand	<0.5	0.12	<0.005	0.0073	0.0053
MW-1	16.0-16.5	1/28/1992	Clay	19	0.98	0.013	0.17	0.35
MW-2	11.0-11.5	1/28/1992	Silty Sand	<0.5	<0.005	<0.005	<0.005	<0.005
MW-2	16.0-16.5	1/28/1992	Clay	5.4	<0.005	<0.005	1.1	0.057
MW-3	11.0-11.5	1/28/1992	Silty Sand	5.6	0.69	<0.005	0.048	0.013
MW-3	16.0-16.5	1/28/1992	Clay	6.4	1.0	<0.005	0.13	0.078
MW-4	6.0-6.5	1/28/1992	Silty Sand	28	0.035	<0.024	0.4	1.6
MW-4	11.0-11.5	1/28/1992	Silty Sand	5.7	0.22	0.076	0.17	0.64
MW-4	16.0-16.5	1/28/1992	Clay	15	2.7	1.2	0.39	1.8
MW-5	11.0-11.5	1/28/1992	Silty Sand	0.79	0.3	<0.005	0.049	0.019
MW-5	16.0-16.5	1/28/1992	Clay	7.2	0.66	0.016	0.16	0.55
MW-6	11.0-11.5	1/28/1992	Silty Sand	<0.5	0.0076	<0.005	<0.005	0.0052
MW-6	16.0-16.5	1/28/1992	Clay	0.55	0.17	<0.005	0.016	0.021
MW-7	5	6/21/1993	Clay	<0.5	<0.005	<0.005	<0.005	<0.015
MW-7	10	6/21/1993	Silty Sand	<0.5	<0.005	<0.005	<0.005	<0.015
MW-7	15	6/21/1993	Silty Clay	0.5	0.012	<0.005	0.038	<0.015
MW-8	5	6/22/1993	Silty Clay	<0.5	<0.005	<0.005	<0.005	<0.015
MW-8	10	6/22/1993	Silty Clay	<0.5	<0.005	<0.005	<0.005	<0.015
MW-8	15	6/22/1993	Silty Clay	<0.5	<0.005	<0.005	<0.005	<0.015
MW-9	5	6/22/1993	Silty Clay	<0.5	<0.005	<0.005	<0.005	<0.015
MW-9	10	6/22/1993	Silty Sand	<0.5	0.015	<0.005	<0.005	<0.015
MW-9	15	6/22/1993	Clay	9	0.13	0.027	0.19	0.76
MW-10	5	6/22/1993	Silty Clay	<0.5	<0.005	<0.005	<0.005	<0.015
MW-10	10	6/22/1993	Sandy Silt	<0.5	0.016	<0.005	<0.005	<0.015
MW-10	15	6/22/1993	Clay	0.59	0.0089	<0.005	0.051	0.015

TABLE 1
PREVIOUS SITE INVESTIGATION
GROUNDWATER MONITOR WELLS
SOIL SAMPLE ANALYTICAL RESULTS (ASA, January 1992/June 1993; BC, February 1995)
FORMER EZ-SERVE FACILITY NO. 100877
ATC JOB NO. 43.25827.0024
(Results in milligrams per kilogram (mg/kg))

Sample Identification	Sample Depth (feet)	Sampling Date	Lithology	TPH EPA 8015	Benzene EPA 8020	Toluene EPA 8020	Ethylbenzene EPA 8020	Total Xylenes EPA 8020
MW-11	10	2/6/1995	Silty Sand	<100	<1	<1	2	5
MW-11	15	2/6/1995	Clayey Sand	100	<1	<1	2	5
MW-12	10	2/6/1995	Sandy Clay	310	<1	<1	1	4
MW-12	15	2/6/1995	Sandy Clay	<100	<1	<1	<1	1
MW-13	10	2/7/1995	Sandy Silt	<100	<1	<1	<1	<1
MW-13	15	2/7/1995	Clayey Sand	<100	<1	<1	<1	11
MW-14	10	2/7/1995	Silty Sand	<100	<1	<1	<1	<1
MW-14	15	2/7/1995	Silty Sand	760	1	<1	1	9

Notes:

TPH Total petroleum hydrocarbons; analyzed by EPA method 8015
<0.5 Less than the detection limit of 0.5
mg/kg milligrams per kilograms (parts per million)

TABLE 2
GROUNDWATER MONITOR AND REMEDIATION WELL
CONSTRUCTION DETAILS AND SURVEY DATA
FORMER E-Z SERVE LOCATION NO. 100877
525 West A Street, Hayward, California

Well Number	Date of Construction	Casing Diameter (inches)	Boring Diameter (inches)	Screen Slot Size (inches)	Total Depth (ft bgs)	Screened Interval (ft bgs)	Surveyed Top of Casing Elevation (feet AMSL)	Surveyed Date
MW-1	1/28/1992	4	11	0.020	30	15-29	41.75	2/5/2002
MW-1A	--	4	--	--	30	--	43.40	2/5/2002
MW-2	1/28/1992	4	11	0.020	30	15-29	43.26	2/5/2002
MW-3	1/28/1992	4	11	0.020	30	15-29	43.89	2/5/2002
MW-4	1/28/1992	4	11	0.020	30	15-29	42.76	2/5/2002
MW-5	1/29/1992	4	11	0.020	30	15-29	42.10	2/5/2002
MW-6	1/29/1992	4	11	0.020	30	15-29	42.33	2/5/2002
MW-7	6/21/1993	2	8.5	0.020	30	10-29	42.70	2/5/2002
MW-8	6/22/1993	2	8.5	0.020	30	10-29	--	--
MW-9	6/22/1993	2	8.5	0.020	30	10-29	--	--
MW-10	6/22/1993	2	8.5	0.020	30	10-29	--	--
MW-11	2/6/1995	2	8	0.020	25	5-25	--	--
MW-12	2/6/1995	2	8	0.020	30	10-30	43.25	2/5/2002
MW-13	2/7/1995	2	8	0.020	30	10-30	40.97	2/5/2002
MW-14	2/7/1995	2	8	0.020	30	10-30	43.19	2/5/2002
VE/AS-1	6/20/2002	4/1	10	0.020	30	5-15/28-30	--	--
VE/AS-2	6/20/2002	4/1	10	0.020	30	5-15/28-30	--	--
VE/AS-3	6/20/2002	4/1	10	0.020	30	5-15/28-30	--	--
EX-1	6/24/2002	6	12	0.020	35	10-35	--	--

Notes :
 AMSL = Above mean sea level
 -- = Data not available.

TABLE 5
ADDITIONAL SITE ASSESSMENT
GROUNDWATER MONITOR AND REMEDIATION WELLS
SOIL SAMPLE ANALYTICAL RESULTS - PETROLEUM HYDROCARBONS AND FUEL OXYGENATES
FORMER E-Z SERVE LOCATION NO. 100877
525 WEST A STREET, CALIFORNIA

Soil Sample Identification	Sampling Date	TPHg EPA 8260B (mg/kg)	Benzene EPA 8260B (µg/kg)	Toluene EPA 8260B (µg/kg)	Ethylbenzene EPA 8260B (µg/kg)	Total Xylenes EPA 8260B (µg/kg)	TAME EPA 8260B (µg/kg)	TBA EPA 8260B (µg/kg)	DIPE EPA 8260B (µg/kg)	ETBE EPA 8260B (µg/kg)	MTBE EPA 8260B (µg/kg)
VEAS-1/5'	6/20/2002	<0.5	<0.005	<0.005	<0.005	<0.005	<0.005	<0.05	<0.005	<0.005	<0.005
VEAS-1/10'	6/20/2002	<0.5	<0.005	<0.005	<0.005	<0.005	<0.005	<0.05	<0.005	<0.005	<0.005
VEAS-1/15'	6/20/2002	69	<0.005	<0.005	0.83	3.0	<0.005	<0.05	<0.005	<0.005	<0.005
VEAS-1/20'	6/20/2002	670	0.7	<0.5	8.8	40	<0.5	<5.0	<0.5	<0.5	<0.5
VEAS-1/25'	6/20/2002	<0.5	<0.005	<0.005	<0.005	<0.005	<0.005	<0.05	<0.005	<0.005	<0.005
VEAS-1/30'	6/20/2002	<0.5	<0.005	<0.005	<0.005	<0.005	<0.005	<0.05	<0.005	<0.005	<0.005
VEAS-2/5'	6/20/2002	<0.5	<0.005	<0.005	0.005	0.017	<0.005	<0.05	<0.005	<0.005	<0.005
VEAS-2/10'	6/20/2002	<0.5	<0.005	<0.005	<0.005	0.010	<0.005	<0.05	<0.005	<0.005	<0.005
VEAS-2/15'	6/20/2002	2.0	0.012	<0.005	0.020	0.013	<0.005	<0.05	<0.005	<0.005	<0.005
VEAS-2/20'	6/20/2002	6.2	0.062	<0.005	0.086	0.10	<0.005	<0.05	<0.005	<0.005	<0.005
VEAS-2/25'	6/20/2002	1.9	<0.005	<0.005	0.016	0.026	<0.005	<0.05	<0.005	<0.005	<0.005
VEAS-2/30'	6/20/2002	<0.5	<0.005	<0.005	<0.005	0.006	<0.005	<0.05	<0.005	<0.005	<0.005
VEAS-3/5'	6/20/2002	<0.5	<0.005	<0.005	<0.005	0.007	<0.005	<0.05	<0.005	<0.005	<0.005
VEAS-3/10'	6/20/2002	<0.5	<0.005	<0.005	<0.005	<0.005	<0.005	<0.05	<0.005	<0.005	<0.005
VEAS-3/15'	6/20/2002	1.8	<0.005	<0.005	0.007	0.008	<0.005	<0.05	<0.005	<0.005	<0.005
VEAS-3/20'	6/20/2002	1.7	0.010	<0.005	0.036	0.024	<0.005	<0.05	<0.005	<0.005	<0.005
VEAS-3/25'	6/20/2002	<0.5	<0.005	<0.005	<0.005	<0.005	<0.005	<0.05	<0.005	<0.005	<0.005
VEAS-3/30'	6/20/2002	<0.5	<0.005	<0.005	<0.005	<0.005	<0.005	<0.05	<0.005	<0.005	<0.005
EX-1/10'	6/20/2002	<0.5	<0.005	<0.005	<0.005	<0.005	<0.005	<0.05	<0.005	<0.005	<0.005
EX-1/15'	6/20/2002	<0.5	0.006	<0.005	<0.005	<0.005	<0.005	<0.05	<0.005	<0.005	<0.005
EX-1/20'	6/20/2002	100	<0.1	<0.1	0.7	1.6	<0.1	<1.0	<0.1	<0.1	<0.1
EX-1/25'	6/20/2002	1.1	<0.005	<0.005	0.009	0.017	<0.005	<0.05	<0.005	<0.005	<0.005
EX-1/30'	6/20/2002	<0.5	<0.005	<0.005	<0.005	<0.005	<0.005	<0.05	<0.005	<0.005	<0.005
EX-1/35'	6/20/2002	<0.5	<0.005	<0.005	<0.005	0.007	<0.005	<0.05	<0.005	<0.005	<0.005

Notes:
TPHg Total petroleum hydrocarbons characterized as gasoline, analyzed by EPA method 8260B
MTBE Methyl-tertiary-butyl ether, analyzed by EPA 8260B
<# Less than the detection limit shown
mg/kg milligrams per kilograms (parts per million)

TABLE 1
 RESULTS OF LABORATORY ANALYSIS OF SOIL SAMPLES FROM SOIL BORINGS, SEPTEMBER 2009
 Former EZ Serve 100877 / 525 West A Street, Hayward, CA

Well Number	Date Sampled	TPH-G (mg/kg)	Benzene (µg/kg)	Toluene (µg/kg)	Ethyl-benzene (µg/kg)	Total Xylenes (µg/kg)	DIPE (µg/kg)	ETBE (µg/kg)	MTBE (µg/kg)	TAME (µg/kg)	EDB (µg/kg)	EDC (µg/kg)	TBA (µg/kg)
SB1-15'	9/24/2009	<3	<5	<5	<5	<5	<2	<2	<5	<2	<5	<5	<10
SB1-20'	9/24/2009	7.7	26	<5	73	8.6	<2	<2	<5	<2	<5	<5	<10
SB1-25'	9/24/2009	221	<250	<250	5,430	10,500	<100	<100	<250	<100	<250	<250	<500
SB1-30'	9/24/2009	33	<250	<250	569	1,060	<100	<100	<250	<100	<250	<250	<500
SB2-15'	9/24/2009	<3	<5	<5	<5	<5	<2	<2	<5	<2	<5	<5	<10
SB2-20'	9/24/2009	29	<10	<10	112	<10	<4	<4	<10	<4	<10	<10	<20
SB2-25'	9/24/2009	101	<250	<250	<250	<250	<100	<100	<250	<100	<250	<250	<500
SB2-30'	9/24/2009	<3	<5	<5	<5	<5	<2	<2	9.5	<2	<5	<5	<10
SB3-20'	9/24/2009	6.9	<250	<250	405	<250	<100	<100	<250	<100	<250	<250	<500
SB3-25'	9/24/2009	39	<5	<5	1,250	799	<2	<2	<5	<2	<5	<5	<10
SB3-30'	9/24/2009	<3	<5	<5	<5	<5	<2	<2	6.4	<2	<5	<5	<10
SB4-15'	9/24/2009	<3	<5	<5	<5	<5	<2	<2	<5	<2	<5	<5	<10
SB4-20'	9/24/2009	<3	<5	<5	208	13	<2	<2	<5	<2	<5	<5	<10
SB4-25'	9/24/2009	12	<250	<250	459	<250	<100	<100	<250	<100	<250	<250	<500
SB5-15'	9/24/2009	<3	<5	<5	<5	<5	<2	<2	<5	<2	<5	<5	<10
SB5-20'	9/24/2009	14	<250	<250	1,070	680	<100	<100	<250	<100	<250	<250	<500
SB5-25'	9/24/2009	102	<250	<250	778	<250	<100	<100	<250	<100	<250	<250	<500
SB5-30'	9/24/2009	<3	<5	<5	<5	<5	<2	<2	<5	<2	<5	<5	<10
SB6-15'	9/24/2009	<3	<5	<5	<5	<5	<2	<2	<5	<2	<5	<5	<10
SB6-20'	9/24/2009	18	<250	<250	359	<250	<100	<100	<250	<100	<250	<250	<500
SB6-25'	9/24/2009	7.6	25	<5	53	14	<2	<2	<5	<2	<5	<5	<10
SB6-30'	9/24/2009	<3	<5	<5	<5	<5	<2	<2	<5	<2	<5	<5	<10

Notes:

TPH-G = total petroleum hydrocarbons with gasoline distinction
 MTBE = methyl tertiary butyl ether
 DIPE = di-isopropyl ether
 ETBE = ethyl-tert-butyl ether
 TAME = tert-amyl methyl ether
 TBA = tert butanol
 mg/kg= milligrams per kilogram
 µg/kg= micrograms per kilogram
 -- = not analyzed, measured, or collected

Table 2-1 Summary of Analytical Results for In-Situ Groundwater Samples Collected from Former E-Z Serve Station #100877, 525 West A Street, Hayward, California

Sample Location	Date Collected	Concentration (micrograms per liter)				
		Benzene	Toluene	Ethylbenzene	Total Xylenes	TPHg ^a
HP-1	2/2/95	15	3.4	8.1	3.9	1,100
HP-2	2/2/95	600	180	3,800	13,000	170,000
HP-3	2/2/95	78	<5	73	180	2,800
HP-4	2/2/95	<0.5	<0.5	3.2	12	240
HP-5	2/2/95	<0.5	<0.5	1.3	5.1	230
HP-6	2/2/95	1,000	40	1,500	1,500	22,000
HP-7	2/2/95	1,000	32	490	340	11,000
HP-8	2/2/95	4.6	2.2	2.1	5.0	780
HP-9	2/2/95	<0.5	<0.5	1.3	4.0	100
HP-10	2/3/95	<0.5	<0.5	<0.5	<0.5	<50
HP-11	2/3/95	<0.5	0.84	<0.5	<0.5	<50
HP-12	2/3/95	<0.5	<0.5	<0.5	<0.5	<50
HP-13	2/3/95	<0.5	<0.5	<0.5	<0.5	<50
HP-14	2/3/95	<0.5	<0.5	<0.5	<0.5	<50
HP-15	2/3/95	<0.5	<0.5	<0.5	<0.5	<50
HP-16	2/3/95	4.2	<0.5	11	26	310
HP-17	2/3/95	3.8	<0.5	5.8	15	110

^aTotal petroleum hydrocarbons as gasoline: analyzed by Modified EPA Method 8015
Benzene, toluene, ethylbenzene, xylene isomers analyzed by EPA Method 8020

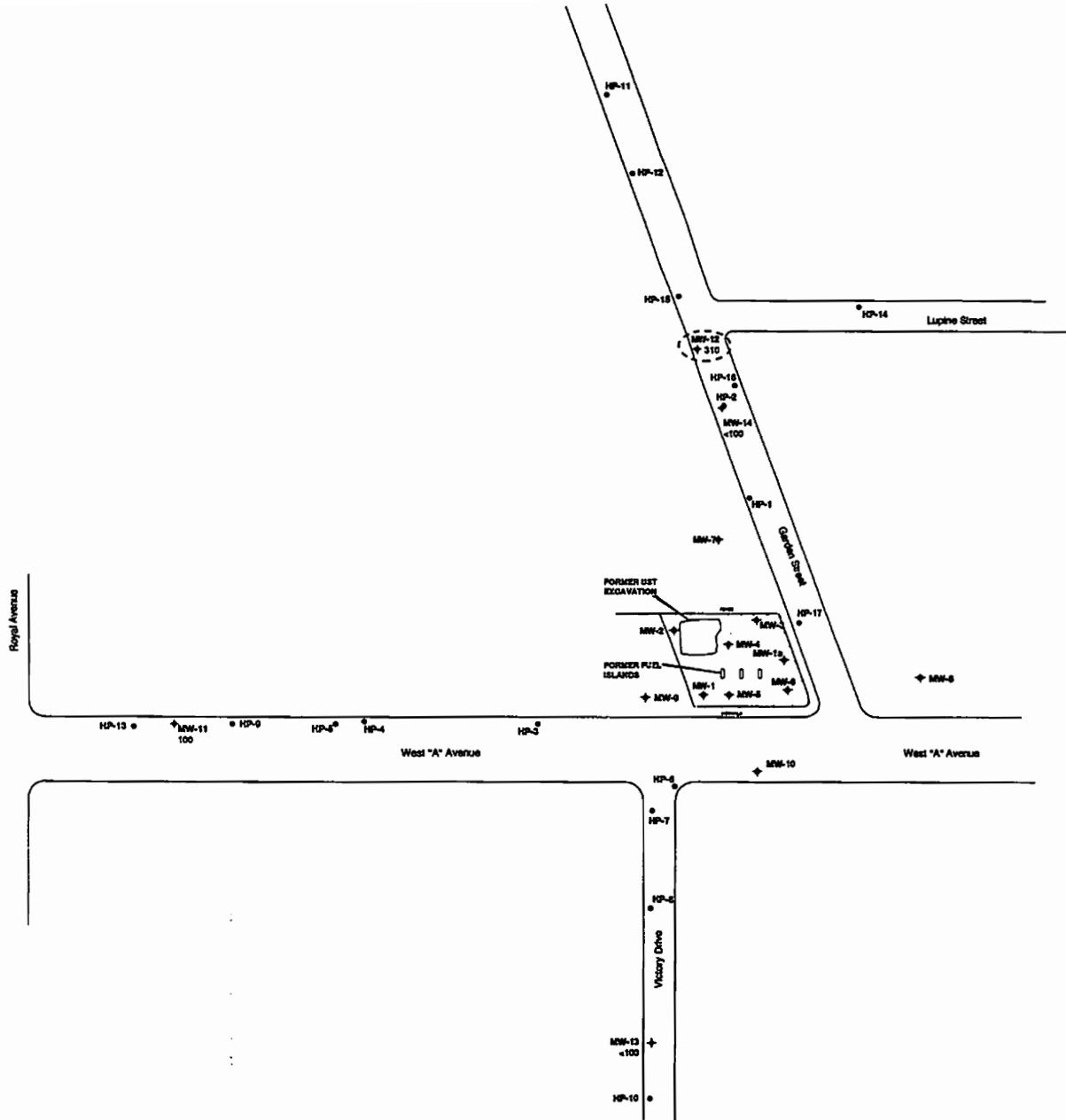

EXPLANATION	
	LOCATION OF PREVIOUSLY INSTALLED MONITORING WELL
	LOCATION OF MONITORING WELLS INSTALLED BY BROWN AND CALDWELL
	HYDROPUNCH GROUNDWATER SAMPLE LOCATIONS
	CONCENTRATION OF TPHg IN SOIL (in µg/g) AT 10' BELOW GROUND SURFACE

KTB EZServe Petroleum Marketing Company of California Former Station #100877 525 West A Street, Hayward, California		
TITLE TPHg In Soil Isoconcentration Map		
BROWN AND CALDWELL	DATE 2-22-95	Figure 3-6
	PROJECT 1564-07	

TABLE 2
RESULTS OF LABORATORY ANALYSIS OF WATER SAMPLES FROM SOIL BORINGS, SEPTEMBER 2009
Former EZ Serve 100877 / 525 West A Street, Hayward, CA

Well Number	Date Sampled	TPH-G (ug/L)	Benzene (ug/L)	Toluene (ug/L)	Ethyl-benzene (ug/L)	Total Xylenes (ug/L)	DIPE (ug/L)	ETBE (ug/L)	MTBE (ug/L)	TAME (ug/L)	EDB (ug/L)	EDC (ug/L)	TBA (ug/L)
SB1-W	9/24/2009	2,230	8.9	<5	91	141	<1	<1	199	<1	<5	<5	32
SB2-W	9/24/2009	1,640	<1	<5	37	9	<1	<1	149	<1	<5	<5	20
SB3-W	9/24/2009	1,830	4.6	<5	212	42	<1	<1	50	<1	<5	<5	<10
SB4A-W	9/24/2009	76	<1	<5	<5	<5	<1	<1	58	<1	<5	<5	11
SB5-W	9/24/2009	25,300	41.0	<10	1,090	167	<10	<10	36	<10	<50	<50	<100
SB6-W	9/24/2009	4,450	9.2	<5	13	<5	<1	<1	17	<1	<5	<5	<10

Notes:

TPH-G = total petroleum hydrocarbons with gasoline distinction
 MTBE = methyl tertiary butyl ether
 DIPE = di-isopropyl ether
 ETBE = ethyl-tert-butyl ether
 TAME = tert-amyl methyl ether
 TBA = tert butanol
 EDB = Ethylene dibromide
 EDC = Ethylene dichloride
 ug/L= micrograms per liter
 -- = not analyzed, measured, or collected

APPENDIX E
PRIME PROPERTIES 3Q10 GROUNDWATER
MONITORING DATA



HYDRO ANALYSIS, INC.

*Environmental & Water Resources Engineering
Groundwater Consultants*

August 25, 2010

Danilo Galang
City of Hayward Fire Department
Hayward City Hall
777 B Street
Hayward, CA 94541

Re: 580 West A Street
Hayward, CA
RB File No. 01-0027

Dear Mr. Galang:

Please find enclosed a copy of the report titled "*Semi-Annual Groundwater Monitoring, Prime Properties, 580 West A Street, Hayward, California*" by Hydro Analysis, Inc., dated August 25, 2010.

If you have any questions, please contact me at (510)620-0891.

Sincerely,

Gary Aguiar
Principal Engineer

TABLE 1.

**Shallow Water Table Elevations
August 13, 2010**

Well	Top of Casing Elevation (feet)	Depth to Water (feet)	Product Thickness (inch)	Elevation Adjustment (feet)	Water Table Elevation (feet)
MW-1	49.05	15.41	0	0.00	33.64
MW-2	48.99	15.38	0	0.00	33.61
MW-3	49.23	15.52	0	0.00	33.71
MW-4	48.75	15.08	0	0.00	33.67
MW-5	48.41	14.86	0	0.00	33.55
MW-6	49.29	15.74	0	0.00	33.55
MW-7	51.09	17.11	0	0.00	33.98
MW-8	48.58	14.66	SPOTTY SHEEN	0.00	33.92
MW-9	48.27	14.58	0	0.00	33.69
MW-10	48.41	14.71	0	0.00	33.70
MW-11	47.28	13.69	0	0.00	33.59
MW-12	48.14	14.26	0	0.00	33.88

FIGURE 2.
Shallow Groundwater Sampling Results

Well	Date	TPH as Gasoline (µg/L)	Benzene (µg/L)	Toluene (µg/L)	Ethyl-benzene (µg/L)	Total Xylenes (µg/L)	MTBE (µg/L)	DIPE (µg/L)	ETBE (µg/L)	TAME (µg/L)	TBA (µg/L)
MW-1	16-Aug-10	8,200	ND < 5	6.1	360	83	ND < 5	—	—	—	—
MW-2	16-Aug-10	4,300	35	3.7	58	13	ND < 2.5	—	—	—	—
MW-3	16-Aug-10	250	ND < 0.5	ND < 0.5	ND < 0.5	ND < 1	ND < 0.5	—	—	—	—
MW-4	16-Aug-10	2,100	ND < 0.5	ND < 0.5	ND < 0.5	ND < 1	14	—	—	—	—
MW-5	16-Aug-10	8,500	19	ND < 5	230	ND < 10	ND < 5	—	—	—	—
MW-6	16-Aug-10	12,000	ND < 20	ND < 20	1,200	49	ND < 20	—	—	—	—
MW-7	16-Aug-10	3,200	ND < 2.5	ND < 2.5	7.3	ND < 5	ND < 2.5	—	—	—	—
MW-8	16-Aug-10	6,600	16	ND < 5	49	ND < 10	ND < 5	—	—	—	—

ND = not detected

FIGURE 2. (continued)
Shallow Groundwater Sampling Results

Well	Date	TPH as Gasoline (µg/L)	Benzene (µg/L)	Toluene (µg/L)	Ethyl-benzene (µg/L)	Total Xylenes (µg/L)	MTBE (µg/L)	DIPE (µg/L)	ETBE (µg/L)	TAME (µg/L)	TBA (µg/L)
MW-9	13-Aug-10	4,400	9.8	ND < 2.5	3.7	ND < 5	ND < 2.5	—	—	—	—
MW-10	13-Aug-10	460	ND < 0.5	ND < 0.5	0.53	ND < 1	4.9	—	—	—	—
MW-11	16-Aug-10	1,800	ND < 0.5	ND < 0.5	ND < 0.5	ND < 1	26	—	—	—	—
MW-12	13-Aug-10	3,600	120	1.0	24	3.5	ND < 1	—	—	—	—

ND = not detected

FIGURE 3.
Shallow Irrigation Well Sampling Results

Well	Date	TPH as Gasoline (µg/L)	Benzene (µg/L)	Toluene (µg/L)	Ethyl-benzene (µg/L)	Total Xylenes (µg/L)	MTBE (µg/L)	DIPE (µg/L)	ETBE (µg/L)	TAME (µg/L)	TBA (µg/L)
LAGOMARSINO 21961 Victory Drive LAGOMARSINO	06-Apr-09	ND < 50	ND < 0.5	ND < 0.5	0.57	ND < 1	ND < 0.5	—	—	—	—
	15-Jun-09	ND < 50	ND < 0.5	ND < 0.5	ND < 0.5	ND < 1	ND < 0.5	ND < 1	ND < 0.5	ND < 0.5	ND < 5
	15-Oct-09	ND < 50	ND < 0.5	ND < 0.5	0.76	ND < 1	ND < 0.5	ND < 1	ND < 0.5	ND < 0.5	ND < 5
	04-Mar-10	63	ND < 0.5	ND < 0.5	1.7	ND < 1	ND < 0.5	—	—	—	—
	16-Aug-10	53	ND < 0.5	ND < 0.5	1.4	ND < 1	ND < 0.5	—	—	—	—
KHAN 21943 Victory Drive	15-Jun-09	ND < 50	ND < 0.5	ND < 0.5	ND < 0.5	ND < 1	28	ND < 1	ND < 0.5	ND < 0.5	ND < 5
	19-Oct-09	ND < 50	ND < 0.5	ND < 0.5	ND < 0.5	ND < 1	29	ND < 1	ND < 0.5	ND < 0.5	ND < 5
	04-Mar-10	52	ND < 0.5	ND < 0.5	ND < 0.5	ND < 1	53	—	—	—	—
	16-Aug-10	ND < 50	ND < 0.5	ND < 0.5	ND < 0.5	ND < 1	68	—	—	—	—

ND = not detected

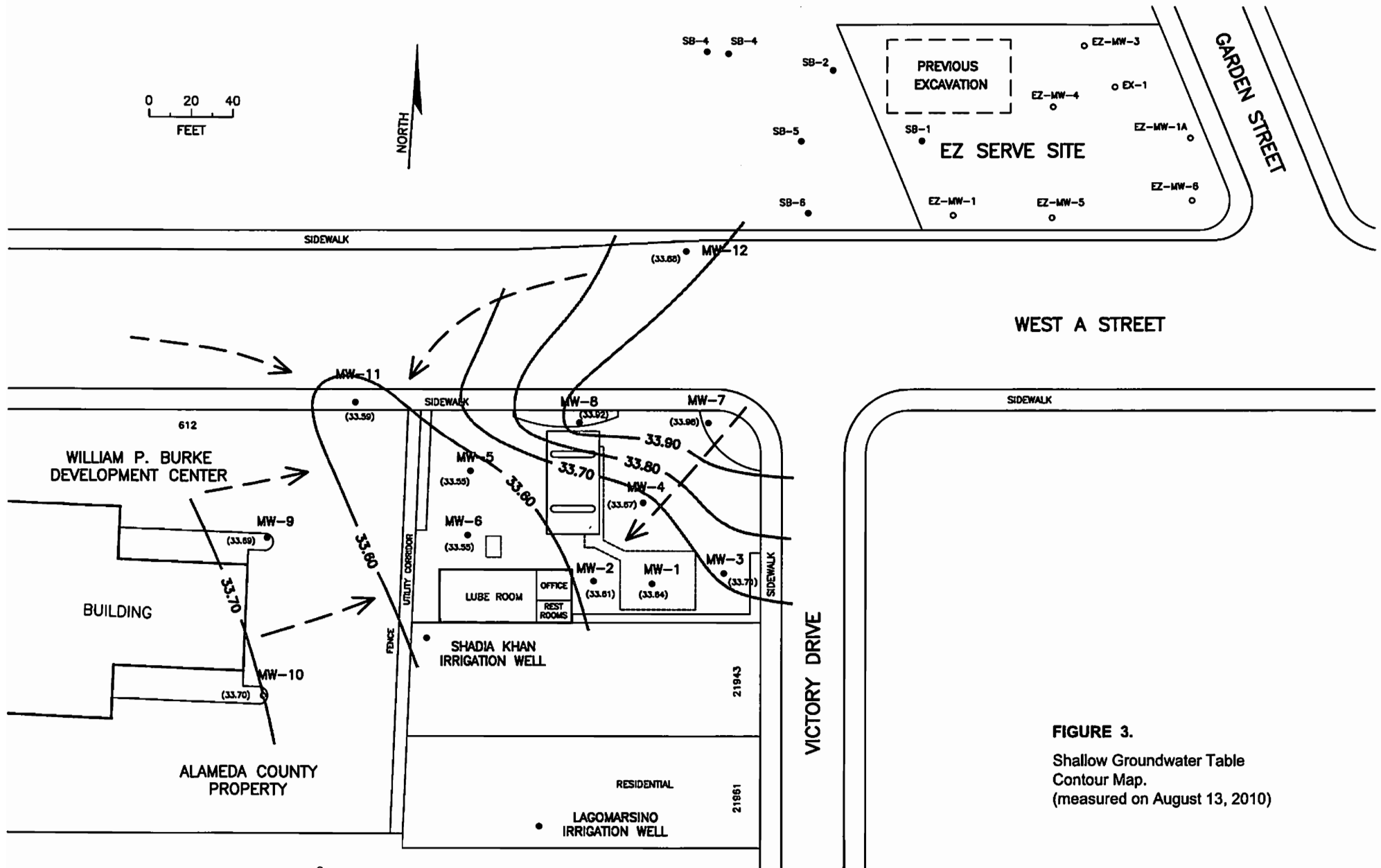

FIGURE 3.
 Shallow Groundwater Table
 Contour Map.
 (measured on August 13, 2010)

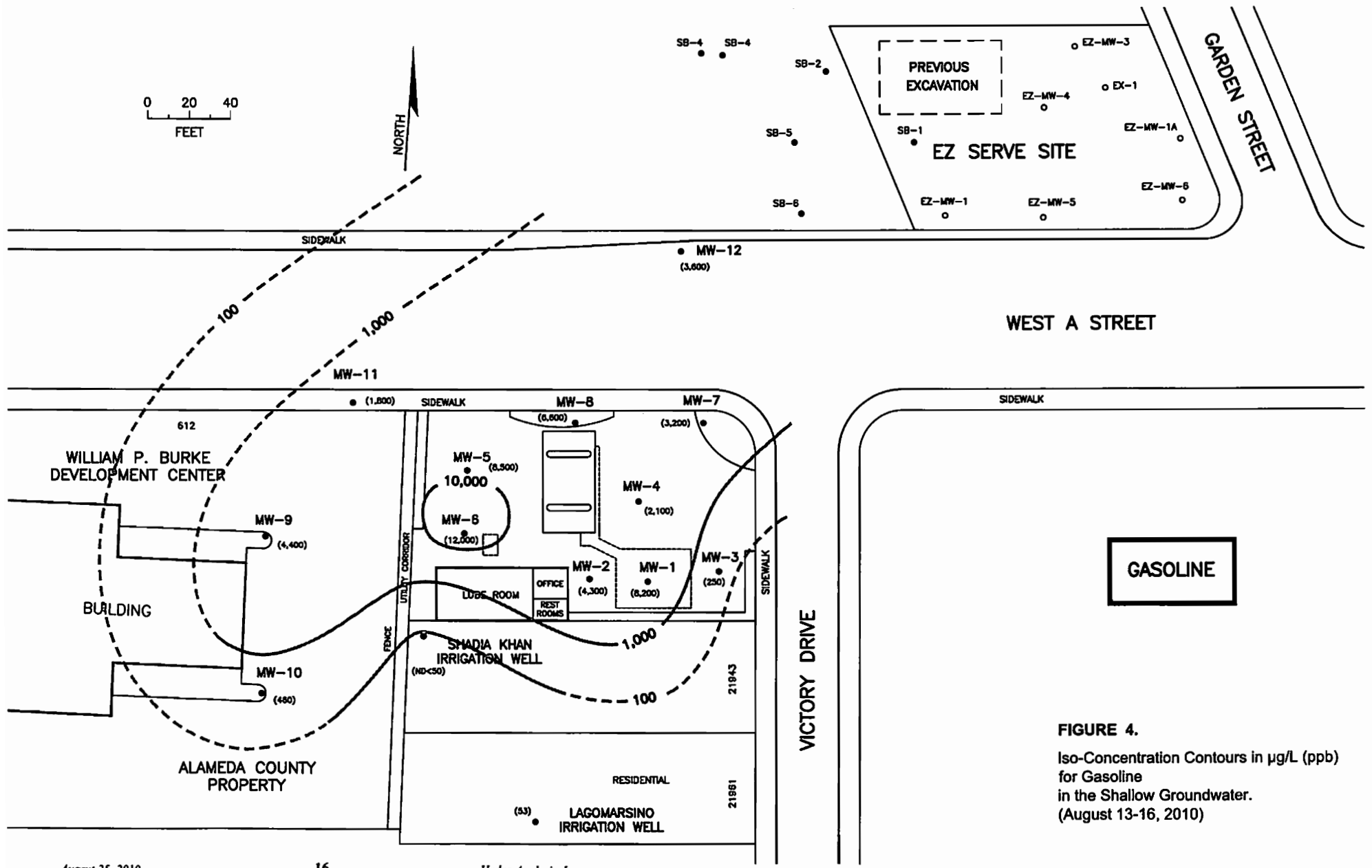

FIGURE 4.
 Iso-Concentration Contours in µg/L (ppb)
 for Gasoline
 in the Shallow Groundwater.
 (August 13-16, 2010)

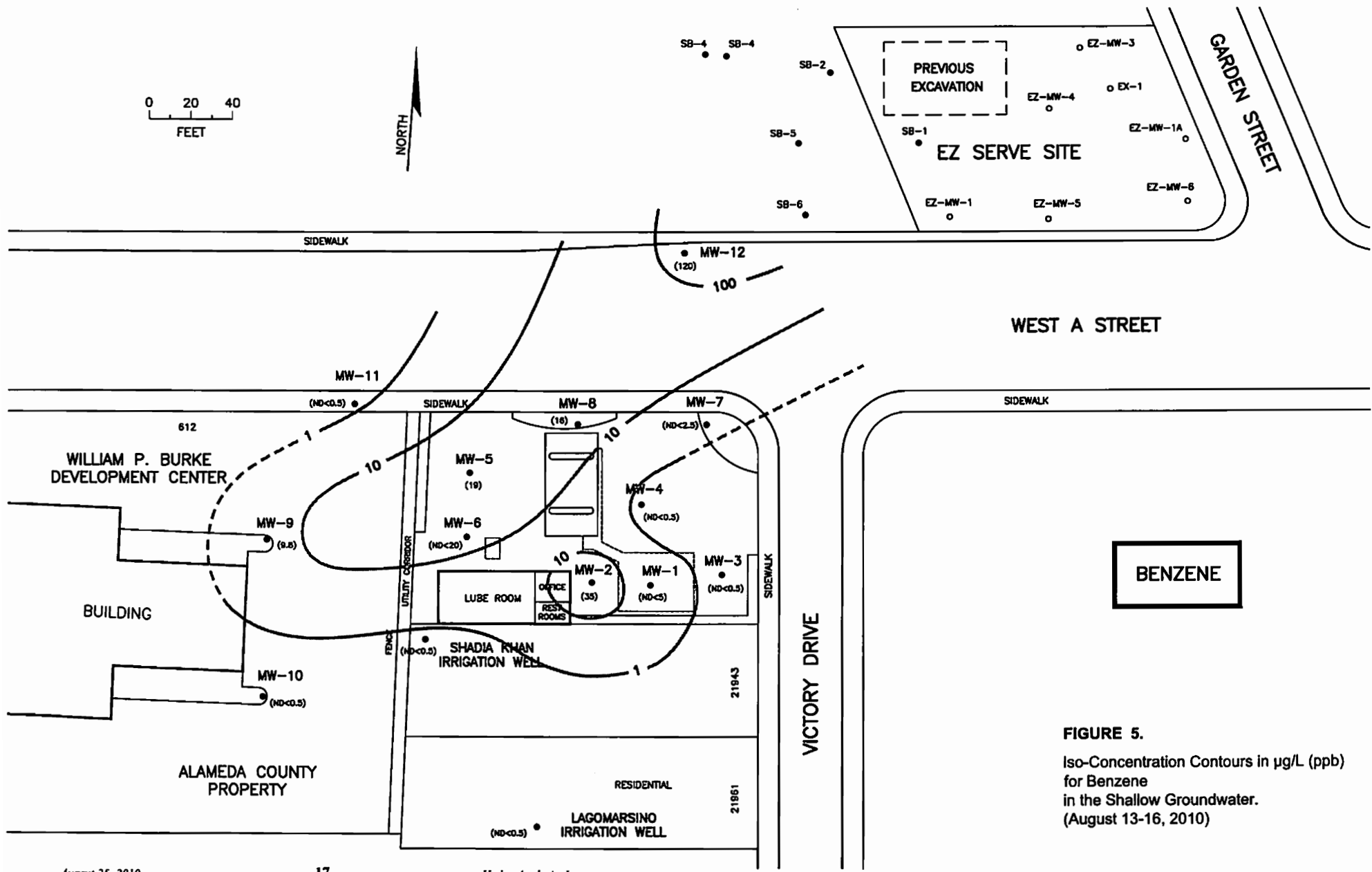

FIGURE 5.

Iso-Concentration Contours in $\mu\text{g/L}$ (ppb) for Benzene in the Shallow Groundwater. (August 13-16, 2010)

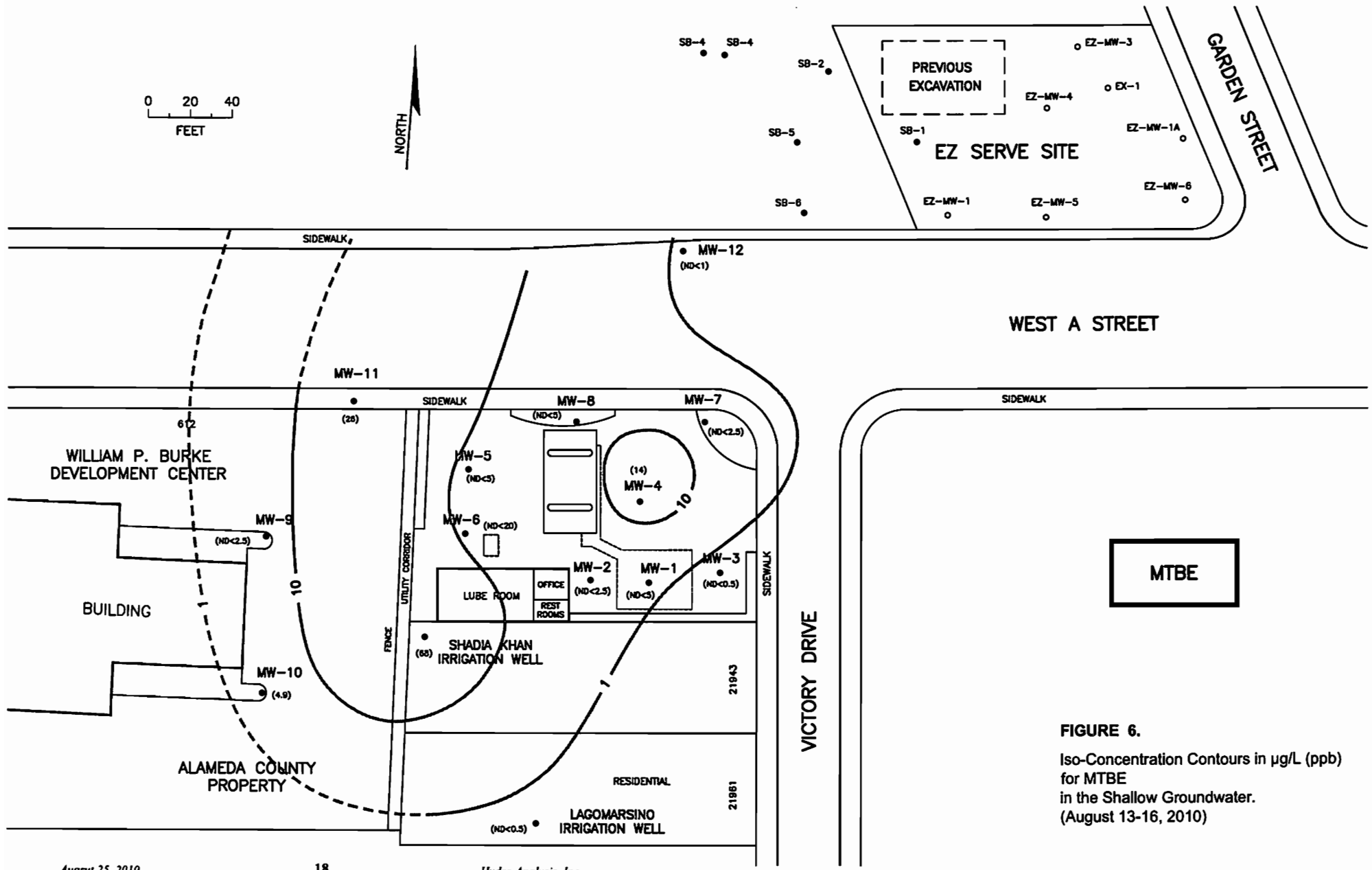
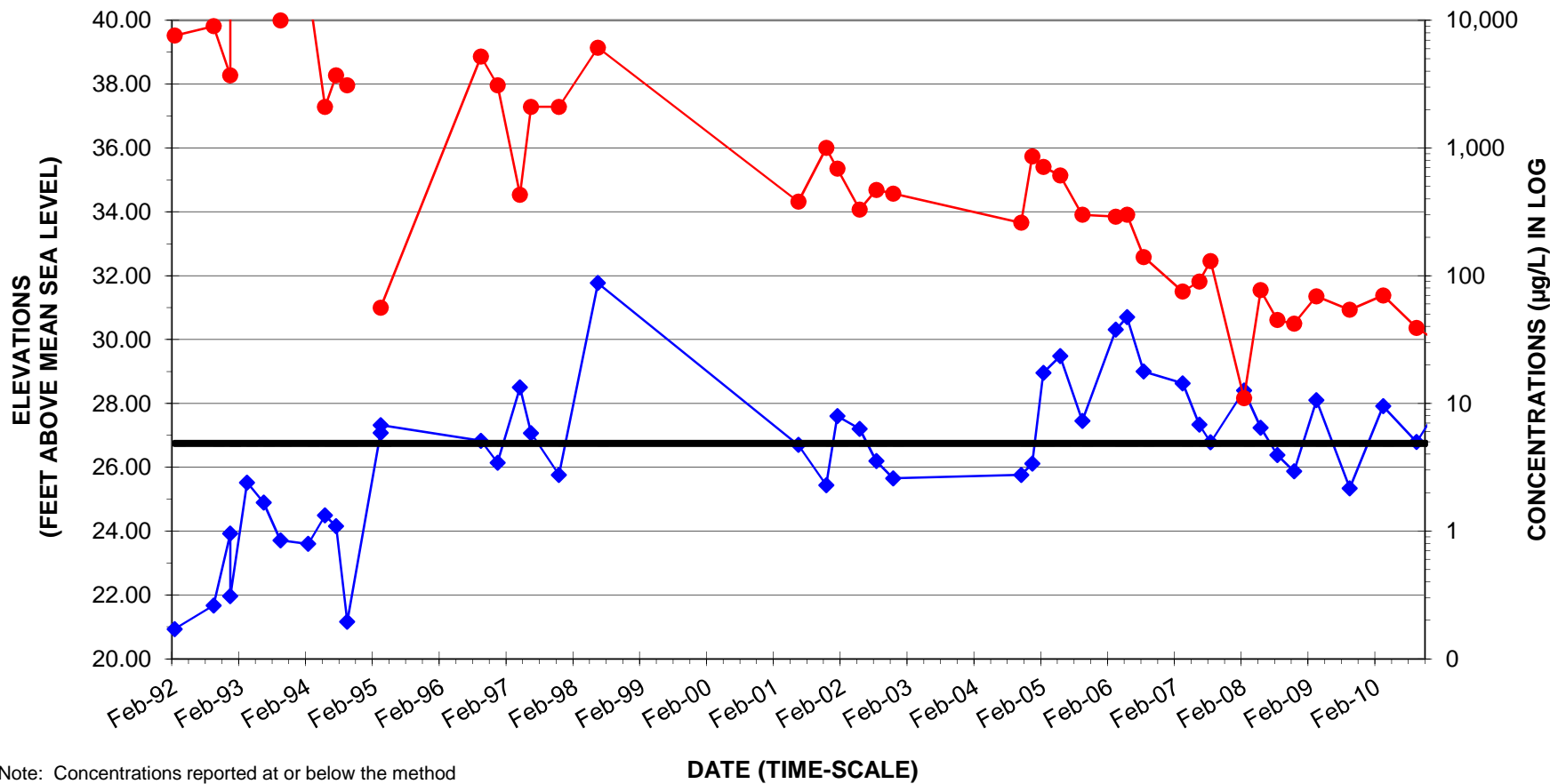

FIGURE 6.
 Iso-Concentration Contours in $\mu\text{g/L}$ (ppb)
 for MTBE
 in the Shallow Groundwater.
 (August 13-16, 2010)

APPENDIX F
HYDROGRAPHS OF GROUNDWATER DATA

**GROUNDWATER HYDROGRAPH FOR MW-1
Former RPMS (E-Z Serve) Location 100877
525 W. A Street, Hayward, California**

◆ GW Elevation
 — Top of Screen Elevation
 ● Benzene Concentration



Note: Concentrations reported at or below the method detection limit are plotted at the laboratory reporting limit.

**GROUNDWATER HYDROGRAPH FOR MW-4
Former RPMS (E-Z Serve) Location 100877
525 West A Street, Hayward, California**

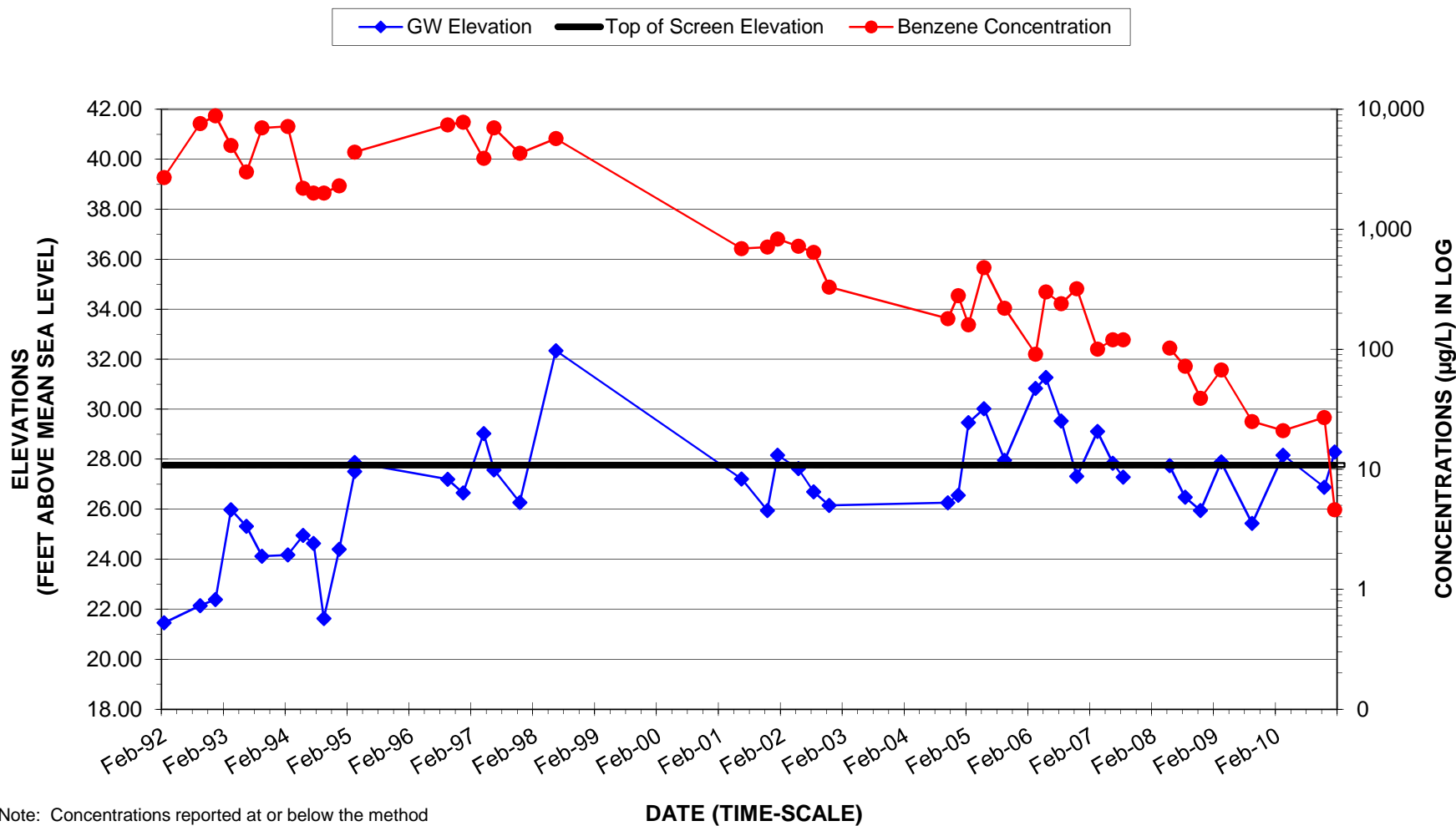

Note: Concentrations reported at or below the method detection limit are plotted at the laboratory reporting limit.

**GROUNDWATER HYDROGRAPH FOR MW-5
Former RPMS (E-Z Serve) Location 100877
525 West A Street, Hayward, California**

◆ GW Elevation
 — Top of Screen Elevation
 ● Benzene Concentration

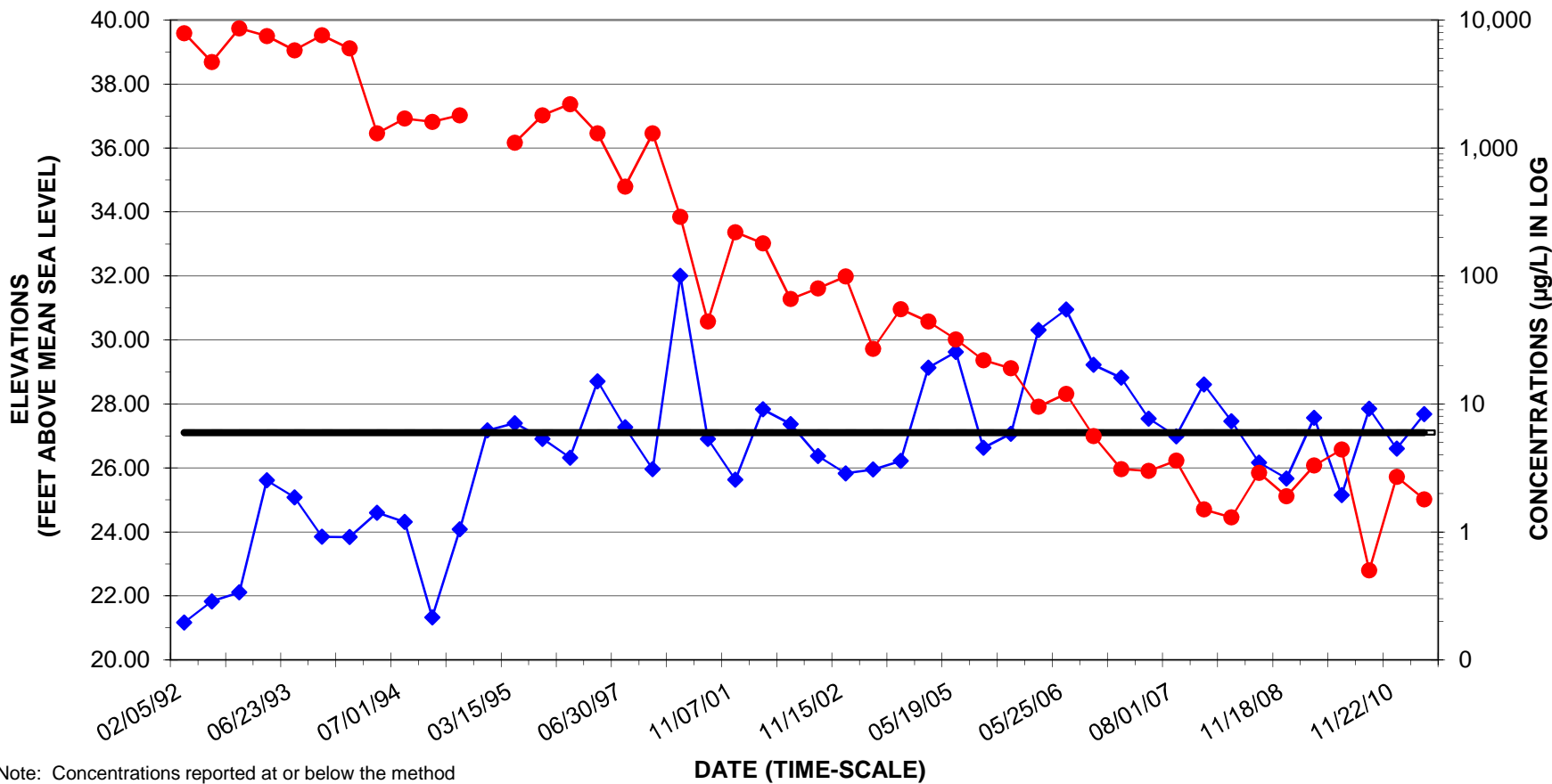

Note: Concentrations reported at or below the method detection limit are plotted at the laboratory reporting limit.

APPENDIX G
GEOTRACKER DATA SUBMITTAL RECEIPT

STATE WATER RESOURCES CONTROL BOARD
GEOTRACKER ESI

UPLOADING A GEO_REPORT FILE

SUCCESS

Your GEO_REPORT file has been successfully submitted!

<u>Submittal Type:</u>	GEO_REPORT
<u>Report Title:</u>	Revised Site Conceptual Model and Preferential Pathway Study, February 28, 2011
<u>Report Type:</u>	Sensitive Receptor Survey Report
<u>Report Date:</u>	2/28/2011
<u>Facility Global ID:</u>	T0600100483
<u>Facility Name:</u>	EZ SERVE #100877
<u>File Name:</u>	RO#0000023 Revised Site Conceptual Model and Preferential Pathway Study 02-28-2011.pdf
<u>Organization Name:</u>	Schaaf
<u>Username:</u>	SCHAAF
<u>IP Address:</u>	75.22.88.211
<u>Submittal Date/Time:</u>	5/8/2011 7:44:11 PM
<u>Confirmation Number:</u>	6723954200

Copyright © 2008 State of California