

WORK PLAN  
FOR  
SUPPLEMENTAL SITE INVESTIGATION

Port of Oakland - Building C-401  
2277 Seventh Street  
Oakland, California

Project No. 10-270-01-001

Prepared for:

Port of Oakland  
530 Water Street  
Oakland, California

Prepared by:

Alisto Engineering Group  
1777 Oakland Boulevard, Suite 200  
Walnut Creek, California

94598

295-1650

March 30, 1995

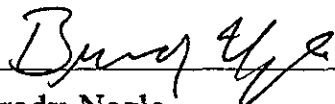
  
\_\_\_\_\_  
Brady Nagle  
Project Manager

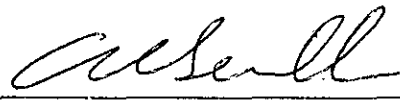
  
\_\_\_\_\_  
Al Sevilla, P.E.  
Principal



**WORK PLAN  
FOR  
SUPPLEMENTAL SITE INVESTIGATION**

**Port of Oakland - Building C-401  
2277 Seventh Street  
Oakland, California**

**Proposal No. 10-270-01-01**

**March 30, 1995**

**INTRODUCTION**

This work plan presents the proposed scope of work for conducting a supplemental site investigation at the Port of Oakland, Building C-401, 2277 Seventh Street, Oakland, California, is based on currently available reports and information. Field activities will be conducted in accordance with applicable requirements and guidelines of the Alameda County Health Care Services Agency and the California Regional Water Quality Control Board, San Francisco Bay Region.

**SITE DESCRIPTION AND BACKGROUND**

The Port of Oakland property, which includes Building C-401 at 2277 Seventh Street, Oakland, California, is leased to SeaLand Services, Inc. Adjacent and east of the SeaLand lease is 2225 7th Street, which is owned by the Port of Oakland and leased by Dongary Investments, who in turn subleases to NW Transport Services and SeaLand Services. A site vicinity map is shown in Figure 1, and a brief description of background information for the properties is presented below.

SeaLand Lease

In September 1993, four underground storage tanks immediately to the south of Building C-401 were removed from the site. Two 10,000-gallon tanks (CF-17 and CF-18) were used to store gasoline; one 500 gallon tank for storage of waste oil; and one 300-gallon tank was apparently used to store used diesel and oil. During removal, the tanks were visually inspected and no holes were observed.

Analysis of soil samples collected during tank removal activities detected up to 1,700 milligrams per kilogram (mg/kg) total petroleum hydrocarbons as gasoline (TPH-G) and 5,500 mg/kg total petroleum hydrocarbons as diesel (TPH-D). Benzene, toluene, ethylbenzene, and total xylenes (BTEX) were detected in the soil samples, with benzene concentrations of up to 6.7 mg/kg. Total petroleum hydrocarbons as motor oil and total oil and grease were not detected above reported detection limits in the soil samples. Analysis of soil samples collected at the limits of overexcavation detected up to 1,600 mg/kg TPH-G, 6,700 mg/kg TPH-D, and 5.7 mg/kg benzene. Analysis of grab groundwater samples collected from the tank cavities detected up to 180 mg/kg benzene (Uribe, 1994a).

E:\01-10-270\SS1.WP

1

→ "residual concs."

In May 1994, six soil borings, SB-1 through SB-6, were drilled and soil samples were collected at the site. Three additional soil borings were drilled and converted into groundwater monitoring wells, MW-1 through MW-3. Analysis of groundwater samples collected from the soil borings and monitoring wells detected TPH-D in each sample. Separate-phase product was observed in Monitoring wells MW-1 and MW-3 at thicknesses of up to 6.88 feet. TPH-G was not detected in any of the groundwater samples analyzed (Uribe, 1994b).

#### Dongary Investments Lease: SeaLand and NW Transport Subleases

In 1989, one of seven 20,000-gallon underground diesel fuel storage tanks at the former ANR Freight sublease (currently the NW Transport sublease) failed a leak detection test. After collecting and analyzing soil and grab groundwater samples collected around the tanks, the tank which failed leak testing was removed from the site in March 1990. Petroleum hydrocarbon were detected in soil samples collected below the tank location.

In July 1992, one bulk oil and the six remaining diesel fuel storage tanks were removed from the property subleased by ANR Freight. The diesel storage tanks were observed to have no holes, but one hole was observed in the bulk oil tank. Concentrations of TPH-D detected in the 16 soil samples collected from the main excavation averaged 28,000 mg/kg (Ramcon, 1993).

In August 1992, a 2,000-gallon waste oil tank was removed from the SeaLand sublease, and no holes were observed in the tank. Soil samples from the waste oil tank pit contained detectable concentrations of benzene, TPH-D, total petroleum hydrocarbons as motor oil (TPH-MO), halogenated volatile organic compounds, and semi-volatile organic compounds (Ramcon, 1993).

December 1992, Soil Borings BH-1 through BH-16 were drilled and Borings BH-15, BH-16, and BH-13 were converted into Monitoring Wells MW-1, MW-2, and MW-3. Analysis of soil samples collected from the borings detected TPH-D at concentrations ranging from 42 to 7400 parts per million (ppm) in 6 soil samples, and TPH-MO at concentrations ranging from 16 to 77 ppm in 4 soil samples. TPH-G and BTEX constituents were not detected above the reported detection limits. Analysis of groundwater samples collected from Monitoring Wells MW-1 through MW-3 did not detect TPH-D, TPH-MO, or BTEX above the reported detection limits. However, analysis of the groundwater sample collected from MW-1 detected several volatile organic compounds (Ramcon, 1993).

#### **SCOPE OF WORK**

The supplemental site investigation includes tasks to: 1) assess the nature and downgradient extent of petroleum hydrocarbons in the subsurface soil and groundwater; 2) determine the hydrogeologic characteristics of the site; and 3) investigate the source of product observed in Monitoring Wells MW-1 and MW-3.

Task 1: Conduct Pre-Drilling Activities

The necessary well installation permits will be obtained and subsurface interferences will be located in the proposed boring locations prior to drilling.

Task 2: Drill Soil Borings and Install Temporary Wells

Approximately 10 soil borings will be drilled at the site to approximately 13 feet below grade by direct-pushing a 2-1/2-inch-diameter core barrel to the desired depth, removing a center plug, and inserting a 1-1/2-inch-diameter split-spoon sampler lined with stainless steel tubes. During drilling, soil samples will be collected from the borings at depths of 3, 5, and 10 feet, and at the termination of the borings at approximately 13 feet below grade, or at depths of significant changes in stratigraphy. The samples will be collected from a split-spoon sampler lined with stainless steel tubes and logged by a geologist using the Unified Soil Classification System. Each sample will be field screened using a photo-ionization detector (PID) to assist in selecting samples for laboratory analysis. Selected samples will be sealed airtight with Teflon sheeting, plastic endcaps, and adhesive tape.



Soil samples for chemical analysis will be selected based on the following criteria: the soil sample collected at the capillary fringe and the soil sample which has the highest head space reading using the PID. Only the capillary fringe sample will be analyzed if that sample has the highest PID reading or if no PID readings are recorded from any of the soil samples collected from that boring. Samples selected for analysis will be labelled for identification and placed immediately into an iced cooler for transportation to the laboratory.

Groundwater samples will be collected from the temporary wells by inserting 1-1/4-inch-diameter PVC well casing with 0.010-inch perforations from the bottom of the boring to a depth interval above the highest anticipated water level, and solid casing from the top of the slotted casing. The casings, fittings, screens, and other components of the temporary well construction will be steam cleaned before installation.

Groundwater in each temporary well will be monitored for separate phase product or sheen. Unless separate phase product is observed, the temporary wells will be sampled using a disposable bailer, and groundwater samples will be transferred into laboratory-supplied containers. The temporary well will be left in place until the full volume of sample necessary has been obtained. The samples will be labeled with the temporary well number, site identification, date and time of collection, and sampler's initials, and transported in an iced cooler to a state-certified laboratory following preservation and chain of custody protocol.

After sampling, the temporary wells will be destroyed by removing the PVC casing and backfilling the borehole to grade with neat cement. Temporary wells/borings will be destroyed at the end of each working day, and not left open over night.

County?

Task 3: Install Groundwater Monitoring Wells

Up to six groundwater monitoring wells will be installed at the site. The location and number of proposed monitoring wells will be determined after receipt of the analytical data from the temporary wells, and presented to the appropriate parties on a site plan for approval before commencing well construction activities.

you bet!

The proposed monitoring wells will be installed and constructed based on site-specific hydrogeologic conditions and the nature of contamination encountered, if any. The soil borings for well construction will be drilled using a drilling rig equipped with 8-inch-diameter, continuous-flight, hollow-stem augers. The wells will be completed to depths of approximately 10 feet below the top of the first saturated zone encountered to a total depth of approximately 20 feet using 2-inch diameter, Schedule 40, PVC pipe, with 0.010-inch perforations, and the required filter pack. A bentonite spacer will be installed above the sand pack, and the remainder of the annulus will be sealed with Portland Type I/II neat cement. The top of each well will be secured with a watertight locking cap and utility box finished flush with the ground surface.

Task 4: Develop, Sample, and Survey Wells

The wells will be developed to: (1) consolidate and stabilize the filter pack; (2) optimize well production; and (3) reduce the turbidity of subsequent groundwater samples. The wells will be developed during drilling and before installation of the bentonite spacer and neat cement seal. Development will be accomplished by purging a maximum of 10 saturated well volumes or until the groundwater is relatively free of sediment.

Sampling of the proposed new groundwater monitoring wells will be performed a minimum of 72 hours after development. Before sampling of the proposed and existing monitoring wells, the water level will be measured and the wells will be inspected for free product or sheen. The wells will then be purged to allow groundwater representative of the aquifer to enter. Purging will be accomplished using a bailer or pump so as not to agitate the groundwater or expose it to air. Purging will continue until a minimum of 3 and a maximum of 10 saturated well casing volumes have been evacuated and indicator parameters have stabilized. Indicator parameters will be pH, temperature, and specific conductivity. Stabilization of the parameters will be determined when they vary no more than the following values:

- pH - 0.2 units
- Temperature - 0.5 degrees Celsius
- Specific conductivity - 10 percent

The samples collected from the wells will be placed in an iced cooler and transported to a state-certified laboratory for analysis. Purged water from

sampling and development, as well as decontamination rinsate, will be stored onsite in labeled Department of Transportation approved 55-gallon drums for transport and disposal.

To obtain data for the calculation of hydraulic gradient and groundwater flow direction of the shallow aquifer, the new monitoring well will be surveyed from the top of casing to within 0.01 foot accuracy in reference to an established benchmark or a common datum.

Task 5: Analyze Soil and Groundwater Samples

Soil and groundwater samples will be submitted to Clayton Environmental Consultants, Inc., Pleasanton, California, (State Certification No. 1196) for laboratory analysis. The samples will be analyzed on a standard 2 week turnaround. The soil and groundwater samples will be analyzed for the following:

- Total petroleum hydrocarbons as gasoline (TPH-G) using EPA Method 8015
- Benzene, toluene, ethylbenzene, total xylenes (BTEX) using EPA Method 8020
- Total petroleum hydrocarbons as diesel using EPA Method 8015

Task 6: Evaluate Data and Prepare Report

Following completion of sample analysis, a detailed evaluation of results and available information will be conducted to assess the nature and extent of hydrocarbons in the soil and groundwater. Alisto will include the results of quarterly groundwater sampling, which will be conducted following installation of the new wells. A report will be prepared presenting the results of the above tasks to include the following:

- A summary of field and analytical data.
- Groundwater gradient and hydrocarbon concentration maps, including data from coordinated groundwater sampling of the Port of Oakland and Dongary properties:
- Interpretation of site geologic and hydrogeologic conditions with cross-sections using borings and wells from both sites.
- Summary of findings and conclusions.

## SITE SAFETY PLAN

Field procedures and activities related to the site investigation will be conducted in accordance with a site-specific safety plan. The site safety plan will be prepared in accordance with applicable requirements of the California EPA, the federal and state Occupational Safety and Health Administration, and the Port of Oakland.

## IMPLEMENTATION SCHEDULE

The proposed additional site characterization will be completed and a report submitted within 90 days after approval of this work plan by the regulatory agencies.

Following is the estimated schedule:

<u>Task or Activity</u>	<u>Days After Work Plan Approval</u>
Conduct pre-drilling activities	15
Drill soil borings and install temporary wells	25
Install groundwater monitoring wells	45
Develop, sample, and survey wells	60
Analyze soil and groundwater samples	75
Evaluate data and prepare report	90

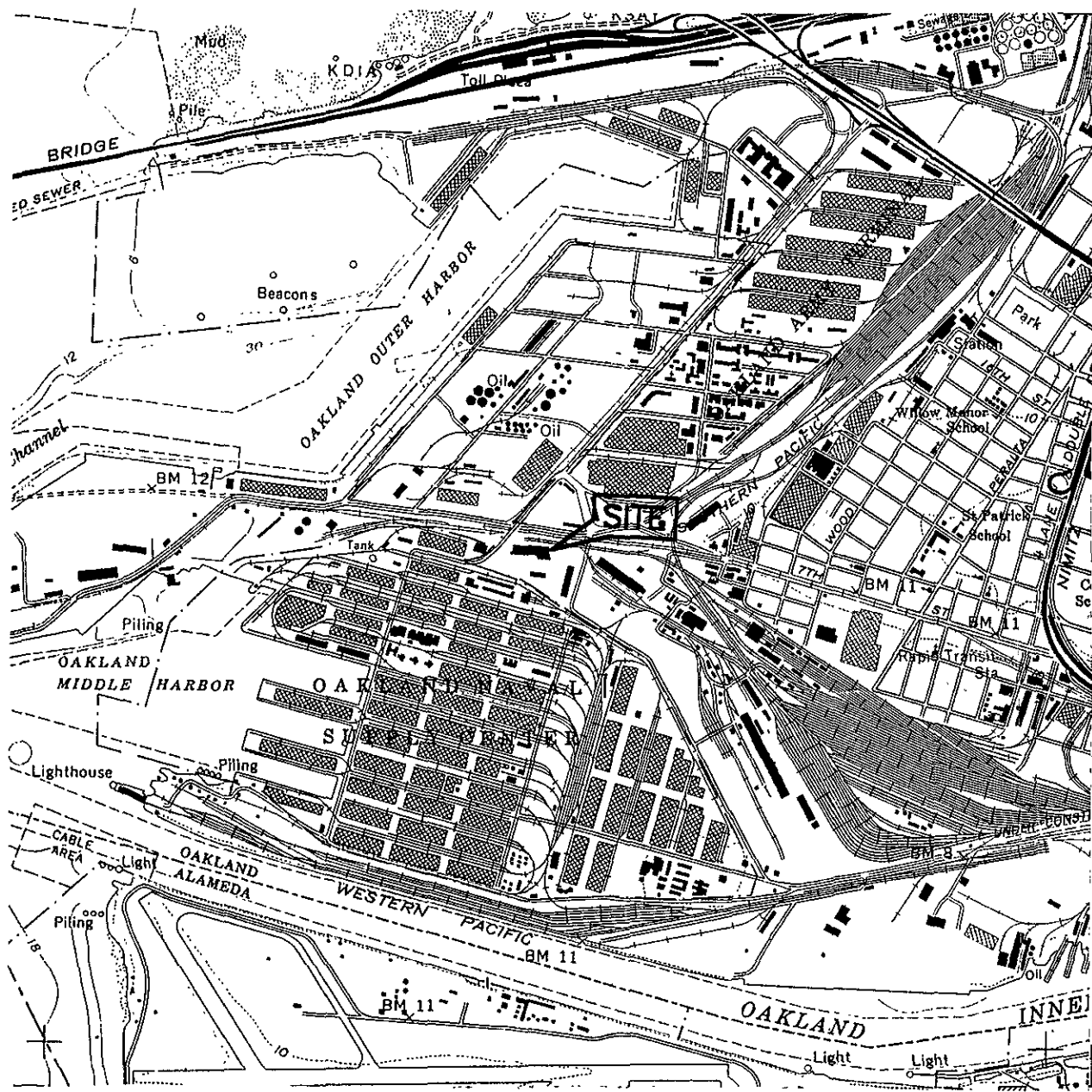

SOURCE:  
 USGS MAP, OAKLAND WEST QUADRANGLE,  
 7.5 MINUTE SERIES, 1959,  
 PHOTOREVISED 1980.

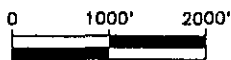

**FIGURE 1**  
**SITE VICINITY MAP**

PORT OF OAKLAND  
 BUILDING C-401  
 2277 SEVENTH STREET  
 OAKLAND, CALIFORNIA

PROPOSAL NO. 10-95-025



**ALISTO ENGINEERING GROUP**  
 WALNUT CREEK, CALIFORNIA



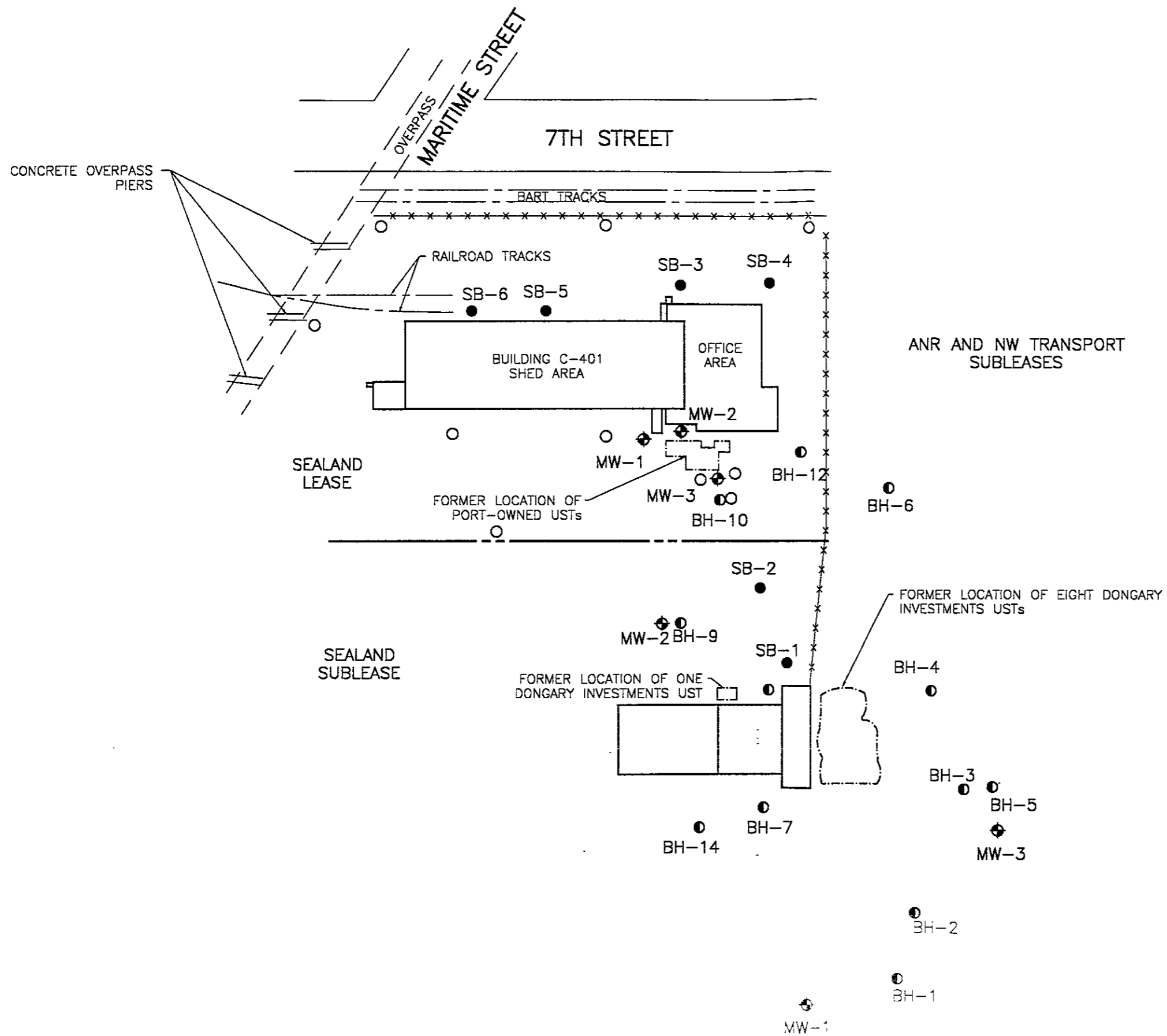

**LEGEND**

- ⊕ EXISTING PORT OF OAKLAND GROUNDWATER MONITORING WELL
- ⊕ EXISTING DONGARY GROUNDWATER MONITORING WELL
- EXISTING PORT OF OAKLAND SOIL BORING LOCATION
- ⊙ EXISTING DONGARY SOIL BORING LOCATION
- PROPOSED SOIL BORING

**FIGURE 2**  
**PROPOSED SOIL BORING LOCATIONS**

PORT OF OAKLAND  
 BUILDING C-401  
 2277 SEVENTH STREET  
 OAKLAND, CALIFORNIA

PROJECT NO. 10-270

Port of Oakland-2277 Seventh St.  
**Bore Hole MW-3**

Date 5/16/94  
 Drilling Method HS Auger  
 Sampling Method 18" Split spoon  
 Surface Elevation 14.24  
 Recorded By JC Borrego  
 Registered Geologist \_\_\_\_\_

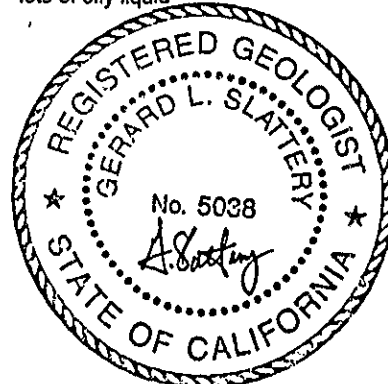
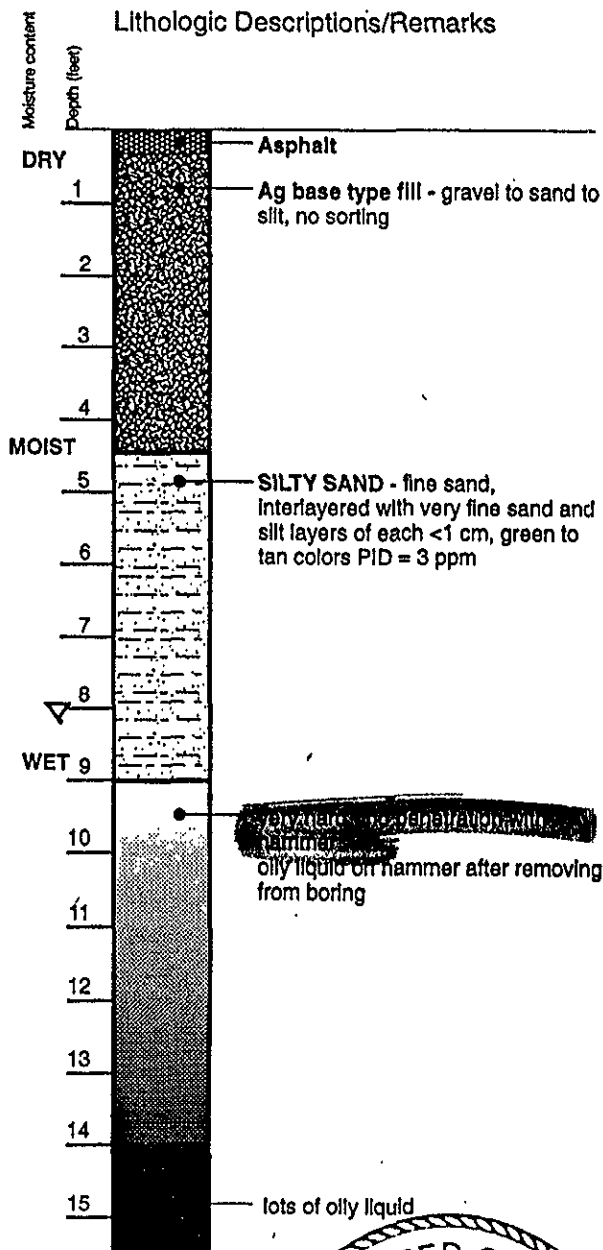
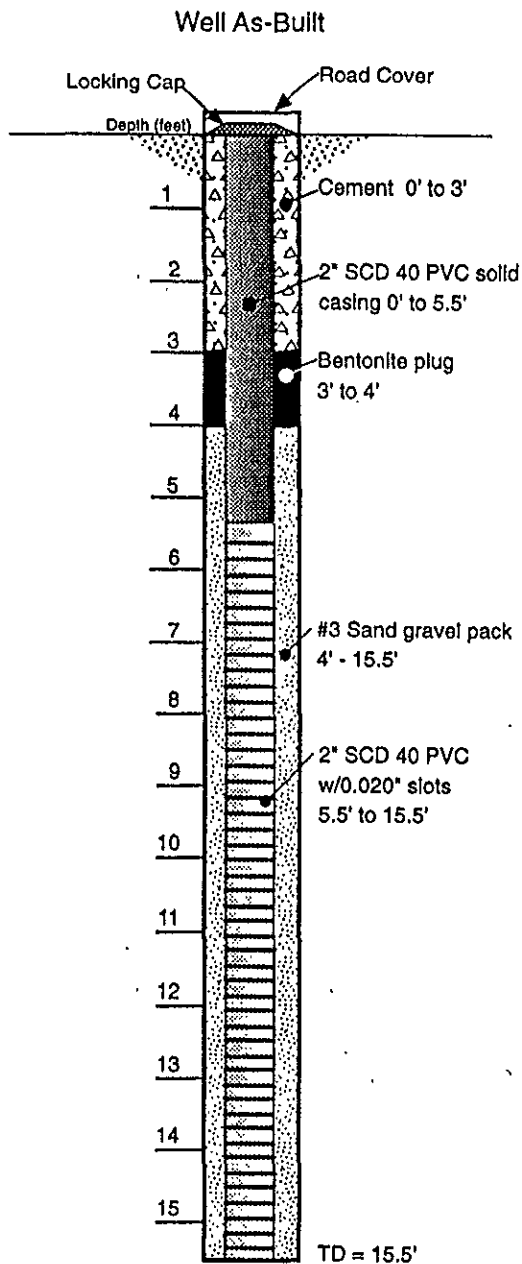

Urbe & Associates

Port of Oakland-2277 Seventh St.  
**Bore Hole MW-3**

Date 5/16/94  
 Drilling Method HS Auger  
 Sampling Method 18" Split spoon  
 Surface Elevation 14.24  
 Recorded By JC Borrego  
 Registered Geologist \_\_\_\_\_

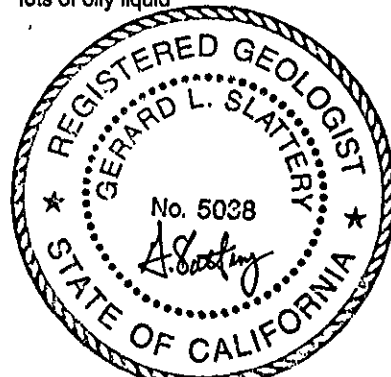
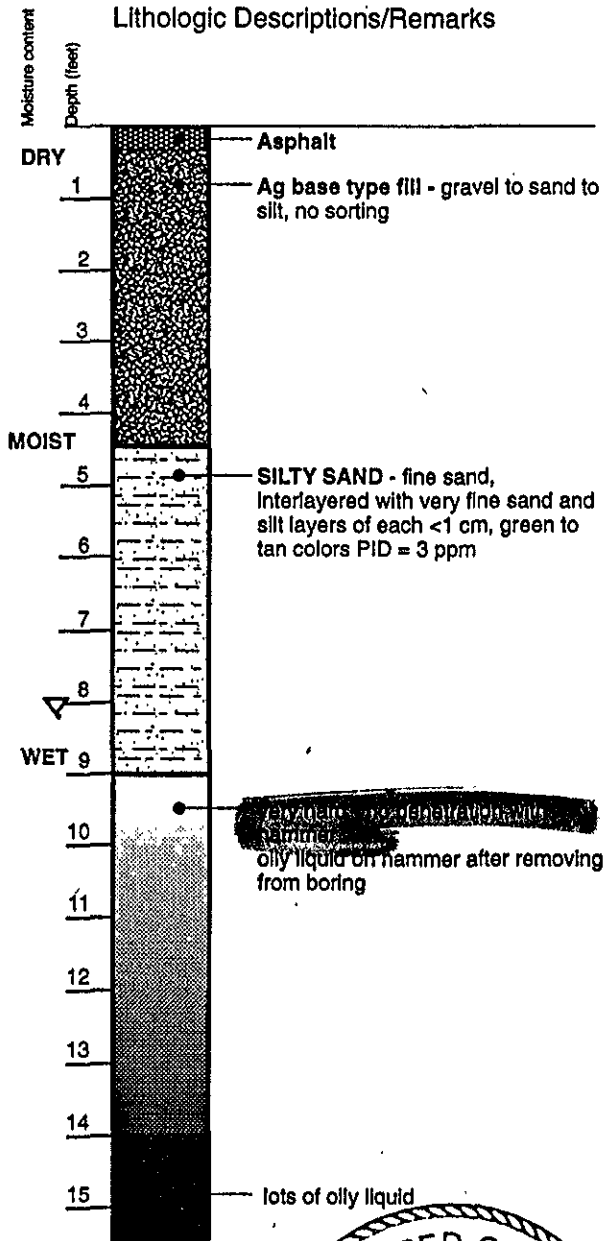
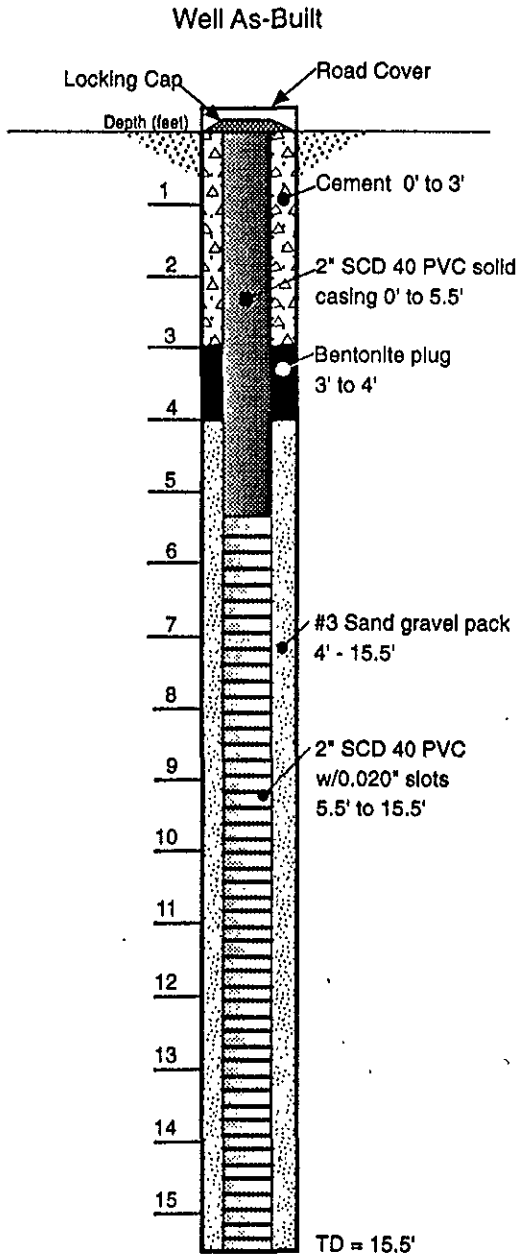

Uribe & Associates

ENVIRONMENTAL  
PROTECTION  
95 MAR -9 PM 1:29



# PORT OF OAKLAND

March 8, 1995

Jennifer Eberle  
Hazardous Materials Specialist  
Alameda County Health Care Services Agency  
1131 Harbor Bay Parkway, 2nd Floor  
Alameda, CA 94502

Dear Ms. Eberle:

**SUBJECT: DOCUMENTATION OF GROUNDWATER MONITORING AND FREE PRODUCT  
REMOVAL AT 2277 7TH ST (Port Contract # 93323)**

Per your request, enclosed are three tables summarizing results of the Port's groundwater monitoring and free product recovery at 2277 7th St through March 3, 1995.

If you have any questions, please feel free to contact me at 272-1220.

Sincerely,

Dan Schoenholz  
Associate Environmental Scientist

Enclosures

cc: Don Ringsby, Dongary Investments

ds\wp51\files\anr\shipper7.1tr

**Product Column Data for  
Groundwater Monitoring Wells at  
Port of Oakland Building C-401, 2277 Seventh Street, Oakland**

Date	Reference Elevation <sup>1</sup> (feet)	Well Depth (feet)	Initial Depth to Product <sup>2</sup> (feet)	Initial Depth to Groundwater <sup>2</sup> (feet)	Initial Thickness of Product in Well (feet)	Estimated Amount Recovered (gallons)	Final Depth to Product <sup>2</sup> (feet)	Final Depth to Groundwater <sup>2</sup> (feet)	Final Thickness of Product in Well (feet)
MW - 1	14.17	15.4							
6/30/94			9.20	9.75	0.55	1.5	NM	NM	NM
7/8/94			9.12	9.88	0.76	1.5	NM	NM	NM
7/14/94			9.12	9.90	0.78	1.5	NM	NM	NM
7/21-22/94			9.16	9.78	0.62	1.5	NM	NM	NM
7/29/94			9.13	10.00	0.87	3	NM	NM	NM
8/3/94			9.19	10.30	1.11	3	NM	NM	NM
8/11/94			9.24	10.51	1.27	3	NM	NM	NM
8/18/94			9.25	10.38	1.13	3	NM	NM	NM
9/29/94			9.30	10.50	1.20	3	11.05	11.1	0.05
10/4/94			9.30	9.75	0.45	1.5	9.45	9.5	0.05
10/14/94			9.25	10.05	0.80	1.5	9.4	9.45	0.05
10/21/94			9.49	10.84	1.35	NA	NM	NM	NM
11/2/94			9.44	10.26	0.82	2.5	NM	NM	NM
* 11/10/94			8.45	9.80	1.35	3	NA	NA	NA
11/18/94			8.78	9.76	0.98	3	NM	NM	NM
12/8/94			8.69	9.46	0.77	3	NM	NM	NM
1/20/95			7.73	8.01	0.28	2	NM	NM	NM
1/27/95			7.52	7.54	0.02	2	NM	NM	NM
2/10/95			7.92	8.15	0.23	2	NM	NM	NM
2/16/95			8.18	8.40	0.23	1	NM	NM	NM
2/23/95			8.21	8.46	0.25	2	NM	NM	NM
3/3/95			8.15	8.25	0.10	2	NM	NM	NM
<b>Total</b>						<b>46.5</b>			

MAR 06 '95 05:17PM URIBE & ASSOC

URIBE & ASSOC

MAR 06 '95 05:14PM

ENVIRONMENTAL PROTECTION  
95 MAR -9 PM 1:29

**Product Column Data for  
Groundwater Monitoring Wells at  
Port of Oakland Building C-401, 2277 Seventh Street, Oakland**

Date	Reference Elevation (feet)	Well Depth (feet)	Initial Depth to Product (feet)	Initial Depth to Groundwater (feet)	Initial Thickness of Product in Well (feet)	Estimated Amount Recovered (gallons)	Final Depth to Product (feet)	Final Depth to Groundwater (feet)	Final Thickness of Product in Well (feet)
MW - 2	14.38	15.18							
7/22/94			NA	9.58	NA	NA	NA	NA	NA
7/29/94			NA	9.51	NA	NA	NA	NA	NA
8/3/94			NA	9.59	NA	NA	NA	NA	NA
8/11/94			NA	9.67	NA	NA	NA	NA	NA
8/18/94			NA	9.63	NA	NA	NA	NA	NA
9/29/94			NA	9.75	NA	NA	NA	NA	NA
10/4/94			NA	9.6	NA	NA	NA	NA	NA
10/21/94			NA	9.94	NA	NA	NA	NA	NA
11/2/94			NA	9.8	NA	NA	NA	NA	NA
* 11/10/94			NA	9.8	NA	NA	NA	NA	NA
11/18/94			NA	8.92	NA	NA	NA	NA	NA
12/8/94			NA	8.98	NA	NA	NA	NA	NA
1/27/95			NA	8	NA	NA	NA	NA	NA
2/10/95			NA	8	NA	NA	NA	NA	NA
2/23/95			NA	8.21	NA	NA	NA	NA	NA

MAR 06 '95 05:17PM URIBE & ASSOC

URIBE & ASSOC

MAR 06 '95 05:15PM P.4

ENVIRONMENTAL PROTECTION  
95 MAR -9 PM 1:29

**Product Column Data for  
Groundwater Monitoring Wells at  
Port of Oakland Building C-401, 2277 Seventh Street, Oakland**

Date	Reference Elevation <sup>1</sup> (feet)	Well Depth (feet)	Initial Depth to Product <sup>2</sup> (feet)	Initial Depth to Groundwater <sup>2</sup> (feet)	Initial Thickness of Product in Well (feet)	Estimated Amount Recovered (gallons)	Final Depth to Product <sup>2</sup> (feet)	Final Depth to Groundwater <sup>2</sup> (feet)	Final Thickness of Product in Well (feet)
MW - 3	14.24	15.3							
6/30/94			8.83	14.97	6.14	45	NM	NM	NM
7/8/94			8.34	14.85	6.51	45	NM	NM	NM
7/14/94			8.35	14.41	6.06	45	NM	NM	NM
7/21-22/94			8.45	14.32	5.87	45	NM	NM	NM
7/29/94			8.9	14.45	5.55	18	NM	NM	NM
8/3/94			8.45	14.45	6.00	30	NM	NM	NM
8/11/94			9.52	14.45	4.93	30	NM	NM	NM
8/18/94			9.48	14.38	4.90	45	NM	NM	NM
9/23/94			8.75	14.45	5.70	100	8.8	12.9	4.10
9/29/94			8.85	14.45	5.60	165	9.5	12.45	2.95
10/4/94			8.65	14.5	5.85	165	9	12.3	3.30
10/14/94			9.6	14.5	4.90	165	9.1	10.5	1.40
10/21/94			8.88	14.5	5.62	90	9.02	12.67	3.65
11/2/94			8.79	14.5	5.71	50	9.05	13.25	4.20
* 11/10/94			8.07	13.12	5.05	NA	NA	NA	NA
11/18/94			7.91	13.1	5.19	90	NA	NA	NA
12/8/94			7.95	13.58	5.63	50	NA	NA	NA
1/20/95			7.09	10.11	3.02	40	NM	NM	NM
1/27/95			7.15	11.09	3.94	20	NM	NM	NM
* 2/10/95			7.05	11.05	4.00	0	NA	NA	NA
2/16/95			7.2	12.1	4.90	140	7.3	10.9	3.6
2/23/95			7.33	12	4.67	100	NM	NM	NM
3/3/95			7.4	12.25	4.85	150	7.55	10.7	3.15
<b>Total</b>						<b>1628</b>			

**Notes:**

NA = not applicable; NM = not measured

\* Product recovery not conducted on 11/10/94 and 2/10/95 due to failure in the pumping equipment.

1 Reference elevation is top of well casing and relative to Port of Oakland Datum (3.2 feet below MSL).

Reference elevations surveyed on June 8, 1994 by Greiner Associates.

2 Depths measured from top of well casing.

3 For MW - 1, the estimated amount recovered is approximately 75% product and 25% water

for MW - 3, the estimated amount recovered is approximately 100% product.

ENVIRONMENTAL PROTECTION  
95 MAR - 9



# PORT OF OAKLAND

ALCO  
HAZMAT  
95 FEB -2 PM 2:50

January 30, 1995

Jennifer Eberle  
Hazardous Materials Specialist  
Alameda County Health Care Services Agency  
1131 Harbor Bay Parkway, 2nd Floor  
Alameda, CA 94502

Dear Ms. Eberle:

**SUBJECT: DOCUMENTATION OF DISPOSAL OF FREE PRODUCT REMOVED AT 2277  
7TH ST (Port Contract # 93323)**

In your letter to me dated December 29, 1994, you requested records documenting the appropriate disposal of the product recovered from the site.

The first pickup occurred on October 13, 1994. Enclosed is a copy of a receipt provided by American Valley Environmental Services, Inc., to Decon Environmental Services, the Port's contractor. American Valley Environmental Services, Inc. then manifested the diesel as part of a consolidated shipment to PRC Patterson, Inc. A copy of manifest # 93031699 is enclosed.

A second pickup of product occurred on January 19, 1995. I will forward the appropriate documentation to you as soon as I have received it.

If you have any questions, please feel free to contact me at 272-1220.

Sincerely,

Dan Schoenholz  
Associate Environmental Scientist

Enclosures

cc: Don Ringsby, Dongary Investments



State of California—Environmental Protection Agency  
Form Approved OMB No. 2050-0039 (Expires 9-30-94)  
Please print or type. Form designed for use on offset (12-pitch) typewriter.

See Instructions on back of page 6.

Department of Toxic Substances Control  
Sacramento, California

IN CASE OF EMERGENCY OR SPILL, CALL THE NATIONAL RESPONSE CENTER 1-800-424-8802. WITHIN CALIFORNIA, CALL 1-800-852-7550

UNIFORM HAZARDOUS WASTE MANIFEST		1. Generator's US EPA ID No.	Manifest Document No.	2. Page 1	Information in the shaded area is not required by Federal law.	
2. Generator's Name and Mailing Address <b>AMERICAN VALLEY ENV. SVC. INC</b> <b>2930 BEER RD SUITE 156 TURLOCK, CA</b>		CA110001121115W 311699		1 of 1		
3. Generator's Phone (909) 732-4645		95382				
5. Transporter 1 Company Name <b>AMERICAN VALLEY ENVIRONMENTAL</b>		CA 0000121154				
9. Designated Facility Name and Site Address <b>PRC PATTERSON, INC.</b> <b>13331 N. HWY. 33</b> <b>PATTERSON, CA 95363</b>		CA 0003166720				
11. US DOT Description (including Proper Shipping Name, Hazard Class, and ID Number)		12. Containers		13. Total Quantity		14. UN#
a. <b>NON-RCRA HAZARDOUS WASTE LIQUID</b>		0 0 1 T 1		01550		
c.						
d.						
15. Special Handling Instructions and Additional Information <b>GLOVES</b> <b>IN CASE OF EMERGENCY CONTACT: BILL LEMOS @ 1-800-732-4645</b>						
16. GENERATOR'S CERTIFICATION: I hereby declare that the contents of the consignment are fully and accurately described above by proper shipping name and are classified, packed, marked, and labeled, and are in all respects in proper condition for transport by highway according to applicable federal, state and international laws.  If I am a large quantity generator, I certify that I have a program in place to reduce the volume and toxicity of waste generated to the degree I have determined to be economically practicable and that I have selected the practicable method of treatment, storage, or disposal currently available to me which minimizes the present and future threat to human health and the environment. OR, if I am a small quantity generator, I have made a good faith effort to minimize my waste generation and select the best waste management method that is available to me and that I can afford.						
Printed/Typed Name <b>Bill Lemos</b>		Signature <i>Bill Lemos</i>		Month Day Year <b>10 20 94</b>		
17. Transporter 1 Acknowledgment of Receipt of Materials Printed/Typed Name <b>BILL LEMOS</b>		Signature <i>Bill Lemos</i>		Month Day Year <b>10 20 94</b>		
18. Transporter 2 Acknowledgment of Receipt of Materials Printed/Typed Name		Signature		Month Day Year		
19. Discrepancy Indication Space						
20. Facility Owner or Operator Certification of receipt of hazardous materials covered by this manifest except as noted in item 17. Printed/Typed Name <b>Dev Arredondo</b>		Signature <i>Dev Arredondo</i>		Month Day Year <b>10 20 94</b>		

DO NOT WRITE BELOW THIS LINE.

**AMERICAN VALLEY  
ENVIRONMENTAL SERVICES, INC.**

2930 Geer Road Suite 156  
TURLOCK, CALIFORNIA 95382  
E.P.A. #CAL000121154  
1 800-732-4645

CUSTOMER'S ORDER NO. <b>1370</b>		PHONE <b>510 732-6444</b>		DATE <b>10-13-94</b>		
NAME <b>DECON ENVIRONMENTAL</b>						
ADDRESS <b>23490 CONNECTICUT AVE HAWAARD CA 94545</b>						
SOLD BY	CASH	C.O.D.	CHARGE	ON ACCT.	MOSE RET'D	PAID OUT
QTY.		DESCRIPTION			PRICE	AMOUNT
<b>385</b>		Waste Oil			<b>1<sup>10</sup></b>	<b>423.50</b>
		Waste Water & Oil				
		Waste Coolant & Oil				
		Rinsate				
		Time				
		Test/P.P.M.				
		Manifest # <b>93031699</b>				
		Ship To: Petroleum Recycling Corporation P.O. Box 1167 Paterson, California 95363 E.P.A. #CAD083166728			TAX	
RECEIVED BY <b>Gary by Bill</b>					TOTAL	<b>423.50</b>

**5590**

All claims and returned goods  
MUST be accompanied by this bill.

**Thank You**

Investments Site	
Figure 3: Map of Plume from ANR / Dongary	
SCALE: GRAPHIC Job No. 96-209	DRAWN BY: PO
DATE: 7-2-93	REVISED: A.W.
RAMCON	

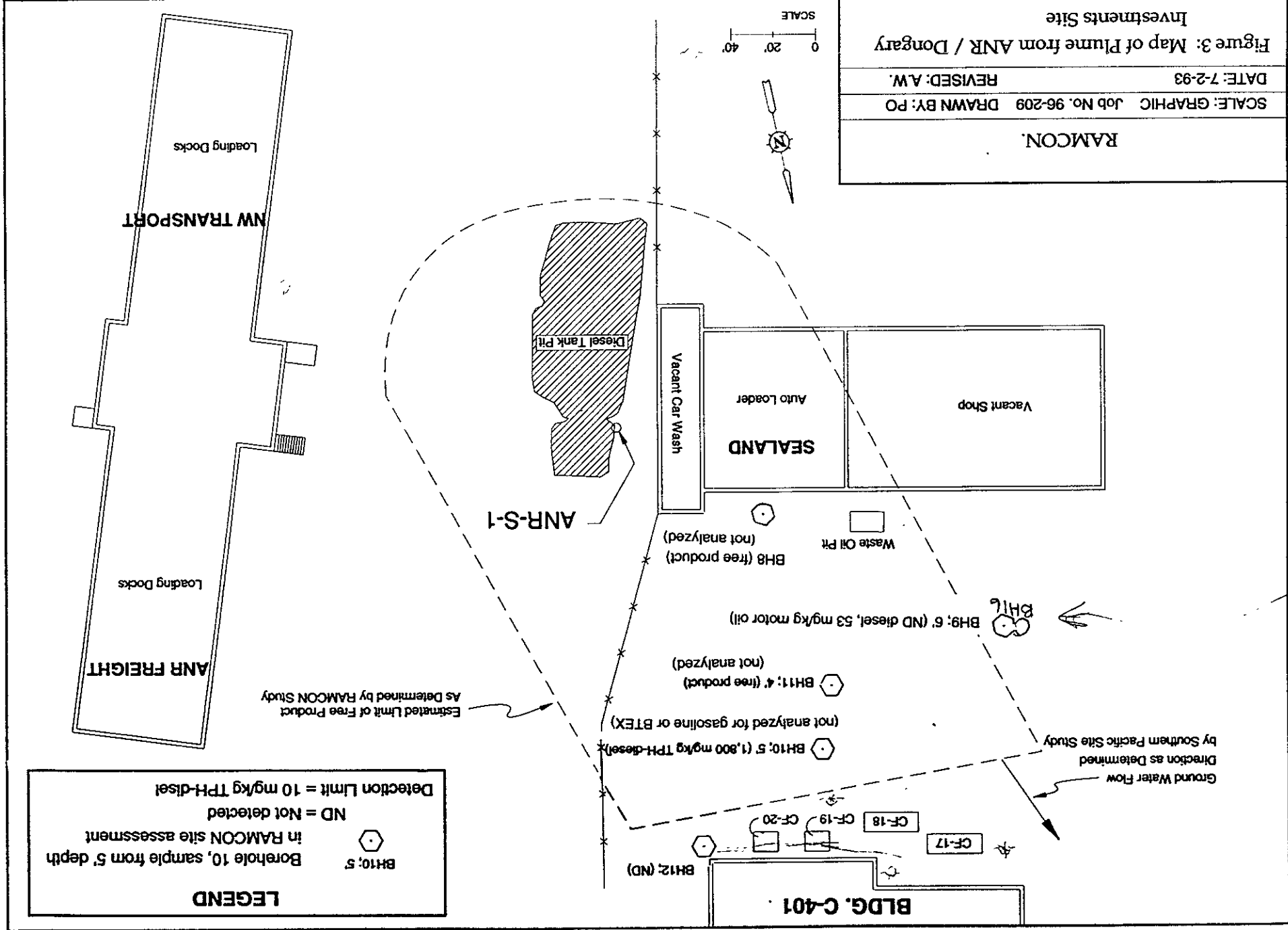

**LEGEND**

Borehole 10, sample from 5' depth  
 BH10: 5

ND = Not detected  
 Detection Limit = 10 mg/kg TPH-diesel

As Determined by RAMCON Study

? 9116

Leaking Underground Fuel Storage Tank Program

VII. ADDITIONAL COMMENTS (cont'd)

Groundwater was encountered at 28.38 feet bgs. Analytical results of the "grab" groundwater sample for TPHd, TPHg, BTEX, and O&G were nondetect.

Based on the log of the exploratory boring, the soil profile beneath the former tank complex consists of clays to the depth explored and no significant aquifer materials were observed.

+ Port claimed USTs were gasoline (also motor oil + waste oil).

+ Dongary's USTs were diesel (7) + 1 bulk oil + 1 waste oil.

<sup>never mind</sup> + got the "Wp for TK Activities at Shippers Dump," by Uribe, June 93 (Rep' contents of 3 <sup>Port</sup> USTs) ~~at~~.

+ FP in both pits.

+ gw flow dirk; fluctuates (S in 9-94, NW in 11-94, <sup>NW in 1-93</sup>)

+ Port collected soil sample fm Dongary's pit on 11-11-93: ND TPHd + 18 ppm TPHg.

+ Port did 2 SBs on Dongary sublease: at 5' bgs:  
SB1 + 2: ND TPHg, ND BTEX, 10 + 43 ppm TPHd.  
Grab water fm here got 210,000 ~~ppm~~ <sup>mg/L</sup> TPHd, ND TPHg,  
4,200 <sup>ppb</sup> benz (SB1), + 310 <sup>ppm</sup> TPHd, 23 <sup>ppm</sup> TPHg. + ND benz (SB2)  
(See 11-10-94 Uribe report).

+ 1-8-93 Ramcon (Taber) W-SW at .0014  
1-15-93

9-12-94 GTI - South

11-30-94 GTI + Uribe - NW

Dongary - more MWs + invest. Δ in lithology

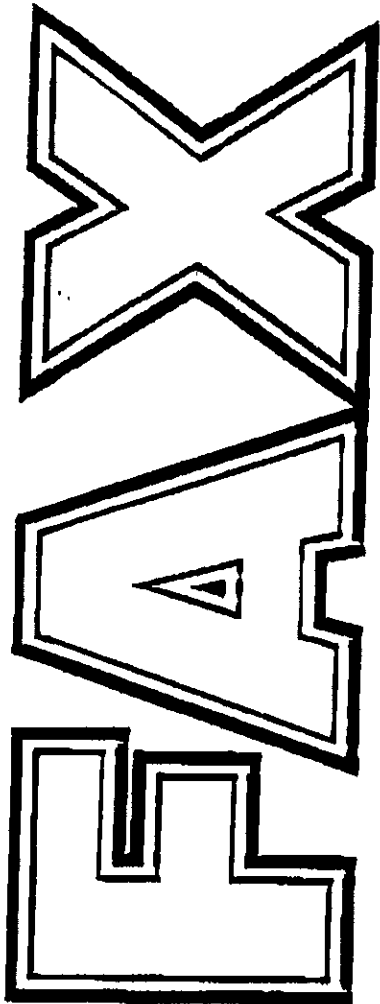

FACSIMILE TRANSMITTAL	
TO	Jennifer Eberle
ATTENTION	ACHCSA
FROM	Dan Schoenholz
DATE & TIME	1/11/95 10:30
FAX NUMBER	337-9335
NO. OF PAGES	2

- Per your request
- "Sealand Site" is the Shippers Imperial site (2277 7th St.)

PORT OF OAKLAND  
 ENVIRONMENTAL  
 DEPARTMENT  
 530 WATER STREET,  
 5TH FLOOR  
 OAKLAND, CA 94607  
 FAX (510) 465-3755  
 PHONE (510) 272-1174



**PORT OF OAKLAND**

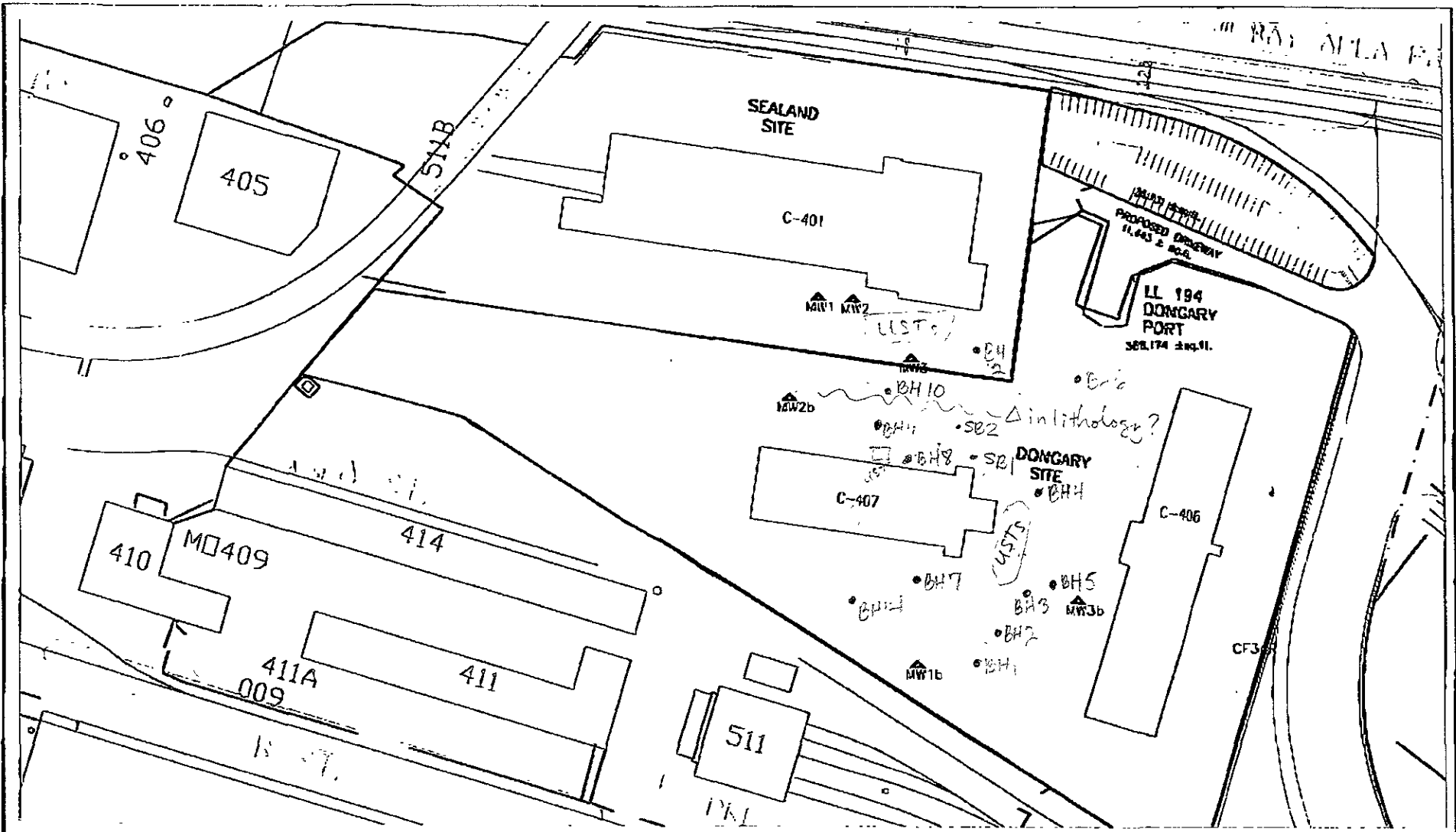

RECEIVED BY: [ ] DATE: [ ] TIME: [ ]	[ ] [ ] [ ]	[ ] [ ] [ ]	[ ] [ ] [ ]	PORT OF OAKLAND <b>TOLLING AGREEMENT          EXHIBIT "A"</b>	<b>PORT OF OAKLAND</b> [ ] [ ]	DATE: [ ] TIME: [ ] BY: [ ]
---	-------------------	-------------------	-------------------	--	--------------------------------------	-----------------------------------

↑  
2

FP in soil

HAZMAT



94 DEC 29 PM 3:33

# PORT OF OAKLAND

December 27, 1994

Jennifer Eberle  
Hazardous Materials Specialist  
Alameda County Health Care Services Agency  
1131 Harbor Bay Parkway, 2nd Floor  
Alameda, CA 94502

Dear Ms. Eberle:

**SUBJECT: FREE PRODUCT REMOVAL AT 2277 7TH ST (Port Contract # 93394)**

The purposes of this letter are:

- 1) to update you on the Port of Oakland's free product removal efforts at 2277 7th St., and to request your concurrence with our plan for future action; and
- 2) to provide you with updated information with respect to groundwater flow direction at the project site.

## FREE PRODUCT REMOVAL

As you know, the Port has been removing free product from MW-2 and MW-3 at 2277 7th St. since June 30, 1994. Initially, product removal was performed on a weekly basis by bailing. After eight weeks, product thickness in MW-3 was not significantly reduced.

At that time, the Port proposed in a letter dated August 24, 1994, to use a mechanical pump to remove product more efficiently. You concurred via letter dated August 30, 1994. The Port commenced free product removal using a mechanical pump on September 23, 1994, and has performed seven additional pumping episodes. **As of December 8, 1994, the Port had removed a total of 1180 gallons of diesel from MW-3 and product thickness remained at 5.63 feet.** We have enclosed a table documenting free product removal efforts to date.

Because manual pumping does not appear to be an effective solution for reducing the quantity of free product at this site, the Port proposes to evaluate a more comprehensive, automatic system. We are also exploring the possibility of working cooperatively with Dongary Investments in designing and



Jennifer Eberle  
Free Product Removal  
December 27, 1994  
Page 2

constructing such a system. In the interim, we have stopped pumping free product manually.

Pursuant to Title 23, Article 5, Section 2655, we request that you concur with our interpretation that it is impractical to continue to remove free product via manual pumping.

**GROUNDWATER FLOW DIRECTION**

On December 6, 1994, a Port of Oakland survey crew completed a survey of the three wells installed by the Port at Building C-401 and the three wells installed as part of the Dongary Investments investigation. A copy of the survey report is enclosed. Using the information obtained in the Port survey, the groundwater flow direction has been recalculated for three different water level measuring events (see enclosed figure). Based on the results of the recalculation, it appears that the Port's monitoring well MW-3 is located upgradient of the former Port-owned underground storage tanks.

If you have any questions, please feel free to contact me at 272-1220.

Sincerely,

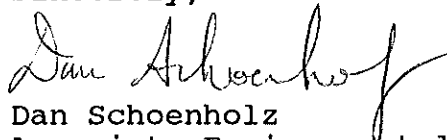

Dan Schoenholz  
Associate Environmental Scientist

Enclosures

cc: Don Ringsby, Dongary Investments  
Terry Surel  
James McGrath  
Neil Werner  
Gerry Slattery, Uribe & Associates

**Product Column Data for  
Groundwater Monitoring Wells at  
Port of Oakland Building C-401, 2277 Seventh Street, Oakland**

Date	Reference Elevation <sup>1</sup> (feet)	Well Depth (feet)	Initial Depth to Product <sup>2</sup> (feet)	Initial Depth to Groundwater <sup>2</sup> (feet)	Initial Thickness of Product in Well (feet)	Estimated Amount Recovered (gallons)	Final Depth to Product <sup>2</sup> (feet)	Final Depth to Groundwater <sup>2</sup> (feet)	Final Thickness of Product in Well (feet)
<b>MW - 1</b>	<b>14.17</b>	<b>15.4</b>							
6/30/94			9.20	9.75	0.55	1.5	NM	NM	NM
7/8/94			9.12	9.88	0.76	1.5	NM	NM	NM
7/14/94			9.12	9.90	0.78	1.5	NM	NM	NM
7/21-22/94			9.16	9.78	0.62	1.5	NM	NM	NM
7/29/94			9.13	10.00	0.87	3	NM	NM	NM
8/3/94			9.19	10.30	1.11	3	NM	NM	NM
8/11/94			9.24	10.51	1.27	3	NM	NM	NM
8/18/94			9.25	10.38	1.13	3	NM	NM	NM
9/29/94			9.30	10.50	1.20	3	11.05	11.1	0.05
10/4/94			9.30	9.75	0.45	1.5	9.45	9.5	0.05
10/14/94			9.25	10.05	0.80	1.5	9.4	9.45	0.05
10/21/94			9.49	10.84	1.35	NA	NM	NM	NM
11/2/94			9.44	10.26	0.82	2.5	NM	NM	NM
* 11/10/94			8.45	9.80	1.35	3	NA	NA	NA
11/18/94			8.78	9.76	0.98	3	NM	NM	NM
12/8/94			8.69	9.46	0.77	3	NM	NM	NM
<b>MW - 2</b>	<b>14.38</b>	<b>15.18</b>							
7/22/94			NA	9.58	NA	NA	NA	NA	NA
7/29/94			NA	9.51	NA	NA	NA	NA	NA
8/3/94			NA	9.59	NA	NA	NA	NA	NA
8/11/94			NA	9.67	NA	NA	NA	NA	NA
8/18/94			NA	9.63	NA	NA	NA	NA	NA
9/29/94			NA	9.75	NA	NA	NA	NA	NA
10/4/94			NA	9.6	NA	NA	NA	NA	NA
10/21/94			NA	9.94	NA	NA	NA	NA	NA
11/2/94			NA	9.8	NA	NA	NA	NA	NA
* 11/10/94			NA	9.8	NA	NA	NA	NA	NA
11/18/94			NA	8.92	NA	NA	NA	NA	NA
12/8/94			NA	8.98	NA	NA	NA	NA	NA

**Product Column Data for  
Groundwater Monitoring Wells at  
Port of Oakland Building C-401, 2277 Seventh Street, Oakland**

Date	Reference Elevation <sup>1</sup> (feet)	Well Depth (feet)	Initial Depth to Product <sup>2</sup> (feet)	Initial Depth to Groundwater <sup>2</sup> (feet)	Initial Thickness of Product in Well (feet)	Estimated Amount Recovered (gallons)	Final Depth to Product <sup>2</sup> (feet)	Final Depth to Groundwater <sup>2</sup> (feet)	Final Thickness of Product in Well (feet)
<b>MW - 3</b>	14.24	15.3							
6/30/94			8.83	14.97	6.14	45	NM	NM	NM
7/8/94			8.34	14.85	6.51	45	NM	NM	NM
7/14/94			8.35	14.41	6.06	45	NM	NM	NM
7/21-22/94			8.45	14.32	5.87	45	NM	NM	NM
7/29/94			8.9	14.45	5.55	18	NM	NM	NM
8/3/94			8.45	14.45	6.00	30	NM	NM	NM
8/11/94			9.52	14.45	4.93	30	NM	NM	NM
8/18/94			9.48	14.38	4.90	45	NM	NM	NM
9/23/94			8.75	14.45	5.70	100	8.8	12.9	4.10
9/29/94			8.85	14.45	5.60	165	9.5	12.45	2.95
10/4/94			8.65	14.5	5.85	165	9	12.3	3.30
10/14/94			9.6	14.5	4.90	165	9.1	10.5	1.40
10/21/94			8.88	14.5	5.62	90	9.02	12.67	3.65
11/2/94			8.79	14.5	5.71	50	9.85	13.25	4.20
* 11/10/94			8.07	13.12	5.05	NA	NA	NA	NA
11/18/94			7.91	13.1	5.19	90	NA	NA	NA
12/8/94			7.95	13.58	5.63	50	NA	NA	NA

**Notes:**

NA = not applicable

NM = not measured

\* Product recovery not conducted on 11/10/94 due to failure in the pumping equipment.

1 Reference elevation is top of well casing and relative to Port of Oakland Datum (3.2 feet below MSL).

Reference elevations surveyed on June 8, 1994 by Greiner Associates.

2 Depths measured from top of well casing.

3 For MW - 1, the estimated amount recovered is approximately 75% product and 25% water

For MW - 3, the estimated amount recovered is approximately 100% product.

December 8, 1994

**To: DAN SCHOENHOLZ**  
Environmental Planning

**From: GILBERT E. HAYES**  
Survey Chief

**Re: Locations and Elevations of Monitoring Wells**  
Survey Request 917932 / Work order: 202386

We have completed the survey work as you requested. After our discussion yesterday, I met, in the field, with Mr. John Borrego of U & A.

Together we were able to open some of the wells, however we were unable to open most of the padlocks. Thus the locations of the elevations taken at each well are annotated.

WELL	NORTHING	EASTING	ELEVATION	NOTES
MW1	2121670.88	6037561.78	14.59	(1)
MW2	2121668.81	6037599.76	14.71	(1)
MW3	2121604.12	6037863.10	14.20	(2)
MW1b	2121269.53	6037669.66	13.72	(4)
MW2b	2121560.37	6037529.43	13.81	(3)
MW3b	2121339.82	6037846.26	15.06	(4)

**NOTES:**

(1) The lid could not be opened. The elevation was taken on the flange of the rim. This location was punched and painted red for future location.

(2) The lid was opened, but the cap assembly covered the casing. Nobody had a key to this padlock. An elevation was taken on the padlock flange which was painted red.

(3) The lid was opened however the cap was locked (no key). A measurement was made to the top of the cap. Subtract 0.01 from the value shown to determine the elevation of the casing at the indicator mark.

(4) The lid was opened and the cap removed successfully. The elevation shown is on the top of the casing.

In the future it would be very helpful if we can obtain keys and whatever tools are required to open the lids. Also, as a suggestion, you might wish to think about generating a Port Standard Detail so that lids, locks, caps, etc. are always the same on future wells.



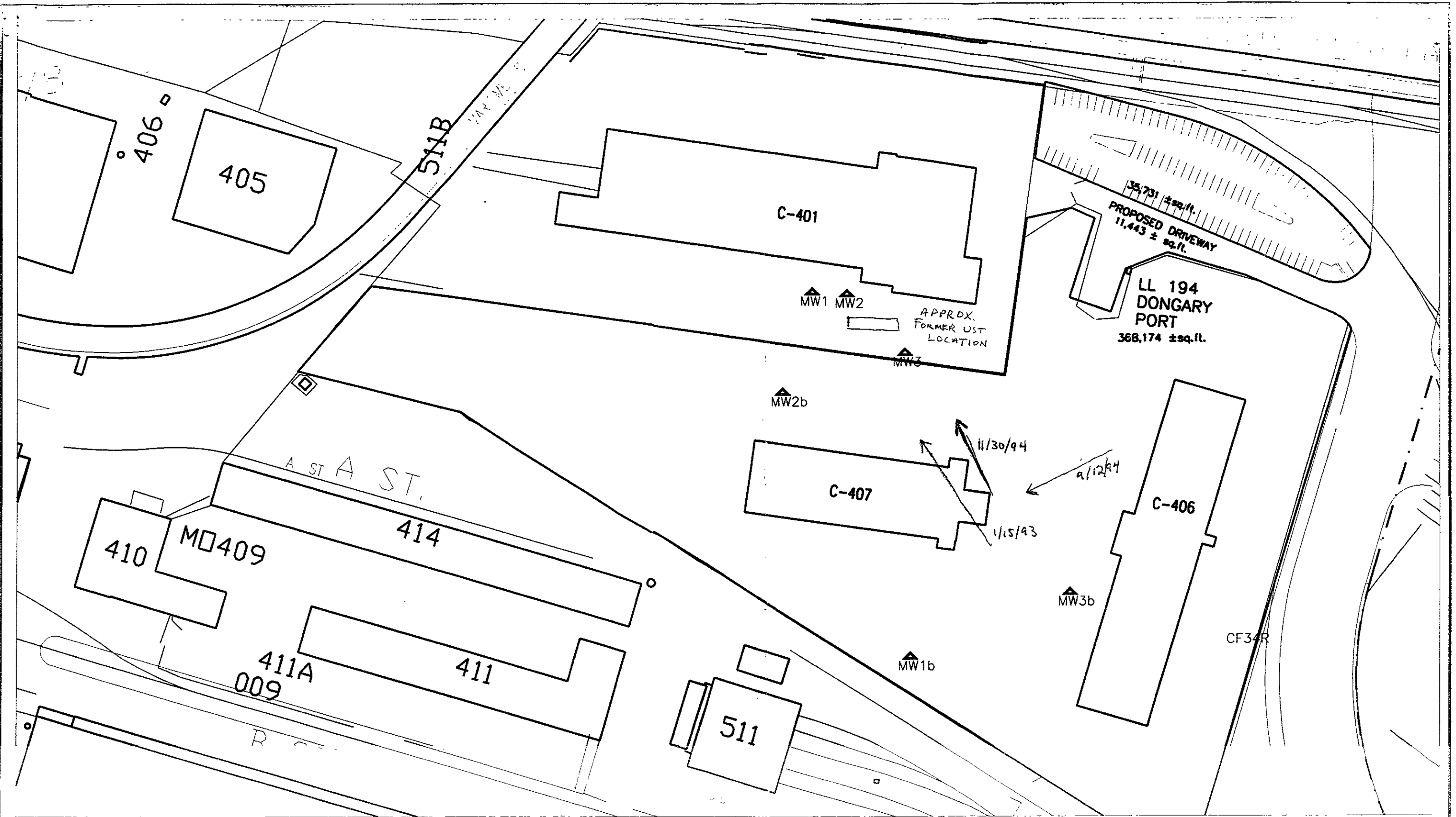

→ = APPROXIMATE GW FLOW DIRECTION W DATE OF GW ELEVATION MEASUREMENT BASED ON PORT WELL SURVEY CONDUCTED 12/94

<p>XP atlas map 0105 atlas map 011 atlas map 012 atlas map 013</p>	<p>DATE: _____</p> <p>DRAWN: _____</p>	<p>SCALE: _____</p>	<p>PROJECT: _____</p>	<p>Dongary/ Port Monitoring Wells</p>	<p>PORT OF OAKLAND</p>	<p>map\cases\dongary</p>
--	--	---------------------	-----------------------	---	------------------------	--------------------------