

RECEIVED

By Alameda County Environmental Health 9:54 am, Sep 13, 2016

411 W. MacArthur LLC
650B Fremont Ave #375
Los Altos, CA 94024
415-705 9922
Email: joehernon@gmail.com

Sept. 1st, 2016.

Keith Nowell and Dilan Roe:

Alameda County Department of Environmental Health. 1131 Harbor Bay Parkway.
Suite 250. Alameda, CA 94502-6577

Subject: 411 W. MacArthur Blvd, Oakland California.

Attached please find a report entitled " Revised Human Health Risk Assessment Report" (HHRA) prepared by Applied Remedial Services, Inc., for the property at 411 West MacArthur Boulevard in Oakland, California. The objective of this report was to satisfy requests from Alameda County Department of Environmental Health.

I declare under penalty of perjury that the information and/or recommendations contained in the attached document or report are true and correct to the best of my knowledge.

Sincerely,
Joe Hernon

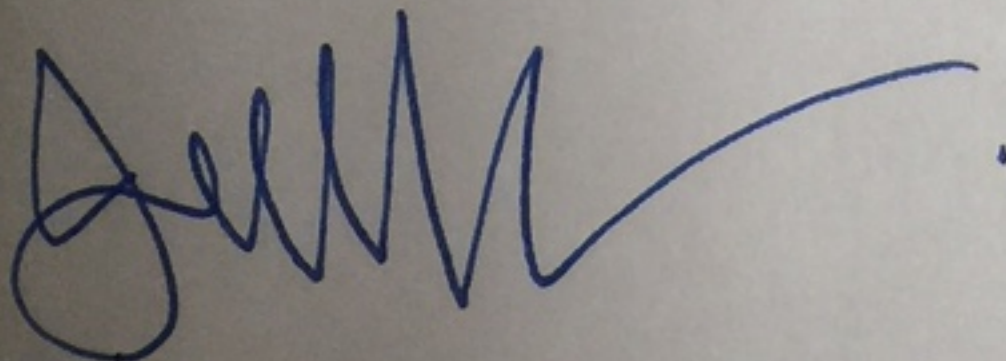

Regards,

Joseph A. Hernon. (Manager)
411 W. MacArthur LLC.



*P.O. BOX 5086
Walnut Creek, California 94596
Phone (925)943-7742, Fax (925) 943-7714*

Applied Remedial Services, Inc.

August 26, 2016

Mr. Keith Nowell
Ms. Dilan Roe
Alameda County Department of Environmental Health
1131 Harbor Bay Parkway, 2nd Floor
Alameda, CA 94502

**Subject: Revised Human Health Risk Assessment Report
411 W. MacArthur Boulevard, Oakland, California
ACEH RO#0003192; Global ID: T10000007937**

Dear Mr. Nowell and Ms. Roe:

ARS is pleased to submit this Human Health Risk Assessment Report (HHRA) on behalf of 411 West MacArthur LLC for the planned residential development at 411 West MacArthur Boulevard in Oakland, California (the "Site"). Soil and groundwater vapor data from the eastern portion and the future proposed elevator shaft area located in the middle southern portion of the site were evaluated to determine if a potentially complete vapor intrusion pathway exists within the subsurface, and to evaluate the potential risk to future building occupants associated with the vapor intrusion pathways.

We have offered a background section of previous investigations and results. We have also presented the methods and results of the vapor intrusion risk evaluations.

The potential vapor intrusion pathway was evaluated using a tiered or step-wise approach, in accordance with Cal EPA guidance (2011) and San Francisco Regional Water Quality Control Board (SFRWQCB) (2016) vapor intrusion guidance Environmental Screening Levels (ESLs). The approach consisted of first comparing site soil and groundwater vapor concentrations to conservative vapor screening levels for residential and commercial/industrial exposure scenarios in order to select constituents of potential concern (COPCs), followed by vapor intrusion modeling (HERO VI model), which was used in conjunction with

the USEPA Advanced Version (3.1) of the Johnson and Ettinger Model. February 2004. The Model was adjusted to use Cal EPA DTSC's recommended input parameters (from Cal EPA 2011) and most updated toxicity information presented in the (2011) Department of Toxic Substances Control (DTSC) document: "Guidance for the Evaluation and Mitigation of Subsurface Vapor Intrusion into Indoor Air", also called the Vapor Intrusion Guidance (VIG).

Please Do not hesitate to call us if you need any further assistance. In addition to the office I can be reached at (707) 567-2202 and Jim at (707) 631-1505.

Respectfully Submitted,



Michael Kara
Principal Toxicologist



James E. Gribi
Professional Geologist
California No. 5843



CERTIFICATION

I Michael F. Kara a Biochemist have completed all graduate university courses in Toxicology, conducted three years of post-graduate research in Toxicology and concluded 1st year of medicine, has Thirty (30) years of direct investigation and remediation of contaminated properties and over Ten (10) years of conducting Health Risk Evaluations, certify under penalty of law that this document titled "Human Health Risk Assessment Report" for the property located at 411 West MacArthur Blvd. in Oakland, California (Site), dated August 15, 2016, was personally researched and prepared by me. The completed Report was conducted under my supervision and direction in accordance with a system designed to assure that the information submitted was properly gathered and evaluated by qualified personnel. This information is, to the best of my knowledge and belief, true, accurate, complete and satisfies the scope of work prescribed by the client. I am aware that there are significant penalties for submitting false information. The report was peer reviewed by my colleague Jim Gribi, a California licensed Professional Geologist with over Twenty-Five (25) years of direct investigation and remediation experience of contaminated properties.

Furthermore, I certify and declare that, to the best of our professional knowledge and belief, that we meet the definition for Environmental Professionals as specified in 40 CFR Part 312.10. We have the specific qualifications, based on education, training, and experience, to assess and remediate a property of the nature, history, and setting of this Site.



Michael F. Kara
Principal Toxicologist
USEPA Environmental Professional
Registered Environmental Property Assessor # 386340
Registered Lead Sampling Technician #21985

8-18-2016

Date

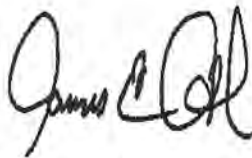

James E. Gribi
Registered Geologist
California No. 5843

8-18-2016

Date

TABLE OF CONTENTS

1.0 INTRODUCTION1

2.0 SITE GEOLOGY AND HYDROGEOLOGY1

3.0 DISTRIBUTION OF PETROLEUM HYDROCARBONS IN SOIL.....2

4.0 DISTRIBUTION OF PETROLEUM HYDROCARBONS IN GROUNDWATER.....3

5.0 PREVIOUS REMEDIAL ACTIVITIES3

6.0 RECENT INVESTIGATIVE ACTIVITIES AT THE SITE.....4

 6.1 GRIBI’S INVESTIGATION4

 6.2 ASI’S INVESTIGATION7

7.0 PLANNED DEVELOPMENT VAPOR MITIGATION MEASURES8

8.0 HUMAN HEALTH RISK ASSESSMENT.....9

 8.1 POTENTIAL EXPOSURE PATHWAYS9

 8.3 COMPARISON OF COPC CONCENTRATIONS WITH ESLs10

 8.3 QUANTITATIVE RISK ANALYSIS.....12

 8.3.1 *Risk Analysis Using Soil Gas Data*.....12

 8.3.2 *Risk Analysis Using Groundwater Data*13

 8.3.3 *Model Uncertainties*14

9.0 CONCLUSIONS.....14

11.0 REFERENCES17

TAB NUMBER

- 1) TABLES
- 2) FIGURES
- 3) BORING LOGS
- 4) GROUNDWATER ATTENUATION CHARTS for MW-2 and MW-3

HUMAN HEALTH RISK ASSESSMENT REPORT
411 W. MACARTHUR BOULEVARD, OAKLAND, CALIFORNIA
ACEH RO#0003192; GLOBAL ID: T10000007937

1.0 INTRODUCTION

On behalf of 411 West MacArthur LLC (the Client), Applied Remedial Services, Inc. (ARS) is pleased to submit this Human Health Risk Assessment Report (HHRA) and a summary of site specific data and activities regarding recent investigative events that were conducted by two (2) consulting firms Gribi Associates (Gribi) in April 2016 and Aquifer Sciences, Inc. (ASI) in May 2016 at the mid-southern and eastern portions of the property located at 411 West MacArthur Blvd. in Oakland, California (the “Site”).

Chevron Site Number 351642 is a former Unocal service station located on the southwestern corner of the intersection of West MacArthur Blvd. and Webster Street, in Oakland, California (Figures 1 and 2). Two generations of fuel station facilities have been removed from the Site: the 1st in 1989 and the 2nd in 1998. The station building and canopy were left in place following station decommissioning (Figure 3). There are currently no businesses onsite and the site is being prepared for a sixteen (16) unit multi-story residential apartment complex with a 3,000 square feet (sf) commercial grocery market place on the corner of Webster Street and West MacArthur Blvd. (Figure 3).

The Site comprises an approximately 8,000-square foot parcel on the southwest corner of West MacArthur Boulevard and Webster Street. The planned Site development will consist of a five-story apartment building with approximately 16 living units. The building will include a concrete-encased parking and storage basement on the west side of the building. The ground floor will include parking over the basement area on the west side and concrete-floored commercial use on the east side of the building. The second through fifth floors will include residential apartments. An elevator shaft located towards the middle southern portion of the site in the will extend from the basement up to the fifth floor.

2.0 SITE GEOLOGY AND HYDROGEOLOGY

Silt and clay mixtures were encountered at the site by AECOM (consultant to Chevron) from the surface to the total depth explored of 30 feet below ground surface (bgs). In some locations, these sediments are underlain by clayey sand and clayey gravel to 30 feet bgs. Intermittent, poorly graded sand layers are encountered from approximately 20 to 27 bgs. Boring logs for the new ASI borings advanced in May 2016 and three (3) monitoring wells MW-1, MW-2 and MW-3 which were advanced at the site in 1989, are included in Tab Number 3. (see Figures 4, 5, 6, and 7).

The most recent groundwater monitoring event was conducted on February 14, 2013. Depth to groundwater ranged from 13.66 to 17.98 feet below the top of the well casings, and groundwater elevation ranged from 53.46 to 57.71 feet above mean sea level. The groundwater flow direction was calculated to flow in a South-Southwesterly direction, with an average hydraulic gradient of approximately 0.04 feet per foot (ft/ft).

The historical groundwater flow directions have been predominately the South since April 1993 when wells MW-5 and MW-6 were included (Figure 3). Prior to 1993, with fewer wells being monitored, the groundwater flow direction was noted to be the East. Hydrocarbons were not detected in groundwater samples from SB-2, which is located directly East of the Site, indicating that the groundwater plume has not migrated in that direction.

Historical groundwater flow direction was also discussed in the 2006 Soil and Groundwater Investigation Report, where TRC included a rose diagram that depicted the predominant groundwater flow directions through first quarter 2006 to be East and Southwest; however, the existing data through third quarter 2010 were re-evaluated. The predominant flow directions were found to be South and South-Southwest. Since the second quarter of 1994, all reported flow directions were reported to be generally Southerly, ranging between East-Southeast and Southwest, with the exception of the second quarter of 2001 (Northeast), and the third quarter of 2006 (West). Since the third quarter of 2007, reported flow directions have been to the South.

3.0 DISTRIBUTION OF PETROLEUM HYDROCARBONS IN SOIL

Table 1 and Figures 8 and 9 provide a summary of historic and recent soil hydrocarbon results. The highest concentrations of TPHg (6,100 mg/kg), toluene (5,300 mg/kg), ethylbenzene (86 mg/kg), and total xylenes (420 mg/kg) were detected in the fuel UST source area in SB-3 at a depth of 16 feet bgs. The highest concentration of benzene (12 mg/kg) was detected in a sidewall sample (SW-1) from the UST excavation; however, benzene was not detected in the confirmation sample (SW-1(4)) from this location following over-excavation activities. The highest concentration of benzene in soil left in place after excavation activities were detected near the UST excavation area in MW-2 (1.5 mg/kg) at 19 feet bgs.

The highest concentration of MTBE (0.64 mg/kg) was detected for SB-3 at 14 feet bgs. The horizontal extent of hydrocarbons in soil is defined by MW-3 to the North; SB-9 to the East; SB-10, SB-5, and SW-1(4), and SB-1 to the South; and SB-4 and MW-4 to the West.

Hydrocarbon-impacted soil is generally encountered at depths below 15 feet bgs on the Eastern side of the Property near the former gasoline USTs.

4.0 DISTRIBUTION OF PETROLEUM HYDROCARBONS IN GROUNDWATER

Tables 2 and 3, and Figure 9 provide a summary of historic and recent groundwater results. Groundwater has been sampled at the site since 1989. Sample analyses have included TPHg, BTEX, and MTBE. The historical maximum concentrations of TPHg (21,000 micrograms per liter [$\mu\text{g/l}$]), benzene (1,300 $\mu\text{g/l}$), and MTBE (4,800 $\mu\text{g/l}$) were detected in MW-3 in 1991 and 1992 and have significantly decreased since that time. Point attenuation graphs are provided for MW-2 and MW-3 as Charts B1 and B2, respectively in Tab Number 4. TPHg and benzene were not detected in groundwater above laboratory reporting limits during the most recent groundwater monitoring event conducted in February 2013. MTBE was detected in groundwater for one well, MW-3, at 5.1 $\mu\text{g/l}$, which is slightly above the Environmental Screen Level (ESL) of 5.0 $\mu\text{g/l}$.

Petroleum hydrocarbons in groundwater were defined by well MW-5 to the East, MW-2 to the South, MW-1 to the West, and MW-4 and MW-6 to the Northwest and Northeast, respectively.

Grab groundwater samples collected from soil borings during March 2006 and December 2010 show significantly higher hydrocarbon concentrations than groundwater samples collected at the same time from the monitoring well network (see Tables 2 and 3). This difference is most likely due to: (1) the fine-grained nature of Site soil and presence of entrained sediments in the samples, and (2) cross contamination of groundwater from coring tools that were pushed through slightly hydrocarbon-impacted soils. The grab groundwater samples confirm the groundwater impacts around the former gasoline UST pit and show decreasing concentrations over time due to natural attenuation. Thus, the 2010 grab groundwater samples showed lower hydrocarbon concentrations than grab groundwater samples from 2006 borings collected from the same areas of the site (SB-3W vs. SB-9 and SB-5W vs SB-10). Also, very low to non-detectable concentrations of petroleum hydrocarbons were encountered in grab groundwater samples from downgradient offsite 2006 borings SB-1W and SW-2W.

5.0 PREVIOUS REMEDIAL ACTIVITIES

Remedial activities conducted at the Site included the excavation of approximately 830 cubic yards of soil from the site (450 cubic yards in 1989 and 380 cubic yards in 1998) and the removal of 1,500 gallons of groundwater.

In July 1989, during UST replacement activities, approximately 450 cubic yards of soil and 1,500 gallons of groundwater were removed from the UST pit and disposed of off-site. Analytical results for the six soil confirmation sidewall samples collected at 10 feet bgs from the fuel tank pull indicated low concentrations of total petroleum hydrocarbons (TPH) as gasoline (TPHg) ranging from non-detectable to 11 milligrams per kilogram (mg/kg), except for one sample, which had 3,100 mg/kg of TPHg (see Figure 8. A soil sample collected from the used-oil pit at 8.5 feet bgs had no detectable TPHg, TPH as

diesel (TPHd), benzene, toluene, ethylbenzene, and total xylenes (BTEX). Following the sidewall sampling, 1,500 gallons of groundwater was removed from the gasoline UST pit.

Subsequent over-excavation of the fuel UST pit was performed by removing 4 linear feet (calculated removal of 50 cubic yards) from the Southern and Eastern sidewalls, near the soil sample location with 3,100 mg/kg of TPHg. The post excavation confirmation sample results were non-detect and 1 mg/kg for TPHg in two samples collected from SW-1(4) and SW-4(2), respectively (Figure 8).

In September 1998, the second-generation USTs were removed. Soil samples were collected from beneath the former fuel USTs and the former product piping. Soil samples contained a maximum TPHg concentration of 360 mg/kg and benzene of 1.5 mg/kg at 9.5 feet, and methyl tert-butyl ether (MTBE) was not detected in any of the soil samples. Approximately 380 cubic yards of trenching and UST backfill materials from the second station configuration was stockpiled and later transported off-site for disposal during the 1998 station demolition (Figure 8).

6.0 RECENT INVESTIGATIVE ACTIVITIES AT THE SITE

Two recent investigations were conducted at the Site by Gribi Associates (Gribi) in April 2016 and Aquifer Science, Inc. (ASI) in May 2016 (see Figure 9 and Figure 10). The Gribi investigation involved 1) Collection of grab groundwater samples from three soil borings on the west and east side of the Site; and (2) Collection of soil gas samples from these three locations. The goal of these activities was to assess potential indoor risks from vapor intrusion relative to the planned residential and commercial development at the Site. The groundwater samples (GW-1, GW-2, and GW-3) were advanced to minus twenty (20) feet bgs, while the soil gas sample SG-1 located in the mid-southern portion of the site near the future elevator pit was collected from minus 15 feet bgs (457 cm) and the two other soil gas samples SG-2 and SG-3 which were collected from the future proposed commercial space area were collected from 5.5 feet bgs (168 cm).

6.1 Gribi's Investigation

- **Task 1 Collect three grab groundwater samples.** Three soil borings, GW-1, GW-2, and GW-3, were drilled to collect one grab groundwater sample from each boring. Prior to conducting field activities, boring permits were obtained from Alameda County Public Works and USA was notified.

The three borings included one boring, GW-1, in the planned location of the elevator pit, on the south side of the Site, and two borings, GA-2 and GA-3, just east of the former UST excavation cavity, on the east side of the Site (see Figure 3). Each boring was drilled to approximately three to four feet below first-encountered groundwater (groundwater expected at approximately 17 feet in depth).

After reaching boring total depth, 3/4-inch diameter PVC well casing was placed in the boring, and approximately 1 to 3 gallons of water were hypothetically to be purged from the PVC casing prior to sampling, which never occurred. Therefore, due to lack of water recharge, no purging occurred whatsoever, and the samples were collected from the first groundwater catch, which might not have been representative of site groundwater conditions. This protocol compounded by the fine-grained nature of Site soil at this depth described in ASI's boring logs as "Clayey Silt with Sand" and the more than likely presence of entrained sediments in the samples, may have overestimated the presence of petroleum hydrocarbon related compounds in the grab groundwater samples.

The Groundwater was sampled and preserved in accordance with standard sampling protocols, and samples were transported to the analytical laboratory under formal chain-of-custody. Borings were grouted in accordance with ACPW permit requirements, and drilling and sampling equipment were thoroughly decontaminated between each boring. Three groundwater samples (one per boring) were analyzed for TPH-G, BTEX, and Naphthalene using USEPA Method 8260. The results are presented in Table 2.

- **Task 2 Collect three soil gas samples.** Three soil gas samples, SG-1, SG-2, and SG-3, were collected. The three samples included one sample, SG-1, in the planned elevator pit area, and two samples, SG-2 and SG-3, just east of the former UST excavation cavity, on the east side of the Site (see Figure 3). The three soil gas samples were collected at approximately five and a half feet beneath the planned building foundation depth; thus, respective soil gas sampling depths for SG-1, SG-2, and SG-3 were 16.0 feet, 5.5 feet and 5.5 feet bgs. Note that for SG-1, since groundwater was shallower than 20 feet in depth, then the soil gas sample depth was raised to approximately four feet above the groundwater depth.

Temporary vapor wells were constructed as follows: (1) After coring to the desired depth using direct-push coring equipment, a vapor tip with 1/4-inch diameter Teflon (or similar) tubing was set at the desired depth; (2) Filter sand was placed around the vapor tip, with sand approximately six inches below and six inches above the vapor tip; (2) A one foot bentonite seal, consisting of six inches of dry granular bentonite followed by six inches of pre-hydrated granular or pellet bentonite, was placed above the filter sand; and (3) The remaining annulus was filled with hydrated pellet bentonite.

The three temporary soil gas wells were purged and sampled in accordance with current DTSC protocols as follows:

- A "T" valve was placed in line at the ground surface to allow for system purging and for pressure testing of the above ground portion of the sampling train. The sampling tubing was attached to a

200-milliliter per minute maximum flow controller, then a one-liter laboratory-supplied Summa Canister™ (evacuated to 29 inches' mercury vacuum) with vacuum pressure valve.

- After allowing the vapor wells to equilibrate for at least one hour, the wells were purged and sampled. A laboratory supplied purge/pressure test Summa Canister™ (evacuated to 29 inches' mercury) was then used to test vacuum pressure in the above ground portion of the sampling train. Sampling train vacuum pressure was maintained for at least 10 minutes; if pressure drops occur, the system connections were tightened and the pressure testing continued.
- The vapor well was then purged of approximately three purge volumes using a dedicated Summa Canister.
- The entire probe and sampling train was placed under a shroud and a leak test was conducted. Helium from a compressed gas cylinder was pumped into the shroud, and the helium concentration inside the shroud were maintained at approximately 10,000 ppmV (the detection level for the ASTM Method D-1946 is 100 ppmV). Helium monitoring was conducted using a Mark Radio detection MGD-2002 helium detector with internal pump (or equivalent). For the sampling train leak test, the helium monitor was attached to the purge tube and the T-valve opened. A positive reading of helium by the detector indicated the presence of helium inside the sample train and, therefore, a leak in the sample train. If helium is detected, all connections in the sample train were tightened and the leak test repeated until no helium was detected. It is noteworthy, that SG-2 contained 4.2% helium according to the analytical laboratory. Therefore, a leak did occur in this Summa canister; however according to CAL EPA DTSC acceptable Helium leakage is up to 10%, therefore results of this sample are valid.
- The vapor sample was then collected by opening the Summa canister and allowing the vapor to fill the canister until the vacuum pressure in the canister reached approximately 20 percent of initial (approximately 5 to 6 inched mercury). The flow controller was used so that the Summa Canister filled slowly (200 ml per minute or less) to insure a representative soil vapor sample. Prior to, at start time, and during sampling, periodic vacuum measurements were recorded on a field data sheet, and initial and final vacuum pressures were noted on a chain-of-custody records.
- The vapor samples (filled Summa canisters) were secured and transported to McCampbell Analytical Laboratories, Inc. a certified analytical laboratory, under formal chain-of-custody.
- The three soil gas samples were analyzed for TPH-G, BTEX, and Naphthalene using USEPA Method TO-15, and for fixed gases (including oxygen, carbon dioxide, nitrogen, and helium) using ASTM Method D1946-90. These data are presented in Table 4.

Grab groundwater samples from GW-1, GW-2, and GW-3 showed respective TPHg concentrations of 42,000 ug/L, 21,000 ug/L, and 7,800 ug/L, and respective benzene concentrations of 110 ug/L, 39 ug/L, and <5 ug/L. Respective naphthalene concentrations in GW-1, GW-2, and GW-3 grab groundwater samples were 2,300 ug/L, 490 ug/L, and 190 ug/L. Since groundwater is present below 15 feet bgs and is not used on the site, the direct exposure and ingestion receptor scenarios are not applicable. However, since the benzene concentrations in GW-1 and GW-2 and the naphthalene concentrations in all three grab groundwater samples exceed the Groundwater to Vapor Intrusion ESLs (deep groundwater, fine-coarse grained soils), the groundwater to vapor intrusion exposure pathway is potentially complete for onsite receptors.

Soil gas samples from SG-1, SG-2, and SG-3 showed respective TPHg concentrations of 150,000 ug/m³, 1,900,000 ug/m³, and 2,700,000 ug/m³, and respective benzene concentrations of 39 ug/m³, 450 ug/m³, and <160 ug/m³. The benzene concentration for SG-2 (450 ug/m³), located on the east end of the site, is above the Sub-slab/Soil Gas residential land use ESL for benzene of 48 ug/m³. This indicates a potential indoor vapor intrusion exposure risk relative to benzene if mitigation measures are not implemented during construction of the planned residential development. It is noteworthy, that the planned site development will include the installation of a sub-slab depressurization system (SSDS) designed to fully mitigate any and all potential vapor intrusion concerns. A brief description of the planned SSDS is included in Section 7.0 of this report. All activities surrounding SSDS installation will be conducted under the supervision of a certified vapor engineer who has been qualified by the manufacturer of the product to install their product.

Soil gas samples from SG-1, SG-2, and SG-3 showed respective methane concentrations of 0.50 percent (%), 21%, and 23%. These methane impacts could have resulted from either: (1) breakdown of residual hydrocarbons in soil; and/or (2) biogenic activity in shallow organic-rich Bay Mud silts and clays. The fact that the SG-1 soil gas sample, collected at 16 feet in depth in non-Bay Mud soils, showed low methane, whereas samples SG-2 and SG-3, collected in Bay Mud soils, showed elevated methane, would suggest a natural, biogenic origin related to Bay Mud soils. Potential explosive hazards associated with these shallow soil gas methane impacts will be mitigated by the planned vapor barrier/venting system.

Due to the presence of elevated methane in shallow soil gas samples SG-2 and SG-3, Alameda County Environmental Health requested in a meeting on April 6, 2016 that three additional borings be drilled in the immediate vicinity of SG-2 and SG-3. The purpose of these borings was to determine whether or not a shallow hydrocarbon source exists, which could have resulted in the elevated methane vapor impacts at SG-2 and SG-3. Thus, these borings were to be drilled down to approximately 16 feet in depth, and soil samples were to be collected at approximately five-foot intervals would be analyzed for hydrocarbon constituents.

6.2 ASI's Investigation

In May 2016, Aquifer Sciences, Inc. (ASI) drilled and sampled three soil borings, AS-1, AS-2, and

AS-3, adjacent to the previous soil gas sample locations SG-2 and SG-3. A total of twelve (12) soil samples were collected from the borings for total petroleum hydrocarbons quantified as gasoline (TPH-gasoline), benzene, toluene, ethylbenzene, and xylenes (BTEX) analysis by EPA Method 8021B and 8015B.

Soil samples from borings AS-1 and AS-2 showed no significant detections of hydrocarbons in soil samples from 5.0 feet to 18 feet in depth. Soil samples collected at 7 feet, 10 feet 14 feet, and 16 feet bgs from boring AS-3, located adjacent to previous Gribi boring/sample locations GW-3 and SG-3, showed respective TPHg concentrations of 90 mg/kg, 550 mg/kg, 13 mg/kg, and 690 mg/kg. Samples from 7 feet to 14 feet bgs showed no significant detections of BTEX constituents, and the soil sample from 16 feet bgs showed 2.4 mg/kg of benzene, 24 mg/kg of toluene, 17 mg/kg of ethylbenzene, and 94 mg/kg of xylenes. These concentrations are relatively low and certainly do not indicate widespread hydrocarbon release at shallow depth beneath the investigated area.

7.0 PLANNED DEVELOPMENT VAPOR MITIGATION MEASURES

The Site comprises an approximately 8,000-square foot parcel on the southwest corner of West MacArthur Boulevard and Webster Street. The planned Site development will consist of a five-story apartment building with approximately 16 living units. The building will include a concrete-encased subterranean parking and storage basement on the west side of the building. The ground floor will include parking over the basement area on the west side and concrete-floored commercial use on the east side of the building. The second through fifth floors will include residential apartments. An elevator shaft will extend from the basement up to the fifth floor. Copies of portions of planned development drawings are included in Tab Number 2.

In order to mitigate possible vapor intrusion into the Site building, a passive sub-slab depressurization system (SSDS) and vapor barrier will be installed under the planned commercial space (approximately 3,000 square feet) on the east side of the building, to include the elevator pit area. The recommended area for the vapor barrier and passive venting system is shown on Figure 3.

Prior to installation, vapor mitigation system design plans and specifications will be prepared by a qualified California-licensed civil and geotechnical professional engineer and will be submitted to ACEH for approval. In addition, a Site Mitigation Risk Plan will be submitted, which describes operation and maintenance activities to be conducted for the SSDS and vapor barrier to insure system integrity throughout the life of the Site apartment building.

8.0 HUMAN HEALTH RISK ASSESSMENT

This section provides an evaluation of potential exposure pathways, comparison of contaminants of potential concern (COPC) with regulatory screening levels, and calculation of site-specific risk levels based on COPC data. These are presented in the following sections:

- 8.1 Potential Exposure Pathways
- 8.2 Comparison of COPC Concentrations with ESLs
- 8.3 Quantitative Risk Analysis

Please note that this HHRA has been conducted without taking into account the planned SSDS mitigative measures for the site development. Based on the results of this HHRA and our understanding of the planned SSDS mitigation measures, we believe that, once implemented, actual risk levels for future human receptors will be significantly below allowable risk levels (one in one million for Carcinogenic Risk and 1.0 Hazard Index for non-carcinogenic risk).

8.1 Potential Exposure Pathways

ARS conducted a qualitative evaluation of potential exposure pathways relative to the planned residential development. Results of this preliminary evaluation of all potential exposure pathways. Note that, in conducting this evaluation, we have generally tried to use current, and not historic (greater than 10 years old), data.

Exposure Pathway	Complete?	Risk Level	Discussion
Air Exposure Pathway			
Surface soil volatilization to ambient air	Possible	Low	No shallow soil BTEX detections.
Subsurface soil volatilization to ambient air	Possible	Low	No significant deep soil BTEX detections.
Subsurface soil volatilization to enclosed space	Possible	Low	No shallow soil BTEX detections above 10 ft bgs.
Groundwater volatilization to ambient air	Possible	Low	Possible BTEX volatilization to Commercial space of Site building.
Groundwater volatilization to enclosed space	Possible	Low to Moderate	Possible BTEX volatilization to Commercial space of Site building.
Soil Exposure Pathway			
Dermal contact/ingestion of surface soils	Possible	Low	Construction worker only; no significant shallow soil hydrocarbon impacts.
Dermal contact/ingestion of subsurface soils	Possible	Low	Construction worker only; soil TPHg/BTEX impacts generally below direct exposure ESLs. Building foundation

Exposure Pathway	Complete?	Risk Level	Discussion
			would not be deeper than 3.5 ft. bgs.
Groundwater Exposure Pathway			
Soil leaching to groundwater, ingestion	No	None	No onsite groundwater use.
Dissolved/free phase groundwater ingestion	No	None	No onsite groundwater use.
Surface Water Exposure Pathway			
Soil leaching to surface water	No	None	No nearby surface water bodies.
Groundwater plume discharge to surface water	No	None	No nearby surface water bodies.

As the table above illustrates, possible complete exposure pathways exist relative to the air exposure (volatilization to ambient and enclosed air from soil and groundwater) and soil exposure (direct exposure to soil) pathways. The potential risks associated with ambient air exposure, either from soil or groundwater exposure, is expected to be low. The potential risks associated with enclosed air exposure, primarily from groundwater volatilization, are expected to be low to moderate, given the somewhat elevated benzene, ethylbenzene, and naphthalene soil gas concentrations at SG-2. Potential direct exposure to hydrocarbon-impacted soils is possible during construction; however, the areas with identified soil hydrocarbon impacts are relatively small and are present at depths greater than 10 feet bgs and building foundation structural members would not infringe upon soil beneath 3.5 ft. bgs.

In summary, the primary potential environmental receptors relative to the planned residential development are: (1) Potential direct exposure to hydrocarbon-impacted soils during construction related activities; and (2) Potential exposure of residential apartment building occupants to indoor air with volatile hydrocarbons.

Note that the above receptor pathway evaluation does not specifically take into account possible methane explosion hazards. This is because, while elevated methane concentrations are present in shallow soil gas beneath the Site, the evaluation of associated flash risk is difficult because of other conditions (rich oxygen environment and an ignition source) which are necessary for a flash. Note that the planned SSDS mitigative measures are expected to fully mitigate this risk.

8.3 Comparison of COPC Concentrations with ESLs

Contaminants of Potential Concern (COPCs) identified in soil, groundwater, and soil gas include gasoline-range petroleum hydrocarbons. Specific COPCs, maximum concentrations, and Environmental Screening Levels for residential land use are summarized as follows:

COPC	Soil (mg/kg)		GW (ug/L)		Soil Gas (ug/m ³)	
	Max Conc.	ESL	Max Conc.	ESL	Max Conc.	ESL
TPHg	690	740	42,000	NL	2,700,000	NL
B	2.4	0.23	110	30	450	48
T	24	970	540	100,000	210	160,000
E	17	5.1	2,600	370	360	560
X	94	560	4,800	38,000	1,100	52,000
N	NA	33	2,300	180	<530	41
Methane					23%	5-15% (LEL) >15% (UEL)

TPHg = Total Petroleum Hydrocarbons as Gasoline
 B = Benzene
 T = Toluene
 E = Ethylbenzene
 X = Xylenes
 N = Naphthalene
 mg/kg = Milligrams per kilogram
 ug/L = Micrograms per liter
 ug/m³ = Micrograms per cubic meter
 Max. Conc. = Maximum concentration
 NA = Not analyzed for this analyte
 ESL = Environmental Screening Level (San Francisco Bay Regional Water Quality Control Board, February 2016)

Soil = Table S-1, Soil Direct Exposure (residential)/Leaching to Groundwater;
 Groundwater = Table GW-4, Groundwater Vapor Intrusion (deep, fine-course, residential);
 Soil Gas = Table SG-1, Subslab/Soil Gas Vapor Intrusion (residential)
 (A) = Direct Exposure ESL/Leaching to Groundwater ESL
 NL = Not listed.
 <530 = Not detected above the expressed value.
 Shaded = Exceeds ESL.

As summarized above, maximum soil concentrations for benzene and ethylbenzene exceed direct exposure ESLs; however, as summarized in Section 8.1, soil direct exposure is limited to the construction worker scenario and the exposure risk is expected to be low due to the lack of shallow soil impacts.

Groundwater concentrations for benzene, ethylbenzene, and naphthalene exceed the residential vapor intrusion ESL for deep groundwater and fine-course soils. However, the groundwater sample with ESL exceedances (GW-1) was collected at the same location as a soil gas sample (SG-1) with hydrocarbon concentrations that did not exceed vapor intrusion ESLs. Since the groundwater ESLs for vapor intrusion rely on a greater number of risk model assumptions (default depth to water, soil permeability, etc.), it is more than likely that soil gas sample results provide a more accurate measure of vapor intrusion risk than the groundwater-to-vapor-intrusion ESLs.

The maximum soil gas concentration for benzene exceeds the residential vapor intrusion ESL, and the maximum methane concentration exceeds both the lower explosive limit (LEL) and the upper explosive limit (UEL). However, as noted in Section 8.1, the planned SSDS mitigative measures will reduce risk relative to these potential issues of concern. Note that the respective soil gas TPHg concentrations for SG-1, SG-2, and SG-3 of 150,000 ug/m³, 1,900,000 ug/m³, and 2,700,000 ug/m³ are above the soil gas odor nuisance ESL of 50,000 ug/m³. However, these odor nuisance concerns will be adequately addressed by the planned SSDS mitigative measures.

8.3 Quantitative Risk Analysis

Quantitative, site-specific risk analyses were conducted using two methods: (1) Risk modelling using soil gas data; and (2) Risk modelling using groundwater data. These calculations were accomplished using California Department of Toxic Substances Control (DTSC), Office of Human and Ecological Risk Office (HERO) “Screening-Level Model for Soil Gas Contamination” (updated December 2014), and “Screening-Level Model for Groundwater Contamination” (updated December 2014). These spreadsheet models were used in conjunction with DTSC’s “Guidance for Evaluation & Mitigation of Subsurface Vapor Intrusion to Indoor Air” (October 2011) and USEPA’s “User’s Guide for Evaluating Subsurface Vapor Intrusion into Buildings” (February 2004). Standard and site-specific models parameters used for both models are included in Table 5. Model risk analyses are presented in the following sections:

8.3.1 Risk Analysis Using Soil Gas Data

8.3.2 Risk Analysis Using Groundwater Data

As previously noted in this report, it is likely that risk analysis using Site soil gas data model, rather than groundwater data, will provide a more accurate measure of vapor intrusion risk due to the smaller number of assumptions used in the soil gas data risk model.

Note also that the risk analyses reported herein were conducted assuming no SSDS mitigative measures. The planned SSDS mitigative measures will be designed by qualified professionals to sufficiently mitigate any and all potential vapor intrusion to indoor air risks reported herein.

8.3.1 Risk Analysis Using Soil Gas Data

The HERO soil gas and groundwater vapor intrusion models represent DTSC’s versions of a USEPA vapor intrusion spreadsheet model that incorporated the Johnson and Ettinger (J&E) model (1991) and added a human health risk component which allowed for the calculation of risk associated with inhalation of specific contaminants. For the HERO soil gas spreadsheet model, the following most elevated concentrations for each COPC input values were entered. The Model input parameters and backup calculations for every COPC are enclosed in Tab Number 1:

- Chemicals modeled: BTEX (naphthalene soil gas = ND)
- Soil Gas Concentrations:
 - Benzene = 450 ug/m³ (SG-2)
 - Toluene = 210 ug/m³ (SG-1)
 - Ethylbenzene = 390 ug/m³ (SG-1)
 - Xylenes = 1,100 ug/m³ (SG-1)
- Depth below grade to bottom of enclosed space floor: 15 cm

- Vadose zone SCS soil type: CL (clay, based on soil boring logs)

Results of the **Soil Gas** to vapor intrusion model risk calculations are summarized in Table 6. Using the above input values, the total (additive) Excess Lifetime Cancer Risk (ELCR) and Hazard Index (HI) were:

- Residential Exposure Scenario: ELCR = 6.5×10^{-6} ; HI = **0.46**
- Commercial Exposure Scenario: ELCR = 7.0×10^{-7} ; HI = **0.53**,

These risk calculations would apply to both the at-grade portion of the planned Site residential building and the elevator pit area (at 15 feet bgs), since soil gas samples were collected beneath the elevator pit depth (SG-1 at about 16 feet bgs) and at about 5.5 (168 cm) feet below surface grade (SG-2 and SG-3).

8.3.2 Risk Analysis Using Groundwater Data

The HERO groundwater vapor intrusion model allows for the inputting of site-specific groundwater depths. Thus, since groundwater depths relative to the elevator pit depth and surface grade are different, separate model risk calculations were conducted for elevator pit receptors and for at-grade vapor intrusion receptors. For the HERO groundwater gas spreadsheet model, the following input values were entered:

- Chemicals modeled: Benzene, Ethylbenzene, Naphthalene which were in excess of their respective Residential ESL levels;
- Most elevated Groundwater Concentrations levels were selected:
 - Benzene = 110 ug/L (GW-1)
 - Ethylbenzene = 2,600 ug/L (GW-1)
 - Naphthalene = 2,300 ug/L (GW-1)
- Depth below grade to bottom of enclosed space floor: 15 cm
- Depth below grade to water table: Elevator Pit = 91 cm (3 feet); At Grade = 518 cm (17 feet)
- Vadose zone SCS soil type: CL (clay, based on soil boring logs)

Results of the groundwater to vapor intrusion model risk calculations are summarized in Table 7. Using the above input values, the total (additive) Excess Lifetime Cancer Risk (ELCR) and Hazard Index (HI) for elevator pit receptors and at-grade receptors were:

- Residential Exposure Scenario-Elevator Pit Receptors: ELCR = 3.89×10^{-5} ; HI = **0.68**
- Residential Exposure Scenario-At Grade Receptors: ELCR = 3.6×10^{-5} ; HI = **0.61**,

8.3.3 *Model Uncertainties*

There is some uncertainty associated with estimating potential vapor intrusion to indoor air exposure risks using soil gas and/or groundwater data. Multiple factors contribute to uncertainty in the evaluations, as described below.

- The HERO vapor intrusion models do not account for biodegradation or any decrease in concentration over time and, therefore, the models are likely to overestimate potential risks for biodegradable petroleum hydrocarbons. During the sampling event, oxygen was detected in soil vapor samples from the Site at concentrations ranging from 0.76% to 11%. This, together with relatively low BTEX concentrations at the Site, would indicate the potential for significant bio-attenuation over time.
- In addition to biodegradation, several other factors such as an intact foundation and/or low-permeability soils may cause the vapor intrusion pathway to be incomplete.
- The HERO models makes several assumptions in estimating indoor air concentrations and exposure risks. For instance, the models assume homogeneous soils and homogeneous distribution of contaminants (in this case, maximum contaminant concentrations) over the entire area of concern. This is clearly not the case on the Site.
- The use of the maximum detected soil vapor concentrations as the EPCs for estimation of ELCR/HI is a conservative assumption, intended to represent the worst-case exposure scenario in which the maximum detected soil vapor concentration represents the homogeneous concentration in soil vapor.

9.0 CONCLUSIONS

In accordance with ACEH directives, ARS has completed this HHRA for the Site. The HHRA included:

- (1) A qualitative evaluation of potential exposure pathways;
- (2) A comparison of contaminants of potential concern (COPC) with appropriate regulatory screening levels; and
- (3) Calculation of site-specific risk levels based on Site COPC data.

The preliminary exposure pathway evaluation identified two potential exposure pathways relative to the planned residential development:

- Potential direct exposure to hydrocarbon-impacted soils during construction related activities; and
- Potential residential indoor air volatile hydrocarbon exposure for apartment building occupants.

Using these potential exposure pathways, maximum recent soil, groundwater, and soil gas concentrations were compared to appropriate Environmental Screening Levels (ESLs). For soil, maximum soil

concentrations for benzene and ethylbenzene exceed direct exposure ESLs; however, soil direct exposure is limited to the construction worker scenario and the exposure risk is expected to be low due to the lack of shallow soil impacts. For groundwater, maximum Site groundwater concentrations for benzene, ethylbenzene, and naphthalene exceed the residential vapor intrusion ESL for deep groundwater and fine-coarse soils; however, co-located soil gas samples, which are more accurate for vapor intrusion assessment, did not show concomitant hydrocarbon concentrations above vapor intrusion ESLs. For soil gas, the maximum soil gas concentration for benzene exceeds the residential vapor intrusion ESL, and the maximum methane concentration exceeds both the lower explosive limit (LEL) and the upper explosive limit (UEL). However, the planned SSDS mitigative measures will reduce risk relative to these potential adverse risks.

Quantitative, site-specific risk analyses were conducted using two methods: (1) Risk modelling using soil gas data; and (2) Risk modelling using groundwater data. These calculations were accomplished using California Department of Toxic Substances Control (DTSC), Human and Ecological Risk Office (HERO) “Screening-Level Model for Soil Gas Contamination” (updated December 2014), and “Screening-Level Model for Groundwater Contamination” (updated December 2014). Using site-specific parameters for maximum soil gas concentrations and site-specific soil type, the soil gas to vapor intrusion model yielded the following the total (additive) excess lifetime cancer risk (ELCR) and hazard index (HI) values:

- Residential Exposure Scenario: ELCR = 6.5×10^{-6} ; HI = **0.46**
- Commercial Exposure Scenario: ELCR = 7.0×10^{-7} ; HI = **0.53**,

These risk calculations would apply to both the at-grade portion of the planned Site residential building and the elevator pit area (at 15 feet bgs), since soil gas samples were collected beneath the elevator pit depth (SG-1 at about 16 feet bgs) and at about 5 feet below surface grade (SG-2 and SG-3).

The HERO groundwater vapor intrusion model allows for the inputting of site-specific groundwater depths. Thus, since groundwater depths relative to the elevator pit depth and surface grade are different, separate model risk calculations were conducted for the elevator pit and for at-grade vapor intrusion receptors. Using site-specific parameters for maximum groundwater concentrations, depths to groundwater, and soil type, the groundwater to vapor intrusion model yielded the following the total (additive) excess lifetime cancer risk (ELCR) and hazard index (HI) values for elevator pit receptors and at-grade receptors:

- Residential Exposure Scenario-Elevator Pit Receptors: ELCR = 3.89×10^{-5} ; HI = **0.68**;
- Residential Exposure Scenario-At Grade Receptors: ELCR = 3.6×10^{-5} ; HI = **0.61**;

The results of this quantitative vapor intrusion risk evaluation are based on the assumption that the soil gas and groundwater hydrocarbon concentrations will remain constant for the assumed exposure duration of 25 years, thus, likely overestimating the risk to planned building occupants.

Note that the risk analyses reported herein were conducted simply to show what the current residential land use might be in the absence of the planned SSDS mitigative measures. However, the planned SSDS mitigative measures will be designed by qualified licensed professional engineers to sufficiently mitigate any and all potential Volatile Organic Compounds (VOCs) vapor intrusion to indoor air risks relative to the planned residential development at the site.

10.0 RECOMMENDATIONS

Based on the findings and conclusions presented herein, as well as the uncertainties associated with the modeling, ARS, Inc. recommends that in order to mitigate the threat from future VOC vapor intrusion:

- Installation of a vapor barrier against VOCs beneath structural foundation members of the commercial area at the Site and the elevator pit area at the Site;
- Installation of a passive sub-slab depressurization and passive soil venting system, including collection pipes, and subsequent vapor sampling; and;
- Installation of an engineered exhaust fan system within the new garage to remove any fugitive emissions.

11.0 REFERENCES

San Francisco Regional Water Quality Control Board. Feb 2016 Update to Environmental Screening Levels. California Regional Water Quality Control Board, San Francisco Bay Region.

California Environmental Protection Agency. 2004. USEPA Advanced Version (3.1) of the Johnson and Ettinger Model. February 2004. Model adjusted to use Cal EPA DTSC's recommended input parameters (from Cal EPA 2011) and most updated toxicity information.

Final Guidance for the Evaluation and Mitigation of Subsurface Vapor Intrusion to Indoor Air (Vapor Intrusion Guidance). Department of Toxic Substances Control. October 2011.

Advisory – Active Soil Gas Investigations. Jointly issued by the Regional Water Quality Control Board, Los Angeles Region, San Francisco Region, and the Department of Toxic Substances Control. April 2012.

United States Environmental Protection Agency. 1991. *Role of the Baseline Risk Assessment in Superfund Remedy Selection Decisions*. USEPA OSWER Directive #9355.0-30. April.

Use of Monitored Natural Attenuation at Superfund, RCRA Corrective Action and Underground Storage Tank Sites. USEPA OSWER Directive 9200.4-17. Interim Final. December 1, 1997.

User's Guide for the Evaluating Subsurface Vapor Intrusion into Buildings. USEPA Office of Emergency and Remedial Response. Revised February 22, 2004.

Delta. 2009. *Site Investigation Report, 76 Service Station No. 1156, 4276 MacArthur Boulevard, Oakland, California*, dated September 8, 2009. Prepared for ConocoPhillips Company, 76 Broadway, Sacramento, California. Prepared by Delta Consultants, 11050 White Rock Road, Suite 110, Rancho Cordova, California, 95670.

AECOM 2013. *Report on Limited Site Assessment*, dated April 20, 2013. Submitted to ACEH.

Evaluation of Biogenic Methane, prepared by Department of Toxic Substances Control March 28, 2012a

TABLES

Department of Toxic Substances Control Vapor Intrusion Screening Model - Soil Gas

Scenario: Commercial
Chemical: Methylcyclohexane

DATA ENTRY SHEET

Reset to Defaults

Soil Gas Concentration Data		
ENTER	ENTER	ENTER
Chemical CAS No. (numbers only, no dashes)	Soil gas conc., C_g ($\mu\text{g}/\text{m}^3$)	OR Soil gas conc., C_n (ppmv)
Chemical		
108872	2.70E+06	Methylcyclohexane

Results Summary				
Soil Gas Conc. ($\mu\text{g}/\text{m}^3$)	Attenuation Factor (unitless)	Indoor Air Conc. ($\mu\text{g}/\text{m}^3$)	Cancer Risk	Noncancer Hazard
2.70E+06	5.9E-04	1.6E+03	NA	5.2E-01

MESSAGE: See VLOOKUP table comments on chemical properties and/or toxicity criteria for this chemical.

MORE
↓

ENTER	ENTER	ENTER	ENTER	ENTER
Depth below grade to bottom of enclosed space floor, L_f (15 or 200 cm)	Soil gas sampling depth below grade, L_s (cm)	Average soil temperature, T_s ($^{\circ}\text{C}$)	OR Vadose zone SCS soil type (used to estimate soil vapor permeability)	User-defined vadose zone soil vapor permeability, k_v (cm^2)
15	168	24		2.00E-02

MORE
↓

ENTER	ENTER	ENTER	ENTER	ENTER
Vadose zone SCS soil type Lookup Soil Parameters	Vadose zone soil dry bulk density, ρ_b^A (g/cm^3)	Vadose zone soil total porosity, n^V (unitless)	Vadose zone soil water-filled porosity, θ_w^V (cm^3/cm^3)	Average vapor flow rate into bldg. (Leave blank to calculate) Q_{soil} (L/m)
SCL	1.66	0.375	0.054	5

MORE
↓

Lookup Receptor Parameters

ENTER	ENTER	ENTER	ENTER	ENTER	ENTER
Averaging time for carcinogens, AT_C (yrs)	Averaging time for noncarcinogens, AT_{NC} (yrs)	Exposure duration, ED (yrs)	Exposure frequency, EF (days/yr)	Exposure Time ET (hrs/day)	Air Exchange Rate ACH (hour^{-1})
70	25	25	250	8 (NEW)	1 (NEW)

NEW=> Commercial

END

CHEMICAL PROPERTIES SHEET

Methylcyclohexane

Diffusivity in air, D_a (cm^2/s)	Diffusivity in water, D_w (cm^2/s)	Henry's law constant at reference temperature, H ($\text{atm}\cdot\text{m}^3/\text{mol}$)	Henry's law constant reference temperature, T_R ($^{\circ}\text{C}$)	Enthalpy of vaporization at the normal boiling point, $\Delta H_{v,b}$ (cal/mol)	Normal boiling point, T_B ($^{\circ}\text{K}$)	Critical temperature, T_C ($^{\circ}\text{K}$)	Unit risk factor, URF ($\mu\text{g}/\text{m}^3$) ⁻¹	Reference conc., RfC (mg/m^3)	Molecular weight, MW (g/mol)
7.35E-02	8.52E-06	1.03E-01	25	7,474	373.90	572.20	0.0E+00	7.0E-01	98.21

END

INTERMEDIATE CALCULATIONS SHEET

Scenario: Commercial

Chemical: Methylcyclohexane

Source-building separation, L_T (cm)	Vadose zone soil air-filled porosity, θ_a^V (cm^3/cm^3)	Vadose zone effective total fluid saturation, S_{te} (cm^3/cm^3)	Vadose zone soil intrinsic permeability, k_i (cm^2)	Vadose zone soil relative air permeability, k_{ra} (cm^2)	Vadose zone soil effective vapor permeability, k_v (cm^2)	Floor-wall seam perimeter, X_{crack} (cm)	Soil gas conc. ($\mu\text{g}/\text{m}^3$)	Bldg. ventilation rate, $Q_{building}$ (cm^3/s)
153	0.321	#N/A	#N/A	#N/A	2.00E-02	4,000	2.70E+06	6.78E+04

Area of enclosed space below grade, A_B (cm^2)	Crack-to-total area ratio, η (unitless)	Crack depth below grade, Z_{crack} (cm)	Enthalpy of vaporization at ave. soil temperature, $\Delta H_{v,TS}$ (cal/mol)	Henry's law constant at ave. soil temperature, H_{TS} (atm- m^3/mol)	Henry's law constant at ave. soil temperature, H'_{TS} (unitless)	Vapor viscosity at ave. soil temperature, μ_{TS} (g/cm-s)	Vadose zone effective diffusion coefficient, D_v^{eff} (cm^2/s)	Diffusion path length, L_d (cm)
1.00E+06	5.00E-03	15	8,428	9.80E-02	4.02E+00	1.80E-04	1.19E-02	153

Convection path length, L_p (cm)	Source vapor conc., C_{source} ($\mu\text{g}/\text{m}^3$)	Crack radius, r_{crack} (cm)	Average vapor flow rate into bldg., Q_{soil} (cm^3/s)	Crack effective diffusion coefficient, D^{crack} (cm^2/s)	Area of crack, A_{crack} (cm^2)	Exponent of equivalent foundation Peclet number, $\exp(\text{Pe}^f)$ (unitless)	Infinite source indoor attenuation coefficient, α (unitless)	Infinite source bldg. conc., $C_{building}$ ($\mu\text{g}/\text{m}^3$)
15	2.70E+06	1.25	8.33E+01	1.19E-02	5.00E+03	1.24E+06	5.93E-04	1.60E+03

Unit risk factor, URF ($\mu\text{g}/\text{m}^3$) ⁻¹	Reference conc., RfC (mg/m^3)
------------------------------------------------------------------	-------------------------------------------------

NA	7.0E-01
----	---------

END

RESULTS SHEET

Scenario: Commercial
Chemical: Methylcyclohexane

INCREMENTAL RISK CALCULATIONS:

Incremental risk from vapor intrusion to indoor air, carcinogen (unitless)	Hazard quotient from vapor intrusion to indoor air, noncarcinogen (unitless)
NA	5.2E-01

MESSAGE SUMMARY BELOW:

END

**Alternate Surrogates For Gasoline
(n-Pentane & Hexane)**

RESULTS SHEET

Scenario: Commercial
Chemical: Pentane, n-

INCREMENTAL RISK CALCULATIONS:

Incremental risk from vapor intrusion to indoor air, carcinogen (unitless)	Hazard quotient from vapor intrusion to indoor air, noncarcinogen (unitless)
NA	3.9E-01

MESSAGE SUMMARY BELOW:

END

Department of Toxic Substances Control Vapor Intrusion Screening Model - Soil Gas

Scenario: Commercial
Chemical: Pentane, n-

DATA ENTRY SHEET

Reset to Defaults

Soil Gas Concentration Data

ENTER Chemical CAS No. (numbers only, no dashes)	ENTER Soil gas conc., C_G ($\mu\text{g}/\text{m}^3$)	OR	ENTER Soil gas conc., C_G (ppmv)	Chemical
109660	2.70E+06			Pentane, n-

Results Summary				
Soil Gas Conc. ($\mu\text{g}/\text{m}^3$)	Attenuation Factor (unitless)	Indoor Air Conc. ($\mu\text{g}/\text{m}^3$)	Cancer Risk	Noncancer Hazard
2.70E+06	6.3E-04	1.7E+03	NA	3.9E-01

MORE ↓

ENTER Depth below grade to bottom of enclosed space floor, L_F (15 or 200 cm)	ENTER Soil gas sampling depth below grade, L_S (cm)	ENTER Average soil temperature, T_S ($^{\circ}\text{C}$)	ENTER Vadose zone SCS soil type (used to estimate soil vapor permeability)	OR	ENTER User-defined vadose zone soil vapor permeability, k_v (cm^2)
15	168	16.67			2.00E-02

MORE ↓

ENTER Vadose zone SCS soil type <small>Lookup Soil Parameters</small>	ENTER Vadose zone soil dry bulk density, ρ_b^A (g/cm^3)	ENTER Vadose zone soil total porosity, n^V (unitless)	ENTER Vadose zone soil water-filled porosity, θ_w^V (cm^3/cm^3)	ENTER Average vapor flow rate into bldg. (Leave blank to calculate) Q_{soil} (L/m)
CL	1.66	0.375	0.054	5

MORE ↓

Lookup Receptor Parameters

ENTER Averaging time for carcinogens, AT_C (yrs)	ENTER Averaging time for noncarcinogens, AT_{NC} (yrs)	ENTER Exposure duration, ED (yrs)	ENTER Exposure frequency, EF (days/yr)	ENTER Exposure Time, ET (hrs/day)	ENTER Air Exchange Rate, ACH (hour^{-1})
70	25	25	250	8	1

NEW=> Commercial

END

(NEW) (NEW)

CHEMICAL PROPERTIES SHEET

Pentane, n-

Diffusivity in air, D_a (cm^2/s)	Diffusivity in water, D_w (cm^2/s)	Henry's law constant at reference temperature, H ($\text{atm}\cdot\text{m}^3/\text{mol}$)	Henry's law constant reference temperature, T_R ($^\circ\text{C}$)	Enthalpy of vaporization at the normal boiling point, $\Delta H_{v,b}$ (cal/mol)	Normal boiling point, T_B ($^\circ\text{K}$)	Critical temperature, T_C ($^\circ\text{K}$)	Unit risk factor, URF ($\mu\text{g}/\text{m}^3$) ⁻¹	Reference conc., RfC (mg/m^3)	Molecular weight, MW (g/mol)
8.21E-02	8.80E-06	1.25E+00	25	6,155	309.00	469.70	0.0E+00	1.0E+00	72.15

END

INTERMEDIATE CALCULATIONS SHEET

Scenario: Commercial
 Chemical: Pentane, n-

Source-building separation, L_T (cm)	Vadose zone soil air-filled porosity, θ_a^V (cm^3/cm^3)	Vadose zone effective total fluid saturation, S_{te} (cm^3/cm^3)	Vadose zone soil intrinsic permeability, k_i (cm^2)	Vadose zone soil relative air permeability, k_{rq} (cm^2)	Vadose zone soil effective vapor permeability, k_v (cm^2)	Floor-wall seam perimeter, X_{crack} (cm)	Soil gas conc. ($\mu\text{g}/\text{m}^3$)	Bldg. ventilation rate, $Q_{building}$ (cm^3/s)
153	0.321	#N/A	#N/A	#N/A	2.00E-02	4,000	2.70E+06	6.78E+04

Area of enclosed space below grade, A_B (cm^2)	Crack-to-total area ratio, η (unitless)	Crack depth below grade, Z_{crack} (cm)	Enthalpy of vaporization at ave. soil temperature, $\Delta H_{v,TS}$ (cal/mol)	Henry's law constant at ave. soil temperature, H_{TS} ($\text{atm}\cdot\text{m}^3/\text{mol}$)	Henry's law constant at ave. soil temperature, H'_{TS} (unitless)	Vapor viscosity at ave. soil temperature, μ_{TS} (g/cm-s)	Vadose zone effective diffusion coefficient, D_V^{eff} (cm^2/s)	Diffusion path length, L_d (cm)
1.00E+06	5.00E-03	15	6,418	9.16E-01	3.85E+01	1.77E-04	1.33E-02	153

Convection path length, L_p (cm)	Source vapor conc., C_{source} ($\mu\text{g}/\text{m}^3$)	Crack radius, r_{crack} (cm)	Average vapor flow rate into bldg., Q_{soil} (cm^3/s)	Crack effective diffusion coefficient, D^{crack} (cm^2/s)	Area of crack, A_{crack} (cm^2)	Exponent of equivalent foundation Peclet number, $\exp(\text{Pe}^f)$ (unitless)	Infinite source indoor attenuation coefficient, α (unitless)	Infinite source bldg. conc., $C_{building}$ ($\mu\text{g}/\text{m}^3$)
15	2.70E+06	1.25	8.33E+01	1.33E-02	5.00E+03	2.83E+05	6.27E-04	1.69E+03

Unit risk factor, URF ($\mu\text{g}/\text{m}^3$) ⁻¹	Reference conc., RfC (mg/m^3)
NA	1.0E+00

END

RESULTS SHEET

Scenario: Commercial
Chemical: Hexane

INCREMENTAL RISK CALCULATIONS:

Incremental risk from vapor intrusion to indoor air, carcinogen (unitless)	Hazard quotient from vapor intrusion to indoor air, noncarcinogen (unitless)
NA	5.2E-01

MESSAGE SUMMARY BELOW:

END

Department of Toxic Substances Control Vapor Intrusion Screening Model - Soil Gas

Scenario: Commercial
Chemical: Hexane

DATA ENTRY SHEET

Reset to Defaults

Soil Gas Concentration Data

ENTER	ENTER	OR	ENTER	
Chemical CAS No. (numbers only, no dashes)	Soil gas conc., C_a ($\mu\text{g}/\text{m}^3$)		Soil gas conc., C_a (ppmv)	Chemical
110543	2.70E+06			Hexane

Results Summary				
Soil Gas Conc. ($\mu\text{g}/\text{m}^3$)	Attenuation Factor (unitless)	Indoor Air Conc. ($\mu\text{g}/\text{m}^3$)	Cancer Risk	Noncancer Hazard
2.70E+06	5.9E-04	1.6E+03	NA	5.2E-01

MORE ↓

ENTER	ENTER	ENTER	ENTER	OR	ENTER
Depth below grade to bottom of enclosed space floor, L_F (15 or 200 cm)	Soil gas sampling depth below grade, L_S (cm)	Average soil temperature, T_S ($^{\circ}\text{C}$)	Vadose zone SCS soil type (used to estimate soil vapor permeability)		User-defined vadose zone soil vapor permeability, k_v (cm^2)
15	168	16.67			2.00E-02

MORE ↓

ENTER	ENTER	ENTER	ENTER	ENTER
Vadose zone SCS soil type <small>Lookup Soil Parameters</small>	Vadose zone soil dry bulk density, ρ_b^A (g/cm^3)	Vadose zone soil total porosity, n^V (unitless)	Vadose zone soil water-filled porosity, θ_w^V (cm^3/cm^3)	Average vapor flow rate into bldg. (Leave blank to calculate) Q_{soil} (L/m)
CL	1.66	0.375	0.054	5

MORE ↓

Lookup Receptor Parameters

ENTER	ENTER	ENTER	ENTER	ENTER	ENTER
Averaging time for carcinogens, AT_C (yrs)	Averaging time for noncarcinogens, AT_{NC} (yrs)	Exposure duration, ED (yrs)	Exposure frequency, EF (days/yr)	Exposure Time, ET (hrs/day)	Air Exchange Rate, ACH (hour^{-1})
70	25	25	250	8 (NEW)	1 (NEW)

END

NEW=> Commercial

CHEMICAL PROPERTIES SHEET

Hexane

Diffusivity in air, D_a (cm^2/s)	Diffusivity in water, D_w (cm^2/s)	Henry's law constant at reference temperature, H ($\text{atm}\cdot\text{m}^3/\text{mol}$)	Henry's law constant reference temperature, T_R ($^{\circ}\text{C}$)	Enthalpy of vaporization at the normal boiling point, $\Delta H_{v,b}$ (cal/mol)	Normal boiling point, T_B ($^{\circ}\text{K}$)	Critical temperature, T_C ($^{\circ}\text{K}$)	Unit risk factor, URF ($\mu\text{g}/\text{m}^3$) ⁻¹	Reference conc., RfC (mg/m^3)	Molecular weight, MW (g/mol)
7.31E-02	8.17E-06	1.80E+00	25	6,895	341.70	508.00	0.0E+00	7.0E-01	86.18

END

INTERMEDIATE CALCULATIONS SHEET

Scenario: **Commercial**

Chemical: **Hexane**

Source-building separation, L_T (cm)	Vadose zone soil air-filled porosity, θ_a^V (cm^3/cm^3)	Vadose zone effective total fluid saturation, S_{te} (cm^3/cm^3)	Vadose zone soil intrinsic permeability, k_i (cm^2)	Vadose zone soil relative air permeability, $k_{r,q}$ (cm^2)	Vadose zone soil effective vapor permeability, k_v (cm^2)	Floor-wall seam perimeter, X_{crack} (cm)	Soil gas conc. ($\mu\text{g}/\text{m}^3$)	Bldg. ventilation rate, $Q_{building}$ (cm^3/s)
153	0.321	#N/A	#N/A	#N/A	2.00E-02	4,000	2.70E+06	6.78E+04

Area of enclosed space below grade, A_B (cm^2)	Crack-to-total area ratio, η (unitless)	Crack depth below grade, Z_{crack} (cm)	Enthalpy of vaporization at ave. soil temperature, $\Delta H_{v,TS}$ (cal/mol)	Henry's law constant at ave. soil temperature, H_{TS} (atm- m^3/mol)	Henry's law constant at ave. soil temperature, H'_{TS} (unitless)	Vapor viscosity at ave. soil temperature, μ_{TS} (g/cm-s)	Vadose zone effective diffusion coefficient, D_V^{eff} (cm^2/s)	Diffusion path length, L_d (cm)
1.00E+06	5.00E-03	15	7,648	1.24E+00	5.22E+01	1.77E-04	1.18E-02	153

Convection path length, L_p (cm)	Source vapor conc., C_{source} ($\mu\text{g}/\text{m}^3$)	Crack radius, r_{crack} (cm)	Average vapor flow rate into bldg., Q_{soil} (cm^3/s)	Crack effective diffusion coefficient, D^{crack} (cm^2/s)	Area of crack, A_{crack} (cm^2)	Exponent of equivalent foundation Peclet number, $\exp(Pe^f)$ (unitless)	Infinite source indoor attenuation coefficient, α (unitless)	Infinite source bldg. conc., $C_{building}$ ($\mu\text{g}/\text{m}^3$)
15	2.70E+06	1.25	8.33E+01	1.18E-02	5.00E+03	1.33E+06	5.91E-04	1.60E+03

Unit risk factor, URF ($\mu\text{g}/\text{m}^3$) ⁻¹	Reference conc., RfC (mg/m^3)
NA	7.0E-01

END

Department of Toxic Substances Control Vapor Intrusion Screening Model - Soil Gas

Scenario: Commercial
Chemical: Benzene

DATA ENTRY SHEET

Reset to Defaults

Soil Gas Concentration Data				
ENTER	ENTER	OR	ENTER	Chemical
Chemical CAS No. (numbers only, no dashes)	Soil gas conc., C_g ($\mu\text{g}/\text{m}^3$)		Soil gas conc., C_g (ppmv)	
71432	4.50E+02			Benzene

Results Summary				
Soil Gas Conc. ($\mu\text{g}/\text{m}^3$)	Attenuation Factor (unitless)	Indoor Air Conc. ($\mu\text{g}/\text{m}^3$)	Cancer Risk	Noncancer Hazard
4.50E+02	6.5E-04	2.9E-01	7.0E-07	2.2E-02

MESSAGE: See VLOOKUP table comments on chemical properties and/or toxicity criteria for this chemical.

MORE
↓

ENTER	ENTER	ENTER	ENTER	OR	ENTER
Depth below grade to bottom of enclosed space floor, L_f (15 or 200 cm)	Soil gas sampling depth below grade, L_s (cm)	Average soil temperature, T_s ($^{\circ}\text{C}$)	Vadose zone SCS soil type (used to estimate soil vapor permeability)		User-defined vadose zone soil vapor permeability, k_v (cm^2)
15	168	16.67			2.00E-02

MORE
↓

ENTER	ENTER	ENTER	ENTER	ENTER
Vadose zone SCS soil type <small>Lookup Soil Parameters</small>	Vadose zone soil dry bulk density, ρ_b^A (g/cm^3)	Vadose zone soil total porosity, n^V (unitless)	Vadose zone soil water-filled porosity, θ_w^V (cm^3/cm^3)	Average vapor flow rate into bldg. (Leave blank to calculate) Q_{soil} (L/m)
CL	1.66	0.375	0.054	5

MORE
↓

Lookup Receptor Parameters

ENTER	ENTER	ENTER	ENTER	ENTER	ENTER
Averaging time for carcinogens, AT_C (yrs)	Averaging time for noncarcinogens, AT_{NC} (yrs)	Exposure duration, ED (yrs)	Exposure frequency, EF (days/yr)	Exposure Time, ET (hrs/day)	Air Exchange Rate, ACH (hour^{-1})
70	25	25	250	8 <small>(NEW)</small>	1 <small>(NEW)</small>

EW=> Commercial

END

CHEMICAL PROPERTIES SHEET

Benzene

Diffusivity in air, D_a (cm^2/s)	Diffusivity in water, D_w (cm^2/s)	Henry's law constant at reference temperature, H ($\text{atm}\cdot\text{m}^3/\text{mol}$)	Henry's law constant reference temperature, T_R ($^\circ\text{C}$)	Enthalpy of vaporization at the normal boiling point, $\Delta H_{v,b}$ (cal/mol)	Normal boiling point, T_B ($^\circ\text{K}$)	Critical temperature, T_C ($^\circ\text{K}$)	Unit risk factor, URF ($\mu\text{g}/\text{m}^3$) ⁻¹	Reference conc., RfC (mg/m^3)	Molecular weight, MW (g/mol)
8.95E-02	1.03E-05	5.55E-03	25	7,342	353.24	562.16	2.9E-05	3.0E-03	78.11

END

INTERMEDIATE CALCULATIONS SHEET

Scenario: Commercial

Chemical: Benzene

Source-building separation, L_T (cm)	Vadose zone soil air-filled porosity, θ_a^V (cm ³ /cm ³)	Vadose zone effective total fluid saturation, S_{fe} (cm ³ /cm ³)	Vadose zone soil intrinsic permeability, k_i (cm ²)	Vadose zone soil relative air permeability, k_{rg} (cm ²)	Vadose zone soil effective vapor permeability, k_v (cm ²)	Floor-wall seam perimeter, X_{crack} (cm)	Soil gas conc., ($\mu\text{g}/\text{m}^3$)	Bldg. ventilation rate, $Q_{building}$ (cm ³ /s)
153	0.321	#N/A	#N/A	#N/A	2.00E-02	4,000	4.50E+02	6.78E+04

Area of enclosed space below grade, A_B (cm ²)	Crack-to-total area ratio, η (unitless)	Crack depth below grade, Z_{crack} (cm)	Enthalpy of vaporization at ave. soil temperature, $\Delta H_{v,TS}$ (cal/mol)	Henry's law constant at ave. soil temperature, H_{TS} (atm-m ³ /mol)	Henry's law constant at ave. soil temperature, H'_{TS} (unitless)	Vapor viscosity at ave. soil temperature, μ_{TS} (g/cm-s)	Vadose zone effective diffusion coefficient, D_v^{eff} (cm ² /s)	Diffusion path length, L_d (cm)
1.00E+06	5.00E-03	15	8,054	3.76E-03	1.58E-01	1.77E-04	1.45E-02	153

Convection path length, L_p (cm)	Source vapor conc., C_{source} ($\mu\text{g}/\text{m}^3$)	Crack radius, r_{crack} (cm)	Average vapor flow rate into bldg., Q_{soil} (cm ³ /s)	Crack effective diffusion coefficient, D^{crack} (cm ² /s)	Area of crack, A_{crack} (cm ²)	Exponent of equivalent foundation Peclet number, $\exp(\text{Pe}^f)$ (unitless)	Infinite source indoor attenuation coefficient, α (unitless)	Infinite source bldg. conc., $C_{building}$ ($\mu\text{g}/\text{m}^3$)
15	4.50E+02	1.25	8.33E+01	1.45E-02	5.00E+03	1.00E+05	6.54E-04	2.94E-01

Unit risk factor, URF ($\mu\text{g}/\text{m}^3$) ⁻¹	Reference conc., RfC (mg/m ³)
2.9E-05	3.0E-03

END

RESULTS SHEET

Scenario: Commercial
Chemical: Benzene

INCREMENTAL RISK CALCULATIONS:

Incremental risk from vapor intrusion to indoor air, carcinogen (unitless)	Hazard quotient from vapor intrusion to indoor air, noncarcinogen (unitless)
7.0E-07	2.2E-02

MESSAGE SUMMARY BELOW:

END

Vapor Intrusion Screening Model - Soil Gas

DATA ENTRY SHEET

Scenario: Residential
Chemical: Benzene

Reset to Defaults

Soil Gas Concentration Data

ENTER Chemical CAS No. (numbers only, no dashes)	ENTER Soil gas conc., C_a ($\mu\text{g}/\text{m}^3$)	OR	ENTER Soil gas conc., C_g (ppmv)	Chemical
71432	4.50E+02			Benzene

Results Summary				
Soil Gas Conc. ($\mu\text{g}/\text{m}^3$)	Attenuation Factor (unitless)	Indoor Air Conc. ($\mu\text{g}/\text{m}^3$)	Cancer Risk	Noncancer Hazard
4.50E+02	1.3E-03	5.9E-01	6.1E-06	1.9E-01

MESSAGE: See VLOOKUP table comments on chemical properties and/or toxicity criteria for this chemical.

MORE
↓

ENTER Depth below grade to bottom of enclosed space floor, L_f (15 or 200 cm)	ENTER Soil gas sampling depth below grade, L_s (cm)	ENTER Average soil temperature, T_s ($^{\circ}\text{C}$)	ENTER Vadose zone SCS soil type (used to estimate soil vapor permeability)	OR	ENTER User-defined vadose zone soil vapor permeability, k_v (cm^2)
15	168	16.67			2.00E-02

MORE
↓

ENTER Vadose zone SCS soil type Lookup Soil Parameters	ENTER Vadose zone soil dry bulk density, ρ_b^A (g/cm^3)	ENTER Vadose zone soil total porosity, n^V (unitless)	ENTER Vadose zone soil water-filled porosity, θ_w^V (cm^3/cm^3)	ENTER Average vapor flow rate into bldg. (Leave blank to calculate) Q_{soil} (L/m)
SCL	1.66	0.375	0.054	5

MORE
↓

Lookup Receptor
Parameters

ENTER Averaging time for carcinogens, AT_C (yrs)	ENTER Averaging time for noncarcinogens, AT_{NC} (yrs)	ENTER Exposure duration, ED (yrs)	ENTER Exposure frequency, EF (days/yr)	ENTER Exposure Time ET (hrs/day)	ENTER Air Exchange Rate ACH (hour^{-1})
70	26	26	350	24 (NEW)	0.5 (NEW)

NEW=> Residential

END

CHEMICAL PROPERTIES SHEET

Benzene

Diffusivity in air, D_a (cm^2/s)	Diffusivity in water, D_w (cm^2/s)	Henry's law constant at reference temperature, H ($\text{atm}\cdot\text{m}^3/\text{mol}$)	Henry's law constant reference temperature, T_R ($^{\circ}\text{C}$)	Enthalpy of vaporization at the normal boiling point, $\Delta H_{v,b}$ (cal/mol)	Normal boiling point, T_B ($^{\circ}\text{K}$)	Critical temperature, T_C ($^{\circ}\text{K}$)	Unit risk factor, URF ($\mu\text{g}/\text{m}^3$) ⁻¹	Reference conc., RfC (mg/m^3)	Molecular weight, MW (g/mol)
8.95E-02	1.03E-05	5.55E-03	25	7,342	353.24	562.16	2.9E-05	3.0E-03	78.11

END

INTERMEDIATE CALCULATIONS SHEET

Scenario: Residential

Chemical: Benzene

Source-building separation, L_T (cm)	Vadose zone soil air-filled porosity, θ_a^V (cm ³ /cm ³)	Vadose zone effective total fluid saturation, S_{te} (cm ³ /cm ³)	Vadose zone soil intrinsic permeability, k_i (cm ²)	Vadose zone soil relative air permeability, k_{rg} (cm ²)	Vadose zone soil effective vapor permeability, k_v (cm ²)	Floor-wall seam perimeter, X_{crack} (cm)	Soil gas conc., (μg/m ³)	Bldg. ventilation rate, $Q_{building}$ (cm ³ /s)
153	0.321	#N/A	#N/A	#N/A	2.00E-02	4,000	4.50E+02	3.39E+04

Area of enclosed space below grade, A_B (cm ²)	Crack-to-total area ratio, η (unitless)	Crack depth below grade, Z_{crack} (cm)	Enthalpy of vaporization at ave. soil temperature, $\Delta H_{v,TS}$ (cal/mol)	Henry's law constant at ave. soil temperature, H_{TS} (atm-m ³ /mol)	Henry's law constant at ave. soil temperature, H'_{TS} (unitless)	Vapor viscosity at ave. soil temperature, μ_{TS} (g/cm-s)	Vadose zone effective diffusion coefficient, D_v^{eff} (cm ² /s)	Diffusion path length, L_d (cm)
1.00E+06	5.00E-03	15	8,054	3.76E-03	1.58E-01	1.77E-04	1.45E-02	153

Convection path length, L_p (cm)	Source vapor conc., C_{source} (μg/m ³)	Crack radius, r_{crack} (cm)	Average vapor flow rate into bldg., Q_{soil} (cm ³ /s)	Crack effective diffusion coefficient, D^{crack} (cm ² /s)	Area of crack, A_{crack} (cm ²)	Exponent of equivalent foundation Peclet number, $exp(Pe^f)$ (unitless)	Infinite source indoor attenuation coefficient, α (unitless)	Infinite source bldg. conc., $C_{building}$ (μg/m ³)
15	4.50E+02	1.25	8.33E+01	1.45E-02	5.00E+03	1.00E+05	1.31E-03	5.88E-01

Unit risk factor, URF (μg/m ³) ⁻¹	Reference conc., RfC (mg/m ³)
2.9E-05	3.0E-03

END

RESULTS SHEET

Scenario: Residential
Chemical: Benzene

INCREMENTAL RISK CALCULATIONS:

Incremental risk from vapor intrusion to indoor air, carcinogen (unitless)	Hazard quotient from vapor intrusion to indoor air, noncarcinogen (unitless)
6.1E-06	1.9E-01

MESSAGE SUMMARY BELOW:

END

Department of Toxic Substances Control Vapor Intrusion Screening Model - Soil Gas

Scenario: Residential
Chemical: Ethylbenzene

DATA ENTRY SHEET

Reset to Defaults

Soil Gas Concentration Data				
ENTER	ENTER	OR	ENTER	Chemical
Chemical CAS No. (numbers only, no dashes)	Soil gas conc., C_a ($\mu\text{g}/\text{m}^3$)		Soil gas conc., C_a (ppmv)	
100414	3.90E+02			Ethylbenzene

Results Summary				
Soil Gas Conc. ($\mu\text{g}/\text{m}^3$)	Attenuation Factor (unitless)	Indoor Air Conc. ($\mu\text{g}/\text{m}^3$)	Cancer Risk	Noncancer Hazard
3.90E+02	1.1E-03	4.5E-01	4.0E-07	4.3E-04

MORE
↓

ENTER	ENTER	ENTER	OR	ENTER
Depth below grade to bottom of enclosed space floor, L_f (15 or 200 cm)	Soil gas sampling depth below grade, L_s (cm)	Average soil temperature, T_s ($^{\circ}\text{C}$)	Vadose zone SCS soil type (used to estimate soil vapor permeability)	User-defined vadose zone soil vapor permeability, k_v (cm^2)
15	168	16.67		2.00E-02

MORE
↓

ENTER	ENTER	ENTER	ENTER	ENTER
Vadose zone SCS soil type Lookup Soil Parameters	Vadose zone soil dry bulk density, ρ_b^A (g/cm^3)	Vadose zone soil total porosity, n^V (unitless)	Vadose zone soil water-filled porosity, θ_w^V (cm^3/cm^3)	Average vapor flow rate into bldg. (Leave blank to calculate) Q_{soil} (L/m)
CL	1.66	0.375	0.054	5

MORE
↓

Lookup Receptor Parameters

ENTER	ENTER	ENTER	ENTER	ENTER	ENTER
Averaging time for carcinogens, AT_C (yrs)	Averaging time for noncarcinogens, AT_{NC} (yrs)	Exposure duration, ED (yrs)	Exposure frequency, EF (days/yr)	Exposure Time ET (hrs/day)	Air Exchange Rate ACH (hour^{-1})
70	26	26	350	24 (NEW)	0.5 (NEW)

NEW=>

Residential

END

CHEMICAL PROPERTIES SHEET

Ethylbenzene

Diffusivity in air, D_a (cm^2/s)	Diffusivity in water, D_w (cm^2/s)	Henry's law constant at reference temperature, H ($\text{atm}\cdot\text{m}^3/\text{mol}$)	Henry's law constant reference temperature, T_R ($^\circ\text{C}$)	Enthalpy of vaporization at the normal boiling point, $\Delta H_{v,b}$ (cal/mol)	Normal boiling point, T_B ($^\circ\text{K}$)	Critical temperature, T_C ($^\circ\text{K}$)	Unit risk factor, URF ($\mu\text{g}/\text{m}^3$) ⁻¹	Reference conc., RfC (mg/m^3)	Molecular weight, MW (g/mol)
6.85E-02	8.46E-06	7.88E-03	25	8,501	409.34	617.20	2.5E-06	1.0E+00	106.17

END

INTERMEDIATE CALCULATIONS SHEET

Scenario: Residential
 Chemical: Ethylbenzene

Source-building separation, L_T (cm)	Vadose zone soil air-filled porosity, θ_a^v (cm ³ /cm ³)	Vadose zone effective total fluid saturation, S_{ie} (cm ³ /cm ³)	Vadose zone soil intrinsic permeability, k_f (cm ²)	Vadose zone soil relative air permeability, k_{rg} (cm ²)	Vadose zone soil effective vapor permeability, k_v (cm ²)	Floor-wall seam perimeter, X_{crack} (cm)	Soil gas conc., ($\mu\text{g}/\text{m}^3$)	Bldg. ventilation rate, $Q_{building}$ (cm ³ /s)
153	0.321	#N/A	#N/A	#N/A	2.00E-02	4,000	3.90E+02	3.39E+04

Area of enclosed space below grade, A_B (cm ²)	Crack-to-total area ratio, η (unitless)	Crack depth below grade, Z_{crack} (cm)	Enthalpy of vaporization at ave. soil temperature, $\Delta H_{v,TS}$ (cal/mol)	Henry's law constant at ave. soil temperature, H_{TS} (atm-m ³ /mol)	Henry's law constant at ave. soil temperature, H'_{TS} (unitless)	Vapor viscosity at ave. soil temperature, μ_{TS} (g/cm-s)	Vadose zone effective diffusion coefficient, D_v^{eff} (cm ² /s)	Diffusion path length, L_d (cm)
1.00E+06	5.00E-03	15	10,079	4.83E-03	2.03E-01	1.77E-04	1.11E-02	153

Convection path length, L_p (cm)	Source vapor conc., C_{source} ($\mu\text{g}/\text{m}^3$)	Crack radius, r_{crack} (cm)	Average vapor flow rate into bldg., Q_{soil} (cm ³ /s)	Crack effective diffusion coefficient, D^{crack} (cm ² /s)	Area of crack, A_{crack} (cm ²)	Exponent of equivalent foundation Peclet number, $\exp(Pe^f)$ (unitless)	Infinite source indoor attenuation coefficient, α (unitless)	Infinite source bldg. conc., $C_{building}$ ($\mu\text{g}/\text{m}^3$)
15	3.90E+02	1.25	8.33E+01	1.11E-02	5.00E+03	3.47E+06	1.14E-03	4.46E-01

Unit risk factor, URF ($\mu\text{g}/\text{m}^3$) ⁻¹	Reference conc., RfC (mg/m ³)
2.5E-06	1.0E+00

END

RESULTS SHEET

Scenario: Residential
Chemical: Ethylbenzene

INCREMENTAL RISK CALCULATIONS:

Incremental risk from vapor intrusion to indoor air, carcinogen (unitless)	Hazard quotient from vapor intrusion to indoor air, noncarcinogen (unitless)
4.0E-07	4.3E-04

MESSAGE SUMMARY BELOW:

END

Department of Toxic Substances Control Vapor Intrusion Screening Model - Soil Gas

Scenario: Residential
Chemical: Toluene

DATA ENTRY SHEET

Reset to Defaults

Soil Gas Concentration Data				
ENTER	ENTER	OR	ENTER	Chemical
Chemical CAS No. (numbers only, no dashes)	Soil gas conc., C_s ($\mu\text{g}/\text{m}^3$)		Soil gas conc., C_g (ppmv)	
108883	2.10E+02			Toluene

Results Summary				
Soil Gas Conc. ($\mu\text{g}/\text{m}^3$)	Attenuation Factor (unitless)	Indoor Air Conc. ($\mu\text{g}/\text{m}^3$)	Cancer Risk	Noncancer Hazard
2.10E+02	1.2E-03	2.6E-01	NA	8.2E-04

MORE
↓

ENTER	ENTER	ENTER	ENTER	OR	ENTER
Depth below grade to bottom of enclosed space floor, L_f (15 or 200 cm)	Soil gas sampling depth below grade, L_s (cm)	Average soil temperature, T_s ($^{\circ}\text{C}$)	Vadose zone SCS soil type (used to estimate soil vapor permeability)		User-defined vadose zone soil vapor permeability, k_v (cm^2)
15	168	16.67			2.00E-02

MORE
↓

ENTER	ENTER	ENTER	ENTER	ENTER
Vadose zone SCS soil type <small>Lookup Soil Parameters</small>	Vadose zone soil dry bulk density, ρ_b^A (g/cm^3)	Vadose zone soil total porosity, n^V (unitless)	Vadose zone soil water-filled porosity, θ_w^V (cm^3/cm^3)	Average vapor flow rate into bldg. (Leave blank to calculate) Q_{soil} (L/m)
CL	1.66	0.375	0.054	5

MORE
↓

Lookup Receptor Parameters

ENTER	ENTER	ENTER	ENTER	ENTER	ENTER
Averaging time for carcinogens, AT_C (yrs)	Averaging time for noncarcinogens, AT_{NC} (yrs)	Exposure duration, ED (yrs)	Exposure frequency, EF (days/yr)	Exposure Time, ET (hrs/day)	Air Exchange Rate, ACH (hour^{-1})
70	26	26	350	24 (NEW)	0.5 (NEW)

NEW=> Residential

END

CHEMICAL PROPERTIES SHEET

Toluene

Diffusivity in air, D_a (cm^2/s)	Diffusivity in water, D_w (cm^2/s)	Henry's law constant at reference temperature, H ($\text{atm}\cdot\text{m}^3/\text{mol}$)	Henry's law constant reference temperature, T_R ($^{\circ}\text{C}$)	Enthalpy of vaporization at the normal boiling point, $\Delta H_{v,b}$ (cal/mol)	Normal boiling point, T_B ($^{\circ}\text{K}$)	Critical temperature, T_C ($^{\circ}\text{K}$)	Unit risk factor, URF ($\mu\text{g}/\text{m}^3$) ⁻¹	Reference conc., RfC (mg/m^3)	Molecular weight, MW (g/mol)
7.78E-02	9.20E-06	6.64E-03	25	7,930	383.78	591.79	0.0E+00	3.0E-01	92.14

END

INTERMEDIATE CALCULATIONS SHEET

Scenario: Residential

Chemical: Toluene

Source-building separation, L_T (cm)	Vadose zone soil air-filled porosity, θ_a^v (cm ³ /cm ³)	Vadose zone effective total fluid saturation, S_{te} (cm ³ /cm ³)	Vadose zone soil intrinsic permeability, k_i (cm ²)	Vadose zone soil relative air permeability, k_{rg} (cm ²)	Vadose zone soil effective vapor permeability, k_v (cm ²)	Floor-wall seam perimeter, X_{crack} (cm)	Soil gas conc., ($\mu\text{g}/\text{m}^3$)	Bldg. ventilation rate, $Q_{building}$ (cm ³ /s)
153	0.321	#N/A	#N/A	#N/A	2.00E-02	4,000	2.10E+02	3.39E+04

Area of enclosed space below grade, A_B (cm ²)	Crack-to-total area ratio, η (unitless)	Crack depth below grade, Z_{crack} (cm)	Enthalpy of vaporization at ave. soil temperature, $\Delta H_{v,TS}$ (cal/mol)	Henry's law constant at ave. soil temperature, H_{TS} (atm-m ³ /mol)	Henry's law constant at ave. soil temperature, H'_{TS} (unitless)	Vapor viscosity at ave. soil temperature, μ_{TS} (g/cm-s)	Vadose zone effective diffusion coefficient, D_v^{eff} (cm ² /s)	Diffusion path length, L_d (cm)
1.00E+06	5.00E-03	15	9,082	4.27E-03	1.80E-01	1.77E-04	1.26E-02	153

Convection path length, L_p (cm)	Source vapor conc., C_{source} ($\mu\text{g}/\text{m}^3$)	Crack radius, r_{crack} (cm)	Average vapor flow rate into bldg., Q_{soil} (cm ³ /s)	Crack effective diffusion coefficient, D^{crack} (cm ² /s)	Area of crack, A_{crack} (cm ²)	Exponent of equivalent foundation Peclet number, $\exp(\text{Pe}^f)$ (unitless)	Infinite source indoor attenuation coefficient, α (unitless)	Infinite source bldg. conc., $C_{building}$ ($\mu\text{g}/\text{m}^3$)
15	2.10E+02	1.25	8.33E+01	1.26E-02	5.00E+03	5.69E+05	1.22E-03	2.56E-01

Unit risk factor, URF ($\mu\text{g}/\text{m}^3$) ⁻¹	Reference conc., RfC (mg/m ³)
NA	3.0E-01

END

RESULTS SHEET

Scenario: Residential
Chemical: Toluene

INCREMENTAL RISK CALCULATIONS:

Incremental risk from vapor intrusion to indoor air, carcinogen (unitless)	Hazard quotient from vapor intrusion to indoor air, noncarcinogen (unitless)
NA	8.2E-04

MESSAGE SUMMARY BELOW:

END

Department of Toxic Substances Control Vapor Intrusion Screening Model - Soil Gas

DATA ENTRY SHEET

Scenario: Residential
Chemical: o-Xylene

Reset to Defaults

Soil Gas Concentration Data

ENTER Chemical CAS No. (numbers only, no dashes)	ENTER Soil gas conc., C_g ($\mu\text{g}/\text{m}^3$)	OR	ENTER Soil gas conc., C_g (ppmv)	Chemical
95476	1.10E+03			o-Xylene

Results Summary				
Soil Gas Conc. ($\mu\text{g}/\text{m}^3$)	Attenuation Factor (unitless)	Indoor Air Conc. ($\mu\text{g}/\text{m}^3$)	Cancer Risk	Noncancer Hazard
1.10E+03	1.1E-03	1.3E+00	NA	1.2E-02

MORE
↓

ENTER Depth below grade to bottom of enclosed space floor, L_f (15 or 200 cm)	ENTER Soil gas sampling depth below grade, L_s (cm)	ENTER Average soil temperature, T_s ($^{\circ}\text{C}$)	ENTER Vadose zone SCS soil type (used to estimate soil vapor permeability)	OR	ENTER User-defined vadose zone soil vapor permeability, k_v (cm^2)
15	168	16.67			2.00E-02

MORE
↓

ENTER Vadose zone SCS soil type Lookup Soil Parameters	ENTER Vadose zone soil dry bulk density, ρ_b^A (g/cm^3)	ENTER Vadose zone soil total porosity, n^V (unitless)	ENTER Vadose zone soil water-filled porosity, θ_w^V (cm^3/cm^3)	ENTER Average vapor flow rate into bldg. (Leave blank to calculate) Q_{soil} (L/m)
CL	1.66	0.375	0.054	5

MORE
↓

Lookup Receptor
Parameters

ENTER Averaging time for carcinogens, AT_C (yrs)	ENTER Averaging time for noncarcinogens, AT_{NC} (yrs)	ENTER Exposure duration, ED (yrs)	ENTER Exposure frequency, EF (days/yr)	ENTER Exposure Time ET (hrs/day)	ENTER Air Exchange Rate ACH (hour^{-1})
70	26	26	350	24 (NEW)	0.5 (NEW)

NEW=> Residential

CHEMICAL PROPERTIES SHEET

o-Xylene

Diffusivity in air, D_a (cm^2/s)	Diffusivity in water, D_w (cm^2/s)	Henry's law constant at reference temperature, H ($\text{atm}\cdot\text{m}^3/\text{mol}$)	Henry's law constant reference temperature, T_R ($^\circ\text{C}$)	Enthalpy of vaporization at the normal boiling point, $\Delta H_{v,b}$ (cal/mol)	Normal boiling point, T_B ($^\circ\text{K}$)	Critical temperature, T_C ($^\circ\text{K}$)	Unit risk factor, URF ($\mu\text{g}/\text{m}^3$) ⁻¹	Reference conc., RfC (mg/m^3)	Molecular weight, MW (g/mol)
6.89E-02	8.53E-06	5.18E-03	25	8,661	417.60	630.30	0.0E+00	1.0E-01	106.17

END

INTERMEDIATE CALCULATIONS SHEET

Scenario: Residential

Chemical: o-Xylene

Source-building separation, L_T (cm)	Vadose zone soil air-filled porosity, θ_a^v (cm^3/cm^3)	Vadose zone effective total fluid saturation, S_{te} (cm^3/cm^3)	Vadose zone soil intrinsic permeability, k_i (cm^2)	Vadose zone soil relative air permeability, k_{rg} (cm^2)	Vadose zone soil effective vapor permeability, k_w (cm^2)	Floor-wall seam perimeter, X_{crack} (cm)	Soil gas conc. ($\mu\text{g}/\text{m}^3$)	Bldg. ventilation rate, $Q_{building}$ (cm^3/s)
153	0.321	#N/A	#N/A	#N/A	2.00E-02	4,000	1.10E+03	3.39E+04

Area of enclosed space below grade, A_B (cm^2)	Crack-to-total area ratio, η (unitless)	Crack depth below grade, Z_{crack} (cm)	Enthalpy of vaporization at ave. soil temperature, $\Delta H_{v,TS}$ (cal/mol)	Henry's law constant at ave. soil temperature, H_{TS} (atm- m^3/mol)	Henry's law constant at ave. soil temperature, H'_{TS} (unitless)	Vapor viscosity at ave. soil temperature, μ_{TS} (g/cm-s)	Vadose zone effective diffusion coefficient, D_v^{eff} (cm^2/s)	Diffusion path length, L_d (cm)
1.00E+06	5.00E-03	15	10,329	3.14E-03	1.32E-01	1.77E-04	1.11E-02	153

Convection path length, L_p (cm)	Source vapor conc., C_{source} ($\mu\text{g}/\text{m}^3$)	Crack radius, r_{crack} (cm)	Average vapor flow rate into bldg., Q_{soil} (cm^3/s)	Crack effective diffusion coefficient, D^{crack} (cm^2/s)	Area of crack, A_{crack} (cm^2)	Exponent of equivalent foundation Peclet number, $\exp(\text{Pe}^f)$ (unitless)	Infinite source indoor attenuation coefficient, α (unitless)	Infinite source bldg. conc., $C_{building}$ ($\mu\text{g}/\text{m}^3$)
15	1.10E+03	1.25	8.33E+01	1.11E-02	5.00E+03	3.14E+06	1.15E-03	1.26E+00

Unit risk factor, URF ($\mu\text{g}/\text{m}^3$) ⁻¹	Reference conc., RfC (mg/m^3)
NA	1.0E-01

END

RESULTS SHEET

Scenario: Residential
Chemical: o-Xylene

INCREMENTAL RISK CALCULATIONS:

Incremental risk from vapor intrusion to indoor air, carcinogen (unitless)	Hazard quotient from vapor intrusion to indoor air, noncarcinogen (unitless)
NA	1.2E-02

MESSAGE SUMMARY BELOW:

END

RESULTS SHEET

Scenario: Residential
 Chemical: Naphthalene

RISK-BASED GROUNDWATER CONCENTRATION CALCULATIONS:

Indoor exposure groundwater conc., carcinogen (µg/L)	Indoor exposure groundwater conc., noncarcinogen (µg/L)	Risk-based indoor exposure groundwater conc., (µg/L)	Pure component water solubility, S (µg/L)	Final indoor exposure groundwater conc., (µg/L)
NA	NA	NA	3.10E+04	NA

INCREMENTAL RISK CALCULATIONS:

Incremental risk from vapor intrusion to indoor air, carcinogen (unitless)	Hazard quotient from vapor intrusion to indoor air, noncarcinogen (unitless)
9.9E-06	2.6E-01

MESSAGE SUMMARY BELOW:

MESSAGE: Attenuation factor < 6E-05 is unreasonably low.

END

Department of Toxic Substances Control Vapor Intrusion Screening Model - Groundwater

DATA ENTRY SHEET

CALCULATE RISK-BASED GROUNDWATER CONCENTRATION (enter "X" in "YES" box)
YES

OR

CALCULATE INCREMENTAL RISKS FROM ACTUAL GROUNDWATER CONCENTRATION
(enter "X" in "YES" box and initial groundwater conc. below)

YES

X

Scenario: **Residential**
Chemical: **Naphthalene**

Reset to
Defaults

ENTER Chemical CAS No. (numbers only, no dashes)	ENTER Initial groundwater conc., C _w (µg/L)	Chemical
91203	2.30E+03	Naphthalene

Results Summary					Risk-Based Groundwater Concentration	
Soil Gas Conc. (C _{source}) (µg/m ³)	Attenuation Factor (alpha) (unitless)	Indoor Air Conc. (C _{indoor}) (µg/m ³)	Cancer Risk	Noncancer Hazard	Cancer Risk = 10 ⁻⁶ (µg/L)	Noncancer HQ = 1 (µg/L)
2.28E+04	3.6E-05	8.2E-01	9.9E-06	2.6E-01	NA	NA

MESSAGE: Attenuation factor < 6E-05 is unreasonably low.

MORE
↓

ENTER Depth below grade to bottom of enclosed space floor, L _f (15 or 200 cm)	ENTER Depth below grade to water table, L _{wr} (cm)	ENTER SCS soil type directly above water table	ENTER Average soil/ groundwater temperature, T _s (°C)
15	518	CL	16.67

ENTER
Average vapor
flow rate into bldg.
(Leave blank to calculate)
Q_{soil}
(L/m)

0.05

MORE
↓

ENTER Vadose zone SCS soil type (used to estimate soil vapor permeability)	OR	ENTER User-defined vadose zone soil vapor permeability, k _v (cm ²)	ENTER Vadose zone SCS soil type Lookup Soil Parameters	ENTER Vadose zone soil dry bulk density, ρ _b ^v (g/cm ³)	ENTER Vadose zone soil total porosity, n ^v (unitless)	ENTER Vadose zone soil water-filled porosity, θ _w ^v (cm ³ /cm ³)
		2.00E-02	CL	1.63	0.384	0.146

MORE
↓

Lookup Receptor
Parameters

ENTER Target risk for carcinogens, TR (unitless)	ENTER Target hazard quotient for noncarcinogens, THQ (unitless)	ENTER Averaging time for carcinogens, AT _c (yrs)	ENTER Averaging time for noncarcinogens, AT _{nc} (yrs)	ENTER Exposure duration, ED (yrs)	ENTER Exposure frequency, EF (days/yr)	ENTER Exposure Time ET (hrs/day)	ENTER Air Exchange Rate ACH (hour) ⁻¹
1.0E-06	1	70	26	26	350	24 (NEW)	0.5 (NEW)

NEW=> Residential

END

CHEMICAL PROPERTIES SHEET

Naphthalene

Diffusivity in air, D_a (cm^2/s)	Diffusivity in water, D_w (cm^2/s)	Henry's law constant at reference temperature, H ($\text{atm}\cdot\text{m}^3/\text{mol}$)	Henry's law constant reference temperature, T_R ($^\circ\text{C}$)	Enthalpy of vaporization at the normal boiling point, $\Delta H_{v,b}$ (cal/mol)	Normal boiling point, T_B ($^\circ\text{K}$)	Critical temperature, T_C ($^\circ\text{K}$)	Organic carbon partition coefficient, K_{oc} (cm^3/g)	Pure component water solubility, S (mg/L)	Unit risk factor, URF ($\mu\text{g}/\text{m}^3$) ⁻¹	Reference conc., RfC (mg/m^3)
6.05E-02	8.38E-06	4.40E-04	25	10,373	491.14	748.40	1.54E+03	3.10E+01	3.4E-05	3.0E-03

END

INTERMEDIATE CALCULATIONS SHEET

Scenario: Residential

Chemical: Naphthalene

Source-building separation, L_T (cm)	Vadose zone soil air-filled porosity, θ_a^V (cm ³ /cm ³)	Vadose zone effective total fluid saturation, S_{te} (cm ³ /cm ³)	Vadose zone soil intrinsic permeability, k_i (cm ²)	Vadose zone soil relative air permeability, k_{ra} (cm ²)	Vadose zone soil effective vapor permeability, k_v (cm ²)	Thickness of capillary zone, L_{cz} (cm)	Total porosity in capillary zone, n_{cz} (cm ³ /cm ³)	Air-filled porosity in capillary zone, $\theta_{a,cz}$ (cm ³ /cm ³)	Water-filled porosity in capillary zone, $\theta_{w,cz}$ (cm ³ /cm ³)	Floor-wall seam perimeter, X_{crack} (cm)
503	0.238	#N/A	#N/A	#N/A	2.00E-02	46.88	0.442	0.067	0.375	4.000

Bldg. ventilation rate, $Q_{building}$ (cm ³ /s)	Area of enclosed space below grade, A_B (cm ²)	Crack-to-total area ratio, η (unitless)	Crack depth below grade, Z_{crack} (cm)	Enthalpy of vaporization at ave. groundwater temperature, $\Delta H_{v,TS}$ (cal/mol)	Henry's law constant at ave. groundwater temperature, H_{TS} (atm·m ³ /mol)	Henry's law constant at ave. groundwater temperature, H'_{TS} (unitless)	Vapor viscosity at ave. soil temperature, μ_{TS} (g/cm·s)	Vadose zone effective diffusion coefficient, D_v^{eff} (cm ² /s)	Capillary zone effective diffusion coefficient, D_{cz}^{eff} (cm ² /s)	Total overall effective diffusion coefficient, D_T^{eff} (cm ² /s)
3.39E+04	1.00E+06	5.00E-03	15	12.844	2.36E-04	9.92E-03	1.77E-04	3.45E-03	2.03E-04	1.39E-03

Diffusion path length, L_d (cm)	Convection path length, L_p (cm)	Source vapor conc., C_{source} (µg/m ³)	Crack radius, r_{crack} (cm)	Average vapor flow rate into bldg., Q_{soil} (cm ³ /s)	Crack effective diffusion coefficient, D_{crack} (cm ² /s)	Area of crack, A_{crack} (cm ²)	Exponent of equivalent foundation Peclet number, $\exp(Pe^f)$ (unitless)	Infinite source indoor attenuation coefficient, α (unitless)	Infinite source bldg. conc., $C_{building}$ (µg/m ³)	Unit risk factor, URF (µg/m ³) ⁻¹	Reference conc., RfC (mg/m ³)
503	15	2.28E+04	1.25	8.33E-01	3.45E-03	5.00E+03	1.62E+00	3.59E-05	8.19E-01	3.4E-05	3.0E-03
END											

Warning: alpha < 6E-05 is unreasonably low.

RESULTS SHEET

Scenario: Residential

Chemical: Naphthalene

RISK-BASED GROUNDWATER CONCENTRATION CALCULATIONS:

Indoor exposure groundwater conc., carcinogen (µg/L)	Indoor exposure groundwater conc., noncarcinogen (µg/L)	Risk-based indoor exposure groundwater conc., (µg/L)	Pure component water solubility, S (µg/L)	Final indoor exposure groundwater conc., (µg/L)
NA	NA	NA	3.10E+04	NA

INCREMENTAL RISK CALCULATIONS:

Incremental risk from vapor intrusion to indoor air, carcinogen (unitless)	Hazard quotient from vapor intrusion to indoor air, noncarcinogen (unitless)
1.2E-05	3.1E-01

MESSAGE SUMMARY BELOW:

MESSAGE: Attenuation factor < 6E-05 is unreasonably low.

END

Department of Toxic Substances Control Vapor Intrusion Screening Model - Groundwater

DATA ENTRY SHEET

Scenario: **Residential**
Chemical: **Naphthalene**

Reset to Defaults

CALCULATE RISK-BASED GROUNDWATER CONCENTRATION (enter "X" in "YES" box)

YES

OR

CALCULATE INCREMENTAL RISKS FROM ACTUAL GROUNDWATER CONCENTRATION (enter "X" in "YES" box and initial groundwater conc. below)

YES

Results Summary					Risk-Based Groundwater Concentration	
Soil Gas Conc. (C_{soil}) ($\mu\text{g}/\text{m}^3$)	Attenuation Factor (alpha) (unitless)	Indoor Air Conc. (C_{indoor}) ($\mu\text{g}/\text{m}^3$)	Cancer Risk	Noncancer Hazard	Cancer Risk = 10^{-6} ($\mu\text{g}/\text{L}$)	Noncancer HQ = 1 ($\mu\text{g}/\text{L}$)
2.28E+04	4.2E-05	9.6E-01	1.2E-05	3.1E-01	NA	NA

ENTER Chemical CAS No. (numbers only, no dashes)	ENTER Initial groundwater conc., C_w ($\mu\text{g}/\text{L}$)	Chemical
91203	2.30E+03	Naphthalene

MESSAGE: Attenuation factor < 6E-05 is unreasonably low.

MORE
↓

ENTER Depth below grade to bottom of enclosed space floor, L_f (15 or 200 cm)	ENTER Depth below grade to water table, L_{wt} (cm)	ENTER SCS soil type directly above water table	ENTER Average soil/ groundwater temperature, T_s ($^{\circ}\text{C}$)
15	91	CL	16.67

ENTER Average vapor flow rate into bldg. (Leave blank to calculate) Q_{soil} (L/m)
0.05

MORE
↓

ENTER Vadose zone SCS soil type (used to estimate soil vapor permeability)	OR	ENTER User-defined vadose zone soil vapor permeability, k_v (cm^2)	ENTER Vadose zone SCS soil type Lookup Soil Parameters	ENTER Vadose zone soil dry bulk density, ρ_b^v (g/cm^3)	ENTER Vadose zone soil total porosity, n^v (unitless)	ENTER Vadose zone soil water-filled porosity, θ_w^v (cm^3/cm^3)
		2.00E-02	CL	1.63	0.384	0.146

MORE
↓

Lookup Receptor
Parameters

ENTER Target risk for carcinogens, TR (unitless)	ENTER Target hazard quotient for noncarcinogens, THQ (unitless)	ENTER Averaging time for carcinogens, AT_c (yrs)	ENTER Averaging time for noncarcinogens, AT_{nc} (yrs)	ENTER Exposure duration, ED (yrs)	ENTER Exposure frequency, EF (days/yr)	ENTER Exposure Time ET (hrs/day)	ENTER Air Exchange Rate ACH (hour) ⁻¹
1.0E-06	1	70	26	26	350	24	0.5
Used to calculate risk-based groundwater concentration.						(NEW)	(NEW)

END

NEW=> Residential

CHEMICAL PROPERTIES SHEET

Naphthalene

Diffusivity in air, D_a (cm^2/s)	Diffusivity in water, D_w (cm^2/s)	Henry's law constant at reference temperature, H ($\text{atm}\cdot\text{m}^3/\text{mol}$)	Henry's law constant reference temperature, T_R ($^{\circ}\text{C}$)	Enthalpy of vaporization at the normal boiling point, $\Delta H_{v,b}$ (cal/mol)	Normal boiling point, T_B ($^{\circ}\text{K}$)	Critical temperature, T_C ($^{\circ}\text{K}$)	Organic carbon partition coefficient, K_{oc} (cm^3/g)	Pure component water solubility, S (mg/L)	Unit risk factor, URF ($\mu\text{g}/\text{m}^3$) ⁻¹	Reference conc., RfC (mg/m^3)
6.05E-02	8.38E-06	4.40E-04	25	10,373	491.14	748.40	1.54E+03	3.10E+01	3.4E-05	3.0E-03

END

INTERMEDIATE CALCULATIONS SHEET

Scenario: Residential

Chemical: Naphthalene

Source-building separation, L_T (cm)	Vadose zone soil air-filled porosity, θ_a^v (cm^3/cm^3)	Vadose zone effective total fluid saturation, S_{te} (cm^3/cm^3)	Vadose zone soil intrinsic permeability, k_i (cm^2)	Vadose zone soil relative air permeability, k_{rg} (cm^2)	Vadose zone soil effective vapor permeability, k_v (cm^2)	Thickness of capillary zone, L_{cz} (cm)	Total porosity in capillary zone, n_{cz} (cm^3/cm^3)	Air-filled porosity in capillary zone, $\theta_{s,cz}$ (cm^3/cm^3)	Water-filled porosity in capillary zone, $\theta_{w,cz}$ (cm^3/cm^3)	Floor-wall seam perimeter, X_{crack} (cm)
76	0.238	#N/A	#N/A	#N/A	2.00E-02	46.88	0.442	0.067	0.375	4,000

Bldg. ventilation rate, $Q_{building}$ (cm^3/s)	Area of enclosed space below grade, A_B (cm^2)	Crack-to-total area ratio, η (unitless)	Crack depth below grade, Z_{crack} (cm)	Enthalpy of vaporization at ave. groundwater temperature, $\Delta H_{v,TS}$ (cal/mol)	Henry's law constant at ave. groundwater temperature, H_{TS} ($\text{atm}\cdot\text{m}^3/\text{mol}$)	Henry's law constant at ave. groundwater temperature, H'_{TS} (unitless)	Vapor viscosity at ave. soil temperature, μ_{TS} (g/cm-s)	Vadose zone effective diffusion coefficient, D_v^{eff} (cm^2/s)	Capillary zone effective diffusion coefficient, D_{cz}^{eff} (cm^2/s)	Total overall effective diffusion coefficient, D_T^{eff} (cm^2/s)
3.39E+04	1.00E+06	5.00E-03	15	12,844	2.36E-04	9.92E-03	1.77E-04	3.45E-03	2.03E-04	3.18E-04

Diffusion path length, L_d (cm)	Convection path length, L_p (cm)	Source vapor conc., C_{source} ($\mu\text{g}/\text{m}^3$)	Crack radius, r_{crack} (cm)	Average vapor flow rate into bldg., Q_{soil} (cm^3/s)	Crack effective diffusion coefficient, D_{crack} (cm^2/s)	Area of crack, A_{crack} (cm^2)	Exponent of equivalent foundation Peclet number, $\exp(\text{Pe}^f)$ (unitless)	Infinite source indoor attenuation coefficient, α (unitless)	Infinite source bldg. conc., $C_{building}$ ($\mu\text{g}/\text{m}^3$)	Unit risk factor, URF ($\mu\text{g}/\text{m}^3$) ⁻¹	Reference conc., RFC (mg/m^3)
76	15	2.28E+04	1.25	8.33E-01	3.45E-03	5.00E+03	1.62E+00	4.22E-05	9.64E-01	3.4E-05	3.0E-03

END

Warning: alpha < 6E-05 is unreasonably low.

RESULTS SHEET

Scenario: Residential

Chemical: Ethylbenzene

RISK-BASED GROUNDWATER CONCENTRATION CALCULATIONS:

Indoor exposure groundwater conc., carcinogen (µg/L)	Indoor exposure groundwater conc., noncarcinogen (µg/L)	Risk-based indoor exposure groundwater conc., (µg/L)	Pure component water solubility, S (µg/L)	Final indoor exposure groundwater conc., (µg/L)
NA	NA	NA	1.69E+05	NA

INCREMENTAL RISK CALCULATIONS:

Incremental risk from vapor intrusion to indoor air, carcinogen (unitless)	Hazard quotient from vapor intrusion to indoor air, noncarcinogen (unitless)
9.6E-06	1.0E-02

MESSAGE SUMMARY BELOW:

MESSAGE: Attenuation factor < 6E-05 is unreasonably low.

END

Department of Toxic Substances Control Vapor Intrusion Screening Model - Groundwater

DATA ENTRY SHEET

Scenario: Residential
Chemical: Ethylbenzene

Reset to Defaults

CALCULATE RISK-BASED GROUNDWATER CONCENTRATION (enter "X" in "YES" box)

YES

OR

CALCULATE INCREMENTAL RISKS FROM ACTUAL GROUNDWATER CONCENTRATION
(enter "X" in "YES" box and initial groundwater conc. below)

YES

ENTER

Chemical
CAS No.
(numbers only,
no dashes)

ENTER

Initial
groundwater
conc.,
 C_w
($\mu\text{g/L}$)

Chemical

100414	2.60E+03	Ethylbenzene
--------	----------	--------------

Results Summary					Risk-Based Groundwater Concentration	
Soil Gas Conc. (C_{source}) ($\mu\text{g/m}^3$)	Attenuation Factor (alpha) (unitless)	Indoor Air Conc. (C_{building}) ($\mu\text{g/m}^3$)	Cancer Risk	Noncancer Hazard	Cancer Risk = 10^{-6} ($\mu\text{g/L}$)	Noncancer HQ = 1 ($\mu\text{g/L}$)
5.28E+05	2.0E-05	1.1E+01	9.6E-06	1.0E-02	NA	NA

MESSAGE: Attenuation factor < 6E-05 is unreasonably low.

MORE
↓

ENTER

Depth
below grade
to bottom
of enclosed
space floor,
 L_f
(15 or 200 cm)

ENTER

Depth
below grade
to water table,
 L_{WT}
(cm)

ENTER

SCS
soil type
directly above
water table

ENTER

Average
soil/
groundwater
temperature,
 T_s
($^{\circ}\text{C}$)

15	518	CL	16.67
----	-----	----	-------

ENTER

Average vapor
flow rate into bldg.
(Leave blank to calculate)
 Q_{soil}
(L/m)

0.05

MORE
↓

ENTER

Vadose zone
SCS
soil type
(used to estimate
soil vapor
permeability)

OR

ENTER

User-defined
vadose zone
soil vapor
permeability,
 k_v
(cm^2)

ENTER

Vadose zone
SCS
soil type
Lookup Soil
Parameters

ENTER

Vadose zone
soil dry
bulk density,
 ρ_b^v
(g/cm^3)

ENTER

Vadose zone
soil total
porosity,
 n^v
(unitless)

ENTER

Vadose zone
soil water-filled
porosity,
 θ_w^v
(cm^3/cm^3)

	2.00E-02	CL	1.63	0.384	0.146
--	----------	----	------	-------	-------

MORE
↓

ENTER

Target risk for
carcinogens,
TR
(unitless)

ENTER

Target hazard
quotient for
noncarcinogens,
THQ
(unitless)

ENTER

Averaging
time for
carcinogens,
 AT_c
(yrs)

ENTER

Averaging
time for
noncarcinogens,
 AT_{nc}
(yrs)

ENTER

Exposure
duration,
ED
(yrs)

ENTER

Exposure
frequency,
EF
(days/yr)

ENTER

Exposure
Time
ET
(hrs/day)

ENTER

Air Exchange
Rate
ACH
(hour^{-1})

1.0E-06	1	70	26	26	350	24	0.5
---------	---	----	----	----	-----	----	-----

Used to calculate risk-based
groundwater concentration.

(NEW) (NEW)

END

NEW=> Residential

CHEMICAL PROPERTIES SHEET

Ethylbenzene

Diffusivity in air, D_a (cm^2/s)	Diffusivity in water, D_w (cm^2/s)	Henry's law constant at reference temperature, H ($\text{atm}\cdot\text{m}^3/\text{mol}$)	Henry's law constant reference temperature, T_R ($^\circ\text{C}$)	Enthalpy of vaporization at the normal boiling point, $\Delta H_{v,b}$ (cal/mol)	Normal boiling point, T_B ($^\circ\text{K}$)	Critical temperature, T_C ($^\circ\text{K}$)	Organic carbon partition coefficient, K_{oc} (cm^3/g)	Pure component water solubility, S (mg/L)	Unit risk factor, URF ($\mu\text{g}/\text{m}^3$) ⁻¹	Reference conc., RfC (mg/m^3)
6.85E-02	8.46E-06	7.88E-03	25	8,501	409.34	617.20	4.46E+02	1.69E+02	2.5E-06	1.0E+00

END

INTERMEDIATE CALCULATIONS SHEET

Scenario: Residential

Chemical: Ethylbenzene

Source-building separation, L_T (cm)	Vadose zone soil air-filled porosity, θ_a^v (cm^3/cm^3)	Vadose zone effective total fluid saturation, S_{te} (cm^3/cm^3)	Vadose zone soil intrinsic permeability, k_i (cm^2)	Vadose zone soil relative air permeability, k_{rg} (cm^2)	Vadose zone soil effective vapor permeability, k_v (cm^2)	Thickness of capillary zone, L_{cz} (cm)	Total porosity in capillary zone, n_{cz} (cm^3/cm^3)	Air-filled porosity in capillary zone, $\theta_{a,cz}$ (cm^3/cm^3)	Water-filled porosity in capillary zone, $\theta_{w,cz}$ (cm^3/cm^3)	Floor-wall seam perimeter, X_{crack} (cm)
503	0.238	#N/A	#N/A	#N/A	2.00E-02	46.88	0.442	0.067	0.375	4,000

Bldg. ventilation rate, $Q_{building}$ (cm^3/s)	Area of enclosed space below grade, A_B (cm^2)	Crack-to-total area ratio, η (unitless)	Crack depth below grade, Z_{crack} (cm)	Enthalpy of vaporization at ave. groundwater temperature, $\Delta H_{v,TS}$ (cal/mol)	Henry's law constant at ave. groundwater temperature, H_{TS} ($\text{atm}\cdot\text{m}^3/\text{mol}$)	Henry's law constant at ave. groundwater temperature, H'_{TS} (unitless)	Vapor viscosity at ave. soil temperature, μ_{TS} (g/cm-s)	Vadose zone effective diffusion coefficient, D_v^{eff} (cm^2/s)	Capillary zone effective diffusion coefficient, D_{cz}^{eff} (cm^2/s)	Total overall effective diffusion coefficient, D_T^{eff} (cm^2/s)
3.39E+04	1.00E+06	5.00E-03	15	10,079	4.83E-03	2.03E-01	1.77E-04	3.90E-03	5.11E-05	4.86E-04

Diffusion path length, L_d (cm)	Convection path length, L_p (cm)	Source vapor conc., C_{source} ($\mu\text{g}/\text{m}^3$)	Crack radius, r_{crack} (cm)	Average vapor flow rate into bldg., Q_{soil} (cm^3/s)	Crack effective diffusion coefficient, D^{crack} (cm^2/s)	Area of crack, A_{crack} (cm^2)	Exponent of equivalent foundation Peclet number, $\exp(\text{Pe}^f)$ (unitless)	Infinite source indoor attenuation coefficient, α (unitless)	Infinite source bldg. conc., $C_{building}$ ($\mu\text{g}/\text{m}^3$)	Unit risk factor, URF ($\mu\text{g}/\text{m}^3$) ⁻¹	Reference conc., RFC (mg/m^3)
503	15	5.28E+05	1.25	8.33E-01	3.90E-03	5.00E+03	1.53E+00	2.03E-05	1.07E+01	2.5E-06	1.0E+00

END

Warning: alpha < 6E-05 is unreasonably low.

RESULTS SHEET

Scenario: Residential

Chemical: Ethylbenzene

RISK-BASED GROUNDWATER CONCENTRATION CALCULATIONS:

Indoor exposure groundwater conc., carcinogen (µg/L)	Indoor exposure groundwater conc., noncarcinogen (µg/L)	Risk-based indoor exposure groundwater conc., (µg/L)	Pure component water solubility, S (µg/L)	Final indoor exposure groundwater conc., (µg/L)
NA	NA	NA	1.69E+05	NA

INCREMENTAL RISK CALCULATIONS:

Incremental risk from vapor intrusion to indoor air, carcinogen (unitless)	Hazard quotient from vapor intrusion to indoor air, noncarcinogen (unitless)
1.0E-05	1.1E-02

MESSAGE SUMMARY BELOW:

MESSAGE: Attenuation factor < 6E-05 is unreasonably low.

END

Department of Toxic Substances Control Vapor Intrusion Screening Model - Groundwater

DATA ENTRY SHEET

Scenario: **Residential**
Chemical: **Ethylbenzene**

Reset to Defaults

CALCULATE RISK-BASED GROUNDWATER CONCENTRATION (enter "X" in "YES" box)

YES

OR

CALCULATE INCREMENTAL RISKS FROM ACTUAL GROUNDWATER CONCENTRATION (enter "X" in "YES" box and initial groundwater conc. below)

YES

ENTER Chemical CAS No. (numbers only, no dashes)	ENTER Initial groundwater conc., C _w (µg/L)	Chemical
100414	2.60E+03	Ethylbenzene

Results Summary					Risk-Based Groundwater Concentration	
Soil Gas Conc. (C _{source}) (µg/m ³)	Attenuation Factor (alpha) (unitless)	Indoor Air Conc. (C _{building}) (µg/m ³)	Cancer Risk	Noncancer Hazard	Cancer Risk = 10 ⁻⁶ (µg/L)	Noncancer HQ = 1 (µg/L)
5.28E+05	2.2E-05	1.2E+01	1.0E-05	1.1E-02	NA	NA

MESSAGE: Attenuation factor < 6E-05 is unreasonably low.

MORE
↓

ENTER Depth below grade to bottom of enclosed space floor, L _F (15 or 200 cm)	ENTER Depth below grade to water table, L _{WT} (cm)	ENTER SCS soil type directly above water table	ENTER Average soil/ groundwater temperature, T _s (°C)
15	91	CL	16.67

ENTER
Average vapor
flow rate into bldg.
(Leave blank to calculate)

Q _{soil} (L/m)
0.05

MORE
↓

ENTER Vadose zone SCS soil type (used to estimate soil vapor permeability)	OR	ENTER User-defined vadose zone soil vapor permeability, k _v (cm ²)	ENTER Vadose zone SCS soil type Lookup Soil Parameters	ENTER Vadose zone soil dry bulk density, ρ _b ^v (g/cm ³)	ENTER Vadose zone soil total porosity, n ^v (unitless)	ENTER Vadose zone soil water-filled porosity, θ _w ^v (cm ³ /cm ³)
		2.00E-02	CL	1.63	0.384	0.146

MORE
↓

Lookup Receptor Parameters

ENTER Target risk for carcinogens, TR (unitless)	ENTER Target hazard quotient for noncarcinogens, THQ (unitless)	ENTER Averaging time for carcinogens, AT _c (yrs)	ENTER Averaging time for noncarcinogens, AT _{nc} (yrs)	ENTER Exposure duration, ED (yrs)	ENTER Exposure frequency, EF (days/yr)	ENTER Exposure Time ET (hrs/day)	ENTER Air Exchange Rate ACH (hour) ⁻¹
1.0E-06	1	70	26	26	350	24 (NEW)	0.5 (NEW)

NEW=> Residential

END

CHEMICAL PROPERTIES SHEET

Ethylbenzene

Diffusivity in air, D_a (cm^2/s)	Diffusivity in water, D_w (cm^2/s)	Henry's law constant at reference temperature, H ($\text{atm}\cdot\text{m}^3/\text{mol}$)	Henry's law constant reference temperature, T_R ($^{\circ}\text{C}$)	Enthalpy of vaporization at the normal boiling point, $\Delta H_{v,b}$ (cal/mol)	Normal boiling point, T_B ($^{\circ}\text{K}$)	Critical temperature, T_C ($^{\circ}\text{K}$)	Organic carbon partition coefficient, K_{oc} (cm^3/g)	Pure component water solubility, S (mg/L)	Unit risk factor, URF ($\mu\text{g}/\text{m}^3$) ⁻¹	Reference conc., RfC (mg/m^3)
6.85E-02	8.46E-06	7.88E-03	25	8,501	409.34	617.20	4.46E+02	1.69E+02	2.5E-06	1.0E+00

END

INTERMEDIATE CALCULATIONS SHEET

Scenario: Residential

Chemical: Ethylbenzene

Source-building separation, L_T (cm)	Vadose zone soil air-filled porosity, θ_a^V (cm^3/cm^3)	Vadose zone effective total fluid saturation, S_{le} (cm^3/cm^3)	Vadose zone soil intrinsic permeability, k_i (cm^2)	Vadose zone soil relative air permeability, k_{ra} (cm^2)	Vadose zone soil effective vapor permeability, k_v (cm^2)	Thickness of capillary zone, L_{cz} (cm)	Total porosity in capillary zone, n_{cz} (cm^3/cm^3)	Air-filled porosity in capillary zone, $\theta_{a,cz}$ (cm^3/cm^3)	Water-filled porosity in capillary zone, $\theta_{w,cz}$ (cm^3/cm^3)	Floor-wall seam perimeter, X_{crack} (cm)
76	0.238	#N/A	#N/A	#N/A	2.00E-02	46.88	0.442	0.067	0.375	4,000

Bldg. ventilation rate, $Q_{building}$ (cm^3/s)	Area of enclosed space below grade, A_B (cm^2)	Crack-to-total area ratio, η (unitless)	Crack depth below grade, Z_{crack} (cm)	Enthalpy of vaporization at ave. groundwater temperature, $\Delta H_{v,TS}$ (cal/mol)	Henry's law constant at ave. groundwater temperature, H_{TS} ($\text{atm}\cdot\text{m}^3/\text{mol}$)	Henry's law constant at ave. groundwater temperature, H'_{TS} (unitless)	Vapor viscosity at ave. soil temperature, μ_{TS} (g/cm-s)	Vadose zone effective diffusion coefficient, D_v^{eff} (cm^2/s)	Capillary zone effective diffusion coefficient, D_{cz}^{eff} (cm^2/s)	Total overall effective diffusion coefficient, D_T^{eff} (cm^2/s)
3.39E+04	1.00E+06	5.00E-03	15	10,079	4.83E-03	2.03E-01	1.77E-04	3.90E-03	5.11E-05	8.21E-05

Diffusion path length, L_d (cm)	Convection path length, L_p (cm)	Source vapor conc., C_{source} ($\mu\text{g}/\text{m}^3$)	Crack radius, r_{crack} (cm)	Average vapor flow rate into bldg., Q_{soil} (cm^3/s)	Crack effective diffusion coefficient, D_{crack} (cm^2/s)	Area of crack, A_{crack} (cm^2)	Exponent of equivalent foundation Peclet number, $\exp(\text{Pe}^f)$ (unitless)	Infinite source indoor attenuation coefficient, α (unitless)	Infinite source bldg. conc., $C_{building}$ ($\mu\text{g}/\text{m}^3$)	Unit risk factor, URF ($\mu\text{g}/\text{m}^3\cdot\text{s}^{-1}$)	Reference conc., RfC (mg/m^3)
76	15	5.28E+05	1.25	8.33E-01	3.90E-03	5.00E+03	1.53E+00	2.20E-05	1.16E+01	2.5E-06	1.0E+00

END

Warning: alpha < 6E-05 is unreasonably low.

RESULTS SHEET

Scenario: Residential

Chemical: Benzene

RISK-BASED GROUNDWATER CONCENTRATION CALCULATIONS:

Indoor exposure groundwater conc., carcinogen (µg/L)	Indoor exposure groundwater conc., noncarcinogen (µg/L)	Risk-based indoor exposure groundwater conc., (µg/L)	Pure component water solubility, S (µg/L)	Final indoor exposure groundwater conc., (µg/L)
NA	NA	NA	1.79E+06	NA

INCREMENTAL RISK CALCULATIONS:

Incremental risk from vapor intrusion to indoor air, carcinogen (unitless)	Hazard quotient from vapor intrusion to indoor air, noncarcinogen (unitless)
5.0E-06	1.5E-01

MESSAGE SUMMARY BELOW:

MESSAGE: Attenuation factor < 6E-05 is unreasonably low.

END

Department of Toxic Substances Control Vapor Intrusion Screening Model - Groundwater

DATA ENTRY SHEET

CALCULATE RISK-BASED GROUNDWATER CONCENTRATION (enter "X" in "YES" box)
YES

OR

CALCULATE INCREMENTAL RISKS FROM ACTUAL GROUNDWATER CONCENTRATION
(enter "X" in "YES" box and initial groundwater conc. below)

YES

Scenario: **Residential**
Chemical: **Benzene**

Reset to Defaults

ENTER Chemical CAS No. (numbers only, no dashes)
ENTER Initial groundwater conc., C_w ($\mu\text{g/L}$)
Chemical

71432	1.10E+02	Benzene
-------	----------	---------

MESSAGE: See VLOOKUP table comments on chemical properties and/or toxicity criteria for this chemical.

Results Summary					Risk-Based Groundwater Concentration	
Soil Gas Conc. (C_{soil}) ($\mu\text{g/m}^3$)	Attenuation Factor (alpha) (unitless)	Indoor Air Conc. ($C_{building}$) ($\mu\text{g/m}^3$)	Cancer Risk	Noncancer Hazard	Cancer Risk ($\mu\text{g/L}$)	Noncancer ($\mu\text{g/L}$)
1.74E+04	2.8E-05	4.8E-01	5.0E-06	1.5E-01	$= 10^{-5}$	HQ = 1
					NA	NA

MESSAGE: Attenuation factor < 6E-05 is unreasonably low.

MORE ↓

ENTER Depth below grade to bottom of enclosed space floor, L_f (15 or 200 cm)
ENTER Depth below grade to water table, L_{wt} (cm)
ENTER SCS soil type directly above water table
ENTER Average soil/groundwater temperature, T_s ($^{\circ}\text{C}$)

15	518	SCL	16.67
----	-----	-----	-------

ENTER Average vapor flow rate into bldg. (Leave blank to calculate)
 Q_{soil} (L/m)

MORE ↓

ENTER Vadose zone SCS soil type (used to estimate soil vapor permeability)
OR
ENTER User-defined vadose zone soil vapor permeability, K_v (cm^2)
ENTER Vadose zone SCS soil type (Lookup Soil Parameters)
ENTER Vadose zone soil dry bulk density, ρ_b^v (g/cm^3)
ENTER Vadose zone soil total porosity, n^v (unitless)
ENTER Vadose zone soil water-filled porosity, θ_w^v (cm^3/cm^3)

	2.00E-02	SCL	1.63	0.384	0.146
--	----------	-----	------	-------	-------

MORE ↓

Lookup Receptor Parameters

ENTER Target risk for carcinogens, TR (unitless)
ENTER Target hazard quotient for noncarcinogens, THQ (unitless)
ENTER Averaging time for carcinogens, AT_c (yrs)
ENTER Averaging time for noncarcinogens, AT_{nc} (yrs)
ENTER Exposure duration, ED (yrs)
ENTER Exposure frequency, EF (days/yr)
ENTER Exposure Time, ET (hrs/day)
ENTER Air Exchange Rate, ACH (hour^{-1})

1.0E-06	1	70	26	26	350	24 (NEW)	0.5 (NEW)
---------	---	----	----	----	-----	--------------------	---------------------

Used to calculate risk-based groundwater concentration.

NEW=> Residential

END

CHEMICAL PROPERTIES SHEET

Benzene

Diffusivity in air, D_a (cm^2/s)	Diffusivity in water, D_w (cm^2/s)	Henry's law constant at reference temperature, H ($\text{atm}\cdot\text{m}^3/\text{mol}$)	Henry's law constant reference temperature, T_R ($^\circ\text{C}$)	Enthalpy of vaporization at the normal boiling point, $\Delta H_{v,b}$ (cal/mol)	Normal boiling point, T_B ($^\circ\text{K}$)	Critical temperature, T_C ($^\circ\text{K}$)	Organic carbon partition coefficient, K_{oc} (cm^3/g)	Pure component water solubility, S (mg/L)	Unit risk factor, URF ($\mu\text{g}/\text{m}^3$) ⁻¹	Reference conc., RfC (mg/m^3)
8.95E-02	1.03E-05	5.55E-03	25	7,342	353.24	562.16	1.46E+02	1.79E+03	2.9E-05	3.0E-03

END

INTERMEDIATE CALCULATIONS SHEET

Scenario: Residential

Chemical: Benzene

Source-building separation, L_T (cm)	Vadose zone soil air-filled porosity, θ_a^V (cm ³ /cm ³)	Vadose zone effective total fluid saturation, S_{te} (cm ³ /cm ³)	Vadose zone soil intrinsic permeability, k_i (cm ²)	Vadose zone soil relative air permeability, k_{rg} (cm ²)	Vadose zone soil effective vapor permeability, k_v (cm ²)	Thickness of capillary zone, L_{cz} (cm)	Total porosity in capillary zone, n_{cz} (cm ³ /cm ³)	Air-filled porosity in capillary zone, $\theta_{a,cz}$ (cm ³ /cm ³)	Water-filled porosity in capillary zone, $\theta_{w,cz}$ (cm ³ /cm ³)	Floor-wall seam perimeter, X_{crack} (cm)
503	0.238	#N/A	#N/A	#N/A	2.00E-02	25.86	0.384	0.051	0.333	4,000

Bldg. ventilation rate, $Q_{building}$ (cm ³ /s)	Area of enclosed space below grade, A_B (cm ²)	Crack-to-total area ratio, η (unitless)	Crack depth below grade, Z_{crack} (cm)	Enthalpy of vaporization at ave. groundwater temperature, $\Delta H_{v,TS}$ (cal/mol)	Henry's law constant at ave. groundwater temperature, H_{TS} (atm-m ³ /mol)	Henry's law constant at ave. groundwater temperature, H'_{TS} (unitless)	Vapor viscosity at ave. soil temperature, μ_{TS} (g/cm-s)	Vadose zone effective diffusion coefficient, D_{vz}^{eff} (cm ² /s)	Capillary zone effective diffusion coefficient, D_{cz}^{eff} (cm ² /s)	Total overall effective diffusion coefficient, D_T^{eff} (cm ² /s)
3.39E+04	1.00E+06	5.00E-03	15	8,054	3.76E-03	1.58E-01	1.77E-04	5.10E-03	4.10E-05	6.95E-04

Diffusion path length, L_d (cm)	Convection path length, L_p (cm)	Source vapor conc., C_{source} (µg/m ³)	Crack radius, r_{crack} (cm)	Average vapor flow rate into bldg., Q_{soil} (cm ³ /s)	Crack effective diffusion coefficient, D_{crack} (cm ² /s)	Area of crack, A_{crack} (cm ²)	Exponent of equivalent foundation Peclet number, $\exp(Pe')$ (unitless)	Infinite source indoor attenuation coefficient, α (unitless)	Infinite source bldg. conc., $C_{building}$ (µg/m ³)	Unit risk factor, URF (µg/m ³) ⁻¹	Reference conc., RfC (mg/m ³)
503	15	1.74E+04	1.25	8.33E-01	5.10E-03	5.00E+03	1.39E+00	2.79E-05	4.84E-01	2.9E-05	3.0E-03

END

Warning: alpha < 6E-05 is unreasonably low.

RESULTS SHEET

Scenario: Residential

Chemical: Benzene

RISK-BASED GROUNDWATER CONCENTRATION CALCULATIONS:

Indoor exposure groundwater conc., carcinogen (µg/L)	Indoor exposure groundwater conc., noncarcinogen (µg/L)	Risk-based indoor exposure groundwater conc., (µg/L)	Pure component water solubility, S (µg/L)	Final indoor exposure groundwater conc., (µg/L)
NA	NA	NA	1.79E+06	NA

INCREMENTAL RISK CALCULATIONS:

Incremental risk from vapor intrusion to indoor air, carcinogen (unitless)	Hazard quotient from vapor intrusion to indoor air, noncarcinogen (unitless)
5.2E-06	1.6E-01

MESSAGE SUMMARY BELOW:

MESSAGE: Attenuation factor < 6E-05 is unreasonably low.

Department of Toxic Substances Control Vapor Intrusion Screening Model - Groundwater

DATA ENTRY SHEET

Scenario: **Residential**
Chemical: **Benzene**

Reset to Defaults

CALCULATE RISK-BASED GROUNDWATER CONCENTRATION (enter "X" in "YES" box)
YES

OR

CALCULATE INCREMENTAL RISKS FROM ACTUAL GROUNDWATER CONCENTRATION
(enter "X" in "YES" box and initial groundwater conc. below)

YES

ENTER Chemical CAS No. (numbers only, no dashes)	ENTER Initial groundwater conc., C _w (µg/L)	Chemical
71432	1.10E+02	Benzene

MESSAGE: See VLOOKUP table comments on chemical properties and/or toxicity criteria for this chemical.

Results Summary					Risk-Based Groundwater Concentration	
Soil Gas Conc. (C _{soilgas}) (µg/m ³)	Attenuation Factor (alpha) (unitless)	Indoor Air Conc. (C _{indoor}) (µg/m ³)	Cancer Risk	Noncancer Hazard	Cancer Risk = 10 ⁻⁶ (µg/L)	Noncancer HQ = 1 (µg/L)
1.74E+04	2.9E-05	5.0E-01	5.2E-06	1.6E-01	NA	NA

MESSAGE: Attenuation factor < 8E-05 is unreasonably low.

MORE ↓

ENTER Depth below grade to bottom of enclosed space floor, L _F (15 or 200 cm)	ENTER Depth below grade to water table, L _{WT} (cm)	ENTER SCS soil type directly above water table	ENTER Average soil/ groundwater temperature, T _S (°C)
15	91	CL	16.67

ENTER
Average vapor
flow rate into bldg.
(Leave blank to calculate)

Q _{soil} (L/m)
0.05

MORE ↓

ENTER Vadose zone SCS soil type (used to estimate soil vapor permeability)	OR	ENTER User-defined vadose zone soil vapor permeability, k _v (cm ²)	ENTER Vadose zone SCS soil type Lookup Soil Parameters	ENTER Vadose zone soil dry bulk density, ρ _b ^v (g/cm ³)	ENTER Vadose zone soil total porosity, n ^v (unitless)	ENTER Vadose zone soil water-filled porosity, θ _w ^v (cm ³ /cm ³)
		2.00E-02	CL	1.63	0.384	0.146

MORE ↓

ENTER Target risk for carcinogens, TR (unitless)	ENTER Target hazard quotient for noncarcinogens, THQ (unitless)	ENTER Averaging time for carcinogens, AT _C (yrs)	ENTER Averaging time for noncarcinogens, AT _{NC} (yrs)	ENTER Exposure duration, ED (yrs)	ENTER Exposure frequency, EF (days/yr)	ENTER Exposure Time ET (hrs/day)	ENTER Air Exchange Rate ACH (hour) ⁻¹
1.0E-06	1	70	26	26	350	24 (NEW)	0.5 (NEW)

NEW=> Residential

Used to calculate risk-based groundwater concentration.

END

CHEMICAL PROPERTIES SHEET

Benzene

Diffusivity in air, D_a (cm^2/s)	Diffusivity in water, D_w (cm^2/s)	Henry's law constant at reference temperature, H ($\text{atm}\cdot\text{m}^3/\text{mol}$)	Henry's law constant reference temperature, T_R ($^\circ\text{C}$)	Enthalpy of vaporization at the normal boiling point, $\Delta H_{v,b}$ (cal/mol)	Normal boiling point, T_B ($^\circ\text{K}$)	Critical temperature, T_C ($^\circ\text{K}$)	Organic carbon partition coefficient, K_{oc} (cm^3/g)	Pure component water solubility, S (mg/L)	Unit risk factor, URF ($\mu\text{g}/\text{m}^3\text{y}^{-1}$)	Reference conc., RfC (mg/m^3)
8.95E-02	1.03E-05	5.55E-03	25	7,342	353.24	562.16	1.46E+02	1.79E+03	2.9E-05	3.0E-03

END

INTERMEDIATE CALCULATIONS SHEET

Scenario: Residential

Chemical: Benzene

Source-building separation, L_T (cm)	Vadose zone soil air-filled porosity, θ_a^v (cm ³ /cm ³)	Vadose zone effective total fluid saturation, S_{te} (cm ³ /cm ³)	Vadose zone soil intrinsic permeability, k_i (cm ²)	Vadose zone soil relative air permeability, k_{rg} (cm ²)	Vadose zone soil effective vapor permeability, k_v (cm ²)	Thickness of capillary zone, L_{cz} (cm)	Total porosity in capillary zone, n_{cz} (cm ³ /cm ³)	Air-filled porosity in capillary zone, $\theta_{a,cz}$ (cm ³ /cm ³)	Water-filled porosity in capillary zone, $\theta_{w,cz}$ (cm ³ /cm ³)	Floor-wall seam perimeter, X_{crack} (cm)
76	0.238	#N/A	#N/A	#N/A	2.00E-02	46.88	0.442	0.067	0.375	4,000

Bldg. ventilation rate, $Q_{building}$ (cm ³ /s)	Area of enclosed space below grade, A_B (cm ²)	Crack-to-total area ratio, η (unitless)	Crack depth below grade, Z_{crack} (cm)	Enthalpy of vaporization at ave. groundwater temperature, $\Delta H_{v,TS}$ (cal/mol)	Henry's law constant at ave. groundwater temperature, H_{TS} (atm·m ³ /mol)	Henry's law constant at ave. groundwater temperature, H'_{TS} (unitless)	Vapor viscosity at ave. soil temperature, μ_{TS} (g/cm-s)	Vadose zone effective diffusion coefficient, D_v^{eff} (cm ² /s)	Capillary zone effective diffusion coefficient, D_{cz}^{eff} (cm ² /s)	Total overall effective diffusion coefficient, D_T^{eff} (cm ² /s)
3.39E+04	1.00E+06	5.00E-03	15	8,054	3.76E-03	1.58E-01	1.77E-04	5.10E-03	6.89E-05	1.11E-04

Diffusion path length, L_d (cm)	Convection path length, L_p (cm)	Source vapor conc., C_{source} (µg/m ³)	Crack radius, r_{crack} (cm)	Average vapor flow rate into bldg., Q_{soil} (cm ³ /s)	Crack effective diffusion coefficient, D^{crack} (cm ² /s)	Area of crack, A_{crack} (cm ²)	Exponent of equivalent foundation Peclet number, $\exp(Pe^f)$ (unitless)	Infinite source indoor attenuation coefficient, α (unitless)	Infinite source bldg. conc., $C_{building}$ (µg/m ³)	Unit risk factor, URF (µg/m ³) ⁻¹	Reference conc., RfC (mg/m ³)
76	15	1.74E+04	1.25	8.33E-01	5.10E-03	5.00E+03	1.39E+00	2.89E-05	5.02E-01	2.9E-05	3.0E-03

END

Warning: alpha < 6E-05 is unreasonably low.

Well Installation Activities, November 1992

MW5 (5)	11/18/1992	5	<1.0	--	<0.0050	<0.0050	<0.0050	<0.0050	--	--	--	--	--	--	--	--	--	--
MWS (10)	11/18/1992	10	<1.0	--	<0.0050	<0.0050	<0.0050	<0.0050	--	--	--	--	--	--	--	--	--	--
MW5 (15)	11/18/1992	15	<1.0	--	<0.0050	<0.0050	<0.0050	<0.0050	--	--	--	--	--	--	--	--	--	--
MW5 (21)	11/18/1992	21	<1.0	--	<0.0050	<0.0050	<0.0050	<0.0050	--	--	--	--	--	--	--	--	--	--
MW6 (5)	11/18/1992	5	<1.0	--	<0.0050	<0.0050	<0.0050	<0.0050	--	--	--	--	--	--	--	--	--	--
MW6 (10)	11/18/1992	10	<1.0	--	<0.0050	<0.0050	<0.0050	<0.0050	--	--	--	--	--	--	--	--	--	--
MW6 (15)	11/18/1992	15	<1.0	--	<0.0050	<0.0050	<0.0050	<0.0050	--	--	--	--	--	--	--	--	--	--
MW6 (19.5)	11/18/1992	19.5	<1.0	--	<0.0050	<0.0050	<0.0050	<0.0050	--	--	--	--	--	--	--	--	--	--

UST Removal Activities, September 1998

A1 (19)	9/14/1998	19	3.5	--	0.53	0.36	0.069	0.40	<0.050	--	--	--	--	--	--	--	--	26
A2 (18)	9/14/1998	18	12	--	0.050	0.075	<0.0050	0.026	<0.050	--	--	--	--	--	--	--	--	<1.0
B1 (19.5)	9/14/1998	19.5	360	--	1.5	15	7.0	44	<0.050	--	--	--	--	--	--	--	--	1.7
B2 (19.5)	9/14/1998	19.5	6.7	--	0.017	1.8	0.24	1.4	<0.050	--	--	--	--	--	--	--	--	2.7
P1 (6)	9/14/1998	6	<1.0	--	<0.0050	<0.0050	<0.0050	<0.0050	<0.050	--	--	--	--	--	--	--	--	11
P2 (6)	9/14/1998	6	<1.0	--	<0.0050	<0.0050	<0.0050	<0.0050	<0.050	--	--	--	--	--	--	--	--	1.3
P3 (6)	9/14/1998	6	<1.0	--	<0.0050	<0.0050	<0.0050	<0.0050	<0.050	--	--	--	--	--	--	--	--	<1.0
P4 (6)	9/14/1998	6	<1.0	--	<0.0050	<0.0050	<0.0050	<0.0050	<0.050	--	--	--	--	--	--	--	--	<1.0

Soil Boring Investigation, March 2006

SB-1@5	3/27/2006	5	<0.97	--	<0.0049	<0.0049	<0.0049	<0.0097	<0.0049	<0.0097	<0.0049	<0.0049	<0.0049	<0.0049	<0.0049	<0.49	--	--
SB-1@9	3/27/2006	9	2.8	--	<0.0048	<0.0048	<0.0048	<0.0097	<0.0048	<0.0097	<0.0048	<0.0048	<0.0048	<0.0048	<0.0048	<0.48	--	--
SB-2@5	3/27/2006	5	<0.97	--	<0.0049	<0.0049	<0.0049	<0.0097	<0.0049	<0.0097	<0.0049	<0.0049	<0.0049	<0.0049	<0.0049	<0.49	--	--
SB-2@9	3/27/2006	9	<0.93	--	<0.0047	<0.0047	<0.0047	<0.0093	<0.0047	<0.0093	<0.0047	<0.0047	<0.0047	<0.0047	<0.0047	<0.47	--	--
56-3@14	3/27/2006	14	1.3	--	0.11	<0.0046	0.061	0.055	0.64	0.19	<0.0046	<0.0046	<0.0046	<0.0046	<0.0046	<0.46	--	--
SB-3@16	3/27/2006	16	6,100	--	<9.7	53	86	420	<9.7	<19	<9.7	<9.7	<9.7	<9.7	<9.7	<190	--	--
SB-4@5	3/27/2006	5	<0.93	--	<0.0047	<0.0047	<0.0047	<0.0093	<0.0047	<0.0093	<0.0047	<0.0047	<0.0047	<0.0047	<0.0047	<0.47	--	--
56-4@15	3/27/2006	15	<0.92	--	<0.0046	<0.0046	<0.0046	<0.0092	<0.0046	<0.0092	<0.0046	<0.0046	<0.0046	<0.0046	<0.0046	<0.46	--	--
SB-5@9	3/27/2006	9	<0.93	--	<0.0046	<0.0046	<0.0046	<0.0093	<0.0046	<0.0093	<0.0046	<0.0046	<0.0046	<0.0046	<0.0046	<0.46	--	--
SB-5@13	3/27/2006	13	<0.93	--	<0.0047	<0.0047	<0.0047	<0.0093	<0.0047	<0.0093	<0.0047	<0.0047	<0.0047	<0.0047	<0.0047	<0.47	--	--

AS-3-7	5/6/16	7	90	--	<.005	<.005	0.15	<.015	--	--	--	--	--	--	--	--	--	--
AS-3-10	5/6/16	10	550	--	<.005	0.21	6.10	11	--	--	--	--	--	--	--	--	--	--
AS-3-14	5/6/16	14	13	--	0.04	0.01	0.24	0.051	--	--	--	--	--	--	--	--	--	--
AS-3-16	5/6/16	16	690	--	2.4	24	17	94	--	--	--	--	--	--	--	--	--	--
ESL-Direct Exposure (res.)			740	230	0.23	970	5.1	560	42	--	--	--	--	--	0.37	--	11,000	80
ESL-Direct Exposure (construction worker)			2,800	880	24	4,100	480	2,400	3,700	--	--	--	--	--	37	--	31,000	160

Notes:

SG-1 = Soil Gas Levels in $\mu\text{g}/\text{m}^3$

GW Depth = Groundwater depth below top of casing

GW Elevation = Groundwater mean sea level elevation

TPH-G = Total Petroleum Hydrocarbons as Gasoline

B = Benzene

T = Toluene

E = Ethylbenzene

X = Xylenes

MTBE = Methyl-t-Butyl Ether

TBA = tert-Butanol

TAME = Tert-amyl Methyl Ether

DIPE = Diisopropyle ether

ETBE = Ethyl-tert-butyl ether

EDB = Ethylene Dibromide

1,2-DCA = 1,2-Dichloroethane

TOG = Total Oil & Grease (TPH-Motor Oil Final Risk Based Screening Level Table S1-Soil Direct Exposure Human Health Screening Levels)

-- = Not analyzed for this parameter

<0.050 = Not detected above the expressed value

(A) = Sample also analyzed for HVOCs and SVOCs; all nondetect

(B) = Results for Total Petroleum Hydrocarbons as Motor Oil analysis

(C) = Results for Total Petroleum Hydrocarbons as Hydraulic Fluid analysis

Table 2
Grab Groudwater Laboratory Analytical Results
 411 West MacArthur Boulevard
 Oakland, CA

Sample ID	Sample Depth (ft)	Concentration (micrograms per liter, µg/L)					
		TPH-G	B	T	E	X	Naph.
Soil Boring Investigation, ARS, April 8, 2016							
GW-1	20	42,000	110	67	2,600	4,800	2,300
GW-2	20	21,000	39	540	850	3,900	490
GW-3	20	7,800	<5.0	81	230	1,000	190
ESL-Vapor Intrusion (residential)		NL	30	100,000	370	38,000	180
ESL-Vapor Intrusion (commercial)		NL	260	NL	3,300	NL	1,600

Notes:



Areas Shaded in Blue are in excess of RWQCB ESL Feb 2016 Residential limits

Areas Shaded in Brown are in excess of RWQCB ESL Feb 2016 Commercial limits

Table 3
Cumulative Groundwater Monitoring Data and Analytical Results
411 West MacArthur Boulevard
Oakland, CA

Well ID	Date	TOC (ft)	DTW (ft)	GWE	Concentration, micrograms per liter (µg/L)				
					TPH-G	B	T	E	X
MW-1	9/15/1989	--	--	--	ND	ND	0.61	ND	ND
	1/23/1990	--	--	--	ND	1.5	2.3	ND	4.3
	4/19/1990	--	--	--	ND	ND	ND	ND	ND
	7/17/1990	--	--	--	ND	ND	ND	ND	ND
	10/16/1990	--	--	--	ND	ND	ND	ND	ND
	1/15/1991	--	--	--	ND	ND	ND	ND	ND
	4/12/1991	--	--	--	ND	ND	ND	ND	ND
	7/15/1991	--	--	--	ND	ND	ND	ND	ND
	7/14/1992	--	--	--	ND	ND	ND	ND	ND
	4/13/1993	72.43	17.70	54.73	Sampled Annually in the Third Quarter				
	7/14/1993	72.43	18.49	53.94	ND	2.2	2.1	1.1	6.2
	10/14/1993	72.10	18.32	53.78	Sampled Annually in the Third Quarter				
	1/12/1994	72.10	18.18	53.92	Sampled Annually in the Third Quarter				
	4/11/1994	72.10	17.80	54.30	Sampled Annually in the Third Quarter				
	7/7/1994	72.10	18.28	53.82	ND	ND	ND	ND	ND
	10/5/1994	72.10	18.55	53.55	Sampled Annually in the Third Quarter				
	1/9/1995	72.10	17.90	54.20	Sampled Annually in the Third Quarter				
	4/17/1995	72.10	17.22	54.88	Sampled Annually in the Third Quarter				
	7/19/1995	72.10	18.03	54.07	ND	ND	ND	ND	ND
	10/26/1995	72.10	18.67	53.43	Sampled Annually in the Third Quarter				
	1/16/1996	72.10	17.20	54.90	Sampled Annually in the Third Quarter				
	4/15/1996	72.10	17.40	54.70	Sampled Annually in the Third Quarter				
	7/11/1996	72.10	18.03	54.07	ND	ND	ND	ND	ND
	1/17/1997	72.10	16.54	55.56	Sampled Annually in the Third Quarter				
	7/21/1997	72.10	18.16	53.94	ND	ND	ND	ND	ND
	1/14/1998	72.10	16.05	56.05	Sampled Annually in the Third Quarter				
	7/6/1998	72.10	16.46	55.64	ND	ND	ND	ND	ND
	1/13/1999	72.10	17.37	54.73	Sampled Annually in the Third Quarter				
	8/31/1999	72.12	17.00	55.12	ND	ND	ND	ND	ND
	1/21/2000	72.12	17.04	55.08	Sampled Annually in the Third Quarter				
	7/10/2000	72.12	18.10	54.02	ND	ND	ND	ND	ND
	1/4/2001	72.12	17.95	54.17	Sampled Annually in the Third Quarter				
	7/16/2001	72.12	18.03	54.09	ND	ND	ND	ND	ND
	1/28/2002	72.12	17.31	54.81	Sampled Annually in the Third Quarter				
	7/12/2002	72.12	18.15	53.97	<50	<0.50	<0.50	<0.50	<0.50
	1/14/2003	72.12	17.66	54.46	Sampled Annually in the Third Quarter				
	7/10/2003	72.12	17.86	54.26	<50	<0.30	<0.30	<0.30	<0.60
	2/4/2004	72.12	17.43	54.69	Sampled Annually in the Third Quarter				
	7/29/2004	72.12	18.12	54.00	<50	<0.30	<0.38	<0.30	<0.6
	3/2/2005	72.12	16.15	55.97	Sampled Annually in the Third Quarter				

	9/30/2005	72.12	18.04	54.08	<50	<0.30	<0.38	<0.30	<0.6
	3/23/2006	72.12	--	--	Sampled Annually in the Third Quarter				
	9/26/2006	72.12	17.90	54.22	<50	<0.30	<0.30	<0.30	<0.6
	3/15/2007	72.12	17.22	54.90	Sampled Annually in the Third Quarter				
	9/27/2007	72.12	18.49	53.63	<50	<0.30	<0.30	<0.30	<0.6
	3/27/2008	72.12	17.57	54.55	Sampled Annually in the Third Quarter				
	9/17/2008	72.12	18.20	53.92	<50	<0.30	<0.30	<0.30	<0.6
	3/27/2009	72.12	16.75	55.37	Sampled Annually in the Third Quarter				
	9/17/2009	72.12	18.18	53.94	<50	<0.30	<0.30	<0.30	<0.6
	3/23/2010	72.12	17.34	54.78	Sampled Annually in the Third Quarter				
	9/21/2010	72.12	18.74	53.38	<50	<0.30	<0.30	<0.30	<0.6
	3/30/2011	72.12	16.68	55.44	Sampled Annually in the Third Quarter				
	9/6/2011	72.12	18.36	53.76	<50	<0.30	<0.30	<0.30	<0.60
	2/3/2012	72.12	18.02	54.10	Sampled Annually in the Third Quarter				
	8/17/2012	72.12	18.50	53.62	<50	<0.30	<0.30	<0.30	<0.60
	2/14/2013	72.12	17.98	54.14	Sampled Annually in the Third Quarter				
	8/1/2013	72.12	18.45	53.67	<50	<0.30	<0.30	<0.30	<0.60
	2/5/2014	72.12	18.75	53.37	Sampled Annually in the Third Quarter				
MW-2	9/15/1989	--	--	--	290	ND	12	ND	ND
	1/23/1990	--	--	--	400	73	36	10	40
	4/19/1990	--	--	--	3900	550	5.1	91	390
	7/17/1990	--	--	--	490	76	0.6	11	46
	10/16/1990	--	--	--	1400	430	2.0	48	240
	1/15/1991	--	--	--	680	170	0.7	19	81
	4/12/1991	--	--	--	2200	160	4.3	23	62
	7/15/1991	--	--	--	2200	770	12	72	370
	10/15/1991	--	--	--	140	44	0.56	1.5	12
	1/15/1992	--	--	--	220	37	0.52	1.1	7
	4/14/1992	--	--	--	150	6.2	ND	ND	1.4
	7/14/1992	--	--	--	130	3.7	ND	ND	ND
	10/12/1992	--	--	--	370	3.4	0.56	ND	11
	1/8/1993	--	--	--	510	ND	ND	ND	ND
	4/13/1993	71.63	17.86	53.77	410	42	7.7	6.4	28
	7/14/1993	71.63	18.38	53.25	110	6.5	ND	ND	1.1
	10/14/1993	71.38	18.20	53.18	230	5.3	ND	ND	2.1
	1/12/1994	71.38	18.08	53.30	300	7.8	3.8	1.8	10
	4/9/1994	71.38	17.97	53.41	120	10	0.88	1.1	4.9
	4/11/1994	71.38	17.88	53.50	--	--	--	--	--
	7/7/1994	71.38	17.81	53.57	110	4.4	ND	ND	ND
	10/5/1994	71.38	18.33	53.05	720	20	ND	ND	3.1
	1/9/1995	71.38	17.40	53.98	ND	ND	ND	ND	ND
	4/17/1995	71.38	17.50	53.88	93	5.6	0.62	1.7	5.5
	7/19/1995	71.38	18.01	53.37	77	32	0.58	1.7	4.1
	10/26/1995	71.38	18.21	53.17	54	13	ND	ND	0.72
	1/16/1996	71.38	16.58	54.80	120	23	ND	ND	0.99
	4/15/1996	71.38	17.61	53.77	340	21	ND	2.2	3.7

	7/11/1996	71.38	17.98	53.40	540	34	ND	4.3	12
	1/17/1997	71.38	17.08	54.30	320	63	2.4	9.4	26
	7/21/1997	71.38	18.06	53.32	160	13	ND	1.3	1.6
	1/14/1998	71.38	16.52	54.86	66	6.3	ND	ND	0.98
	7/6/1998	71.38	16.87	54.51	ND	2.3	ND	ND	ND
	1/13/1999	71.38	17.88	53.50	53	24	ND	0.52	0.98
	8/31/1999	71.34	18.45	52.89	86	14.00	ND	0.63	ND
	1/21/2000	71.34	17.73	53.61	ND	1.94	ND	ND	ND
	7/10/2000	71.34	18.14	53.20	ND	ND	ND	ND	ND
	1/4/2001	71.34	18.02	53.32	ND	0.925	ND	ND	ND
	7/16/2001	71.34	18.02	53.32	ND	ND	ND	ND	ND
	1/28/2002	71.34	17.57	53.77	<50	<0.50	<0.50	<0.50	<0.50
	7/12/2002	71.34	18.05	53.29	<50	<0.50	<0.50	<0.50	<0.50
	1/14/2003	71.34	17.44	53.90	<50	<0.50	<0.50	<0.50	<0.50
	7/10/2003	71.34	--	--	--	--	--	--	--
	2/4/2004	71.34	17.22	54.12	<50	<0.50	<0.50	<0.50	<0.50
	7/29/2004	71.34	--	--	--	--	--	--	--
	3/2/2005	71.34	16.63	54.71	99	26	<0.50	3.5	2.8
	9/30/2005	71.34	17.94	53.40	<50	1.2	<0.30	<0.30	<0.60
	3/23/2006	71.34	16.74	54.60	<50	3.6	<0.30	0.35	<0.60
	9/26/2006	71.34	17.91	53.43	<50	1.2	<0.30	<0.30	<0.60
	3/15/2007	71.34	17.45	53.89	110	6.5	<0.30	0.70	<0.60
	9/27/2007	71.34	18.23	53.11	<50	<0.30	<0.30	<0.30	<0.60
	3/27/2008	71.34	17.77	53.57	<50	1.8	<0.30	<0.30	<0.60
	9/17/2008	71.34	18.06	53.28	<50	1.6	<0.30	<0.30	<0.60
	3/27/2009	71.34	17.43	53.91	<50	3.5	<0.30	<0.30	<0.60
	9/17/2009	71.34	18.01	53.33	<50	2.7	<0.30	<0.30	<0.60
	3/23/2010	71.34	17.47	53.87	<50	0.68	<0.30	<0.30	<0.60
	9/21/2010	71.34	18.41	52.93	69	1.6	<0.30	<0.30	<0.60
	3/30/2011	71.34	16.58	54.76	<50	<0.30	<0.30	<0.30	<0.60
	9/6/2011	71.34	18.14	53.20	<50	<0.30	<0.30	<0.30	<0.60
	2/3/2012	71.34	17.97	53.37	<50	<0.30	<0.30	<0.30	<0.60
	8/17/2012	71.34	18.20	53.14	57	1.2	<0.30	<0.30	<0.60
	2/14/2013	71.34	17.88	53.46	<50	<0.30	<0.30	<0.30	<0.60
	8/1/2013	71.34	16.30	55.04	<50	<0.30	<0.30	<0.30	<0.60
	2/5/2014	71.34	18.34	53.00	<50	<0.30	<0.30	<0.30	<0.60
MW-3	9/15/1989	--	--	--	32	ND	ND	ND	ND
	1/23/1990	--	--	--	450	110	1.2	4.4	11
	4/19/1990	--	--	--	3,100	600	27	54	220
	7/17/1990	--	--	--	4,000	270	48	130	250
	10/16/1990	--	--	--	740	210	1.4	2.5	82
	1/15/1991	--	--	--	3,200	460	1.5	120	270
	4/12/1991	--	--	--	880	170	1.1	34	110
	7/15/1991	--	--	--	9,200	1300	230	490	1900
	10/15/1991	--	--	--	3,100	390	34	150	390
	1/15/1992	--	--	--	3,000	590	14	310	750

4/14/1992	--	--	--	14,000	660	48	560	2000
7/14/1992	--	--	--	21,000	890	200	1200	4300
10/12/1992	--	--	--	3,200	160	10	230	540
1/8/1993	--	--	--	1,100	48	0.99	0.9	93
4/13/1993	72.06	17.96	54.10	12,000	290	38	760	2300
7/14/1993	72.06	18.54	53.52	6,300	190	ND	430	1000
10/14/1993	71.86	18.45	53.41	2,500	52	ND	110	250
1/12/1994	71.86	18.34	53.52	3,800	78	ND	180	390
4/9/1994	71.86	18.19	53.67	1,800	22	ND	140	280
4/11/1994	71.86	18.12	53.74	--	--	--	--	--
7/7/1994	71.86	18.21	53.65	110	4.5	ND	ND	ND
10/5/1994	71.86	18.58	53.28	ND	ND	ND	ND	ND
1/9/1995	71.86	17.69	54.17	ND	0.68	ND	ND	ND
4/17/1995	71.86	17.68	54.18	3,700	80	10	270	510
7/19/1995	71.86	18.20	53.66	15,000	330	27	990	2400
10/26/1995	71.86	18.32	53.54	14,000	420	180	750	1600
1/16/1996	71.86	17.95	53.91	920	38	ND	30	57
4/15/1996	71.86	17.78	54.08	9,700	240	ND	570	860
7/11/1996	71.86	18.19	53.67	13,000	69	5.5	430	900
1/17/1997	71.86	17.23	54.63	4,400	25	ND	270	580
7/21/1997	71.86	18.29	53.57	9,000	36	ND	450	800
1/14/1998	71.86	16.71	55.15	7,100	40	ND	380	360
7/6/1998	71.86	17.03	54.83	6,800	39	ND	320	360
1/13/1999	71.86	18.00	53.86	1,800	9.4	ND	58	36
8/31/1999	71.40	--	--	--	--	--	--	--
1/21/2000	71.40	17.58	53.82	ND	ND	ND	ND	ND
7/10/2000	71.40	18.05	53.35	ND	ND	ND	ND	ND
8/25/2000	71.40	17.82	53.58	--	--	--	--	--
1/4/2001	71.40	18.16	53.24	ND	ND	ND	ND	ND
7/16/2001	71.40	17.98	53.42	ND	ND	ND	ND	ND
1/28/2002	71.40	17.84	53.56	<50	ND<0.50	ND<0.50	ND<0.50	ND<0.50
7/12/2002	71.40	17.87	53.53	<50	ND<0.50	ND<0.50	ND<0.50	ND<0.50
1/14/2003	71.40	17.28	54.12	<50	ND<0.50	ND<0.50	ND<0.50	ND<0.50
7/10/2003	71.40	17.64	53.76	<50	ND<0.50	ND<0.50	ND<0.50	ND<0.50
2/4/2004	71.40	17.05	54.35	<50	ND<0.50	ND<0.50	ND<0.50	ND<0.50
7/29/2004	71.40	17.82	53.58	<50	<0.30	<0.30	<0.30	<0.60
3/2/2005	71.40	16.47	54.93	93	<0.50	<0.50	<0.50	<0.50
9/30/2005	71.40	17.79	53.61	65	<0.30	<0.30	<0.30	<0.60
3/23/2006	71.40	16.61	54.79	54	<0.30	0.41	ND<0.30	0.98
9/26/2006	71.40	17.77	53.63	51	<0.30	<0.30	<0.30	<0.60
3/15/2007	71.40	17.27	54.13	140	<0.30	<0.30	<0.30	<0.60
9/27/2007	71.40	18.48	52.92	<50	<0.30	<0.30	<0.30	<0.60
3/27/2008	71.40	17.67	53.73	<50	<0.30	<0.30	<0.30	<0.60
9/17/2008	71.40	17.91	53.49	56	<0.30	<0.30	<0.30	<0.60
3/27/2009	71.40	17.34	54.06	<50	<0.30	<0.30	<0.30	<0.60
9/17/2009	71.40	17.88	53.52	<50	<0.30	<0.30	<0.30	<0.60
3/23/2010	71.40	17.33	54.07	<50	<0.30	<0.30	<0.30	<0.60

	9/21/2010	71.40	18.28	53.12	69	<0.30	<0.30	<0.30	<0.60
	3/30/2011	71.40	16.50	54.90	110	<0.30	<0.30	<0.30	<0.60
	9/6/2011	71.40	18.03	53.37	<50	<0.30	<0.30	<0.30	<0.60
	2/3/2012	71.40	17.83	53.57	<50	<0.30	<0.30	<0.30	<0.60
	8/17/2012	71.40	18.07	53.33	<50	<0.30	<0.30	<0.30	<0.60
	2/14/2013	71.40	17.72	53.68	<50	<0.30	<0.30	<0.30	<0.60
	8/1/2013	71.40	18.02	53.38	<50	<0.30	<0.30	<0.30	<0.60
	2/5/2014	71.40	18.24	53.16	<50	<0.30	<0.30	<0.30	<0.60
MW-4	9/15/1989	--	--	--	ND	ND	ND	ND	ND
	1/23/1990	--	--	--	ND	ND	ND	ND	
	4/19/1990	--	--	--	ND	ND	ND	ND	
	7/17/1990		--	--	ND	ND	ND	ND	ND
	10/16/1990	--	--	--	ND	ND	ND	ND	ND
	1/15/1991	--	--	--	ND	ND	--	ND	
	4/12/1991		--	--	ND	ND	ND	ND	ND
	7/15/1991	--	--	--	ND	ND	ND	ND	ND
	7/14/1992	--	--	--	ND	2.5	ND	1.0	
	4/13/1993	71.98	17.67	54.31	Sampled Annually in the Third Quarter				
	7/14/1993	71.98	18.31	53.67	ND	ND	ND	ND	ND
	10/14/1993	71.64	18.08	53.56	Sampled Annually in the Third Quarter				
	1/12/1994	71.64	17.97	53.67	Sampled Annually in the Third Quarter				
	4/11/1994	71.64	17.70	53.94	Sampled Annually in the Third Quarter				
	7/7/1994	71.64	17.80	53.84	ND	ND	ND	ND	ND
	10/5/1994	71.64	18.28	53.36	Sampled Annually in the Third Quarter				
	1/9/1995	71.64	17.38	54.26	Sampled Annually in the Third Quarter				
	4/17/1995	71.64	17.21	54.43	Sampled Annually in the Third Quarter				
	7/19/1995	71.64	17.82	53.82	ND	ND	ND	ND	ND
	10/26/1995	71.64	18.17	53.47	Sampled Annually in the Third Quarter				
	1/16/1996	71.64	16.45	55.19	Sampled Annually in the Third Quarter				
	4/15/1996	71.64	17.35	54.29	Sampled Annually in the Third Quarter				
	7/11/1996	71.64	17.81	53.83	ND	ND	ND	ND	ND
	1/17/1997	71.64	16.73	54.91	Sampled Annually in the Third Quarter				
	7/21/1997	71.64	17.91	53.73	ND	ND	ND	ND	ND
	1/14/1998	71.64	16.18	55.46	Sampled Annually in the Third Quarter				
	7/6/1998	71.64	16.49	55.15	ND	ND	ND	ND	ND
	1/13/1999	71.64	17.29	54.35	Sampled Annually in the Third Quarter				
	8/31/1999	71.54	--	--	Sampled Annually in the Third Quarter				
	1/21/2000	71.54	17.51	54.03	Sampled Annually in the Third Quarter				
	7/10/2000	71.54	17.93	53.61	ND	ND	ND	ND	ND
	1/4/2001	71.54	18.10	53.44	Sampled Annually in the Third Quarter				
	7/16/2001	71.54	17.76	53.78	ND	ND	ND	ND	ND
	1/28/2002	71.54	17.20	54.34	Sampled Annually in the Third Quarter				
	7/12/2002	71.54	17.81	53.73	<50	<0.50	<0.50	<0.50	<0.50
	1/14/2003	71.54	17.30	54.24	Sampled Annually in the Third Quarter				
	7/10/2003	71.54	17.58	53.96	<50	<0.50	<0.50	<0.50	<0.50
	2/4/2004	71.54	17.07	54.47	Sampled Annually in the Third Quarter				

	7/29/2004	71.54	17.81	53.73	<50	<0.30	<0.30	<0.30	<0.60
	3/2/2005	71.54	16.25	55.29	Sampled Annually in the Third Quarter				
	9/30/2005	71.54	17.74	53.80	<50	<0.30	<0.30	<0.30	<0.60
	3/23/2006	71.54	--	--	Sampled Annually in the Third Quarter				
	9/26/2006	71.54	17.71	53.83	<50	<0.30	<0.30	<0.30	<0.60
	3/15/2007	71.54	17.56	53.98	Sampled Annually in the Third Quarter				
	9/27/2007	71.54	18.16	53.38	<50	<0.30	<0.30	<0.30	<0.60
	3/27/2008	71.54	17.58	53.96	Sampled Annually in the Third Quarter				
	9/17/2008	71.54	17.87	53.67	<50	<0.30	<0.30	<0.30	<0.60
	3/27/2009	71.54	17.17	54.37	Sampled Annually in the Third Quarter				
	9/17/2009	71.54	17.86	53.68	<50	<0.30	<0.30	<0.30	<0.60
	3/23/2010	71.54	17.25	54.29	Sampled Annually in the Third Quarter				
	9/21/2010	71.54	18.31	53.23	<50	<0.30	<0.30	<0.30	<0.60
	3/30/2011	71.54	16.35	55.19	Sampled Annually in the Third Quarter				
	9/6/2011	71.54	18.00	53.54	<50	<0.30	<0.30	<0.30	<0.60
	2/3/2012	71.54	17.81	53.73	Sampled Annually in the Third Quarter				
	8/17/2012	71.54	18.09	53.45	<50	<0.30	<0.30	<0.30	<0.60
	2/14/2013	71.54	17.68	53.86	Sampled Annually in the Third Quarter				
	8/1/2013	71.54	18.05	53.49	<50	<0.30	<0.30	<0.30	<0.60
	2/5/2014	--	--	--	Sampled Annually in the Third Quarter				
MW-5	11/30/1992	--	--	--	ND	ND	ND	ND	ND
	1/8/1993	--	--	--	ND	ND	ND	ND	ND
	4/13/1993	71.51	17.49	54.02	ND	ND	ND	ND	ND
	7/14/1993	71.51	18.02	53.49	ND	ND	0.57	ND	ND
	10/14/1993	71.23	17.82	53.41	ND	ND	ND	ND	ND
	1/12/1994	71.23	17.74	53.49	ND	ND	0.84	ND	1.6
	4/11/1994	71.23	17.56	53.67	Sampled Annually in the Third Quarter				
	7/7/1994	71.23	17.50	53.73	ND	ND	ND	ND	ND
	10/5/1994	71.23	17.98	53.25	Sampled Annually in the Third Quarter				
	1/9/1995	71.23	17.13	53.25	Sampled Annually in the Third Quarter				
	4/17/1995	71.23	17.05	53.25	Sampled Annually in the Third Quarter				
	7/19/1995	71.23	17.59	53.25	ND	ND	ND	ND	ND
	10/26/1995	71.23	18.10	53.25	Sampled Annually in the Third Quarter				
	1/16/1996	71.23	17.11	53.25	Sampled Annually in the Third Quarter				
	4/15/1996	71.23	17.22	53.25	Sampled Annually in the Third Quarter				
	7/11/1996	71.23	17.59	53.25	ND	ND	ND	ND	ND
	1/17/1997	71.23	16.75	53.25	Sampled Annually in the Third Quarter				
	7/21/1997	71.23	17.59	53.25	ND	ND	ND	ND	ND
	1/14/1998	71.23	16.16	53.25	Sampled Annually in the Third Quarter				
	7/6/1998	71.23	16.52	53.25	ND	ND	ND	ND	ND
	1/13/1999	71.23	17.62	53.25	Sampled Annually in the Third Quarter				
	8/31/1999	71.16	17.76	53.25	ND	ND	ND	ND	ND
	1/21/2000	71.16	16.83	53.25	Sampled Annually in the Third Quarter				
	7/10/2000	71.16	17.46	53.25	ND	ND	ND	ND	ND
	1/4/2001	71.16	17.51	53.25	Sampled Annually in the Third Quarter				
	7/16/2001	71.16	17.32	53.25	ND	ND	ND	ND	ND

	1/28/2002	71.16	17.12	53.25	Sampled Annually in the Third Quarter				
	7/12/2002	71.16	17.12	53.25	<50	<0.50	<0.50	<0.50	<0.50
	1/14/2003	71.16	16.67	53.25	Sampled Annually in the Third Quarter				
	7/10/2003	71.16	17.39	53.25	<50	<0.50	<0.50	<0.50	<0.50
	2/4/2004	71.16	16.23	53.25	Sampled Annually in the Third Quarter				
	7/29/2004	71.16	16.02	53.25	<50	<0.30	0.64	<0.30	0.79
	3/2/2005	71.16	16.43	53.25	Sampled Annually in the Third Quarter				
	9/30/2005	71.16	17.41	53.25	<50	<0.30	<0.30	<0.30	<0.60
	3/23/2006	71.16	16.37	53.25	Sampled Annually in the Third Quarter				
	9/26/2006	71.16	15.54	53.25	<50	<0.30	<0.30	<0.30	<0.60
	3/15/2007	71.16	17.20	53.25	Sampled Annually in the Third Quarter				
	9/27/2007	71.16	18.01	53.25	<50	<0.30	<0.30	<0.30	<0.60
	3/27/2008	71.16	17.57	53.25	Sampled Annually in the Third Quarter				
	9/17/2008	71.16	17.68	53.25	<50	<0.30	<0.30	<0.30	<0.60
	3/27/2009	71.16	17.14	53.25	Sampled Annually in the Third Quarter				
	9/17/2009	71.16	17.60	53.25	<50	<0.30	<0.30	<0.30	<0.60
	3/23/2010	71.16	17.84	53.25	Sampled Annually in the Third Quarter				
	9/21/2010	71.16	17.92	53.25	<50	<0.30	<0.30	<0.30	<0.60
	3/30/2011	71.16	15.87	53.25	Sampled Annually in the Third Quarter				
	9/6/2011	71.16	17.74	53.25	<50	<0.30	<0.30	<0.30	<0.60
	2/3/2012	71.16	17.69	53.25	Sampled Annually in the Third Quarter				
	8/17/2012	71.16	17.75	53.25	<50	<0.30	<0.30	<0.30	<0.60
	2/14/2013	71.16	17.51	53.25	Sampled Annually in the Third Quarter				
	8/1/2013	71.16	17.71	53.25	<50	<0.30	<0.30	<0.30	<0.60
	2/5/2014	71.16	17.96	53.25	Sampled Annually in the Third Quarter				
MW-6	11/30/1992	--	--	--	ND	ND	ND	ND	ND
	1/8/1993	--	--	--	ND	ND	ND	ND	ND
	4/13/1993	71.79	11.94	59.85	ND	ND	ND	ND	ND
	7/14/1993	71.79	17.20	54.59	ND	0.99	2.4	ND	1.9
	10/14/1993	71.44	17.21	54.23	ND	ND	0.64	ND	ND
	1/12/1994	71.44	17.44	54.00	ND	ND	1.2	ND	2.9
	4/11/1994	71.44	13.66	57.78	Sampled Annually in the Third Quarter				
	7/7/1994	71.44	14.05	57.39	ND	ND	ND	ND	ND
	10/5/1994	71.44	14.16	57.28	Sampled Annually in the Third Quarter				
	1/9/1995	71.44	13.73	57.71	Sampled Annually in the Third Quarter				
	4/17/1995	71.44	11.30	60.14	Sampled Annually in the Third Quarter				
	7/19/1995	71.44	12.32	59.12	ND	ND	ND	ND	ND
	10/26/1995	71.44	17.88	53.56	Sampled Annually in the Third Quarter				
	1/16/1996	71.44	16.38	55.06	Sampled Annually in the Third Quarter				
	4/15/1996	71.44	14.00	57.44	Sampled Annually in the Third Quarter				
	7/11/1996	71.44	13.58	57.86	ND	ND	ND	ND	ND
	1/17/1997	71.44	15.42	56.02	Sampled Annually in the Third Quarter				
	7/21/1997	71.44	13.78	57.66	ND	ND	ND	ND	ND
	1/14/1998	71.44	13.65	57.79	Sampled Annually in the Third Quarter				
	7/6/1998	71.44	13.90	57.54	ND	ND	ND	ND	ND
	1/13/1999	71.44	14.93	56.51	Sampled Annually in the Third Quarter				

8/31/1999	71.37	15.81	55.56	ND	ND	ND	ND	ND
1/21/2000	71.37	16.13	55.24	Sampled Annually in the Third Quarter				
7/10/2000	71.37	16.95	54.42	ND	ND	ND	ND	ND
1/4/2001	71.37	17.09	54.28	Sampled Annually in the Third Quarter				
7/16/2001	71.37	16.83	54.54	ND	ND	ND	ND	ND
1/28/2002	71.37	14.58	56.79	Sampled Annually in the Third Quarter				
7/12/2002	71.37	16.76	54.61	<50	<0.50	<0.50	<0.50	<0.50
1/14/2003	71.37	16.25	55.12	Sampled Annually in the Third Quarter				
7/10/2003	71.37	12.97	58.40	<50	<0.50	<0.50	<0.50	<0.50
2/4/2004	71.37	16.20	55.17	Sampled Annually in the Third Quarter				
7/29/2004	71.37	14.98	56.39	<50	<0.50	<0.50	<0.50	<0.50
3/2/2005	71.37	14.51	56.86	Sampled Annually in the Third Quarter				
9/30/2005	71.37	14.45	56.92	<50	<0.30	<0.30	<0.30	<0.6
3/23/2006	71.37	16.55	54.82	Sampled Annually in the Third Quarter				
9/26/2006	71.37	17.58	53.79	<50	<0.30	<0.30	<0.30	<0.60
3/15/2007	71.37	13.72	57.65	Sampled Annually in the Third Quarter				
9/27/2007	71.37	14.18	57.19	<50	<0.30	<0.30	<0.30	<0.60
3/27/2008	71.37	14.83	56.54	Sampled Annually in the Third Quarter				
9/17/2008	71.37	14.70	56.67	<50	<0.30	<0.30	<0.30	<0.60
3/27/2009	71.37	15.66	55.71	Sampled Annually in the Third Quarter				
9/17/2009	71.37	15.31	56.06	<50	<0.30	<0.30	<0.30	<0.60
3/23/2010	71.37	15.42	55.95	Sampled Annually in the Third Quarter				
9/21/2010	71.37	15.62	55.75	<50	<0.30	<0.30	<0.30	<0.60
3/30/2011	71.37	14.12	57.25	Sampled Annually in the Third Quarter				
9/6/2011	71.37	15.07	56.30	<50	<0.30	<0.30	<0.30	<0.60
2/3/2012	71.37	14.88	56.49	Sampled Annually in the Third Quarter				
8/17/2012	71.37	16.08	55.29	<50	<0.30	<0.30	<0.30	<0.60
2/14/2013	71.37	13.66	57.71	Sampled Annually in the Third Quarter				
8/1/2013	71.37	13.58	57.79	<50	<0.30	<0.30	<0.30	<0.60
2/14/2013	71.37	15.69	55.68	Sampled Annually in the Third Quarter				
ESL-Vapor Intrusion (residential)				NL	30	100,000	370	38,000
ESL-Vapor Intrusion (commercial)				NL	260	NL	3,300	NL

Notes:

TOC = Top of casing mean sea level elevation, in feet

DTW = Depth to water, in feet below top of casing

GWE = Groundwater mean sea level elevation, in feet

TPH-G = Total Petroleum Hydrocarbons as Gasoline

B = Benzene

T = Toluene

E = Ethylbenzene

X = Xylenes

<50 = Not detected above the expressed value

Table 4
SOIL GAS LABORATORY ANALYTICAL RESULTS
 411 W. MacArthur Blvd., Oakland, CA

Sample ID	Date	Sample Depth	TPH-G (ug/m ³)	B (ug/m ³)	T (ug/m ³)	E (ug/m ³)	X (ug/m ³)	Naphth. (ug/m ³)	Methane (%)	CO2 (%)	N (%)	O2 (%)	Helium (%)
SG-1	4/15/2016	16.0 ft	150,000	39	210	360	1,100	<53	0.50	0.12	NA	11.0	<0.050
SG-2	4/8/2016	5.5 ft	1,900,000	450	<190	<220	<660	<530	21	5.2	NA	2.5	4.3
SG-3	4/8/2016	5.5 ft	2,700,000	<160	<190	390	<660	<530	23	4.2	NA	0.76	<0.050
Soil Gas ESL-Residential			300,000	48	1.6E+05	560	5.2E+04	41	LEL = 4.4 UEL = 17	--	--	--	--
Soil Gas ESL-Commercial			2,500,000	420	1.3E+06	4,900	4.4E+05	360	LEL = 4.4 UEL = 17	--	--	--	--

Table Notes

TPH-G = Total Petroleum Hydrocarbons as Gasoline

B = Benzene

T = Toluene

E = Ethylbenzene

X = Xylenes

Naphth. = Naphthalene

ug/m³ = micrograms per cubic meter

% = Percent

<0190 = Not detected above the expressed detection level.

LEL = Lower explosion limit

UEL = Upper explosion limit

 Elevated Levels Shaded

Table 5
Summary of Indoor Air Modeling Parameters⁸
 411 West MacArthur Boulevard
 Oakland, CA

Parameter	Proposed On-Site Residential Building		
	Value	Units	Reference
Building			
Building Length, Width and Height	4,267 x 2,136 x 1,676	cm	Site-specific building parameters (approximately 30 feet x 60 feet) assuming an 8-foot ceiling
Indoor Air Exchange Rate	5	1/hour	Default for a commercial/Residential building ³
Average Vapor Flow Rate Into Building	0.05	L/min	Model calculated
Slab or Basement Scenario	Slab-on-Grade	-	Most likely scenario for California
Depth below grade to bottom of enclosed floor space			
	15	cm	Default for slab-on-grade construction ¹
Soil			
SCL Soil Type	Clay	-	Site specific ⁷
Vadose zone soil dry bulk density	1.66	g/cm ³	Site specific ²
Vadose zone soil total porosity	0.375	cm ³ /cm ³	Site specific ²
Vadose zone soil water-filled porosity	0.054	cm ³ /cm ³	Site specific ²
Soil Vapor Sample Depth	168	cm	Site specific (5.5 feet/15 feet)
Soil Temperature	16.67	°C	Model calculated ⁶
Exposure			
Exposure Duration	25	year	Default assumption for Commercial/Industrial Worker ⁴
Exposure Frequency	250	day/year	Default assumption for Commercial/Industrial Worker ⁴
Averaging Time - Noncarcinogens	25	year	Default assumption for Commercial/Industrial Worker ⁴

Parameter	Proposed On-Site Residential Building		
	Value	Units	Reference
Averaging Time - Carcinogens	70	year	Default assumption for Commercial/Industrial Worker ⁴
Exposure			
Exposure Duration	26	year	Default assumption for Residential ⁴
Exposure Frequency	350	day/year	Default assumption for Residential ⁴
Averaging Time - Noncarcinogens	26	year	Default assumption for Residential ⁴
Averaging Time - Carcinogens	70	year	Default assumption for Residential ⁴
Toxicity Values			
Benzene			
Unit Risk Factor	2.90E-05	($\mu\text{g}/\text{m}^3$) ⁻¹	CalEPA (2013)
Reference Concentration	3.00E-02	(mg/m^3)	CalEPA (2013)
Ethylbenzene			
Unit Risk Factor	2.50E-06	($\mu\text{g}/\text{m}^3$) ⁻¹	CalEPA (2013)
Reference Concentration	1.00E+00	(mg/m^3)	CalEPA (2013)
Toluene			
Reference Concentration EPA	5.00E+00	(mg/m^3)	USEPA ⁵
Reference Concentration	3.00E-01	(mg/m^3)	CalEPA (2013)
Methyl CycloHexane (Gasoline)			
Reference Concentration EPA	3.00E+00	(mg/m^3)	USEPA ⁵
Napthalene			
Unit Risk Factor	3.40E-05	($\mu\text{g}/\text{m}^3$) ⁻¹	CalEPA (2013)
Reference Concentration	3.00E-03	(mg/m^3)	CalEPA (2013)
Notes:			
bgs = Below ground surface			
cm = Centimeter			
cm ³ = Cubic centimeter			
$\mu\text{g}/\text{m}^3$ = Micrograms per cubic meter			
g/cm ³ = Grams per cubic meter			
cm ³ /cm ³ = Cubic meter per cubic meter			
°C = Degrees Celsius			

^oF = Degrees Celsius

CalEPA (2013) = California Environmental Protection Agency, OEHHA Toxicity Criteria Database, 2013

DTSC/HERO (2011) = Department of Toxic Substances Control/Office of Human and Ecological Risk

DTSC/HERD = Department of Toxic Substances Control/Human and Ecological Risk Division

NA = Not Available

OEHHA = Office of Environmental Health Hazard Assessment

OSWER = Office of Solid Waste and Emergency Response

USCS = Unified Soil Classification System

USEPA = United States Environmental Protection Agency

¹Johnson & Ettinger (J&E) Model, Version 3.1, February 2004, adjusted with DTSC/HERD recommended default values

²Based on the site-specific geotechnical testing

³CalEPA 2011a Final Guidance for the Evaluation and Mitigation of Subsurface Vapor Intrusion to Indoor Air. DTSC, CalEPA, October 2011

⁴USEPA 1991 Human Health Evaluation Manual: Supplemental Guidance: Standard Default Exposure Factors. OSWER Directive March 25, 1991

⁵USEPA Recommended Toxicity November 2013 RSL Table

⁶User's Guide for JE Model (2004), 62 ^oF for Oakland, CA

⁷Top 5 feet of soil consists primarily of clay w/minor amount of silt. Clay was used as the USCS soil category that best describes Site soil, based on Guidance in Table 11 of the JE Model User's Guide

⁸Inputs not referred to on this table are set at default values.

Table 6
Summary of Soil Vapor Modeling Results
 411 West MacArthur Boulevard
 Oakland, CA

COPC ¹ (Exposure Scenario)	Max Soil Vapor Concentration (µg/m ³)	Location of Max Soil Vapor Concentration	ELRC ²	HI ²	DTSC Rec Tox Criteria Values (µg/m ³) ⁻¹ to Calculate Risk and Hazard (3/2014)	Inhalation Unit Risk Factor (IUR) (ug/m ³) ⁻¹
Benzene-Residential	450	SG-2	6.1E-06	0.19	2.95E-05	7.80E-06
Benzene-Commercial	450	SG-2	7.00E-07	0.022	2.95E-06	7.80E-06
TPH-g-Commercial ³	2,700,000	SG-3	N/A	0.51	N/A	N/A
Ethylbenzene-Residential	390	SG-3	4.00E-07	4.30E-04	2.50E-06	2.50E-06
O-Xylene-Residential	1,100	SG-1	N/A	0.012	N/A	N/A
Toluene-Residential	210	SG-1	N/A	0.26	N/A	N/A
Total Residential ELCR/HI			6.50E-06	0.46		
Total Commercial ELCR/HI			7.00E-07	0.53		

Notes:

¹Chemicals of Potential Concern

²Estimated using the CalEPA DTSC (Vapor Intrusion Guidance 2011)/HERO version of the Johnson and Ettinger Model Spreadsheets-Soil Gas Screening (March 2014) and model inputs presented in Table 5

³ Estimated by utilizing C7-C9 Cyclohexanone as a surrogate

ELCR: Potential Excess Lifetime Cancer Risk

HI: Hazard Index

Attenuation Factors:

- Benzene Attenuation Factor (Residential) = 1.3E-03
- Benzene Attenuation Factor (Commercial) = 6.5E-04
- TPHg(Methyl Cyclohexanone Surrogate) = 5.9E-04
- Ethylbenzene Attenuation Factor (Residential) = 1.1E-03
- O-Xylene Attenuation Factor (Residential) = 1.1E-03
- Toluene Attenuation Factor (Residential) = 1.1E-03

Table 7
Summary of Groundwater Vapor Modeling Results
 411 West MacArthur Boulevard
 Oakland, CA

COPC ¹ (Exposure Scenario)	Max. Groundwater Concentration (µg/l)	Depth to Groundwater (cm)	Cancer Risk ²	Non-Cancer Risk ²
Benzene-Residential	110	91	6.9E-06	0.21
Benzene-Residential	110	518	6.6E-06	0.2
Ethylbenzene-Residential	2,300	91	1.50E-05	0.016
Ethylbenzene-Residential	2,300	518	1.40E-05	0.015
Napthalene-Residential	2,600	91	1.70E-05	0.45
Napthalene-Residential	2,600	518	1.50E-05	0.39
Total Residential Cancer Risk/Non-Cancer Risk - Elevator Pit Receptors			3.89E-05	0.68
Total Residential Cancer Risk/Non-Cancer Risk - At-Grade Receptors			3.6E-05	0.61

Notes:

¹COPC: Chemicals of Potential Concern

²Estimated using the CalEPA DTSC (Vapor Intrusion Guidance 2011)/HERO version of the Johnson and Ettinger Model Spreadsheets-Groundwater Screening and model inputs, (USEPA Vapor Intrusion Model; 2004)

Attenuation Factors

Benzene Attenuation Factor (Residential-3') = 2.8.0E-05

Benzene Attenuation Factor (Residential-17') = 2.7E-05

Ethylbenzene Attenuation Factor (Residential-3') = 2.1E-05

Ethylbenzene Attenuation Factor (Residential-17') = 2.0E-05

Napthalene Attenuation Factor (Residential-3') = 3.6E-05

Napthalene Attenuation Factor (Residential-17') = 3.1E-05

FIGURES

TOPO! map printed on 02/16/16 from "California.tpo" and "Untitled.tpg"

122°17,000' W

122°15,000' W

WGS84 122°14,000' W

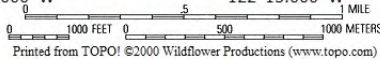
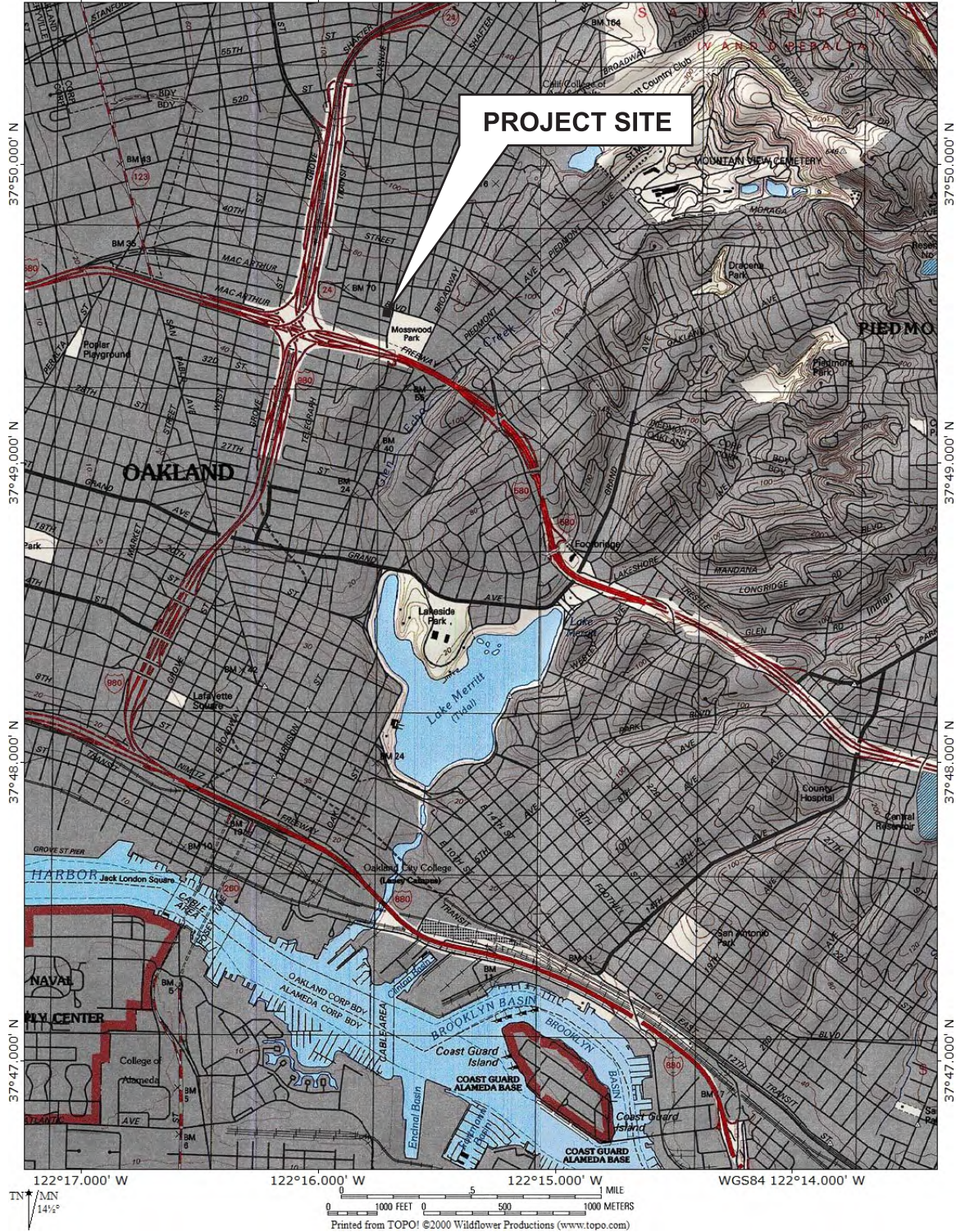

Printed from TOPO! ©2000 Wildflower Productions (www.topo.com)

DESIGNED BY: JG	CHECKED BY: MK	SITE VICINITY MAP	DATE: 08/18/2016	FIGURE: 1
DRAWN BY: JG	SCALE:			
PROJECT NO: ARS-16-29-01		411 WEST MACARTHUR BLVD. OAKLAND, CALIFORNIA		

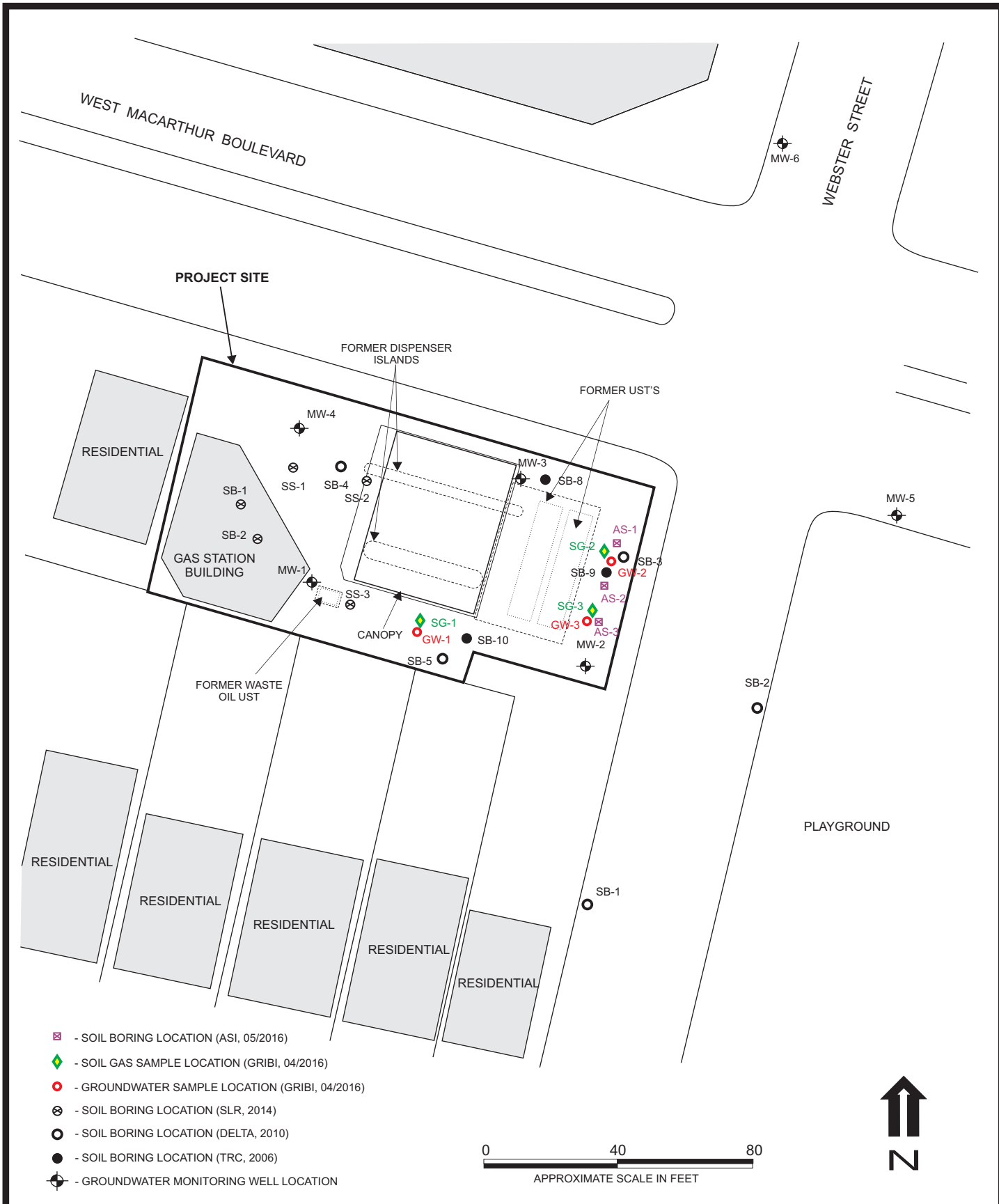

DESIGNED BY: JG	CHECKED BY: MK	SITE PLAN 411 W. MAC ARTHUR BLVD. OAKLAND, CALIFORNIA	DATE: 08/18/2016	FIGURE: 2
DRAWN BY: JG	SCALE:		 Applied Remedial Services, Inc. P.O. Box 5086 Walnut Creek, CA 94596	
PROJECT NO: ARS-16-29-01				



WEST MACARTHUR BOULEVARD

UST PIPING EXCAVATION CAVITY
(APPROX. 6.5' BGS IN 1989;
APPROX. 6.0' BGS IN 1998)

FORMER UST'S

GASOLINE UST
EXCAVATION CAVITY
(APPROX. 12' BGS IN 1989;
APPROX. 20' BGS IN 1998)

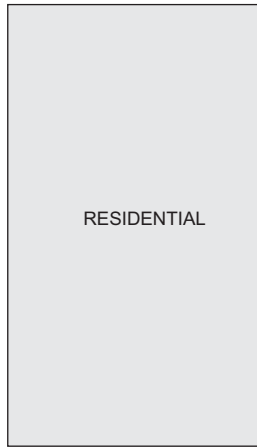

RESIDENTIAL

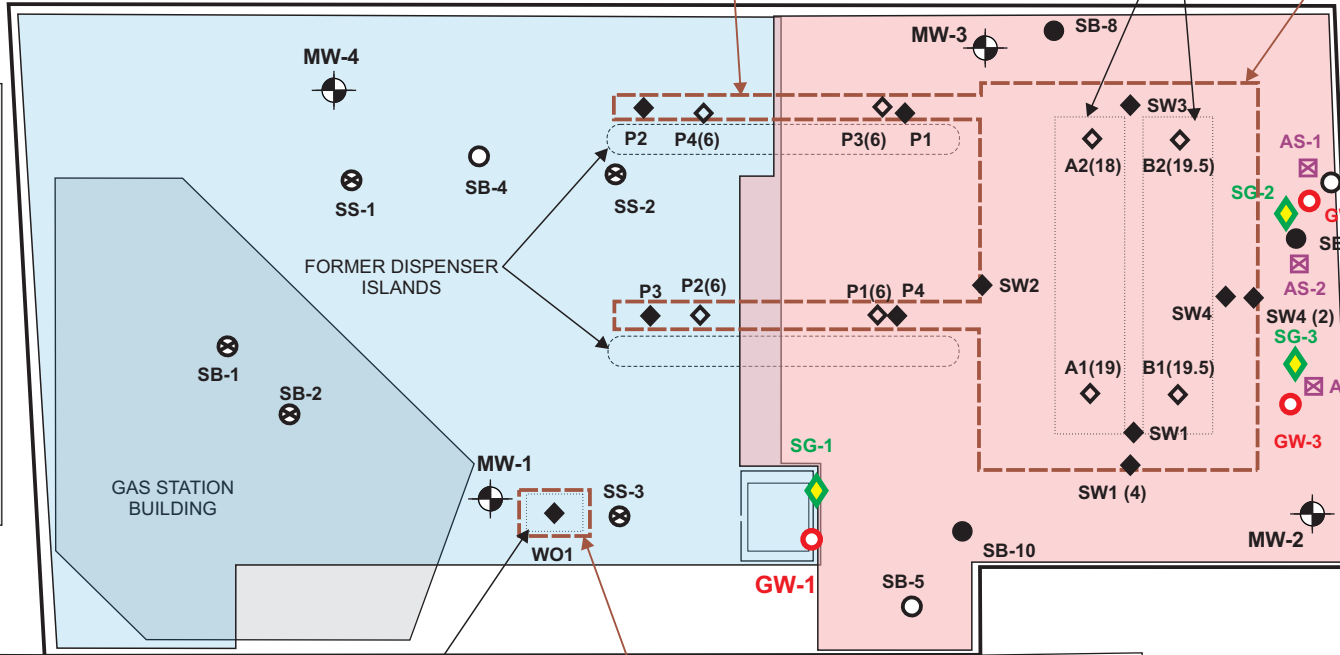

WEBSTER STREET

- SOIL BORING LOCATION (ASI, 05/2016)
- SOIL GAS SAMPLE LOCATION (GRIBI, 04/2016)
- GROUNDWATER SAMPLE LOCATION (GRIBI, 04/2016)
- SOIL BORING LOCATION (SLR, 2014)
- SOIL BORING LOCATION (DELTA, 2010)
- SOIL BORING LOCATION (TRC, 2006)
- UST REMOVAL SOIL SAMPLE, 09/1998
- UST REMOVAL SOIL SAMPLE, 07/1989
- GROUNDWATER MONITORING WELL LOCATION

FORMER WASTE OIL UST

WASTE OIL UST EXCAVATION CAVITY
(APPROX. 8.5' BGS IN 1989)

- COMMERCIAL/RETAIL SUITE ON GROUND FLOOR, 14 FEET CEILING.

- BASEMENT, CAR STACKER & MECH./STORAGE, 8 FEET CEILING; PARKING ON GROUND FLOOR, 14 FEET CEILING.



DESIGNED BY: JG	CHECKED BY: MK
DRAWN BY: JG	SCALE:
PROJECT NO: ARS-16-29-01	

SITE DETAILS
411 W. MAC ARTHUR BLVD. OAKLAND, CALIFORNIA

DATE: 08/18/2016	FIGURE: 3
------------------	-----------





WEST MACARTHUR BOULEVARD

UST PIPING EXCAVATION CAVITY
(APPROX. 6.5' BGS IN 1989;
APPROX. 6.0' BGS IN 1998)

FORMER UST'S

GASOLINE UST
EXCAVATION CAVITY
(APPROX. 12' BGS IN 1989;
APPROX. 20' BGS IN 1998)

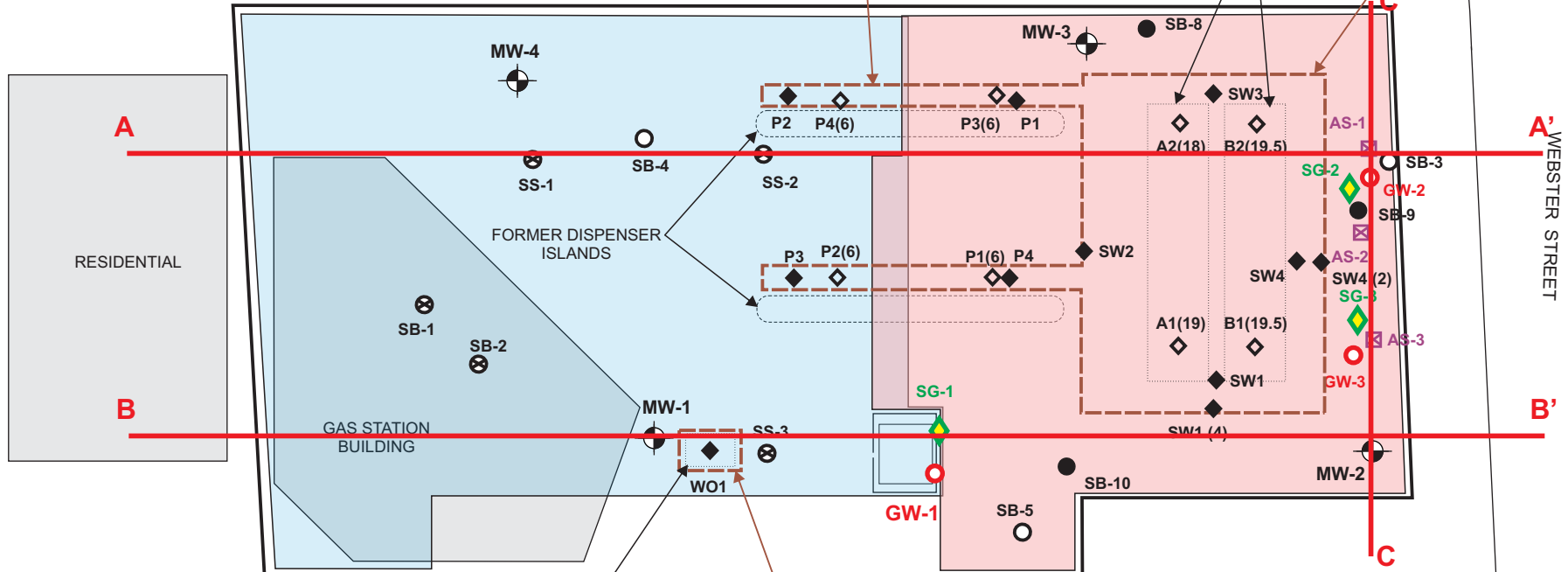

RESIDENTIAL

FORMER DISPENSER ISLANDS

GAS STATION BUILDING

FORMER WASTE OIL UST

WASTE OIL UST EXCAVATION CAVITY
(APPROX. 8.5' BGS IN 1989)

COMMERCIAL/RETAIL SUITE ON GROUND FLOOR, 14 FEET CEILING.

BASEMENT, CAR STACKER & MECH./STORAGE, 8 FEET CEILING; PARKING ON GROUND FLOOR, 14 FEET CEILING.



- ⊠ - SOIL BORING LOCATION (ASI, 05/2016)
- ◇ - SOIL GAS SAMPLE LOCATION (GRIBI, 04/2016)
- - GROUNDWATER SAMPLE LOCATION (GRIBI, 04/2016)
- ⊗ - SOIL BORING LOCATION (SLR, 2014)
- - SOIL BORING LOCATION (DELTA, 2010)
- - SOIL BORING LOCATION (TRC, 2006)
- ◇ - UST REMOVAL SOIL SAMPLE, 09/1998
- ◆ - UST REMOVAL SOIL SAMPLE, 07/1989
- ⊕ - GROUNDWATER MONITORING WELL LOCATION

DESIGNED BY: JG	CHECKED BY: MK
DRAWN BY: JG	SCALE:
PROJECT NO: ARS-16-29-01	

**CROSS SECTION
LOCATION MAP**
411 W. MAC ARTHUR BLVD.
OAKLAND, CALIFORNIA

DATE: 08/18/2016 FIGURE: 4



A (E)

A' (W)

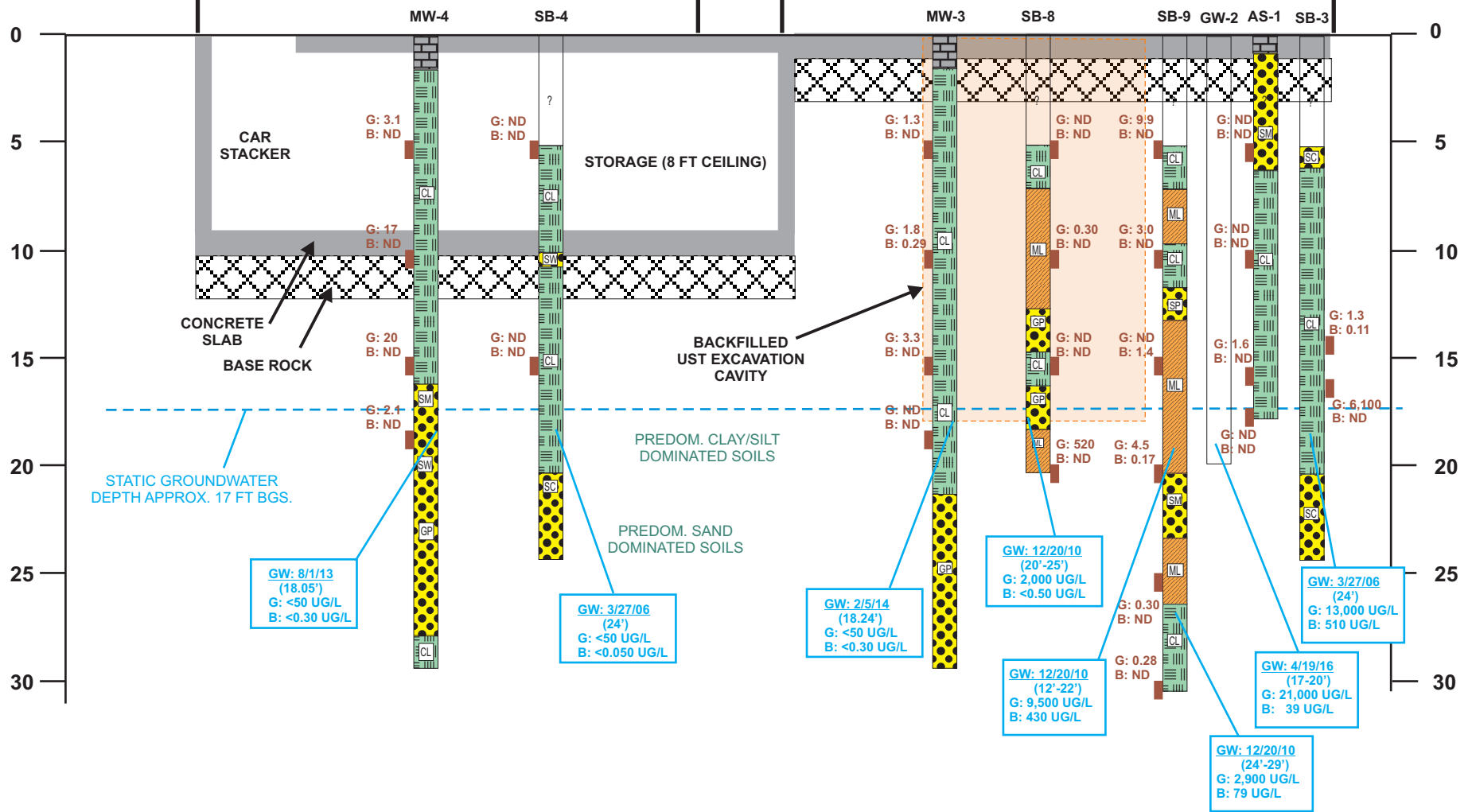

DESIGNED BY: JG	CHECKED BY: MK
DRAWN BY: JG	SCALE:
PROJECT NO: ARS-16-29-01	

CROSS SECTION A-A'

411 W. MAC ARTHUR BLVD.
OAKLAND, CALIFORNIA

DATE: 08/18/2016	FIGURE: 5
<p>ARS, INC Applied Remedial Services, Inc. P.O. Box 5086 Walnut Creek, CA 94596</p>	

B (E)

B' (W)

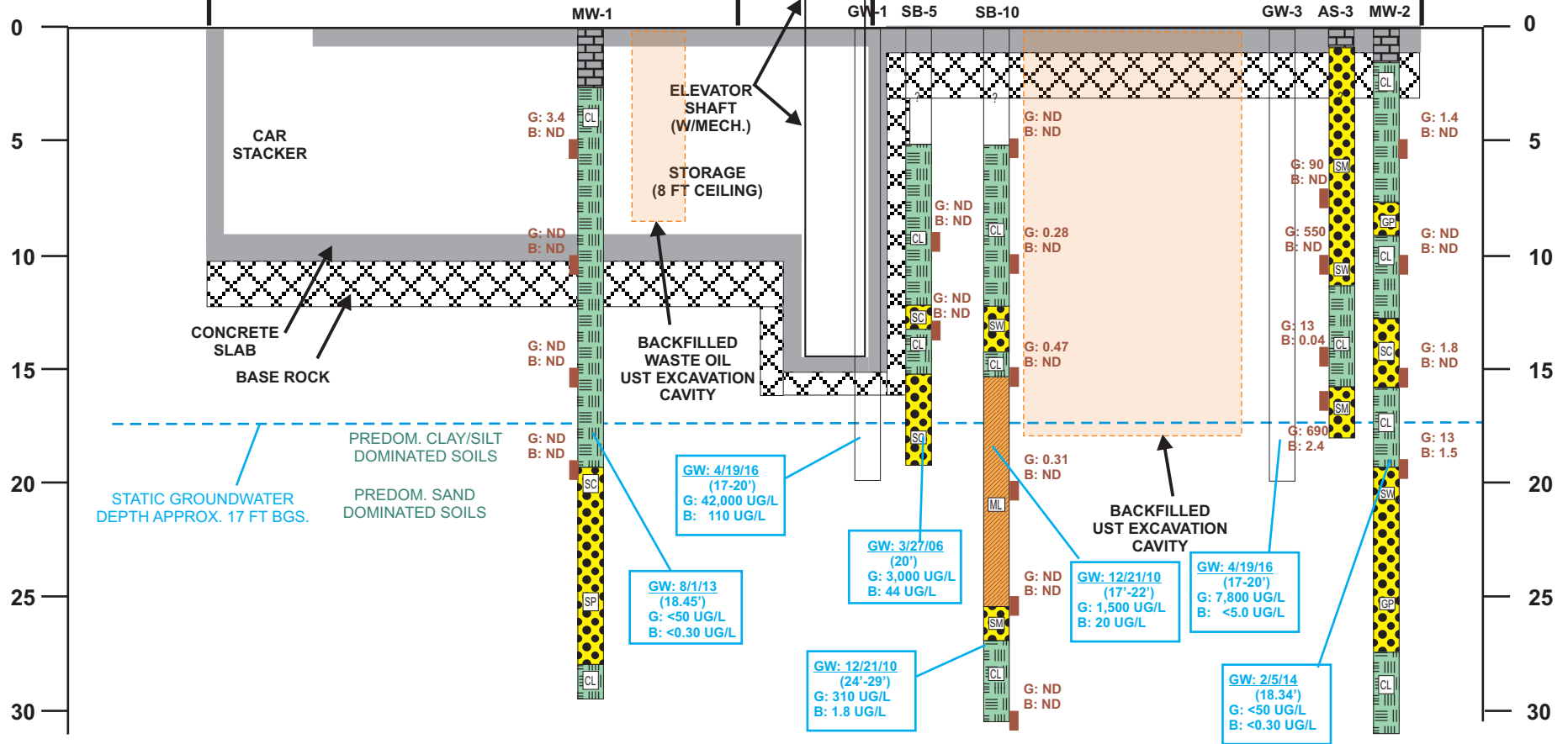

DESIGNED BY: JG	CHECKED BY: MK
DRAWN BY: JG	SCALE:
PROJECT NO: ARS-16-29-01	

CROSS SECTION B-B'
411 W. MAC ARTHUR BLVD.
OAKLAND, CALIFORNIA

DATE: 08/18/2016 FIGURE: 6

ARS, INC
Applied Remedial Services, Inc.
P.O. Box 5086
Walnut Creek, CA 94596

COMMERCIAL/RETAIL (14 FT CEILING)

C (S)

C' (N)

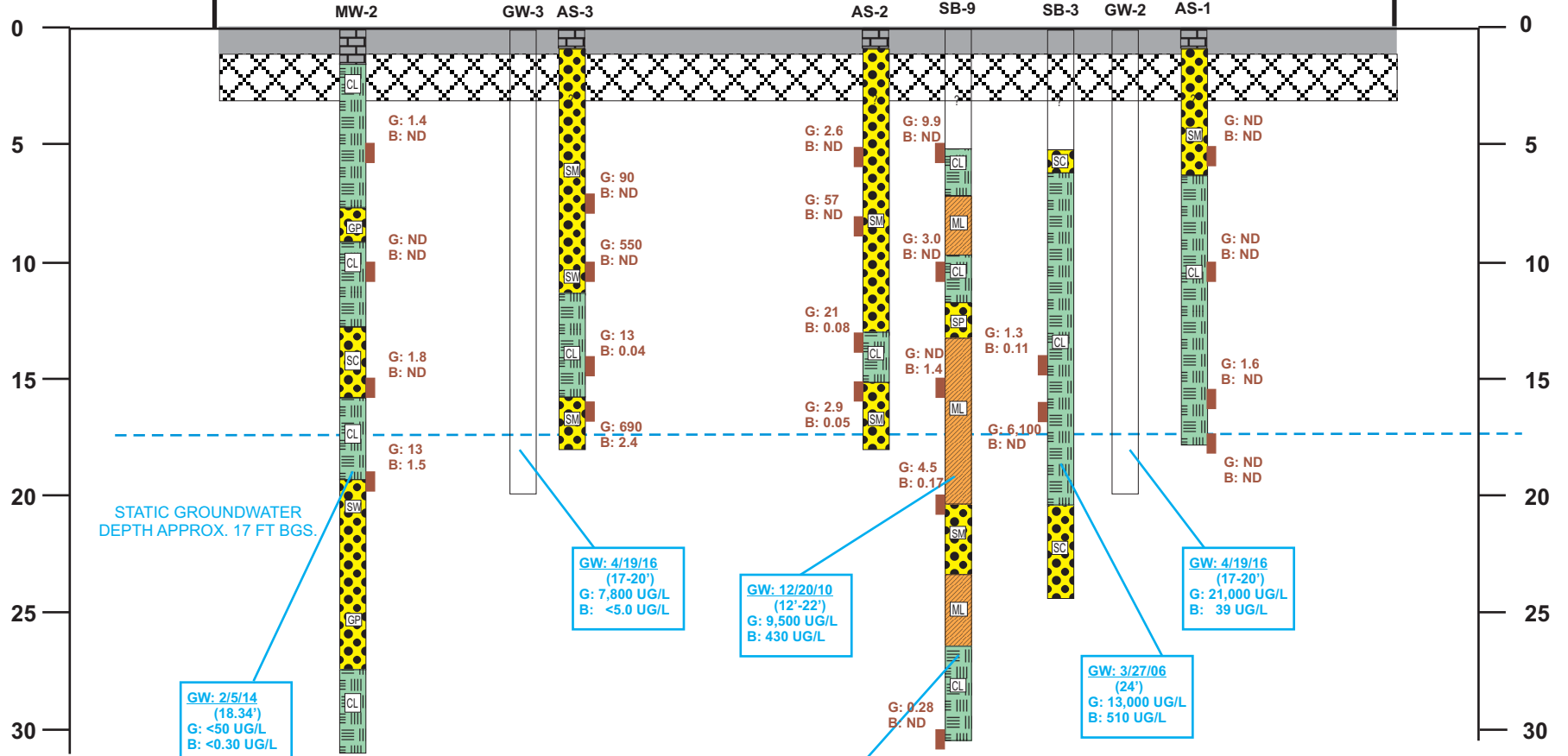

STATIC GROUNDWATER DEPTH APPROX. 17 FT BGS.

GW: 2/5/14
(18.34')
G: <50 UG/L
B: <0.30 UG/L

GW: 4/19/16
(17'-20')
G: 7,800 UG/L
B: <5.0 UG/L

GW: 12/20/10
(12'-22')
G: 9,500 UG/L
B: 430 UG/L

GW: 12/20/10
(24'-29')
G: 2,900 UG/L
B: 79 UG/L

GW: 3/27/06
(24')
G: 13,000 UG/L
B: 510 UG/L

GW: 4/19/16
(17'-20')
G: 21,000 UG/L
B: 39 UG/L



DESIGNED BY: JG	CHECKED BY: MK
DRAWN BY: JG	SCALE:
PROJECT NO: ARS-16-29-01	

CROSS SECTION B-B'
411 W. MAC ARTHUR BLVD.
OAKLAND, CALIFORNIA

DATE: 08/18/2016	FIGURE: 7
<p>Applied Remedial Services, Inc. P.O. Box 5086 Walnut Creek, CA 94596</p>	



WEST MACARTHUR BOULEVARD

UST PIPING EXCAVATION CAVITY
(APPROX. 6.5' BGS IN 1989)
APPROX. 6.0' BGS IN 1998

ONLINE UST EXCAVATION CAVITY
12' BGS IN 1989;
20' BGS IN 1998

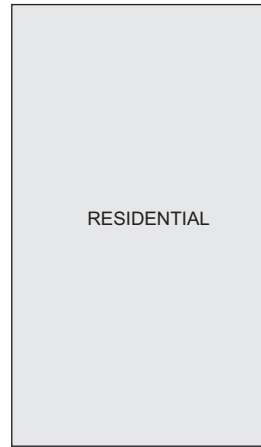

RESIDENTIAL

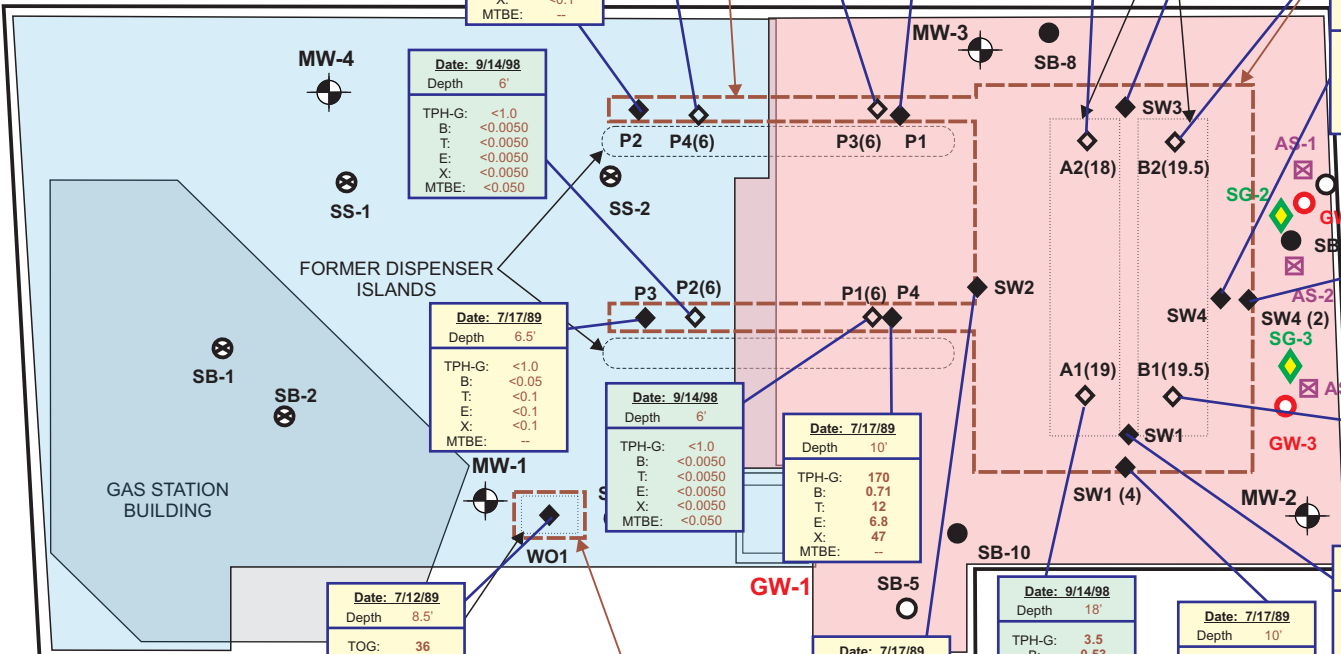

FORMER DISPENSER ISLANDS

GAS STATION BUILDING

WASTE OIL UST EXCAVATION CAVITY
(APPROX. 8.5' BGS IN 1989)

COMMERCIAL/RETAIL SUITE ON GROUND FLOOR, 14 FEET CEILING.

BASEMENT, CAR STACKER & MECH./STORAGE, 8 FEET CEILING; PARKING ON GROUND FLOOR, 14 FEET CEILING.

Date: 7/12/89
Depth: 8.5'
TOG: 36
TPH-D: <1.0
TPH-G: <1.0
B: <-0.05
T: <0.1
E: <0.1
X: <0.1
MTBE: --
HVOC'S: ALL ND
SVOC'S: ALL ND

Date: 9/14/98
Depth: 6'
TPH-G: <1.0
B: <-0.0050
T: <-0.0050
E: <-0.0050
X: <-0.0050
MTBE: <-0.050

Date: 7/17/89
Depth: 6.5'
TPH-G: <1.0
B: <-0.05
T: <-0.1
E: <-0.1
X: <-0.1
MTBE: --

Date: 9/14/98
Depth: 6'
TPH-G: <1.0
B: <-0.0050
T: <-0.0050
E: <-0.0050
X: <-0.0050
MTBE: <-0.050

Date: 9/14/98
Depth: 6'
TPH-G: <1.0
B: <-0.0050
T: <-0.0050
E: <-0.0050
X: <-0.0050
MTBE: <-0.050

Date: 7/17/89
Depth: 10'
TPH-G: 170
B: 0.71
T: 12
E: 6.8
X: 47
MTBE: --

Date: 7/17/89
Depth: 10'
TPH-G: 1.1
B: 0.10
T: <0.1
E: <0.1
X: 0.18
MTBE: --

Date: 9/14/98
Depth: 18'
TPH-G: 3.5
B: 0.53
T: 0.36
E: 0.069
X: 0.40
MTBE: <-0.050
LEAD: 26

Date: 7/17/89
Depth: 10'
TPH-G: <1.0
B: <-0.05
T: <0.1
E: <0.1
X: <0.1
MTBE: --

Date: 7/17/89
Depth: 10'
TPH-G: 3,100
B: 12
T: 300
E: 110
X: 730
MTBE: --

Date: 9/14/98
Depth: 19.5'
TPH-G: 360
B: 1.5
T: 15
E: 7.0
X: 44
MTBE: <-0.050
LEAD: 1.7

Date: 7/17/89
Depth: 10'
TPH-G: 11
B: 0.61
T: 0.51
E: 0.44
X: 1.3
MTBE: --

Date: 7/17/89
Depth: 10'
TPH-G: 2.5
B: <-0.05
T: <-0.1
E: <-0.1
X: 0.24
MTBE: --

Date: 9/14/98
Depth: 19.5'
TPH-G: 6.7
B: 0.017
T: 1.8
E: 0.24
X: 1.4
MTBE: <-0.050
LEAD: 2.7

Date: 7/17/89
Depth: 10'
TPH-G: 5.7
B: 0.26
T: <0.1
E: 0.23
X: 0.45
MTBE: --

Date: 9/14/98
Depth: 18'
TPH-G: 12
B: 0.050
T: 0.075
E: <-0.0050
X: 0.026
MTBE: <-0.050
LEAD: <1.0

Date: 7/17/89
Depth: 6.5'
TPH-G: <1.0
B: <-0.05
T: <-0.1
E: <-0.1
X: <-0.1
MTBE: --

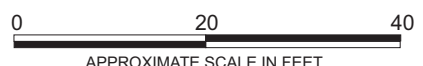

- ⊠ - SOIL BORING LOCATION (ASI, 05/2016)
- ◇ - SOIL GAS SAMPLE LOCATION (GRIBI, 04/2016)
- - GROUNDWATER SAMPLE LOCATION (GRIBI, 04/2016)
- ⊗ - SOIL BORING LOCATION (SLR, 2014)
- - SOIL BORING LOCATION (DELTA, 2010)
- - SOIL BORING LOCATION (TRC, 2006)
- ◇ - UST REMOVAL SOIL SAMPLE, 09/1998
- ◆ - UST REMOVAL SOIL SAMPLE, 07/1989
- ⊕ - GROUNDWATER MONITORING WELL LOCATION

DESIGNED BY: JG	CHECKED BY: MK
DRAWN BY: JG	SCALE:
PROJECT NO: ARS-16-29-01	

UST REMOVAL SOIL HYDROCARBON RESULTS
411 W. MAC ARTHUR BLVD.
OAKLAND, CALIFORNIA

DATE: 08/18/2016 FIGURE: 8

Date: 9/6/89		Date: 8/1/13		Date: 3/27/06		Date: 9/7/89				Date: 2/5/14		Date: 12/20/10				Date: 12/20/10				Date: 12/20/10					Date: 12/20/10								
SOIL (MG/KG)				GW (UG/L)		SOIL (MG/KG)		GW (UG/L)		SOIL (MG/KG)		GW (UG/L)		SOIL (MG/KG)				GW (UG/L)				SOIL (MG/KG)					GW (UG/L)						
Depth	5'	10'	15'	18.5'	(18.05')	Depth	5.0'	15.0'	(24')	Depth	5'	10'	15'	18.5'	(18.24')	Depth	5'	10'	15'	20.0'	(20'-25')	Depth	5'	10'	15'	20'	25'	30'	(17'-22)	(24'-29')			
TPH-D:	-	-	-	-	<50	TPH-D:	<0.93	<0.92	<50	TPH-D:	-	-	-	<50	TPH-D:	<0.20	0.30	<10	520	2,000	TPH-D:	9.9	3.0	<10	4.5	0.30	0.28	9,500	2,900				
TPH-G:	3.1	17	20	2.1	<50	TPH-G:	<0.93	<0.92	<50	TPH-G:	<0.20	0.30	<10	520	2,000	TPH-G:	9.9	3.0	<10	4.5	0.30	0.28	9,500	2,900	TPH-G:	9.9	3.0	<10	4.5	0.30	0.28	9,500	2,900
B:	<0.05	<0.05	<0.05	<0.05	<0.30	B:	<0.0047	<0.0046	<0.050	B:	<0.0050	<0.0050	<0.025	<1.2	<0.50	B:	<0.025	<0.0050	1.4	0.17	<0.0050	<0.0050	430	79	B:	<0.025	<0.0050	1.4	0.17	<0.0050	<0.0050	430	79
T:	<0.1	<0.1	<0.1	<0.1	<0.30	T:	<0.0047	<0.0046	<0.050	T:	<0.0050	<0.0050	<0.025	19	48	T:	0.10	0.069	0.14	0.067	0.0050	0.011	330	100	T:	<0.1	<0.1	<0.1	2.1	<0.30	<0.30	330	100
E:	<0.1	<0.1	<0.1	<0.1	<0.30	E:	<0.0047	<0.0046	<0.050	E:	<0.0050	<0.0050	<0.025	19	48	E:	0.059	0.28	0.66	0.37	0.028	0.043	2,100	540	E:	<0.1	<0.1	<0.1	1.8	<0.30	<0.30	2,100	540
X:	<0.1	0.10	0.27	<0.1	<0.60	X:	<0.0093	<0.0092	<1.0	X:	<0.010	<0.010	<0.050	86	340	X:	0.059	0.28	0.66	0.37	0.028	0.043	2,100	540	X:	<0.1	<0.1	<0.1	1.8	<0.30	<0.30	2,100	540
MTBE:	-	-	-	-	<1.0	MTBE:	<0.0047	<0.0046	3.4	MTBE:	<0.0050	<0.0050	<0.025	<1.2	<0.50	MTBE:	<0.025	0.014	0.04	0.62	<0.0050	<0.0050	190	<5.0	MTBE:	<0.025	0.014	0.04	0.62	<0.0050	<0.0050	190	<5.0

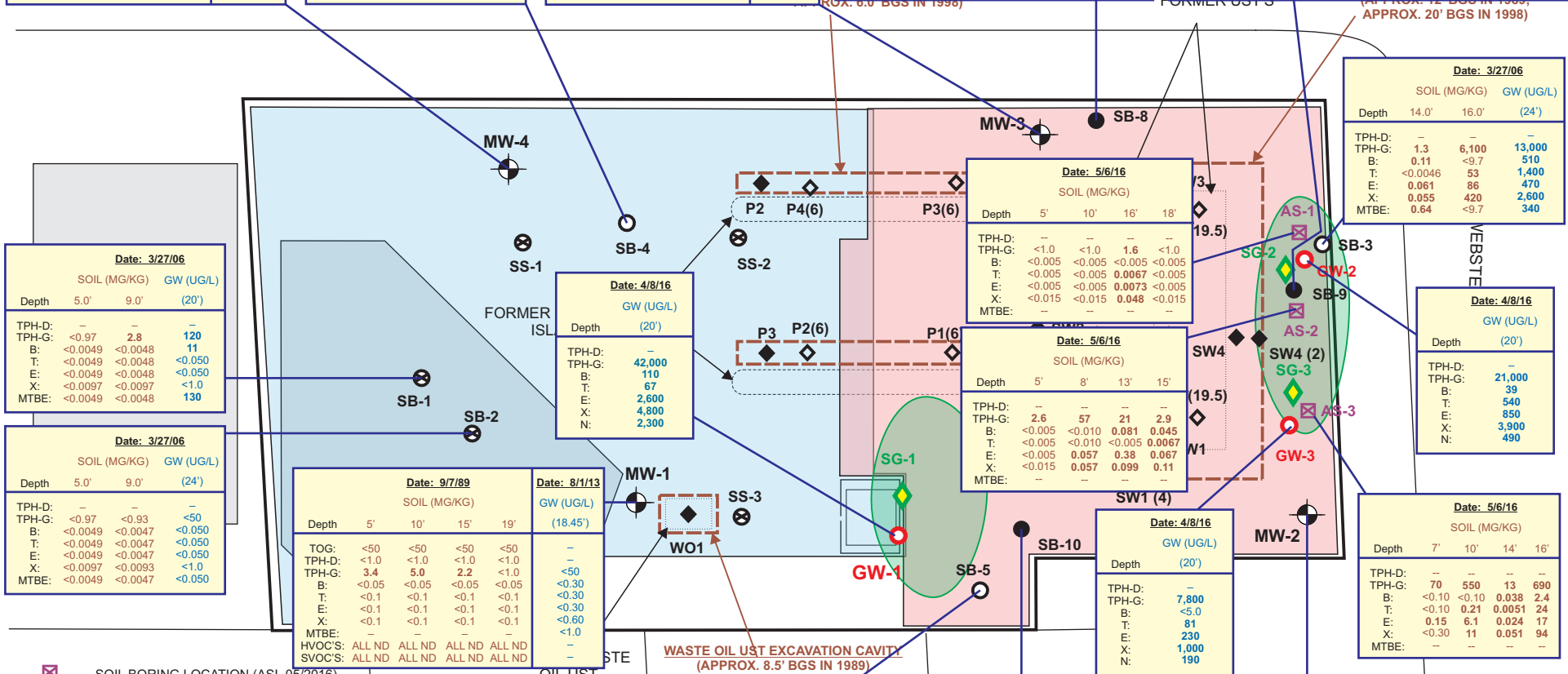

- ⊠ - SOIL BORING LOCATION (ASI, 05/2016)
- ◆ - SOIL GAS SAMPLE LOCATION (GRIBI, 04/2016)
- - GROUNDWATER SAMPLE LOCATION (GRIBI, 04/2016)
- ⊗ - SOIL BORING LOCATION (SLR, 2014)
- - SOIL BORING LOCATION (DELTA, 2010)
- - SOIL BORING LOCATION (TRC, 2006)
- ◇ - UST REMOVAL SOIL SAMPLE, 09/1998
- ◆ - UST REMOVAL SOIL SAMPLE, 07/1989
- ⊕ - GROUNDWATER MONITORING WELL LOCATION

DESIGNED BY: JG	CHECKED BY: MK	SOIL & GROUNDWATER HYDROCARBON RESULTS 411 W. MAC ARTHUR BLVD. OAKLAND, CALIFORNIA	DATE: 08/18/2016	FIGURE: 9
DRAWN BY: JG	SCALE:		 Applied Remedial Services, Inc. P.O. Box 5086 Walnut Creek, CA 94596	
PROJECT NO: ARS-16-29-01				



WEST MACARTHUR BOULEVARD

UST PIPING EXCAVATION CAVITY
(APPROX. 6.5' BGS IN 1989;
APPROX. 6.0' BGS IN 1998)

GASOLINE UST
EXCAVATION CAVITY
(APPROX. 12' BGS IN 1989;
APPROX. 20' BGS IN 1998)

SOIL GAS
DEPTH 5.5 FT
TPH-G: 1,900,000
B: 450
T: <190
E: <220
X: <660
N: <530
METH: 21%

SOIL GAS
DEPTH 16.0 FT
TPH-G: 150,000
B: 39
T: 210
E: 360
X: 1,100
N: <53
METH: 0.50%

SOIL GAS
DEPTH 5.5 FT
TPH-G: 2,700,000
B: <160
T: <190
E: 390
X: <660
N: <530
METH: 23%

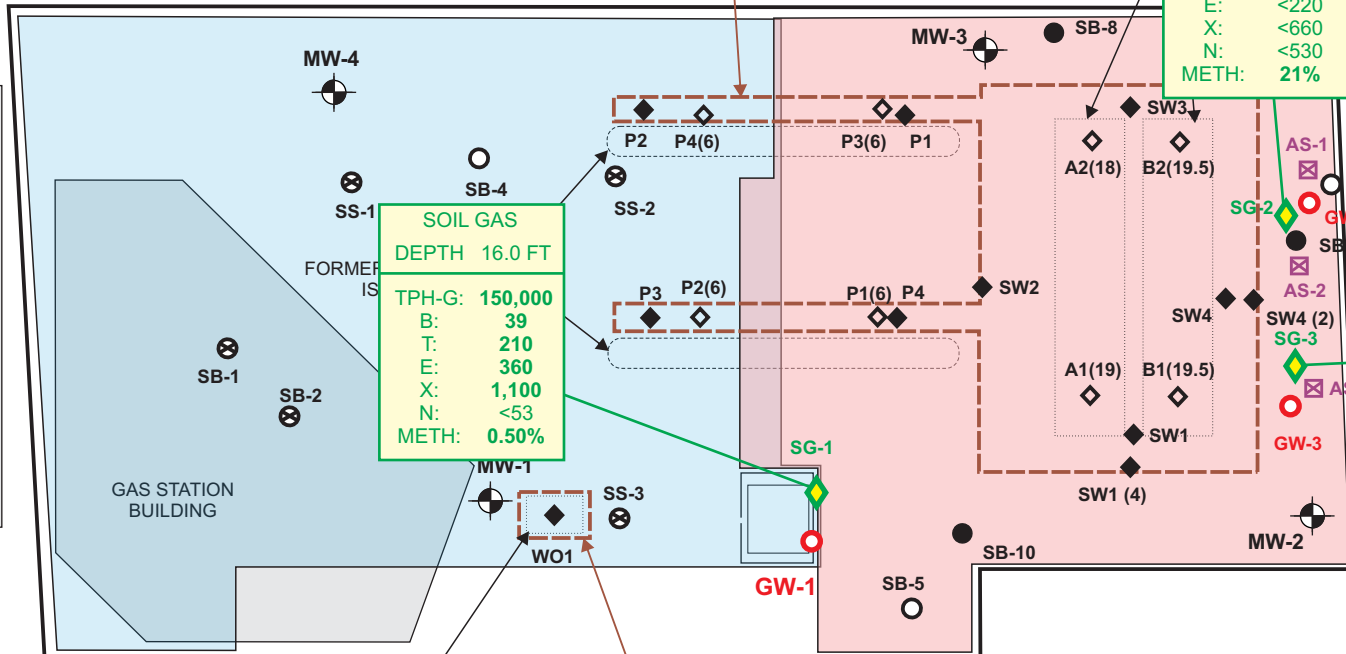
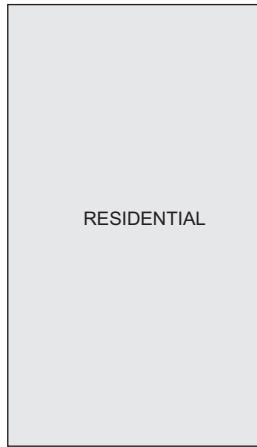

RESIDENTIAL

GAS STATION BUILDING

FORMER WASTE OIL UST

WASTE OIL UST EXCAVATION CAVITY
(APPROX. 8.5' BGS IN 1989)

COMMERCIAL/RETAIL SUITE ON GROUND FLOOR, 14 FEET CEILING.

BASEMENT, CAR STACKER & MECH./STORAGE, 8 FEET CEILING; PARKING ON GROUND FLOOR, 14 FEET CEILING.



- ⊠ - SOIL BORING LOCATION (ASI, 05/2016)
- ◇ - SOIL GAS SAMPLE LOCATION (GRIBI, 04/2016)
- - GROUNDWATER SAMPLE LOCATION (GRIBI, 04/2016)
- ⊗ - SOIL BORING LOCATION (SLR, 2014)
- - SOIL BORING LOCATION (DELTA, 2010)
- - SOIL BORING LOCATION (TRC, 2006)
- ◇ - UST REMOVAL SOIL SAMPLE, 09/1998
- ◆ - UST REMOVAL SOIL SAMPLE, 07/1989
- ⊕ - GROUNDWATER MONITORING WELL LOCATION

DESIGNED BY: JG	CHECKED BY: MK
DRAWN BY: JG	SCALE:
PROJECT NO: ARS-16-29-01	

SITE GAS HYDROCARBON RESULTS
411 W. MAC ARTHUR BLVD.
OAKLAND, CALIFORNIA



DATE: 08/18/2016 FIGURE: 10





BORING LOGS

AQUIFER SCIENCES, INC.

PROJECT NAME 216621 NO. AS-1



DRILLING LOCATION <u>411 West MacArthur Blvd. Oakland</u>		ELEVATION AND DATUM (FT) <u>-</u>			
DRILLING AGENCY <u>Gregg Drilling</u>	DRILLER <u>Leo Santos</u>	DATE STARTED <u>5/6/16</u>	DATE FINISHED <u>5/6/16</u>		
DRILLING METHOD <u>Direct Push</u>	DRILL BIT <u>2"</u>	BORING DEPTH (FT) <u>18'</u>	WELL DEPTH (FT) <u>-</u>		
DRILLING EQUIPMENT <u>Geo Probe DP-13</u>	SAMPLER <u>2" Acrylic Liner</u>	NO. OF SAMPLES <u>4</u>	SOIL <u>4</u>	GW <u>-</u>	OTHER <u>-</u>
SIZE AND TYPE OF CASING <u>-</u>		DEPTH TO WATER (FT) <u>-</u>	FIRST <u>-</u>	COMPLETION <u>-</u>	OTHER <u>-</u>
TYPE OF PERFORATION <u>-</u>	FROM <u>-</u> TO <u>-</u> FT.	LOGGED BY: 		CHECKED BY: 	
SIZE AND TYPE OF FILTER PACK <u>-</u>	FROM <u>-</u> TO <u>-</u> FT.				
TYPE OF SEAL <u>-</u>	FROM <u>-</u> TO <u>-</u> FT.				
TYPE OF SEAL <u>-</u>	FROM <u>-</u> TO <u>-</u> FT.				

DEPTH (FEET)	DESCRIPTION	GRAPHIC LOG			SAMPLES				REMARKS (Drilling Rate, Fluid Loss, Odor, etc.)	
		Lithology	Well Construction Diagram	Water Level	Sampling Interval	Recovery (%)	Blow Counts (per 6 in.)	OVm (ppmv)		
1	Asphalt								Start time: 1105	
2	Dark brown moist Medium Dense Clayey <u>SILT</u> w/ sand Occasional angular gravel	SM		100%	100%	2.7	20.1	3.6	2.2	AS-1-5 @ 1115
3										
4										
5										
6										
7										
8										
9										
10										
11										
12	Olive gray to olive moist medium stiff Inorganic CLAY	CL		100%	100%	2.2	1.8	1.0	AS-1-10 @ 1120	
13										

DEPTH (FEET)	DESCRIPTION	GRAPHIC LOG			SAMPLES			REMARKS (Drilling Rate, Fluid Loss, Odor, etc.)
		Lithology	Well Construction Diagram	Water Level	Sampling Interval	Recovery (%)	Blow Counts (per 6 in.)	
15	Olive Gray to olive Moist Medium stiff Inorganic Clay	CL			100%		1.6	AS-1-15 @ 1125
16					4.9			
17					100%			
18	Bottom of boring 18'						10.2	AS-1-18 @ 1130 Finish time: 1130

AQUIFER SCIENCES, INC.

PROJECT NAME 216621 NO. AS-2



DRILLING LOCATION <u>411 West MacArthur Blvd. Oakland</u>		ELEVATION AND DATUM (FT) <u>-</u>	
DRILLING AGENCY <u>Gregg Drilling</u>	DRILLER <u>Leo Santos</u>	DATE STARTED <u>5/6/16</u>	DATE FINISHED <u>5/6/16</u>
DRILLING METHOD <u>Direct Push</u>	DRILL BIT <u>2"</u>	BORING DEPTH (FT) <u>18'</u>	WELL DEPTH (FT) <u>-</u>
DRILLING EQUIPMENT <u>Geo Probe DP-13</u>	SAMPLER <u>2" Acrylic Liner</u>	NO. OF SAMPLES <u>5</u>	SOIL <u>5</u>
SIZE AND TYPE OF CASING <u>-</u>	DEPTH TO WATER (FT) <u>-</u>	FIRST <u>-</u>	COMPLETION <u>-</u>
TYPE OF PERFORATION <u>-</u>	FROM <u>-</u> TO <u>-</u> FT.	LOGGED BY: 	CHECKED BY: 
SIZE AND TYPE OF FILTER PACK <u>-</u>	FROM <u>-</u> TO <u>-</u> FT.		
TYPE OF SEAL <u>-</u>	FROM <u>-</u> TO <u>-</u> FT.		
TYPE OF SEAL <u>-</u>	FROM <u>-</u> TO <u>-</u> FT.		

DEPTH (FEET)	DESCRIPTION	GRAPHIC LOG			SAMPLES			REMARKS (Drilling Rate, Fluid Loss, Odor, etc.)
		Lithology	Well Construction Diagram	Water Level	Sampling Interval	Recovery (%)	Blow Counts (per 6 in.)	
1	Asphalt							Start time:
2								
3	Dark brown moist Medium Dense							
4	Clayey <u>SILT</u> w/ sand							
5	occasional Angular Gravel							AS-2-5 @ 1030
6		SM						
7								
8	Light brown w/ olive grey mottling							
9	Moist Medium Dense							AS-2-8 @ 1035
10	Clayey <u>SILT</u> w/ sand							
11								
12	Light brown moist Medium Dense							
13	clayey <u>SILT</u> w/ sand.							
13	Olive Gray to olive Moist Medium Dense Inorganic CLAY	CL						AS-2-13 @ 1040

DEPTH (FEET)	DESCRIPTION	GRAPHIC LOG			SAMPLES			REMARKS (Drilling Rate, Fluid Loss, Odor, etc.)
		Lithology	Well Construction Diagram	Water Level	Sampling Interval	Recovery (%)	Blow Counts (per 6 in.)	
15	Olive Grey to Olive Moist medium dense Inorganic <u>CLAY</u>	CL					98.1	NOTE: Petroleum ODOR AS-2-15 @ 1050
16	Olive Gray to Olive Moist Medium stiff Clayey <u>SILT</u> w/ sand	SM					1245	
17								
18	Bottom of boring 18'						432	AS-2-18 @ 1055 (Hold) Finish time: 1055

AQUIFER SCIENCES, INC.

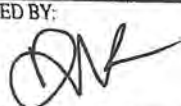
PROJECT NAME 216621 NO. AS-3

DRILLING LOCATION <u>411 West MacArthur Blvd. Oakland</u>		ELEVATION AND DATUM (FT) <u>-</u>	
DRILLING AGENCY <u>Gregg Drilling</u>	DRILLER <u>Leo Santos</u>	DATE STARTED <u>5/6/16</u>	DATE FINISHED <u>5/6/16</u>
DRILLING METHOD <u>Direct Push</u>	DRILL BIT <u>2"</u>	BORING DEPTH (FT) <u>13'</u>	WELL DEPTH (FT) <u>-</u>
DRILLING EQUIPMENT <u>Geo Probe DP-13</u>	SAMPLER <u>2" Acrylic Liner</u>	NO. OF SAMPLES <u>4</u>	SOIL <u>4</u>
SIZE AND TYPE OF CASING <u>-</u>	DEPTH TO WATER (FT) <u>15.5'</u>	FIRST <u>-</u>	COMPLETION <u>-</u>
TYPE OF PERFORATION <u>-</u>	FROM <u>-</u> TO <u>-</u> FT.	LOGGED BY: 	CHECKED BY: 
SIZE AND TYPE OF FILTER PACK <u>-</u>	FROM <u>-</u> TO <u>-</u> FT.		
TYPE OF SEAL <u>-</u>	FROM <u>-</u> TO <u>-</u> FT.		
TYPE OF SEAL <u>-</u>	FROM <u>-</u> TO <u>-</u> FT.		

DEPTH (FEET)	DESCRIPTION	GRAPHIC LOG			SAMPLES				REMARKS (Drilling Rate, Fluid Loss, Odor, etc.)
		Lithology	Well Construction Diagram	Water Level	Sampling Interval	Recovery (%)	Blow Counts (per 6 in.)	QVM (ppmv)	
1	Asphalt								Start time:
2									NOTE: Petroleum ODOR starting @ 2' odor consistent to 18'.
3									
4	Dark Brown Moist								
5	Medium Dense clayey <u>SILT</u> w/ sand	SM							NOTE: Not able to sample due to low recovery
6	occasional angular Gravel								
7									
8									AS-3-7 @ 0945
9									
10	Light Brown Moist Medium Dense clayey <u>SILT</u> w/sand.								AS-3-10 @ 0955
11	Olive Brown Moist very loose	SW							
12	Well graded <u>SAND</u>								
13	Olive Gray to olive Wet Medium stiff to soft Inorganic <u>CLAY</u>	CL							NOTE: Ground water encountered @ ~ 15.5', may be elevated due to sloshing
14									

DEPTH (FEET)	DESCRIPTION	GRAPHIC LOG			SAMPLES			REMARKS (Drilling Rate, Fluid Loss, Odor, etc.)
		Lithology	Well Construction Diagram	Water Level	Sampling Interval	Recovery (%)	Blow Counts (per 6 in.)	
14	Olive Gray to Olive Wet Medium stiff to soft Inorganic <u>CLAY</u>	CL			X		204	AS-3-14 @ 1000
16	Dark Brown Saturated Loose Sandy clayey <u>SILT</u>	SM			X		302	AS-3-16 @ 1010
18	Bottom of boring 18'						871	Finish time: 1010

B O R I N G L O G

Project No. KEI-P89-0703		Boring & Casing Diameter 9" 2"		Logged By D.L.
Project Name Unocal, Oakland/MacArthur		Well Head Elevation N/A		Date Drilled 9/7/89
Boring No. MW1		Drilling Method Hollow-stem Auger	Drilling Company EGI	
Penetra- tion blows/6"	G. W. level	Depth (ft) Samples	Strati- graphy USCS	Description
		0		A.C. Pavement Sand and Gravel: fill.
11/17/22		5		Clay, high plasticity, stiff, moist, very dark grayish brown.
				Gravelly clay with sand, stiff, moist, dark yellowish brown.
32/17/20		10		Sand clay, high plasticity, stiff, moist, olive, trace gravel.
			CH	Clay, high plasticity, very stiff, moist, pale olive, with greenish gray stained root holes.
13/17/19		15		Sandy clay, moderate to high plasticity, stiff, moist, olive to light yellowish brown.
10/17/20	▼ 7			
		20	SC	Clayey sand, dense, very moist to wet, yellowish brown.

B O R I N G L O G

Project No. KEI-P89-0703	Boring & Casing Diameter 9" 2"	Logged By D.L.
Project Name Unocal, Oakland/MacArthur	Well Head Elevation N/A	Date Drilled 9/7/89
Boring No. MW1	Drilling Method Hollow-stem Auger	Drilling Company EGI

Penetra- tion blows/6"	G. W. level	Depth (ft) Samples	Strati- graphy USCS	Description
		25	SC	Clayey sand, as above.
			SP	Poorly graded sand, yellowish brown.
			CH	Clay, high plasticity, very stiff, moist, yellowish brown.
		30		
		35		
		40		
				TOTAL DEPTH 29'

B O R I N G L O G

Project No. KEI-P89-0703	Boring & Casing Diameter 9" 2"	Logged By D.L.
Project Name Unocal, Oakland/MacArthur	Well Head Elevation N/A	Date Drilled 9/6/89
Boring No. MW2	Drilling Method Hollow-stem Auger	Drilling Company EGI

Penetration blows/6"	G. W. level	Depth (ft) Samples	Strati- graphy USCS	Description
		0		Concrete Pavement Sand and Gravel: Fill
9/14/21		5	CH	Clay, high plasticity, with silt, firm to stiff, moist, dark olive gray, black from 1.5 to 4 feet.
13/15/28		10	GC	Clayey gravel with sand, dense, moist, yellowish brown, gravel to 3/4".
9/15/19			CH	Sandy clay, high plasticity, 15-45% sand, stiff, moist, light yellowish brown and greenish gray, mottled, lensed with clayey sand.
10/15/23			SC	Clayey sand, dense to very dense, moist, olive and greenish gray.
8/10/15		15		
9/12/16			CH	Silty clay, moderate to high plasticity, firm, moist, olive.
13/37/46	▼	20	SW	Well graded sand with gravel, dense, wet, brown, silty from 19.5 feet.

B O R I N G L O G

Project No. KEI-P89-0703	Boring & Casing Diameter 9" 2"	Logged By D.L.
Project Name Unocal, Oakland/MacArthur	Well Head Elevation N/A	Date Drilled 9/6/89
Boring No. MW2	Drilling Method Hollow-stem Auger	Drilling Company EGI

Penetra- tion blows/6"	G. W. level	Depth (ft) Samples	Strati- graphy USCS	Description
		—	GP- GM	Poorly graded gravel with silt and sand, very dense, wet, dark yellowish brown.
25/37/45		25	GP	Poorly graded gravel with sand, very dense, wet, dark, yellowish brown.
		—	CH	Clay, high plasticity, trace sand, very stiff, moist, yellowish brown.
25/29/35		30		
		—		
		35		
		—		
		40		
				TOTAL DEPTH 30.5'

BORING LOG

Project No. KEI-P89-0703	Boring & Casing Diameter 9" 2"	Logged By D.L.
Project Name Unocal, Oakland/MacArthur	Well Head Elevation N/A	Date Drilled 9/7/89
Boring No. MW3	Drilling Method Hollow-stem Auger	Drilling Company EGI

Penetration blows/6"	G. W. level	Depth (ft) Samples	Strati- graphy USCS	Description
		0		Concrete Pavement
9/15/21		5	CH	Clay, high plasticity, with silt, stiff, moist, dark olive gray, very dark grayish brown above 4'.
14/17/23		10		Clay, high plasticity, very stiff, moist, pale olive, with dark greenish gray stained root holes.
15/23/33		15	CL	Sandy clay, low to moderate plasticity, 25-40% sand, stiff, moist, olive and greenish gray, mottled, lensed with clayey sand.
10/17/24	▼	20	CH	Sandy clay, moderate to high plasticity, stiff, moist, olive.

BORING LOG

Project No. KEI-P89-0703	Boring & Casing Diameter 9" 2"	Logged By D.L.
Project Name Unocal, Oakland/MacArthur	Well Head Elevation N/A	Date Drilled 9/7/89
Boring No. MW3	Drilling Method Hollow-stem Auger	Drilling Company EGI

Penetration blows/6"	G. W. level	Depth (ft) Samples	Strati- graphy USCS	Description
37/50- 5-1/2"			<div style="text-align: center;">GP- GC</div> <div style="text-align: center;">GC</div>	<p>Sandy clay, as above.</p> <p>Poorly graded gravel with clay and sand, very dense, wet, dark yellowish brown.</p> <p>Clayey gravel, very dense, moist, yellowish brown.</p>
		40		TOTAL DEPTH 29'

TABLE 4. MEAN VALUES OF SATURATED HYDRAULIC CONDUCTIVITY FOR THE 12 SCS SOIL TEXTURAL CLASSIFICATIONS

Soil texture , USDA	Saturated hydraulic conductivity, cm/h
Sand	29.70
Loamy sand	14.59
Sandy loam	4.42
Sandy clay loam	1.31
Sandy clay	0.12
Loam	1.04
Clay loam	0.26
Silt loam	0.45
Clay	0.20
Silty clay loam	0.07
Silt	0.25
Silty clay	0.02

Given a two-phase system (i.e., air and water), the effective total fluid saturation (S_{te}) is calculated as:

$$S_{te} = \frac{(\theta_w - \theta_r)}{(n - \theta_r)} \quad (28)$$

- where
- S_{te} = Effective total fluid saturation, unitless
 - θ_w = Soil water-filled porosity, cm^3/cm^3
 - θ_r = Residual soil water content, cm^3/cm^3
 - n = Soil total porosity, cm^3/cm^3 .

Chart B1: Groundwater Attenuation for MW-2

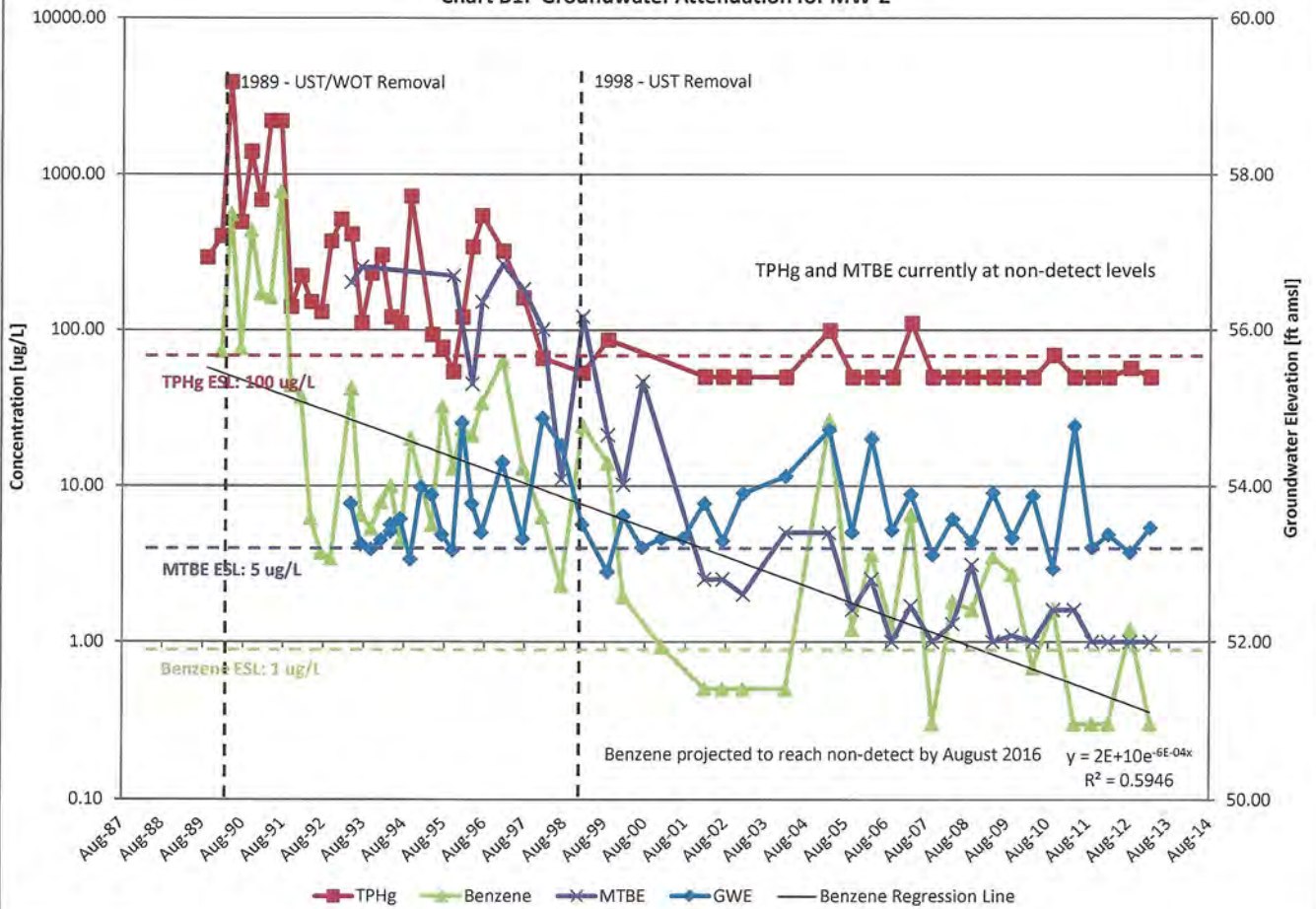
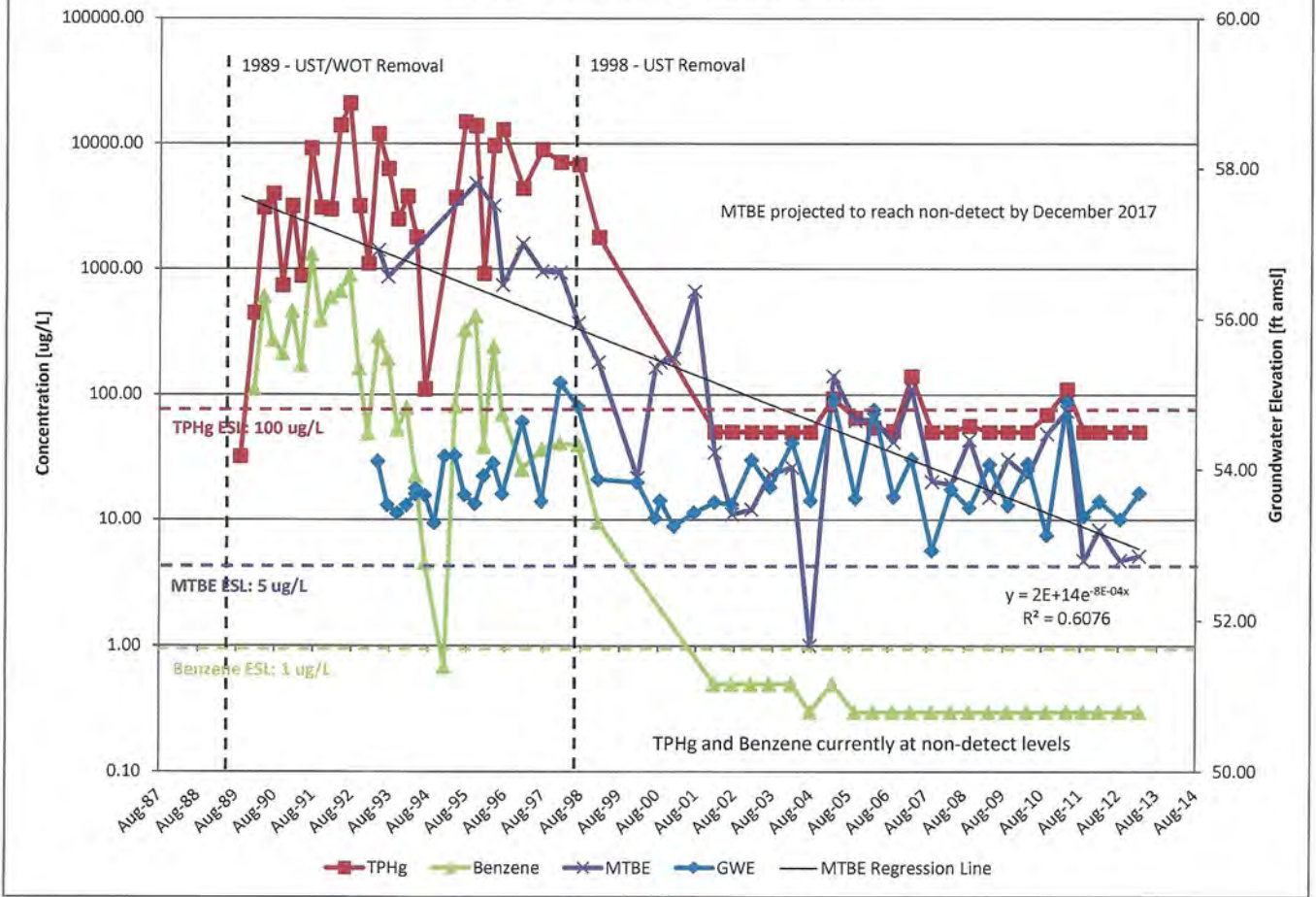

Chart B2: Groundwater Attenuation for MW-3



**Alternate Surrogates For Gasoline
(n-Pentane & Hexane)**