



RECEIVED

7:54 am, Mar 20, 2007

Alameda County
Environmental Health

March 16, 2007

Mr. Jerry Wickham
Department of Environmental Health
Alameda County Health Agency
1131 Harbor Bay Parkway
Alameda, California 94502

Subject: SLIC Case No. RO0002892, Chevron Sunol Pipeline, 2793 Calaveras Road, Sunol, CA – **Work Plan for Additional Site Characterization**

Dear Mr. Wickham:

On behalf of Chevron Pipe Line Company (Chevron), URS Corporation (URS) has prepared the attached work plan to install GORE™ modules to obtain additional subsurface data prior to installing additional groundwater monitoring wells at the Chevron Sunol Pipeline Site (Site) in Sunol, California. The attached work plan incorporates comments received from the Alameda County Environmental Health (ACEH) staff in the January 17, 2007 comment letter to Chevron. Specifically, this work plan is intended to fulfill the ACEH's technical report request to submit a work plan for further site characterization by March 19, 2007.

If you have any questions on this work plan, please call Mr. Joe Morgan at 510-874-3201.

Sincerely yours,

URS CORPORATION

Joe Morgan III
Senior Project Manager

WORK PLAN FOR ADDITIONAL
SITE CHARACTERIZATION
CHEVRON SUNOL PIPELINE
SUNOL, CALIFORNIA

SLIC CASE NO. RO0002892

Prepared for:

Chevron Pipe Line Company
4800 Fournace Place, E320C
Bellaire, Texas 77401

March 2007

URS

URS Corporation
1333 Broadway, Suite 800
Oakland, California 94612

26815217



Global Gas

Jeff Cosgray
Sr. Site Remediation
Specialist

**Health, Environmental &
Safety**
Chevron Pipe Line Company
4800 Fournace, E320C
Bellaire, Texas 77401-2324
Tel 713 432 3335
Fax 866 653 0301
JCOS@Chevron.com

March 14, 2007

Mr. Jerry Wickham
Department of Environmental Health
Alameda County Health Agency
1131 Harbor Bay Parkway
Alameda, California 94502

Dear Mr. Wickham:

I declare, under penalty of perjury, that the information and/or recommendations contained in URS' work plan titled "**Work Plan for Additional Site Characterization**" are true and correct to the best of my knowledge at the present time.

Submitted by:

A handwritten signature in black ink that reads "Jeffrey Cosgray". The signature is written in a cursive, flowing style.

Jeffrey Cosgray
Chevron Pipe Line Company

This Work Plan (“Work Plan for Additional Subsurface Investigation, Chevron Sunol Pipeline, Sunol, California”) was prepared under my direct supervision. The information and proposed additional subsurface investigation activities presented in this work plan are based on our review of available data obtained during our previous field efforts, studies performed by others, and laboratory data produced by independent laboratories. To the best of our knowledge, we have incorporated into our recommendations all relevant data pertaining to the Chevron Pipeline Release site in Sunol, California.

This Work Plan was developed in accordance with the standard of care used to develop this type of work plan. The assumptions that were made and the recommendations for additional field activities were based on our professional experience and protocols reported in the literature for similar investigations.



URS Corporation
Approved by:



Hanchih Angela Liang, Ph.D., P.E.

TABLE OF CONTENTS

Section 1	Introduction.....	1-1
Section 2	Background.....	2-1
	2.1 Release History and Investigation Effort to Date	2-1
	2.2 GORE™ Survey	2-2
Section 3	Field Activities	3-1
	3.1 Pre-Fieldwork Activities.....	3-1
	3.2 Fieldwork	3-1
	3.3 Health and Safety Monitoring.....	3-1
	3.4 Schedule.....	3-2
	3.5 Reporting.....	3-3
Section 4	References	4-1

Figures

1	Site Vicinity Map
2	Proposed Area for Additional Subsurface Investigation

Appendices

A	ACEH Letter dated January 17, 2007
B	USEPA ETV Program Certificate for GORE™ surveys

Acronyms and Abbreviations

ACEH	Alameda County Environmental Health Department
bgs	below ground surface
CPL	Chevron Pipe Line Company
ePTFE	expanded polytetrafluoroethene
ETV	Environmental Technology Verification
HASP	Health and Safety Plan
JSA	Job Safety Analysis
PID	photoionization detector
SFPUC	San Francisco Public Utilities Commission
SMS	Safety Management Standard
SVE	soil vapor extraction
URS	URS Corporation
USEPA	U.S. Environmental Protection Agency
VOC	volatile organic compound
SVOC	semi-volatile organic compound

On behalf of Chevron Pipe Line Company (Chevron), URS Corporation (URS) has prepared this “*Work Plan for Additional Site Characterization*” (Work Plan) for the Chevron Pipe Line Site (Site) in Sunol, California. This Work Plan is intended to meet with the requests stated in the January 17, 2007 Alameda County Environmental Health (ACEH) comment letter to CPL (Appendix A). Specifically, this Work Plan is intended to meet the requirement that a Work Plan for Site Characterization be submitted by March 19, 2007.

Due to the complex subsurface conditions at the Site, URS will collect additional subsurface data prior to installing additional monitoring wells. In an effort to place future groundwater monitoring wells in the optimal locations to more fully characterize the extent of the groundwater plume, URS reviewed four potential screening methods: Field Soil-Gas Sampling, GORE™ surveys (formerly known as GORE-SORBER® Screening Survey passive soil gas sampling system), Seismic Refraction Surveying, and Electrical Resistivity Tomography Surveying. Based on the evaluation of these four methods, the GORE™ surveys appear to be the best tool for obtaining additional subsurface information at the Site. This Work Plan describes the field activities involved in installing the GORE™ modules, retrieving the modules after the required length of time (approximately 14 days), and the analyses associated with the results. Based on the analytical results of the GORE™ modules, URS will submit a Work Plan for installing additional groundwater monitoring wells at the Site.

2.1 RELEASE HISTORY AND INVESTIGATION EFFORT TO DATE

An unleaded gasoline release occurred on August 14, 2005 when an underground pipeline (the Bay Area Product Line) was damaged during dirt road grading activities. The location of the pipeline release is approximately 2.7 miles south of the intersection of Interstate 680 and Calaveras Road, between mileposts 2.7 and 2.8 of Calaveras Road, in Sunol Valley, Valle de San Jose Mexican land grant (La Costa Valley Quadrangle) in Alameda County, California. The release location is approximately 4 miles southeast from the city of Sunol, California. The pipeline extends along Calaveras Road and traverses a steep hillside above the east side of the road (Figure 1). The San Francisco Public Utilities Commission (SFPUC) owns the property where the release occurred and leases it to a cattle rancher. Immediately to the west of Calaveras Road at the location of the release is a tree nursery (the Valley Crest Tree Company), which also leases the property from the SFPUC.

The release location is on a steep, west-facing slope with a grade of 80 to 90 percent. Vegetation at the release location is predominantly oak woodlands. A small stream is located approximately 150 to 200 feet north of the release location. This stream flows into the Alameda Creek floodplain and joins Alameda Creek seasonally.

URS has conducted six phases of subsurface investigations at the Site (URS 2005, 2006b). A total of nine groundwater monitoring wells (MW-1 through MW-9) as shown on Figure 2 were installed and quarterly groundwater monitoring have been conducted since the first quarter of 2006.

Two water-bearing zones are observed at the Site; the unconfined water-bearing zone (screened by wells MW-1 through MW-4, MW-8, and MW-9) and the confined sandstone water-bearing zone (screened by wells MW-5 through MW-7). Based on the quarterly groundwater monitoring results, the unconfined water-bearing zone appears to be the hydrogeologic unit of concern for contaminant transport. Although groundwater movement within the nursery unconfined water-bearing zone is affected by seasonal fluctuations in precipitation, the local groundwater flow direction is in a northerly direction (URS 2007).

Well MW-9 was installed in August 2006, approximately 160 feet northwest west of the release location, as shown on Figure 2. MW-9 was intended to define the northern extent of the

contaminant plume. However, free-phase product has been observed in MW-9 since the third quarter of 2006. URS plans to install additional groundwater monitoring wells to the north of MW-9 to assess the downgradient edge of the groundwater plume. Due to the complex subsurface conditions, URS will collect additional subsurface data prior to installing additional monitoring wells. The GORE™ Survey was chosen as a tool to collect soil gas samples in the area north of MW-9 within the nursery and the adjacent cattle grazing land. The approximate dimensions are 1,000 feet in length (N-S direction) and 200 feet in width (E-W direction), as shown on Figure 2. The modules will be installed in a grid pattern with a proposed spacing of 75 feet in the N-S direction and 50 feet in the E-W direction. Based on the survey results, URS will submit a Work Plan for installing additional groundwater monitoring wells.

2.2 GORE™ SURVEY

The GORE™ Survey underwent the U.S. Environmental Protection Agency (USEPA) Environmental Technology Verification (ETV) Program in 1997. The demonstration results indicated that the GORE™ Survey successfully collected soil gas samples in clay and sandy soils. The sampler provided positive identification of target compounds and may detect lower concentrations of VOCs in the soil gas than can the referenced soil gas sampling method. The USEPA ETV Report is included in Appendix B.

The GORE™ Survey uses GORE™ modules to collect soil gas samples. The module is a passive soil gas sampler that is designed to collect a broad range of volatile organic compounds (VOCs) and semi-volatile organic compounds (SVOCs), including halogenated compounds, petroleum hydrocarbons, and polynuclear aromatic hydrocarbons. A typical module contains two or more passive collection units called sorbers. Each sorber contains an equal amount of sorbent materials (polymeric and carbonaceous resins). These granular adsorbent materials are used because of their affinity for a broad range of VOCs and SVOCs. The sorbers are sheathed in the bottom of a 4-foot-long, vapor-permeable retrieval cord. The cord and the sorbers are constructed of inert, hydrophobic, microporous GORE-TEX® expanded polytetrafluoroethylene (ePTFE). The microporous structure of ePTFE allows vapors to move freely across the membrane and onto the sorbent material. This microporous structure also protects the granular adsorbents from physical contact with soil particulates and water. The module is installed to a depth of two to three feet below ground surface (bgs) manually by using push rods. The top of the hole is then sealed with

a stopper. The module is left in place for approximately 14 days and is then retrieved by hand. The manufacturer analyzes the modules and provides a colored contour map based on the relative analytical results (Appendix B).

3.1 PRE-FIELDWORK ACTIVITIES

Prior to fieldwork, URS will coordinate with the San Francisco Public Utilities Commission (SFPUC) to access the area north to the tree nursery. URS will obtain a boring permit from the Alameda County Flood Control and Water Conservation District - Zone 7 and notify Underground Service Alert 48 hours prior to fieldwork to identify any shallow utilities running through the area. Because the depth of the holes is only 3 feet bgs and will be hand augured, additional utility clearance of the area is not necessary.

3.2 FIELDWORK

The coverage of the screening method includes the area north of MW-9 within the nursery and the adjacent cattle grazing land. The approximate dimensions are 1,000 feet in length (N-S direction) and 200 feet in width (E-W direction), as shown on Figure 2. The modules will be installed in a grid pattern with a proposed spacing of 75 feet in the N-S direction and 50 feet in the E-W direction. Although Calaveras Road is included in the coverage area, no modules will be installed on the roadway. The easternmost line of modules will be installed along the eastern shoulder of Calaveras Road beyond the Calaveras Road right-of-way.

The GORE™ modules will be inserted into small (0.5-0.75-inch diameter) holes at depths of approximately three feet bgs. The hole will be created by advancing either push rods or a small diameter hand auger. The sampler is then manually inserted into the hole using push rods. The hole will then be sealed with a stopper. The module will remain in place for approximately 14 days to absorb soil gases and is then retrieved by hand. The modules will be analyzed by the manufacturer, W. L. Gore & Associates, Inc. for total petroleum hydrocarbons, benzene, toluene, ethylbenzene, and total xylzenes. A colored contour map based on the analytical results will be provided by the manufacture.

The holes will be grouted per Alameda County requirement after the modules are retrieved.

3.3 HEALTH AND SAFETY MONITORING

Before field activities begin, a site-specific health and safety orientation will be conducted for all on-site personnel. The following topics will be discussed at the briefing:

- Health and safety personnel names and alternates responsible for site health and safety.

- Site hazards, as identified in the Health and Safety Plan (HASP), e.g. biological, traffic, slip trip and fall, cutting hazards.
- Personal protective equipment.
- Heat stress symptoms and control measures that will be employed.
- Applicable URS Safety Management Standards (SMSs).
- Safe work practices, including those discussed in the HASP, Chevron's Safety Guidelines, and the Loss Prevention System.
- Personnel and equipment decontamination procedures.
- Air monitoring.
- Emergency procedures.
- Other applicable topics.

At the end of the briefing, attendees will be informally quizzed to assess their understanding of the health and safety requirements.

In addition to the initial site-specific health and safety briefing, daily health and safety meetings will be conducted to address health and safety concerns. These meetings will be documented using the On-Site Health and Safety Tailgate Meeting Record Form in the HASP. Job Safety Analyses (JSAs) will be developed for new tasks. The JSAs will be discussed in detail with the personnel working on the respective task(s). The JSAs will also be reviewed daily in the Safety Tailgate Meeting.

Air monitoring will be performed as often as necessary to protect field personnel from exposure to hazardous concentrations of chemicals. In particular, air monitoring will be conducted whenever new soil is broken and at least every 30 minutes thereafter. Measurements will be made at the ground surface and in the workers' breathing zone where the field activities are being performed. Personnel will perform air monitoring during work activities according to the air-monitoring plan in the HASP.

3.4 SCHEDULE

URS plans on installing the modules as soon as the week of March 26, 2006, providing all the equipment is available. Installing the modules should take no more than two field days. The modules will then be removed and sent in for analysis approximately two weeks after

installation. Removing the modules and sealing the holes should take no more than two field days.

3.5 REPORTING

Based on the contour maps showing the relative contaminant concentrations provided by GORE™, URS will prepare a work plan for the installation of additional groundwater monitoring wells to assess the downgradient edge of the contaminant plume within the unconfined water-bearing zone.

- URS 2005. *Subsurface Investigation Report, Chevron Pipeline Release, Sunol, California*. URS Corporation, December 15, 2005.
- URS 2006a. *Interim Remediation Report, Soil Vapor Extraction System for the Chevron Pipeline Release Location, Sunol, California, SLIC Case No. RO0002892*. URS Corporation, February 28, 2006.
- URS 2006b. *Additional Subsurface Investigation Report, Chevron Sunol Pipeline, Sunol, California*. URS Corporation, May 22, 2006.
- URS 2007. *Fourth Quarter 2006 groundwater monitoring report, Chevron Sunol Pipeline, Sunol, California*. URS Corporation, February 15, 2007.

Figures

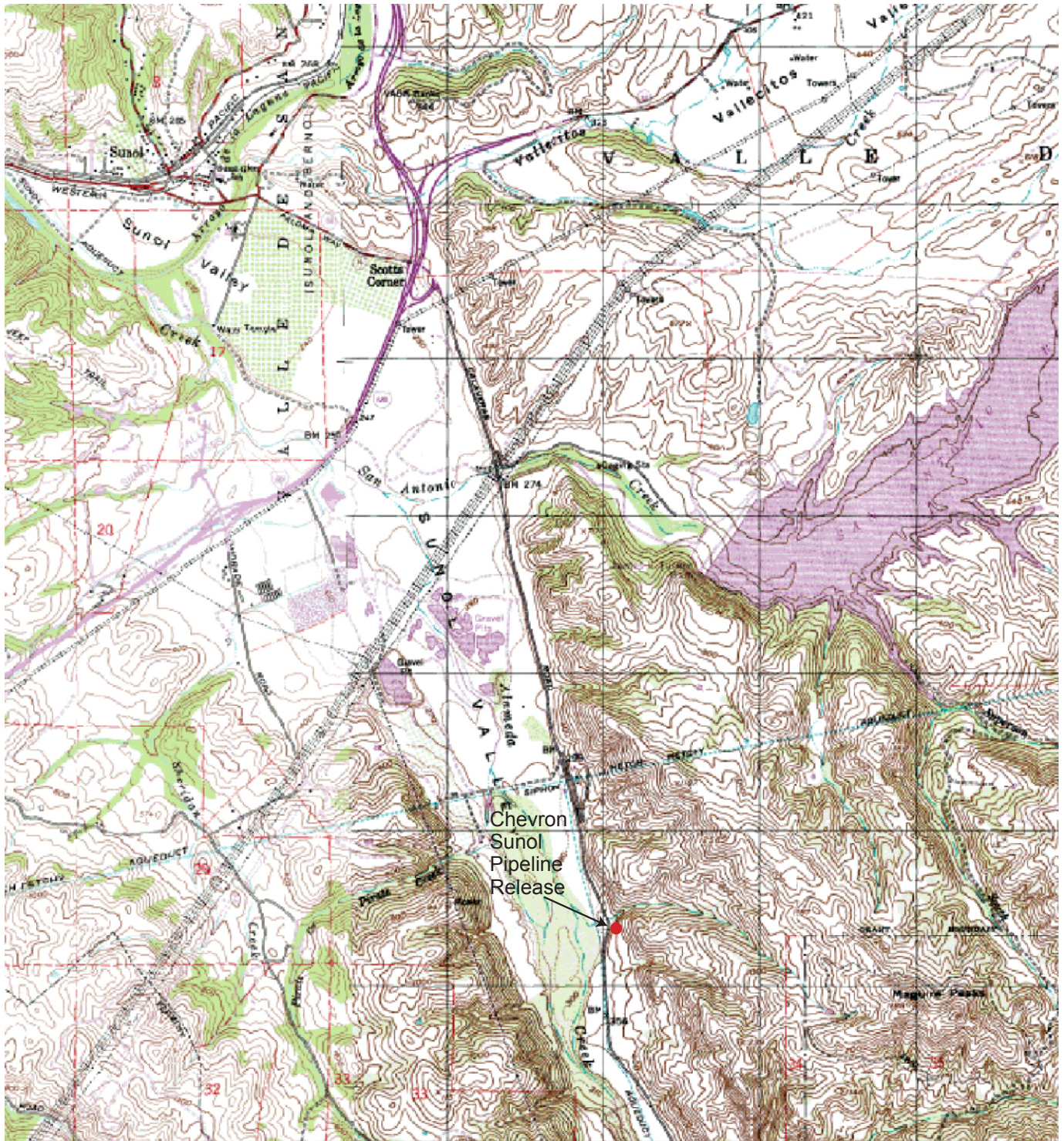
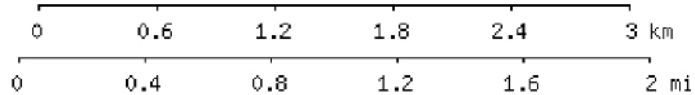

Image obtained from topozone.com



MAP REFERENCE:
 PORTION OF U.S.G.S. QUADRANGLE MAP
 7 1/2 MINUTE SERIES (TOPOGRAPHIC)
 LA COSTA VALLEY QUADRANGLE



Chevron Pipeline Company
 Project No. 26815217

SITE VICINITY MAP
 CHEVRON SUNOL PIPELINE
 SUNOL, CALIFORNIA

Figure
 1



LEGEND:

	MONITORING WELLS
	PROPOSED AREA FOR ADDITIONAL INVESTIGATION
	PIPELINE

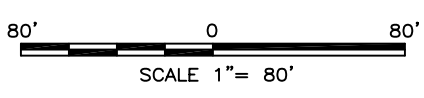

	CHEVRON PIPELINE COMPANY	PROPOSED AREA FOR ADDITIONAL SUBSURFACE INVESTIGATION	Figure 2
	Project No. 26815217		

Appendix A
ACEH Letter dated January 17, 2007

ALAMEDA COUNTY
HEALTH CARE SERVICES

AGENCY

DAVID J. KEARS, Agency Director



ENVIRONMENTAL HEALTH SERVICES
ENVIRONMENTAL PROTECTION
1131 Harbor Bay Parkway, Suite 250
Alameda, CA 94502-6577
(510) 567-6700
FAX (510) 337-9335

January 17, 2007

Mr. Jeff Cosgray
Chevron Pipe Line Company
4800 Fournace Place
Bellaire, TX 77401-2324

Subject: SLIC Case No. RO0002892, Chevron Sunol Pipeline, 2793 Calaveras Road, Sunol, CA

Dear Mr. Cosgray:

Alameda County Environmental Health (ACEH) staff has reviewed the case file for the above-referenced site including the reports entitled, "Additional Groundwater Monitoring Well Installation and Third Quarter 2006 Groundwater Monitoring Report," dated December 4, 2006 and "Soil Vapor Extraction System Start-Up Report," dated December 19, 2006. Both reports were prepared on your behalf by URS Corporation. The "Additional Groundwater Monitoring Well Installation and Third Quarter 2006 Groundwater Monitoring Report," presents the results from installation of two monitoring wells and analytical results from groundwater sampling conducted in August 2006. Groundwater monitoring well MW-8 was installed to monitor contaminant migration through a gravel layer above bedrock on the east side of Calaveras Road. Fuel hydrocarbons were detected at elevated concentrations in soil samples collected from the well boring and in the initial groundwater sample collected from MW-8. Well MW-9 was installed north of existing monitoring wells at the site to help evaluate the downgradient extent of contamination. Free-phase product was observed in well MW-9; therefore, the downgradient extent of dissolved phase contamination has not been determined. We request that you address the technical comments below and submit a Work Plan for additional investigation of the downgradient extent of contamination.

The "Soil Vapor Extraction System Start-Up Report," presents the results from installation of five additional soil vapor extraction (SVE) wells, soil sampling results, SVE start up, SVE system monitoring, and initial mass removal calculations. From system start up on November 28, 2006 to December 8, 2006, the system removed an estimated 920 pounds of hydrocarbons. Well SVE-8, which is located on the hillside slope is not operational due to groundwater in SVE-8. ACEH appreciates the efforts by Chevron Pipe Line Company to install the additional SVE wells on the steep hillside below the fuel release.

We request that you address the following technical comments, perform the proposed work, and send us the reports described below.

TECHNICAL COMMENTS

1. **Downgradient Extent of Contamination and Potential Discharge to Unnamed Creek and Alameda Creek.** Free-phase product is present in well MW-9, which is located approximately 160 feet west northwest of the release location. The purpose of well MW-9

was to assess the downgradient extent of dissolved phase contamination. Based on these results, please present plans in the Work Plan requested below to fully define the extent of free-phase product and the downgradient extent of dissolved phase groundwater contamination.

2. **Potential Discharge to Unnamed Creek and Alameda Creek.** We concur with the proposal to move the sampling location for the unnamed creek to a new location northwest of well MW-9 where the creek flows into the floodplain. Please implement this recommendation during the next quarterly groundwater monitoring. The location of the sampling location for the unnamed creek is to be shown on a detailed topographic map in the next quarterly monitoring report. ACEH will provide technical comments as necessary on the new location following receipt of the quarterly monitoring report.
3. **Conclusions Regarding Unconfined Groundwater at Well MW-8.** The fourth bulleted conclusion in the "Additional Groundwater Monitoring Well Installation and Third Quarter 2006 Groundwater Monitoring Report," regarding unconfined groundwater at well MW-8 indicates that, "the hillside appears to act as a recharge source for the nursery unconfined water-bearing zone." The conclusion goes on to state that, "the presence of groundwater at MW-8, within unconsolidated soils above the sandstone bedrock contact, supports URS' previous hypothesis that groundwater from the hillside acts as a preferential pathway for groundwater transport (URS 2006d)." We assume that the conclusion meant to state that the gravel layer is a preferential pathway for groundwater rather than groundwater acts as a preferential pathway for groundwater. However, this conclusion does not appear to be consistent with previous conclusions and recommendations by URS. Please note that URS submitted correspondence entitled, "Response to ACEH June 5, 2006 Letter – Technical Comment 1. Gravel Layer as Preferential Pathway," dated July 7, 2006, which objected to the installation of well MW-8 and indicated that, "the gravel zone in this area is part of the unsaturated zone rather than a saturated zone migration pathway, nor would wells in this location aid in further understanding of TPH migration or extent because it is in the middle of the impacted and migration pathway area that has already been investigated." The observation of groundwater within the gravel zone does not appear to be consistent with an unsaturated zone. Furthermore, the detection of elevated concentrations of fuel hydrocarbons in groundwater within a saturated preferential pathway does provide useful information to assess the ongoing transport of fuel hydrocarbons from the hillside to the unconfined groundwater west of Calaveras Road. Please revise your evaluation of groundwater flow through the gravel layer and propose any additional investigation or well installation that may be required in the Work Plan requested below.
4. **Quarterly Groundwater Monitoring.** Please continue quarterly groundwater monitoring from the existing wells and a surface water location as discussed in technical comment 2. Since ethanol and methanol have not been detected in results to date, you may discontinue analysis for ethanol and methanol in future groundwater monitoring. The "Additional Groundwater Monitoring Well Installation and Third Quarter 2006 Groundwater Monitoring Report," recommends continuing analysis for geochemical indicators. Please note that ACEH has not requested that you conduct analysis for geochemical indicators. The purpose of analyzing for geochemical indicators is not clear given the groundwater monitoring well network for the site. Wells MWS-1 and MW-9 have free product; well MW-2 appears to be upgradient of the groundwater contamination; wells MW-3 and MW-4 do not appear to sample formation water; and wells MW-5, -6, and -7 monitor the confined bedrock aquifer.

None of these wells appear to effectively monitor a dissolved phase plume in the unconfined aquifer. Only well MW-8, which is directly downslope from the release and contains groundwater with 18,000 micrograms per liter of TPH as gasoline appears to monitor dissolved phase concentrations in the unconfined aquifer. Please describe the rationale for continued monitoring of geochemical indicators. Please present results of the quarterly groundwater sampling in the monitoring reports requested below.

5. **Operation of SVE System.** We concur with the recommendation to monitor the operation of the SVE system. We request that you present results from the SVE system monitoring on a quarterly basis in the monitoring reports requested below.

TECHNICAL REPORT REQUEST

Please submit technical reports to Alameda County Environmental Health (Attention: Jerry Wickham), according to the following schedule:

- **February 15, 2007** – Quarterly Groundwater Monitoring Report for the Fourth Quarter 2007
- **March 19, 2007** – Work Plan for Site Characterization
- **March 20, 2007** – Quarterly SVE Operation and Monitoring Report
- **May 15, 2007** – Quarterly Groundwater Monitoring Report for the First Quarter 2007
- **June 20, 2007** – Quarterly SVE Operation and Monitoring Report

These reports are being requested pursuant to California Health and Safety Code Section 25296.10. 23 CCR Sections 2652 through 2654, and 2721 through 2728 outline the responsibilities of a responsible party in response to an unauthorized release from a petroleum UST system, and require your compliance with this request.

ELECTRONIC SUBMITTAL OF REPORTS

The Alameda County Environmental Cleanup Oversight Programs (LOP and SLIC) require submission of all reports in electronic form to the county's ftp site. Paper copies of reports will no longer be accepted. The electronic copy replaces the paper copy and will be used for all public information requests, regulatory review, and compliance/enforcement activities. Instructions for submission of electronic documents to the Alameda County Environmental Cleanup Oversight Program ftp site are provided on the attached "Electronic Report Upload (ftp) Instructions." Please do not submit reports as attachments to electronic mail.

Submission of reports to the Alameda County ftp site is an addition to existing requirements for electronic submittal of information to the State Water Resources Control Board (SWRCB) Geotracker website. Submission of reports to the Geotracker website does not fulfill the requirement to submit documents to the Alameda County ftp site. In September 2004, the SWRCB adopted regulations that require electronic submittal of information for groundwater cleanup programs. For several years, responsible parties for cleanup of leaks from underground storage tanks (USTs) have been required to submit groundwater analytical data, surveyed

locations of monitor wells, and other data to the Geotracker database over the Internet. Beginning July 1, 2005, electronic submittal of a complete copy of all necessary reports was required in Geotracker (in PDF format). Please visit the SWRCB website for more information on these requirements (http://www.swrcb.ca.gov/ust/cleanup/electronic_reporting).

PERJURY STATEMENT

All work plans, technical reports, or technical documents submitted to ACEH must be accompanied by a cover letter from the responsible party that states, at a minimum, the following: "I declare, under penalty of perjury, that the information and/or recommendations contained in the attached document or report is true and correct to the best of my knowledge." This letter must be signed by an officer or legally authorized representative of your company. Please include a cover letter satisfying these requirements with all future reports and technical documents submitted for this fuel leak case.

PROFESSIONAL CERTIFICATION & CONCLUSIONS/RECOMMENDATIONS

The California Business and Professions Code (Sections 6735, 6835, and 7835.1) requires that work plans and technical or implementation reports containing geologic or engineering evaluations and/or judgments be performed under the direction of an appropriately registered or certified professional. For your submittal to be considered a valid technical report, you are to present site specific data, data interpretations, and recommendations prepared by an appropriately licensed professional and include the professional registration stamp, signature, and statement of professional certification. Please ensure all that all technical reports submitted for this fuel leak case meet this requirement.

AGENCY OVERSIGHT

If it appears as though significant delays are occurring or reports are not submitted as requested, we will consider referring your case to the Regional Board or other appropriate agency, including the County District Attorney, for possible enforcement actions. California Health and Safety Code, Section 25299.76 authorizes enforcement including administrative action or monetary penalties of up to \$10,000 per day for each day of violation.

If you have any questions, please call me at (510) 567-6791.

Sincerely,

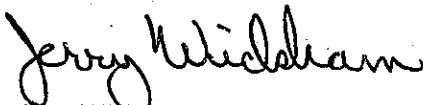

Jerry Wickham
Hazardous Materials Specialist

Enclosure: ACEH Electronic Report Upload (ftp) Instructions

Jeff Cosgray
January 17, 2007
Page 5

cc: Colleen Winey, QIC 80201
Zone 7 Water Agency
100 North Canyons Parkway,
Livermore, CA 94551

Joe Morgan III
URS Corporation
1333 Broadway, Suite 800
Oakland, CA 94612

Hanchih Angela Liang
URS Corporation
1333 Broadway, Suite 800
Oakland, CA 94612

Joe Naras
San Francisco Public Utilities Commission
Natural Resources Division
1657 Rollins Road
Burlingame, CA 94010

Craig Freeman
San Francisco Public Utilities Commission
Environmental and Regulatory Compliance Division
1145 Market Street, Suite 500
San Francisco, CA 94103

Donna Drogos, ACEH
Jerry Wickham, ACEH
File

Appendix B
USEPA ETV Program Certificate for GORE™ surveys

 **EPA Environmental Technology
Verification Report**

Soil Gas Sampling Technology

W. L. Gore & Associates, Inc.
GORE-SORBER Screening Survey



Environmental Technology Verification Report

Passive Soil Gas Sampler

W. L. Gore & Associates, Inc. GORE-SORBER[®] Screening Survey

Prepared by

Tetra Tech EM Inc.
591 Camino De La Reina, Suite 640
San Diego, California 92108

Contract No. 68-C5-0037

Dr. Stephen Billets
Characterization and Monitoring Branch
Environmental Sciences Division
Las Vegas, Nevada 89193-3478

National Exposure Research Laboratory
Office of Research and Development
U.S. Environmental Protection



Notice

This document was prepared for the U.S. Environmental Protection Agency's (EPA) Superfund Innovative Technology Evaluation Program under Contract No. 68-C5-0037. The work detailed in this document was administered by the National Exposure Research Laboratory—Environmental Sciences Division in Las Vegas, Nevada. The document has been subjected to EPA's peer and administrative reviews, and has been approved for publication as an EPA document. Mention of corporation names, trade names, or commercial products does not constitute endorsement or recommendation for use of specific products.



UNITED STATES ENVIRONMENTAL PROTECTION AGENCY

Office of Research and Development
Washington, D.C. 20460



ENVIRONMENTAL TECHNOLOGY VERIFICATION PROGRAM
VERIFICATION STATEMENT

TECHNOLOGY TYPE:	PASSIVE SOIL GAS SAMPLER
APPLICATION:	SUBSURFACE SOIL GAS SAMPLING
TECHNOLOGY NAME:	GORE-SORBER® SCREENING SURVEY PASSIVE SOIL GAS SAMPLING SYSTEM
COMPANY:	W.L. GORE & ASSOCIATES, INC.
ADDRESS:	100 CHESAPEAKE BOULEVARD ELKTON, MARYLAND 21921
PHONE:	(410) 392-7600

ETV PROGRAM DESCRIPTION

The U.S. Environmental Protection Agency (EPA) created the Environmental Technology Verification (ETV) Program to facilitate the deployment of innovative technologies through performance verification and information dissemination. The goal of the ETV Program is to further environmental protection by substantially accelerating the acceptance and use of improved and cost-effective technologies. The ETV Program is intended to assist and inform those involved in the design, distribution, permitting, and purchase of environmental technologies. This document summarizes the results of a demonstration of the W.L. Gore & Associates, Inc., GORE-SORBER® Screening Survey passive soil gas sampling system.

PROGRAM OPERATION

Under the ETV Program and with the full participation of the technology developer, the EPA evaluates the performance of innovative technologies by developing demonstration plans, conducting field tests, collecting and analyzing demonstration data, and preparing reports. The technologies are evaluated under rigorous quality assurance (QA) protocols to ensure that data of known and adequate quality are generated and that the demonstration results are defensible. The EPA's National Exposure Research Laboratory, which demonstrates field characterization and monitoring technologies, selected Tetra Tech EM Inc. as the verification organization to assist in field testing various soil and soil gas sampling technologies. This demonstration was conducted under EPA's Superfund Innovative Technology Evaluation Program.

DEMONSTRATION DESCRIPTION

In May and June 1997, the EPA conducted a field test of the GORE-SORBER® Screening Survey passive soil gas sampling system along with one other soil gas and four soil sampling technologies. This verification statement focuses on the GORE-SORBER® Screening Survey passive soil gas sampling system; similar statements have been prepared for each of the other technologies. The performance of the GORE-SORBER® Screening Survey passive soil gas sampling system was compared to the reference sampling method, active soil gas sampling (which provides a snapshot of the soil gas environment at the time the sample is collected). The comparison addressed three parameters: (1) volatile organic compound (VOC) detection and quantitation, (2) sample retrieval time, and (3) cost. Data quality indicators for precision, accuracy, representativeness, completeness, and comparability were also assessed against project-specific QA objectives to ensure the usefulness of the data.

The GORE-SORBER[®] Screening Survey passive soil gas sampling system was demonstrated at two sites: the Small Business Administration (SBA) site in Albert City, Iowa, and the Chemical Sales Company (CSC) site in Denver, Colorado. These sites were chosen because each site exhibited a wide range of VOC concentrations and a distinct soil type. The VOCs detected at the sites include vinyl chloride; cis-1,2-dichloroethene (cis-1,2-DCE); 1,1-dichloroethane (1,1-DCA); 1,1,1-trichloroethane (1,1,1-TCA); trichloroethene (TCE); and tetrachloroethene (PCE). The SBA site is composed primarily of clay soil, and the CSC site is composed primarily of medium- to fine-grained sandy soil. A complete description of the demonstration, including a data summary and discussion of results, is available in the report titled *Environmental Technology Verification Report: Passive Soil Gas Sampler*, W.L. Gore & Associates, Inc., GORE-SORBER[®] Screening Survey, EPA 600/R-98/095.

TECHNOLOGY DESCRIPTION

The GORE-SORBER[®] Screening Survey uses GORE-SORBER[®] modules to collect soil gas samples. The GORE-SORBER[®] module is a passive soil gas sampler that is designed to collect a broad range of VOCs and semivolatile organic compounds (SVOC), including halogenated compounds, petroleum hydrocarbons, and polynuclear aromatic hydrocarbons. A typical GORE-SORBER[®] module contains two or more passive collection units called sorbers. Each sorber contains an equal amount of sorbent materials (polymeric and carbonaceous resins). These granular adsorbent materials are used because of their affinity for a broad range of VOCs and SVOCs. The sorbers are sheathed in the bottom of a 4-foot-long, vapor-permeable retrieval cord. The cord and the sorbers are constructed of inert, hydrophobic, microporous GORE-TEX[®] expanded polytetrafluoroethene (ePTFE). The microporous structure of ePTFE allows vapors to move freely across the membrane and onto the sorbent material. This microporous structure also protects the granular adsorbents from physical contact with soil particulates and water. The GORE-SORBER[®] module is installed to a depth of 2 to 3 feet. A pilot hole is created using a slide hammer and tile probe or hand drill (in paved areas). The sampler is then manually inserted into the hole using push rods. The module is retrieved by hand and must be analyzed by the developer.

VERIFICATION OF PERFORMANCE

The demonstration data indicate the following performance characteristics for the GORE-SORBER[®] Screening Survey passive soil gas sampling system:

VOC Detection and Quantitation: The GORE-SORBER[®] Screening Survey detected the same compounds in each sample as the reference soil gas sampling method, as well as several VOCs that the reference method did not detect. This performance characteristic suggests that the GORE-SORBER[®] Screening Survey may detect VOCs that are at lower concentrations in the subsurface than the reference soil gas sampling method can detect. The results also indicate a general correlation between the GORE-SORBER[®] Screening Survey and reference method data. However, at high contaminant levels, the ratio between the mass of contaminant in soil gas detected using the GORE-SORBER[®] module and the concentration of contaminant in soil gas detected using the reference soil gas sampling method decreases, suggesting that sorbent saturation may have occurred. The GORE-SORBER[®] Screening Survey and reference method are field screening techniques that provide only an estimate of the actual concentration of contaminants in soil gas. Because the GORE-SORBER[®] Screening Survey and reference method use different techniques to collect soil gas samples, it is not expected that the two methods will provide the same response or that the data will be directly comparable. In addition, the GORE-SORBER[®] Screening Survey yields results in micrograms per sample and the reference soil gas sampling method reports results in nanograms per liter. Therefore, a statistical analysis of the data was not performed, and interpretation of the chemical concentration data for this demonstration is limited to qualitative observations.

Sample Retrieval Time: Installation of the GORE-SORBER[®] modules averaged 8.0 minutes per sampler at the SBA site and 7.4 minutes per sampler at the CSC site. For the demonstration, the modules were left in place for approximately 10 days. Collection of the modules required an average of 1.9 minutes per sampler at the SBA site and 2.4 minutes at the CSC site. Overall, installation and collection of 35 GORE-SORBER[®] modules at the SBA site required 346 minutes, an average of 9.9 minutes per sample and installation and collection of 28 GORE-SORBER[®] modules at the CSC site required 274 minutes, an average of 9.8 minutes per sample. The analysis and reporting by the technology developer required 14 to 18 days from the time samples were collected until the laboratory report was delivered. The reference soil gas method required 458 minutes to collect 35 samples at the SBA site, an average of 13.1 minutes per sample, and 183 minutes to collect 28 samples at the CSC site, an average

of 6.5 minutes per sample. One day was required per site to analyze the samples and report the results. Based on the demonstration results, the average sample retrieval times for the GORE-SORBER[®] modules were quicker than the reference soil gas sampling method in the clay soils at the SBA site and slower than the reference sampling method in the sandy soils at the CSC site. The results also indicate that the sample retrieval time for the GORE-SORBER[®] modules may be less susceptible to variations in soil type than the sample collection times for the reference method. During sample collection using the reference active soil gas sampler, the clay soil at the SBA site caused the system to hold its vacuum at several sampling locations; therefore, soil gas was not completely drawn into the system for sampling. In these cases, the rod was withdrawn in additional 6-inch increments until the vacuum was broken and the system's pressure reached equilibrium with atmospheric pressure. The vacuum problem was not encountered in the sandy soil at the CSC site. A two-person sampling crew retrieved soil gas samples using the GORE-SORBER[®] Screening Survey at both the SBA and CSC sites, and a three-person sampling and analysis crew collected and analyzed the soil gas samples using the reference soil gas sampling method at both sites.

Cost Based on the demonstration results, the GORE-SORBER[®] Screening Survey cost \$125 to \$225 per sample plus equipment costs of \$25 to \$85 per day and mobilization/demobilization costs of \$200 to \$600 per day. Operating costs for the GORE-SORBER[®] Screening Survey ranged from \$810 to \$1,540 at both the clay soil site and the sandy soil site. For this demonstration, the active soil gas sampling method was procured at a lump sum of \$4,700 per site for the collection and analysis of 40 soil gas samples at each site. Oversight costs for the active soil gas sampling method ranged from \$680 to \$1,260 at the clay soil site and \$480 to \$910 at the sandy soil site. A site-specific cost and performance analysis is recommended before selecting a subsurface soil gas sampling method.

A qualitative performance assessment of the GORE-SORBER[®] Screening Survey indicated that (1) all 63 modules installed at the SBA and CSC sites were retrieved without sample loss, resulting in 100 percent completeness; (2) the sampler is easy to use and requires minimal training (a 10-minute training video is available from the developer); (3) logistical requirements for the GORE-SORBER[®] Screening Survey require that the samplers be installed using a manual push tool, left in place for several days, retrieved by hand, and sent to the developer for analysis; and (4) sample handling in the field requires that sorbent be properly containerized and shipped to the developer. Other factors that may affect the performance range of the GORE-SORBER[®] Screening Survey but that were not evaluated during the demonstration are sampling depth, time allowed for sampling, type and amount of sorbent material placed in the GORE-SORBER[®] module, and ability of vapors to move across the module membrane.

The demonstration results indicate that the GORE-SORBER[®] Screening Survey can provide useful, cost-effective data for environmental problem-solving. The GORE-SORBER[®] modules successfully collected soil gas samples in clay and sandy soils. The sampler provided positive identification of target compounds and may detect lower concentrations of VOCs in the soil gas than can the reference soil gas sampling method. Based on the results of this demonstration, there appears to be a general correlation between the GORE-SORBER[®] Screening Survey and reference method data. However, at higher contaminant levels, the ratio between the mass of contaminant detected in the soil gas using the GORE-SORBER[®] module and the concentration of contaminant detected using the reference method decreases. As with any technology selected, the user must determine what is appropriate for the application and the project data quality objectives.

Gary J. Foley, Ph.D.
Director
National Exposure Research Laboratory
Office of Research and Development

NOTICE: EPA verifications are based on an evaluation of technology performance under specific, predetermined criteria and appropriate quality assurance procedures. EPA makes no expressed or implied warranties as to the performance of the technology and does not certify that a technology will always operate as verified. The end user is solely responsible for complying with any and all applicable federal, state, and local requirements.

Foreword

The U.S. Environmental Protection Agency (EPA) is charged by Congress with protecting the nation's natural resources. Under the mandate of national environmental laws, the Agency strives to formulate and implement actions leading to a compatible balance between human activities and the ability of natural systems to support and nurture life. To meet this mandate, the EPA's Office of Research and Development (ORD) provides data and science support that can be used to solve environmental problems and to build the scientific knowledge base needed to manage our ecological resources wisely, to understand how pollutants affect our health, and to prevent or reduce environmental risks.

The National Exposure Research Laboratory (NERL) is the Agency's center for the investigation of technical and management approaches for identifying and quantifying risks to human health and the environment. Goals of the Laboratory's research program are to (1) develop and evaluate methods and technologies for characterizing and monitoring air, soil, and water; (2) support regulatory and policy decisions; and (3) provide the science support needed to ensure effective implementation of environmental regulations and strategies.

The EPA's Superfund Innovative Technology Evaluation (SITE) Program evaluates technologies for the characterization and remediation of contaminated Superfund and Resource Conservation and Recovery Act sites. The SITE Program was created to provide reliable cost and performance data to speed the acceptance and use of innovative remediation, characterization, and monitoring technologies by the regulatory and user communities.

Effective measurement and monitoring technologies are needed to assess the degree of contamination at a site, to provide data that can be used to determine the risk to public health or the environment, to supply the necessary cost and performance data to select the most appropriate technology, and to monitor the success or failure of a remediation process. One component of the EPA SITE Program, the Monitoring and Measurement Technology Program, demonstrates and evaluates innovative technologies to meet these needs.

Candidate technologies can originate from within the federal government or from the private sector. Through the SITE Program, developers are given the opportunity to conduct a rigorous demonstration of their technology under actual field conditions. By completing the evaluation and distributing the results, the Agency establishes a baseline for acceptance and use of these technologies. The Monitoring and Measurement Technology Program is managed by the ORD's Environmental Sciences Division in Las Vegas, Nevada.

Gary Foley, Ph.D.
Director
National Exposure Research Laboratory
Office of Research and Development

Contents

Notice	ii
Verification Statement	iii
Foreword	vi
Figures	ix
Tables	x
Acronyms and Abbreviations	xi
Acknowledgments	xii
Executive Summary	xiii
Chapter 1 Introduction	1
Technology Verification Process	3
Needs Identification and Technology Selection	3
Demonstration Planning and Implementation	3
Report Preparation	4
Information Distribution	4
Demonstration Purpose	4
Chapter 2 Technology Description	5
Background	5
Components and Accessories	7
General Operating Procedures	7
Developer Contact	9
Chapter 3 Site Descriptions and Demonstration Design	10
Site Selection and Description	10
SBA Site Description	10
CSC Site Description	12
Predemonstration Sampling and Analysis	14
Demonstration Design	14
VOC Detection and Quantitation	16
Sample Retrieval Time	16
Cost	17
Deviations from the Demonstration Plan	17
Chapter 4 Description and Performance of the Reference Method	18
Background	18
Components and Accessories	18
Description of Platform	19
Demonstration Operating Procedures	19
Qualitative Performance Factors	20
Reliability and Ruggedness	20
Training Requirements and Ease of Operation	21
Logistical Requirements	21
Sample Handling	21

Contents (Continued)

Performance Range	21
Quantitative Performance Factors	21
VOC Detection and Quantitation	22
Sample Retrieval Time	22
Data Quality	22
Chapter 5 Technology Performance	25
Qualitative Performance Factors	25
Reliability and Ruggedness	25
Training Requirements and Ease of Operation	25
Logistical Requirements	25
Sample Handling	26
Performance Range	26
Quantitative Performance Assessment	26
VOC Detection and Quantitation	26
Sample Retrieval Time	29
Data Quality	32
Chapter 6 Economic Analysis	34
Assumptions	34
GORE-SORBER® Screening Survey	34
Reference Sampling Method	36
Chapter 7 Summary of Demonstration Results	39
Chapter 8 Technology Update	41
Chapter 9 Previous Deployment	43
References	44
Appendix	
A Data Summary Tables	A-1

Figures

2-1.	GORE-SORBER® Module Schematic	8
3-1.	Small Business Administration Site	11
3-2.	Chemical Sales Company Site	13
3-3.	Typical Sampling Locations and Random Sampling Grid	15
5-1.	Comparative Plot of Mean Total DCE Mass Versus Concentration	30
5-2.	Comparative Plot of Mean 1,1,1-TCA Mass Versus Concentration	30
5-3.	Comparative Plot of Mean TCE Mass Versus Concentration	31
5-4.	Comparative Plot of Mean PCE Mass Versus Concentration	31

Tables

4-1.	Volatile Organic Compound Concentrations in Samples Collected Using the Reference Soil Gas Sampling Method	23
5-1.	Volatile Organic Compound Mass in Samples Collected Using the GORE-SORBER® Screening Survey	27
5-2.	Mean Chemical Concentrations of the GORE-SORBER® Screening Survey and Reference Soil Gas Sampling Method	28
5-3.	Average Sample Retrieval Times for the GORE-SORBER® Modules and the Reference Soil Gas Sampling Method	32
6-1.	Estimated Subsurface Soil Gas Sampling Costs for the GORE-SORBER® Screening Survey	35
6-2.	Estimated Subsurface Soil Gas Sampling Costs for the Reference Sampling Method	37

Acronyms and Abbreviations

bgs	below ground surface
cc	cubic centimeter
cis-1,2-DCE	cis-1,2-dichloroethene
CRREL	Cold Regions Research Engineering Laboratory
CSC	Chemical Sales Company
1,1-DCA	1,1-dichloroethane
DCE	dichloroethene
E&E	Ecology & Environment
EPA	U.S. Environmental Protection Agency
ePTFE	expanded polytetrafluoroethene
ETV	Environmental Technology Verification
ETVR	Environmental Technology Verification Report
GC/MS	gas chromatography/mass spectrometer
Gore	W.L. Gore & Associates, Inc.
mg/kg	milligrams per kilogram
ml	milliliter
Fg	micrograms
Fg/kg	micrograms per kilogram
NELAC	National Environmental Laboratory Accreditation Conference
ng/L	nanograms per liter
NERL	National Exposure Research Laboratory
OU	operable unit
PAH	polynuclear aromatic hydrocarbons
PCE	tetrachloroethene
QA	quality assurance
QA/QC	quality assurance/quality control
RCRA	Resource Conservation and Recovery Act
RI/FS	remedial investigation/feasibility study
RPD	relative percent difference
SBA	Small Business Administration
SITE	Superfund Innovative Technology Evaluation
SMC	Superior Manufacturing Company
SVE	soil vapor extraction
SVOC	semivolatile organic compound
1,1,1-TCA	1,1,1-trichloroethane
TCE	trichloroethene
trans-1,2-DCE	trans-1,2-dichloroethene
VOC	volatile organic compound

Acknowledgments

This report was prepared for the U.S. Environmental Protection Agency's (EPA) Environmental Technology Verification Program under the direction of Stephen Billets, Brian Schumacher, and Eric Koglin of the EPA's National Exposure Research Laboratory—Environmental Sciences Division in Las Vegas, Nevada. The project was also supported by the EPA's Superfund Innovative Technology Evaluation (SITE) Program. The EPA wishes to acknowledge the support of Janice Kroone (EPA Region 7), Joe Vranka (Colorado Department of Public Health and the Environment), Armando Saenz (EPA Region 8), Sam Goforth (independent consultant), Alan Hewitt (Cold Regions Research Engineering Laboratory), Bob Siegrist (Colorado School of Mines), and Ann Kern (EPA SITE Program). In addition, we gratefully acknowledge the collection of the passive soil gas samples using the GORE-SORBER[®] Screening Survey by Mark Wrigley (Gore); implementation of this demonstration by Eric Hess and John Parks (Tetra Tech); editorial and publication support by Butch Fries, Jennifer Brainerd, and Stephanie Anderson (Tetra Tech); and technical report preparation by Ron Ohta, Roger Argus, and Ben Hough (Tetra Tech).

Executive Summary

In May and June 1997, the U.S. Environmental Protection Agency conducted a demonstration of the GORE-SORBER[®] Screening Survey, one other soil gas sampling technology, and four soil sampling technologies. This Environmental Technology Verification Report presents the results of the GORE-SORBER[®] Screening Survey demonstration; similar reports have been published for each technology.

The GORE-SORBER[®] module is a passive soil gas sampler that consists of several separate sorbent collection units called sorbers. Each sorber contains equal quantities of sorbent materials (polymeric and carbonaceous resins) selected for their affinity to a broad range of volatile organic compounds (VOC) and semivolatile organic compounds, and for their hydrophobic characteristics. The sorbers are sheathed in a vapor-permeable insertion and retrieval cord constructed of inert, hydrophobic material that allows vapors to move freely across the membrane and onto the sorbent material and that protects the granular adsorbents from physical contact with soil particulates and water.

The GORE-SORBER[®] module was demonstrated at two sites: the Small Business Administration (SBA) site in Albert City, Iowa, and the Chemical Sales Company (CSC) site in Denver, Colorado. These sites were chosen because each exhibited a wide range of VOC concentrations and because each had a distinct soil type. The VOCs detected at the sites include vinyl chloride; cis-1,2-dichloroethene; trichloroethene; 1,1-dichloroethane; 1,1,1-trichloroethane; and tetrachloroethene. The SBA site is composed primarily of clay soil, and the CSC site is composed primarily of medium- to fine-grained sandy soil.

The GORE-SORBER[®] Screening Survey was compared to a reference sampling method, active soil gas sampling, in terms of the following parameters: (1) VOC detection and quantitation, (2) sample retrieval time, and (3) cost. The demonstration data indicated the following performance characteristics for the GORE-SORBER[®] Screen Survey passive soil gas sampling system:

- C The GORE-SORBER[®] Screening Survey detected the same compounds as the reference sampling method, as well as several VOCs that the reference method did not detect. The results also indicate a general correlation between the GORE-SORBER[®] Screening Survey and reference sampling method data. However, at high contaminant levels, the ratio between the mass of contaminant in soil gas detected using the GORE-SORBER[®] module and the concentration of contaminant in soil gas detected using the reference method decreases.
- C The average sample retrieval times for the GORE-SORBER[®] modules were quicker than the reference soil gas sampling method in the clay soils at the SBA site and slower than the reference sampling method in the sandy soils at the CSC site. For this demonstration, the GORE-SORBER[®] modules were left in place for 10 days at each site and required an average of 16 days per site for analysis and reporting by the developer.
- C Based on the demonstration results, the GORE-SORBER[®] Screening Survey cost \$125 to \$225 per sample plus equipment costs of \$25 to \$85 per day and mobilization/demobilization costs of \$200 to \$600 per site. Operating costs for the GORE-SORBER[®] Screening Survey ranged from \$810 to \$1,540 at both the clay soil site and the sandy soil site.

In general, the results for data quality indicators selected for this demonstration met the established quality assurance objectives and support the usefulness of the demonstration results in verifying the GORE-SORBER[®] Screening Survey's performance.

Chapter 1 Introduction

Performance verification of innovative and alternative environmental technologies is an integral part of the U.S. Environmental Protection Agency's (EPA) regulatory and research mission. Early efforts focused on evaluating technologies that supported implementation of the Clean Air and Clean Water Acts. To meet the needs of the hazardous waste program, the Superfund Innovative Technology Evaluation (SITE) Program was established by the EPA Office of Solid Waste and Emergency Response (OSWER) and Office of Research and Development (ORD) as part of the Superfund Amendments and Reauthorization Act of 1986. The primary purpose of the SITE Program is to promote the acceptance and use of innovative characterization, monitoring, and treatment technologies.

The overall goal of the SITE Program is to conduct research and performance verification studies of alternative or innovative technologies that may be used to achieve long-term protection of human health and the environment. The various components of the SITE Program are designed to encourage the development, demonstration, acceptance, and use of new or innovative treatment and monitoring technologies. The program is designed to meet four primary objectives: (1) identify and remove obstacles to the development and commercial use of alternative technologies, (2) support a development program that identifies and nurtures emerging technologies, (3) demonstrate promising innovative technologies to establish reliable performance and cost information for site characterization and cleanup decision-making, and (4) develop procedures and policies that encourage the selection of alternative technologies at Superfund sites, as well as other waste sites and commercial facilities.

The intent of a SITE demonstration is to obtain representative, high quality, performance and cost data on innovative technologies so that potential users can assess a given technology's suitability for a specific application. The SITE Program includes the following elements:

- C Monitoring and Measurement Technology (MMT) Program** — Evaluates technologies that detect, monitor, sample, and measure hazardous and toxic substances. These technologies are expected to provide better, faster, and more cost-effective methods for producing real-time data during site characterization and remediation studies

- C Remediation Technologies** — Conducts demonstrations of innovative treatment technologies to provide reliable performance, cost, and applicability data for site cleanup

- C Technology Transfer Program** — Provides and disseminates technical information in the form of updates, brochures, and other publications that promote the program and the technology. Provides technical assistance, training, and workshops to support the technology

The MMT Program provides developers of innovative hazardous waste measurement, monitoring, and sampling technologies with an opportunity to demonstrate a technology's performance under actual field conditions. These technologies may be used to detect, monitor, sample, and measure hazardous and toxic substances in soil, sediment, waste materials, and groundwater. Technologies include chemical sensors for *in situ* (in place) measurements, groundwater sampling devices, soil and core sampling devices, soil gas samplers, laboratory and field-portable analytical equipment, and other systems that support field sampling or data acquisition and analysis.

The MMT Program promotes the acceptance of technologies that can be used to accurately assess the degree of contamination at a site, provide data to evaluate potential effects on human health and the environment, apply data to assist in selecting the most appropriate cleanup action, and monitor the effectiveness of a remediation process. Acceptance into the program places high priority on innovative technologies that provide more cost-effective, faster, and safer methods than conventional technologies for producing real-time or near-real-time data. These technologies are demonstrated under field conditions and results are compiled, evaluated, published, and disseminated by ORD. The primary objectives of the MMT Program are the following:

- C Test field analytical technologies that enhance monitoring and site characterization capabilities
- C Identify the performance attributes of new technologies to address field characterization and monitoring problems in a more cost-effective and efficient manner
- C Prepare protocols, guidelines, methods, and other technical publications that enhance the acceptance of these technologies for routine use

The SITE MMT Program is administered by ORD's National Exposure Research Laboratory (NERL-LV) at the Environmental Sciences Division in Las Vegas, Nevada.

In 1994, the EPA created the Environmental Technology Verification (ETV) Program to facilitate the deployment of innovative technologies in other areas of environmental concern through performance verification and information dissemination. As in the SITE Program, the goal of the ETV Program is to further environmental protection by substantially accelerating the acceptance and use of improved and cost-effective technologies. The ETV Program is intended to assist and inform those involved in the design, distribution, permitting, and purchase of various environmental technologies. The ETV Program capitalizes on and applies the lessons learned in implementing the SITE Program.

For each demonstration, the EPA draws on the expertise of partner "verification organizations" to design efficient procedures for conducting performance tests of environmental technologies. The EPA selects its partners from both the public and private sectors, including federal laboratories, states, universities, and private sector entities. Verification organizations oversee and report verification activities based on testing and quality assurance (QA) protocols developed with input from all major stakeholder and customer groups associated with the technology area. For this demonstration, the EPA selected Tetra Tech EM Inc. (Tetra Tech; formerly PRC Environmental Management, Inc.) as the verification organization.

In May and June 1997, the EPA conducted a demonstration, funded by the SITE Program, to verify the performance of four soil and two soil gas sampling technologies: SimulProbe® Technologies, Inc., Core Barrel Sampler; Geoprobe® Systems, Inc., Large-Bore Soil Sampler; AMS™ Dual Tube Liner

Sampler; Clements Associates, Inc., Environmentalist's Subsoil Probe; Quadrel Services, Inc., EMFLUX® Soil Gas Investigation System; and W.L. Gore & Associates, Inc., GORE-SORBER® Screening Survey passive soil gas sampling system. This environmental technology verification report (ETVR) presents the results of the demonstration for one soil gas sampling technology, the GORE-SORBER® Screening Survey passive soil gas sampling system. Separate ETVRs have been published for the remaining soil and soil gas sampling technologies.

Technology Verification Process

The technology verification process is designed to conduct demonstrations that will generate high-quality data that the EPA and others can use to verify technology performance and cost. Four key steps are inherent in the process: (1) needs identification and technology selection, (2) demonstration planning and implementation, (3) report preparation, and (4) information distribution.

Needs Identification and Technology Selection

The first aspect of the technology verification process is to identify technology needs of the EPA and the regulated community. The EPA, the U.S. Department of Energy, the U.S. Department of Defense, industry, and state agencies are asked to identify technology needs for characterization, sampling, and monitoring. Once a technology area is chosen, a search is conducted to identify suitable technologies that will address that need. The technology search and identification process consists of reviewing responses to *Commerce Business Daily* announcements, searches of industry and trade publications, attendance at related conferences, and leads from technology developers. Selection of characterization and monitoring technologies for field testing includes an evaluation of the candidate technology against the following criteria:

- C Designed for use in the field or in a mobile laboratory
- C Applicable to a variety of environmentally contaminated sites
- C Has potential for resolving problems for which current methods are unsatisfactory
- C Has costs that are competitive with current methods
- C Performs better than current methods in areas such as data quality, sample preparation, or analytical turnaround time
- C Uses techniques that are easier and safer than current methods
- C Is commercially available

Demonstration Planning and Implementation

After a technology has been selected, the EPA, the verification organization, and the developer agree to a strategy for conducting the demonstration and evaluating the technology. The following issues are addressed at this time:

-
- C Identifying and defining the roles of demonstration participants, observers, and reviewers
 - C Identifying demonstration sites that provide the appropriate physical or chemical attributes in the desired environmental media
 - C Determining logistical and support requirements (for example, field equipment, power and water sources, mobile laboratory, or communications network)
 - C Arranging analytical and sampling support
 - C Preparing and implementing a demonstration plan that addresses the experimental design, the sampling design, quality assurance/quality control (QA/QC), health and safety, field and laboratory operations scheduling, data analysis procedures, and reporting requirements

Report Preparation

Each of the innovative technologies is evaluated independently and, when possible, against a reference technology. The technologies are usually operated in the field by the developers in the presence of independent observers. These individuals are selected by the EPA or the verification organization and work to ensure that the technology is operated in accordance with the demonstration plan. Demonstration data are used to evaluate the capabilities, performance, limitations, and field applications of each technology. After the demonstration, all raw and reduced data used to evaluate each technology are compiled into a technology evaluation report as a record of the demonstration. A verification statement and detailed evaluation narrative of each technology are published in an ETVR. This document receives a thorough technical and editorial review prior to publication.

Information Distribution

The goal of the information distribution strategy is to ensure that ETVRs are readily available to interested parties through traditional data distribution pathways, such as printed documents. Related documents and technology updates are also available on the World Wide Web through the ETV Web site (<http://www.epa.gov/etv>) and through the Hazardous Waste Clean-Up Information Web site supported by the EPA OSWER Technology Innovation Office (<http://clu-in.org>). Additional information on the SITE Program can be found on ORD's web site (<http://www.epa.gov/ORD/SITE>).

Demonstration Purpose

The purpose of this demonstration of the GORE-SORBER[®] Screening Survey was to evaluate how the sampler performed relative to the reference sampling method, active soil gas sampling. Specifically, this demonstration evaluated the GORE-SORBER[®] Screening Survey in comparison to the reference soil gas sampling method in terms of the following parameters: (1) volatile organic compound (VOC) detection and quantitation, (2) sample retrieval time, and (3) cost. Data quality indicators for precision, accuracy, representativeness, completeness, and comparability were also assessed against established QA objectives to ensure the usefulness of the data for the purpose of this verification.

Chapter 2

Technology Description

This chapter describes the GORE-SORBER[®] Screening Survey, including its background, components and accessories, and general operating procedures. The text in this chapter was provided by the developer and was edited for format and relevance.

Background

Soil gas sampling techniques can be broadly divided into two categories: active and passive. The active soil gas sampling method uses vacuum methods to collect soil gas samples at discrete depth intervals and provides a “snapshot” of the soil gas environment at a particular moment and at a specific depth. This approach requires detectable vapor-phase compound concentrations, relatively porous subsurface soil, and experienced on-site personnel. Because the soil gas samples are usually analyzed immediately, an on-site or nearby laboratory is typically required. Active soil gas sampling is generally used for rapid screening of VOCs in the subsurface in moderately permeable soils and is generally not applicable to detecting semivolatile organic compounds (SVOC).

Passive sampling techniques rely on diffusion and adsorption and can be used to sample for VOCs and SVOCs, depending on the adsorbent selected and the diffusion membrane used. The developers of passive soil gas samplers claim that the passive samplers allow for equilibrium to develop between the soil gases and the sorbent over a period of several days to weeks. Further, the developers claim that exposure of the passive samplers to the soil gas over extended periods concentrates the mass of VOCs and SVOCs absorbed to the sampler; thereby enhancing contaminant detection sensitivity.

The GORE-SORBER[®] Screening Survey is a passive soil gas sampling technology developed by W.L. Gore & Associates, Inc. (Gore). The GORE-SORBER[®] module consists of several granular adsorbent materials housed in a chemically inert, hydrophobic, microporous GORE-TEX[®] expanded polytetrafluoroethylene (ePTFE) membrane. The microporous structure of ePTFE allows vapors to move freely across the membrane and onto the sorbent material while preventing water and soil particles from entering the sampler. GORE-SORBER[®] and GORE-TEX[®] are registered trademarks of Gore. GORE-SORBER[®] Screening Survey is a registered service mark of Gore.

The GORE-SORBER[®] Screening Survey was developed to address the limitations of reference methods (such as sensitivity to detection of SVOCs and performance under a broader range of geologic conditions) and to improve the design limitations of existing passive collection systems, including the quantity and type of adsorbents used, sorbent hydrophobicity, and collector installation depth. The GORE-SORBER[®] module was designed to sample contaminants in soil gas from open land, beneath artificial surfacing, and under water in various terrain, weather, and soil types.

The GORE-SORBER[®] module is designed to identify and quantify a broad spectrum of compounds. The developer provided the following list of target analytes that the GORE-SORBER[®] Screening Survey can potentially detect:

- C VOCs: vinyl chloride, methyl tert-butyl ether, 1,1-dichloroethane (1,1-DCA), chloroform, benzene, 1,2-dichloroethane, toluene, tetrachloroethene (PCE), ethylbenzene, o-xylene, trans-1,2-dichloroethene (trans-1,2-DCE), cis-1,2-dichloroethene (cis-1,2-DCE), 1,1,1-trichloroethane (1,1,1-TCA), carbon tetrachloride, trichloroethene (TCE), octane, chlorobenzene, m-,p-xylene, and ketones.
- C SVOCs: 1,3,5-trimethylbenzene, 1,2,4-trimethylbenzene, 1,4-dichlorobenzene, undecane, tridecane, pentadecane, naphthalene, 2-methylnaphthalene, acenaphthene, fluorene, phenanthrene, anthracene, fluoranthene, and pyrene.
- C Explosives: nitrobenzene, 2-nitrotoluene, 3-nitrotoluene, 4-nitrotoluene, 1,3-dinitrobenzene, 2,4-dinitrotoluene, 2,6-dinitrotoluene, 1,3,5-trinitrobenzene, 2,4,6-trinitrotoluene, 2-amino-4,6-dinitrotoluene, and 4-amino-2,6-dinitrotoluene.
- C Chemical Agents/Breakdown Products: mustard (as a tentatively identified compound), 1,4-dithiane, 1,4-oxathiane, benzothiazole, p-chlorophenylmethylsulfide, p-chlorophenylmethylsulfoxide, p-chlorophenylmethylsulfone, dimethyldisulfide, diisopropyl methylphosphonate, dimethyl methylphosphonate, 4-chloroacetophenone, and 2-chloroacetophenone.
- C Polychlorinated Biphenyls: (mono-, di-, tri-, and tetra-chlorobiphenyl detection capability has been demonstrated), and certain pesticides and herbicides.

Additional developer claims for the GORE-SORBER[®] Screening Survey include the following:

- C The data are proportionally comparable to active soil gas data
- C The samplers' detection limits for VOCs and SVOCs range from 0.01 to 0.1 micrograms (Fg)
- C The extended sampling time, 7 to 14 days, increases sensitivity and lowers detection limits
- C No specialized training is needed to use the GORE-SORBER[®] module
- C A single GORE-SORBER[®] module can be used to quantitate VOCs and SVOCs in vapor pressure range from vinyl chloride up to pyrene
- C The data provide positive identification of target compounds
- C Nontarget compounds can be tentatively identified through library search
- C The data are reproducible

However, during the demonstration, only Gore's claims regarding the ability of the GORE-SORBER[®] Screening Survey to be used to sample for VOCs, sample retrieval time, and cost were evaluated.

Components and Accessories

Each module for a particular screening survey contains equal amounts of a suitable granular adsorbent material. Specific polymeric and carbonaceous resins are selected by Gore for their affinity to a broad range of VOCs and SVOCs, and for their hydrophobic properties. The sorbers are sheathed in the bottom of a 4-foot-long, vapor-permeable insertion and retrieval cord. Both the retrieval cord and sorbent container are constructed solely of inert, hydrophobic, microporous GORE-TEX[®] ePTFE, similar to Teflon[™] brand polytetrafluoroethene. Figure 2-1 shows a typical GORE-SORBER[®] module.

The ePTFE protects the sorbent media from contact with groundwater and soil pore water without retarding soil vapor diffusion. This characteristic of the technology facilitates its application in low permeability and poorly drained soils.

General Operating Procedures

The following is a summary of the developer-recommended operating procedure to install and remove a GORE-SORBER[®] :

1. A slam bar or electric rotary hammer-drill should be used to make a 0.5-inch to 0.75-inch-diameter pilot hole to deploy the samplers. Although GORE-SORBER[®] modules may be installed to any depth, the samplers are typically installed at a depth of 2 to 3 feet below ground surface (bgs).
2. After the pilot hole is completed, the GORE-SORBER[®] module is removed from its reusable storage and shipping containers and is inserted into the completed pilot holes using the stainless-steel insertion rod supplied by the technology developer. The sorbers, which are at the end of the GORE-SORBER[®] module, are pushed to the bottom of the pilot hole. The top of each GORE-SORBER[®] module is fastened to a cork that is tamped flush with the ground surface to seal the annulus of the hole.
3. The GORE-SORBER[®] module is left in place for a predetermined time to allow for passive soil gas sampling (typically 1 to 2 weeks).
4. GORE-SORBER[®] module retrieval requires that field personnel locate the sampler, remove the cork, grasp the retrieval cord, and manually pull the module from each location. The cork is separated from the module and discarded. The GORE-SORBER[®] module is resealed in shipping vials provided by the developer and placed in the shipping cooler. The GORE-SORBER[®] module is returned by overnight carrier to the technology developer for laboratory analysis. During the demonstration, the GORE-SORBER[®] modules were immediately placed on ice in the shipping cooler after collection. However, Gore claims that placing modules on ice after collection is not a requirement.

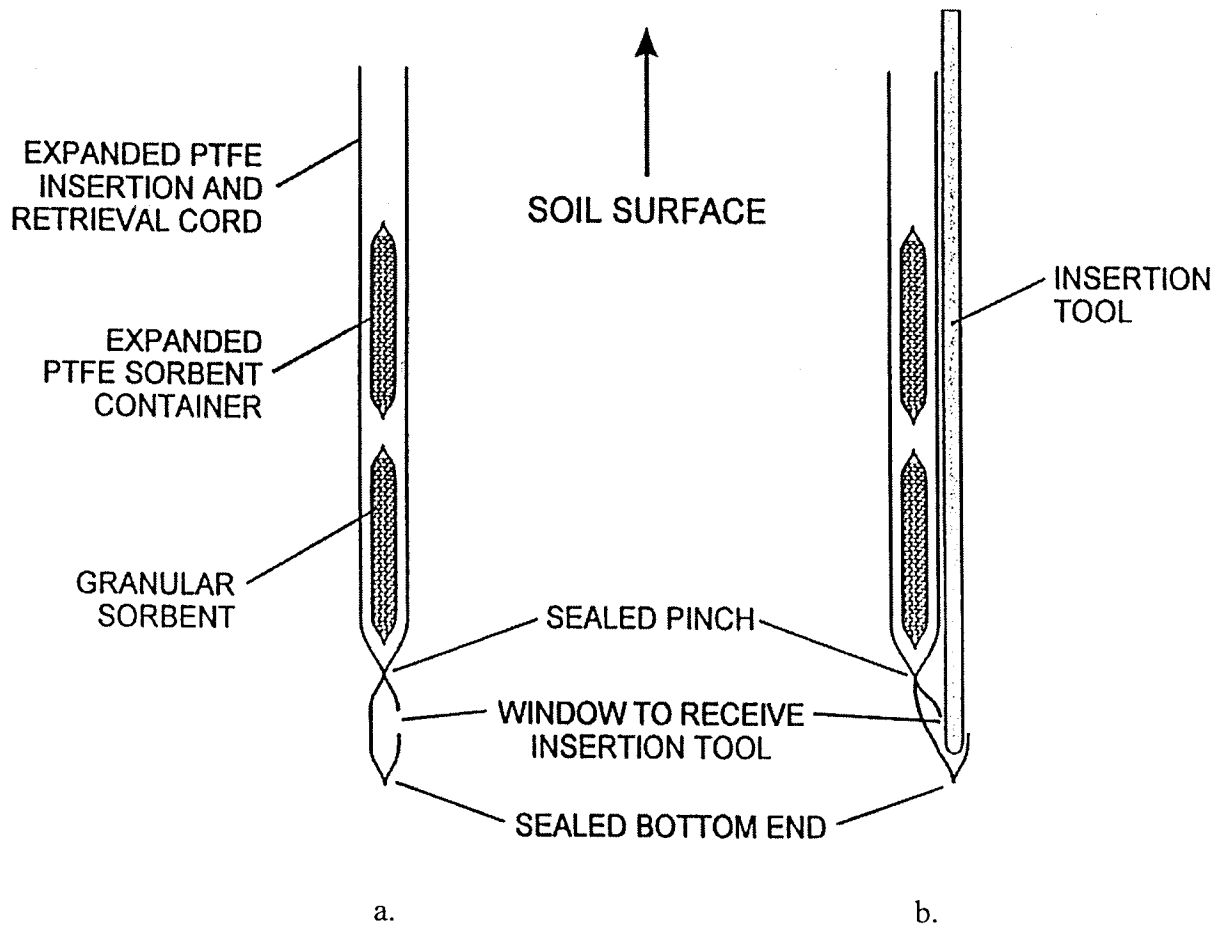

- a. GORE-SORBER®
- b. GORE-SORBER® with attached insertion tool

Figure 2-1. GORE-SORBER® Module Schematic (W.L. Gore & Associates, 1997)

Developer Contact

For more developer information on the GORE-SORBER[®] Screening Survey, please refer to Chapters 8 and 9 of this ETVR or contact the developer at:

Ray Fenstermacher
W.L. Gore & Associates, Inc.
100 Chesapeake Boulevard
Elkton, Maryland 21921
Telephone: (410) 392-7600
Facsimile: (410) 506-4780
E-mail: rfenster@wlgore.com

Chapter 3

Site Descriptions and Demonstration Design

This chapter describes the demonstration sites, predemonstration sampling and analysis, and the demonstration design. The demonstration was conducted in accordance with the “Final Demonstration Plan for the Evaluation of Soil Sampling and Soil Gas Sampling Technologies” (PRC, 1997).

Site Selection and Description

The following criteria were used to select the demonstration sites:

- C Unimpeded access for the demonstration
- C A range (micrograms per kilogram [Fg/kg] to milligrams per kilogram [mg/kg]) of chlorinated or aromatic VOC contamination in soil
- C Well-characterized contamination
- C Different soil textures
- C Minimal underground utilities
- C Situated in different climates

Based on a review of 48 candidate sites, the Small Business Administration (SBA) site in Albert City, Iowa, and the Chemical Sales Company (CSC) site in Denver, Colorado, were selected for the demonstration of the GORE-SORBER[®] Screening Survey.

SBA Site Description

The SBA site is located on Orchard Street between 1st and 2nd Avenues in east-central Albert City, Iowa (Figure 3-1). The site is the location of the former Superior Manufacturing Company (SMC) facility and is now owned by the SBA and B&B Chlorination, Inc. SMC manufactured grease guns at the site from 1935 until 1967. Metal working, assembling, polishing, degreasing, painting, and other operations were carried out at the site during this period. The EPA files indicate that various solvents were used in manufacturing grease guns and that waste metal shavings coated with oil and solvents were placed in the former waste storage area. The oil and solvents were allowed to drain onto the ground, and the metal waste was hauled off site by truck (Ecology & Environment [E&E], 1996).

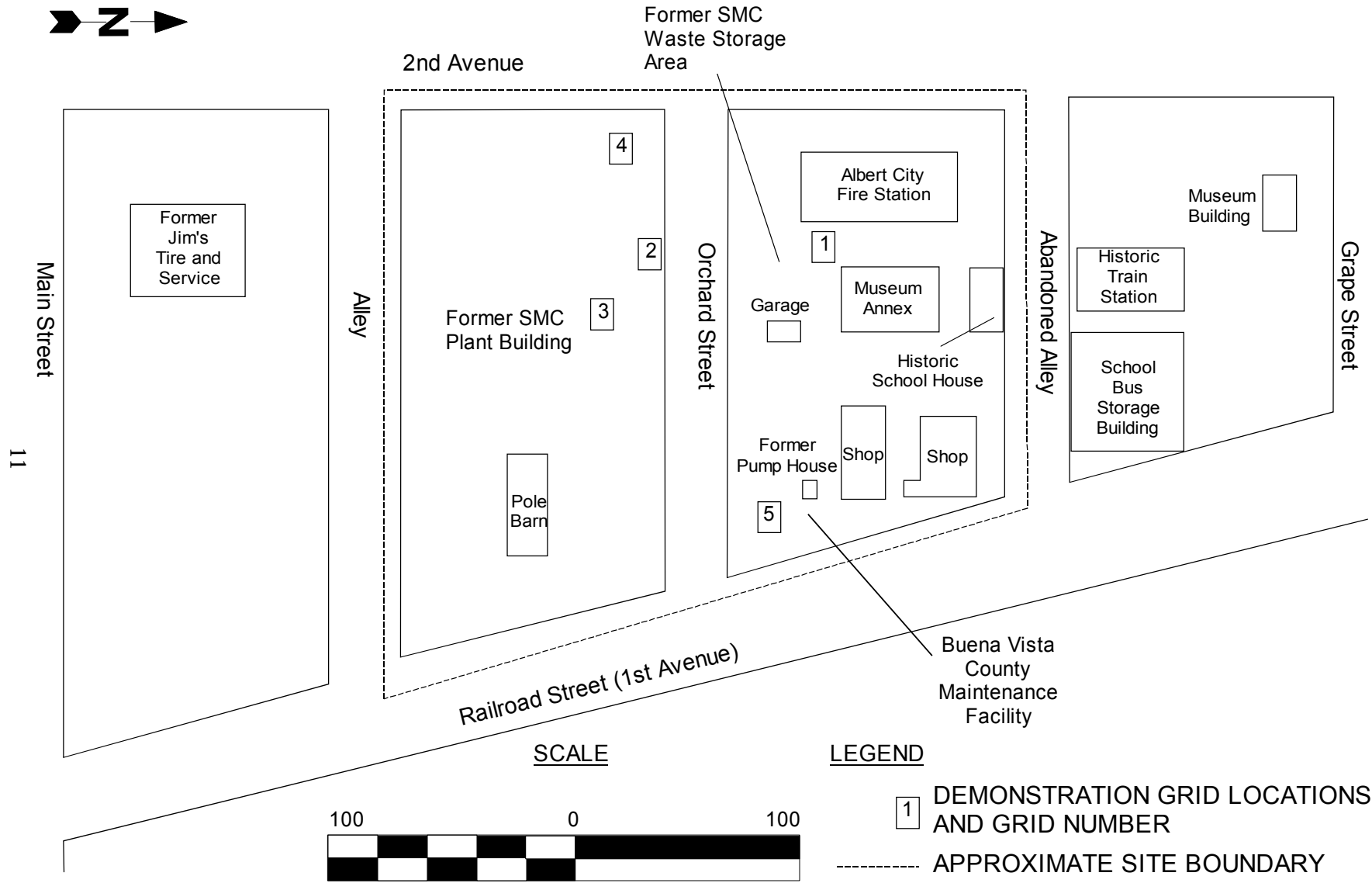

Figure 3-1. Small Business Administration Site

The site consists of the former SMC plant property and waste storage yard. The SMC plant property is currently a grass-covered, relatively flat, unfenced open lot. The plant buildings have been razed. A pole barn is the only building currently on the plant property. Several buildings are present on the waste storage yard, including three historic buildings: a garage, a museum, and a school house.

Poorly drained, loamy soils of the Nicollet series are present throughout the site area. The upper layer of these soils is a black loam grading to a dark-gray loam. Below this layer, the soils grade to a friable, light clay loam extending to a depth of 60 inches. Underlying these soils is a thick sequence (400 feet or more) of glacial drift. The lithology of this glacial drift is generally a light yellowish-gray, sandy clay with some gravel, pebbles, or boulders. The sand-to-clay ratio is probably variable throughout the drift. Groundwater is encountered at about 6 to 7 feet bgs at the SBA site (E&E, 1996).

Tetrachloroethene, TCE, cis-1,2-DCE, and vinyl chloride are the primary contaminants detected in soil at the site. These chlorinated VOCs have been detected in both surface (0 to 2 feet deep) and subsurface (3 to 5 feet deep) soil samples. TCE and cis-1,2-DCE are the VOCs usually detected at the highest concentrations in both soil and groundwater. In past site investigations, TCE and cis-1,2-DCE have been detected in soils at 17 and 40 mg/kg, respectively, with vinyl chloride present at 1.4 mg/kg. The areas of highest contamination have been found near the center of the former SMC plant property and near the south end of the former SMC waste storage area (E&E, 1996).

CSC Site Description

The CSC site is located in Denver, Colorado, approximately 5 miles northeast of downtown Denver. From 1962 to 1976, a warehouse at the site was used to store chemicals. The CSC purchased and first occupied the facility in 1976. The CSC installed aboveground and underground storage tanks and pipelines at the site between October 1976 and February 1977. From 1976 to 1992, the facility received, blended, stored, and distributed various chemicals and acids. Chemicals were transported in bulk to the CSC facility by train and were unloaded along railroad spurs located north and south of the CSC facility. These operations ceased at the CSC site in 1992.

The EPA conducted several investigations of the site from 1981 through 1991. Results of these investigations indicated a release of organic chemicals into the soil and groundwater at the site. As a result of this finding, the CSC site was placed on the National Priorities List in 1990. The site is divided into three operable units (OU). This demonstration was conducted at OU1, which is located at 4661 Monaco Parkway in Denver (Figure 3-2). In September 1989, EPA and CSC entered into an Administrative Order of Consent requiring CSC to conduct a remedial investigation/feasibility study (RI/FS) for CSC OU1. The RI/FS was completed at OU1 in 1991 (Engineering-Science, Inc., 1991).

The current site features of OU1 consist of the warehouse, a concrete containment pad with a few remaining tanks from the aboveground tank farm, another smaller containment pad with aboveground tanks north of a railroad spur, and multiple areas in which drums are stored on the west side of the warehouse and in the northwest corner of the property. The warehouse is currently in use and is occupied by Steel Works Corporation.

The topography, distribution of surficial deposits, and materials encountered during predemonstration sampling suggest that the portion of OU1 near the CSC warehouse is a terrace deposit composed of Slocum Alluvium beneath aeolian sand, silt, and clay. The terrace was likely formed by renewed downcutting of a tributary to Sand Creek. Borings at the CSC property indicate that soils in the vadose

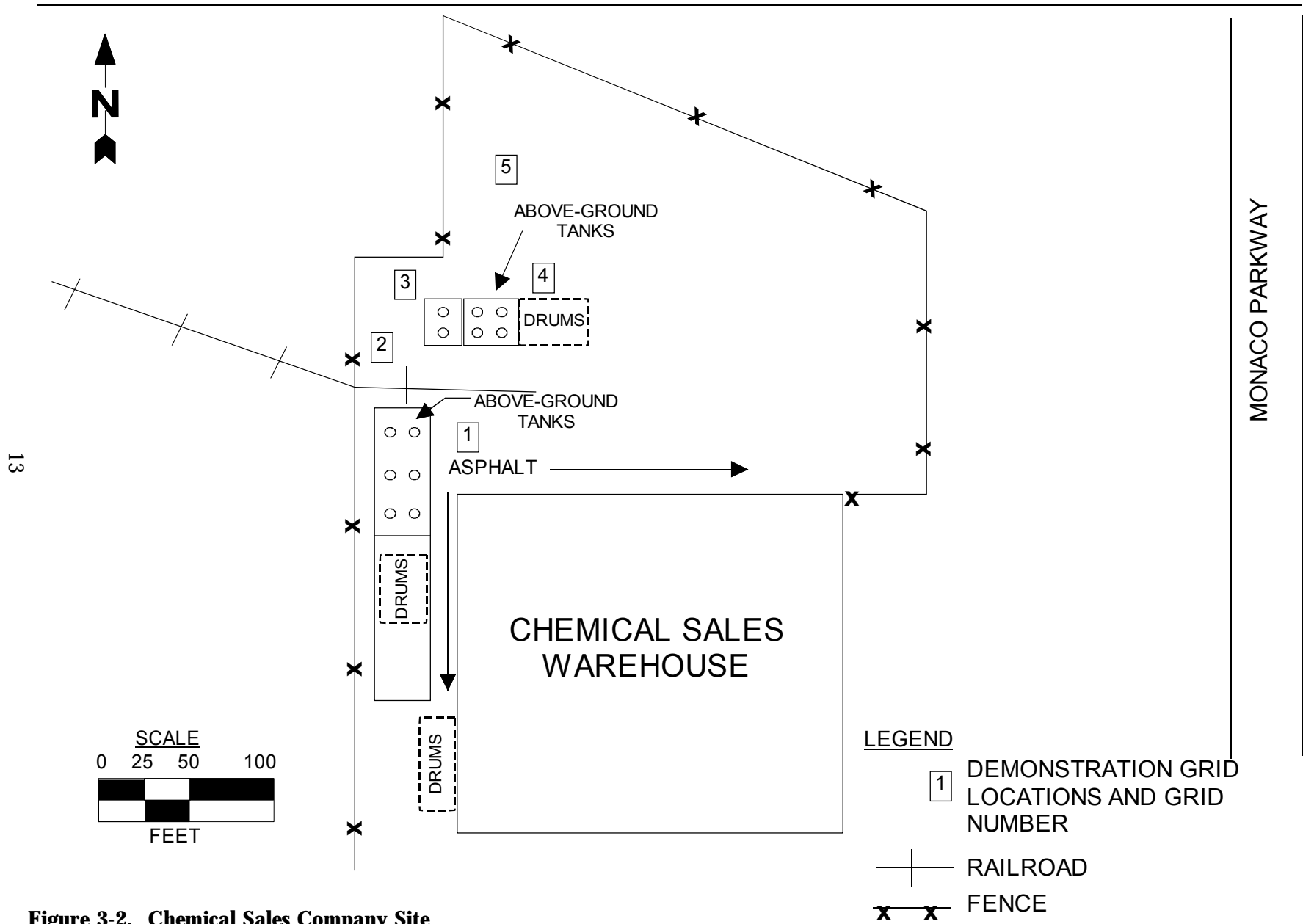

13

Figure 3-2. Chemical Sales Company Site

- LEGEND**
- 1 DEMONSTRATION GRID LOCATIONS AND GRID NUMBER
 - +— RAILROAD
 - x—x— FENCE

zone and saturated zone are primarily fine- to coarse-grained, poorly sorted sands with some silts and clays. The alluvial aquifer also contains some poorly sorted gravel zones. The depth to water is about 30 to 40 feet bgs near the CSC warehouse.

Previous soil investigations at the CSC property detected chlorinated VOC contamination extending from near the surface (less than 5 feet bgs) to the water table depth. The predominant chlorinated VOCs detected in site soils were PCE, TCE, 1,1,1-TCA, and 1,1-DCA. The area of highest VOC contamination is north of the CSC tank farm, near the northern railroad spur. The PCE concentrations detected in this area measure as high as 80 mg/kg, with TCE and 1,1,1-TCA concentrations measuring as high as 1 mg/kg.

Predemonstration Sampling and Analysis

Predemonstration sampling and analysis were conducted to establish the geographic location of sampling grids, identify target sampling depths, and estimate the variability of contaminant concentrations exhibited at each grid location and target sampling depth. Predemonstration sampling was conducted at the SBA site between April 1 and 11, 1997, and at the CSC site between April 20 and 25, 1997. Eleven sampling grids, six at the SBA site and five at the CSC site, were investigated to confirm that each grid exhibited chemical concentrations and soil texture characteristics that met the criteria set forth in the predemonstration sampling plan (PRC, 1997) and to confirm that passive and active soil gas sampling could be used at the two sites.

At each of the grids sampled during the predemonstration, five borings were advanced and samples were collected for VOC and soil texture analysis. As expected, the primary VOCs detected in soil samples at the SBA site were vinyl chloride, cis-1,2-DCE, TCE, and PCE. The primary VOCs detected at the CSC site were 1,1,1-TCA, TCE, and PCE. TCE and cis-1,2-DCE were detected at the highest concentrations. Soil texture within each grid was relatively homogeneous at the target GORE-SORBER[®] sampling depth of 3 feet.

An active soil gas sampling method sample was collected from an area adjacent to each of the soil sampling grids at each site. Analysis of samples from these locations confirmed that (1) the active soil gas sampling method could be used at the two sites, and (2) soil gas contamination was detectable by the reference method. Of the 11 grids investigated during predemonstration sampling, nine were selected for demonstration sampling, five grids at the SBA site and four grids at the CSC site.

Demonstration Design

The demonstration was designed to evaluate the GORE-SORBER[®] Screening Survey passive soil gas sampling system in comparison to the reference sampling method, active soil gas sampling, in terms of the following parameters: (1) VOC detection and quantitation, (2) sample retrieval time, and (3) cost. These parameters were assessed in two different soil textures (clay soil at the SBA site and sandy soil at the CSC site). The demonstration design is described in detail in the demonstration plan (PRC, 1997) and is summarized below.

Predemonstration sampling identified nine grids (Grids 1, 2, 4, 5, and 6 at the SBA site and Grids 1, 2, 4, and 5 at the CSC site) that exhibited consistent soil texture and acceptable VOC concentrations. Each grid was 10.5 by 10.5 feet in area and was divided into seven rows and seven columns, producing 49, 18- by 18-inch sampling cells (Figure 3-3). Each grid was sampled at a depth of approximately 3

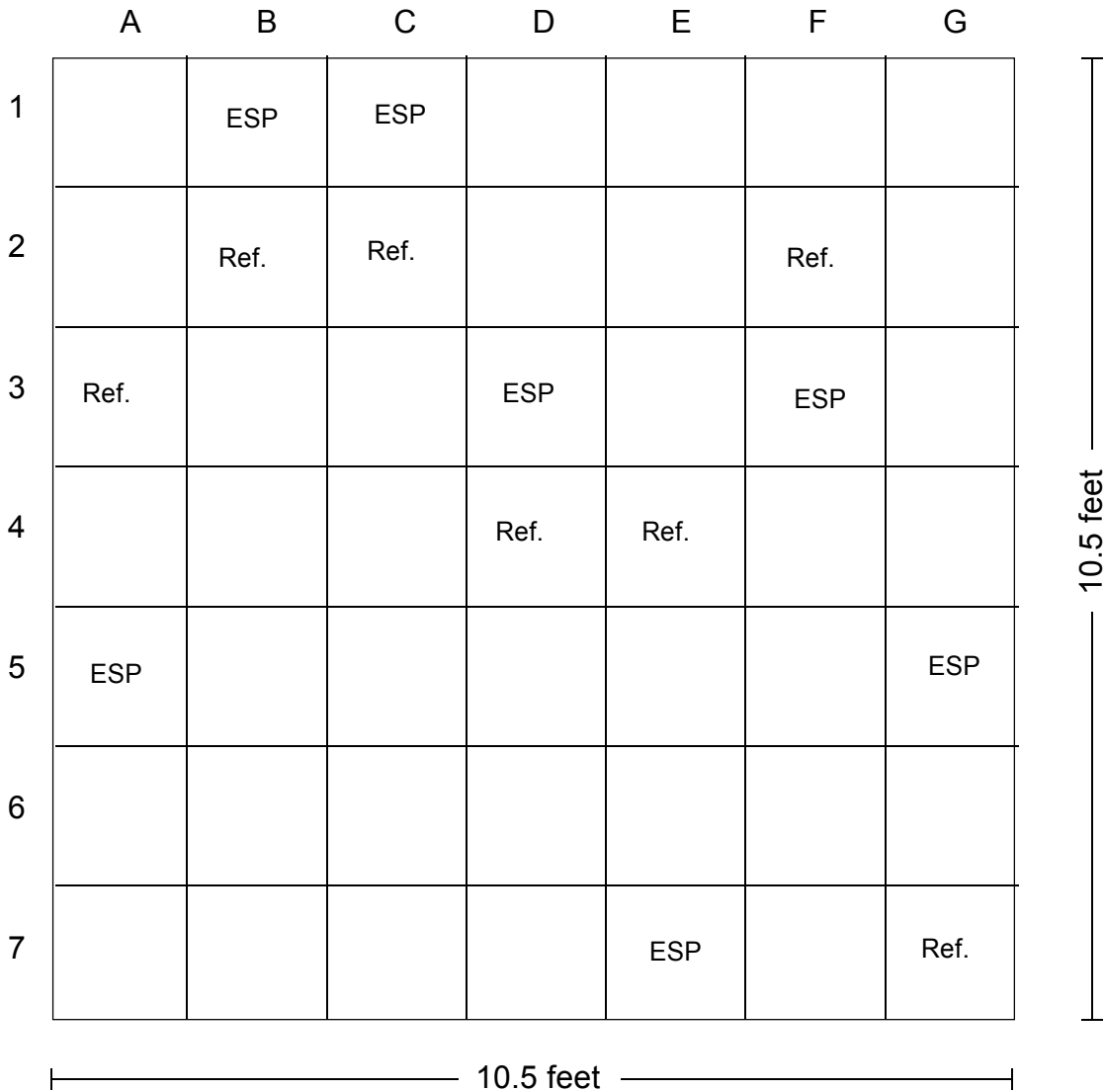

ESP JMC Environmentalist's Subsoil Probe Sampling Location

Ref. Reference Sampling Method Location

Figure 3-3. Typical Sampling Locations and Random Sampling Grid

feet in each of the seven columns (labeled A through G) using the reference soil gas sampling method; the GORE-SORBER[®] modules were emplaced at a depth of about 3 to 4 inches for passive sampling. For each grid, seven soil gas samples were collected using the GORE-SORBER[®] modules and reference soil gas sampling method. The seven cells that were sampled using each method were selected randomly. The procedure used to collect samples using the GORE-SORBER[®] modules is described in Chapter 2 and the procedure used to collect samples using the reference soil gas sampling method is described in Chapter 4.

VOC Detection and Quantitation

After collection of the GORE-SORBER[®] modules, the modules were shipped to the developer for analysis using a gas chromatography mass spectrometer (GC/MS) according to the developer's standard operating procedures (Gore, 1996). The reference active soil gas samples were analyzed in an on-site laboratory following the guidelines discussed in the quality assurance project plan (PRC, 1997). The guidelines used for on-site analysis were similar to SW-846 Method 5021 (Volatile Organic Compounds in Soils and Other Solid Matrices Using Equilibrium Headspace Analysis), modified to include high- and low-concentration procedures similar to those described in SW-846 Method 5035 (Closed-System Purge-and-Trap and Extraction for Volatile Organics in Soil and Waste Samples) (EPA, 1986). The target compounds were vinyl chloride, 1,2-DCE, TCE, and PCE at the SBA site, and 1,2-DCE, 1,1-DCA, 1,1,1-TCA, TCE, and PCE at the CSC site. Soil gas samples collected from the CSC site were not analyzed for vinyl chloride because it was not detected in soil during site characterization.

The reference soil gas samples were collected in 40-milliliter (ml) glass volatile organic analysis vials. The standard injection volume used for soil gas analysis was 2 ml. A gas-tight glass syringe was used to directly inject the soil gas samples onto the GC column. An electrolytic conductivity detector was used for compound identification and quantitation. The GC was a Hewlett-Packard Series II equipped with a packed injection port and a DB-624 column.

Because the GORE-SORBER[®] Screening Survey data were reported as a total mass of analyte absorbed onto the sample cartridge and the reference soil gas sampling method data were reported as a mass of analyte detected per liter of air, the data could not be statistically compared directly. Therefore, graphical methods were used to examine the relationship between the values reported by the two methods. Mean concentrations from the reference method were plotted on the x axis, and mean analyte mass values reported by the GORE-SORBER[®] Screening Survey were plotted on the y axis. The resulting curves were fitted to a trendline that depicts the relationship between the amount of a compound sorbed and the amount of a compound present in the gas phase. To assess how well the data set fit the trendline, a correlation coefficient was calculated for each plot.

Sample Retrieval Time

Sample retrieval time was measured as the time required to set up on a sampling grid, install and collect the seven GORE-SORBER[®] modules from each grid, decontaminate the sampler installation and collection equipment, and move to a new sampling grid. The time required to install the samplers was added to the time required to collect the samplers to obtain the sample retrieval time.

Cost

The cost estimate focused on the range of costs for using the GORE-SORBER[®] Screening Survey passive soil gas sampling system and reference soil gas sampler to collect 40 subsurface soil gas samples at a clay soil site (similar to the SBA site) and a sandy soil site (similar to the CSC site). The cost analysis is based on the results and experience gained from the demonstration and cost information provided by Gore. Factors that could affect the cost of operating the GORE-SORBER[®] Screening Survey passive soil gas sampling system and the reference soil gas sampler include:

- C Equipment costs
- C Labor costs
- C Sample analysis and reporting costs
- C Decontamination costs
- C Site restoration costs

Deviations from the Demonstration Plan

Three project-wide deviations from the approved demonstration plan were identified: (1) vinyl chloride was eliminated from the target compound list at the CSC site because vinyl chloride was not detected in the soil gas at the site; (2) a statistical comparison of the GORE-SORBER[®] Screening Survey data to the reference data was not performed because the two methods use different sampling techniques and the data are not directly comparable; and (3) active soil gas sample results were not available from Grid 6 at the SBA site because of laboratory error. Cases where the performance of an individual sampling technology caused it to deviate from the demonstration plan are discussed on a technology-specific basis in Chapters 4 (reference method) and 5 (GORE-SORBER[®] Screening Survey) of this ETVR.

Chapter 4

Description and Performance of the Reference Method

This chapter describes the active soil gas sampling system used during the demonstration as the reference soil gas sampling method, and includes its associated background information, components and accessories, platform description, demonstration operating procedures, qualitative performance factors, quantitative performance factors, and data quality measures.

Background

Soil gas screening technology was used as early as 1929 as a surface geochemical technique in oil and gas exploration. In the early 1980s, active soil gas sampling became widely used as an environmental investigative tool for aiding in the delineation of subsurface organic contamination. The intent of active soil gas sampling is to reduce site characterization costs by identifying areas with suspected contamination, thereby minimizing the number of soil borings and monitoring wells required to delineate the extent of contamination.

Active soil gas sampling produces a discrete sample that provides a “snapshot” of the soil gas environment at the time the sample is collected. The sampling technique used in this demonstration requires the presence of vapor-phase compounds at detectable concentrations, relatively porous subsurface soil, experienced analytical instrument operators at the site, and portable analytical equipment for on-site analysis of samples.

Components and Accessories

Two active soil gas sampling systems were used during this demonstration: an AMS™ soil gas sampling system at the SBA site, and a Geoprobe® soil gas sampling system at the CSC site. The systems are similar, and this description of system components and accessories applies to both technologies. The components of the reference sampling method consist of an expendable drive point, a drive-point holder, drive rods, expendable plastic tubing, a tubing connector, and a vacuum pump. The 2-inch-long, expendable drive point is a solid steel or aluminum component that has a cone-shaped drive end and a cylindrical shank on the other end that fits into the point holder. The drive-point holder is a hollow tube 4 inches long by 1-inch outside diameter. One end of the point holder holds the expendable point; the other has female threads for attaching the tubing connector. The 2-inch-long, hollow metal tubing connector has a nipple for the plastic tubing on one end and male threads with a rubber gasket on the other end, which attaches to the drive-point holder. The 36- to 48-inch-long by 1-inch outside-diameter drive rod is a hollow metal tube with male threads on one end and female threads on the other. The vacuum pump is capable of drawing a vacuum of 20 to 30 inches of mercury, is constructed of metal, and has pressure gauges on the sampling line and vacuum tank.

Other components of the reference soil gas sampling system include a drive cap, pull cap, ancillary tools, and expendable sampling supplies. The drive and pull caps are metal and have female threads on one end for attaching to the top drive rod. Ancillary tools required include drill bits, vise grips, pipe wrenches, crescent wrenches, knives, hemostats, and screwdrivers. Expendable sampling supplies required include the plastic tubing (tygon, Teflon™, or polyethylene), silicone tubing, 40-ml volatile organic analysis vials, syringe with needle, double-ended needles, and a container for waste.

Because the soil gas samples are usually analyzed immediately, an on-site or nearby laboratory is typically required. During this demonstration, a GC in an on-site, mobile laboratory was used to analyze the soil gas samples collected using the reference sampling method.

Description of Platform

The AMS™ and Geoprobe® active soil gas sampling systems use similar platforms to place the samplers. The platform consists of a hydraulically powered hammer mounted in the bed of a three-quarter-ton pickup truck. Additional equipment required includes an oil reservoir, a pump, a hammer support structure, hydraulic control levers, and three hydraulic cylinders: one to fold the hammer for transport, one to adjust the hammer height, and one to adjust the foot height.

The mobility and performance of the platform were adequate for the conditions at both demonstration sites. The size of the truck and the ability of the hammer to pivot in multiple directions allowed for smooth transition from one sampling location to another. The platform easily pushed or hammered the soil gas samplers to the 4-foot sampling depth at each demonstration site, and the platform easily extracted the soil gas samplers. The clay soil at the SBA site required less hammering to place the soil gas samplers than did the sandy soil at the CSC site.

Demonstration Operating Procedures

The reference soil gas sampling method involved assembling and installing the sampling system and collecting the soil gas sample. Initially, a 1-inch outside-diameter hollow rod was driven to the target sampling depth within the selected grid cell. The rod was fitted with an expendable drive point. Once the rod reached the target depth of 4 feet bgs, it was withdrawn approximately 6 inches. The expendable drive point remained in place, producing a 6-inch void space that allowed a soil gas sample to be collected. Once the rod was retracted 6 inches, a 0.25-inch inside-diameter, high-density polyethylene or Teflon™ tube was lowered into the drive rod. The end of the tubing was fitted with a reverse threaded, barbed fitting. The barb was inserted into the tubing and the reverse threaded end was screwed into the expendable drive point holder at the end of the drive rod when the tubing reached the end of the drive rod. A butyl rubber O-ring around the threaded end of the barb fitting ensured an airtight seal between the tubing and the end of the drive rod.

Once the tubing was in place, the soil gas sample was collected by attaching an evacuated 40-ml sampling vial with a double-ended needle to the top end of the system tubing as follows.

1. The sampling vial was evacuated using a 60-cubic-centimeter (cc) plastic syringe. The syringe pulled a vacuum on the closed sampling vial for 10 seconds. This vacuum was applied by attempting to draw 60 cc of air out of the vial.

-
2. A volume-calibrated vacuum system was attached to the end of the polyethylene tube connected to the end of the hollow rod. The vacuum system removed a volume of air equal to one tubing volume that was calculated to be 16.4 cc in this demonstration.
 3. The vacuum system was shut off and the sampling string was allowed to equilibrate with ambient air pressure. The system was closed so that equilibration occurred only by drawing soil gas into the sample tubing. (A vacuum line integrity test was successfully completed before each sampling event to ensure that there were no leaks in the soil gas system.)
 4. When no vacuum was left in the tubing, a double-end hypodermic needle was inserted into the tygon tubing that connected the polyethylene tubing with the vacuum pump. The exposed end of the needle was sealed with a soft rubber sheath. The evacuated sampling vial was pushed onto the exposed needle. The needle penetrated the vial's septum and exposed the soil gas in the tubing to the vacuum in the vial, causing the vial to fill with soil gas. The sampling vial was allowed to collect a sample for 40 seconds at the CSC site and 2 minutes at the SBA site. These times were selected after several tests on refilling evacuated vials were conducted by observing (1) septa "spring back" to their original positions, and (2) lack of an air hiss upon opening the vial.

Each sampling vial containing a soil gas sample was numbered according to the sample grid and cell where it was collected. After the samples were properly labeled, they were analyzed within 24 hours of collection. Prior to analysis, the active soil gas samples were stored at ambient temperatures.

All reusable soil gas sampling equipment was decontaminated by heating with a portable propane heater for approximately 30 seconds. The sampling vials and needles were not reused, and the sample tubing was discarded after a single use.

Qualitative Performance Factors

The following qualitative performance factors were assessed for the reference soil gas sampling method: (1) reliability and ruggedness under the test conditions, (2) training requirements and ease of operation, (3) logistical requirements, (4) sample handling, and (5) performance range.

Reliability and Ruggedness

The reliability and ruggedness of the reference active soil gas sampling method was adequate for conditions at both demonstration sites. The sampler was pushed or hammered to the 4.5-foot sampling depth at each site without incident. During the demonstration, operators noted that attaching the tubing adapter to the point holder was easier when the tubing was precut to the required length (per the sampling depth); otherwise, the tubing tended to unwind when released, which would either loosen or unscrew the tubing adapter from the point holder. The clay soil at the SBA site caused the system to hold its vacuum at several sampling locations; hence, soil gas was not completely drawn into the system for sampling. In these cases, the rod was withdrawn in additional 6-inch increments until the vacuum was broken and the system's pressure reached equilibrium with atmospheric pressure. The vacuum problem was not encountered in the sandy soil at the CSC site. The reference soil gas sampling method operated without any equipment failure or mechanical breakdown during the demonstration.

Training Requirements and Ease of Operation

The active soil gas sampling technology requires minimal training due to the ease of operating the system. Special certifications, advanced degrees, or other specialized training are not required to operate the sampling platform and use the system. However, health and safety training is required by the Occupational Safety and Health Administration when operating at hazardous waste sites. A novice would require 3 to 6 hours of hands-on training to become proficient at using the sampling platform and the soil gas sampling system. A two-person crew is recommended for sampling and operation of the system and platform, but one person may safely operate the system.

Logistical Requirements

Logistical requirements for the reference active soil gas sampling method include obtaining utility clearances and grouting the sampling holes. Permits to operate the system were not required by the states of Iowa and Colorado, but may be required in other states. The system, platform, and ancillary equipment are mounted on or contained in the platform vehicle.

The physical disruption caused by the sampling platform was minimal during the demonstration. No soil cuttings were generated and a 1-inch diameter hole was left at each sampling location after the reference soil gas sampling system was extracted. These holes were grouted with bentonite after samples were collected.

Sample Handling

The reference soil gas samples were easily collected and handled. When no vacuum was left in the sampling tubing, one end of a double-end hypodermic needle was inserted into the polyethylene tubing and the other end was inserted through the septum of the evacuated sampling vial. Soil gas in the tubing was drawn into the sampling vial until the pressure reached equilibrium. This took about 40 to 120 seconds. The sampling vial containing the soil gas sample was numbered according to the sample grid and cell where it was collected. The soil gas samples were properly labeled and were then stored at ambient temperature until analysis. The samples were analyzed within 24 hours of collection.

Performance Range

The performance range of the reference soil gas sampling method is limited by soil texture, permeability, soil moisture content, contaminant type, and depth to groundwater. During the demonstration, reference soil gas samples were collected from a depth of 4 feet; however, the system is capable of collecting samples at depths of 30 to 60 feet. Soil such as glacial till with cobbles or fill with pieces of concrete can cause refusal of the reference sampling method before it reaches the desired depth. Clay soil may also impede sample collection because the vacuum is not readily released. The reference soil gas sampling method must be conducted above the water table to avoid drawing water into the sampling tube.

Quantitative Performance Factors

Three quantitative performance indicators were measured for the reference soil gas sampling method: (1) VOC detection and quantitation, (2) sample retrieval time, and (3) cost. The following sections

discuss the first two performance factors; a cost analysis of the reference soil gas sampling method is provided in Chapter 6.

VOC Detection and Quantitation

Seven samples were collected using the reference soil gas sampling method within each grid as described in Chapter 3 and specified in the demonstration plan (PRC, 1997). Samples were analyzed for VOCs by GC analysis according to the standard operating guideline provided in the demonstration plan (PRC, 1997). Table 4-1 presents the range and mean VOC concentrations for samples collected using the reference method. The VOC results for each sample collected are presented in Appendix A. For Grid 6 at the SBA site, VOC data for the reference method were not available because of laboratory error. For one of the sampling grids, VOC data for all seven samples are not available due to laboratory error; in this case, the range and mean were calculated from the available data. Chapter 5 presents a graphical comparison of the analytical results obtained using the reference soil gas sampling method to those obtained using the GORE-SORBER[®] Screening Survey.

Sample Retrieval Time

The reference soil gas method required 458 minutes to collect 35 samples at the SBA site, an average of 13.1 minutes per sample, and 183 minutes to collect 28 samples at the CSC site, an average of 6.5 minutes per sample. Sample retrieval time was measured as the amount of time per sample required to set up at a sampling grid, collect the required samples, grout the hole, decontaminate the sampling equipment, and move to a new sampling location. Analytical results were available from the on-site laboratory within one day; this time was not included in calculating the sample retrieval time. A three-person sampling and analysis crew collected and analyzed soil gas samples using the reference soil gas sampling method at both sites. The difference in sample retrieval time between the SBA and CSC sites may be due in part to differences in soil type (clay versus sandy soil).

Data Quality

Data quality was assessed throughout this demonstration by implementing an approved quality assurance project plan (PRC, 1997). The QA/QC procedures included the consistent application of approved methods for sample collection, chemical analysis, and data reduction. Based on the intended use of the data, QA objectives for precision, accuracy, representativeness, comparability, and completeness were established, and QC samples were collected to assess whether the QA objectives were met. Based on the results of a field audit conducted by the EPA and a detailed validation of the demonstration data by Tetra Tech, the data have been deemed acceptable for use as described in the demonstration design (Chapter 3). The results of the QC indicators used for the reference soil gas sampling method are provided in the technology evaluation report for this demonstration (Tetra Tech, 1997) and are summarized below.

All reference soil gas samples were analyzed within 24 hours of collection, as specified in the quality assurance project plan. Some initial calibrations of the Hewlett-Packard Series II GC had to be abbreviated to meet acceptance criteria, and either a five-point or a three-point calibration was utilized instead of the specified six-point calibration. However, all continuing calibrations met the acceptance criteria for percent difference, indicating that the calibration was reproducible. Two method blanks were analyzed at the SBA site and one at the CSC site. In addition, one ambient air blank and one

Table 4-1. Volatile Organic Compound Concentrations in Samples Collected Using the Reference Soil Gas Sampling Method

Concentration (ng/L)													
Site	Grid	Vinyl Chloride		Total DCE		1,1-DCA		1,1,1-TCA		TCE		PCE	
		Range	Mean	Range	Mean	Range	Mean	Range	Mean	Range	Mean	Range	Mean
SBA	1	230,000 - 5,180,000	2,390,000	279,000 - 2,220,000	958,000	< 50	< 50	< 50	< 50	< 50	< 50	< 50	< 50
SBA	2	< 100	< 100	< 50 - 151	65	< 50	< 50	< 50	< 50	183 - 5,380	1,250	< 50	< 50
SBA	4	< 100	< 100	< 50 - 261	101	< 50	< 50	< 50	< 50	744 - 33,600	9,390	< 50	< 50
SBA	5	< 100 - 8,270	1,980	3,180 - 21,000	9,980	< 50	< 50	< 50	< 50	132 - 6,250	2,010	< 50	< 50
SBA	6 *	NA	NA	NA	NA	NA	NA	NA	NA	NA	NA	NA	NA
CSC	1	NA	NA	2,260 - 21,300	10,800	< 500	< 500	7,530 - 670,000	314,000	7,450 - 77,400	41,800	79,000 - 770,000	330,000
CSC	2	NA	NA	< 500 - 3,780	1,850	< 500	< 500	33,900 - 439,000	288,000	11,400 - 154,000	89,500	32,000 - 427,000	223,000
CSC	4	NA	NA	< 500 - 10,500	6,190	< 500	< 500	19,600 - 217,000	142,000	1,880 - 41,800	22,200	20,800 - 389,000	192,000
CSC	5 †	NA	NA	< 500 - 1,400	738	< 500	< 500	12,600 - 132,000	69,900	2,430 - 24,700	11,500	24,800 - 220,000	98,500

ng/L Nanograms per liter
 Total DCE Total Dichloroethene
 1,1,1-TCA 1,1,1-Trichloroethane
 CSC Chemical Sales Company site
 † VOC data for only five samples are available
 * VOC data are not available because of laboratory error
 1,1-DCA 1,1-Dichloroethane
 PCE Tetrachloroethene
 TCE Trichloroethene
 SBA Small Business Administration site
 NA Not analyzed

equipment blank were analyzed at each site. None of these blanks exhibited any target compounds above the quantitation limit, indicating that there were no apparent sample contamination problems at either site.

Tetra Tech performed a data validation review of all data, and an EPA Region 8 QC chemist performed an audit of the laboratory during the predemonstration phase. Neither of these reviews noted any significant data quality issues. Thus, the data appear to be of sufficient quality for the intended use.

Chapter 5

Technology Performance

This chapter describes the performance of the GORE-SORBER[®] Screening Survey passive soil gas sampling system in terms of qualitative and quantitative performance factors. A description of the GORE-SORBER[®] Screening Survey is provided in Chapter 2.

Qualitative Performance Factors

The following qualitative performance factors were assessed for the GORE-SORBER[®] Screening Survey: (1) reliability and ruggedness under the test conditions, (2) training requirements and ease of operation, (3) logistical requirements, (4) sample handling, and (5) performance range.

Reliability and Ruggedness

The GORE-SORBER[®] Screening Survey collected 100 percent (63 of 63) of the samples without sample loss or downtime, which verifies the developer claim that the samplers can collect soil gas samples in clay and poorly drained soils. The GORE-SORBER[®] modules are protected during shipping by placing them in 2-ounce jars inside foam packaging. This procedure minimizes any possible damage to the sorbers during shipping.

Training Requirements and Ease of Operation

The GORE-SORBER[®] modules were installed by the developer, but the developer claims that no specialized training is required. When deemed desirable or necessary by a client, the developer furnishes a 10-minute training video.

Logistical Requirements

No special license requirements are necessary to use the GORE-SORBER[®] Screening Survey. The system requires two mobilizations: one trip is required to install the samplers, and a second trip is needed to collect the samplers. Once the samples are collected, they must be returned to the developer for analysis.

Installation of the GORE-SORBER[®] module requires drilling a 0.5-inch to 0.75-inch hole between 2 and 3 feet deep. Shallow underground utilities such as cable, telephone, and electrical lines should be located and utility clearances should be obtained before the holes are drilled. Installation of samples through paved surfaces requires the use of a roto-hammer or drill, and holes in the pavement are usually patched after sampling. The roto-hammer requires an electrical power source.

For this demonstration push platforms mounted on pickup trucks were used to create the pilot holes for the GORE-SORBER® modules. The physical impact of demonstration sampling on the site was minimal. The GORE-SORBER® modules left 0.75-inch-diameter holes in the ground surface, which were grouted with bentonite after the samplers were collected.

Sample Handling

GORE-SORBER® module retrieval requires that field personnel locate the sampler, remove the cork used to seal the annulus of the installation hole, grasp the retrieval cord, and manually pull the sampler from each location. Corks are separated from the module and discarded. The exposed samplers are resealed in the designated shipping jars and placed immediately on ice in coolers supplied by the technology developer. Coolers are returned to the developer under proper chain-of-custody documentation. The GORE-SORBER® modules are then analyzed in the developer's analytical laboratory using a GC/MS.

Performance Range

GORE-SORBER® modules use granular adsorbents housed in a chemically inert, hydrophobic, microporous GORE-TEX® ePTFE membrane. Gore claims that the unique properties of the ePTFE membrane protect the granular adsorbents from physical contact with soil particulates and water, thereby allowing the GORE-SORBER® module to be placed directly in soil either in the vadose or saturated zones. Typical sampling depths for the GORE-SORBER® module are between 2 and 5 feet. The sampling depth used during the demonstration was 3 feet.

Quantitative Performance Assessment

Quantitative measures of the performance of the GORE-SORBER® Screening Survey passive soil gas sampling system consisted of (1) VOC detection and quantitation, (2) sample retrieval time, and (3) cost. The following sections discuss the first two performance factors; a cost analysis of the GORE-SORBER® Screening Survey is provided in Chapter 6.

VOC Detection and Quantitation

Seven samples were collected using the GORE-SORBER® modules within each sampling grid, as described in Chapter 3. Samples were analyzed for VOCs by GC/MS according to the standard operating guideline provided in the demonstration plan (PRC, 1997). Table 5-1 presents the range and mean VOC mass calculated from samples collected using the GORE-SORBER® Screening Survey. The VOC results for each sample collected are presented in Appendix A.

Table 5-2 compares the mean VOC concentrations detected using the GORE-SORBER® Screening Survey to those detected in the samples collected using the reference method. In all cases, the GORE-SORBER® Screening Survey detected the same compounds in each grid as the reference method, and in several instances detected compounds that were not detected using the reference method. For example, the GORE-SORBER® Screening Survey detected low levels of PCE at the SBA site and low levels of 1,1-DCA at the CSC site, where the reference method did not detect these compounds. Past soil sampling at the sites confirmed the presence of these contaminants.

Table 5-1. Volatile Organic Compound Mass in Samples Collected Using the GORE-SORBER® Screening Survey

		Mass (µg/sample)											
Site	Grid	Vinyl Chloride		Total DCE		1,1-DCA		1,1,1-TCA		TCE		PCE	
		Range	Mean	Range	Mean	Range	Mean	Range	Mean	Range	Mean	Range	Mean
SBA	1	399 - 1,640	919	507 - 665	592	<0.01	<0.01	<0.02	<0.02	0.70 - 4.11	1.97	0.02 - 0.14	0.06
SBA	2	<1.77	<1.77	0.76 - 14.6	6.04	<0.01	<0.01	<0.02	<0.02	69.9 - 163	108	0.54 - 1.58	1.02
SBA	4	<1.77	<1.77	0.84 - 3.21	1.38	<0.01	<0.01	<0.02	<0.02	51.6 - 327	195	0.08 - 1.08	0.42
SBA	5	<1.77 - 3.62	2.77	16.2 - 119	59.7	<0.01	<0.01	<0.02	<0.02	8.90 - 75.5	34.8	0.03 - 0.14	0.08
SBA	6	<1.77	<1.77	<0.02 - 0.81	0.18	<0.01	<0.01	<0.02	<0.02	<0.02	<0.02	<0.03	<0.03
CSC	1	NA	NA	96.0 - 242	181	<0.01 - 0.16	0.08	28.4 - 50.3	38.3	208 - 287	255	397 - 433	411
CSC	2	NA	NA	80.9 - 115	95.2	<0.01	<0.01	31.9 - 43.8	37.6	296 - 335	318	307 - 367	341
CSC	4	NA	NA	155 - 217	189	<0.01 - 0.13	0.06	24.4 - 35.3	30.2	209 - 273	252	324 - 367	351
CSC	5	NA	NA	40.3 - 88.9	65.0	<0.01	<0.01	16.7 - 25.5	22.3	189 - 239	217	292 - 345	327

µg/sample Micrograms per sample
 Total DCE Total Dichloroethene
 1,1-DCA 1,1-Dichloroethane
 1,1,1-TCA 1,1,1-Trichloroethane
 CSC Chemical Sales Company site
 PCE Tetrachloroethene
 TCE Trichloroethene
 NA Not analyzed
 SBA Small Business Administration site

Table 5-2. Mean Chemical Concentrations of the GORE-SORBER® Screening Survey and Reference Soil Gas Sampling Method

		Mean Concentration											
Site	Grid	Vinyl Chloride		Total DCE		1,1-DCA		1,1,1-TCA		TCE		PCE	
		GORE-SORBER® (µg/sample)	Ref. (ng/L)	GORE-SORBER® (µg/sample)	Ref. (ng/L)	GORE-SORBER® (µg/sample)	Ref. (ng/L)	GORE-SORBER® (µg/sample)	Ref. (ng/L)	GORE-SORBER® (µg/sample)	Ref. (ng/L)	GORE-SORBER® (µg/sample)	Ref. (ng/L)
SBA	1	919	2,390,000	592	958,000	<0.01	<50	<0.02	<50	1.97	<50	0.06	<50
SBA	2	<1.77	<100	6.04	65	<0.01	<50	<0.02	<50	108	1,250	1.02	<50
SBA	4	<1.77	<100	1.38	101	<0.01	<50	<0.02	<50	195	9,390	0.42	<50
SBA	5	2.77	1,980	59.7	9,980	<0.01	<50	<0.02	<50	34.8	2,010	0.08	<50
SBA	6	<1.77	NA	0.18	NA	<0.01	NA	<0.02	NA	<0.02	NA	<0.03	NA
CSC	1	NA	NA	181	10,800	0.08	<500	38.3	314,000	255	41,800	411	330,000
CSC	2	NA	NA	95.2	1,850	<0.01	<500	37.6	288,000	318	89,500	341	223,000
CSC	4	NA	NA	189	6,190	0.06	<500	30.2	142,000	252	22,200	351	192,000
CSC	5	NA	NA	65.0	738	<0.01	<500	22.3	69,900	217	11,500	327	98,500

28

µg/sample	Micrograms per sample	NA	Not analyzed
ng/L	Nanograms per liter	PCE	Tetrachloroethene
Total DCE	Total Dichloroethene	TCE	Trichloroethene
1,1-DCA	1,1-Dichloroethane	Ref.	Reference Soil Gas Sampling Method
1,1,1-TCA	1,1,1-Trichloroethane	SBA	Small Business Administration site
CSC	Chemical Sales Company site		

The ability of the GORE-SORBER[®] Screening Survey to detect low-concentration VOCs that the reference sampling method did not detect suggests that, under conditions similar to this demonstration, the prolonged sampling period for the GORE-SORBER[®] modules may provide higher sensitivity to low-concentration contaminants.

The GORE-SORBER[®] Screening Survey and the reference method are field screening techniques that provide only an estimate of the actual concentration of contaminants in the soil gas. Because the GORE-SORBER[®] Screening Survey and the reference method use different methods to collect soil gas samples, it is not expected that the two methods will provide the same response. Furthermore, because analysis of GORE-SORBER[®] modules yields results in micrograms per sample and the reference method produces results in nanograms per liter, the data cannot be directly compared. Consequently, graphical methods were used to examine the relationship between the values reported by the two methods. Comparative plots for total DCE, 1,1,1-TCA, TCE, and PCE data are presented as Figures 5-1 through 5-4. Mean concentrations from the reference method are plotted on the x axis, and mean analyte mass values reported by the GORE-SORBER[®] Screening Survey are plotted on the y axis. Insufficient data are available to provide a meaningful plot of vinyl chloride and 1,1-DCA data. [Note: Neither the GORE-SORBER[®] Screening Survey or the reference sampling method detected 1,1-DCA or 1,1,1-TCA at the SBA site, which also correlates with analytical data from soil and groundwater collected at the site by E&E and predemonstration activities conducted by Tetra Tech.]

Based on a review of the data distribution presented in Figures 5-1 through 5-4, the relationship between the mass of compounds measured on the GORE-SORBER[®] modules and the concentrations measured using the reference sampling method is nonlinear, and suggests a logarithmic trend. Logarithmic trendlines were fitted to each plot, and a correlation coefficient was calculated to evaluate how well the trendlines matched the data. The correlation coefficients were 0.815 for total DCE, 0.997 for 1,1,1-TCA, 0.876 for TCE, and 0.994 for PCE. A correlation factor of 1.00 is a “perfect” match with the logarithmic trendline.

The plots indicate that there is a relative correlation between the GORE-SORBER[®] Screening Survey and reference method data; the higher the concentration of contaminant in the soil gas, the higher the mass detected using the GORE-SORBER[®] Screening Survey. The plots also show that at higher contaminant levels, the ratio between the mass of contaminant detected using the GORE-SORBER[®] modules and the concentration of contaminant in the soil gas decreases, suggesting sorbent saturation may have occurred in the GORE-SORBER[®] modules.

Sample Retrieval Time

During the demonstration, installation of the GORE-SORBER[®] modules averaged 8.0 minutes per sampler at the SBA site and 7.4 minutes per sampler at the CSC site. For the demonstration, the samplers were left in place for approximately 10 days at each site. Collection of the samplers required an average of 1.9 minutes per sampler at the SBA site and 2.4 minutes at the CSC site. Overall, installation and collection of 35 GORE-SORBER[®] modules at the SBA site required 346 minutes, an average of 9.9 minutes per sample and installation and collection of 28 GORE-SORBER[®] modules at the CSC site required 274 minutes, an average of 9.8 minutes per sample. The analysis and reporting by the technology developer required 14 to 18 days from the time samples were collected until the laboratory report was delivered. The sample retrieval time included the amount of time per sample required to set up at a sampling grid, install and collect the seven samplers, grout the hole,

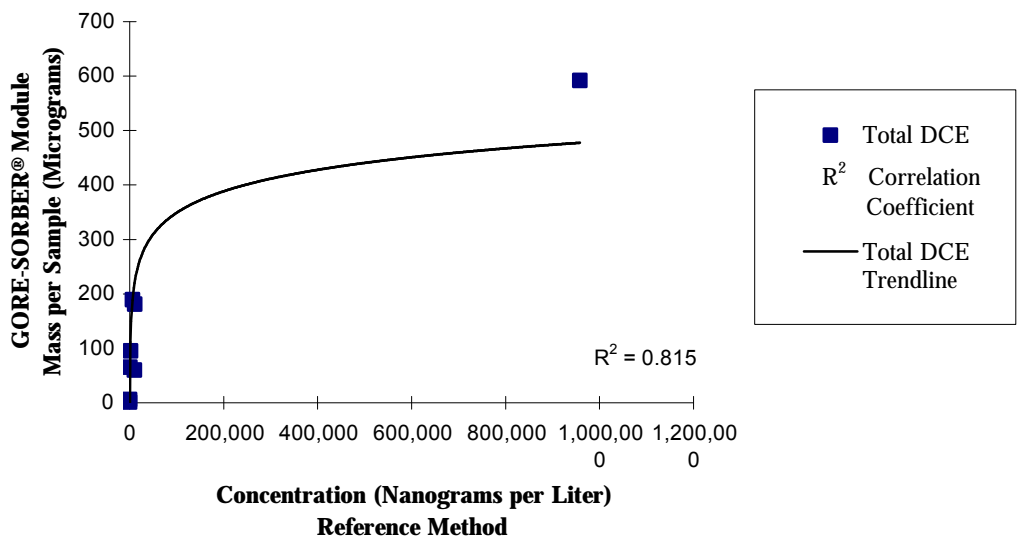

Figure 5-1. Comparative Plot of Mean Total DCE Mass Versus Concentration

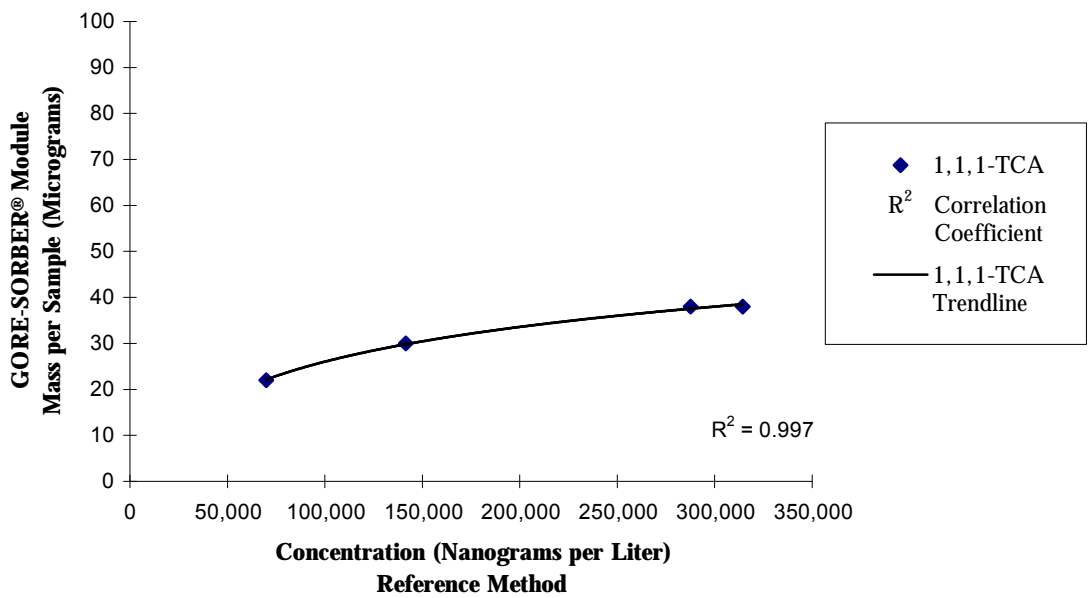

Figure 5-2. Comparative Plot of Mean 1,1,1-TCA Mass Versus Concentration

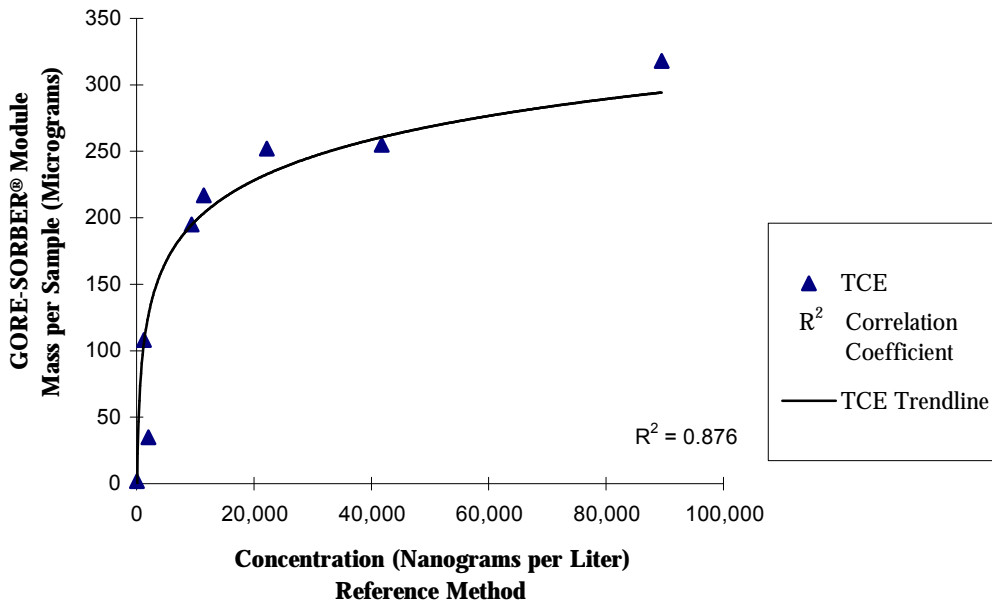

Figure 5-3. Comparative Plot of Mean TCE Mass Versus Concentration

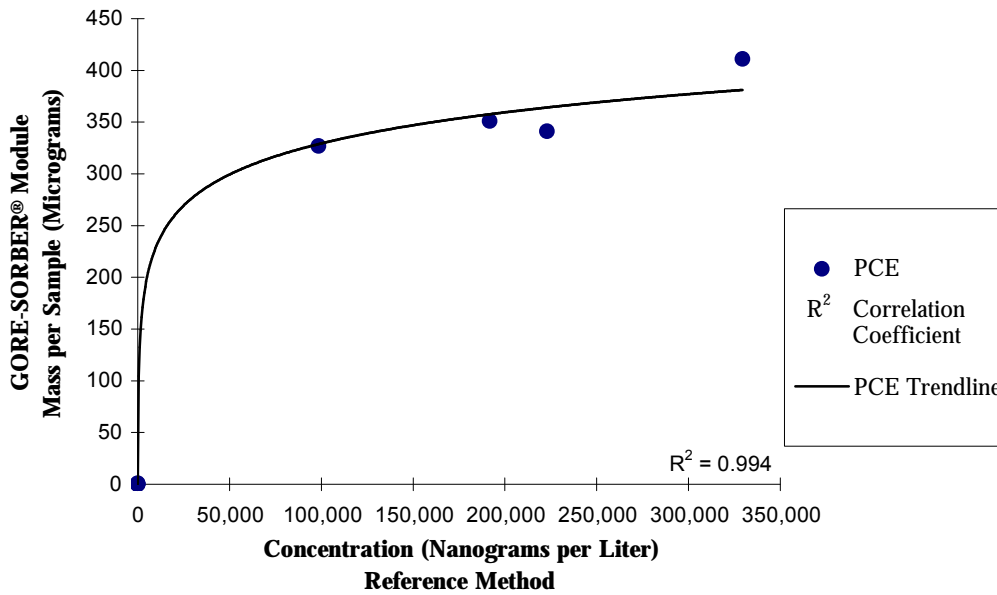

Figure 5-4. Comparative Plot of Mean PCE Mass Versus Concentration

decontaminate the sampling equipment, and move to a new sampling location. A two-person sampling crew installed and collected the GORE-SORBER[®] Screening Survey samples at both sites.

Table 5-3 presents a comparison of the average sample retrieval times for the GORE-SORBER[®] modules and those for the reference soil gas sampling method. The average sample retrieval times for the GORE-SORBER[®] modules were quicker than the reference sampling method in the clay soils at the SBA site and slower than the reference sampling method in the sandy soils at the CSC site.

Table 5-3. Average Sample Retrieval Times for the GORE-SORBER[®] Modules and the Reference Soil Gas Sampling Method

Sampler	Average Time (minutes per sample)	
	SBA Site	CSC Site
GORE-SORBER [®] Module		
Average Sample Installation Time	8.0	7.4
Average Sample Collection Time	1.9	2.4
Average Sample Retrieval Time	9.9	9.8
Reference Sampling Method		
Average Sample Retrieval Time	13.1	6.5

Note: A two-person sampling crew installed and collected soil gas samples using the GORE-SORBER[®] Screening Survey at both the SBA and CSC sites, and a three-person sampling and analysis crew collected and analyzed the soil gas samples using the reference soil gas sampling method at both sites.

Data Quality

Data quality was assessed throughout this demonstration by implementing an approved quality assurance project plan (PRC, 1997). The QA/QC procedures included the consistent application of approved methods for sample collection, chemical analysis, and data reduction. Based on the intended use of the data, QA objectives for precision, accuracy, representativeness, comparability, and completeness were established and QC samples were collected to assess whether the QA objectives were met. Based on the results of a field audit conducted by EPA and a detailed validation of the data by Tetra Tech, the data have been deemed acceptable for use as described in the demonstration design (Chapter 3). The results of the QC indicators used for this demonstration for the GORE-SORBER[®] Screening Survey are provided in the technology evaluation report for this demonstration (Tetra Tech, 1997) and are summarized below.

As planned, adsorbent samples from the SBA site were sent to the developer for analysis in accordance with the developer's standard operating procedures. The developer applied its own standard quality control procedures, as described in detail in the developer's data report provided in the technology evaluation report for this demonstration (Tetra Tech, 1997). The QC samples included field blanks, trip blanks, and laboratory duplicates.

At the SBA site, the target chlorinated hydrocarbon VOCs were not detected in the field blank. Cis-1,2-dichloroethene was detected up to 0.30 Fg per sample in the three trip blanks; however, this was on the order of 1 percent of the average amount of cis-1,2-dichloroethene in samples. At the CSC site, minor PCE contamination (up to 0.43 Fg per sample) was observed in the field blank and the three trip blanks. Lower levels of contamination with TCE and 1,1,1-TCA were also observed in the three trip blanks. These contamination levels were low in comparison to the sample concentrations (mean PCE concentration was 345 Fg per sample). Therefore, potential contamination of samples did not appear to be a significant issue at either site and the resulting data quality impacts are considered minimal.

The results of analysis of nine laboratory duplicate samples indicated that precision, as measured by the relative percent difference (RPD) of the duplicate results, was consistently within the QA objective of 50 percent for all target analytes. Only one result was outside the 50 percent objective (the RPD for PCE from the SBA site was 64 percent). Thus, method precision also appears to be acceptable.

Chapter 6

Economic Analysis

The GORE-SORBER[®] Screening Survey passive soil gas sampling system was demonstrated at two sites that varied geologically and were contaminated with VOCs at a range of concentrations. This chapter presents an economic analysis for applying the GORE-SORBER[®] Screening Survey at sites similar to those used in this demonstration. The demonstration costs for the reference sampling method are also provided.

This economic analysis estimates the range of costs for using a GORE-SORBER[®] Screening Survey to collect 40 subsurface soil gas samples at a clay soil site (similar to the SBA site) and a sandy soil site (similar to the CSC site). The analysis is based on the results and experience gained from this demonstration and on costs provided by Gore. To account for variability in cost data and assumptions, the economic analysis is presented as a list of cost elements and a range of costs for collecting soil gas samples using the GORE-SORBER[®] Screening Survey and reference sampling method.

Assumptions

Several factors affect the cost of subsurface soil gas sampling. Wherever possible, these factors are identified so that decision makers can independently complete a site-specific economic analysis. For example, this cost estimate is based on the soil type and average sample retrieval times calculated during the demonstrations at the SBA and CSC sites. This cost estimate assumes that a hammer-driven, steel rod is used to install the GORE-SORBER[®] Screening Survey 3 feet bgs, and that a direct-push platform is used to advance the active soil gas sampling system to a depth of 4.5 feet bgs for sample collection. The cost estimate also assumes that a one-person sampling crew collects soil gas samples using the GORE-SORBER[®] Screening Survey and that a two-person sampling and analysis crew collects and analyzes soil gas samples using the reference sampling method.

GORE-SORBER[®] Screening Survey

The costs for collecting soil gas samples using the GORE-SORBER[®] Screening Survey are presented in two categories: (1) sampler, sample analysis, and equipment costs, which include mobilization/demobilization, equipment use, and sampler and sample analysis for the GORE-SORBER[®] Screening Survey and (2) operating costs, which include labor for sampler installation and retrieval and other direct costs such as supplies and site restoration.

The cost categories and associated cost elements are defined and discussed below and serve as the basis for the estimated cost ranges presented in Table 6-1.

Table 6-1. Estimated Subsurface Soil Gas Sampling Costs for the GORE-SORBER® Screening Survey

Sampler, Sample Analysis, and Equipment Costs

Mobilization/Demobilization = \$200 to \$600 per site
 Equipment = \$25 to \$85 per day
 GORE-SORBER® Module and Sample Analysis = \$125 to \$225 per sample

Operating Costs

Clay Soil Site		Sandy Soil Site	
Sample Retrieval Time = 7 to 9 hours (1 day)		Sample Retrieval Time = 7 to 9 hours (1 day)	
Total Samples Collected = 40		Total Samples Collected = 40	
Total Sample Depth = 120 feet (3 feet/sample)		Total Sample Depth = 120 feet (3 feet/sample)	
Sampling Crew Size = 1 Person		Sampling Crew Size = 1 Person	
Labor Costs		Labor Costs	
Mobilization/Demobilization	\$400 - \$600	Mobilization/Demobilization	\$400 - \$600
Travel	\$12 - \$60	Travel	\$12 - \$60
Per Diem	0 - \$300	Per Diem	0 - \$300
Sample Retrieval	\$350 - \$450	Sample Retrieval	\$350 - \$450
Other Direct Costs		Other Direct Costs	
Supplies	\$25 - \$75	Supplies	\$25 - \$75
Site Restoration	\$25 - \$50	Site Restoration	\$25 - \$50
Range of Operating Costs*	\$810 - \$1,540		\$810 - \$1,540

* The range of Operating Costs is rounded to the nearest tens of dollars and does not include Sampler, Sample Analysis, and Equipment Costs

Sampler, Sample Analysis, and Equipment Costs. These costs include mobilization/demobilization, equipment, and sampler and sample analysis for the GORE-SORBER® Screening Survey. Cost ranges were estimated as a daily equipment use fee and a per-sample charge. The costs include:

- C Mobilization/Demobilization Costs — These costs include preparing, delivering, and setting up the sampling equipment as well as packing up and returning the equipment to the vendor’s facility. Equipment mobilization and demobilization costs are estimated to range from \$200 to \$600 for each site.
- C Equipment Costs — Based on the average sample retrieval times for the demonstration and on collecting 40 samples at each site, it is assumed that 1 day will be required to install the passive soil gas detectors at the clay soil site and 1 day at the sandy soil site. Equipment costs are estimated to range from \$25 to \$85 per day and include the cost of equipment to install the passive soil gas sampler (hammer-driven steel rod [\$25 per day]) and rental of a roto-hammer (\$60 per day). A roto-hammer is required only if samplers must be installed below pavement. No equipment is needed during retrieval of the passive soil gas detectors.

-
- C GORE-SORBER[®] Module and Sample Analysis Costs — Unit costs of the GORE-SORBER[®] Screening Survey include GORE-SORBER[®] modules, laboratory analysis, data tables, maps, and a final report. The GORE-SORBER[®] Screening Survey costs range from \$125 to \$225 per sample, depending on the selected target analytes. The GORE-SORBER[®] Screening Survey costs include off-site laboratory analysis using a GC/MS.

Operating Costs. Operating costs are limited to mobilization/demobilization, travel, on-site labor costs, and per diem. Operating costs for collecting the GORE-SORBER[®] modules are segregated into labor costs and other direct costs, as shown below.

Labor costs include mobilization/demobilization, travel, per diem, and sample retrieval costs.

- C Mobilization/Demobilization Labor Costs — This cost element includes the time for one person to prepare for and travel to each site and includes 4 to 6 hours at a rate of \$50 per hour for two trips (one for sampler installation and one for sampler collection).
- C Travel Costs — Travel costs for each site are limited to round-trip mileage costs and are estimated to be between 20 to 100 miles at a rate of \$0.30 per mile for 2 trips (one for sampler installation and one for sampler collection).
- C Per Diem Costs — This cost element includes food, lodging, and incidental expenses and is estimated to range from zero (for a local site) to \$150 per day per person for one person for 2 days (1 day for mobilization and sample installation; 1 day for sample collection, demobilization, and site restoration.) Costs are estimated to be the same for the clay site and the sandy site.
- C Sample Retrieval Labor Costs — On-site labor costs include labor for sampler installation and sampler collection. Because installation and collection of the GORE-SORBER[®] modules is relatively simple, additional oversight labor is not required. Only one person is required to install and collect the passive soil gas detectors. Based on the average demonstration sample retrieval times, sample installation and collection labor times are estimated to be 7 to 9 hours for one person at each site (clay or sandy soil). Labor rates are estimated at \$50 per hour.

Other direct costs include supplies and site restoration costs.

- C Supplies — This cost element includes decontamination supplies, such as buckets, soap, high-purity rinse water, and brushes, as well as personal protective equipment (Level D, the minimum level of protection, is assumed). Supplies are estimated to cost between \$25 and \$75.
- C Site Restoration — Site restoration costs include grouting the sample boreholes and site restoration labor. Grouting costs for each site are limited to grout and grouting tools (\$25 to \$50). Site restoration labor cost are included under sample retrieval labor costs.

Reference Sampling Method

The costs for implementing the reference soil gas sampling method (active soil gas sampler) during the demonstration include categories for sampling and analysis and for oversight, as presented in Table 6-2 and discussed below.

Table 6-2. Estimated Subsurface Soil Gas Sampling Costs for the Reference Sampling Method

Sampling and Analysis Equipment Costs			
Lump Sum = \$4,700 for each site			
Oversight Costs			
Clay Soil Site		Sandy Soil Site	
Total Sampling Time = 9 to 11 hours (2 days)		Total Sampling Time = 5 to 7 hours (1 day)	
Total Samples Collected = 40		Total Samples Collected = 40	
Total Sample Depth = 180 feet (4.5 feet/sample)		Total Sample Depth = 180 feet (4.5 feet/sample)	
Sampling Crew Size = 2 People		Sampling Crew Size = 2 People	
Labor Costs		Labor Costs	
Mobilization/Demobilization	\$200 - \$300	Mobilization/Demobilization	\$200 - \$300
Travel	\$6 - \$30	Travel	\$6 - \$30
Per Diem	0 - \$300	Per Diem	0 - \$150
Sampling Oversight	\$450 - \$550	Sampling Oversight	\$250 - \$350
Other Direct Costs		Other Direct Costs	
Supplies	\$25 - \$75	Supplies	\$25 - \$75
Range of Oversight Costs*	\$680 - \$1,260		\$480 - \$910

* The range of Oversight Costs is rounded to the nearest tens of dollars and does not include Sampling and Analysis Equipment Costs

Sampling and Analysis Costs. Total lump sum sampling and analysis equipment costs for the clay and sandy soil sites was \$4,700 for each site, and included:

- C Mobilization and demobilization
- C Drilling footage
- C Active soil gas sampling system
- C On-site laboratory analysis using a GC and electrolytic conductivity detector
- C Active soil gas sampling and analysis crew labor costs (2 people)
- C Per diem for the crew (2 people)
- C Grouting boreholes
- C Site restoration
- C Decontamination supplies
- C Waste collection and containerization
- C Data tables

Additional mobilization/demobilization and per diem costs will apply if the site is more than 100 miles from the active soil gas developer. The minimum active soil gas sampling cost is \$2,500 per day for the collection and analysis of 20 samples for six or fewer VOCs. Up to 20 additional samples could be collected per day at an additional cost of \$90 per sample and \$5 per linear sample depth foot.

Oversight Costs. Oversight costs are presented as ranges to provide an estimate of oversight costs that may be incurred at other sites. Costs for overseeing the reference sampling are segregated into labor costs and other direct costs, as shown below.

Labor costs include mobilization/demobilization, travel, per diem, and sampling oversight.

- C Mobilization/Demobilization Labor Costs — This cost element includes the time for one person to prepare for and travel to each site, and includes 4 to 6 hours each at a rate of \$50 per hour.
- C Travel Costs — Travel costs for each site are limited to round-trip mileage costs for 20 to 100 miles at a rate of \$0.30 per mile.
- C Per Diem Costs — This cost element includes food, lodging, and incidental expenses and is estimated to range from zero (for a local site) to \$150 per day for one person for 2 days at the clay soil site (1 day for sample collection and ½ day for mobilization and demobilization and site restoration) and for one person for 1 day at the sandy soil site (½ day for sample collection and ½ day for mobilization/demobilization and site restoration). No per diem costs are presented for the sampling and analysis crew because these costs are included in the sampling and analysis equipment lump sum.
- C Sampling Oversight Labor Costs — On-site labor, often a registered geologist, is required to oversee sample collection. Active soil gas collection labor typically includes a platform operator and one helper to collect samples and decontaminate sampling equipment. Therefore, the total number of personnel on site would be three: one person to oversee sampling activities and two people to operate the direct-push equipment and collect samples. Based on the average sample retrieval times determined during the demonstration, sampling oversight labor times are estimated to be 9 to 11 hours for one person at the clay soil site and 5 to 7 hours for one person at the sandy soil site. Labor rates are assumed to be \$50 per hour. Labor costs for the active soil gas sampler operators are included in the equipment costs.

Other direct costs include supplies. Decontamination and site restoration costs are included under the sampling and analysis equipment costs.

- C Supplies — This cost element includes personal protective equipment (Level D, the minimum level of protection, is assumed) and other miscellaneous field supplies. Supplies are estimated to cost between \$25 and \$75.

Chapter 7

Summary of Demonstration Results

This chapter summarizes the technology performance results. The GORE-SORBER[®] Screening Survey was compared to the reference method (active soil gas sampling) in terms of the following parameters: (1) VOC detection and quantitation, (2) sample retrieval time, and (3) cost. The demonstration data indicate the following performance characteristics for the GORE-SORBER[®] Screening Survey:

- C **VOC Detection and Quantitation:** The GORE-SORBER[®] Screening Survey detected the same compounds in each sample as the reference soil gas sampling method, as well as several VOCs that the reference method did not detect. This performance characteristic suggests that the GORE-SORBER[®] Screening Survey may detect VOCs that are at lower concentrations in the subsurface than the reference soil gas sampling method can detect. The results also indicate a general correlation between the GORE-SORBER[®] Screening Survey and reference method data. However, at high contaminant levels, the ratio between the mass of contaminant in soil gas detected using the GORE-SORBER[®] module and the concentration of contaminant in soil gas detected using the reference soil gas sampling method decreases, suggesting that sorbent saturation may have occurred. The GORE-SORBER[®] Screening Survey and reference method are field screening techniques that provide only an estimate of the actual concentration of contaminants in soil gas. Because the GORE-SORBER[®] Screening Survey and reference method use different techniques to collect soil gas samples, it is not expected that the two methods will provide the same response or that the data will be directly comparable. In addition, the GORE-SORBER[®] Screening Survey yields results in micrograms per sample and the reference soil gas sampling method reports results in nanograms per liter. Therefore, a statistical analysis of the data was not performed, and interpretation of the chemical concentration data for this demonstration is limited to qualitative observations.

- C **Sample Retrieval Time:** Installation of the GORE-SORBER[®] modules averaged 8.0 minutes per sampler at the SBA site and 7.4 minutes per sampler at the CSC site. For the demonstration, the modules were left in place for approximately 10 days. Collection of the modules required an average of 1.9 minutes per sampler at the SBA site and 2.4 minutes at the CSC site. Overall, installation and collection of 35 GORE-SORBER[®] modules at the SBA site required 346 minutes, an average of 9.9 minutes per sample and installation and collection of 28 GORE-SORBER[®] modules at the CSC site required 274 minutes, an average of 9.8 minutes per sample. The analysis and reporting by the technology developer required 14 to 18 days from the time samples were collected until the laboratory report was delivered. The reference soil gas method required 458 minutes to collect 35 samples at the SBA site, an average of 13.1 minutes per sample, and 183 minutes to collect 28 samples at the CSC site, an average of 6.5 minutes per sample. One day was required per site to analyze the samples and report the results. Based on the demonstration results, the average sample retrieval times for the GORE-

SORBER[®] modules were quicker than the reference method in the clay soils at the SBA site and slower than the reference sampling method in the sandy soils at the CSC site. The results also indicate that the sample retrieval time for the GORE-SORBER[®] modules may be less susceptible to variations in soil type than the sample collection times for the reference method. During sample collection using the reference method, the clay soil at the SBA site caused the system to hold its vacuum at several sampling locations; therefore, soil gas was not completely drawn into the system for sampling. In these cases, the rod was withdrawn in additional 6-inch increments until the vacuum was broken and the system's pressure reached equilibrium with atmospheric pressure. The vacuum problem was not encountered in the sandy soil at the CSC site. A two-person sampling crew retrieved soil gas samples using the GORE-SORBER[®] Screening Survey at both the SBA and CSC sites, and a three-person sampling and analysis crew collected and analyzed soil gas samples using the reference method at both sites.

- C **Cost:** Based on the demonstration results, the GORE-SORBER[®] Screening Survey cost \$125 to \$225 per sample plus equipment costs of \$25 to \$85 per day and mobilization/demobilization costs of \$200 to \$600 per site. Operating costs for the GORE-SORBER[®] Screening Survey ranged from \$810 to \$1,540 at both the clay soil site and the sandy soil site. For this demonstration, the active soil gas sampling method was procured at a lump sum of \$4,700 per site for the collection and analysis of 40 soil gas samples at each site. Oversight costs for the active soil gas sampling method ranged from \$680 to \$1,260 at the clay soil site and \$480 to \$910 at the sandy soil site. A site-specific cost and performance analysis is recommended before selecting a subsurface soil gas sampling method.

In general, the data quality indicators selected for this demonstration met the established quality assurance objectives and support the usefulness of the demonstration results in verifying the performance of the GORE-SORBER[®] Screening Survey.

A qualitative performance assessment of the GORE-SORBER[®] Screening Survey indicated that (1) all 63 modules installed at the SBA and CSC sites were retrieved without sample loss, resulting in 100 percent completeness; (2) the sampler is easy to use and requires minimal training (a 10-minute training video is available from the developer); (3) logistical requirements for the GORE-SORBER[®] Screening Survey require that the samplers be installed using a manual push tool, left in place for several days, retrieved by hand, and sent to the developer for analysis; and (4) sample handling in the field requires that sorbent be properly containerized and shipped to the developer. Other factors that may affect the performance range of the GORE-SORBER[®] Screening Survey but that were not evaluated during the demonstration are sampling depth, time allowed for sampling, type and amount of sorbent material placed in the GORE-SORBER[®] module, and ability of vapors to move across the module membrane.

The demonstration results indicate that the GORE-SORBER[®] Screening Survey can provide useful, cost-effective data for environmental problem-solving. The GORE-SORBER[®] modules successfully collected soil gas samples in clay and sandy soils. The sampler provided positive identification of target compounds and may detect lower concentrations of VOCs in the soil gas than can the reference method. Based on the results of this demonstration, there appears to be a general correlation between the GORE-SORBER[®] Screening Survey and reference method data. However, at higher contaminant levels, the ratio between the mass of contaminant detected in the soil gas using the GORE-SORBER[®] module and the concentration of contaminant detected using the reference method decreases. As with any technology selected, the user must determine what is appropriate for the application and the project data quality objectives.

Chapter 8

Technology Update

Guidelines for Use of GORE-SORBER[®] module in Water Quality Monitoring

The GORE-SORBER[®] Screening Survey has been validated and applied on more than 1,200 projects since 1992. When placed in the screened, saturated interval of a monitoring well or piezometer, the waterproof, vapor-permeable GORE-TEX[®] (ePTFE) membrane collector housing allows for water/air partitioning (in accordance with Henry's Law) of dissolved-phase organic compounds while preventing transfer of liquid water and eliminating impact from suspended solids on the adsorbent. Outlined below are some general guidelines for use and installation of passive, adsorbent-based GORE-SORBER[®] collectors in monitoring wells as a means of qualitatively screening water quality as part of a groundwater monitoring program.

- C GORE-SORBER[®] collectors can be used to reduce the frequency of groundwater purging and sampling for petroleum and chlorinated organic chemicals, including polynuclear aromatic hydrocarbons (PAHs).
- C We recommend an initial round of testing consisting of matrix (water) sampling and testing by conventional means and testing using GORE-SORBER[®] modules. The deployment and retrieval of the GORE-SORBER[®] modules should occur prior to any purging/sampling of the well for matrix testing purposes in order to establish a baseline relationship at this site between the matrix concentration data and the sorber mass data. The results will then be plotted on a scatter diagram to show the site-specific relationship between groundwater concentration and mass on the GORE-SORBER[®] module.
- C Subsequent testing uses only GORE-SORBER[®] modules to monitor trends in water quality over time on an individual well basis.
- C Periodic purging and sampling with concurrent GORE-SORBER[®] collector monitoring is recommended every four to six sampling events. To ensure comparability of the data, the periodic matrix samples must be collected and analyzed in a consistent manner.

Chapter 8 was written solely by W.L. Gore & Associates. The statements presented in this chapter represent the vendor's point of view and summarize the claims made by the vendor regarding the GORE-SORBER[®] Screening Survey. Publication of this material does not represent the EPA's approval or endorsement of the statements made in this chapter; results of the performance evaluation of the GORE-SORBER[®] Screening Survey are discussed in other chapters of this report.

-
- C Modules should be placed adjacent to the screened interval in the monitoring well, not in the headspace of the well or outside the screened interval to avoid any stagnation effects.
 - C Modules should not be placed in direct contact with free product (that is, liquid hydrocarbons or solvents).
 - C Only a 2-day exposure period is required for modules deployed directly in groundwater. This exposure period has been derived experimentally as part of our validation.
 - C GORE-SORBER® Screening Survey modules can be used to test for toluene, ethylbenzene, and xylene, petroleum hydrocarbons, chlorinated solvents, and many SVOCs, such as polynuclear aromatic hydrocarbons (PAHs). Application for ethers, alcohols, ketones, or most other highly water-soluble compounds has not been validated at this time.
 - C Information relative to the site, the well construction, and matrix sampling and testing procedures being used will be useful for data interpretation purposes.
 - C Monitoring wells being used as soil vapor extraction (SVE) points are not suitable to this application.

NELAC Certification of Screening Modules Laboratory

The W.L. Gore & Associates, Inc. Screening Modules Laboratory has been certified to be in conformance with the National Environmental Laboratory Accreditation Conference (NELAC) Chapter 5, Quality System Standards, adopted in July, 1997 by U.S. EPA, federal and state officials as the national environmental laboratory performance standard for the United States.

CRREL Study

In a field comparison by the U.S. Army Corps of Engineers Cold Regions Research Engineering Laboratory (CRREL) in Hanover, New Hampshire, the GORE-SORBER® Screening Survey was compared to an in-vial sample handling and analysis method for estimating volatile organic compound contamination in the near surface vadose zone. The two methods, although very different operationally, yielded similar results for trichloroethane contamination. The correlation ($R^2 = 0.944$) between the two methods was far better than those between the in-vial method and conventional soil sample collection and handling techniques. Copies of CRREL Special Report 96-14 are available from W.L. Gore & Associates, Inc.

Chapter 8 was written solely by W.L. Gore & Associates. The statements presented in this chapter represent the vendor's point of view and summarize the claims made by the vendor regarding the GORE-SORBER® Screening Survey. Publication of this material does not represent the EPA's approval or endorsement of the statements made in this chapter; results of the performance evaluation of the GORE-SORBER® Screening Survey are discussed in other chapters of this report.

Chapter 9

Previous Deployment

The GORE-SORBER® Screening Survey has been applied at more than 1,200 sites around the world since 1992. It has been used at many small and large industrial facilities, at petroleum refining, bulk storage and retail facilities, at military sites, and at Department of Energy sites. The GORE-SORBER® Screening Survey has been approved by state environmental regulatory agencies and by regional offices of EPA in site-specific work plan documents for RI/FS and Resource Conservation and Recovery Act (RCRA) Facility Investigations under the Comprehensive Environmental Response, Compensation, and Liability Act/Superfund Amendments and Reauthorization Act and RCRA. Case studies for a variety of applications are available from W.L. Gore & Associates, Inc.

Chapter 9 was written solely by W.L. Gore & Associates. The statements presented in this chapter represent the vendor's point of view and summarize the claims made by the vendor regarding the GORE-SORBER® Screening Survey. Publication of this material does not represent the EPA's approval or endorsement of the statements made in this chapter; results of the performance evaluation of the GORE-SORBER® Screening Survey are discussed in other chapters of this report.

References

- Ecology & Environment. 1996. "Expanded Site Inspection for the Albert City, SBA Site, Albert City, Iowa." July.
- Engineering-Science, Inc. 1991. "Remedial Investigation/Feasibility Report for the Chemical Sales Company Superfund Site, OU1, Leyden Street Site."
- PRC Environmental Management, Inc. 1997. "Final Demonstration Plan for the Evaluation of Soil Sampling and Soil Gas Sampling Technologies."
- Tetra Tech EM Inc. 1997. "Soil and Soil Gas Technology Evaluation Report."
- W.L. Gore & Associates (Gore). 1996. Approved Quality Assurance Manual Number QAM-1.10/25/96, Revision 5.
- Gore. 1997. GORE-SORBER[®] Product Schematic
- U.S. Environmental Protection Agency. 1986. Test Methods for Evaluating Solid Waste. SW-846. Third Edition.

APPENDIX A

DATA SUMMARY TABLES

FOR THE

W.L. GORE & ASSOCIATES, INC.
GORE-SORBER® SCREENING SURVEY
PASSIVE SOIL GAS SAMPLING SYSTEM

**TABLE A1. VOLATILE ORGANIC COMPOUND CONCENTRATIONS
FOR GORE AND REFERENCE DATA
SBA SITE - GRID 1**

Sample Name	Sample Location	Soil Type	Contaminant Concentration (ng/sample)					
			Vinyl Chloride	Total DCE	1,1-DCA	1,1,1-TCA	TCE	PCE
GORE SAMPLER DATA								
137567 - GORE	A5	Fine	399	621	0.01	0.02	2.80	0.14
137568 - GORE	B6	Fine	663	630	0.01	0.02	4.11	0.11
137564 - GORE	C4	Fine	618	608	0.01	0.02	2.80	0.08
137565 - GORE	D4	Fine	1,051	665	0.01	0.02	1.17	0.05
137563 - GORE	E2	Fine	781	550	0.01	0.02	0.70	0.02
137562 - GORE	F1	Fine	1,281	507	0.01	0.02	1.36	0.02
137566 - GORE	G4	Fine	1,640	560	0.01	0.02	0.86	0.03
Quantitation Limit	-	-	1.77	0.02	0.01	0.02	0.02	0.03

Range: 399 - 1,640 507 - 665 0.01 0.02 0.70 - 4.11 0.02 - 0.14

Mean: 919 592 0.01 0.02 1.97 0.06

Sample Name	Sample Location	Soil Type	Contaminant Concentration (ng/L)					
			Vinyl Chloride	Total DCE	1,1-DCA	1,1,1-TCA	TCE	PCE
REFERENCE SAMPLING METHOD DATA								
ACTAG1A105.0	A1	Fine	230,224	343,072	50	50	50	50
ACTAG1B605.0	B6	Fine	3,830,535	2,223,217	50	50	50	50
ACTAG1C105.0	C1	Fine	2,808,445	1,705,212	50	50	50	50
ACTAG1D605.0	D6	Fine	1,059,056	640,633	50	50	50	50
ACTAG1E705.0	E7	Fine	3,102,754	1,218,334	50	50	50	50
ACTAG1F405.0	F4	Fine	517,255	297,770	50	50	50	50
ACTAG1G605.0	G6	Fine	5,178,313	279,336	50	50	50	50

Range: 230,000 - 5,180,000 279,000 - 2,220,000 50 50 50 50

Mean: 2,390,000 958,000 50 50 50 50

Notes:

Gore Data: Quantitation limits are listed in the last row of the table.

Reference Data: Values reported as 50 are actually non-detects at a detection limit of 50 ng/L.

**TABLE A2. VOLATILE ORGANIC COMPOUND CONCENTRATIONS
FOR GORE AND REFERENCE DATA
SBA SITE - GRID 2**

Sample Name	Sample Location	Soil Type	Contaminant Concentration (ng/sample)					
			Vinyl Chloride	Total DCE	1,1-DCA	1,1,1-TCA	TCE	PCE
GORE SAMPLER DATA								
137580 - GORE	A5	Fine	1.77	2.85	0.01	0.02	163	1.58
137578 - GORE	B3	Fine	1.77	0.76	0.01	0.02	69.9	1.26
137576 - GORE	C1	Fine	1.77	1.80	0.01	0.02	71.1	1.23
137581 - GORE	D5	Fine	1.77	4.01	0.01	0.02	79.4	0.88
137582 - GORE	E6	Fine	1.77	5.23	0.01	0.02	99.1	0.77
137577 - GORE	F2	Fine	1.77	14.6	0.01	0.02	152	0.88
137579 - GORE	G4	Fine	1.77	13.1	0.01	0.02	120	0.54
Quantitation Limit	-	-	1.77	0.02	0.01	0.02	0.02	0.03

Range: 1.77 0.76 - 14.6 0.01 0.02 69.9 - 163 0.54 - 1.58

Mean: 1.77 6.04 0.01 0.02 108 1.02

Sample Name	Sample Location	Soil Type	Contaminant Concentration (ng/L)					
			Vinyl Chloride	Total DCE	1,1-DCA	1,1,1-TCA	TCE	PCE
REFERENCE SAMPLING METHOD DATA								
ACTAG2A405.0	A4	Fine	100	50	50	50	491	50
ACTAG2B605.0	B6	Fine	100	50	50	50	560	50
ACTAG2C305.0	C3	Fine	100	50	50	50	508	50
ACTAG2D205.0	D2	Fine	100	151	50	50	5,378	50
ACTAG2E605.0	E6	Fine	100	50	50	50	323	50
ACTAG2F505.0	F5	Fine	100	58	50	50	1,283	50
ACTAG2G705.0	G7	Fine	100	50	50	50	183	50

Range: 100 50 - 151 50 50 183 - 5,380 50

Mean: 100 65 50 50 1,250 50

Notes:

Gore Data: Quantitation limits are listed in the last row of the table.

Reference Data: Values reported as 50 (or 100 for vinyl chloride) are actually non-detects at a detection limit of 50 ng/L (or 100 ng/L for vinyl chloride).

**TABLE A3. VOLATILE ORGANIC COMPOUND CONCENTRATIONS
FOR GORE AND REFERENCE DATA
SBA SITE - GRID 4**

Sample Name	Sample Location	Soil Type	Contaminant Concentration (ng/sampler)					
			Vinyl Chloride	Total DCE	1,1-DCA	1,1,1-TCA	TCE	PCE
GORE SAMPLER DATA								
137571 - GORE	A3	Fine	1.77	1.09	0.01	0.02	228	0.51
137572 - GORE	B5	Fine	1.77	1.40	0.01	0.02	327	1.08
137574 - GORE	C6	Fine	1.77	0.84	0.01	0.02	209	0.38
137569 - GORE	D2	Fine	1.77	3.21	0.01	0.02	254	0.41
137575 - GORE	E7	Fine	1.77	1.17	0.01	0.02	136	0.22
137573 - GORE	F5	Fine	1.77	0.87	0.01	0.02	163	0.27
137570 - GORE	G3	Fine	1.77	1.08	0.01	0.02	51.6	0.08
Quantitation Limit	-	-	1.77	0.02	0.01	0.02	0.02	0.03

Range: 1.77 0.84 - 3.21 0.01 0.02 51.6 - 327 0.08 - 1.08

Mean: 1.77 1.38 0.01 0.02 195 0.42

Sample Name	Sample Location	Soil Type	Contaminant Concentration (ng/L)					
			Vinyl Chloride	Total DCE	1,1-DCA	1,1,1-TCA	TCE	PCE
REFERENCE SAMPLING METHOD DATA								
ACTAG4A305.0	A3	Fine	100	50	50	50	3,429	50
ACTAG4B505.0	B5	Fine	100	195	50	50	14,259	50
ACTAG4C105.0	C1	Fine	100	261	50	50	33,558	50
ACTAG4D205.0	D2	Fine	100	50	50	50	744	50
ACTAG4E405.0	E4	Fine	100	50	50	50	1,088	50
ACTAG4F305.0	F3	Fine	100	50	50	50	3,330	50
ACTAG4G105.0	G1	Fine	100	50	50	50	9,295	50

Range: 100 50 - 261 50 50 744 - 33,600 50

Mean: 100 101 50 50 9,390 50

Notes:

Gore Data: Quantitation limits are listed in the last row of the table.

Reference Data: Values reported as 50 (or 100 for vinyl chloride) are actually non-detects at a detection limit of 50 ng/L (or 100 ng/L for vinyl chloride).

**TABLE A4. VOLATILE ORGANIC COMPOUND CONCENTRATIONS
FOR GORE AND REFERENCE DATA
SBA SITE - GRID 5**

Sample Name	Sample Location	Soil Type	Contaminant Concentration (ng/sample)					
			Vinyl Chloride	Total DCE	1,1-DCA	1,1,1-TCA	TCE	PCE
GORE SAMPLER DATA								
137557 - GORE	A4	Fine	1.77	44.8	0.01	0.02	15.4	0.08
137559 - GORE	B5	Fine	3.62	19.4	0.01	0.02	8.90	0.04
137554 - GORE	C2	Fine	3.43	69.3	0.01	0.02	28.3	0.14
137561 - GORE	D6	Fine	1.77	16.2	0.01	0.02	18.1	0.03
137555 - GORE	E2	Fine	2.80	119	0.01	0.02	50.5	0.14
137556 - GORE	F3	Fine	2.51	79.2	0.01	0.02	46.9	0.08
137558 - GORE	G5	Fine	3.47	69.7	0.01	0.02	75.5	0.08
Quantitation Limit	-	-	1.77	0.02	0.01	0.02	0.02	0.03

Range: 1.77 - 3.62 16.2 - 119 0.01 0.02 8.90 - 75.5 0.03 - 0.14

Mean: 2.77 59.7 0.01 0.02 34.8 0.08

Sample Name	Sample Location	Soil Type	Contaminant Concentration (ng/L)					
			Vinyl Chloride	Total DCE	1,1-DCA	1,1,1-TCA	TCE	PCE
REFERENCE SAMPLING METHOD DATA								
ACTAG5A405.0	A4	Fine	100	5,544	50	50	355	50
ACTAG5B605.0	B6	Fine	275	4,773	50	50	1,222	50
ACTAG5C405.0	C4	Fine	100	8,745	50	50	545	50
ACTAG5D705.0	D7	Fine	8,265	17,865	50	50	6,253	50
ACTAG5E205.0	E2	Fine	100	3,175	50	50	132	50
ACTAG5F705.0	F7	Fine	4,889	21,028	50	50	2,710	50
ACTAG5G705.0	G7	Fine	100	8,734	50	50	2,867	50

Range: 100 - 8,270 3,180 - 21,000 50 50 132 - 6,250 50

Mean: 1,980 9,980 50 50 2,010 50

Notes:

Gore Data: Quantitation limits are listed in the last row of the table.

Reference Data: Values reported as 50 (or 100 for vinyl chloride) are actually non-detects at a detection limit of 50 ng/L (or 100 ng/L for vinyl chloride).

**TABLE A5. VOLATILE ORGANIC COMPOUND CONCENTRATIONS
FOR GORE AND REFERENCE DATA
SBA SITE - GRID 6**

Sample Name	Sample Location	Soil Type	Contaminant Concentration (ng/sample)					
			Vinyl Chloride	Total DCE	1,1-DCA	1,1,1-TCA	TCE	PCE
GORE SAMPLER DATA								
137583 - GORE	A1	Fine	1.77	0.02	0.01	0.02	0.02	0.03
137587 - GORE	B5	Fine	1.77	0.23	0.01	0.02	0.02	0.03
137585 - GORE	C3	Fine	1.77	0.02	0.01	0.02	0.02	0.03
137584 - GORE	D1	Fine	1.77	0.07	0.01	0.02	0.02	0.03
137586 - GORE	E4	Fine	1.77	0.06	0.01	0.02	0.02	0.03
137588 - GORE	F5	Fine	1.77	0.81	0.01	0.02	0.02	0.03
137592 - GORE	G6	Fine	1.77	0.06	0.01	0.02	0.02	0.03
Quantitation Limit	-	-	1.77	0.02	0.01	0.02	0.02	0.03

Range: 1.77 0.02 - 0.81 0.01 0.02 0.02 0.03

Mean: 1.77 0.18 0.01 0.02 0.02 0.03

Sample Name	Sample Location	Soil Type	Contaminant Concentration (ng/L)					
			Vinyl Chloride	Total DCE	1,1-DCA	1,1,1-TCA	TCE	PCE
REFERENCE SAMPLING METHOD DATA								
REFERENCE SAMPLES NOT ANALYZED IN THIS GRID								

Notes:

Gore Data: Quantitation limits are listed in the last row of the table.

**TABLE A6. VOLATILE ORGANIC COMPOUND CONCENTRATIONS
FOR GORE AND REFERENCE DATA
CSC SITE - GRID 1**

Sample Name	Sample Location	Soil Type	Contaminant Concentration (ng/sample)				
			Total DCE	1,1-DCA	1,1,1-TCA	TCE	PCE
GORE SAMPLER DATA							
137604 - GORE	A3	Coarse	188	0.01	32.6	271	404
137607 - GORE	B6	Coarse	100	0.01	32.3	208	417
137605 - GORE	C4	Coarse	175	0.12	46.1	284	433
137608 - GORE	D6	Coarse	96.0	0.13	50.3	214	405
137602 - GORE	E2	Coarse	228	0.16	28.4	287	413
137603 - GORE	F2	Coarse	239	0.01	40.0	282	397
137606 - GORE	G5	Coarse	242	0.15	38.4	243	405
Quantitation Limit	-	-	0.02	0.01	0.02	0.02	0.03

Range: 96.0 - 242 0.01 - 0.16 28.4 - 50.3 208 - 287 397 - 433

Mean: 181 0.08 38.3 255 411

Sample Name	Sample Location	Soil Type	Contaminant Concentration (ng/L)				
			Total DCE	1,1-DCA	1,1,1-TCA	TCE	PCE
REFERENCE SAMPLING METHOD DATA							
ACTCG1A505.0	A5	Coarse	7,242	500	7,526	26,349	249,342
ACTCG1B605.0	B6	Coarse	2,255	500	170,724	7,450	79,017
ACTCG1C405.0	C4	Coarse	21,311	500	670,474	77,382	769,940
ACTCG1D405.0	D4	Coarse	12,637	500	411,390	44,031	438,473
ACTCG1E205.0	E2	Coarse	19,039	500	478,451	54,857	480,887
ACTCG1F305.0	F3	Coarse	6,246	500	225,933	14,739	117,979
ACTCG1G605.0	G6	Coarse	6,683	500	236,256	67,632	170,967

Range: 2,260- 21,300 500 7,530 - 670,000 7,450 - 77,400 79,000 - 770,000

Mean: 10,800 500 314,000 41,800 330,000

Notes:

Gore Data: Quantitation limits are listed in the last row of the table.

Reference Data: Values reported as 500 are actually non-detects at a detection limit of 500 ng/L

**TABLE A7. VOLATILE ORGANIC COMPOUND CONCENTRATIONS
FOR GORE AND REFERENCE DATA
CSC SITE - GRID 2**

Sample Name	Sample Location	Soil Type	Contaminant Concentration (ng/sample)				
			Total DCE	1,1-DCA	1,1,1-TCA	TCE	PCE
GORE SAMPLER DATA							
137613 - GORE	A6	Coarse	88.7	0.01	32.4	327	343
137614 - GORE	B7	Coarse	96.2	0.01	33.9	335	351
137612 - GORE	C4	Coarse	101	0.01	41.9	330	357
137609 - GORE	D1	Coarse	81.9	0.01	43.8	299	328
137611 - GORE	E3	Coarse	80.9	0.01	31.9	296	307
137615 - GORE	F7	Coarse	115	0.01	40.5	331	367
137610 - GORE	G1	Coarse	102	0.01	38.8	308	332
Quantitation Limit	-	-	0.02	0.01	0.02	0.02	0.03

Range: 80.9 - 115 0.01 31.9 - 43.8 296 - 335 307 - 367

Mean: 95.2 0.01 37.6 318 341

Sample Name	Sample Location	Soil Type	Contaminant Concentration (ng/L)				
			Total DCE	1,1-DCA	1,1,1-TCA	TCE	PCE
REFERENCE SAMPLING METHOD DATA							
ACTCG2A405.0	A4	Coarse	500	500	33,875	11,353	31,950
ACTCG2B405.0	B4	Coarse	500	500	138,681	42,596	101,902
ACTCG2C505.0	C5	Coarse	942	500	219,486	76,171	201,050
ACTCG2D405.0	D4	Coarse	1,708	500	353,483	99,223	222,623
ACTCG2E105.0	E1	Coarse	2,694	500	413,456	123,487	288,770
ACTCG2F205.0	F2	Coarse	2,827	500	415,093	119,787	287,739
ACTCG2G405.0	G4	Coarse	3,780	500	439,087	153,683	427,089

Range: 500 - 3,780 500 33,900 - 439,000 11,400 - 154,000 32,000 - 427,000

Mean: 1,850 500 288,000 89,500 233,000

Notes:

Gore Data: Quantitation limits are listed in the last row of the table.

Reference Data: Values reported as 500 are actually non-detects at a detection limit of 500 ng/L

**TABLE A8. VOLATILE ORGANIC COMPOUND CONCENTRATIONS
FOR GORE AND REFERENCE DATA
CSC SITE - GRID 4**

Sample Name	Sample Location	Soil Type	Contaminant Concentration (ng/sample)				
			Total DCE	1,1-DCA	1,1,1-TCA	TCE	PCE
GORE SAMPLER DATA							
137616 - GORE	A1	Coarse	201	0.13	35.3	263	360
137618 - GORE	B4	Coarse	194	0.01	32.1	258	350
137619 - GORE	C5	Coarse	184	0.01	33.4	242	340
137620 - GORE	D7	Coarse	217	0.01	24.4	273	362
137617 - GORE	E3	Coarse	185	0.10	28.7	257	352
137621 - GORE	F7	Coarse	190	0.13	31.3	259	367
137622 - GORE	G7	Coarse	155	0.01	26.2	209	324
Quantitation Limit	-	-	0.02	0.01	0.02	0.02	0.03

Range: 155 - 217 0.01 - 0.13 24.4 - 35.3 209 - 273 324 - 367

Mean: 189 0.06 30.2 252 351

Sample Name	Sample Location	Soil Type	Contaminant Concentration (ng/L)				
			Total DCE	1,1-DCA	1,1,1-TCA	TCE	PCE
REFERENCE SAMPLING METHOD DATA							
ACTCG4A405.0	A4	Coarse	7,008	500	168,233	20,043	143,142
ACTCG4B305.0	B3	Coarse	500	500	19,627	1,881	20,753
ACTCG4C105.0	C1	Coarse	6,882	500	162,682	21,872	152,164
ACTCG4D605.0	D6	Coarse	3,964	500	115,537	15,855	129,093
ACTCG4E405.0	E4	Coarse	10,513	500	216,980	41,798	388,861
ACTCG4F105.0	F1	Coarse	6,650	500	123,393	21,178	194,826
ACTCG4G305.0	G3	Coarse	7,823	500	184,170	32,812	313,472

Range: 500 - 10,500 500 19,600 - 217,000 1,880 - 41,800 20,800 - 389,000

Mean: 6,190 500 142,000 22,200 192,000

Notes:

Gore Data: Quantitation limits are listed in the last row of the table.

Reference Data: Values reported as 500 are actually non-detects at a detection limit of 500 ng/L.

**TABLE A9. VOLATILE ORGANIC COMPOUND CONCENTRATIONS
FOR GORE AND REFERENCE DATA
CSC SITE - GRID 5**

Sample Name	Sample Location	Soil Type	Contaminant Concentration (ng/sample)				
			Total DCE	1,1-DCA	1,1,1-TCA	TCE	PCE
GORE SAMPLER DATA							
137626 - GORE	A5	Coarse	78.2	0.01	21.2	219	321
137624 - GORE	B2	Coarse	53.5	0.01	25.5	227	345
137627 - GORE	C6	Coarse	88.9	0.01	16.7	213	292
137625 - GORE	D3	Coarse	40.3	0.01	20.7	189	328
137628 - GORE	E7	Coarse	80.0	0.01	25.0	239	342
137629 - GORE	F7	Coarse	72.0	0.01	23.9	239	343
137623 - GORE	G1	Coarse	42.5	0.01	23.1	195	315
Quantitation Limit	-	-	0.02	0.01	0.02	0.02	0.03

Range: 40.3 - 88.9 0.01 16.7 - 25.5 189 - 239 292 - 345

Mean: 65.0 0.01 22.3 217 327

Sample Name	Sample Location	Soil Type	Contaminant Concentration (ng/L)				
			Total DCE	1,1-DCA	1,1,1-TCA	TCE	PCE
REFERENCE SAMPLING METHOD DATA							
ACTCG5A105.0	A1	Coarse	545	500	67,314	8,995	76,084
ACTCG5D505.0	D5	Coarse	744	500	78,631	12,097	99,169
ACTCG5E405.0	E4	Coarse	500	500	58,536	9,166	71,940
ACTCG5F105.0	F1	Coarse	500	500	12,571	2,429	24,812
ACTCG5G705.0	G7	Coarse	1,401	500	132,480	24,684	220,317

Range: 500 - 1,400 500 12,600 - 132,000 2,430 - 24,700 24,800 - 220,000

Mean: 738 500 69,900 11,500 98,500

Notes:

Gore Data: Quantitation limits are listed in the last row of the table.

Reference Data: Values reported as 500 are actually non-detects at a detection limit of 500 ng/L