

File No. 4-02-742-ST

10-2570

Alameda County

JUN 11 2003

Environmental Health

**PROPOSED WORK PLAN FOR PRELIMINARY  
SITE ASSESSMENT AT THE PROPERTY  
LOCATED AT 3800 SAN PABLO AVENUE  
EMERYVILLE, CALIFORNIA  
JUNE 4, 2003**

**PREPARED FOR:  
MR. FILMORE MARKS  
C/O MS. ELAINE KIRK  
MARKS MANAGEMENT COMPANY  
555 MONTGOMERY STREET, SUITE 1205  
SAN FRANCISCO, CALIFORNIA 94111**

**BY:  
ENVIRO SOIL TECH CONSULTANTS  
131 TULLY ROAD  
SAN JOSE, CALIFORNIA 95111**

**ENVIRO SOIL TECH CONSULTANTS**

**LIST OF FIGURES**

**FIGURE 1** ... Site Vicinity Map showing 3800 San Pablo Avenue,  
Emeryville, California

**FIGURE 2** ... Site Plan Showing Location of Building, Former UST  
Excavation Area, and Propose Boreholes/Monitoring Wells

**LIST OF APPENDICES**

**APPENDIX "A"** ... Figure 1 and Figure 2

**APPENDIX "B"** ... Standard Operation Procedures

**APPENDIX "C"** ... Outline of Drum Handling Procedures

**APPENDIX "D"** ... Health and Safety Plan

**APPENDIX "E"** ... Types of Protective Clothing and Respiration

**TABLE OF CONTENTS**

**Page No.**

<b>LETTER OF TRANSMITTAL</b>	1-2
<b>INTRODUCTION</b>	3
<b>GENERAL SITE DESCRIPTION</b>	3
<b>BACKGROUND</b>	4-5
<b>SCOPE OF WORK</b>	5-6
<b>METHODS AND PROCEDURES</b>	6
<i>TASK A - SITE HEALTH AND SAFETY PLAN</i>	6
<i>TASK B - OBTAIN PERMIT</i>	7
<i>TASK C - CONDUCT EXPLORATORY SOIL BORINGS</i>	7
<i>TASK D - INSTALL GROUNDWATER MONITORING WELLS</i>	7
<i>TASK E - DEVELOP, SAMPLE AND SURVEY MONITORING WELLS</i>	8
<i>TASK F - ANALYZED SOIL AND GROUNDWATER SAMPLES</i>	8
<i>TASK G - ANALYZED DATA AND LABORATORY RESULTS</i>	8
<i>TASK H - PREPARE REPORT</i>	9

**APPENDIX "A"**

<b>FIGURE 1 - VICINITY MAP</b>	M1
<b>FIGURE 2 - SITE MAP</b>	M2

**APPENDIX "B"**

DRILLING AND SOIL SAMPLING PROCEDURE	SOP1-SOP2
BORING LOG SHEET	SOP3
MONITORING WELL INSTALLATION	SOP4-SOP5
WELL DETAIL SHEET	SOP6
WELL DEVELOPMENT	SOP7
MONITORING WELL SURVEY SHEET	SOP8
GROUNDWATER SAMPLING	SOP9
FIELD MEASUREMENTS SHEET	SOP10
VOLUME OF WATER IN CASING OR HOLE	SOP11
CHAIN-OF-CUSTODY SHEET	SOP12
SAMPLE MANAGEMENT	SOP13- SOP18

**TABLE OF CONTENTS CONT'D**

**Page No.**

**APPENDIX "C"**

OUTLINE OF DRUM HANDLING PROCEDURES

ODH1-ODH5

**APPENDIX "D"**

HEALTH AND SAFETY PLAN

HSP1-HSP9

**APPENDIX "E"**

TYPES OF PROTECTIVE CLOTHING AND RESPIRATION

TPC1-TPC3

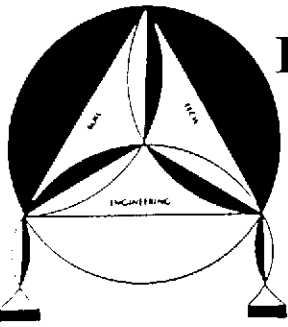

# ENVIRO SOIL TECH CONSULTANTS

Environmental & Geotechnical Consultants

131 TULLY ROAD, SAN JOSE, CALIFORNIA 95111

Tel: (408) 297-1500

Fax: (408) 292-2116

June 4, 2003

File No. 4-02-742-ST

**Mr. Fillmore Marks**

c/o Ms. Elaine Kirk

Marks Management Company

555 Montgomery Street, Suite 1205

San Francisco, California 94111

**SUBJECT: PROPOSED WORK PLAN FOR PRELIMINARY  
SITE ASSESSMENT AT THE PROPERTY**

Located at 3800 San Pablo Avenue, in  
Emeryville, California

Dear Ms. Kirk:

Per the request of Ms. Eva Chu with the Alameda County Health Care Services Agency (ACHCSA) in a letter dated April 15, 2003, the enclosed work plan for the above subject property has been prepared in accordance with State and Local Regulatory Agency requirements for fuel leak sites.

The work plan consists of the tasks required by the agencies in order to define the extent of contamination at the site.

Please submit the work plan to Alameda County Health Care Services Agency (ACHCSA).

If you have any questions or require additional information, please feel free to contact our office at (408) 297-1500

Sincerely,

**ENVIRO SOIL TECH CONSULTANTS**

  
FRANK HAMEDI-FARD  
GENERAL MANAGER

  
LAWRENCE KOO, P.E.  
C. E. #34928

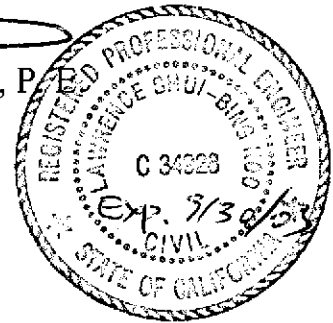

**PROPOSED WORK PLAN  
FOR PRELIMINARY SITE ASSESSMENT  
LOCATED AT 3800 SAN PABLO AVENUE  
EMERYVILLE, CALIFORNIA  
JUNE 4, 2003**

**INTRODUCTION:**

Alameda County Health Care Services Agency (ACHCSA) required this preliminary site assessment proposed work plan for the subject site.

Based on the results of soil sampling during underground storage tanks removal, there is evidence of dissolved petroleum hydrocarbons in the soil at the location of the formerly removed underground fuel storage tanks and the associated piping. After removal of USTs and associated piping, Enviro Soil Tech Consultants (ESTC) collected soil samples from former USTs areas. This work plan proposes a scope of work to delineate the extent of soil and possibly groundwater contamination at the site and describes future remediation activities.

**GENERAL SITE DESCRIPTION:**

The subject site is located at the northwest corner of San Pablo Avenue and West Mac Arthur Boulevard, in Emeryville, California (Figure 1). The site is occupied by MAZ Glass Company, a commercial and residential window retailer and installation company. The ground is relatively flat, and the properties surrounding are primarily light commercial businesses. Figure 2 shows the locations of the building, former fuel storage tanks and the proposed boreholes/monitoring wells.

## **BACKGROUND:**

On May 2, 2002, after the excavation and removal of one 550 gallon and one 1000 gallon heating oil USTs by Alpha Geo Services (AGS), five discrete soil samples were collected from beneath the excavated USTs area at the depth of approximately 7 feet below the surface by ESTC's field engineer.

Based on the odor and discoloration of the samples, Mr. Robert Weston with ACHCSA-EHS recommendation that over-excavate the tanks' pit areas and sample the over-excavation area. Therefore, the tanks' pits were over-excavated to the depths of 10 to 11 feet, and additional soil samples were collected.

The soil samples were analyzed for TPHg and TPHd per EPA Methods 5030/8015B; BTEX, MTBE and other fuel hydrocarbons oxygenates compounds (EPA Method 8260); Total Oil & Grease (TOG) per EPA Method 8015B; Semi-Volatile Organic Compounds (SVOC) per EPA Method 8270; PCB per EPA Method 8082; Creosote and five CAM metals.

Soil samples detected the maximum levels for TPHg at 440 milligram per kilogram (mg/Kg); TPHd at 280 mg/Kg; TOG at 304 mg/Kg; Ethylbenzene at 3200 microgram per kilogram ( $\mu\text{g}/\text{Kg}$ ); Total Xylenes at 480  $\mu\text{g}/\text{Kg}$ ; Cadmium at 1  $\mu\text{g}/\text{Kg}$ ; Chromium at 29  $\mu\text{g}/\text{Kg}$ ; Lead at 5.3  $\mu\text{g}/\text{Kg}$ ; Nickel at 54  $\mu\text{g}/\text{Kg}$  and Zinc at 47  $\mu\text{g}/\text{Kg}$ . Benzene, Toluene, MTBE, PNA, Creosote and SVOC were below laboratory detection limit in the soil samples.

Details of the above activities are described in ESTC's report entitled "Soil Sampling Beneath Removed UST from the Property...", dated June 11, 2002.



In addition, stockpiled soil was also sampled on April 15, 1991, to characterize the concentrations of TPHg for proper disposal.

Between May 13 and 15, 1991, AGS excavated gasoline-affected soil from the former tank area. All the excavation activities were performed under supervision of STE's staff engineer.

On May 2, 2002, Alpha Geo Services performed over-excavation on the tank pit areas under supervision of ESTC's staff engineer until no visible staining or odor was observed in the soil. The over-excavated soil was stockpiled on-site in the back of the building and was covered with visquine after completion of over-excavation activities for proper disposal.

Prior to soil disposal, stockpiled soil was sampled to characterize the soil for proper disposal to Allied Waste Companies (AW).

On June 7, 2002, after receiving authorization from AW, E. J. Pires Trucking under supervision of ESTC transported approximately 40 cubic yards of contaminated soil to AW's facility (Keller Canyon Sanitary Landfill) in Pittsburg, California, for proper disposal. The details of the above activities are described in ESTC's report entitled "Disposal of Stockpiled Soil from the Property...", dated June 17, 2002.

#### **SCOPE OF WORK:**

The scope of work is to delineate the extent of dissolved petroleum hydrocarbons in soil and possibly groundwater at the site and to determine an appropriate course of action to remediate the site, if deemed necessary. The proposed tasks are:

- A) Prepare a site Health and Safety Plan.
- B) Obtain the necessary drilling permit.

- C) Drill 5 exploratory borings around the former tanks areas in accordance with State and Local Regulatory Agency requirements.
- D) Convert three out five borings into groundwater monitoring wells.
- E) Develop, sample and survey the monitoring wells.
- F) Analyze the soil and groundwater samples for Total Petroleum Hydrocarbons as gasoline and diesel (TPHg and TPHd) per EPA Methods 5030/8015 and petroleum hydrocarbons constituents per EPA Method 8260B (such as BTEX, MTBE and other oxygenates).
- G) Analyze the field data and laboratory results.
- H) Prepare a technical report.

#### **METHODS AND PROCEDURES:**

The methods and procedures for drilling, installing and sampling of soil borings and groundwater are described in this section of the work plan. The preliminary investigation approach will be consistent with the (1) Regional Water Quality Control Board (RWQCB) "Tri-Regional Board Staff Recommendations for Preliminary Evaluation and Investigation of Underground Tank Sites" dated August 1990, (2) Alameda County Health Care Services Agency (ACHCSA) guidelines for such fuel tank sites, and (3) our Standard Operation Procedures (SOP) Appendix "B".

#### **TASK A. SITE HEALTH AND SAFETY PLAN:**

A site Health and Safety plan has been prepared and will be available on-site at the time the fieldwork is conducted. This plan is attached in Appendix "D".

TASK B. OBTAIN PERMIT:

Following this work plan approval by the state and local agencies, ESTC will acquire drilling permits, schedule field activities and locate underground utility lines prior to beginning fieldwork.

TASK C. CONDUCT EXPLORATORY SOIL BORINGS:

In order to assess the vertical and lateral extent of hydrocarbons at the site, five soil borings will be drilled to the depth of the groundwater encountered. The drilling procedures will be in accordance with ACHCSA and RWQCB guidelines as described in the attached Standard Operating Procedures (Appendix "B"). Soil samples will be collected from each boring at 5-foot intervals and at significant lithologic changes, using California split spoon sampler or brass sample sleeves. The samples recovered for chemical analysis will be retained in the sleeve, covered with aluminum foil and plastic caps, wrapped with tape, labeled and placed immediately into an iced cooler.

TASK D. INSTALL GROUNDWATER MONITORING WELLS:

Three out of five the exploratory borings will be converted into groundwater monitoring wells to depths of approximately 10 feet below the top of the saturated zone. The borings will be drilled using 8-inch diameter hollow-stem augers. Each monitoring well will be constructed of 2-inch diameter, clean, flush-threaded, Schedule 40 PVC blank and screened (0.020-inch slot size) casing, and the required filter pack. Well installation will follow the standard procedures and requirements of the RWQCB and ACHCSA (see Standard Operation Procedures in Appendix "B").

The top of each monitoring well will be secured with a watertight locking cap and utility box finished flush with the ground surface.

TASK E. DEVELOP, SAMPLE AND SURVEY MONITORING WELLS:

The monitoring wells will be properly developed, purged and sampled in accordance with applicable regulations and guidelines of the RWQCB and ACHCSA.

All wells will be surveyed as to location and elevation in referenced to an established benchmark to within 0.01 foot. Depth-to-water in each well will be measured from the top of the casing using an electronic sounder. Wells will be monitored prior to sampling for presence or absence of any sheen/odor.

TASK F. ANALYZED SOIL AND GROUNDWATER SAMPLES:

Soil and groundwater samples will be transported to a California certified laboratory for analysis, following proper chain-of-custody procedures. Soil and water samples will be analyzed for TPHg and TPHd using EPA Method 5030/8015 and petroleum hydrocarbons constituents (BTEX; MTBE and other oxygenates) using EPA Method 8260B.

TASK G. ANALYZED DATA AND LABORATORY RESULTS:

Upon completion of the soil and groundwater sample analysis, a detailed analysis of the results and available information will be compiled to define the extent and nature of hydrocarbons in the soil and/or groundwater at the site. This analysis will include interpretation of geologic and hydrogeologic information and assessment of the potential short- and long-term impacts of contamination on the beneficial uses of local ground and surface water.

TASK H. PREPARE REPORT:

A report presenting the results and findings of the exploratory soil borings and monitoring well installation, including the boring logs and laboratory reports will be prepared and submitted to Mr. Fillmore Marks and/or Ms. Elaine Kirk for review. Copies of this report should be submitted to CRWQCB and ACHCSA for their review and comments.

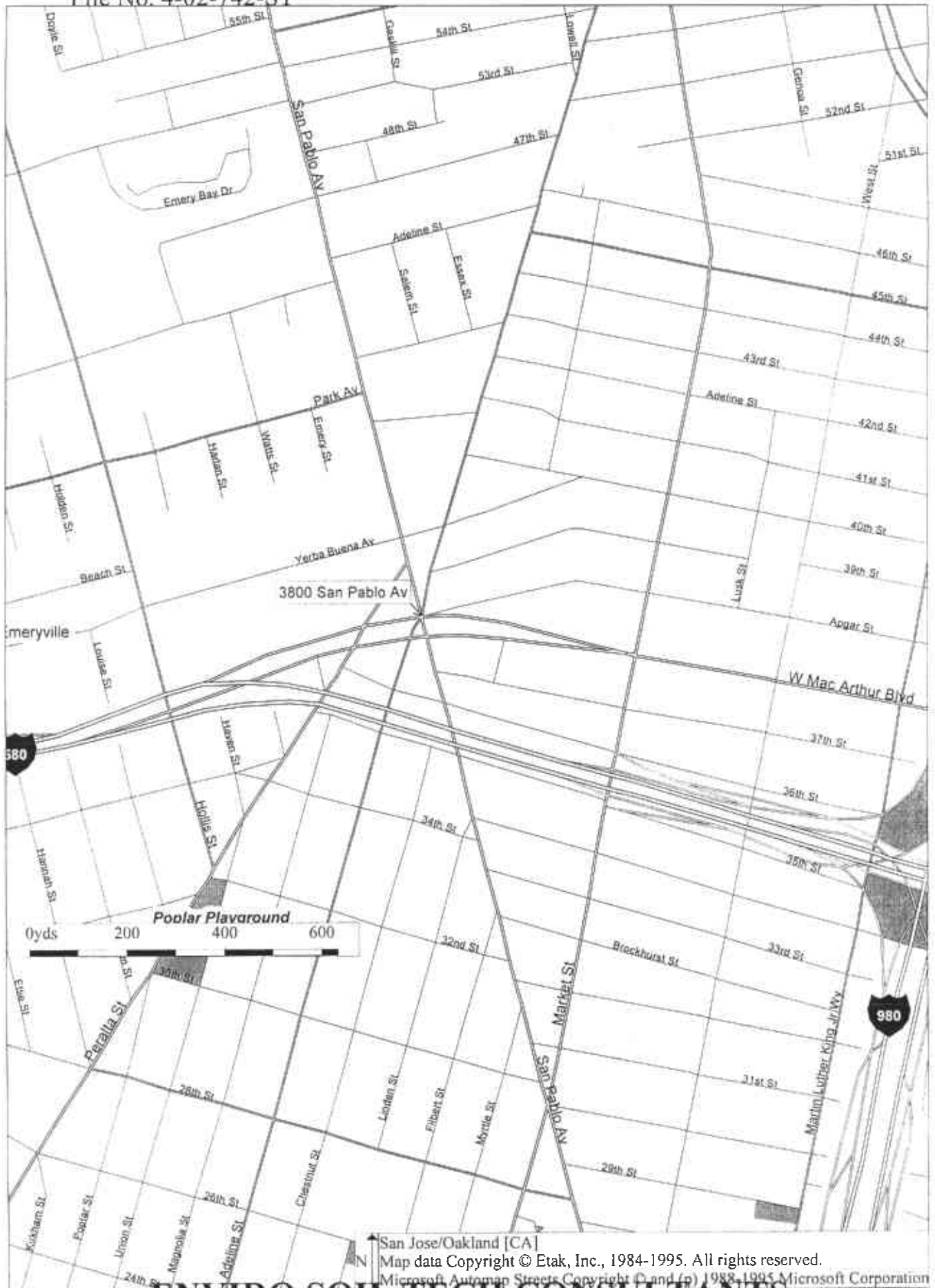

**ENVIRO SOIL TECH CONSULTANTS**

Figure 1

Rev.	Date	Description	By

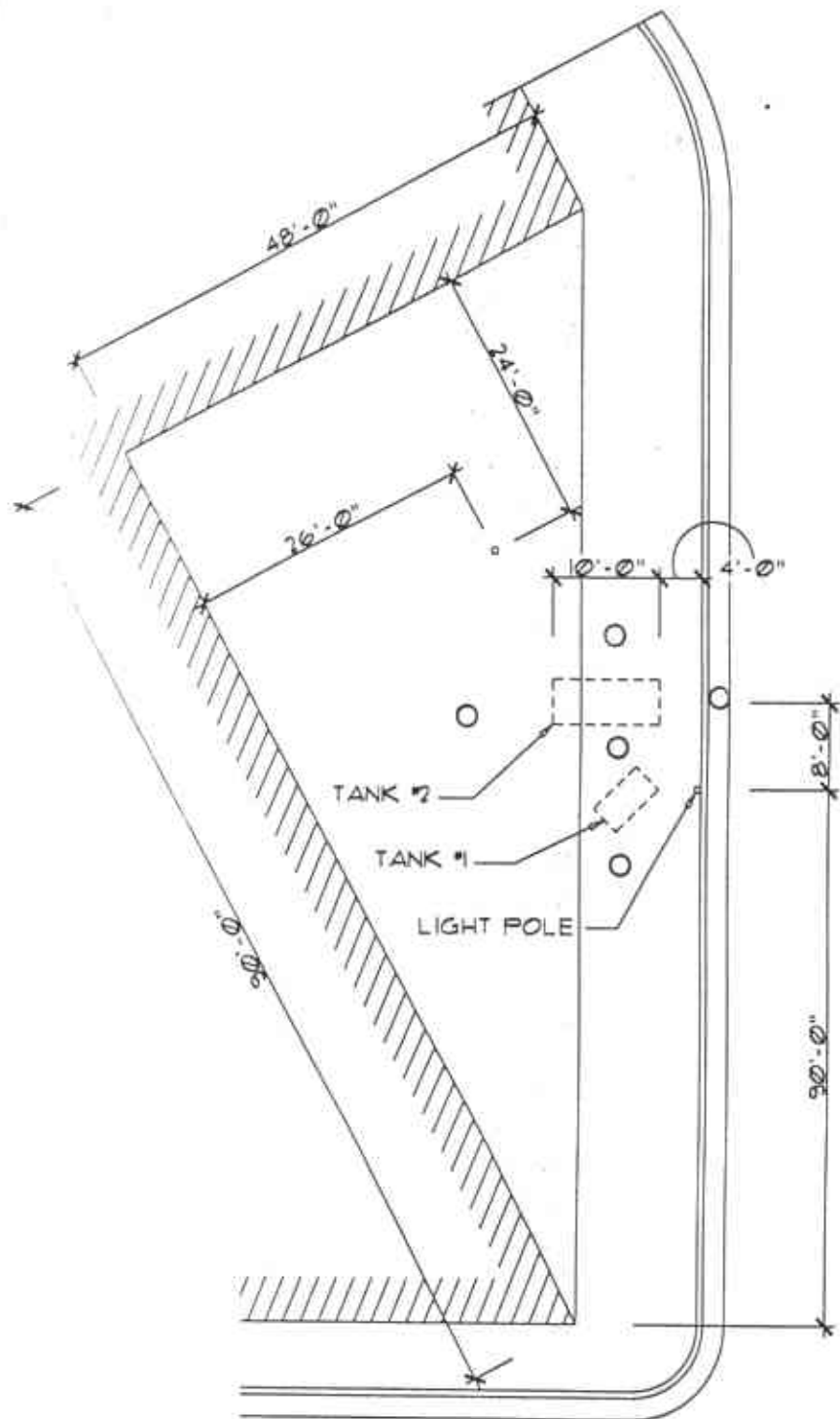

TANK No.	V g.	φ in.	L in.	D in.
1	550	36	67	24
2	1000	48	120	24

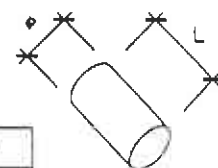

L = Length
D = Depth
g. = Gallons
V = Capacity
φ = Diameter

○ Proposed Borehole/Monitoring Well Location

**ENVIRO SOIL TECH CONSULTANTS**  
 ENVIRONMENTAL & GEOTECHNICAL CONSULTANTS

131, TULLY ROAD, SAN JOSE, CALIFORNIA, 95111  
 Tel : (408) 297-1500 FAX : (408) 292-2116

Job Title : 00000000000000000000

File No : 4-02-742-ST Drawn by : KB Sheet :  
 Date : 05/08/02 Checked by : FH

SK1

**A P P E N D I X "B"**



## **DRILLING AND SOIL SAMPLING PROCEDURE**

Mobile drill rig B-40L, using a continuous, solid-flight, hollow stem-auger will be used in drilling the soil borings to the desired depths.

Prior to drilling, all drilling equipment (auger, pin, drilling head) will be thoroughly steam-cleaned to minimize the possibility of cross-contamination and/or vertical migration of possible contaminants.

In addition, prior to obtaining each individual soil sample, all sampling tools, including the split-spoon sampler and brass liners will be thoroughly washed in a Tri-sodium Phosphate (TSP) solution followed by a rinse in distilled water.

During the drilling operation, relatively undisturbed soil samples will be taken from the required depth by forcing a 2-inch I.D. split-spoon sampler insert with a brass liner into the ground at various depths by means of a 140 lb. hammer falling 30-inches or by hydraulic forces.

The samplers will contain relatively undisturbed soil. In general, the first section of soil from the sampler (shoe) will be used in the field for lithologic inspection and evidence of contamination. The selected brass liner will be immediately trimmed, the ends of the brass liner will be covered tightly with aluminum foil and plastic caps, sealed with tape, labeled, placed in a plastic bag and stored in a cold ice chest in order to minimize the escape of any volatile present in the samples. Soil samples for analysis will then be sent to a state-certified hazardous waste laboratory accompanied by a chain-of-custody record.

Soil samples collected at each sampling interval will be inspected for possible contamination (odor or peculiar colors). Soil vapor concentrations will be measured in the field by using a Photoionization Detector (PID), Photovac Tip Air Analyzer. The soil sample will be sealed in a Zip-Loc plastic bag and placed in the sun to enhance volatilization of the hydrocarbons from the sample. The purpose of this field analysis is to qualitatively determine the presence or absence of hydrocarbons and to establish which soil samples will be analyzed at the laboratory. The data will be recorded on the drilling log at the depth corresponding to the sampling point.

Other soil samples may be collected to document the stratigraphy and estimate relative permeability of the subsurface materials.

Soil tailings that are obtained during drilling will be stored at the site, pending the analytical test results to determine proper disposal.



# ENVIRO SOIL TECH CONSULTANTS

Environmental & Geotechnical Consultants  
131 TULLY ROAD, SAN JOSE, CALIFORNIA 95111  
Tel. (408) 297-1500 Fax: (408) 292-2116

File No. \_\_\_\_\_

Date \_\_\_\_\_

By \_\_\_\_\_

Job \_\_\_\_\_

Site Description \_\_\_\_\_ (continued on reverse side)

Type of Drill Rig \_\_\_\_\_ Hole Diameter \_\_\_\_\_

(NOTE: WATER LEVEL, TIME, DATE AT END OF LOG, CAVING, ETC...)

Sample Quality	Blows/6-inch	Sample Loc. No.	Depth	Soil Classification	Penetrometer
			1		
			2		
			3		
			4		
			5		
			6		
			7		
			8		
			9		
			0		
			1		
			2		
			3		
			4		
			5		
			6		
			7		
			8		
			9		
			0		
			1		
			2		

## MONITORING WELL INSTALLATION

The boreholes for the monitoring wells were hand augered with a diameter of at least two inches larger than the casing outside diameter (O.D.).

The monitoring wells will be cased with threaded, factory-perforated and blank, schedule 40 PVC. The perforated interval consisted of slotted casing, generally 0.010 to 0.040 inch wide by 1.5-inch long slot size, with 42 slots per foot (slots which match formation grain size as determined by field grain-size distribution analysis). A PVC cap will be fastened to the bottom of the casing (no solvents, adhesive, or cements were used), the well casing will be thoroughly washed and steam-cleaned.

After setting the casing inside the borehole, kiln-dried sand or gravel-filter material will be poured into the annular space to fill from the bottom of the boring to two feet above the perforated interval. A one to two feet thick bentonite plug will be placed above this filter material to prevent grout from infiltrating down into the filter material. Approximately one to two gallons of distilled water will be added to hydrate the bentonite pellets. Then the well will be sealed from the top of the bentonite seal to the surface with concrete or neat cement containing about 5% bentonite (see Well Construction Detail).

To protect the well from vandalism and surface water contamination, Christy box with a special type of Allen screw will be installed around the wellhead, (for wells in parking lots, driveways and building areas). Steel stove pipes with padlocks will be usually set over wellheads in landscaped areas.

In general, groundwater monitoring wells extend to the base of the upper aquifer, as defined by the consistent (less than 5 feet thick) clay layer below the upper aquifer, or at least 10 to 15 feet below the top of the upper aquifer, whichever is shallower. The wells do not extend through the laterally extensive clay layer below the upper aquifer. The wells are terminated one to two feet into such a clay layer.

# WELL DETAILS

PROJECT NAME: \_\_\_\_\_

BORING/WELL NO. \_\_\_\_\_

PROJECT NUMBER: \_\_\_\_\_

CASING ELEVATION: \_\_\_\_\_

WELL PERMIT NO.: \_\_\_\_\_

SURFACE ELEVATION: \_\_\_\_\_

G-5 Vault Box

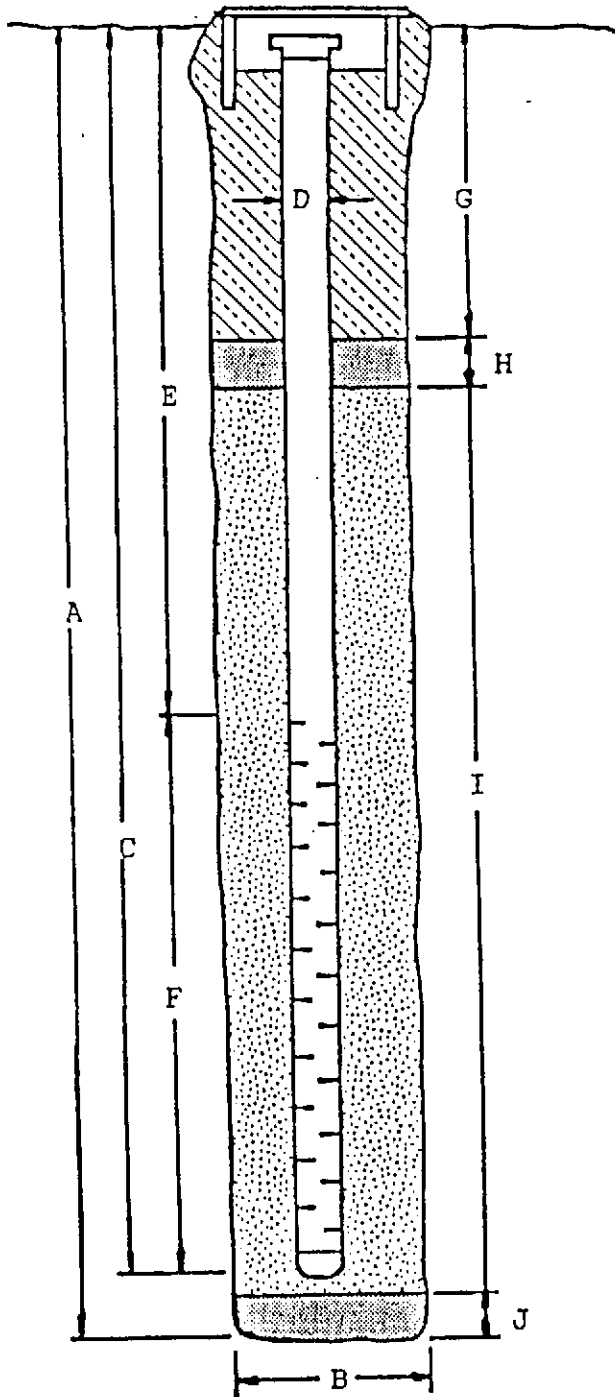

A. Total Depth: \_\_\_\_\_

B. Boring Diameter: \_\_\_\_\_

Drilling method: \_\_\_\_\_

C. Casing Length: \_\_\_\_\_

Material: \_\_\_\_\_

D. Casing Diameter: \_\_\_\_\_

E. Depth to Perforations: \_\_\_\_\_

F. Perforated Length: \_\_\_\_\_

Perforated Interval: \_\_\_\_\_

Perforation Type: \_\_\_\_\_

Perforation Size: \_\_\_\_\_

G. Surface Seal: \_\_\_\_\_

Seal Material: \_\_\_\_\_

H. Seal: \_\_\_\_\_

Seal Material: \_\_\_\_\_

I. Gravel Pack: \_\_\_\_\_

Pack Material: \_\_\_\_\_

Size: \_\_\_\_\_

J. Bottom Seal: \_\_\_\_\_

Seal Material: \_\_\_\_\_

## WELL DEVELOPMENT

For all newly installed groundwater monitoring wells, the well casing, filter pack and adjacent formations were cleared of disturbed sediment and water.

Well development techniques including pumping, bailing, surging, swabbing, jetting, flushing or air lifting by using a stainless steel or Teflon bailer, a submersible stainless steel pump, or air lift pump. The well development will continued until the discharged water appeared to be relatively free of all turbidity.

All water and sediment generated by well development will be collected in 55-gallon steel drums (Department of Transportation approved), closed head (17-H) for temporarily storage, and then will be disposed of properly, depending on analytical results.

to assure that cross-contamination did not occur between wells, all well development tools will be steam-cleaned or thoroughly washed in a Trisodium Phosphate (TSP) solution followed by a rinse in distilled water before each well development.

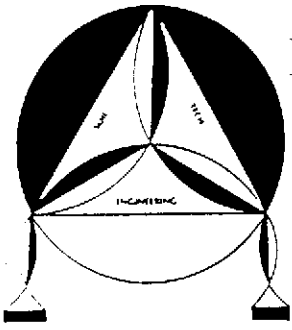

# ENVIRO SOIL TECH CONSULTANTS

Environmental & Geotechnical Consultants

131 TULLY ROAD, SAN JOSE, CALIFORNIA 95111

Tel: (408) 297-1500

Fax: (408) 292-2116

## MONITORING WELL SURVEY SHEET

NAME: \_\_\_\_\_

DATE: \_\_\_\_\_

FACILITY NAME & ADDRESS: \_\_\_\_\_

PROJECT NO.: \_\_\_\_\_

### FIELD ACTIVITIES

<u>WELL NO.</u>	<u>ROD READING</u>	<u>RIM ELEVATION</u>	<u>WATER ELEVATION</u>
_____	_____	_____	_____
_____	_____	_____	_____
_____	_____	_____	_____
_____	_____	_____	_____
_____	_____	_____	_____
_____	_____	_____	_____
_____	_____	_____	_____
_____	_____	_____	_____
_____	_____	_____	_____
_____	_____	_____	_____

WARNING: HAVE YOU SURVEYED ALL WELLS? LOCATED ALL WELLS?

HAVE YOU CHECKED FOR AND SURVEYED EXISTING MONITORING WELLS ON ADJACENT PROPERTIES OR PROPERTIES ACROSS THE STREET?

DO WE HAVE ACCURATE SKETCHES AT 1"=30' (AND 1"=100' IF NECESSARY)? IF NOT, MAKE THEM.



## **GROUNDWATER SAMPLING**

Prior to collection of groundwater samples, all of the sampling equipment (i.e. bailer, cables, bladder pump, discharge lines and etc...) will be cleaned by pumping TSP water solution followed by distilled water.

Prior to purging, the well "Water Sampling Field Survey Forms" will be filled out (depth to water and total depth of water column will be measured and recorded). The well then will be bailed or pumped to remove four to ten well volumes or until the discharged water temperature, conductivity and pH stabilized. "Stabilized" is defined as three consecutive readings within 15% of one another.

The groundwater sample will be collected when the water level in the well recovered to 80% of its static level.

Forty milliliter (ml.) glass volatile organic analysis (VOA) vials with Teflon septa will be used as sample containers. The groundwater sample will be decanted into each VOA vial in such a manner that there will be a meniscus at the top. The cap quickly will be placed over the top of the vial and securely tightened. The VOA vial will then be inverted and tapped to see if air bubbles is present. If none is present, then the sample will be labeled and refrigerated for delivery under chain-of-custody to the laboratory. The label information should include a sample identification number, job identification number, date, time, type of analysis requested and the sampler's name.

# ENVIRO SOIL TECH CONSULTANTS

Environmental & Geotechnical Consultants

131 TULLY ROAD, SAN JOSE, CALIFORNIA 95111

Tel: (408) 297-1500

Fax: (408) 292-2116

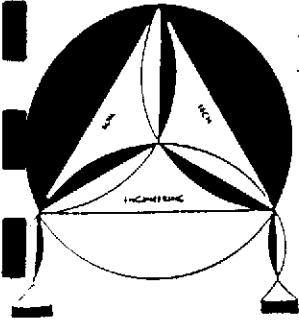

FILE NO.: \_\_\_\_\_

WELL NO.: \_\_\_\_\_

DATE: \_\_\_\_\_

SAMPLER: \_\_\_\_\_

DEPTH TO WELL: \_\_\_\_\_

1 WELL VOLUME: \_\_\_\_\_

DEPTH TO WATER: \_\_\_\_\_

5 WELL VOLUME: \_\_\_\_\_

HEIGHT OF WATER COLUMN: \_\_\_\_\_

ACTUAL PURGED VOLUME: \_\_\_\_\_

CASING DIAMETER: \_\_\_\_\_ 2"

\_\_\_\_\_ 4"

## CALCULATIONS:

2" x 0.1632 \_\_\_\_\_

4" x 0.653 \_\_\_\_\_

PURGE METHOD: \_\_\_\_\_ BAILER \_\_\_\_\_ DISPLACEMENT PUMP \_\_\_\_\_ OTHER

SAMPLE METHOD: \_\_\_\_\_ BAILER \_\_\_\_\_ OTHER

SHEEN: \_\_\_\_\_ NO \_\_\_\_\_ YES, DESCRIBE: \_\_\_\_\_

ODOR: \_\_\_\_\_ NO \_\_\_\_\_ YES, DESCRIBE: \_\_\_\_\_

## FIELD MEASUREMENTS

<u>TIME</u>	<u>VOLUME</u>	<u>Ph</u>	<u>TEMP.</u>	<u>E.C.</u>
_____	_____	_____	_____	_____
_____	_____	_____	_____	_____
_____	_____	_____	_____	_____
_____	_____	_____	_____	_____
_____	_____	_____	_____	_____

FILE NO.: \_\_\_\_\_

WELL NO.: \_\_\_\_\_

DATE: \_\_\_\_\_

SAMPLER: \_\_\_\_\_

DEPTH TO WELL: \_\_\_\_\_

1 WELL VOLUME: \_\_\_\_\_

DEPTH TO WATER: \_\_\_\_\_

5 WELL VOLUME: \_\_\_\_\_

HEIGHT OF WATER COLUMN: \_\_\_\_\_

ACTUAL PURGED VOLUME: \_\_\_\_\_

CASING DIAMETER: \_\_\_\_\_ 2"

\_\_\_\_\_ 4"

CALCULATIONS:

2" x 0.1632 \_\_\_\_\_

4" x 0.653 \_\_\_\_\_

PURGE METHOD: \_\_\_\_\_ BAILER \_\_\_\_\_ DISPLACEMENT PUMP \_\_\_\_\_ OTHER

SAMPLE METHOD: \_\_\_\_\_ BAILER \_\_\_\_\_ OTHER

SHEEN: \_\_\_\_\_ NO \_\_\_\_\_ YES, DESCRIBE: \_\_\_\_\_

ODOR: \_\_\_\_\_ NO \_\_\_\_\_ YES, DESCRIBE: \_\_\_\_\_

FIELD MEASUREMENTS

<u>TIME</u>	<u>VOLUME</u>	<u>Ph</u>	<u>TEMP.</u>	<u>E.C.</u>
_____	_____	_____	_____	_____
_____	_____	_____	_____	_____
_____	_____	_____	_____	_____
_____	_____	_____	_____	_____
_____	_____	_____	_____	_____

SOP10



## SAMPLE MANAGEMENT

### Sample Type: Soil, Oil, Solvents, Polids, Highly Contaminated Liquid (c)

<u>General Composition</u>	<u>Sample Volume</u>	<u>Sample Container</u>	<u>Preservative</u>	<u>Holding Time</u> (recommended/regulatory)
Weak Acids and Bases		plastic or glass		
Photosensitive materials		amber glass		
Volatile Organic		40 ml glass vial with TFE lined septum		
Non-Volatile Organic		glass with TFE lined cap		
<u>Measurement - General Chemical Categories, Inorganic</u>				
Inorganic, general		plastic or glass		
Metals, total		plastic or glass		
<u>Measurement - General Chemical Categories, Organic</u>				
Acid extractables		glass with TFE lined cap		
Base/neutral extractables		glass with TFE lined cap		
<u>Measurement Specified Chemicals - Inorganic</u>				
Hydrofluoric Acid		plastic		
Phosphoric acid		plastic		

## SAMPLE MANAGEMENT

### Sample Type: Waste

<u>General Composition</u>	<u>Sample Volume</u>	<u>Sample Container</u>	<u>Preservative</u>	<u>Holding Time (d)</u> (recommended/regulatory)
<b><u>Measurement - Specific Chemicals, Inorganic</u></b>				
Ammonia			add 1 ml conc H <sub>3</sub> PO <sub>4</sub>	24 Hrs.
Arsenic			add 6 ml conc HNO <sub>3</sub> /L	6 months
Chlorine			cool 4°C	24 Hrs.
Chromium VI			add 6 ml conc H <sub>2</sub> SO <sub>4</sub> /L	24 Hrs.
Cyanide, total			add 2.5 ml of 50% NaOH/L, cool 4°C	24 Hrs.
Fluoride			cool 4°C	7 days
Mercury, total			add 5 ml conc HNO <sub>3</sub> /L	38 days
Mercury, dissolved			filter, add 5 ml conc HNO <sub>3</sub> /L	38 days
Selenium			add 5 ml conc HNO <sub>3</sub> /L	6 months
Sulfide			add 2 ml conc HCl/1	24 Hrs.
Zinc			add 2 ml conc HCl/1	-

### Sample Type: Soil, Oil, Solvents, Solids, Highly Contaminated Liquids (c)

Strong acids, pH<2	glass
Strong bases, pH>12.5	plastic

## SAMPLE MANAGEMENT

### Sample Type: Water and Wastewater

<u>General Composition</u>	<u>Sample Volume</u>	<u>Sample Container</u>	<u>Preservative</u>	<u>Holding Time (d)</u> (recommended/regulatory)
Sulfate	50 ml	plastic or glass	cool 4°C	7 days/28 days
Sulfide	500 ml	plastic or glass	cool 4°C, add 4 drops 2N Zn acetate/100 ml	24 Hrs./28 days
Sulfite	50 ml	plastic or glass	determine on site	No Holding
<u>Measurement - Specific Chemicals, Organic</u>				
NTA	50 ml	plastic or glass waterline & center	cool 4°C	24 Hrs.
<u>Measurement - Physical Properties</u>				
Acidity			cool 4°C	24 Hrs.
Alkalinity			cool 4°C	24 Hrs.
pH			determine on site cool 4°C	6 Hrs.
<u>Measurement - General Chemical Categories, Inorganic</u>				
Metals, dissolved			filter on site, add 5 ml conc HNO <sub>3</sub> /L	6 months
Metals, total			add 5 ml conc HNO <sub>3</sub> /L	6 months
<u>Measurement - General Chemical Categories, Organic</u>				
Phenolics			add H <sub>3</sub> PO <sub>4</sub> to pH 4 & 1 g CuSO <sub>4</sub> /L, cool 4°C	24 Hrs.

## SAMPLE MANAGEMENT

### Sample Type: Water and Wastewater

<u>General Composition</u>	<u>Sample Volume</u>	<u>Sample Container</u>	<u>Preservative</u>	<u>Holding Time (d)</u> (recommended/regulatory)
<b><u>Measurements - Specific Chemicals, Inorganic</u></b>				
Ammonium	500 ml	plastic or glass	cool 4°C, add H <sub>2</sub> SO <sub>4</sub> to pH<2	24 Hrs./28 days
Boron	100 ml	plastic	None Required	28 days/28 days
Chlorine	200 ml	plastic or glass	determine on site	No Holding
Chromium VI	300 ml	plastic or glass, rinse with 1:1 HNO <sub>3</sub>	cool 4°C	24 Hrs./28 days
Cyanide, total	500 ml	plastic or glass add NaOH to pH>12	cool 4°C, dark	24 Hrs./14 days
Cyanide, amenable to chlorination	50 ml	plastic or glass	add 100 mg NaS <sub>2</sub> O <sub>3</sub>	
Fluoride	300 ml	plastic	None Required	7 days/28 days
Iodide	100 ml	plastic or glass	cool 4°C	24 Hrs./-
Iodine	500 ml	plastic or glass	determine on site	½ Hr./-
Mercury, total	500 ml	plastic or glass rinsed with 1:1 HNO <sub>3</sub>	cool 4°C add HNO <sub>3</sub> to pH<2	28 days/28 days
Mercury, dissolved	100 ml	plastic or glass	filter on site add HNO <sub>3</sub> to pH<1	glass: 38 days hard plastic: 13 days
Nitrate	100 ml	plastic or glass	cool 4°C add H <sub>2</sub> SO <sub>4</sub> to pH<2	24 Hrs./48 Hrs.
Nitrate & nitrate	200 ml	plastic or glass	cool 4°C add H <sub>2</sub> SO <sub>4</sub>	24 Hrs./28 days
Nitrate	100 ml	plastic or glass	cool 4° C or freeze	



## SAMPLE MANAGEMENT

### Sample Type: Water and Wastewater

<u>General Composition</u>	<u>Sample Volume</u>	<u>Sample Container</u>	<u>Preservative</u>	<u>Holding Time (d)</u> (recommended/regulatory)
<u>Measurements - General Chemical, Organic</u>				
Acid extractables		2 liter glass with TFE lined cap		
Base/neutral extractable		2 liter glass with TFE lined cap		
MBA's	250 ml	plastic or glass	cool 4°C	24 Hrs.
Oil and Grease	1000 ml	glass, wide mouthed, calibrated	cool 4°C H <sub>2</sub> SO <sub>4</sub> to pH<2	24 Hrs./28 days
Organic		glass rinsed with organic solvents, TFE cap		
Phenolics	500 ml	glass		24 Hrs./28 days
Purgeables by purge and trap	50 ml	glass with TFE cap		

## SAMPLE MANAGEMENT

### Sample Type: Water and Wastewater (a, b, c)

<u>General Composition</u>	<u>Sample Volume</u>	<u>Sample Container</u>	<u>Preservative</u>	<u>Holding Time (d)</u> (recommended/regulatory)
Non-Volatile Organic		2 liter glass with TFE with lined cap		
Photosensitive materials		1 liter amber glass		
Volatile Organic		40 ml glass vial with TFE lined cap (collect in duplicate)		
Volatile	100 ml	plastic or glass	cool 4°C	7 days
<b><u>Measurement - Physical Properties</u></b>				
Acidity	100 ml	plastic or borosilicate glass	cool 4°C	24 Hrs./14 days
Alkalinity	200 ml	plastic or glass	cool 4°C	24 Hrs./14 days
pH	25 ml	plastic or glass	determine on site	2 Hrs./2 Hrs.
Temperature	1000 ml	plastic or glass	determine on site	No Holding
<b><u>Measurement - General Chemical Categories, Inorganic</u></b>				
Metals, dissolved	200 ml	plastic(g) or glass	filter on site (f)	6 months (e)
Metals, total	100 ml	plastic (g) or glass rinsed with 1:1 HNO <sub>3</sub>	HNO <sub>3</sub> to pH<2 (g)	6 months/6 months (e)

File No. 4-02-742-ST

**A P P E N D I X "C"**

**ENVIRO SOIL TECH CONSULTANTS**

**OUTLINE OF DRUM HANDLING PROCEDURES  
FOR THE PROPERTY  
LOCATED AT 3800 SAN PABLO AVENUE  
EMERYVILLE, CALIFORNIA**

1. Test material per site-specific test requirements.
2. Classify Material as : Clean/Non-Hazardous.
3. Labeling of Drums:
  - \* Pending Label: Used to describe material pending final analytical testing. Labels must be immediately affixed to drum during field work.
  - \* Non-Hazardous Label: Required within 24 hours after analytical results are received.
  - \* Hazardous Label: Required within 24 hours after analytical results are received.
  - \* For Pick-Up Label: Must be affixed to drum prior to arranged pick-up date by certified hauler.
4. Remove within 21 days of generation. Empty drums, where material was disposed in bulk, must be removed the same day they are emptied.
5. Disposal of Material:
  - \* Clean: Any local landfill.
  - \* Non-Hazardous: Class III Landfill.
  - \* Hazardous: Class I landfill.
6. Manifests may be signed by the on-site contractor or consultant, owner, or other authorized representatives. The transporter should not sign the manifest.

It is the responsibility of the contractor, consultant and owner to arrange for a person to sign the manifest on the day of pick-up.

7. Reporting:

Reports shall include the following:

- \* Completed soil and water work sheets.
- \* Copy of the analytical results.
- \* State how and where material was disposed.
- \* If drums are emptied and material was disposed of in bulk, state how empty drums were handled.
- \* The signed blue and yellow copies of the hazardous waste manifest.

**SOIL:**

1. Test Requirements and Methods: Per STE site-specific test requirements.

- \* TPH: EPA Method 8015.
- \* BTEX: EPA Method 8020.
- \* TOG: 503 D&E.
- \* Lead:
  - Total Lead - EPA Method 7421.
  - Inorganic (soluble) Lead: DOS Title 22, Waste Extraction Test, 22-66700.
  - Organic - EPA Method 8240.
- \* Ignitable:

2. Classification:

- \* Clean: TPH, BTEX, TOG, VOC and non-detectable (<100 ppm).
- \* Non-Hazardous if any are true:
  - TPH less than 1,000 ppm.
  - Lead - Inorganic (soluble) Lead less than 5 ppm (STLC) or less than 100 ppm (TTLC).
    - Organic Lead less than 13 ppm (TTLC).
- \* Hazardous if any are true:
  - TPH greater than 1,000 ppm.
  - Lead - Inorganic (soluble) Lead greater than 5 ppm (STLC) or greater than 1,000 ppm (TTLC).
    - Organic Lead greater than 13 ppm (TTLC).
  - Ignitable - If TPH>1,000 ppm, then conduct Bunsen Burner Test.
    - If soil burns vigorously and persistently soils are RCRA D001.
- \* VOC - less than 1,000 ppm.

3. Responsibility for Disposal:

- \* Clean: Consultant, contractor or owner.
- \* Non-Hazardous: Consultant, contractor or owner.

4. Types of Drums: DOT-17H for a solid, solidified, or sludge material.

5. Disposal Facility:

- \* Clean: Any local landfill.
- \* Non-Hazardous: Class III or II landfill.

- \* Hazardous: Class I landfill.

**WATER:**

1. Test Requirements and Methods: Per site-specific test requirements.
  - \* TPH: EPA Method 8015.
  - \* BTEX: EPA Method 602.
2. Classification:
  - \* Clean Water: TPH and BTEX non-detectable.
  - \* Hazardous:
    - Water with dissolved product and detectable TPH and BTEX.
    - Water with free product.
    - Free product only.
3. Responsibility for Disposal:
  - \* Clean: Consultant/Contractor.
  - \* Non-Hazardous: Consultant, contractor or owner.
4. Types of Drums: DOT-17C or DOT-17E for liquid or slurry.
5. Disposal Facility:
  - \* Clean Water: Into sanitary sewer per Local Sewer District approval or into storm sewer with proper approval from Water Board.
  - \* Non-Hazardous:
    - Water with TPH and BTEX only.

File No. 4-02-742-ST

- Water with free product.
- Arrange certified waste hauler to pick and dispose.
- \* Hazardous:
  - Free product only.
  - Arrange disposal by a certified hazardous waste hauler.

**ENVIRO SOIL TECH CONSULTANTS**

ODH5



File No. 4-02-742-ST

**A P P E N D I X "D"**

**ENVIRO SOIL TECH CONSULTANTS**

**HEALTH AND SAFETY PLAN  
FOR THE PROPERTY  
LOCATED AT 3800 SAN PABLO AVENUE  
EMERYVILLE, CALIFORNIA**

**GENERAL:**

This Health and Safety Plan (HSP) contains the minimum requirements for the subject site field work. The field activities include drilling, soil sampling and/or water sampling. All personnel and contractors will be required to strictly adhere with this HSP requirements.

The objective of the HSP plan is describe procedures and actions to protect the worker, as well as unauthorized person, from inhalation and ingestion of and direct skin contact with potentially hazardous materials that may be encountered at the site. The plan describes (1) personnel responsibilities and (2) protective equipment to be used as deemed when working on the site. At a minimum, all personnel working at the site must read and understand the requirements of this HSP. A copy of this HSP will be on-site easily accessible to all staff and government field representatives.

**HAZARD ASSESSMENT:**

The major contaminants expected to be encountered on the project are gasoline and its hydrocarbon constituents. The anticipated contaminants and their exposure standards are listed in Table 1. It is not anticipated that the potential levels of exposure

will reach the permissible exposure limits (PEL) or threshold limit values (TLV). Inhalation and dermal contact are the potential exposure pathways. Protective clothing will be mandatory for field personnel specified in this Plan. In addition, respiratory protective devices are required to be worn by each person on-site or to be within easy reach should irritating odors be detected or irritation of the respiratory tract occur.

**TABLE 1  
EXPOSURE LIMITS OF ANTICIPATED CHEMICAL CONTAMINANTS  
IN PARTS PER MILLION (ppm)**

Contaminant	PEL	EL	ED	CL	TWA	STEL
Benzene*[skin] & [carc]	1	---	-----	---	10	5
Ethylbenzene	100	---	-----	---	100	125
Toluene [skin]	100	200	10 min per 8 hours	500	100	150
Xylene (o, m & p isomers) [skin]	100	200	30 min per 8 hours	300	100	150

PEL - permissible exposure limit: 8 hours, time-weighted average, California Occupational Safety and Health Administration Standard (CAL-OSHA).

EL - excursion limit: maximum concentration of an airborne contaminant to which an employee may be exposed without regard to duration provided the 8 hours time-weighted average for PEL is not exceeded (CAL-OSHA).

ED - excursion duration: maximum time period permitted for an exposure above the excursion limit but not exceeding the ceiling limit (CAL-OSHA).

- CL - Ceiling limit: maximum concentration of airborne contaminant which employees may be exposed permitted (CAL-OSHA).
- TWA - time-weighted average: 8 hours, [same as threshold limit value (TLV)], American Conference of Governmental Industrial Hygienists (ACGIH).
- STEL - Short-term exposure limit: 15 minutes time-weighted average (ACGIH).
- [carc] - substance identified as a suspected or confirmed carcinogen.
- [skin] - substance may be absorbed into the bloodstream through the skin, mucous membranes or eyes.
- \* - Federal OSHA Benzene limits given for PEL and STEL; STEL has a 50 minutes duration limit.

A brief description of the physical characteristics, incompatibilities, toxic effects, routes of entry and target organs has been summarized from the NIOSH Pocket Guide to Chemical Hazards for the contaminants anticipated to be encountered. This information is used in on-site safety meetings to alert personnel to the hazards associated with the expected contaminants.

**Benzene:**

Benzene is a colorless, aromatic liquid. Benzene may create an explosion hazard. Benzene is incompatible with strong oxidizers, chlorine and bromine with iron. Benzene is irritating to the eyes, nose and respiratory system. Prolonged exposure may result in giddiness, headache, nausea, staggering gait, fatigue, bone marrow depression or abdominal pain. Routes of entry include inhalation, absorption, ingestion and skin or eye contact. The target organs are blood, the central nervous system (CNS), skin, bone marrow, eyes and respiratory system. Benzene is carcinogenic.

**Ethylbenzene:**

Ethylbenzene is a colorless, aromatic liquid. Ethylbenzene may create an explosion hazard. Ethylbenzene is incompatible with strong oxidizers. Ethylbenzene is irritating to the eyes and mucous membranes. Prolonged exposure may result in headache, dermatitis, narcosis or coma. Routes of entry include inhalation, ingestion and skin or eye contact. The target organs are the eyes, upper respiratory system, skin and the CNS.

**Toluene:**

Toluene is a colorless, aromatic liquid. Toluene may create an explosion hazard. Toluene is incompatible with strong oxidizers. Prolonged exposure may result in fatigue, confusion, euphoria, dizziness, headache, dilation of pupils, lacrimation, insomnia, dermatitis or photophobia. Routes of entry are inhalation, absorption, ingestion and skin or eye contact. The target organs are the CNS, liver, kidneys and skin.

**Xylene Isomers:**

Xylene is a colorless, aromatic liquid. Xylene may create an explosion hazard. Xylene is incompatible with strong oxidizers. Xylene is irritating to the eyes, nose and throat. Prolonged exposure may result in dizziness, excitement, drowsiness, staggering gait, corneal vacuolization, vomiting, abdominal pain or dermatitis. Routes of entry are inhalation, absorption, ingestion and skin or eye contact. The target organs are the CNS, eyes, gastrointestinal tract, blood, liver, kidneys and skin.

**GENERAL PROJECT SAFETY RESPONSIBILITIES:**

Key personnel directly involved in the investigation will be responsible for monitoring the implementation of safe work practices and the provisions of this plan are (1) the drilling project supervisor and (2) Enviro Soil Tech Consultants (*ESTC*) project field engineer. These personnel are responsible for knowing the provisions of the plan, communicating plan requirements to workers under their supervision and regulatory agencies inspectors and for enforcing the plan.

The personnel-protective equipment will be selected to prevent field personnel from exposure to fuel hydrocarbons that may be present at the site. To prevent direct skin contact, the following protective clothing will be worn as appropriate while working at the site:

1. Tyvek coveralls.
2. Butyl rubber or disposable vinyl gloves.
3. Hard hat with optional face shield.
4. Steel toe boots.
5. Goggles or safety glasses.

The type of gloves used will be determined by the type of work being performed. Drilling personnel will be required to wear butyl rubber gloves because they may have long duration contact with the subsurface materials. *ESTC* sampling staff will wear disposable gloves when handling any sample. These gloves will be changed between each sample.

Personnel protective equipment shall be put on before entering the immediate work area. The sleeves of the overalls shall be outside of the cuffs of the gloves to facilitate removal of clothing with the least potential contamination of personnel. If at any time protective clothing (coveralls, boots and gloves) become torn, wet or excessively soiled, it will be replaced immediately.

Total organic vapors will be monitored at the site with a portable PID. should the total organic vapor content approach that of the threshold limit value (TLV) for any of the substances listed in Table 1, appropriate safety measures will be implemented under the supervision of the site project engineer. These precautions include, but are not limited to, the following: (1) donning of respirators (with appropriate cartridges) by site personnel, (2) forced ventilation of the site, (3) shutdown of work until such time as appropriate safety measures sufficient to insure the health and safety of site personnel can be implemented.

No eating, drinking or smoking will be allowed in the vicinity of the drilling operations. *ESTC* will designate a separate area on site for eating and drinking. Smoking will not be allowed at the vicinity of the site except in designated areas. No contact lenses will be worn by field personnel.

#### **WORK ZONES AND SECURITY MEASURES:**

The project engineer will call Underground Service Alert (USA), and the utilities will be marked before any drilling is conducted on-site, and the borings will be drilled at safe distances from the utilities. The client will also be advised to have a representative

on-site to advise us in selecting locations of borings with respect to utilities or underground structures. Enviro Soil Tech Consultants assumes no responsibility to utilities not so located. The first 5 feet will be hand augered before any drilling equipment is operated.

Each of the areas where the borings will be drilled will be designated as Exclusion Zones. Only essential personnel will be allowed into an Exclusion Zone. When it is practical and local topography allows, approximately 25 to 75 feet of space surrounding those Exclusion Zones will be designated as Contamination Reduction Zones.

Cones, wooden barricades or a suitable alternative will be used to deny public access to these Contamination Reduction Zones. The general public will not be allowed close to the work area under any conditions. If for any reason the safety of a member of the public (e.g. motorist or pedestrian) may be endangered, work will cease until the situation is remedied. Cones and warning signs will be used when necessary to redirect motorists or pedestrians.

**LOCATION AND PHONE NUMBERS OF EMERGENCY FACILITIES:**

For emergency reasons, the closest facilities addresses and phone numbers are listed below:

City of Emeryville Fire Department

911

Kaiser Foundation Hospital  
280 West Mac Arthur Boulevard, Oakland, CA

(510) 596-1000

**ENVIRO SOIL TECH CONSULTANTS**

HSP7



**ADDITIONAL CONTINGENCY TELEPHONE NUMBERS:**

Poison Control Center. . . . . (800) 523-2222

Enviro Soil Tech Consultants Administrative Office. . . . . (408) 297-1500

CHEMTREC. . . . . (800) 424-9300

**NOTE:** Only call CHEMTREC stands for Chemical Transportation Emergency Center, a public service of the Chemical Manufacturer's Association. CHEMTREC can usually provide hazard information, warnings and guidance when given identification number or the name of the product and the nature of the problem.

CHEMTREC can also contact the appropriate experts.

This Site Safety Plan has been reviewed by the project engineer, *ESTC's* field personnel and all subcontractors.

Amendments or modifications to this Plan may be written on a separate page and attached to this Plan. Any amendments or modifications must be reviewed and approved by the personnel name above.

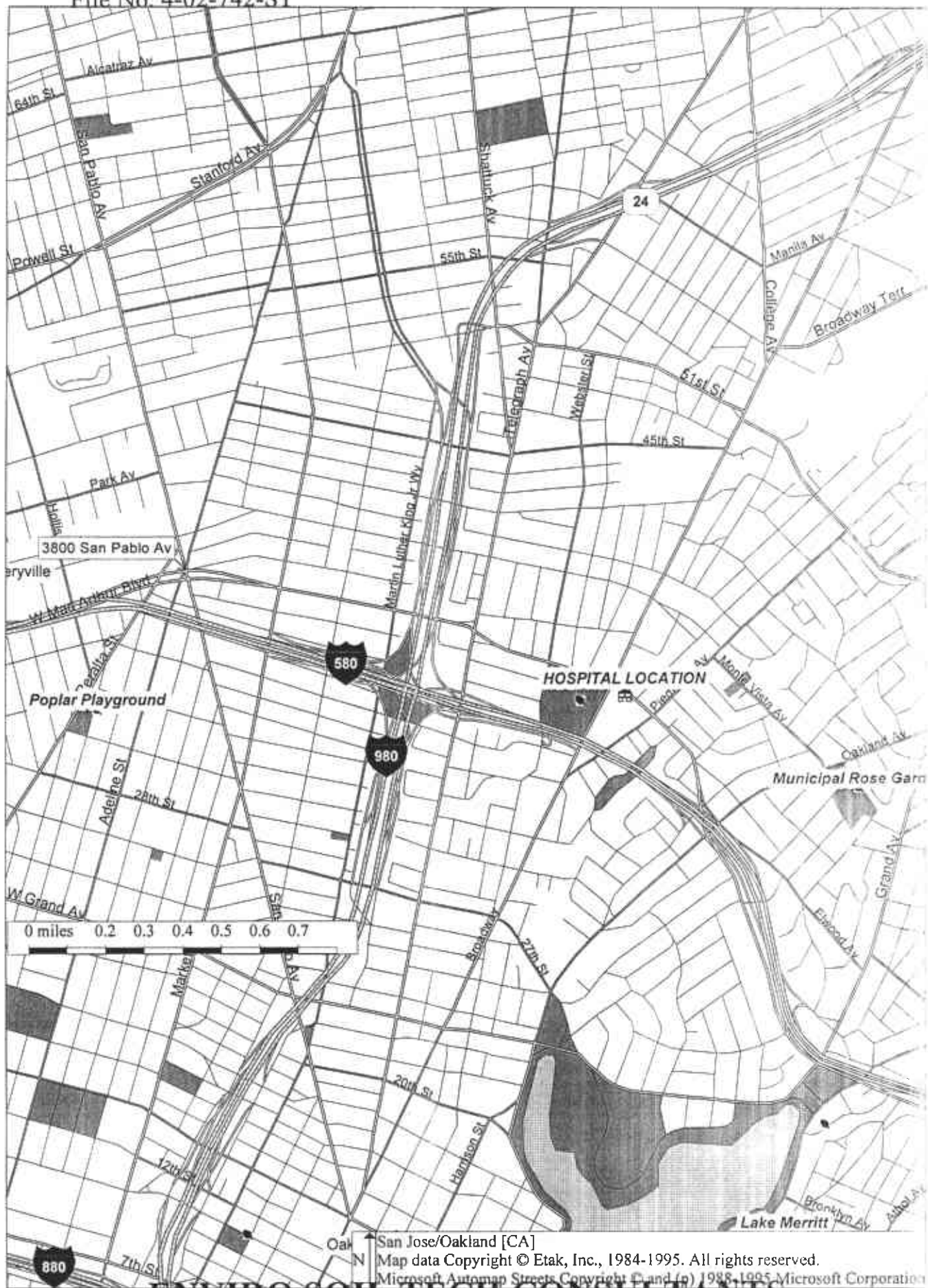

ENVIRO SOIL TECH CONSULTANTS

File No. 4-02-742-ST

**A P P E N D I X "E"**

**ENVIRO SOIL TECH CONSULTANTS**

**TYPES OF PROTECTIVE CLOTHING AND RESPIRATION  
THAT SHOULD BE USED AT HAZARDOUS WASTE SITES  
LOCATED AT 3800 SAN PABLO AVENUE  
EMERYVILLE, CALIFORNIA**

The degree of hazard is based on the waste material's physical, chemical, biological properties and anticipated concentrations of the waste. The level of protective clothing and equipment worn must be sufficient to safeguard the individual. A four category system is described below.

**LEVEL A:**

Level A consists of pressure-demand SCBA (air supplying respirator with back mounted cylinders), fully encapsulated resistant suit, inner and outer chemical resistant steel safety boots (toe, shank and metatarsal protection), and hard hat. Optional equipment might include cooling systems, abrasive resistant gloves, disposable oversuit and boot covers, communication equipment and safety line. Level A is worn when the highest level of respiratory, skin, and eye protection is required. Most samplers will never wear Level A protection.

**LEVEL B:**

Level B protection is utilized in areas where full respiratory protection is warranted, but a lower level of skin and eye protection is sufficient (only a small area of head and neck is exposed). Level B consists of SCBA, splash suit (one or two piece) or disposable chemical resistant coveralls, inner and outer chemical resistant gloves, chemical

resistant safety boots, and hard hat with face shield. Optional items include glove and boot covers and inner chemical resistant fabric coveralls.

**LEVEL C:**

Level C permits the utilization of air-purifying respirators. Level B body, foot and hand protection is normally maintained. Many organizations will permit only the use of approved full-face masks equipped with a chin or harness-mounted canister. However, many sites are visited by personnel wearing a half-mask cartridge respirator.

**LEVEL D:**

Level D protection consists of a standard work uniform of coveralls, gloves, safety shoes or boots, hard hat and goggles or safety glasses.

Two basic types of respirators are air-purifying and air-supplying. Air-purifying respirators are designed to remove specific contaminants by means of filters and/or sorbents. Air-purifying respirators come in various sizes, shapes and models, and can be outfitted with a variety of filters, cartridges and canisters. Each mask and cartridge or canister is designed for protection against certain contaminant concentrations. Just because a cartridge says it is for use against organic vapors does not mean that it is good for all organic vapors.

Air-supplying respirators are utilized in oxygen-deficient atmospheres (less than 19.5 percent) or when an air-purifying device is not sufficient. Air is supplied to a face-mask from an uncontaminated source of air via an air line from stationary tanks, from a compressor or from air cylinders worn on the back (SCBA). Rated capacities of the

SCBA's are normally between 30 and 60 minutes. Only positive pressure (pressure demand) respirators should be used in high concentration hazardous environments.

Respirators often malfunction during cold weather or after continued use. Only NIOSH (National Institute for Occupational Safety and Health) and MSHA (Mine Safety and Health Administration) approved respirators should be used.

Contact lenses are not permitted for use with an respirator. Contact lenses should not be worn at any site since they tend to concentrate organic materials around the eyes; soft plastic contact lenses can absorb chemicals directly. In addition, rapid removal of contact lenses may be difficult in an emergency. Since eye glasses can prevent a good seal around the temple when wearing goggles or full face masks, spectacle adapters are available for masks and goggles.