



AUG 29 2002

Transmittal

To: Ms. eva chu
 Alameda County Environmental
 Health Services
 1131 Harbor Bay Parkway, Suite 250
 Alameda, CA 94502-6577

From: Martha J. Watson
Date: August 26, 2002
Proj. No.: CRA102

Copies	Description	Sent by:
1	Off-Site Groundwater Characterization Cargill Salt – Alameda Facility Alameda, California	<input checked="" type="checkbox"/> Regular Mail <input type="checkbox"/> FedEx <input type="checkbox"/> Courier <input type="checkbox"/> Other

Comments:

cc:

Copies	Name & Address	Sent by:
4	Ms. Teri Peterson Cargill Salt 7220 Central Avenue Newark, CA 94560-4206	<input type="checkbox"/> Regular Mail <input checked="" type="checkbox"/> FedEx <input type="checkbox"/> Courier <input type="checkbox"/> Other
1	Mr. Mark Wheeler Crawford Consulting, Inc. 2 North First Street, 4 th Floor San Jose, CA 95113-1212	<input checked="" type="checkbox"/> Regular Mail <input type="checkbox"/> FedEx <input type="checkbox"/> Courier <input type="checkbox"/> Other

AUG 29 2002

OFF-SITE GROUNDWATER CHARACTERIZATION

Cargill Salt – Alameda Facility

Alameda, California *AUG 2002*

2016 Clement Ave, Alameda

Prepared for:

Cargill Salt

7220 Central Avenue

Newark, California 94560

Prepared by:

Conor Pacific

2580 Wyandotte Street, Suite G

Mountain View, CA 94043

Project No. CRA102

August 21, 2002

Conor Pacific

PROFESSIONAL CERTIFICATION

**Off-Site Groundwater Characterization
Cargill Salt – Alameda Facility
Alameda California**

This report has been prepared by:



Tom Vercoutere
Senior Geologist, R.G. 4462
Conor Pacific

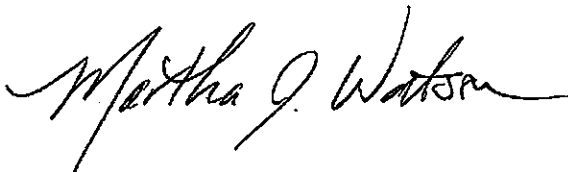

Martha J. Watson
Principal Environmental Engineer
Conor Pacific

CONTENTS

PROFESSIONAL CERTIFICATION	ii
1 INTRODUCTION	1
1.1 SITE BACKGROUND	1
1.2 SUMMARY OF INVESTIGATIVE AND REMEDIAL ACTIVITIES	2
2 SCOPE OF FIELD WORK	4
2.1 PROCEDURES	4
2.1.1 Plume Characterization	5
2.1.2 Well Construction	7
2.1.3 Subsurface Hydraulic Testing	8
3 FINDINGS	10
3.1 EXTENT OF VOCS	10
3.1.1 VOCs in Soil	10
3.1.2 VOCs in Groundwater	11
3.2 HYDROSTRATIGRAPHY	12
3.2.1 Physical and Organic Matter Properties	12
3.3 SUBSURFACE HYDRAULIC TESTING	13
3.4 GROUNDWATER FLOW DIRECTION, GRADIENT, AND VELOCITY	13
4 SUMMARY AND RECOMMENDATIONS	15
4.1 SUMMARY OF SITE CONDITIONS	15
4.2 RECOMMENDATIONS	16
5 REFERENCES	17
6 LIMITATIONS	19

TABLES

Table 1	Summary of Soil Sample Analysis, 1914 Chestnut Street
Table 2	Summary of Groundwater Sample Analysis, 1914 Chestnut Street
Table 3	Summary of Groundwater Sample Analysis, 2016 Clement Street
Table 4	Summary of Soil Physical Properties
Table 5	Hydraulic Slug Test Summary

ILLUSTRATIONS

Figure 1	Site Location
Figure 2	Sampling Locations
Figure 3	Extent of PCE in Groundwater
Figure 4	Groundwater Elevation Contours – December 2001

APPENDICES

Appendix A	Drilling, Right-of-Way, and Encroachment Permits
Appendix B	Hydrostratigraphic Profiles, Well Construction Details, Well Development Log, Survey Results
Appendix C	Certified Analytical Reports
Appendix D	Slug Test Procedures and Data Analysis
Appendix E	Data from Groundwater Monitoring and Previous Investigations

1 INTRODUCTION

This report presents the results of off-site soil and *groundwater* sampling and analysis, monitoring well installation, and hydraulic testing activities conducted by Conor Pacific and Crawford Consulting, Inc. (CCI) at the Cargill Salt Dispensing Systems Division facility, 2016 Clement Avenue in Alameda, California (Figure 1). The work was conducted to define the approximate limits of volatile organic compounds (VOCs), primarily tetrachloroethene (PCE), in off-site groundwater, and obtain information on the uppermost water-bearing zone. The scope of work was consistent with a request from the Alameda County Environmental Health Services (ACEHS, 2001) and a workplan submitted to the ACEHS (Conor Pacific, 2001).

1.1 SITE BACKGROUND

Alameda is an island on the east side of San Francisco Bay, separated from Oakland by a tidal canal (Figure 1). The island is underlain by unconsolidated marine and non-marine sediments, and is part of the East Bay Plain Groundwater Basin. The site is underlain by the Merritt Sand, and lies within the Merritt Sand Outcrop groundwater subarea (Muir, 1993). The Merritt Sand is not considered a primary source of water supply because of its limited areal extent and thickness. According to the Alameda County Flood Control and Water Conservation District, water from the area should only be used for irrigation or other non-potable uses because the Merritt Sand is a relatively thin unit susceptible to anthropomorphic contamination (Hickenbottom and Muir, 1988). There are no known supply wells within ½ mile down- or cross gradient from the site (Groundworks Environmental, Inc. [GEI], 1995).

Cargill's Alameda facility is located on a rectangular lot in an industrial and residential neighborhood. The facility building occupies approximately one-third of the site and is separated from the vacant, unpaved side of the lot by an asphalt driveway (Figure 2). The site is bordered by a sheet-metal shop and a residential lot to the northwest, a two-unit apartment complex to the southwest (1914 and 1916 Chestnut Street), and a residential lot to the southeast.

From 1951 to 1978, the Alameda facility produced salt-dispensing units, which required casting and milling aluminum parts. Casting now occurs off site; the facility still mills and repairs salt-dispensing units.

Constituents of concern associated with site operations have included casting sands with elevated concentrations of metals, and solvents, machine oils, and grease used in casting and milling operations. As discussed below, previous investigations and remedial activities have investigated and remediated metals and VOCs in vadose-zone soil.

1.2 SUMMARY OF INVESTIGATIVE AND REMEDIAL ACTIVITIES

Cargill Salt initiated site investigative activities in 1993 to determine if facility operations had impacted site soils. Cargill Salt submitted the results of the soil sampling investigation to the ACEHS in October 1993 along with a workplan for excavation and disposal of impacted soils and assessment of potential impact to groundwater (GEL, 1993).

After approval of the workplan by ACEHS, Cargill Salt conducted several phases of soil remediation and groundwater characterization. Surficial soils impacted by metals were excavated for disposal off site. Vadose-zone soils with the highest degree of impact by VOCs were also excavated for off-site disposal. The VOCs detected in soils and groundwater at this location may have been associated with degreasing operations at the facility. However, site records indicate that the solvents used for degreasing operations did not include PCE. The VOCs may have also been associated with waste products discarded from neighboring properties. The laundry room/utility shed for the neighboring apartment complex is only 4 feet away from the area where the highest degree of VOC impact to soil was identified. Thus, it is possible that products containing PCE were used in this laundry room (e.g., spot removers) and could have been discarded on the Cargill Salt property.

The results of these characterization and remediation activities were submitted to the ACEHS in a report, *Soil and Groundwater Investigations and Remedial Activities, July 1993 – September 1994, Cargill Salt – Alameda Facility, Alameda, California* (GEL, 1995). Recommendations for additional work to further delineate the lateral and vertical extent of VOCs in groundwater beneath the site were presented in the report.

A workplan for the additional delineation of VOCs in groundwater, "Workplan for Groundwater Characterization and Monitoring Well Installation, 2016 Clement Avenue, Alameda, California" (CCD), was submitted to the ACEHS in July 1999. After approval of the workplan by the ACEHS, Cargill Salt conducted groundwater transect sampling,

well installation, and initial sampling of the groundwater monitoring wells during August and November of 1999.

The results of the 1999 groundwater characterization were submitted to the ACEHS in a report, *Groundwater Characterization and Monitoring Well Installation, Cargill Salt – Alameda Facility, Alameda, California* (CCI and Conor Pacific, 2000).

Recommendations for additional work to further delineate the lateral and downgradient extent of VOCs, to obtain subsurface hydraulic characteristics, and to collect natural attenuation information were presented in the report.

Quarterly groundwater monitoring has been conducted since the initial monitoring well sampling event in November 1999. The monitoring results for 2000 were submitted to ACEHS in an annual report, "Groundwater Monitoring Results, First through Fourth Quarter 2000, Cargill Salt – Alameda Facility, Alameda, California" (CCI, 2001).

Chemical parameters associated with the natural attenuation of VOCs were collected as part of the groundwater monitoring activities conducted in 2001.

A workplan to further delineate the lateral and downgradient extent of VOCs and to obtain subsurface hydraulic characteristics, "Workplan for Off-Site Characterization, Cargill Salt Alameda Facility" (Conor Pacific, 2001), was submitted to the ACEHS in June 2001. After approval of the workplan by the ACEHS and access to off-site sampling locations was obtained, soil and groundwater sampling, well installation, and hydraulic testing was conducted from November 2001 through January 2002.

2 SCOPE OF FIELD WORK

The off-site extent of VOC impacted groundwater at the Alameda facility was characterized by conducting a soil and groundwater grab-sampling program at the 1914 Chestnut Street residential property on November 19, 2001, and a groundwater grab sampling program along Clement Street on December 4 and 6, 2001. Soil samples were collected from six hand-augered borings on the residential property to evaluate whether there is residual PCE in the soil that would have the potential to continue to impact the groundwater in this area. Groundwater grab samples were collected from each of these six borings to define the lateral edge of the VOC plume in groundwater. Groundwater samples were also collected from five machine-drilled borings on Clement Avenue, three along the north side of the street to define the width of the plume's leading edge and two along the south side of street to define the western limits of the plume. A groundwater monitoring well was installed on December 7, 2001 at the location of the highest detected VOC concentrations in groundwater on the north side of Clement Avenue. Boring and sampling locations are shown on Figure 2.

In addition to collecting groundwater and soil samples to characterize plume dimensions, two soils samples were collected from beneath Clement Avenue to evaluate the chemical transport properties of the impacted water-bearing zone, and three slug tests were conducted in on-site monitoring wells to evaluate the hydraulic conductivity of the water-bearing zone.

Conor Pacific conducted the Clement Avenue work under City of Alameda Right-of-Way Permit EX01-0176 and Encroachment Permit EN01-0065, and County of Alameda Public Works Agency drilling permit number W01-1057 (Appendix A); permits were not required for the Chestnut Street activities. Both the Clement Avenue work and the Chestnut Street work were supervised by CCI.

2.1 PROCEDURES

The procedures for the field activities at 1914 Chestnut Street and 2016 Clement Avenue are described below.

2.1.1 Plume Characterization

2.1.1.1 1914 Chestnut Street

Six shallow soil borings were drilled on the residential property using hand augering equipment at the locations shown on Figure 2. All augering and soil sampling equipment was washed in phosphate-free detergent and triple rinsed in deionized water before beginning each boring. As the borings were advanced, the soils were logged by California registered geologists according to the Unified Soil Classification System (USCS); the resulting hydrostratigraphic profiles are included in Appendix B. Soil cuttings were also screened in the field using an organic vapor analyzer equipped with a flame ionization detector (FID). The FID readings, in parts per million by volume (ppmv), were recorded on the profiles.

Two soil samples were collected from each boring by driving 6-inch stainless steel rings into undisturbed soil at the base of the boring. One sample was collected in the unsaturated zone, the other immediately below the water table. Sample depths are included on the profiles. The ends of each ring were covered with Teflon[®], capped, labeled, placed in zip-lock bags, and stored in a cooler that contained blue ice.

Each borehole was augered to a depth of approximately 10 feet below ground surface (bgs). After reaching the target depth, the borehole was left open for approximately ¼ hour to allow groundwater to enter the borehole and stabilize. A groundwater sample was collected from each borehole with a new disposable polyethylene bailer, which was opened immediately before use and discarded after the sample was collected. Groundwater samples were decanted into 40-milliliter glass vials, which were supplied by the laboratory. The vials were filled so that there was no headspace, capped, checked for air bubbles, labeled, and stored in a cooler pending delivery to the laboratory.

After the groundwater samples were obtained, the boreholes were backfilled with soil cuttings to a depth of approximately 5 feet bgs. The interval from approximately 5 to 2 feet bgs was filled with chipped bentonite, which was hydrated, and the remaining borehole was backfilled with topsoil; details are presented on the hydrostratigraphic profiles. Excess soil, as well as sampling equipment and wash water, was collected, and contained on site at the Cargill facility for proper disposal.

Chain-of-custody forms were completed for all soil and groundwater samples and the samples were submitted to Sequoia Analytical for the analysis of VOCs by U.S. Environmental Protection Agency (EPA) Method 8021B. Sequoia Analytical is a State-certified laboratory in Petaluma, California. Certified analytical reports for the analyses of soil and groundwater grab samples at 1914 Chestnut Street are presented in Appendix C.

2.1.1.2. Clement Avenue

Before the Clement Avenue program began, permits were obtained and the five boring locations were marked, Underground Services Alert (USA) was notified, and boring locations were cleared for underground utilities. Five borings were drilled along Clement Avenue for the collection of groundwater grab samples; three on the north side of the street and two on the south side of the street. After sampling and analyzing groundwater from these borings, a groundwater monitoring well was installed at the location of the highest detected VOC concentrations in groundwater on the north side of Clement Avenue. Precision Sampling, Inc. of Richmond California performed the drilling, sampling, and well installation. All drilling and sampling equipment that came in contact with soil or groundwater was steam-cleaned before use at each boring location. Rinseate was collected in 55-gallon drums for disposal off site based on the initial groundwater sampling results. Certified analytical reports for the analyses of soil and groundwater samples at 2016 Clement Avenue are presented in Appendix C.

2.1.1.2.1 *Soil Sampling*

Soil borings were completed by Precision using a Vibra-Push rig (percussion hydraulic hammer and vibrator) to advance its dual tube, Enviro-Core[®] system. The inner 2.0-inch-diameter steel tube is lined with 3-foot-long, polybutyrate sample tubes. The outer 2.5-inch-diameter drive tube acts as temporary casing to prevent sloughing while withdrawing the smaller diameter inner tube with soil cores. Soil samples were collected continuously to a depth of approximately 22 feet in the three borings on the north side of the street. The soil retrieved from the cores was logged according to the USCS; the resulting hydrostratigraphic profiles are included in Appendix B. Because of the uniformity of the soil stratigraphy throughout the area of investigation, the two borings on the south side of Clement Avenue were not sampled for soil logging purposes. Soil samples were collected from boring B-21, the middle boring on the north side of the street, at depths of 8 and 15 feet bgs. These soil samples were submitted to Cooper

Testing Laboratory for the analysis of total organic carbon, porosity, specific gravity, and bulk density.

2.1.1.2.2 *Groundwater Sampling*

Groundwater grab samples were collected from each location using a peristaltic pump equipped with clean polyethylene and Viton[®] tubing. The groundwater grab samples were collected by placing the end of the sampling tube at depths of approximately 15 feet bgs then using the peristaltic pump to withdraw the sample. Where soil sampling was not conducted, Precision Sampling advancing a 1.75-inch diameter steel drive casing equipped with a drop off tip. After reaching a target sample depth of approximately 17 feet, the drive casing was pulled back 3 feet to expose the screen to the water-bearing zone and allow groundwater to fill the drive casing. Grab samples were then collected from the drive casing using the peristaltic pump with clean tubing used for each boring.

All grab groundwater samples were properly decanted into preserved, 40-milliliter sample vials. Sample vials were labeled and stored in a cooler chilled with blue ice for delivery to the laboratory. Samples were submitted with appropriate chain-of-custody documentation to Sequoia Analytical for analyses of VOCs by EPA Method 8021B. Preliminary results from the northern side of Clement Avenue were used to determine where to place the downgradient groundwater monitoring well.

After collecting samples from each boring, the borings were grouted to ground surface using a cement grout. Grout was tremied to the bottom of each boring using the drive casing of the sampling system.

2.1.2 **Well Construction**

Monitoring well MW-4 was installed by Precision using a Vibra-Push rig and dual tube, Enviro-Core[®] system. The monitoring well boring was first started by hand auger to 4 feet bgs to facilitate placement of a surface seal material and well monument during well construction. Monitoring well MW-4 was constructed within the 2.5-inch-diameter outer drive casing, driven to 19 feet bgs, using 1-inch-diameter, Schedule 40, flush-threaded PVC casing and 0.010-inch machine-slotted screen. The water-bearing zone is screened from approximately 9 to 19 feet bgs. The annular space around the well screen and extending approximately 1 foot above the screens is filled with a #30 Sand filter pack. Two feet of ¼-inch bentonite pellets is placed above the filter pack and the remaining annular space is backfilled with a cement grout. A watertight vault is installed

flush to street level at the surface and the casing was capped with a watertight locking expansion well cap. Well construction details are included in Appendix B.

All down-hole drilling equipment, casing, and screen were steam cleaned before use. Rinsate was collected in a 55-gallon drum for disposal off site. The soil cuttings were contained in 5-gallon pails retained on site.

After well MW-4 was installed, it was surveyed by L. Wade Hammond, a California Licensed Land Surveyor (No. 6163). The well's top-of casing elevation and the metal rim on the vault were surveyed to the nearest 0.01 feet relative to the City of Alameda Datum, and the wells northing and easting were surveyed to the nearest 0.1 feet relative to the site datum. Well survey data are presented in Appendix B.

2.1.2.1 Well Development and Sampling

Monitoring well MW-4 was developed and sampled on December 17, 2001, during the fourth quarter 2001 groundwater-monitoring event. Monitoring well MW-4 was developed by swabbing and pumping techniques until the water was clear and free of settleable solids. The water was monitored for temperature, electrical conductivity (EC), pH, and color. Imhoff cones were used to quantify sand and silt quantities of the purge water. This information is included on the well development form included in Appendix B. The water generated during development was contained for appropriate disposal.

Groundwater from monitoring Well MW-4 was sampled using a peristaltic pump equipped with clean polyethylene and Viton[®] tubing. The groundwater sample was collected by placing the end of the sampling tube at a depth of approximately 15 feet bgs then using the peristaltic pump to withdraw the sample into preserved, 40-milliliter sample vials. The sample vials were labeled and stored in a cooler chilled with blue ice for delivery to the laboratory. The groundwater sample was submitted with appropriate chain-of-custody documentation to Sequoia Analytical for analyses of VOCs by EPA Method 8021B.

2.1.3 **Subsurface Hydraulic Testing**

Rising-head slug tests were performed in the three on-site wells, MW-1, MW-2, and MW-3, to provide data on hydraulic conductivity in the impacted water-bearing zone. During a slug test, a near-instantaneous change in water level is created in a well, and the rise or fall of the water level is monitored as it returns to a static level. A rising-head slug

test was performed in each well by depressing the water level with air introduced through a manifold at the top of the well (Patchett, 1993; McLane et. al., 1990). After the water level stabilized, the air was quickly released and a pressure transducer collected piezometric-head measurements over 5 second intervals as the water level rose to at least 90% of its pre-test static level. The data was stored in a data logger and downloaded to a laptop computer for analysis. The slug test data are presented in Appendix D.

3 FINDINGS

This section provides a summary of (1) the extent of VOCs in soil and groundwater, (2) the hydrostratigraphic characteristics of the site, including laboratory results of physical properties for soil samples, (3) subsurface hydraulic testing results, and (4) groundwater flow direction, gradient and velocity.

3.1 EXTENT OF VOCs

The results of the recent field activities at 1914/1916 Chestnut Street and 2016 Clement Avenue are described below in context with the results of previous investigations. Certified analytical reports for the analyses of soil and groundwater grab samples from the investigation at 1914 Chestnut Street and 2016 Clement Avenue are presented in Appendix C. The results of the associated chemical analyses are summarized in Tables 1, 2, and 3. Recent groundwater monitoring results are also summarized in Table 3; certified analytical reports for these analyses will be submitted as part of the annual groundwater monitoring report. Figures and tables of results from groundwater monitoring and prior investigations are presented in Appendix E.

3.1.1 VOCs in Soil

As discussed in Section 1.2, vadose-zone soils with the highest concentrations of VOCs have been excavated and disposed of off site. Figure 2 shows the area of solvent release and subsequent excavation at the upgradient, southwestern corner of the facility (also Figure 6, Appendix E). Residual concentrations of VOCs, however, remain in saturated soil. As shown in Figure 7 of Appendix E, soil samples collected at approximately 6 and 8 feet bgs adjacent to and beneath the excavation area were found to contain 3.4 and 31 milligrams per kilogram (mg/kg) PCE, respectively (GEI, 1995). No VOCs were detected in soil samples collected below these depths.

During this investigation, soil samples were collected from 1914 Chestnut Street (Figure 2) to evaluate the presence of VOCs. No VOCs were detected either in the field using an organic vapor analyzer (see hydrostratigraphic profiles in Appendix B) or by the laboratory (Table 1).

3.1.2 VOCs in Groundwater

Eight VOCs including PCE, TCE, cis-1,2-dichloroethene (cis-1,2-DCE), 1,1-dichloroethene (1,1-DCE), 1,1-dichloroethane (1,1-DCA), 1,1,1-trichloroethane (1,1,1-TCA), trichlorotrifluoroethane, and chloroform have been detected in groundwater samples at concentrations ranging from 0.575 to 4,400 micrograms per liter ($\mu\text{g/l}$) at the site during past investigations (Tables 1 and 2, Appendix E). During this investigation, three (PCE, TCE, and 1,1-DCE) were detected at concentrations of 0.81 to 1,700 $\mu\text{g/l}$ (Tables 2 and 3). As shown on Tables 2 and 3, PCE is the predominant VOC detected similar to previous investigation results. The presence of TCE and 1,1-DCE are most likely related to the presence of PCE. Both are known to be present in technical-grade PCE. Both TCE and 1,1-DCE also are known to be degradation products of PCE. 1,1-DCE can also be a breakdown product of 1,1,1-TCA (Dragun, 1988).

The results from this investigation help define the extent of VOCs in groundwater. Figure 3 illustrates the extent using PCE concentration data from groundwater monitoring and this and previous investigations, including on-site source area results and results for transect groundwater sampling (Figures 2, 3, and 4, Appendix E, [CCI and Conor Pacific, 2000]). As Figure 3 shows, the VOC plume is approximately 30 feet wide near the soil excavation area, and approximately 100 feet wide at the downgradient property boundary. Upgradient, the core of the plume, consisting primarily of PCE, is close to the northwestern property fence; the lateral extent of the plume is less than 15 feet off site (cross-gradient to the northwest), onto a residential lot and adjacent industrial parcel. Downgradient, the core of the VOC plume has moved slightly deeper to the northeast, reflecting the local groundwater flow direction. At the downgradient property boundary, the plume extends cross gradient approximately 15 feet to the northwest. The VOC plume extends less than 50 feet off site in the downgradient direction, beneath Clement Avenue, approximately 200 feet downgradient from the excavated soil area.

PCE, TCE, or both were detected in two of the four site wells. PCE was detected at a concentration of 1,700 $\mu\text{g/l}$ in the groundwater sample from upgradient well MW-2; no TCE was detected. This concentration of PCE correlates well with previous monitoring results and the concentration detected by previous investigations upgradient from this area (890 $\mu\text{g/l}$ at boring AGB-3, Figure 5, Appendix E) (GEI, 1995). At downgradient well MW-1, PCE was detected at a concentration of 1,400 $\mu\text{g/l}$ and TCE was detected at a concentration of 190 $\mu\text{g/l}$. These concentrations also correlate well with previous monitoring results and the concentration detected by previous investigations upgradient

from this area (1,400 and 79 $\mu\text{g/l}$ for PCE and TCE, respectively, boring AGB-6; Figure 5, Appendix E). The presence of TCE in downgradient groundwater suggests that PCE could be naturally degrading via reductive dechlorination to this compound. Further dechlorination to cis-1,2-DCE appears limited based on the low and infrequent detection of this compound (Appendix E). No other VOCs were detected at wells MW-1 and MW-2. Low levels of PCE were detected at wells MW-3 and MW-4. This is consistent with previous monitoring results and the concentration detected by previous investigations (borings AP-3, AP-4C, and AP-5, Figure 5) (GEI, 1995).

3.2 HYDROSTRATIGRAPHY

The soils encountered in borings during this investigation were similar to one another and to soils in previous borings. Hydrostratigraphic profiles for the recent borings are in Appendix B. Poorly graded sand and silty and clayey sands were encountered in the 10-foot-deep borings at 1914 Chestnut Street. In borings B-17 and B-18 on Clement Avenue, a poorly graded sand was encountered between 3 and 10 feet, followed by clayey and silty sands to 15.5 feet, below which was poorly graded sand to 22 feet bgs. In borings B-16, clayey and silty sands were encountered to 15 feet, below which was poorly graded sand to 21 feet bgs. The soils encountered in MW-4 were similar to those in B-17. These subsurface materials have low hydraulic conductivity, and subsequently, do not yield significant quantities of groundwater.

First encountered water in each boring ranged from 3 feet bgs (5 feet MSL) in the borings on Clement Avenue to 6.5 feet bgs (approximately 0.5 feet MSL) in the borings at 1914 Chestnut Street.

3.2.1 Physical and Organic Matter Properties

Soil samples were collected from the middle boring on the north side of Clement Avenue, at depths of 8 and 15 feet bgs. These soil samples were submitted to Cooper Testing Laboratory for the analysis of porosity, grain density, bulk density, and total organic carbon to characterize these parameters, which influence the transport of VOCs in groundwater. The results are summarized in Table 4; the analytical reports are in Appendix C.

The porosity results, averaging approximately 33%, are typical for unconsolidated fine-grained sandy sediments (Driscoll, 1986; Fetter, 1994). The grain density and bulk density, averaging approximately 2.685 and 1.81 grams per cubic centimeter (g/cm^3),

respectively, are also typical values for these sediments. The organic carbon content averages 0.7%.

There is good agreement between the field and laboratory classification of these predominantly fine-grained soils. The two samples collected were logged as silty sand (8-foot bgs sample) and clayey sand (15-foot bgs sample) in the field and the laboratory.

3.3 SUBSURFACE HYDRAULIC TESTING

The data from the slug tests were evaluated using the methods of Bouwer and Rice (1976, 1989, 1989a) and of Hvorslev (1951) as implemented by a spreadsheet software program (Slug, version 0.96b). These methods of analysis are applicable for completely or partially penetrating wells in unconfined and confined water-bearing zones, respectively. Hydraulic conductivity (K) of the tested interval is calculated based on well geometry and the relationship between the change in water level and the elapsed time since the release of the air "slug". A detailed discussion of the slug test data analysis is presented in Appendix D. Table 5 presents a summary of the test results.

The two analytical methods returned similar hydraulic conductivity values. The hydraulic conductivity results from the slug tests ranged from 3×10^{-5} to 3×10^{-6} centimeters per second (cm/sec). These values are within the ranges expected for the clayey sand, silty sand, and sandy clay (Fetter, 1994; Watson and Burnett, 1993) that occur beneath the site. The lowest hydraulic conductivity value is associated with MW-3, which correlates with the slow recharge rate noted during the development and sampling of this well (CCI and Conor Pacific, 2000).

3.4 GROUNDWATER FLOW DIRECTION, GRADIENT, AND VELOCITY

Surveyed top-of-casing elevations and static water levels (collected at each monitoring well on December 17, 2001) were used to construct a groundwater contour plot for the facility (Figure 4). Groundwater levels across the facility range from 3.46 to 5.74 feet MSL. Top of casing and historical groundwater elevation information is summarized in Table 1, Appendix E. Generally, groundwater flows toward the northeast at an average gradient of 0.016. The groundwater flow direction is consistent with distribution of PCE shown in Figure 3. The relatively steep gradient is also a reflection of the low-yielding subsurface materials at the site.

The velocity of groundwater flow can be estimated using the following equation.

$$v = Ki/n$$

where: v = groundwater velocity through a zone (feet per day, [ft/day])
 K = hydraulic conductivity of the zone (ft/day)
 i = hydraulic gradient in the zone (unitless)
 n = effective porosity of the zone (unitless)

Using the highest hydraulic conductivity presented in Table 4, (3×10^{-5} cm/sec, which is equivalent to 0.04 ft/day), the average hydraulic gradient (0.016), and an estimated effective porosity of 30% (90% of the total porosity), the estimated groundwater velocity is 0.0045 ft/day, or approximately 2 feet per year.

4 SUMMARY AND RECOMMENDATIONS

4.1 SUMMARY OF SITE CONDITIONS

Several phases of soil remediation and groundwater characterization have been performed at the site. This work has identified VOCs in both soil in groundwater beneath the site. Vadose-zone soils with the highest concentrations of VOCs were excavated and disposed of off site (GEI 1995). The area of solvent release and subsequent excavation is at the upgradient, southwestern corner of the facility. Residual concentrations of VOCs, primarily PCE and its breakdown products, likely remain in saturated soil. Soil samples collected in 1995 beneath and adjacent to the excavation area at depths between 6 and 8 feet bgs contained up to 31 mg/kg PCE. No VOCs were detected in soil samples collected below these depths. As part of the investigation discussed in this report, soil samples were collected from the property neighboring the excavation area (1914 Chestnut Street) to evaluate the presence of VOCs. No VOCs were detected in soil.

The lateral and vertical extent of VOCs in groundwater beneath the site has been identified by the additional field work discussed in this report. The VOC plume is approximately 30 feet wide near the soil excavation area, and approximately 100 feet wide at the downgradient property boundary. Upgradient, the core of the plume, consisting primarily of PCE, is close to the northwestern property fence; the lateral extent of the plume is less than 15 feet off site on the properties adjacent to the Cargill site (cross-gradient to the northwest). No VOCs were detected in groundwater samples collected further to the northwest at 1914 Chestnut Street (greater than 15 feet from the property line). Downgradient, the core of the VOC plume has moved slightly deeper and to the northeast, reflecting the local groundwater flow direction. At the downgradient property boundary, the plume extends approximately 15 feet to the northwest. The VOC plume extends less than 50 feet off site in the downgradient direction, beneath Clement Avenue, approximately 200 feet downgradient from the excavated soil area. One downgradient groundwater monitoring well was installed as part of the investigation discussed in this report; it is to be used with the other three wells in monitoring groundwater quality, gradient, and flow direction.

PCE and its breakdown product TCE are the predominant VOCs detected in groundwater at the site. The presence of TCE and other breakdown products in downgradient groundwater suggests that PCE is biodegrading. However, TCE is also known to be

present in technical-grade PCE. Furthermore, little cis-1,2-DCE is present, which indicates that degradation via reductive dechlorination is hampered.

The subsurface material is silty to clayey sands with lenses of sandy clay. Groundwater flows toward the northeast at velocity of approximately 2 feet per year. These subsurface materials have low hydraulic conductivity and subsequently, will not yield significant quantities of groundwater.

4.2 RECOMMENDATIONS

Based on the results of this investigation, Conor Pacific recommends that Cargill (1) continue to monitor groundwater quality, flow direction and gradient, and (2) evaluate potential remedial action alternatives for the site.



August 22, 2002

Ms. eva chu

Alameda County Department of Environmental Health
Hazardous Materials Division
1131 Harbor Bay Parkway, Suite 250
Alameda, California 94502-6577

Re: Off-Site Groundwater Characterization, Cargill Salt Alameda Facility

Dear Ms. chu:

The attached report presents the results from an off-site groundwater characterization for the Cargill Salt Alameda facility. To the best of my knowledge, the attached report is true, complete, and correct.

Sincerely,

A handwritten signature in black ink that reads "Teri Peterson".

Teri Peterson
Environmental Engineer

Attachments: As stated

5 REFERENCES

- Alameda County Environmental Health Services (ACEHS), 2001. Letter to Cargill Salt: "Off site Investigation at 2016 Clement Avenue, Alameda, CA", April 19, 2001.
- Ballapragada, S. B, et al., 1997. Environ. Sci. Technol., 31, p. 1728-1734.
- Bouwer, Herman. 1989. The Bouwer and Rice slug test - an update. Groundwater, v.27, n.3
- Bouwer, Herman. 1989. Discussion of the Bouwer and Rice slug test - an update. Groundwater, v.27, n.5
- Bouwer, Herman, and R.C. Rice. 1976. A slug test for determining hydraulic conductivity of unconfined aquifers with completely or partially penetrating wells. Water Resources Research, v.12, no.3.
- Chapelle, F. H. 1996. *Identifying Redox Conditions that Favor the Natural Attenuation of Chlorinated Ethenes in Contaminated Groundwater Systems*.
- Chapuis, Robert P. 1989. Shape factors for permeability tests in boreholes and piezometers. Groundwater, v.27, n.5.
- Conor Pacific, 2001. "Workplan for Off-Site Characterization, Cargill Salt Alameda Facility", June 18 2001.
- Crawford Consulting, Inc. (CCI), 1999. "Workplan for Groundwater Characterization and Monitoring Well Installation, 2016 Clement Avenue, Alameda, California", July 7, 1999.
- Crawford Consulting, Inc. (CCI) and Conor Pacific, 2000. *Groundwater Characterization and Monitoring Well Installation, Cargill Salt - Alameda Facility, Alameda, California*, January 31, 2000.
- Crawford Consulting, Inc. (CCI), 2001. "Groundwater Monitoring Results, First through Fourth Quarter 2000, Cargill Salt - Alameda Facility, Alameda, California", April 11, 2001.
- Dragun, J. 1988. *The Soil Chemistry of Hazardous Materials*, Hazardous Materials Control Research Institute, Silver Spring Maryland.
- Fetter, C.W., 1994. *Applied Hydrogeology*, Prentice Hall, Englewood Cliffs, NJ.
- Groundworks Environmental, Inc. (GEI), 1993. "Results of soil sampling and workplan for remedial activities, Alameda facility", October 19, 1993.

- Groundworks Environmental, Inc. (GEI), 1995. *Soil and Groundwater Investigations and Remedial Activities, July 1993 – September 1994, Cargill Salt – Alameda Facility, Alameda, California, July 31, 1995.*
- Hickenbottom, K., and Muir, K. S., 1988. *Geohydrology and Groundwater-Quality Overview of the East Bay Plain Area, Alameda County, California, 205 (j) Report*, prepared for the California Regional Water Quality Control Board, San Francisco Bay Region, by the Alameda County Flood Control and Water Conservation District, June 1988.
- Hvorslev, M.J. 1951. Time-lag and soil permeability in ground-water observations. U.S. Army Eng. Waterways Exp. Sta., Vicksburg, MS. Bull. 36
- McLane, G.A., D.A. Harrity, and K.O. Thomsen, 1990. *A Pneumatic Method for Conducting Rising and Falling Head Tests in Highly Permeable Aquifers*, In: Proceedings of the 7th National Outdoor Action Conference, National Groundwater Association, Columbus, OH.
- Muir, K. S. 1993. *Geologic Framework of the East Bay Plain Groundwater Basin, Alameda County, California*, report prepared for Alameda County Flood Control and Water Conservation District, August 1993.
- Patchett, R.G., 1993. *Pneumatic Well Insert: Performing Pneumatic Rising Head Tests in Wells with Screens Straddling the Water Table*, In: Proceedings of the 7th National Outdoor Action Conference, National Groundwater Association, Columbus, OH.
- San Francisco Bay Area, Regional Water Quality Control Board (RWQCB), 2000. *Application of Risk-Based Screening Levels and Decision Making to Sites With Impacted Soil and Groundwater (Interim Final - August 2000)*, as periodically updated.
- Watson, L., and A.D. Burnett, 1993. *Hydrology, An Environmental Approach*, Buchanan Books, Ft. Lauderdale, FL.
- U.S. Environmental Protection Agency. *Technical Protocol for Evaluating Natural Attenuation of Chlorinated Organics in Ground Water*. EPA/600/R-98/128. September 1998.

6 LIMITATIONS

Services on this project were performed in accordance with current generally accepted environmental consulting principles and practices. This warranty is in lieu of all others, be it expressed or implied. Environmental conditions may exist at the site that could not be observed. Where the scope of services was limited to observations made during site reconnaissance, interviews, and/or review of readily available reports and literature, our conclusions and recommendations are necessarily based largely on information supplied by others, the accuracy and sufficiency of which may not have been independently reviewed by us. Our professional analyses are based in part on interpretation of data from discrete sampling locations that may not represent actual conditions between such sampling points. Additional data from future work or changing conditions may lead to modifications to our professional opinions and recommendations. Any reliance on this report, or portions thereof, by a third party shall be at such party's sole risk.

Table 1
 Summary of Soil Sample Analysis
 1914 Chestnut Street
 Cargill Salt, Alameda Facility

Boring Designation	Sample Depth ft. bgs	Analytical Results ¹		
		PCE mg/kg	TCE mg/kg	1,1-DCE mg/kg
1914B1	2.5 - 3.0	<0.19	<0.16	<0.14
1914B1	8.0 - 8.5	<0.19	<0.16	<0.14
1914B2	2.5 - 3.0	<0.19	<0.16	<0.14
1914B2	6.7 - 7.2	<0.19	<0.16	<0.14
1914B3	3.8 - 4.3	<0.19	<0.16	<0.14
1914B3	7.9 - 8.4	<0.19	<0.16	<0.14
1914B4	2.7 - 3.2	<0.19	<0.16	<0.14
1914B4	7.0 - 7.5	<0.19	<0.16	<0.14
1914B5	3.0 - 3.5	<0.19	<0.16	<0.14
1914B5	8.0 - 8.5	<0.19	<0.16	<0.14
1914B6	2.8 - 3.3	<0.19	<0.16	<0.14
1914B6	7.5 - 8.0	<0.19	<0.16	<0.14

Notes:

ft bgs = feet below ground surface

PCE = Tetrachloroethene

TCE = Trichloroethene

1,1-DCE = 1,1-Dichloroethene

mg/kg = concentration in milligrams per kilogram (parts per million)

¹Soil samples collected on November 19, 2001 and analyzed by EPA Method 8021B. Only compounds detected in groundwater samples are shown. All other compounds were not detected.

Table 2
 Summary of Groundwater Sample Analysis
 1914 Chestnut Street
 Cargill Salt, Alameda Facility

Boring Designation	Analytical Results ¹		
	PCE µg/L	TCE µg/L	1,1-DCE µg/L
1914B1	<0.5	<0.5	<0.5
1914B2	<0.5	<0.5	<0.5
1914B3	3.4	<0.5	<0.5
1914B4	1.1	<0.5	<0.5
1914B5	500	<0.5	<0.5
1914B6	10	<0.5	<0.5

Notes:

PCE = Tetrachloroethene

TCE = Trichloroethene

1,1-DCE = 1,1-Dichloroethene

µg/L = concentration in micrograms per liter

¹Groundwater samples collected on November 19, 2001 and analyzed by EPA Method 8021B. Only compounds detected in groundwater samples from 2016 Clement Avenue borings and wells are shown. All other compounds were not detected.

Table 3
 Summary of Groundwater Sample Analysis
 2016 Clement Avenue
 Cargill Salt, Alameda Facility

Boring / Well Designation	Analytical Results ¹		
	PCE µg/L	TCE µg/L	1,1-DCE µg/L
B-16	1.9	<1.0	<1.0
B-17 ²	3.4	<1.0	<1.0
B-18	<1.0	<1.0	<1.0
B-19	<1.0	<1.0	<1.0
B-20	120	11	1.3
MW-1	1400	190	<13
MW-2	1700	<25	<25
MW-3	0.81	<0.5	<0.5
MW-4	2.6	<0.5	<0.5

Notes:

Samples from borings collected on December 6, 2001.

Samples from wells collected on December 17, 2001.

PCE = Tetrachloroethene

TCE = Trichloroethene

1,1-DCE = 1,1-Dichloroethene

µg/L = concentration in micrograms per liter

¹Groundwater samples analyzed by EPA Method 8021B. Only compounds detected are shown. All other compounds were not detected.

²Boring B-17 is the location of monitoring well MW-4.

Table 4
 Summary of Soil Physical Properties
 2016 Clement Avenue
 Cargill Salt, Alameda Facility

Boring Designation	Sample Depth ft bgs	Analytical Results			
		Porosity %	Grain Density g/cm ³	Bulk Density g/cm ³	Organic Carbon %
B21	8	33.8	2.69	1.78	0.8
B21	15	31.3	2.68	1.84	0.6
	Average	32.55	2.685	1.81	0.7

Notes:

Samples collected on December 6, 2001.

ft bgs = feet below ground surface

g/cm³ = grams per cubic centimeter

Bulk density (P_b) = $P_s (1-n)$

where:

P_s = Grain Density

n = Porosity

Table 5
 Hydraulic Slug Test Summary
 2016 Clement Avenue
 Cargill Salt, Alameda Facility

Well ID	Test Date	Slug Test Type	Well Length (ft btom)	Static DTW (ft btom)	Saturated Interval (ft)	Screen Length (ft)	Casing Radius (ft)	Borehole Radius (ft)	Hvorslev Conductivity ¹ (K, ft/day)	Hvorslev Conductivity (K, cm/sec)	Bouwer & Rice Conductivity ² (K, ft/day)	Bouwer & Rice Conductivity (K, cm/sec)	Lithology (USCS)
MW-1	1/15/2002	PN R	20.35	4.90	15.45	12	0.042	0.104	9E-02	3E-05	6E-02	2E-05	SC w/ SM
MW-2	1/15/2002	PN R	19.40	4.95	22.25	12	0.042	0.104	6E-02	2E-05	4E-02	2E-05	SC w/ SM, CL, SP
MW-3	1/15/2002	PN R	19.35	4.99	14.36	12	0.042	0.104	1E-02	4E-06	7E-03	3E-06	SC w/ SM, CL
Average value									5.1E-02	1.8E-05	3.6E-02	1.3E-05	

Notes:

PN R - Pneumatic Rising Head Slug Test
 ft - feet
 DTW - depth to water
 btom - below top of manifold

¹ Estimated hydraulic conductivity, K; Hvorslev (1951) method of analysis.
² Estimated hydraulic conductivity, K; Bouwer and Rice (1976, 1989, 1989a) method of analysis.
 ft/min - feet per minute
 cm/sec - centimeters per second

USCS - Unified Soil Classification System
 SC - Clayey Sand
 SM - Silty Sand
 CL - Sandy Clay

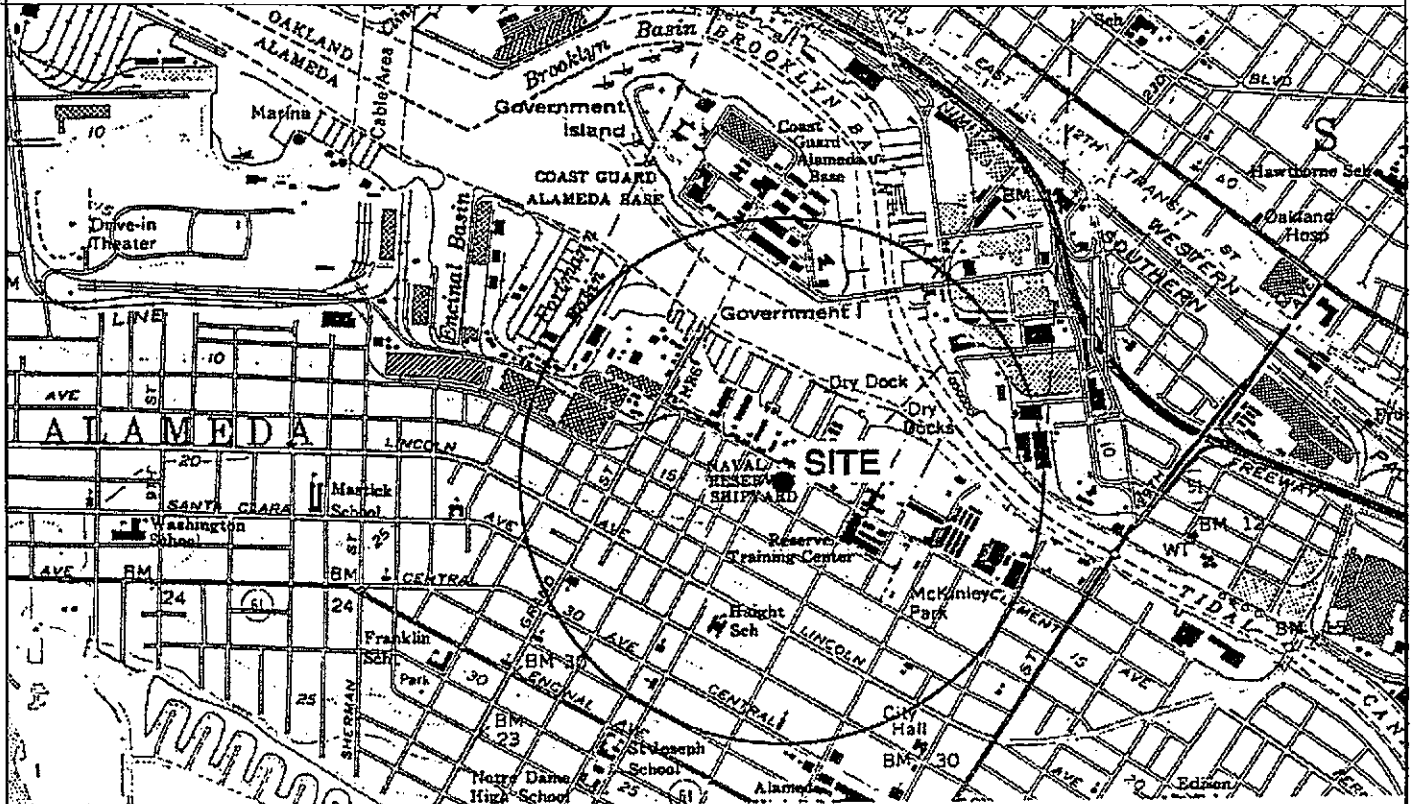
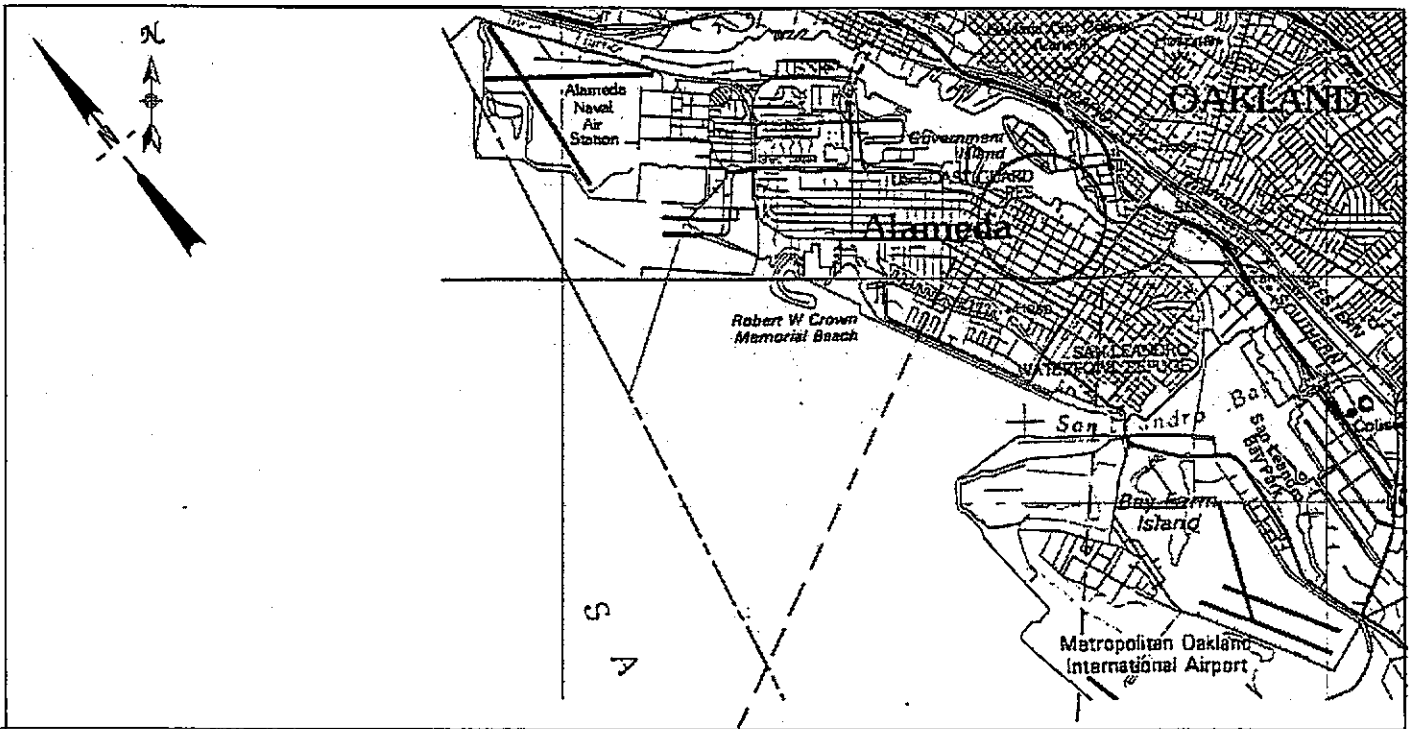

Base map (upper): U.S.G.S. 1:1,000,000-scale series (Topographic)
 San Francisco Quadrangle, California, 1978.
 Base map (lower): U.S.G.S. 7.5 minute series (Topographic)
 Oakland East and Oakland West Quadrangles, California,
 1959, Photorevised 1980.

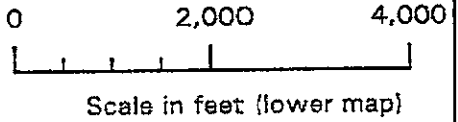

Conor Pacific

Cargill Salt Dispensing Systems Division
 2016 Clement Avenue, Alameda, California
Figure 1. Site Location

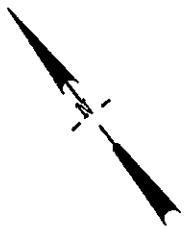

Clement Avenue

B-16 B-17 B-18

Curb line (Typ.)

B-19 B-20

Chestnut Street

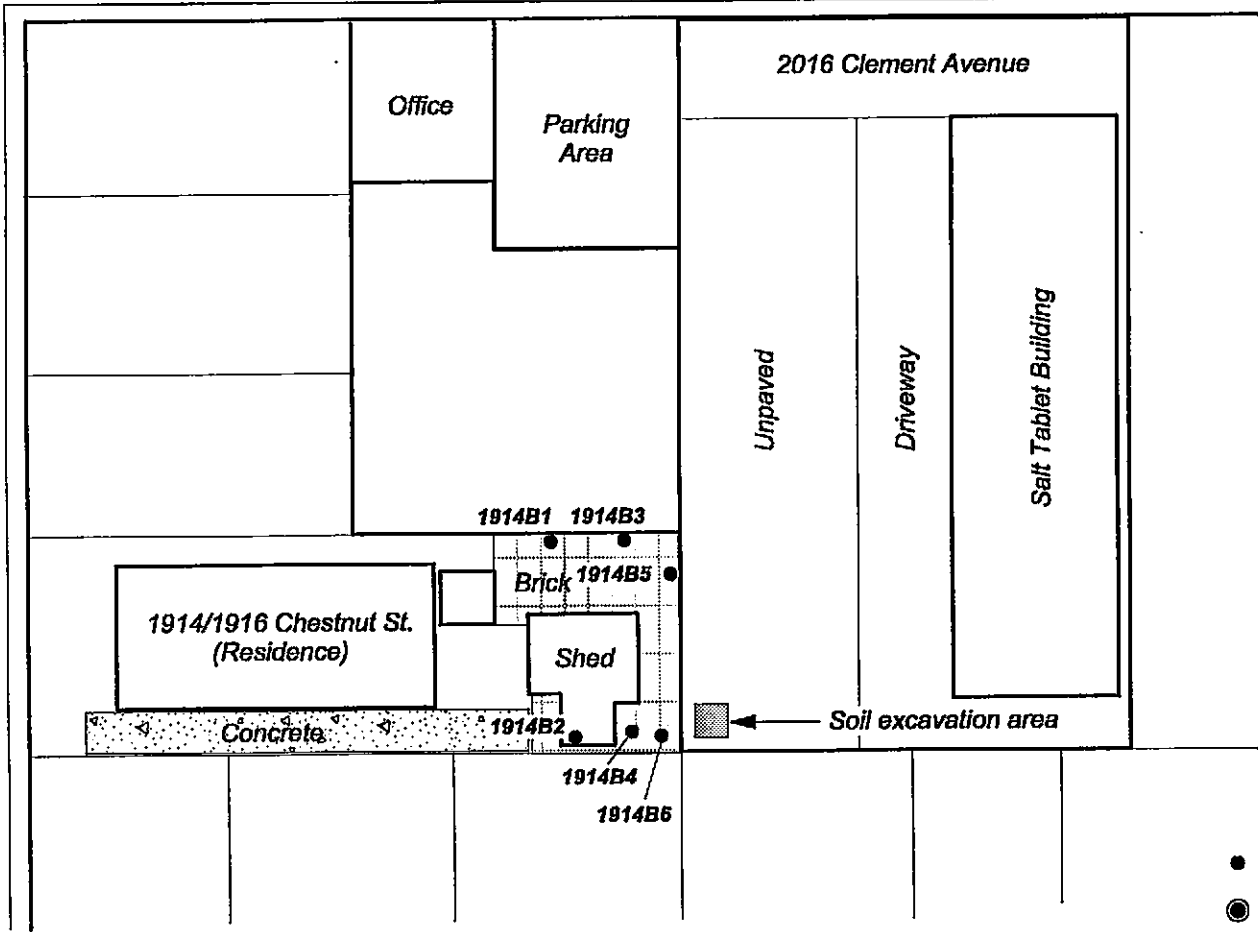

EXPLANATION

- Boring location
- Monitoring well

Conor Pacific

Cargill Salt Dispensing Systems Division
 2016 Clement Avenue, Alameda, California
Figure 2. Sampling Locations

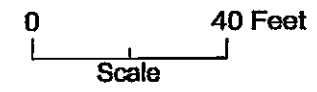

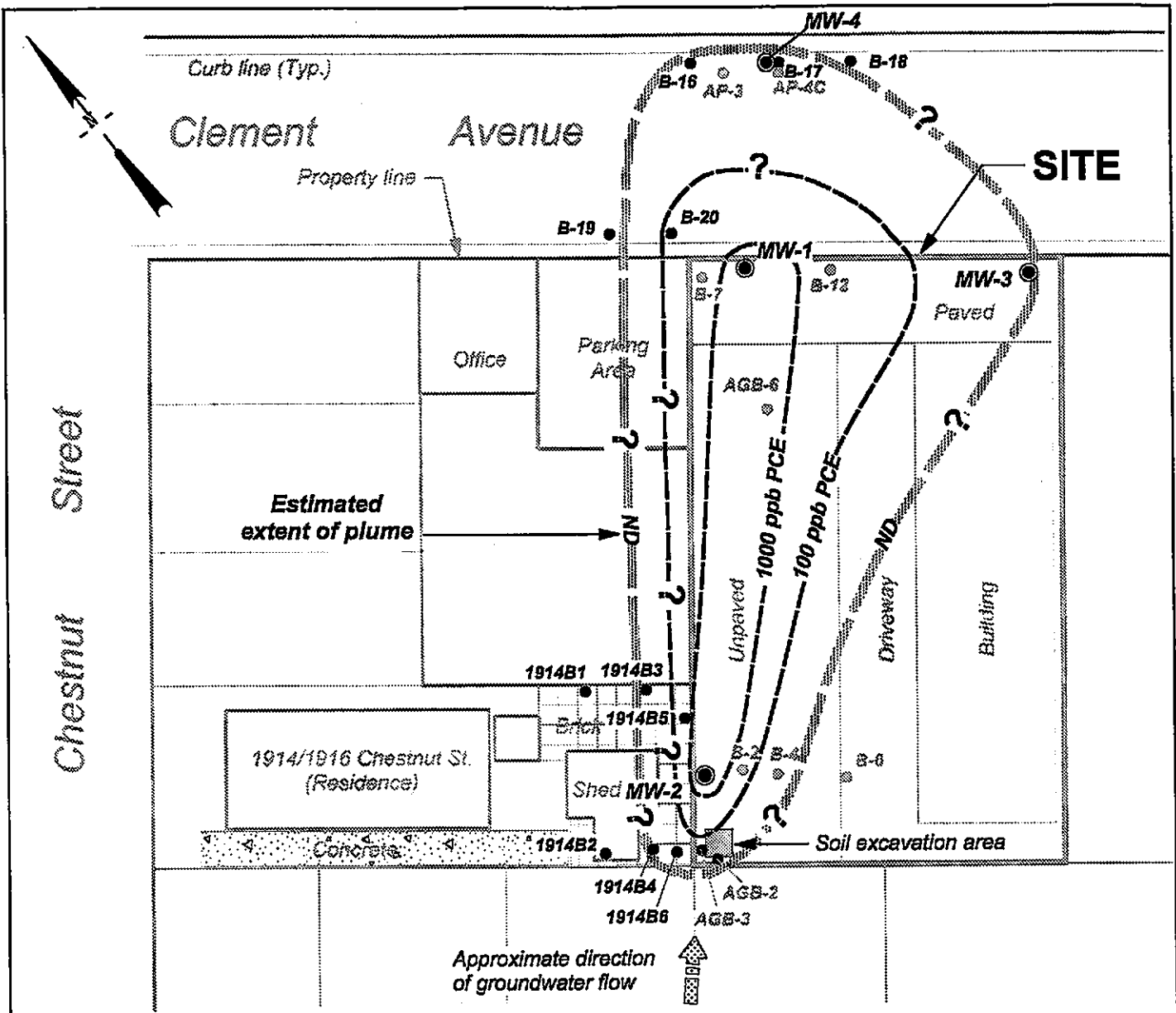

SAMPLE DESIGNATION	SAMPLE DATE	PCE CONC. (µg/L)
MW-1	12/01	1400
MW-2	12/01	1700
MW-3	12/01	0.8
MW-4	12/01	2.6
B-16	12/01	1.9
B-17	12/01	3.4
B-18	12/01	ND
B-19	12/01	ND
B-20	12/01	120
1914B1	11/01	ND
1914B2	11/01	ND
1914B3	11/01	3.4
1914B4	11/01	1.1
1914B5	11/01	500
1914B6	11/01	10

ND=Not detected

EXPLANATION

- Monitoring well
- Grab groundwater sample
- Previous grab groundwater sample location



Conor Pacific

Cargill Salt Dispensing Systems Division
 2016 Clement Avenue, Alameda, California
 Figure 3. Extent of PCE in Groundwater

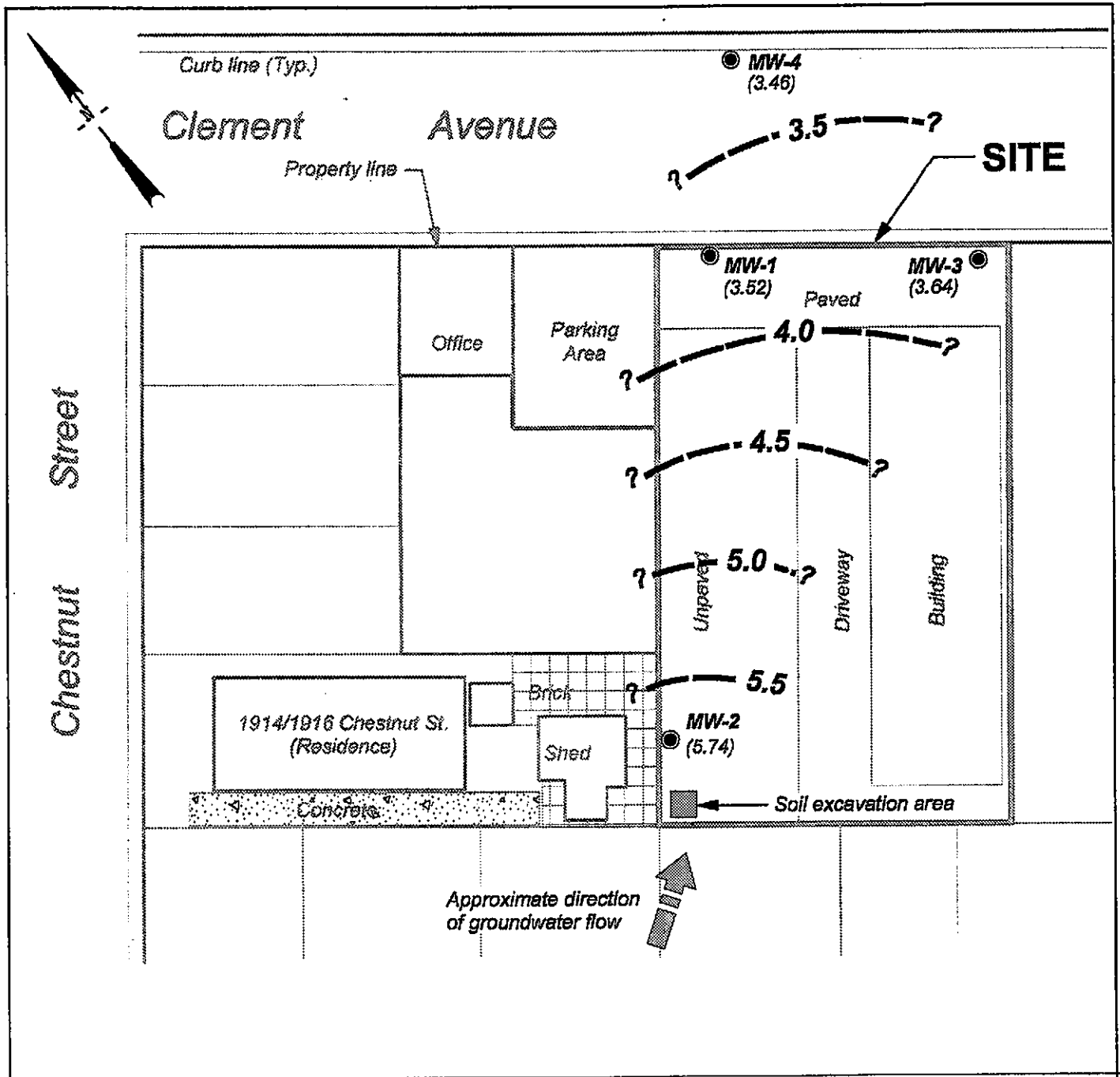

EXPLANATION

● Monitoring well

(5.74) Groundwater elevation (Ft.-MSL);
measured 12/17/01

? — 5.5 — Groundwater elevation contour
(Ft.-MSL)

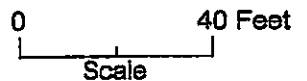

Conor Pacific

Cargill Salt Dispensing Systems Division
2016 Clement Avenue, Alameda, California

Figure 4. Groundwater Elevation Contours - December 2001

APPENDIX A

DRILLING, RIGHT-OF-WAY, AND ENCROACHMENT PERMITS

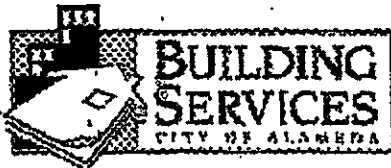

City of Alameda
2263 Santa Clara Avenue, Room 190
Alameda, CA 94501
(510) 748-4530

RECEIVED

NOV 14 2001

Submit in Duplicate

RIGHT-OF-WAY PERMIT APPLICATION

SERVICE NUMBER

DATE Nov 9 2001

Application is hereby made to occupy or perform work in the public right-of-way on the NORTH & SOUTH side of

CLEMENT St. 120-190 feet FROM CHESTNUT ST.

JOB SITE COPY

House No. 2016 Owner CARGILL SALT

For the purpose of 5 BORINGS & 1 well to INVESTIGATE GROUNDWATER CHEMISTRY

Name of Applicant MARTHA WATSON / OWNER Address 2580 WYANDOTTE ST. City/State MOUNTAIN VIEW, CA

Contractor's License No. CS7 636387 City Business License No. 026377 Phone 650-386-3828 x224 Number (510-237-4575 Precision)

INDICATE LOCATION BELOW OR ATTACH SEPARATE SHEET SHOWING LOCATION

BORINGS ARE 28" DIA., 20' DEEP, BACK FILLED WITH CEMENT. ~ 3' FROM F.O.L.

WELL IS WITHIN A VAULT BOX. SEE ATTACHED DIAGRAM. ~ 3' FROM F.O.L.

USA WILL BE NOTIFIED MIN 48 HRS IN ADVANCE.

PLEASE NOTE THE FOLLOWING:

1. Urban runoff program requires that no contaminants, including dirt, enter the storm drain system. Contractor is required to protect inlets. Failure to comply is subject to \$200/day fine.
2. 48 hour advance notice is required for inspection. Contact: Engineering Division, Construction Inspection office at 748-5840. Required inspections: Trenching, backfill, concrete, traffic/pedestrian detours, urban runoff, final inspection. Failure to obtain inspection prior to work may result in refection of said work.
3. All striping, painted graphics and pavement markers damaged or destroyed by street excavation work must be restored by the permittee.
4. All construction within the Public Right-of-Way must have barricades with flashers for night time protection.
5. All work involved is to be done in accordance with standard City of Alameda specifications and City of Alameda practices, all to the satisfaction of the City Engineer. Standard details are attached. Inspection charges shall be paid to the City monthly.
6. Processing time for routine permits is 5 days. Permits requiring extensive research may require up to 15 days.
7. FAILURE TO OBTAIN INSPECTIONS PRIOR TO COMPLETION OF WORK IS SUBJECT TO ADDITIONAL INSPECTION COSTS AT A RATE OF \$32.70 PER HOUR.

Acceptance of this permit constitutes acceptance of the conditions included.

Martha J. Watson
APPLICANT SIGNATURE

Date Nov. 9, 2001

JOB SITE COPY

SPECIAL CONDITIONS

- NO OPEN TRENCH CUTTING
- STATE PERMIT REQUIRED
- ADDITIONAL SETS OF PLANS AND SPECIFICATIONS TO THE ENGINEERING DIVISION PRIOR TO CONSTRUCTION # OF SETS
- OTHER

RECEIVED DATE 11/14/01 SIGNED [Signature]
APPROVED DATE 11-25-01 SIGNED [Signature]
ISSUED DATE 11-28-2001 SIGNED [Signature]

PERMIT NO. 6001-0176

950 West Mall Square, #110

CITY OF ALAMEDA

(510) 749-5840

Alameda Point
Alameda, CA 94501

Public Works Department

Fax (510) 749-5867

Printed: 11-28-2001

Right-of-Way Permit

Permit #
EX01-0176

Applicant

CONOR PACIFIC
2580 WYNDOTTE STREET
MOUNTAIN VIEW, CA
94043
650-386-3828 EXT. 224

Contractor Information

Owner Information

LESLIE SALT CX
7220 CENTRAL AVE
NEWARK CA

94560

Project Information

RTOFWAY - Right-of-Way Permit - **APPROVED**
Sub-Type:

Applied: 11/14/2001

Finalized:

Issued: 11/28/2001

Expires: 11/28/2002

Valuation: \$0.00

Job Address: 2016 CLEMENT AVE
071 025600402

Suite / Unit:

Work Description: EXCAVATE-5 BORINGS & 1 WELL

Parcel Number:

Total Fees:	\$113.00
Total Payments:	\$113.00
BALANCE DUE	\$0.00

Payments Made: 11/28/2001 11:20 AM
Total Payment: **\$113.00**

RECEIPT

Receipt #: R01-5834

Payee: CONOR PACIFIC

Current Payment Made to the Following Items:

Account Code	Description	Amount
4225-37160 (6319)	Engin.-Plan Check Fees	75.00
4520-37450 (1050)	Permit Filing Fees	38.00

Payments Made for this Receipt:

Type	Method	Description	Amount
Payment	Check	549	113.00

Account Summary for Fees and Payments:

Item#	Description	Account Code	Tot Fee	Paid	Prev. Pmts	Cur. Pmts
250	Permit Filing Fees	4520-37450 (1050)	38.00	38.00	.00	38.00
831	Engin.-Plan Check Fees	4225-37160 (6319)	75.00	75.00	.00	75.00

**** See application for additional requirements ****

INSPECTIONS

510-749-5840

NOTE: All construction within the public right of way must have barricades with flashers for night time protection.

This is to certify that the above work has been completed to my satisfaction and approval.

Date

Inspector

950 West Mall Square, #110

CITY OF ALAMEDA

(510) 749-5840

Alameda Point
Alameda, CA 94501

Public Works Department

Fax (510) 749-5867

dated: 11-28-2001

Encroachment Permit

Permit #
EN01-0065

Applicant

PRECISION SAMPLING
1400 2. 60TH ST
RICHMOND CA
94804
800-671-4744

Contractor Information

Owner Information

LESLIE SALT CX
7220 CENTRAL AVE
NEWARK CA

94560

Project Information

ENCROACH - Encroachment Permit - **APPROVED**
Sub-Type:

Applied: 11/28/2001
Finaled:

Issued: 11/28/2001
Expires: 11/28/2002
Valuation: \$0.00

Job Address: 2016 CLEMENT AVE
071 025600402
Suite / Unit:

Parcel Number:

Work Description: 5 BORINGS & 1 WELL, FINISHED AT GRADE (EX01-0176)

Total Fees: \$38.00
Total Payments: \$38.00
BALANCE DUE \$0.00

Payments Made: 11/28/2001 11:19 AM
Total Payment: **\$38.00**

RECEIPT

Receipt #: R01-5833

Payee: CONOR PACIFIC

Current Payment Made to the Following Items:

Account Code	Description	Amount
4520-37450 (1050)	Permit Filing Fees	38.00

Payments Made for this Receipt:

Type	Method	Description	Amount
Payment	Check	549	38.00

Account Summary for Fees and Payments:

Item#	Description	Account Code	Tot Fee	Paid	Prev. Pmts	Cur. Pmts
250	Permit Filing Fees	4520-37450 (1050)	38.00	38.00	.00	38.00

INSPECTIONS

510-749-5840

Call for an inspection when work is complete.

This is to certify that the above work has been completed to my satisfaction and approval.

Date

Inspector

11/13/2001 14:18
MAY-8-99 THU 14:25

6583863815

CONDOR PACIFIC

PAGE 02
P. 02

ZONE 7 WATER AGENCY WELL FAX NO. 510+462+3914



ZONE 7 WATER AGENCY

3887 PARKSIDE DRIVE, PLEASANTON, CALIFORNIA 94586-8127

PHONE (510) 484-2500 X235
FAX (510) 482-3814

*ACPWA 399 Elm Street St
Alameda, CA 94504*

DRILLING PERMIT APPLICATION

PH (510) 690-5554

FX (510) 282-1939

FOR OFFICE USE

FOR APPLICANT TO COMPLETE

LOCATION OF PROJECT 2016 Clement Ave
Alameda, CA

PERMIT NUMBER W01-1057

WELL NUMBER _____

APN _____

California Coordinates Source _____ ft. Accuracy ± _____ ft.
CCN _____ ft. OCE _____ ft.
APN 71-256-82 *21-0000 city of Alameda*

PERMIT CONDITIONS

Circle Permit Requirements Apply

CLIENT

Name Carroll Salt
Address 2270 Central Ave Phone 510-790-8625
City Newark, CA Zip 94560-4206

APPLICANT

Name Martha Watson
Address 2580 WYANDOTT ST, 5TH FL Phone 456-86-3828
City Waltham, MA Zip 02453

TYPE OF PROJECT

Well Construction Geotechnical Investigation
Cathodic Protection General
Water Supply Contamination
Monitoring Well Destruction

PROPOSED WATER SUPPLY WELL USE

New Domestic Replacement Domestic
Municipal Irrigation
Industrial Other _____

DRILLING METHOD:

Mud Rotary Air Rotary Auger
Cable Other
Direct push

DRILLER'S LICENSE NO. 636387

WELL PROJECTS

Drill Hole Diameter 3 in. Maximum 10 ft.
Casing Diameter 1 in. Depth 20 ft.
Surface Seal Depth 2 ft. Number 1

GEOTECHNICAL PROJECTS

Number of Boring 5 Maximum 10 ft.
Hole Diameter 3 in. Depth 20 ft.

ESTIMATED STARTING DATE November 19, 2001
ESTIMATED COMPLETION DATE Nov 21, 2001

I hereby agree to comply with all requirements of this permit and Alameda County Ordinance No. 73-68.

APPLICANT'S SIGNATURE

Martha J. Watson Date 11/9/01

A. GENERAL

- 1. A permit application should be submitted so as to arrive at the Zone 7 office five days prior to proposed starting date.
- 2. Submit to Zone 7 within 60 days after completion of permitted work the original Department of Water Resources Water Well Drillers Report or equivalent for well projects, or drilling logs and location sketch for geotechnical projects.
- 3. Permit is void if project not begun within 60 days of approval date.

B. WATER SUPPLY WELLS

- 1. Minimum surface seal thickness is two inches of cement grout placed by tremie.
- 2. Minimum seal depth is 50 feet for municipal and industrial wells or 20 feet for domestic and irrigation wells unless lesser depth is specially approved.

GROUNDWATER MONITORING WELLS INCLUDING PIEZOMETERS

- 1. Minimum surface seal thickness is two inches of cement grout placed by tremie.
- 2. Minimum seal depth for monitoring wells is the maximum depth practicable or 20 feet.

GEOTECHNICAL. Backfill bore hole with compacted cuttings; heavy bentonite and upper two feet with compacted material. Areas of known or suspected contamination, tremied cement grout shall be used in place of compacted cuttings.

E. CATHODIC

Fill hole above anode zone with concrete placed by tremie.

F. WELL DESTRUCTION

See attached.

G. SPECIAL CONDITIONS

Approved _____ Date 11-13-01

APPENDIX B

**HYDROSTRATIGRAPHIC PROFILES, WELL CONSTRUCTION DETAILS,
WELL DEVELOPMENT LOG, SURVEY RESULTS**

Well	Sample Designation	FID	Odor	Blows/Run	Recovery	Sample	Water	Depth (feet)	Lithology	Structures	Name & Unit	USCS	Color (abbrev.)	Color (Munsell)	Fines (%)				Fines Plasticity			Sand			Grvl.			Hardness - Clays (Density - Sands)					Moisture			Remarks		
															80 60 40 20		L M H			F M C			well mod. poor			v.sft (v.1g)		sft (1g)		v.sft (dries)		sft (dries)		v.sft (dries)			D M W	
															20	40	60	80																				
		K	Z					1	SP		SM	vdgb	10YR 3/2																					Fill - gtz gravel				
			Z					2																									FID measurements in parts per million					
		K	Z					3			SP	dgb	10YR 4/2																									
	1914B3@3.8	K	Z					4																														
			Z					5																														
	Static @ 12:20	K	Z					6			SM																											
			Z					7			SC																											
	1914B3@7.9	K	Z					8			SP	db	10YR 4/3																									
			Z					9																														
								10																														

Hydrostratigraphic Profile

Boring No. 1914 B3
Sheet 1 of 1

Borehole Total Depth (Ft.): 9.75
Final Borehole Dia. (in.): 3.5
Logged by: TLU Checked by: _____
Ground Elev.: _____ T.O.C. Elev.: _____
Coordinates N: _____ E: _____
Drilling Method & Summary: Hand Auger to 9.75 ft. Backfilled 9.75 to 5.5 ft. with cuttings; 5.5 to 2 ft. with bentonite hole plug; 2 to ground surface with shallow cuttings.

Site: 1914 Chestnut St. Alameda
Client: Cargill Salt
Boring No. 1914B3
Well No. 2
Project No. CRA102
Date(s) Drilled: 11/16/01
Date(s) Well Inst.: TLU
Drilling Co./Driller: TLU

Conor Pacific 

Odor: N=none, F=faint, M=moderate, S=strong

D=dry; damp; M=moist; v. moist; W=wet

Well	Sample Designation	FID	Odor	Blows/Run	Recovery	Sample	Water	Depth (feet)	Lithology	Structures	Name & Unit	USCS	Color (abbrev.)	Color (Munsell)	Fines (%)				Fines Plasticity			Sand			Grvl.			Hardness - Clays (Density - Sands)					Moisture			Remarks		
															80	60	40	20	L	M	H	F	M	C	F	C	well	mod.	poor	v.stf (v.%)	stf (v.%)	stf (v.%)	v.stf (v.%)	stf (v.%)	D		M	W
															Sand & Grvl.																							
								1			CONCRETE BASE ROCK																											
								2			SILTY SAND (FILL)	SM	dyb	10YR 3/3																								
								3																														
								4																														
								5			SAND, POORLY GRADED	SP	b	10YR 5/3																								
								6																														
								7																														
								8																														
								9			CLAYEY SAND	SC	dyb	10YR 4/4																								
								10																														
								11																														
								12																														
								13																														
								14			SILTY SAND	SM	dyb	10YR 4/6																								
								15																														
								16			SAND, POORLY GRADED	SP																										
								17																														
								18																														
								19																														
								20																														
								21																														
								22																														

Odor: N=none, F=faint, M=moderate, S=strong

D=dry; damp; M=moist; v. moist; W=wet

Hydrostratigraphic Profile

Boring No. B17
Sheet 1 of 1

Borehole Total Depth (Ft.): 22
Final Borehole Dia. (in.): 2
Logged by: MTM Checked by: _____
Ground Elev.: _____ T.O.C. Elev.: _____
Coordinates N: _____ E: _____
Drilling Method & Summary:
DIRECT PUSH CORING
BACKFILLED W/ CEMENT GROUT
ASPHALT PATCH

Site: 2016 CEMENT
Client: CARILL ALAMEDA
Boring No. B17
Well No. _____
Project No. CR102
Date(s) Drilled: 12/4/01
Date(s) Well Inst.: _____
Drilling Co./Driller: PRECISION

Conor Pacific



BORING DESIGNATION: B-21/MW-4

INSTALLATION

DATE: 12/7/01

BY: mgw

DIMENSIONS

A	Total Depth of Boring (ft.)	<u>19</u>
B	Borehole Diameter (in.)	<u>2.5</u>
C	Well Casing Diameter (in.)	<u>1</u>
D	Well Casing Length (ft.)	<u>18.5</u>
E	Well Casing Slotted Interval (ft.)	<u>10</u>
F	Well Casing End Cap or Sump (ft.)	<u>0.1</u>
G	Annular Seal Interval (ft.)	<u>3.5</u>
H	Annular Seal Interval (ft.)	<u>2.0</u>
I	Sand Pack Interval (ft.)	<u>11</u>
J	Bottom Material Interval (ft.)	<u>0.5</u>
K	Conductor Casing Interval (ft.)	<u>NA</u>
L	Protective Cover Diameter (in.)	<u>7</u>
M	Conductor Casing Diameter (in.)	<u>NA</u>
N	Upper Borehole Diameter (in.)	<u>NA</u>
O	Monument Footing Interval (ft.)	<u>1</u>
	Well Centralizer Depth(s) (ft.)	<u>NA</u>

MATERIALS DATA

Monument Footing	①	<u>CEMENT</u>
Annular Seal	②	<u>NA</u>
Annular Seal	③	<u>CEMENT</u>
Annular Seal	④	<u>BENTONITE</u>
Sand Pack	⑤	<u>#30 SAND</u>
Bottom Material	⑥	<u>NATIVE</u>
Conductor Casing		<u>-</u>
Slotted Casing		<u>0.010" PVC</u>
Well Casing		<u>1"-DIA PVC</u>
Well Centralizers		<u>-</u>
Protective Cover		<u>STEEL</u>

WELL DESIGNATION
MW-4

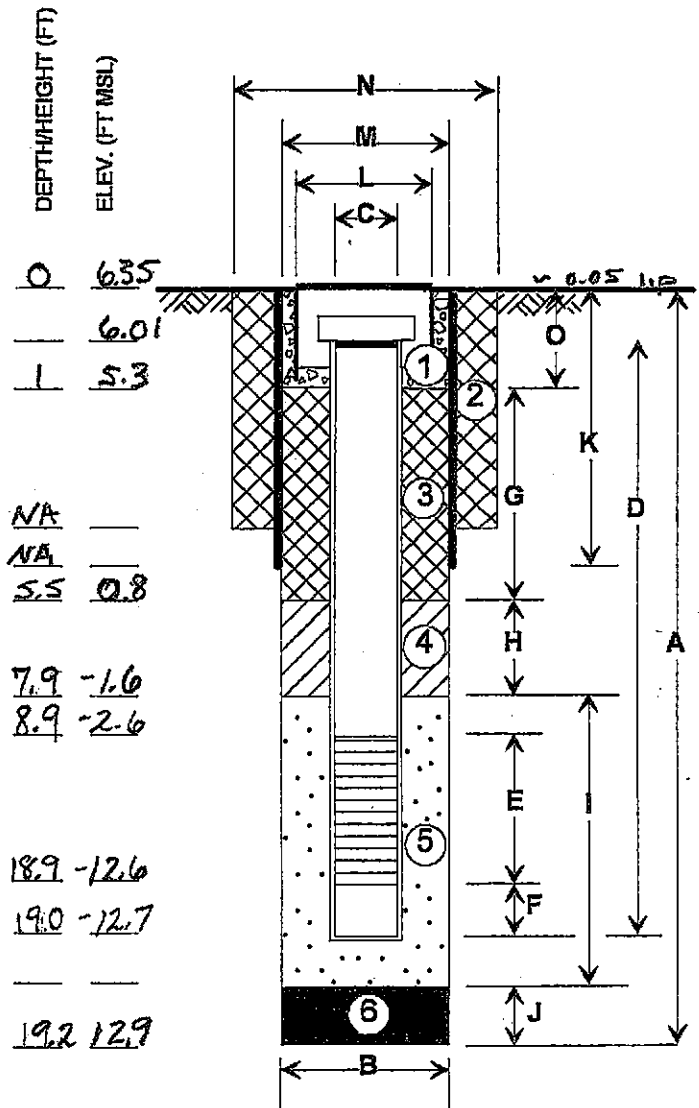

SECTION VIEW (not to scale)

NOTES:



WELL DEVELOPMENT FIELD DATA

Project: CS1605
 STATION NO.: CS1605
 STATION NAME: Alameda facility
 COUNTY: Alameda CA
 DISTRICT: Cargill Salt

WELL ID: MW-4
 SAMPLE ID: MW-4
 DATE DEVELOPED: 12.17.01
 DATE SAMPLED: 12.17.01

WELL INFORMATION - Gallons per linear ft for casing diameter of: 2" = 0.163 4" = 0.653 4.5" = 0.83 6" = 1.5 8" = 2.6
 Casing diameter (in): 1.0 Depth to liquid (ft): 2.55 Well depth (ft): 16.62 One casing volume (gal): 0.65
 Screened interval (ft): _____ Wetted screen length (ft): _____ Pump rate: 0.13 (gal ~~liters~~ /min)

SWABBING SCREENS Start time (2400 Hr): 11:05 End time (2400 Hr): 11:15
 Well depth following surge blocking (ft): 16.65 Hard bottom reached (Y/N): (Y)

REMOVING SOLIDS/WATER Start Time (2400 Hr): 11:20 End time (2400 Hr): 12:27

ES-submersible _____ Grundfos-submersible _____ Centrifugal _____ PVC bailer _____ Stainless bailer _____ Hand auger _____
 Well depth following solids/water removal (ft): 16.65 Hard bottom reached (Y/N): (Y)
 Volume purged: 1,000 (gal) Solids/water disposal: contained in plastic bucket onsite

Time (2400 Hr)	Volume (gals)	DTW (ft)	Temp (°C)	pH (std. units)	EC (µS@25°C)	DO (mg/l)	Turbidity (NTU)	ORP (mV)	Comments (i.e. color/odor)
500	4.32	18.6	6.66	868	1.68	71000	44	Cloudy Brown	
1000	8.49	19.6	6.70	849	1.22	680	41	Cloudy Lt Brown	
Well cleared and solids have removed. Began sample purge.									
1149	2500	9.35	19.9	6.68	851	0.29	160	26	cloudy
1205	5,000	9.35	20.0	6.69	842	0.24	50.3	34	Clear
1227	8,000	9.35	19.9	6.70	850	0.22	31.2	34	Clear
. removed 9 liters from well (develop + sample)									

WELL SAMPLING: Start Time (2400 Hr): 1228 End Time (2400 Hr): 1231

Equipment used: Peristaltic X Grundfos _____ Teflon bailer _____ PVC bailer _____ Dedicated _____
 QC samples collected at well: None Samples filtered through 0.45µm filter: None

REMARKS: 1-inch well inside 2-inch casing, grab well w/ tubing and check valve. Removed silt with peristaltic pump. Settable solids went from 10% to 2%. Well cleared up after 1000 milliliters. Began micro-purge and sample. Liquid level stabilized at 9.35 feet following initial draw-down.

Developed and sampled by (print): J. Butera
 Signature: [Signature]

Reviewed by: [Signature]
 Page 1 of 1

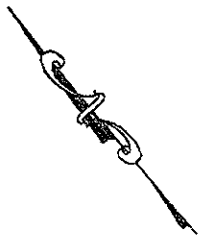

DATE: 12-3-99
 12-21-2001 added curbs, fence, MW-4

GRAPHIC SCALE

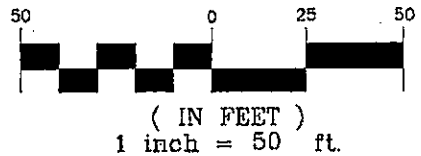

CLEMENT AVE.

BENCHMARK- CITY OF ALAMEDA DATUM
 EL=6.84 *
 SUBTRACT 3.41' FOR USC&GS DATUM

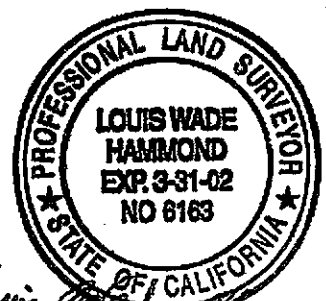
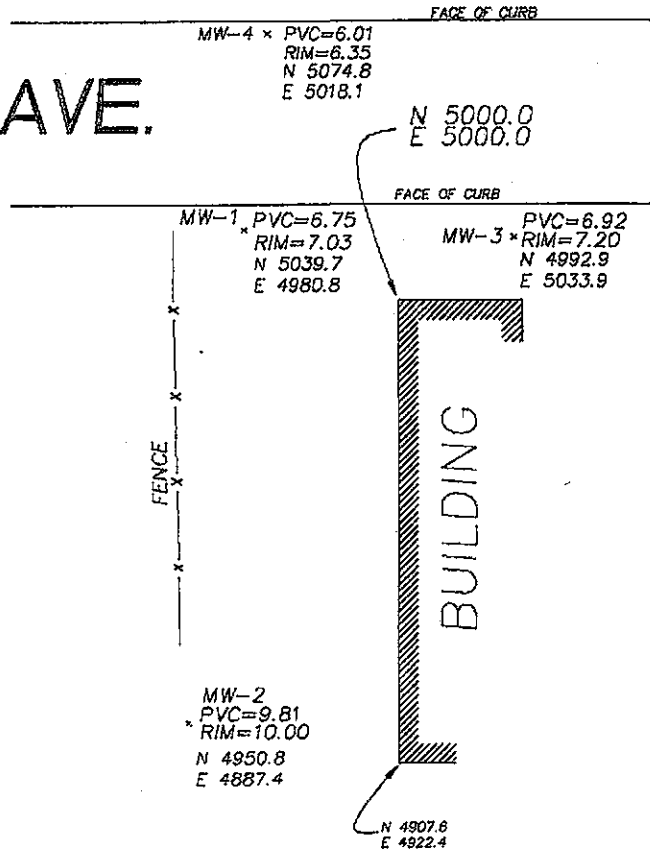

Louis Wade Hammond

L. Wade Hammond
 Licensed Land Surveyor
 No. 6163

36660 Newark Blvd. Suite D
 Newark, California
 94560

Tel: (510) 739-1600
 Fax: (510) 739-1620

WELL SURVEY

CARGILL SALT DISPENSING DIVISION
 2016 CLEMENT AVE.
 ALAMEDA, CA

APPENDIX C

CERTIFIED ANALYTICAL REPORTS



Sequoia Analytical

1455 McDowell Blvd. North, Ste. D
Petaluma, CA 94954
(707) 792-1865
FAX (707) 792-0342
www.sequoialabs.com

December 07 , 2001

Tom Vercoutere
Conor Pacific / EFW
2580 Wyandotte St., Suite G
Mountain View, CA 94043
RE: Cargill Salt / P111463

Enclosed are the results of analyses for samples received by the laboratory on 11/20/01. If you have any questions concerning this report, please feel free to contact me.

Sincerely,

Michelle M. Wiita
Project Manager

CA ELAP Certificate Number 2374





Conor Pacific / EFW
2580 Wyandotte St., Suite G
Mountain View CA, 94043

Project: Cargill Salt
Project Number: CRA102
Project Manager: Tom Vercoutere

Reported:
12/07/01 10:13

ANALYTICAL REPORT FOR SAMPLES

Sample ID	Laboratory ID	Matrix	Date Sampled	Date Received
1914B1@2.5-3.0	P111463-01	Soil	11/19/01 09:20	11/20/01 15:00
1914B1@8.0-8.5	P111463-02	Soil	11/19/01 10:15	11/20/01 15:00
1914B2@2.5-3.0	P111463-03	Soil	11/19/01 09:40	11/20/01 15:00
1914B2@6.7-7.2	P111463-04	Soil	11/19/01 10:05	11/20/01 15:00
1914B3@3.8-4.3	P111463-05	Soil	11/19/01 11:10	11/20/01 15:00
1914B3@7.9-8.4	P111463-06	Soil	11/19/01 12:00	11/20/01 15:00
1914B4@7.0-7.5	P111463-07	Soil	11/19/01 12:00	11/20/01 15:00
1914B4@2.7-3.2	P111463-08	Soil	11/19/01 11:30	11/20/01 15:00
1914B5@3.0-3.5	P111463-09	Soil	11/19/01 12:55	11/20/01 15:00
1914B5@8-8.5	P111463-10	Soil	11/19/01 13:30	11/20/01 15:00
1914B6@2.8-3.3	P111463-11	Soil	11/19/01 12:55	11/20/01 15:00
1914B6@7.5-8.0	P111463-12	Soil	11/19/01 13:30	11/20/01 15:00





Conor Pacific / EFW
2580 Wyandotte St., Suite G
Mountain View CA, 94043

Project: Cargill Salt
Project Number: CRA102
Project Manager: Tom Vercoutere

Reported:
12/07/01 10:13

**Volatile Organics by EPA Method 8021B
Sequoia Analytical - Walnut Creek**

Analyte	Result	MDL	Reporting		Dilution	Batch	Prepared	Analyzed	Method	Notes
			Limit	Units						
1914B1@2.5-3.0 (P111463-01) Soil Sampled: 11/19/01 09:20 Received: 11/20/01 15:00										
Chloromethane	ND	0.15	0.20	mg/kg	100	1K26005	11/26/01	11/28/01	EPA 8021B	
Vinyl chloride	ND	0.090	0.20	"	"	"	"	"	"	
Bromomethane	ND	0.19	0.50	"	"	"	"	"	"	
Chloroethane	ND	0.15	0.20	"	"	"	"	"	"	
Trichlorofluoromethane	ND	0.10	0.20	"	"	"	"	"	"	
1,1-Dichloroethene	ND	0.14	0.20	"	"	"	"	"	"	
Methylene chloride	ND	0.37	1.0	"	"	"	"	"	"	
trans-1,2-Dichloroethene	ND	0.14	0.20	"	"	"	"	"	"	
1,1-Dichloroethane	ND	0.080	0.20	"	"	"	"	"	"	
cis-1,2-Dichloroethene	ND	0.13	0.20	"	"	"	"	"	"	
Chloroform	ND	0.071	0.20	"	"	"	"	"	"	
1,1,1-Trichloroethane	ND	0.20	0.50	"	"	"	"	"	"	
Carbon tetrachloride	ND	0.19	0.50	"	"	"	"	"	"	
1,2-Dichloroethane	ND	0.10	0.20	"	"	"	"	"	"	
Trichloroethene	ND	0.16	0.50	"	"	"	"	"	"	
1,2-Dichloropropane	ND	0.14	0.50	"	"	"	"	"	"	
Bromodichloromethane	ND	0.13	0.20	"	"	"	"	"	"	
cis-1,3-Dichloropropene	ND	0.13	0.20	"	"	"	"	"	"	
trans-1,3-Dichloropropene	ND	0.10	0.20	"	"	"	"	"	"	
1,1,2-Trichloroethane	ND	0.083	0.20	"	"	"	"	"	"	
Tetrachloroethene	ND	0.19	0.50	"	"	"	"	"	"	
Dibromochloromethane	ND	0.070	0.20	"	"	"	"	"	"	
1,2-Dibromoethane	ND	0.23	0.50	"	"	"	"	"	"	
Chlorobenzene	ND	0.35	0.50	"	"	"	"	"	"	
Bromoform	ND	0.063	0.10	"	"	"	"	"	"	
1,1,2,2-Tetrachloroethane	ND	0.060	0.10	"	"	"	"	"	"	
1,3-Dichlorobenzene	ND	0.064	0.10	"	"	"	"	"	"	
1,4-Dichlorobenzene	ND	0.052	0.10	"	"	"	"	"	"	
1,2-Dichlorobenzene	ND	0.068	0.10	"	"	"	"	"	"	
Surrogate: 1-Chloro-2-fluorobenzene		85 %	50-150			"	"	"	"	
Surrogate: 4-Bromofluorobenzene		99 %	50-150			"	"	"	"	





Conor Pacific / EFW
 2580 Wyandotte St., Suite G
 Mountain View CA, 94043

Project: Cargill Salt
 Project Number: CRA102
 Project Manager: Tom Vercoutere

Reported:
 12/07/01 10:13

Volatile Organics by EPA Method 8021B Sequoia Analytical - Walnut Creek

Analyte	Result	MDL	Reporting		Dilution	Batch	Prepared	Analyzed	Method	Notes
			Limit	Units						
1914B1@8.0-8.5 (P111463-02) Soil Sampled: 11/19/01 10:15 Received: 11/20/01 15:00										
Chloromethane	ND	0.15	0.20	mg/kg	100	1K26005	11/26/01	11/28/01	EPA 8021B	
Vinyl chloride	ND	0.090	0.20	"	"	"	"	"	"	
Bromomethane	ND	0.19	0.50	"	"	"	"	"	"	
Chloroethane	ND	0.15	0.20	"	"	"	"	"	"	
Trichlorofluoromethane	ND	0.10	0.20	"	"	"	"	"	"	
1,1-Dichloroethene	ND	0.14	0.20	"	"	"	"	"	"	
Methylene chloride	ND	0.37	1.0	"	"	"	"	"	"	
trans-1,2-Dichloroethene	ND	0.14	0.20	"	"	"	"	"	"	
1,1-Dichloroethane	ND	0.080	0.20	"	"	"	"	"	"	
cis-1,2-Dichloroethene	ND	0.13	0.20	"	"	"	"	"	"	
Chloroform	ND	0.071	0.20	"	"	"	"	"	"	
1,1,1-Trichloroethane	ND	0.20	0.50	"	"	"	"	"	"	
Carbon tetrachloride	ND	0.19	0.50	"	"	"	"	"	"	
1,2-Dichloroethane	ND	0.10	0.20	"	"	"	"	"	"	
Trichloroethene	ND	0.16	0.50	"	"	"	"	"	"	
1,2-Dichloropropane	ND	0.14	0.50	"	"	"	"	"	"	
Bromodichloromethane	ND	0.13	0.20	"	"	"	"	"	"	
cis-1,3-Dichloropropene	ND	0.13	0.20	"	"	"	"	"	"	
trans-1,3-Dichloropropene	ND	0.10	0.20	"	"	"	"	"	"	
1,1,2-Trichloroethane	ND	0.083	0.20	"	"	"	"	"	"	
Tetrachloroethene	ND	0.19	0.50	"	"	"	"	"	"	
Dibromochloromethane	ND	0.070	0.20	"	"	"	"	"	"	
1,2-Dibromoethane	ND	0.23	0.50	"	"	"	"	"	"	
Chlorobenzene	ND	0.35	0.50	"	"	"	"	"	"	
Bromoform	ND	0.063	0.10	"	"	"	"	"	"	
1,1,2,2-Tetrachloroethane	ND	0.060	0.10	"	"	"	"	"	"	
1,3-Dichlorobenzene	ND	0.064	0.10	"	"	"	"	"	"	
1,4-Dichlorobenzene	ND	0.052	0.10	"	"	"	"	"	"	
1,2-Dichlorobenzene	ND	0.068	0.10	"	"	"	"	"	"	
Surrogate: 1-Chloro-2-fluorobenzene		92 %	50-150			"	"	"	"	
Surrogate: 4-Bromofluorobenzene		105 %	50-150			"	"	"	"	





Conor Pacific / EFW
2580 Wyandotte St., Suite G
Mountain View CA, 94043

Project: Cargill Salt
Project Number: CRA102
Project Manager: Tom Vercoutere

Reported:
12/07/01 10:13

**Volatile Organics by EPA Method 8021B
Sequoia Analytical - Walnut Creek**

Analyte	Result	MDL	Reporting		Dilution	Batch	Prepared	Analyzed	Method	Notes
			Limit	Units						
1914B2@2.5-3.0 (P111463-03) Soil Sampled: 11/19/01 09:40 Received: 11/20/01 15:00										
Chloromethane	ND	0.15	0.20	mg/kg	100	1K26005	11/26/01	11/28/01	EPA 8021B	
Vinyl chloride	ND	0.090	0.20	"	"	"	"	"	"	
Bromomethane	ND	0.19	0.50	"	"	"	"	"	"	
Chloroethane	ND	0.15	0.20	"	"	"	"	"	"	
Trichlorofluoromethane	ND	0.10	0.20	"	"	"	"	"	"	
1,1-Dichloroethene	ND	0.14	0.20	"	"	"	"	"	"	
Methylene chloride	ND	0.37	1.0	"	"	"	"	"	"	
trans-1,2-Dichloroethene	ND	0.14	0.20	"	"	"	"	"	"	
1,1-Dichloroethane	ND	0.080	0.20	"	"	"	"	"	"	
cis-1,2-Dichloroethene	ND	0.13	0.20	"	"	"	"	"	"	
Chloroform	ND	0.071	0.20	"	"	"	"	"	"	
1,1,1-Trichloroethane	ND	0.20	0.50	"	"	"	"	"	"	
Carbon tetrachloride	ND	0.19	0.50	"	"	"	"	"	"	
1,2-Dichloroethane	ND	0.10	0.20	"	"	"	"	"	"	
Trichloroethene	ND	0.16	0.50	"	"	"	"	"	"	
1,2-Dichloropropane	ND	0.14	0.50	"	"	"	"	"	"	
Bromodichloromethane	ND	0.13	0.20	"	"	"	"	"	"	
cis-1,3-Dichloropropene	ND	0.13	0.20	"	"	"	"	"	"	
trans-1,3-Dichloropropene	ND	0.10	0.20	"	"	"	"	"	"	
1,1,2-Trichloroethane	ND	0.083	0.20	"	"	"	"	"	"	
Tetrachloroethene	ND	0.19	0.50	"	"	"	"	"	"	
Dibromochloromethane	ND	0.070	0.20	"	"	"	"	"	"	
1,2-Dibromoethane	ND	0.23	0.50	"	"	"	"	"	"	
Chlorobenzene	ND	0.35	0.50	"	"	"	"	"	"	
Bromoform	ND	0.063	0.10	"	"	"	"	"	"	
1,1,2,2-Tetrachloroethane	ND	0.060	0.10	"	"	"	"	"	"	
1,3-Dichlorobenzene	ND	0.064	0.10	"	"	"	"	"	"	
1,4-Dichlorobenzene	ND	0.052	0.10	"	"	"	"	"	"	
1,2-Dichlorobenzene	ND	0.068	0.10	"	"	"	"	"	"	
Surrogate: 1-Chloro-2-fluorobenzene		95 %	50-150			"	"	"	"	
Surrogate: 4-Bromofluorobenzene		108 %	50-150			"	"	"	"	





Conor Pacific / EFW
2580 Wyandotte St., Suite G
Mountain View CA, 94043

Project: Cargill Salt
Project Number: CRA102
Project Manager: Tom Vercoutere

Reported:
12/07/01 10:13

**Volatile Organics by EPA Method 8021B
Sequoia Analytical - Walnut Creek**

Analyte	Result	MDL	Reporting		Dilution	Batch	Prepared	Analyzed	Method	Notes
			Limit	Units						
1914B2@6.7-7.2 (P111463-04) Soil Sampled: 11/19/01 10:05 Received: 11/20/01 15:00										
Chloromethane	ND	0.15	0.20	mg/kg	100	1K26005	11/26/01	11/28/01	EPA 8021B	
Vinyl chloride	ND	0.090	0.20	"	"	"	"	"	"	
Bromomethane	ND	0.19	0.50	"	"	"	"	"	"	
Chloroethane	ND	0.15	0.20	"	"	"	"	"	"	
Trichlorofluoromethane	ND	0.10	0.20	"	"	"	"	"	"	
1,1-Dichloroethene	ND	0.14	0.20	"	"	"	"	"	"	
Methylene chloride	ND	0.37	1.0	"	"	"	"	"	"	
trans-1,2-Dichloroethene	ND	0.14	0.20	"	"	"	"	"	"	
1,1-Dichloroethane	ND	0.080	0.20	"	"	"	"	"	"	
cis-1,2-Dichloroethene	ND	0.13	0.20	"	"	"	"	"	"	
Chloroform	ND	0.071	0.20	"	"	"	"	"	"	
1,1,1-Trichloroethane	ND	0.20	0.50	"	"	"	"	"	"	
Carbon tetrachloride	ND	0.19	0.50	"	"	"	"	"	"	
1,2-Dichloroethane	ND	0.10	0.20	"	"	"	"	"	"	
Trichloroethene	ND	0.16	0.50	"	"	"	"	"	"	
1,2-Dichloropropane	ND	0.14	0.50	"	"	"	"	"	"	
Bromodichloromethane	ND	0.13	0.20	"	"	"	"	"	"	
cis-1,3-Dichloropropene	ND	0.13	0.20	"	"	"	"	"	"	
trans-1,3-Dichloropropene	ND	0.10	0.20	"	"	"	"	"	"	
1,1,2-Trichloroethane	ND	0.083	0.20	"	"	"	"	"	"	
Tetrachloroethene	ND	0.19	0.50	"	"	"	"	"	"	
Dibromochloromethane	ND	0.070	0.20	"	"	"	"	"	"	
1,2-Dibromoethane	ND	0.23	0.50	"	"	"	"	"	"	
Chlorobenzene	ND	0.35	0.50	"	"	"	"	"	"	
Bromoform	ND	0.063	0.10	"	"	"	"	"	"	
1,1,2,2-Tetrachloroethane	ND	0.060	0.10	"	"	"	"	"	"	
1,3-Dichlorobenzene	ND	0.064	0.10	"	"	"	"	"	"	
1,4-Dichlorobenzene	ND	0.052	0.10	"	"	"	"	"	"	
1,2-Dichlorobenzene	ND	0.068	0.10	"	"	"	"	"	"	
Surrogate: 1-Chloro-2-fluorobenzene		71 %	50-150			"	"	"	"	
Surrogate: 4-Bromofluorobenzene		79 %	50-150			"	"	"	"	





Conor Pacific / EFW
 2580 Wyandotte St., Suite G
 Mountain View CA, 94043

Project: Cargill Salt
 Project Number: CRA102
 Project Manager: Tom Vercoutere

Reported:
 12/07/01 10:13

Volatile Organics by EPA Method 8021B Sequoia Analytical - Walnut Creek

Analyte	Result	Reporting		Units	Dilution	Batch	Prepared	Analyzed	Method	Notes
		MDL	Limit							
1914B3@3.8-4.3 (P111463-05) Soil Sampled: 11/19/01 11:10 Received: 11/20/01 15:00										
Chloromethane	ND	0.15	0.20	mg/kg	100	1K26005	11/26/01	11/28/01	EPA 8021B	
Vinyl chloride	ND	0.090	0.20	"	"	"	"	"	"	
Bromomethane	ND	0.19	0.50	"	"	"	"	"	"	
Chloroethane	ND	0.15	0.20	"	"	"	"	"	"	
Trichlorofluoromethane	ND	0.10	0.20	"	"	"	"	"	"	
1,1-Dichloroethene	ND	0.14	0.20	"	"	"	"	"	"	
Methylene chloride	ND	0.37	1.0	"	"	"	"	"	"	
trans-1,2-Dichloroethene	ND	0.14	0.20	"	"	"	"	"	"	
1,1-Dichloroethane	ND	0.080	0.20	"	"	"	"	"	"	
cis-1,2-Dichloroethene	ND	0.13	0.20	"	"	"	"	"	"	
Chloroform	ND	0.071	0.20	"	"	"	"	"	"	
1,1,1-Trichloroethane	ND	0.20	0.50	"	"	"	"	"	"	
Carbon tetrachloride	ND	0.19	0.50	"	"	"	"	"	"	
1,2-Dichloroethane	ND	0.10	0.20	"	"	"	"	"	"	
Trichloroethene	ND	0.16	0.50	"	"	"	"	"	"	
1,2-Dichloropropane	ND	0.14	0.50	"	"	"	"	"	"	
Bromodichloromethane	ND	0.13	0.20	"	"	"	"	"	"	
cis-1,3-Dichloropropene	ND	0.13	0.20	"	"	"	"	"	"	
trans-1,3-Dichloropropene	ND	0.10	0.20	"	"	"	"	"	"	
1,1,2-Trichloroethane	ND	0.083	0.20	"	"	"	"	"	"	
Tetrachloroethene	ND	0.19	0.50	"	"	"	"	"	"	
Dibromochloromethane	ND	0.070	0.20	"	"	"	"	"	"	
1,2-Dibromoethane	ND	0.23	0.50	"	"	"	"	"	"	
Chlorobenzene	ND	0.35	0.50	"	"	"	"	"	"	
Bromoform	ND	0.063	0.10	"	"	"	"	"	"	
1,1,2,2-Tetrachloroethane	ND	0.060	0.10	"	"	"	"	"	"	
1,3-Dichlorobenzene	ND	0.064	0.10	"	"	"	"	"	"	
1,4-Dichlorobenzene	ND	0.052	0.10	"	"	"	"	"	"	
1,2-Dichlorobenzene	ND	0.068	0.10	"	"	"	"	"	"	
Surrogate: 1-Chloro-2-fluorobenzene		93 %	50-150			"	"	"	"	
Surrogate: 4-Bromofluorobenzene		103 %	50-150			"	"	"	"	





Conor Pacific / EFW
2580 Wyandotte St., Suite G
Mountain View CA, 94043

Project: Cargill Salt
Project Number: CRA102
Project Manager: Tom Vercoutere

Reported:
12/07/01 10:13

**Volatile Organics by EPA Method 8021B
Sequoia Analytical - Walnut Creek**

Analyte	Result	MDL	Reporting		Units	Dilution	Batch	Prepared	Analyzed	Method	Notes
			Limit								
1914B3@7.9-8.4 (P111463-06) Soil Sampled: 11/19/01 12:00 Received: 11/20/01 15:00											
Chloromethane	ND	0.15	0.20		mg/kg	100	1K26005	11/26/01	11/28/01	EPA 8021B	
Vinyl chloride	ND	0.090	0.20		"	"	"	"	"	"	
Bromomethane	ND	0.19	0.50		"	"	"	"	"	"	
Chloroethane	ND	0.15	0.20		"	"	"	"	"	"	
Trichlorofluoromethane	ND	0.10	0.20		"	"	"	"	"	"	
1,1-Dichloroethene	ND	0.14	0.20		"	"	"	"	"	"	
Methylene chloride	ND	0.37	1.0		"	"	"	"	"	"	
trans-1,2-Dichloroethene	ND	0.14	0.20		"	"	"	"	"	"	
1,1-Dichloroethane	ND	0.080	0.20		"	"	"	"	"	"	
cis-1,2-Dichloroethene	ND	0.13	0.20		"	"	"	"	"	"	
Chloroform	ND	0.071	0.20		"	"	"	"	"	"	
1,1,1-Trichloroethane	ND	0.20	0.50		"	"	"	"	"	"	
Carbon tetrachloride	ND	0.19	0.50		"	"	"	"	"	"	
1,2-Dichloroethane	ND	0.10	0.20		"	"	"	"	"	"	
Trichloroethene	ND	0.16	0.50		"	"	"	"	"	"	
1,2-Dichloropropane	ND	0.14	0.50		"	"	"	"	"	"	
Bromodichloromethane	ND	0.13	0.20		"	"	"	"	"	"	
cis-1,3-Dichloropropene	ND	0.13	0.20		"	"	"	"	"	"	
trans-1,3-Dichloropropene	ND	0.10	0.20		"	"	"	"	"	"	
1,1,2-Trichloroethane	ND	0.083	0.20		"	"	"	"	"	"	
Tetrachloroethene	ND	0.19	0.50		"	"	"	"	"	"	
Dibromochloromethane	ND	0.070	0.20		"	"	"	"	"	"	
1,2-Dibromoethane	ND	0.23	0.50		"	"	"	"	"	"	
Chlorobenzene	ND	0.35	0.50		"	"	"	"	"	"	
Bromoform	ND	0.063	0.10		"	"	"	"	"	"	
1,1,2,2-Tetrachloroethane	ND	0.060	0.10		"	"	"	"	"	"	
1,3-Dichlorobenzene	ND	0.064	0.10		"	"	"	"	"	"	
1,4-Dichlorobenzene	ND	0.052	0.10		"	"	"	"	"	"	
1,2-Dichlorobenzene	ND	0.068	0.10		"	"	"	"	"	"	
Surrogate: 1-Chloro-2-fluorobenzene		83 %	50-150				"	"	"	"	
Surrogate: 4-Bromofluorobenzene		92 %	50-150				"	"	"	"	





Conor Pacific / EFW
2580 Wyandotte St., Suite G
Mountain View CA, 94043

Project: Cargill Salt
Project Number: CRA102
Project Manager: Tom Vercoutere

Reported:
12/07/01 10:13

**Volatile Organics by EPA Method 8021B
Sequoia Analytical - Walnut Creek**

Analyte	Result	MDL	Reporting		Dilution	Batch	Prepared	Analyzed	Method	Notes
			Limit	Units						
1914B4@7.0-7.5 (P111463-07) Soil Sampled: 11/19/01 12:00 Received: 11/20/01 15:00										
Chloromethane	ND	0.15	0.20	mg/kg	100	1K26005	11/26/01	11/28/01	EPA 8021B	
Vinyl chloride	ND	0.090	0.20	"	"	"	"	"	"	
Bromomethane	ND	0.19	0.50	"	"	"	"	"	"	
Chloroethane	ND	0.15	0.20	"	"	"	"	"	"	
Trichlorofluoromethane	ND	0.10	0.20	"	"	"	"	"	"	
1,1-Dichloroethene	ND	0.14	0.20	"	"	"	"	"	"	
Methylene chloride	ND	0.37	1.0	"	"	"	"	"	"	
trans-1,2-Dichloroethene	ND	0.14	0.20	"	"	"	"	"	"	
1,1-Dichloroethane	ND	0.080	0.20	"	"	"	"	"	"	
cis-1,2-Dichloroethene	ND	0.13	0.20	"	"	"	"	"	"	
Chloroform	ND	0.071	0.20	"	"	"	"	"	"	
1,1,1-Trichloroethane	ND	0.20	0.50	"	"	"	"	"	"	
Carbon tetrachloride	ND	0.19	0.50	"	"	"	"	"	"	
1,2-Dichloroethane	ND	0.10	0.20	"	"	"	"	"	"	
Trichloroethene	ND	0.16	0.50	"	"	"	"	"	"	
1,2-Dichloropropane	ND	0.14	0.50	"	"	"	"	"	"	
Bromodichloromethane	ND	0.13	0.20	"	"	"	"	"	"	
cis-1,3-Dichloropropene	ND	0.13	0.20	"	"	"	"	"	"	
trans-1,3-Dichloropropene	ND	0.10	0.20	"	"	"	"	"	"	
1,1,2-Trichloroethane	ND	0.083	0.20	"	"	"	"	"	"	
Tetrachloroethene	ND	0.19	0.50	"	"	"	"	"	"	
Dibromochloromethane	ND	0.070	0.20	"	"	"	"	"	"	
1,2-Dibromoethane	ND	0.23	0.50	"	"	"	"	"	"	
Chlorobenzene	ND	0.35	0.50	"	"	"	"	"	"	
Bromoform	ND	0.063	0.10	"	"	"	"	"	"	
1,1,1,2-Tetrachloroethane	ND	0.060	0.10	"	"	"	"	"	"	
1,3-Dichlorobenzene	ND	0.064	0.10	"	"	"	"	"	"	
1,4-Dichlorobenzene	ND	0.052	0.10	"	"	"	"	"	"	
1,2-Dichlorobenzene	ND	0.068	0.10	"	"	"	"	"	"	
Surrogate: 1-Chloro-2-fluorobenzene		80 %	50-150			"	"	"	"	
Surrogate: 4-Bromofluorobenzene		92 %	50-150			"	"	"	"	





Conor Pacific / EFW
2580 Wyandotte St., Suite G
Mountain View CA, 94043

Project: Cargill Salt
Project Number: CRA102
Project Manager: Tom Vercoutere

Reported:
12/07/01 10:13

**Volatile Organics by EPA Method 8021B
Sequoia Analytical - Walnut Creek**

Analyte	Result	MDL	Reporting		Dilution	Batch	Prepared	Analyzed	Method	Notes
			Limit	Units						
1914B4@2.7-3.2 (P111463-08) Soil Sampled: 11/19/01 11:30 Received: 11/20/01 15:00										
Chloromethane	ND	0.15	0.20	mg/kg	100	1K26005	11/26/01	11/28/01	EPA 8021B	
Vinyl chloride	ND	0.090	0.20	"	"	"	"	"	"	
Bromomethane	ND	0.19	0.50	"	"	"	"	"	"	
Chloroethane	ND	0.15	0.20	"	"	"	"	"	"	
Trichlorofluoromethane	ND	0.10	0.20	"	"	"	"	"	"	
1,1-Dichloroethene	ND	0.14	0.20	"	"	"	"	"	"	
Methylene chloride	ND	0.37	1.0	"	"	"	"	"	"	
trans-1,2-Dichloroethene	ND	0.14	0.20	"	"	"	"	"	"	
1,1-Dichloroethane	ND	0.080	0.20	"	"	"	"	"	"	
cis-1,2-Dichloroethene	ND	0.13	0.20	"	"	"	"	"	"	
Chloroform	ND	0.071	0.20	"	"	"	"	"	"	
1,1,1-Trichloroethane	ND	0.20	0.50	"	"	"	"	"	"	
Carbon tetrachloride	ND	0.19	0.50	"	"	"	"	"	"	
1,2-Dichloroethane	ND	0.10	0.20	"	"	"	"	"	"	
Trichloroethene	ND	0.16	0.50	"	"	"	"	"	"	
1,2-Dichloropropane	ND	0.14	0.50	"	"	"	"	"	"	
Bromodichloromethane	ND	0.13	0.20	"	"	"	"	"	"	
cis-1,3-Dichloropropene	ND	0.13	0.20	"	"	"	"	"	"	
trans-1,3-Dichloropropene	ND	0.10	0.20	"	"	"	"	"	"	
1,1,2-Trichloroethane	ND	0.083	0.20	"	"	"	"	"	"	
Tetrachloroethene	ND	0.19	0.50	"	"	"	"	"	"	
Dibromochloromethane	ND	0.070	0.20	"	"	"	"	"	"	
1,2-Dibromoethane	ND	0.23	0.50	"	"	"	"	"	"	
Chlorobenzene	ND	0.35	0.50	"	"	"	"	"	"	
Bromoform	ND	0.063	0.10	"	"	"	"	"	"	
1,1,2,2-Tetrachloroethane	ND	0.060	0.10	"	"	"	"	"	"	
1,3-Dichlorobenzene	ND	0.064	0.10	"	"	"	"	"	"	
1,4-Dichlorobenzene	ND	0.052	0.10	"	"	"	"	"	"	
1,2-Dichlorobenzene	ND	0.068	0.10	"	"	"	"	"	"	
Surrogate: 1-Chloro-2-fluorobenzene		101 %	50-150			"	"	"	"	
Surrogate: 4-Bromofluorobenzene		121 %	50-150			"	"	"	"	





Conor Pacific / EFW 2580 Wyandotte St., Suite G Mountain View CA, 94043	Project: Cargill Salt Project Number: CRA102 Project Manager: Tom Vercoutere	Reported: 12/07/01 10:13
---	--	-----------------------------

Volatile Organics by EPA Method 8021B Sequoia Analytical - Walnut Creek

Analyte	Result	MDL	Reporting Limit	Units	Dilution	Batch	Prepared	Analyzed	Method	Notes
1914B5@3.0-3.5 (P111463-09) Soil Sampled: 11/19/01 12:55 Received: 11/20/01 15:00										
Chloromethane	ND	0.15	0.20	mg/kg	100	1K26005	11/26/01	11/28/01	EPA 8021B	
Vinyl chloride	ND	0.090	0.20	"	"	"	"	"	"	
Bromomethane	ND	0.19	0.50	"	"	"	"	"	"	
Chloroethane	ND	0.15	0.20	"	"	"	"	"	"	
Trichlorofluoromethane	ND	0.10	0.20	"	"	"	"	"	"	
1,1-Dichloroethene	ND	0.14	0.20	"	"	"	"	"	"	
Methylene chloride	ND	0.37	1.0	"	"	"	"	"	"	
trans-1,2-Dichloroethene	ND	0.14	0.20	"	"	"	"	"	"	
1,1-Dichloroethane	ND	0.080	0.20	"	"	"	"	"	"	
cis-1,2-Dichloroethene	ND	0.13	0.20	"	"	"	"	"	"	
Chloroform	ND	0.071	0.20	"	"	"	"	"	"	
1,1,1-Trichloroethane	ND	0.20	0.50	"	"	"	"	"	"	
Carbon tetrachloride	ND	0.19	0.50	"	"	"	"	"	"	
1,2-Dichloroethane	ND	0.10	0.20	"	"	"	"	"	"	
Trichloroethene	ND	0.16	0.50	"	"	"	"	"	"	
1,2-Dichloropropane	ND	0.14	0.50	"	"	"	"	"	"	
Bromodichloromethane	ND	0.13	0.20	"	"	"	"	"	"	
cis-1,3-Dichloropropene	ND	0.13	0.20	"	"	"	"	"	"	
trans-1,3-Dichloropropene	ND	0.10	0.20	"	"	"	"	"	"	
1,1,2-Trichloroethane	ND	0.083	0.20	"	"	"	"	"	"	
Tetrachloroethene	ND	0.19	0.50	"	"	"	"	"	"	
Dibromochloromethane	ND	0.070	0.20	"	"	"	"	"	"	
1,2-Dibromoethane	ND	0.23	0.50	"	"	"	"	"	"	
Chlorobenzene	ND	0.35	0.50	"	"	"	"	"	"	
Bromoform	ND	0.063	0.10	"	"	"	"	"	"	
1,1,2,2-Tetrachloroethane	ND	0.060	0.10	"	"	"	"	"	"	
1,3-Dichlorobenzene	ND	0.064	0.10	"	"	"	"	"	"	
1,4-Dichlorobenzene	ND	0.052	0.10	"	"	"	"	"	"	
1,2-Dichlorobenzene	ND	0.068	0.10	"	"	"	"	"	"	
Surrogate: 1-Chloro-2-fluorobenzene		89 %	50-150			"	"	"	"	
Surrogate: 4-Bromofluorobenzene		108 %	50-150			"	"	"	"	





Conor Pacific / EFW
2580 Wyandotte St., Suite G
Mountain View CA, 94043

Project: Cargill Salt
Project Number: CRA102
Project Manager: Tom Vercoutere

Reported:
12/07/01 10:13

**Volatile Organics by EPA Method 8021B
Sequoia Analytical - Walnut Creek**

Analyte	Result	MDL	Reporting Limit	Units	Dilution	Batch	Prepared	Analyzed	Method	Notes
1914B5@8-8.5 (P111463-10) Soil Sampled: 11/19/01 13:30 Received: 11/20/01 15:00										
Chloromethane	ND	0.15	0.20	mg/kg	100	1K26005	11/26/01	11/28/01	EPA 8021B	
Vinyl chloride	ND	0.090	0.20	"	"	"	"	"	"	
Bromomethane	ND	0.19	0.50	"	"	"	"	"	"	
Chloroethane	ND	0.15	0.20	"	"	"	"	"	"	
Trichlorofluoromethane	ND	0.10	0.20	"	"	"	"	"	"	
1,1-Dichloroethene	ND	0.14	0.20	"	"	"	"	"	"	
Methylene chloride	ND	0.37	1.0	"	"	"	"	"	"	
trans-1,2-Dichloroethene	ND	0.14	0.20	"	"	"	"	"	"	
1,1-Dichloroethane	ND	0.080	0.20	"	"	"	"	"	"	
cis-1,2-Dichloroethene	ND	0.13	0.20	"	"	"	"	"	"	
Chloroform	ND	0.071	0.20	"	"	"	"	"	"	
1,1,1-Trichloroethane	ND	0.20	0.50	"	"	"	"	"	"	
Carbon tetrachloride	ND	0.19	0.50	"	"	"	"	"	"	
1,2-Dichloroethane	ND	0.10	0.20	"	"	"	"	"	"	
Trichloroethene	ND	0.16	0.50	"	"	"	"	"	"	
1,2-Dichloropropane	ND	0.14	0.50	"	"	"	"	"	"	
Bromodichloromethane	ND	0.13	0.20	"	"	"	"	"	"	
cis-1,3-Dichloropropene	ND	0.13	0.20	"	"	"	"	"	"	
trans-1,3-Dichloropropene	ND	0.10	0.20	"	"	"	"	"	"	
1,1,2-Trichloroethane	ND	0.083	0.20	"	"	"	"	"	"	
Tetrachloroethene	ND	0.19	0.50	"	"	"	"	"	"	
Dibromochloromethane	ND	0.070	0.20	"	"	"	"	"	"	
1,2-Dibromoethane	ND	0.23	0.50	"	"	"	"	"	"	
Chlorobenzene	ND	0.35	0.50	"	"	"	"	"	"	
Bromoform	ND	0.063	0.10	"	"	"	"	"	"	
1,1,2,2-Tetrachloroethane	ND	0.060	0.10	"	"	"	"	"	"	
1,3-Dichlorobenzene	ND	0.064	0.10	"	"	"	"	"	"	
1,4-Dichlorobenzene	ND	0.052	0.10	"	"	"	"	"	"	
1,2-Dichlorobenzene	ND	0.068	0.10	"	"	"	"	"	"	
Surrogate: 1-Chloro-2-fluorobenzene		98 %	50-150			"	"	"	"	
Surrogate: 4-Bromofluorobenzene		122 %	50-150			"	"	"	"	





Conor Pacific / EFW
 2580 Wyandotte St., Suite G
 Mountain View CA, 94043

Project: Cargill Salt
 Project Number: CRA102
 Project Manager: Tom Vercoutere

Reported:
 12/07/01 10:13

Volatile Organics by EPA Method 8021B Sequoia Analytical - Walnut Creek

Analyte	Result	MDL	Reporting Limit	Units	Dilution	Batch	Prepared	Analyzed	Method	Notes
1914B6@2.8-3.3 (P111463-11) Soil Sampled: 11/19/01 12:55 Received: 11/20/01 15:00										
Chloromethane	ND	0.15	0.20	mg/kg	100	1K26005	11/26/01	11/28/01	EPA 8021B	
Vinyl chloride	ND	0.090	0.20	"	"	"	"	"	"	
Bromomethane	ND	0.19	0.50	"	"	"	"	"	"	
Chloroethane	ND	0.15	0.20	"	"	"	"	"	"	
Trichlorofluoromethane	ND	0.10	0.20	"	"	"	"	"	"	
1,1-Dichloroethene	ND	0.14	0.20	"	"	"	"	"	"	
Methylene chloride	ND	0.37	1.0	"	"	"	"	"	"	
trans-1,2-Dichloroethene	ND	0.14	0.20	"	"	"	"	"	"	
1,1-Dichloroethane	ND	0.080	0.20	"	"	"	"	"	"	
cis-1,2-Dichloroethene	ND	0.13	0.20	"	"	"	"	"	"	
Chloroform	ND	0.071	0.20	"	"	"	"	"	"	
1,1,1-Trichloroethane	ND	0.20	0.50	"	"	"	"	"	"	
Carbon tetrachloride	ND	0.19	0.50	"	"	"	"	"	"	
1,2-Dichloroethane	ND	0.10	0.20	"	"	"	"	"	"	
Trichloroethene	ND	0.16	0.50	"	"	"	"	"	"	
1,2-Dichloropropane	ND	0.14	0.50	"	"	"	"	"	"	
Bromodichloromethane	ND	0.13	0.20	"	"	"	"	"	"	
cis-1,3-Dichloropropene	ND	0.13	0.20	"	"	"	"	"	"	
trans-1,3-Dichloropropene	ND	0.10	0.20	"	"	"	"	"	"	
1,1,2-Trichloroethane	ND	0.083	0.20	"	"	"	"	"	"	
Tetrachloroethene	ND	0.19	0.50	"	"	"	"	"	"	
Dibromochloromethane	ND	0.070	0.20	"	"	"	"	"	"	
1,2-Dibromoethane	ND	0.23	0.50	"	"	"	"	"	"	
Chlorobenzene	ND	0.35	0.50	"	"	"	"	"	"	
Bromoform	ND	0.063	0.10	"	"	"	"	"	"	
1,1,2,2-Tetrachloroethane	ND	0.060	0.10	"	"	"	"	"	"	
1,3-Dichlorobenzene	ND	0.064	0.10	"	"	"	"	"	"	
1,4-Dichlorobenzene	ND	0.052	0.10	"	"	"	"	"	"	
1,2-Dichlorobenzene	ND	0.068	0.10	"	"	"	"	"	"	
Surrogate: 1-Chloro-2-fluorobenzene		98 %	50-150			"	"	"	"	
Surrogate: 4-Bromofluorobenzene		106 %	50-150			"	"	"	"	





Conor Pacific / EFW
 2580 Wyandotte St., Suite G
 Mountain View CA, 94043

Project: Cargill Salt
 Project Number: CRA102
 Project Manager: Tom Vercoutere

Reported:
 12/07/01 10:13

Volatile Organics by EPA Method 8021B Sequoia Analytical - Walnut Creek

Analyte	Result	MDL	Reporting		Dilution	Batch	Prepared	Analyzed	Method	Notes
			Limit	Units						
1914B6@7.5-8.0 (P111463-12) Soil Sampled: 11/19/01 13:30 Received: 11/20/01 15:00										
Chloromethane	ND	0.15	0.20	mg/kg	100	1K26005	11/26/01	11/28/01	EPA 8021B	
Vinyl chloride	ND	0.090	0.20	"	"	"	"	"	"	
Bromomethane	ND	0.19	0.50	"	"	"	"	"	"	
Chloroethane	ND	0.15	0.20	"	"	"	"	"	"	
Trichlorofluoromethane	ND	0.10	0.20	"	"	"	"	"	"	
1,1-Dichloroethene	ND	0.14	0.20	"	"	"	"	"	"	
Methylene chloride	ND	0.37	1.0	"	"	"	"	"	"	
trans-1,2-Dichloroethene	ND	0.14	0.20	"	"	"	"	"	"	
1,1-Dichloroethane	ND	0.080	0.20	"	"	"	"	"	"	
cis-1,2-Dichloroethene	ND	0.13	0.20	"	"	"	"	"	"	
Chloroform	ND	0.071	0.20	"	"	"	"	"	"	
1,1,1-Trichloroethane	ND	0.20	0.50	"	"	"	"	"	"	
Carbon tetrachloride	ND	0.19	0.50	"	"	"	"	"	"	
1,2-Dichloroethane	ND	0.10	0.20	"	"	"	"	"	"	
Trichloroethene	ND	0.16	0.50	"	"	"	"	"	"	
1,2-Dichloropropane	ND	0.14	0.50	"	"	"	"	"	"	
Bromodichloromethane	ND	0.13	0.20	"	"	"	"	"	"	
cis-1,3-Dichloropropene	ND	0.13	0.20	"	"	"	"	"	"	
trans-1,3-Dichloropropene	ND	0.10	0.20	"	"	"	"	"	"	
1,1,2-Trichloroethane	ND	0.083	0.20	"	"	"	"	"	"	
Tetrachloroethene	ND	0.19	0.50	"	"	"	"	"	"	
Dibromochloromethane	ND	0.070	0.20	"	"	"	"	"	"	
1,2-Dibromoethane	ND	0.23	0.50	"	"	"	"	"	"	
Chlorobenzene	ND	0.35	0.50	"	"	"	"	"	"	
Bromoform	ND	0.063	0.10	"	"	"	"	"	"	
1,1,2,2-Tetrachloroethane	ND	0.060	0.10	"	"	"	"	"	"	
1,3-Dichlorobenzene	ND	0.064	0.10	"	"	"	"	"	"	
1,4-Dichlorobenzene	ND	0.052	0.10	"	"	"	"	"	"	
1,2-Dichlorobenzene	ND	0.068	0.10	"	"	"	"	"	"	
Surrogate: 1-Chloro-2-fluorobenzene		75 %	50-150			"	"	"	"	
Surrogate: 4-Bromofluorobenzene		90 %	50-150			"	"	"	"	





Conor Pacific / EFW
2580 Wyandotte St., Suite G
Mountain View CA, 94043

Project: Cargill Salt
Project Number: CRA102
Project Manager: Tom Vercoutere

Reported:
12/07/01 10:13

**Volatile Organics by EPA Method 8021B - Quality Control
Sequoia Analytical - Walnut Creek**

Analyte	Result	MDL	Reporting Limit	Units	Spike Level	Source Result	%REC	%REC Limits	RPD	RPD Limit	Notes
---------	--------	-----	-----------------	-------	-------------	---------------	------	-------------	-----	-----------	-------

Batch 1K26005 - EPA 5030B [MeOH]

Blank (1K26005-BLK1)

Prepared: 11/26/01 Analyzed: 11/28/01

Chloromethane	ND	0.15	0.20	mg/kg							
Vinyl chloride	ND	0.090	0.20	"							
Bromomethane	ND	0.19	0.50	"							
Chloroethane	ND	0.15	0.20	"							
Trichlorofluoromethane	ND	0.10	0.20	"							
1,1-Dichloroethene	ND	0.14	0.20	"							
Methylene chloride	ND	0.37	1.0	"							
trans-1,2-Dichloroethene	ND	0.14	0.20	"							
1,1-Dichloroethane	ND	0.080	0.20	"							
cis-1,2-Dichloroethene	ND	0.13	0.20	"							
Chloroform	ND	0.071	0.20	"							
1,1,1-Trichloroethane	ND	0.20	0.50	"							
Carbon tetrachloride	ND	0.19	0.50	"							
1,2-Dichloroethane	ND	0.10	0.20	"							
Trichloroethene	ND	0.16	0.50	"							
1,2-Dichloropropane	ND	0.14	0.50	"							
Bromodichloromethane	ND	0.13	0.20	"							
cis-1,3-Dichloropropene	ND	0.13	0.20	"							
trans-1,3-Dichloropropene	ND	0.10	0.20	"							
1,1,2-Trichloroethane	ND	0.083	0.20	"							
Tetrachloroethene	ND	0.19	0.50	"							
Dibromochloromethane	ND	0.070	0.20	"							
1,2-Dibromoethane	ND	0.23	0.50	"							
Chlorobenzene	ND	0.35	0.50	"							
Bromoform	ND	0.063	0.10	"							
1,1,2,2-Tetrachloroethane	ND	0.060	0.10	"							
1,3-Dichlorobenzene	ND	0.064	0.10	"							
1,4-Dichlorobenzene	ND	0.052	0.10	"							
1,2-Dichlorobenzene	ND	0.068	0.10	"							
Surrogate: 1-Chloro-2-fluorobenzene	0.466			"	0.500		93	50-150			
Surrogate: 4-Bromofluorobenzene	0.545			"	0.500		109	50-150			





Conor Pacific / EFW
2580 Wyandotte St., Suite G
Mountain View CA, 94043

Project: Cargill Salt
Project Number: CRA102
Project Manager: Tom Vercoutere

Reported:
12/07/01 10:13

**Volatile Organics by EPA Method 8021B - Quality Control
Sequoia Analytical - Walnut Creek**

Analyte	Result	MDL	Reporting Limit	Units	Spike Level	Source Result	%REC	%REC Limits	RPD	RPD Limit	Notes
---------	--------	-----	-----------------	-------	-------------	---------------	------	-------------	-----	-----------	-------

Batch 1K26005 - EPA 5030B [MeOH]

LCS (1K26005-BS1)

Prepared: 11/26/01 Analyzed: 11/28/01

1,1-Dichloroethene	0.936	0.14	0.20	mg/kg	1.00		94	65-135			
Trichloroethene	0.914	0.16	0.50	"	1.00		91	70-130			
Chlorobenzene	0.908	0.35	0.50	"	1.00		91	70-130			
Surrogate: 1-Chloro-2-fluorobenzene	0.563			"	0.500		113	50-150			
Surrogate: 4-Bromofluorobenzene	0.613			"	0.500		123	50-150			

Matrix Spike (1K26005-MS1)

Source: P111463-01

Prepared: 11/26/01 Analyzed: 11/28/01

1,1-Dichloroethene	1.05	0.14	0.20	mg/kg	1.00	ND	105	60-140			
Trichloroethene	1.01	0.16	0.50	"	1.00	ND	101	60-140			
Chlorobenzene	0.958	0.35	0.50	"	1.00	ND	96	60-140			
Surrogate: 1-Chloro-2-fluorobenzene	0.502			"	0.500		100	50-150			
Surrogate: 4-Bromofluorobenzene	0.540			"	0.500		108	50-150			

Matrix Spike Dup (1K26005-MSD1)

Source: P111463-01

Prepared: 11/26/01 Analyzed: 11/28/01

1,1-Dichloroethene	1.00	0.14	0.20	mg/kg	1.00	ND	100	60-140	5	25	
Trichloroethene	0.988	0.16	0.50	"	1.00	ND	99	60-140	2	25	
Chlorobenzene	0.916	0.35	0.50	"	1.00	ND	92	60-140	4	25	
Surrogate: 1-Chloro-2-fluorobenzene	0.527			"	0.500		105	50-150			
Surrogate: 4-Bromofluorobenzene	0.573			"	0.500		115	50-150			





Conor Pacific / EFW
2580 Wyandotte St., Suite G
Mountain View CA, 94043

Project: Cargill Salt
Project Number: CRA102
Project Manager: Tom Vercoutere

Reported:
12/07/01 10:13

Notes and Definitions

DET Analyte DETECTED
ND Analyte NOT DETECTED at or above the reporting limit
NR Not Reported
dry Sample results reported on a dry weight basis
RPD Relative Percent Difference





CHAIN OF CUSTODY

Quotation No. _____

PROJECT NO.: CRA 102	SITE NAME: Cargill / 2016 Clement	ANALYSES	
SAMPLER(S): Tom VerCoutere (printed) KB for TV (signature)		80-113	EDD required? <input type="checkbox"/> Yes <input checked="" type="checkbox"/> No
CONTRACT LABORATORY: <u>Segeia Petaluma</u>			Container Info
TURN-AROUND TIME: <u>Standard</u>			

Sample I.D.	Lab I.D.	Collection		Matrix	Depth ft	Type/Vol.	Filter	Preserv.	Cont. Qty.	Remarks
		Date	Time							
1914B1@25-30		11/18/01	9:20	soil	25-3	2x6 inch stainless steel rings	None	None	1	MDL - PQL
1914B1@30-35			10:15		3-3.5				1	Sample from
1914B2@25-30			9:40		25-3				1	end labeled
1914B2@6.1-7.2			10:05		6.7-7.2				1	"Bottom"
1914B3@3.3-4.5			11:10		3.3-4.3				1	
1914B3@7.1-8.4			12:00		7.9-8.4				1	
1914B7@7.0-7.5			12:00		7.0-7.5				1	
1914B4@2.7-3.2			11:30		2.7-3.2				1	
1914B5@3.0-3.5			12:55		3-3.5				1	
1914B5@8-8.5			13:30		8-8.5				1	
1914B6@2.8-3.3			12:55		2.8-3.3				1	
1914B6@7.5-8.0			13:30		7.5-8				1	

Relinquished by: (signature) <i>KB</i>	Received by: (signature) <i>[Signature]</i>	Date/Time: 11/20/01 1130	SEND RESULTS TO: Attn: Tom VerCoutere Conor Pacific/EFW 2580 Wyandotte St., Suite G Mountain View, CA 94043 Phone (650) 386-3828 Fax (650) 386-3815
Relinquished by: (signature) <i>[Signature]</i>	Received by: (signature) <i>[Signature]</i>	Date/Time: 11/20/01 1220	
Relinquished by: (signature) <i>[Signature]</i>	Received by: (signature) <i>[Signature]</i>	Date/Time: 11-20 1500	



Sequoia Analytical

1455 McDowell Blvd. North, Ste. D
Petaluma, CA 94954
(707) 792-1865
FAX (707) 792-0342
www.sequoialabs.com

December 07 , 2001

Tom Vercoutere
Conor Pacific / EFW
2580 Wyandotte St., Suite G
Mountain View, CA 94043
RE: Cargill Salt / P111453

Enclosed are the results of analyses for samples received by the laboratory on 11/20/01. If you have any questions concerning this report, please feel free to contact me.

Sincerely,

Michelle M. Wiita
Project Manager

CA ELAP Certificate Number 2374





Conor Pacific / EFW
2580 Wyandotte St., Suite G
Mountain View CA, 94043

Project: Cargill Salt
Project Number: CRA102
Project Manager: Tom Vercoutere

Reported:
12/07/01 10:47

ANALYTICAL REPORT FOR SAMPLES

Sample ID	Laboratory ID	Matrix	Date Sampled	Date Received
1914B1	P111453-01	Water	11/19/01 10:45	11/20/01 15:00
1914B2	P111453-02	Water	11/19/01 10:45	11/20/01 15:00
1914B3	P111453-03	Water	11/19/01 12:15	11/20/01 15:00
1914B4	P111453-04	Water	11/19/01 12:25	11/20/01 15:00
1914B5	P111453-05	Water	11/19/01 13:40	11/20/01 15:00
1914B6	P111453-06	Water	11/19/01 13:50	11/20/01 15:00





Conor Pacific / EFW
 2580 Wyandotte St., Suite G
 Mountain View CA, 94043

Project: Cargill Salt
 Project Number: CRA102
 Project Manager: Tom Vercoutere

Reported:
 12/07/01 10:47

Volatile Organic Compounds by EPA Method 8021B Sequoia Analytical - Morgan Hill

Analyte	Result	MDL	Reporting		Units	Dilution	Batch	Prepared	Analyzed	Method	Notes
			Limit								
1914B1 (P111453-01) Water Sampled: 11/19/01 10:45 Received: 11/20/01 15:00											
Bromodichloromethane	ND	0.38	0.50		ug/l	1	1K28010	11/28/01	11/28/01	EPA 8021B	
Bromoform	ND	0.093	0.50		"	"	"	"	"	"	
Bromomethane	ND	0.58	1.0		"	"	"	"	"	"	
Carbon tetrachloride	ND	0.20	0.50		"	"	"	"	"	"	
Chlorobenzene	ND	0.22	0.50		"	"	"	"	"	"	
Chloroethane	ND	0.28	1.0		"	"	"	"	"	"	
Chloroform	ND	0.072	0.50		"	"	"	"	"	"	
Chloromethane	ND	0.27	1.0		"	"	"	"	"	"	
Dibromochloromethane	ND	0.15	0.50		"	"	"	"	"	"	
1,3-Dichlorobenzene	ND	0.27	0.50		"	"	"	"	"	"	
1,4-Dichlorobenzene	ND	0.17	0.50		"	"	"	"	"	"	
1,2-Dichlorobenzene	ND	0.21	0.50		"	"	"	"	"	"	
1,1-Dichloroethane	ND	0.13	0.50		"	"	"	"	"	"	
1,2-Dichloroethane	ND	0.10	0.50		"	"	"	"	"	"	
1,1-Dichloroethene	ND	0.093	0.50		"	"	"	"	"	"	
cis-1,2-Dichloroethene	ND	0.13	0.50		"	"	"	"	"	"	
trans-1,2-Dichloroethene	ND	0.17	0.50		"	"	"	"	"	"	
1,2-Dichloropropane	ND	0.068	0.50		"	"	"	"	"	"	
cis-1,3-Dichloropropene	ND	0.095	0.50		"	"	"	"	"	"	
trans-1,3-Dichloropropene	ND	0.12	0.50		"	"	"	"	"	"	
Methylene chloride	ND	0.098	5.0		"	"	"	"	"	"	
1,1,2,2-Tetrachloroethane	ND	0.27	0.50		"	"	"	"	"	"	
Tetrachloroethene	ND	0.13	0.50		"	"	"	"	"	"	
1,1,1-Trichloroethane	ND	0.081	0.50		"	"	"	"	"	"	
1,1,2-Trichloroethane	ND	0.13	0.50		"	"	"	"	"	"	
1,1,2-Trichlorotrifluoroethane	ND	0.14	1.0		"	"	"	"	"	"	
Trichloroethene	ND	0.28	0.50		"	"	"	"	"	"	
Trichlorofluoromethane	ND	0.12	0.50		"	"	"	"	"	"	
Vinyl chloride	ND	0.31	1.0		"	"	"	"	"	"	
1,2-Dibromoethane	ND	0.18	1.0		"	"	"	"	"	"	
<i>Surrogate: 4-Bromofluorobenzene</i>			105 %								
											70-130





Conor Pacific / EFW
2580 Wyandotte St., Suite G
Mountain View CA, 94043

Project: Cargill Salt
Project Number: CRA102
Project Manager: Tom Vercoutere

Reported:
12/07/01 10:47

**Volatile Organic Compounds by EPA Method 8021B
Sequoia Analytical - Morgan Hill**

Analyte	Result	MDL	Reporting		Units	Dilution	Batch	Prepared	Analyzed	Method	Notes
			Limit								
1914B2 (P111453-02) Water Sampled: 11/19/01 10:45 Received: 11/20/01 15:00											
Bromodichloromethane	ND	0.38	0.50		ug/l	1	1K28010	11/28/01	11/28/01	EPA 8021B	
Bromoform	ND	0.093	0.50		"	"	"	"	"	"	
Bromomethane	ND	0.58	1.0		"	"	"	"	"	"	
Carbon tetrachloride	ND	0.20	0.50		"	"	"	"	"	"	
Chlorobenzene	ND	0.22	0.50		"	"	"	"	"	"	
Chloroethane	ND	0.28	1.0		"	"	"	"	"	"	
Chloroform	ND	0.072	0.50		"	"	"	"	"	"	
Chloromethane	ND	0.27	1.0		"	"	"	"	"	"	
Dibromochloromethane	ND	0.15	0.50		"	"	"	"	"	"	
1,3-Dichlorobenzene	ND	0.27	0.50		"	"	"	"	"	"	
1,4-Dichlorobenzene	ND	0.17	0.50		"	"	"	"	"	"	
1,2-Dichlorobenzene	ND	0.21	0.50		"	"	"	"	"	"	
1,1-Dichloroethane	ND	0.13	0.50		"	"	"	"	"	"	
1,2-Dichloroethane	ND	0.10	0.50		"	"	"	"	"	"	
1,1-Dichloroethene	ND	0.093	0.50		"	"	"	"	"	"	
cis-1,2-Dichloroethene	ND	0.13	0.50		"	"	"	"	"	"	
trans-1,2-Dichloroethene	ND	0.17	0.50		"	"	"	"	"	"	
1,2-Dichloropropane	ND	0.068	0.50		"	"	"	"	"	"	
cis-1,3-Dichloropropene	ND	0.095	0.50		"	"	"	"	"	"	
trans-1,3-Dichloropropene	ND	0.12	0.50		"	"	"	"	"	"	
Methylene chloride	ND	0.098	5.0		"	"	"	"	"	"	
1,1,2,2-Tetrachloroethane	ND	0.27	0.50		"	"	"	"	"	"	
Tetrachloroethene	ND	0.13	0.50		"	"	"	"	"	"	
1,1,1-Trichloroethane	ND	0.081	0.50		"	"	"	"	"	"	
1,1,2-Trichloroethane	ND	0.13	0.50		"	"	"	"	"	"	
1,1,2-Trichlorotrifluoroethane	ND	0.14	1.0		"	"	"	"	"	"	
Trichloroethene	ND	0.28	0.50		"	"	"	"	"	"	
Trichlorofluoromethane	ND	0.12	0.50		"	"	"	"	"	"	
Vinyl chloride	ND	0.31	1.0		"	"	"	"	"	"	
1,2-Dibromoethane	ND	0.18	1.0		"	"	"	"	"	"	
<i>Surrogate: 4-Bromofluorobenzene</i>		88.2 %	70-130				"	"	"	"	





Conor Pacific / EFW
 2580 Wyandotte St., Suite G
 Mountain View CA, 94043

Project: Cargill Salt
 Project Number: CRA102
 Project Manager: Tom Vercoutere

Reported:
 12/07/01 10:47

Volatile Organic Compounds by EPA Method 8021B Sequoia Analytical - Morgan Hill

Analyte	Result	MDL	Reporting Limit	Units	Dilution	Batch	Prepared	Analyzed	Method	Notes
1914B3 (P111453-03) Water Sampled: 11/19/01 12:15 Received: 11/20/01 15:00										
Bromodichloromethane	ND	0.38	0.50	ug/l	1	1K28010	11/28/01	11/28/01	EPA 8021B	
Bromoform	ND	0.093	0.50	"	"	"	"	"	"	
Bromomethane	ND	0.58	1.0	"	"	"	"	"	"	
Carbon tetrachloride	ND	0.20	0.50	"	"	"	"	"	"	
Chlorobenzene	ND	0.22	0.50	"	"	"	"	"	"	
Chloroethane	ND	0.28	1.0	"	"	"	"	"	"	
Chloroform	ND	0.072	0.50	"	"	"	"	"	"	
Chloromethane	ND	0.27	1.0	"	"	"	"	"	"	
Dibromochloromethane	ND	0.15	0.50	"	"	"	"	"	"	
1,3-Dichlorobenzene	ND	0.27	0.50	"	"	"	"	"	"	
1,4-Dichlorobenzene	ND	0.17	0.50	"	"	"	"	"	"	
1,2-Dichlorobenzene	ND	0.21	0.50	"	"	"	"	"	"	
1,1-Dichloroethane	ND	0.13	0.50	"	"	"	"	"	"	
1,2-Dichloroethane	ND	0.10	0.50	"	"	"	"	"	"	
1,1-Dichloroethene	ND	0.093	0.50	"	"	"	"	"	"	
cis-1,2-Dichloroethene	ND	0.13	0.50	"	"	"	"	"	"	
trans-1,2-Dichloroethene	ND	0.17	0.50	"	"	"	"	"	"	
1,2-Dichloropropane	ND	0.068	0.50	"	"	"	"	"	"	
cis-1,3-Dichloropropene	ND	0.095	0.50	"	"	"	"	"	"	
trans-1,3-Dichloropropene	ND	0.12	0.50	"	"	"	"	"	"	
Methylene chloride	ND	0.098	5.0	"	"	"	"	"	"	
1,1,2,2-Tetrachloroethane	ND	0.27	0.50	"	"	"	"	"	"	
Tetrachloroethene	3.4	0.13	0.50	"	"	"	"	"	"	
1,1,1-Trichloroethane	ND	0.081	0.50	"	"	"	"	"	"	
1,1,2-Trichloroethane	ND	0.13	0.50	"	"	"	"	"	"	
1,1,2-Trichlorotrifluoroethane	ND	0.14	1.0	"	"	"	"	"	"	
Trichloroethene	ND	0.28	0.50	"	"	"	"	"	"	
Trichlorofluoromethane	ND	0.12	0.50	"	"	"	"	"	"	
Vinyl chloride	ND	0.31	1.0	"	"	"	"	"	"	
1,2-Dibromoethane	ND	0.18	1.0	"	"	"	"	"	"	
<i>Surrogate: 4-Bromofluorobenzene</i>		104 %	70-130			"	"	"	"	





Conor Pacific / EFW
 2580 Wyandotte St., Suite G
 Mountain View CA, 94043

Project: Cargill Salt
 Project Number: CRA102
 Project Manager: Tom Vercoutere

Reported:
 12/07/01 10:47

Volatile Organic Compounds by EPA Method 8021B Sequoia Analytical - Morgan Hill

Analyte	Result	MDL	Reporting		Units	Dilution	Batch	Prepared	Analyzed	Method	Notes
			Limit								
1914B4 (P111453-04) Water Sampled: 11/19/01 12:25 Received: 11/20/01 15:00											
Bromodichloromethane	ND	0.38	0.50		ug/l	1	1K28010	11/28/01	11/29/01	EPA 8021B	
Bromoform	ND	0.093	0.50		"	"	"	"	"	"	
Bromomethane	ND	0.58	1.0		"	"	"	"	"	"	
Carbon tetrachloride	ND	0.20	0.50		"	"	"	"	"	"	
Chlorobenzene	ND	0.22	0.50		"	"	"	"	"	"	
Chloroethane	ND	0.28	1.0		"	"	"	"	"	"	
Chloroform	0.072	0.072	0.50		"	"	"	"	"	"	
Chloromethane	ND	0.27	1.0		"	"	"	"	"	"	
Dibromochloromethane	ND	0.15	0.50		"	"	"	"	"	"	
1,3-Dichlorobenzene	ND	0.27	0.50		"	"	"	"	"	"	
1,4-Dichlorobenzene	ND	0.17	0.50		"	"	"	"	"	"	
1,2-Dichlorobenzene	ND	0.21	0.50		"	"	"	"	"	"	
1,1-Dichloroethane	ND	0.13	0.50		"	"	"	"	"	"	
1,2-Dichloroethane	ND	0.10	0.50		"	"	"	"	"	"	
1,1-Dichloroethene	ND	0.093	0.50		"	"	"	"	"	"	
cis-1,2-Dichloroethene	ND	0.13	0.50		"	"	"	"	"	"	
trans-1,2-Dichloroethene	ND	0.17	0.50		"	"	"	"	"	"	
1,2-Dichloropropane	ND	0.068	0.50		"	"	"	"	"	"	
cis-1,3-Dichloropropene	ND	0.095	0.50		"	"	"	"	"	"	
trans-1,3-Dichloropropene	ND	0.12	0.50		"	"	"	"	"	"	
Methylene chloride	0.11	0.098	5.0		"	"	"	"	"	"	
1,1,2,2-Tetrachloroethane	ND	0.27	0.50		"	"	"	"	"	"	
Tetrachloroethene	1.1	0.13	0.50		"	"	"	"	"	"	
1,1,1-Trichloroethane	ND	0.081	0.50		"	"	"	"	"	"	
1,1,2-Trichloroethane	ND	0.13	0.50		"	"	"	"	"	"	
1,1,2-Trichlorotrifluoroethane	ND	0.14	1.0		"	"	"	"	"	"	
Trichloroethene	ND	0.28	0.50		"	"	"	"	"	"	
Trichlorofluoromethane	ND	0.12	0.50		"	"	"	"	"	"	
Vinyl chloride	ND	0.31	1.0		"	"	"	"	"	"	
1,2-Dibromoethane	ND	0.18	1.0		"	"	"	"	"	"	
<i>Surrogate: 4-Bromofluorobenzene</i>		<i>91.6 %</i>	<i>70-130</i>								





Conor Pacific / EPW
 2580 Wyandotte St., Suite G
 Mountain View CA, 94043

Project: Cargill Salt
 Project Number: CRA102
 Project Manager: Tom Vercoutere

Reported:
 12/07/01 10:47

Volatile Organic Compounds by EPA Method 8021B Sequoia Analytical - Morgan Hill

Analyte	Result	MDL	Reporting		Units	Dilution	Batch	Prepared	Analyzed	Method	Notes
			Limit								
1914B5 (P111453-05) Water Sampled: 11/19/01 13:40 Received: 11/20/01 15:00											
Bromodichloromethane	ND	38	50		ug/l	100	1K28010	11/28/01	11/29/01	EPA 8021B	
Bromoform	ND	9.3	50		"	"	"	"	"	"	
Bromomethane	ND	58	100		"	"	"	"	"	"	
Carbon tetrachloride	ND	20	50		"	"	"	"	"	"	
Chlorobenzene	ND	22	50		"	"	"	"	"	"	
Chloroethane	ND	28	100		"	"	"	"	"	"	
Chloroform	ND	7.2	50		"	"	"	"	"	"	
Chloromethane	ND	27	100		"	"	"	"	"	"	
Dibromochloromethane	21	15	50		"	"	"	"	"	"	J
1,3-Dichlorobenzene	ND	27	50		"	"	"	"	"	"	
1,4-Dichlorobenzene	ND	17	50		"	"	"	"	"	"	
1,2-Dichlorobenzene	ND	21	50		"	"	"	"	"	"	
1,1-Dichloroethane	ND	13	50		"	"	"	"	"	"	
1,2-Dichloroethane	ND	10	50		"	"	"	"	"	"	
1,1-Dichloroethene	ND	9.3	50		"	"	"	"	"	"	
cis-1,2-Dichloroethene	ND	13	50		"	"	"	"	"	"	
trans-1,2-Dichloroethene	ND	17	50		"	"	"	"	"	"	
1,2-Dichloropropane	ND	6.8	50		"	"	"	"	"	"	
cis-1,3-Dichloropropene	ND	9.5	50		"	"	"	"	"	"	
trans-1,3-Dichloropropene	ND	12	50		"	"	"	"	"	"	
Methylene chloride	ND	9.8	500		"	"	"	"	"	"	
1,1,2,2-Tetrachloroethane	ND	27	50		"	"	"	"	"	"	
Tetrachloroethene	500	13	50		"	"	"	"	"	"	
1,1,1-Trichloroethane	ND	8.1	50		"	"	"	"	"	"	
1,1,2-Trichloroethane	ND	13	50		"	"	"	"	"	"	
1,1,2-Trichlorotrifluoroethane	ND	14	100		"	"	"	"	"	"	
Trichloroethene	ND	28	50		"	"	"	"	"	"	
Trichlorofluoromethane	ND	12	50		"	"	"	"	"	"	
Vinyl chloride	ND	31	100		"	"	"	"	"	"	
1,2-Dibromoethane	ND	18	100		"	"	"	"	"	"	
Surrogate: 4-Bromofluorobenzene		90.0 %	70-130				"	"	"	"	





Conor Pacific / EFW
2580 Wyandotte St., Suite G
Mountain View CA, 94043

Project: Cargill Salt
Project Number: CRA102
Project Manager: Tom Vercoutare

Reported:
12/07/01 10:47

**Volatile Organic Compounds by EPA Method 8021B
Sequoia Analytical - Morgan Hill**

Analyte	Result	MDL	Reporting		Dilution	Batch	Prepared	Analyzed	Method	Notes
			Limit	Units						
1914B6 (P111453-06) Water Sampled: 11/19/01 13:50 Received: 11/20/01 15:00										
Bromodichloromethane	ND	0.38	0.50	ug/l	1	1K28010	11/28/01	11/29/01	EPA 8021B	
Bromoform	ND	0.093	0.50	"	"	"	"	"	"	
Bromomethane	ND	0.58	1.0	"	"	"	"	"	"	
Carbon tetrachloride	ND	0.20	0.50	"	"	"	"	"	"	
Chlorobenzene	ND	0.22	0.50	"	"	"	"	"	"	
Chloroethane	ND	0.28	1.0	"	"	"	"	"	"	
Chloroform	ND	0.072	0.50	"	"	"	"	"	"	
Chloromethane	ND	0.27	1.0	"	"	"	"	"	"	
Dibromochloromethane	ND	0.15	0.50	"	"	"	"	"	"	
1,3-Dichlorobenzene	ND	0.27	0.50	"	"	"	"	"	"	
1,4-Dichlorobenzene	ND	0.17	0.50	"	"	"	"	"	"	
1,2-Dichlorobenzene	ND	0.21	0.50	"	"	"	"	"	"	
1,1-Dichloroethane	ND	0.13	0.50	"	"	"	"	"	"	
1,2-Dichloroethane	ND	0.10	0.50	"	"	"	"	"	"	
1,1-Dichloroethene	ND	0.093	0.50	"	"	"	"	"	"	
cis-1,2-Dichloroethene	ND	0.13	0.50	"	"	"	"	"	"	
trans-1,2-Dichloroethene	ND	0.17	0.50	"	"	"	"	"	"	
1,2-Dichloropropane	ND	0.068	0.50	"	"	"	"	"	"	
cis-1,3-Dichloropropene	ND	0.095	0.50	"	"	"	"	"	"	
trans-1,3-Dichloropropene	ND	0.12	0.50	"	"	"	"	"	"	
Methylene chloride	ND	0.098	5.0	"	"	"	"	"	"	
1,1,2,2-Tetrachloroethane	ND	0.27	0.50	"	"	"	"	"	"	
Tetrachloroethene	10	0.13	0.50	"	"	"	"	"	"	
1,1,1-Trichloroethane	ND	0.081	0.50	"	"	"	"	"	"	
1,1,2-Trichloroethane	ND	0.13	0.50	"	"	"	"	"	"	
1,1,2-Trichlorotrifluoroethane	ND	0.14	1.0	"	"	"	"	"	"	
Trichloroethene	ND	0.28	0.50	"	"	"	"	"	"	
Trichlorofluoromethane	ND	0.12	0.50	"	"	"	"	"	"	
Vinyl chloride	ND	0.31	1.0	"	"	"	"	"	"	
1,2-Dibromoethane	ND	0.18	1.0	"	"	"	"	"	"	
<i>Surrogate: 4-Bromofluorobenzene</i>		<i>101 %</i>	<i>70-130</i>							





Conor Pacific / EFW 2580 Wyandotte St., Suite G Mountain View CA, 94043	Project: Cargill Salt Project Number: CRA102 Project Manager: Tom Vercoutare	Reported: 12/07/01 10:47
---	--	-----------------------------

**Volatile Organic Compounds by EPA Method 8021B - Quality Control
Sequoia Analytical - Morgan Hill**

Analyte	Result	MDL	Reporting Limit	Units	Spike Level	Source Result	%REC	%REC Limits	RPD	RPD Limit	Notes
---------	--------	-----	-----------------	-------	-------------	---------------	------	-------------	-----	-----------	-------

Batch 1K28010 - EPA 5030B [P/T]

Blank (1K28010-BLK1)

Prepared & Analyzed: 11/28/01

Bromodichloromethane	ND	0.38	0.50	ug/l							
Bromoform	ND	0.093	0.50	"							
Bromomethane	ND	0.58	1.0	"							
Carbon tetrachloride	ND	0.20	0.50	"							
Chlorobenzene	ND	0.22	0.50	"							
Chloroethane	ND	0.28	1.0	"							
Chloroform	ND	0.072	0.50	"							
Chloromethane	ND	0.27	1.0	"							
Dibromochloromethane	ND	0.15	0.50	"							
1,3-Dichlorobenzene	ND	0.27	0.50	"							
1,4-Dichlorobenzene	ND	0.17	0.50	"							
1,2-Dichlorobenzene	ND	0.21	0.50	"							
1,1-Dichloroethane	ND	0.13	0.50	"							
1,2-Dichloroethane	ND	0.10	0.50	"							
1,1-Dichloroethene	ND	0.093	0.50	"							
cis-1,2-Dichloroethene	ND	0.13	0.50	"							
trans-1,2-Dichloroethene	ND	0.17	0.50	"							
1,2-Dichloropropane	ND	0.068	0.50	"							
cis-1,3-Dichloropropene	ND	0.095	0.50	"							
trans-1,3-Dichloropropene	ND	0.12	0.50	"							
Methylene chloride	ND	0.098	5.0	"							
1,1,2,2-Tetrachloroethane	ND	0.27	0.50	"							
Tetrachloroethene	ND	0.13	0.50	"							
1,1,1-Trichloroethane	ND	0.081	0.50	"							
1,1,2-Trichloroethane	ND	0.13	0.50	"							
1,1,2-Trichlorotrifluoroethane	ND	0.14	1.0	"							
Trichloroethene	ND	0.28	0.50	"							
Trichlorofluoromethane	ND	0.12	0.50	"							
Vinyl chloride	ND	0.31	1.0	"							
1,2-Dibromoethane	ND	0.18	1.0	"							
Surrogate: 4-Bromofluorobenzene	10.8			"	10.0		108	70-130			





Conor Pacific / EFW 2580 Wyandotte St., Suite G Mountain View CA, 94043	Project: Cargill Salt Project Number: CRA102 Project Manager: Tom Vercoutere	Reported: 12/07/01 10:47
---	--	-----------------------------

**Volatile Organic Compounds by EPA Method 8021B - Quality Control
Sequoia Analytical - Morgan Hill**

Analyte	Result	MDL	Reporting Limit	Units	Spike Level	Source Result	%REC	%REC Limits	RPD	RPD Limit	Notes
---------	--------	-----	-----------------	-------	-------------	---------------	------	-------------	-----	-----------	-------

Batch 1K28010 - EPA 5030B [P/T]

LCS (1K28010-BS1)

Prepared & Analyzed: 11/28/01

Chlorobenzene	10.6	0.22	0.50	ug/l	10.0		106	70-130			
1,1-Dichloroethene	8.91	0.093	0.50	"	10.0		89.1	65-135			
Trichloroethene	10.6	0.28	0.50	"	10.0		106	70-130			
Surrogate: 4-Bromofluorobenzene	11.1			"	10.0		111	70-130			

Matrix Spike (1K28010-MS1)

Source: P111453-01

Prepared: 11/28/01 Analyzed: 11/29/01

Chlorobenzene	9.39	0.22	0.50	ug/l	10.0	ND	93.9	60-140			
1,1-Dichloroethene	7.33	0.093	0.50	"	10.0	ND	73.3	60-140			
Trichloroethene	9.76	0.28	0.50	"	10.0	ND	97.6	60-140			
Surrogate: 4-Bromofluorobenzene	10.8			"	10.0		108	70-130			

Matrix Spike Dup (1K28010-MSD1)

Source: P111453-01

Prepared: 11/28/01 Analyzed: 11/29/01

Chlorobenzene	9.33	0.22	0.50	ug/l	10.0	ND	93.3	60-140	0.641	25	
1,1-Dichloroethene	6.97	0.093	0.50	"	10.0	ND	69.7	60-140	5.03	25	
Trichloroethene	9.29	0.28	0.50	"	10.0	ND	92.9	60-140	4.93	25	
Surrogate: 4-Bromofluorobenzene	10.6			"	10.0		106	70-130			





Conor Pacific / EFW
 2580 Wyandotte St., Suite G
 Mountain View CA, 94043

Project: Cargill Salt
 Project Number: CRA102
 Project Manager: Tom Vercoutere

Reported:
 12/07/01 10:47

Volatile Organic Compounds by EPA Method 8021B - Quality Control
Sequoia Analytical - Morgan Hill

Analyte	Result	MDL	Reporting Limit	Units	Spike Level	Source Result	%REC	%REC Limits	RPD	RPD Limit	Notes
---------	--------	-----	-----------------	-------	-------------	---------------	------	-------------	-----	-----------	-------

Batch 1K28010 - EPA 5030B [P/T]

LCS (1K28010-BS1)

Prepared & Analyzed: 11/28/01

Chlorobenzene	10.6	0.22	0.50	ug/l	10.0		106	70-130			
1,1-Dichloroethene	8.91	0.093	0.50	"	10.0		89.1	65-135			
Trichloroethene	10.6	0.28	0.50	"	10.0		106	70-130			
Surrogate: 4-Bromofluorobenzene	11.1			"	10.0		111	70-130			

Matrix Spike (1K28010-MS1)

Source: P111453-01

Prepared: 11/28/01 Analyzed: 11/29/01

Chlorobenzene	9.39	0.22	0.50	ug/l	10.0	ND	93.9	60-140			
1,1-Dichloroethene	7.33	0.093	0.50	"	10.0	ND	73.3	60-140			
Trichloroethene	9.76	0.28	0.50	"	10.0	ND	97.6	60-140			
Surrogate: 4-Bromofluorobenzene	10.8			"	10.0		108	70-130			

Matrix Spike Dup (1K28010-MSD1)

Source: P111453-01

Prepared: 11/28/01 Analyzed: 11/29/01

Chlorobenzene	9.33	0.22	0.50	ug/l	10.0	ND	93.3	60-140	0.641	25	
1,1-Dichloroethene	6.97	0.093	0.50	"	10.0	ND	69.7	60-140	5.03	25	
Trichloroethene	9.29	0.28	0.50	"	10.0	ND	92.9	60-140	4.93	25	
Surrogate: 4-Bromofluorobenzene	10.6			"	10.0		106	70-130			





Conor Pacific / EFW
2580 Wyandotte St., Suite G
Mountain View CA, 94043

Project: Cargill Salt
Project Number: CRA102
Project Manager: Tom Vercoutare

Reported:
12/07/01 10:47

Notes and Definitions

J Estimated value.
DET Analyte DETECTED
ND Analyte NOT DETECTED at or above the reporting limit
NR Not Reported
dry Sample results reported on a dry weight basis
RPD Relative Percent Difference





CHAIN OF CUSTODY

Quotation No. _____

PROJECT NO.: CRA102	SITE NAME: Cargill/2016 Clement	ANALYSES	
SAMPLER(S): Tom Vercontere (printed) Tom Vercontere (signature)		8021B	EDD required? <input type="checkbox"/> Yes <input checked="" type="checkbox"/> No
CONTRACT LABORATORY: Sequoia-Petaluma			Container Info
TURN-AROUND TIME: standard			

Sample I.D.	Lab I.D.	Collection		Matrix	Depth	Type/Vol.		Cont. Qty.	Remarks
		Date	Time			Filter	Preserv.		
1914B1		11/19/01	10:45	H ₂ O	\	2	40 ml Cont	2	MDL/PQL
1914B2		↓	10:45	↓	↓	2	na	2	↓
1914B3		↓	12:15	↓	↓	2	ACE	2	↓
1914B4		↓	12:25	↓	↓	2		2	↓
1914B5		↓	13:40	↓	↓	2		2	↓
1914B6		↓	13:50	↓	↓	2		2	↓

COOLER CUSTODY SEALS INTACT

NOT INTACT

COOLER TEMPERATURE 3.1 °C

Relinquished by: (signature) <i>Tom Vercontere</i>	Received by: (signature) <i>[Signature]</i>	Date/Time: 11/20/01 1130	SEND RESULTS TO: Attn: Tom Vercontere Conor Pacific/EFW 2580 Wyandotte St., Suite G Mountain View, CA 94043 Phone (650) 386-3828 Fax (650) 386-3815
Relinquished by: (signature) <i>[Signature]</i>	Received by: (signature) <i>[Signature]</i>	Date/Time: 11/20/01 1220	
Relinquished by: (signature) <i>[Signature]</i>	Received by: (signature) <i>[Signature]</i>	Date/Time: 11-20 1509	



**Sequoia
Analytical**

1455 McDowell Blvd, North Ste D
Petaluma, CA 94954
(707) 792-1865
FAX (707) 792-0342
www.sequoialabs.com

13 December, 2001

Martha Watson
Conor Pacific / EFW
2580 Wyandotte St., Suite G
Mountain View, CA 94043

RE: Cargill Salt
Sequoia Work Order: P112180

Enclosed are the results of analyses for samples received by the laboratory on 12/07/01 15:10. If you have any questions concerning this report, please feel free to contact me.

Sincerely,

Michelle M. Wilta
Project Manager

CA ELAP Certificate #2374



Conor Pacific / BFW
2580 Wyandotte St., Suite G
Mountain View CA, 94043

Project: Cargill Salt
Project Number: CRA102.02
Project Manager: Martha Watson

Reported:
12/13/01 12:52

ANALYTICAL REPORT FOR SAMPLES

Sample ID	Laboratory ID	Matrix	Date Sampled	Date Received
B16	P112180-01	Water	12/06/01 09:00	12/07/01 15:10
B17	P112180-02	Water	12/06/01 09:30	12/07/01 15:10
B18	P112180-03	Water	12/06/01 10:30	12/07/01 15:10
B19	P112180-04	Water	12/06/01 12:00	12/07/01 15:10
B20	P112180-05	Water	12/06/01 13:00	12/07/01 15:10

Sequoia Analytical - Petaluma

The results in this report apply to the samples analyzed in accordance with the chain of custody document. This analytical report must be reproduced in its entirety.

Michelle M. Wiita, Project Manager



Conor Pacific / EFW
2580 Wyandotte St., Suite G
Mountain View CA, 94043

Project: Cargill Salt
Project Number: CRA102.02
Project Manager: Martha Watson

Reported:
12/13/01 12:52

**Volatile Organics by EPA Method 8021B
Sequoia Analytical - Walnut Creek**

Analyte	Result	Reporting		Dilution	Batch	Prepared	Analyzed	Method	Notes
		Limit	Units						
B16 (P112180-01) Water Sampled: 12/06/01 09:00 Received: 12/07/01 15:10									
Dichlorodifluoromethane	ND	1.0	ug/l	1	1L10028	12/11/01	12/11/01	EPA 8021B	
Chloromethane	ND	2.0	"	"	"	"	"	"	"
Vinyl chloride	ND	1.0	"	"	"	"	"	"	"
Bromomethane	ND	1.0	"	"	"	"	"	"	"
Chloroethane	ND	1.0	"	"	"	"	"	"	"
Trichlorofluoromethane	ND	1.0	"	"	"	"	"	"	"
1,1-Dichloroethene	ND	1.0	"	"	"	"	"	"	"
Methylene chloride	ND	5.0	"	"	"	"	"	"	"
trans-1,2-Dichloroethene	ND	1.0	"	"	"	"	"	"	"
1,1-Dichloroethane	ND	1.0	"	"	"	"	"	"	"
2,2-Dichloropropane	ND	1.0	"	"	"	"	"	"	"
cis-1,2-Dichloroethene	ND	1.0	"	"	"	"	"	"	"
Chloroform	ND	1.0	"	"	"	"	"	"	"
Bromochloromethane	ND	1.0	"	"	"	"	"	"	"
1,1,1-Trichloroethane	ND	1.0	"	"	"	"	"	"	"
1,1-Dichloropropene	ND	1.0	"	"	"	"	"	"	"
Carbon tetrachloride	ND	1.0	"	"	"	"	"	"	"
1,2-Dichloroethane	ND	2.0	"	"	"	"	"	"	"
Trichloroethene	ND	1.0	"	"	"	"	"	"	"
1,2-Dichloropropane	ND	1.0	"	"	"	"	"	"	"
Bromodichloromethane	ND	1.0	"	"	"	"	"	"	"
Dibromomethane	ND	1.0	"	"	"	"	"	"	"
cis-1,3-Dichloropropene	ND	1.0	"	"	"	"	"	"	"
trans-1,3-Dichloropropene	ND	1.0	"	"	"	"	"	"	"
1,1,2-Trichloroethane	ND	1.0	"	"	"	"	"	"	"
1,3-Dichloropropane	ND	2.0	"	"	"	"	"	"	"
Tetrachloroethene	1.9	1.0	"	"	"	"	"	"	"
Dibromochloromethane	ND	1.0	"	"	"	"	"	"	"
1,2-Dibromoethane	ND	1.0	"	"	"	"	"	"	"
Chlorobenzene	ND	1.0	"	"	"	"	"	"	"
1,1,1,2-Tetrachloroethane	ND	1.0	"	"	"	"	"	"	"
Bromoform	ND	1.0	"	"	"	"	"	"	"
1,1,2,2-Tetrachloroethane	ND	1.0	"	"	"	"	"	"	"
1,2,3-Trichloropropane	ND	1.0	"	"	"	"	"	"	"
Bromobenzene	ND	1.0	"	"	"	"	"	"	"
2-Chlorotoluene	ND	1.0	"	"	"	"	"	"	"
4-Chlorotoluene	ND	1.0	"	"	"	"	"	"	"



Conor Pacific / EFW
 2580 Wyandotte St., Suite G
 Mountain View CA, 94043

Project: Cargill Salt
 Project Number: CRA102.02
 Project Manager: Martha Watson

Reported:
 12/13/01 12:52

Volatile Organics by EPA Method 8021B
Sequoia Analytical - Walnut Creek

Analyte	Result	Reporting Limit	Units	Dilution	Batch	Prepared	Analyzed	Method	Notes
B16 (P112180-01) Water Sampled: 12/06/01 09:00 Received: 12/07/01 15:10									
1,3-Dichlorobenzene	ND	0.50	ug/l	1	1L10028	12/11/01	12/11/01	EPA 8021B	
1,4-Dichlorobenzene	ND	1.0	"	"	"	"	"	"	
1,2-Dichlorobenzene	ND	1.0	"	"	"	"	"	"	
1,2-Dibromo-3-chloropropane	ND	1.0	"	"	"	"	"	"	
1,2,4-Trichlorobenzene	ND	0.50	"	"	"	"	"	"	
Hexachlorobutadiene	ND	0.50	"	"	"	"	"	"	
1,2,3-Trichlorobenzene	ND	0.50	"	"	"	"	"	"	
<i>Surrogate: Dibromodifluoromethane</i>		113 %	50-150	"	"	"	"	"	
<i>Surrogate: 4-Bromofluorobenzene</i>		97 %	50-150	"	"	"	"	"	
B17 (P112180-02) Water Sampled: 12/06/01 09:30 Received: 12/07/01 15:10									
Dichlorodifluoromethane	ND	1.0	ug/l	1	1L10028	12/11/01	12/11/01	EPA 8021B	
Chloromethane	ND	2.0	"	"	"	"	"	"	
Vinyl chloride	ND	1.0	"	"	"	"	"	"	
Bromomethane	ND	1.0	"	"	"	"	"	"	
Chloroethane	ND	1.0	"	"	"	"	"	"	
Trichlorofluoromethane	ND	1.0	"	"	"	"	"	"	
1,1-Dichloroethene	ND	1.0	"	"	"	"	"	"	
Methylene chloride	ND	5.0	"	"	"	"	"	"	
trans-1,2-Dichloroethene	ND	1.0	"	"	"	"	"	"	
1,1-Dichloroethane	ND	1.0	"	"	"	"	"	"	
2,2-Dichloropropane	ND	1.0	"	"	"	"	"	"	
cis-1,2-Dichloroethene	ND	1.0	"	"	"	"	"	"	
Chloroform	ND	1.0	"	"	"	"	"	"	
Bromochloromethane	ND	1.0	"	"	"	"	"	"	
1,1,1-Trichloroethane	ND	1.0	"	"	"	"	"	"	
1,1-Dichloropropene	ND	1.0	"	"	"	"	"	"	
Carbon tetrachloride	ND	1.0	"	"	"	"	"	"	
1,2-Dichloroethane	ND	2.0	"	"	"	"	"	"	
Trichloroethene	ND	1.0	"	"	"	"	"	"	
1,2-Dichloropropane	ND	1.0	"	"	"	"	"	"	
Bromodichloromethane	ND	1.0	"	"	"	"	"	"	
Dibromomethane	ND	1.0	"	"	"	"	"	"	
cis-1,3-Dichloropropene	ND	1.0	"	"	"	"	"	"	
trans-1,3-Dichloropropene	ND	1.0	"	"	"	"	"	"	
1,1,2-Trichloroethane	ND	1.0	"	"	"	"	"	"	
1,3-Dichloropropane	ND	2.0	"	"	"	"	"	"	
Tetrachloroethene	3.4	1.0	"	"	"	"	"	"	



Conor Pacific / BFW
2580 Wyandotte St., Suite G
Mountain View CA, 94043

Project: Cargill Salt
Project Number: CRA102.02
Project Manager: Martha Watson

Reported:
12/13/01 12:52

**Volatile Organics by EPA Method 8021B
Sequoia Analytical - Walnut Creek**

Analyte	Result	Reporting Limit	Units	Dilution	Batch	Prepared	Analyzed	Method	Notes
B17 (P112180-02) Water Sampled: 12/06/01 09:30 Received: 12/07/01 15:10									
Dibromochloromethane	ND	1.0	ug/l	1	1L10028	12/11/01	12/11/01	EPA 8021B	
1,2-Dibromoethane	ND	1.0	"	"	"	"	"	"	
Chlorobenzene	ND	1.0	"	"	"	"	"	"	
1,1,1,2-Tetrachloroethane	ND	1.0	"	"	"	"	"	"	
Bromofom	ND	1.0	"	"	"	"	"	"	
1,1,1,2,2-Tetrachloroethane	ND	1.0	"	"	"	"	"	"	
1,2,3-Trichloropropane	ND	1.0	"	"	"	"	"	"	
Bromobenzene	ND	1.0	"	"	"	"	"	"	
2-Chlorotoluene	ND	1.0	"	"	"	"	"	"	
4-Chlorotoluene	ND	1.0	"	"	"	"	"	"	
1,3-Dichlorobenzene	ND	0.50	"	"	"	"	"	"	
1,4-Dichlorobenzene	ND	1.0	"	"	"	"	"	"	
1,2-Dichlorobenzene	ND	1.0	"	"	"	"	"	"	
1,2-Dibromo-3-chloropropane	ND	1.0	"	"	"	"	"	"	
1,2,4-Trichlorobenzene	ND	0.50	"	"	"	"	"	"	
Hexachlorobutadiene	ND	0.50	"	"	"	"	"	"	
1,2,3-Trichlorobenzene	ND	0.50	"	"	"	"	"	"	
Surrogate: Dibromodifluoromethane		121 %	50-150	"	"	"	"	"	
Surrogate: 4-Bromofluorobenzene		106 %	50-150	"	"	"	"	"	
B18 (P112180-03) Water Sampled: 12/06/01 10:30 Received: 12/07/01 15:10									
Dichlorodifluoromethane	ND	1.0	ug/l	1	1L10028	12/11/01	12/11/01	EPA 8021B	
Chloromethane	ND	2.0	"	"	"	"	"	"	
Vinyl chloride	ND	1.0	"	"	"	"	"	"	
Bromomethane	ND	1.0	"	"	"	"	"	"	
Chloroethane	ND	1.0	"	"	"	"	"	"	
Trichlorofluoromethane	ND	1.0	"	"	"	"	"	"	
1,1-Dichloroethene	ND	1.0	"	"	"	"	"	"	
Methylene chloride	ND	5.0	"	"	"	"	"	"	
trans-1,2-Dichloroethene	ND	1.0	"	"	"	"	"	"	
1,1-Dichloroethane	ND	1.0	"	"	"	"	"	"	
2,2-Dichloropropane	ND	1.0	"	"	"	"	"	"	
cis-1,2-Dichloroethene	ND	1.0	"	"	"	"	"	"	
Chloroform	ND	1.0	"	"	"	"	"	"	
Bromochloromethane	ND	1.0	"	"	"	"	"	"	
1,1,1-Trichloroethane	ND	1.0	"	"	"	"	"	"	
1,1-Dichloropropene	ND	1.0	"	"	"	"	"	"	
Carbon tetrachloride	ND	1.0	"	"	"	"	"	"	



Conor Pacific / EFW
2580 Wyandotte St., Suite G
Mountain View CA, 94043

Project: Cargill Salt
Project Number: CRA102.02
Project Manager: Martha Watson

Reported:
12/13/01 12:52

**Volatile Organics by EPA Method 8021B
Sequoia Analytical - Walnut Creek**

Analyte	Result	Reporting Limit	Units	Dilution	Batch	Prepared	Analyzed	Method	Notes
B18 (P112180-03) Water Sampled: 12/06/01 10:30 Received: 12/07/01 15:10									
1,2-Dichloroethane	ND	2.0	ug/l	1	1L10028	12/11/01	12/11/01	EPA 8021B	
Trichloroethene	ND	1.0	"	"	"	"	"	"	"
1,2-Dichloropropane	ND	1.0	"	"	"	"	"	"	"
Bromodichloromethane	ND	1.0	"	"	"	"	"	"	"
Dibromomethane	ND	1.0	"	"	"	"	"	"	"
cis-1,3-Dichloropropene	ND	1.0	"	"	"	"	"	"	"
trans-1,3-Dichloropropene	ND	1.0	"	"	"	"	"	"	"
1,1,2-Trichloroethane	ND	1.0	"	"	"	"	"	"	"
1,3-Dichloropropane	ND	2.0	"	"	"	"	"	"	"
Tetrachloroethene	ND	1.0	"	"	"	"	"	"	"
Dibromochloromethane	ND	1.0	"	"	"	"	"	"	"
1,2-Dibromoethane	ND	1.0	"	"	"	"	"	"	"
Chlorobenzene	ND	1.0	"	"	"	"	"	"	"
1,1,1,2-Tetrachloroethane	ND	1.0	"	"	"	"	"	"	"
Bromoform	ND	1.0	"	"	"	"	"	"	"
1,1,2,2-Tetrachloroethane	ND	1.0	"	"	"	"	"	"	"
1,2,3-Trichloropropane	ND	1.0	"	"	"	"	"	"	"
Bromobenzene	ND	1.0	"	"	"	"	"	"	"
2-Chlorotoluene	ND	1.0	"	"	"	"	"	"	"
4-Chlorotoluene	ND	1.0	"	"	"	"	"	"	"
1,3-Dichlorobenzene	ND	0.50	"	"	"	"	"	"	"
1,4-Dichlorobenzene	ND	1.0	"	"	"	"	"	"	"
1,2-Dichlorobenzene	ND	1.0	"	"	"	"	"	"	"
1,2-Dibromo-3-chloropropane	ND	1.0	"	"	"	"	"	"	"
1,2,4-Trichlorobenzene	ND	0.50	"	"	"	"	"	"	"
Hexachlorobutadiene	ND	0.50	"	"	"	"	"	"	"
1,2,3-Trichlorobenzene	ND	0.50	"	"	"	"	"	"	"
Surrogate: Dibromodifluoromethane		99 %		50-150	"	"	"	"	"
Surrogate: 4-Bromo fluorobenzene		95 %		50-150	"	"	"	"	"



Conor Pacific / EFW
2580 Wyandotte St., Suite G
Mountain View CA, 94043

Project: Cargill Salt
Project Number: CRA102.02
Project Manager: Martha Watson

Reported:
12/13/01 12:52

**Volatile Organics by EPA Method 8021B
Sequoia Analytical - Walnut Creek**

Analyte	Result	Reporting Limit	Units	Dilution	Batch	Prepared	Analyzed	Method	Notes
B19 (P112180-04) Water Sampled: 12/06/01 12:00 Received: 12/07/01 15:10									
Dichlorodifluoromethane	ND	1.0	ug/l	1	1L10028	12/11/01	12/11/01	EPA 8021B	
Chloromethane	ND	2.0	"	"	"	"	"	"	
Vinyl chloride	ND	1.0	"	"	"	"	"	"	
Bromomethane	ND	1.0	"	"	"	"	"	"	
Chloroethane	ND	1.0	"	"	"	"	"	"	
Trichlorofluoromethane	ND	1.0	"	"	"	"	"	"	
1,1-Dichloroethene	ND	1.0	"	"	"	"	"	"	
Methylene chloride	ND	5.0	"	"	"	"	"	"	
trans-1,2-Dichloroethene	ND	1.0	"	"	"	"	"	"	
1,1-Dichloroethane	ND	1.0	"	"	"	"	"	"	
2,2-Dichloropropane	ND	1.0	"	"	"	"	"	"	
cis-1,2-Dichloroethene	ND	1.0	"	"	"	"	"	"	
Chloroform	ND	1.0	"	"	"	"	"	"	
Bromochloromethane	ND	1.0	"	"	"	"	"	"	
1,1,1-Trichloroethane	ND	1.0	"	"	"	"	"	"	
1,1-Dichloropropene	ND	1.0	"	"	"	"	"	"	
Carbon tetrachloride	ND	1.0	"	"	"	"	"	"	
1,2-Dichloroethane	ND	2.0	"	"	"	"	"	"	
Trichloroethene	ND	1.0	"	"	"	"	"	"	
1,2-Dichloropropane	ND	1.0	"	"	"	"	"	"	
Bromodichloromethane	ND	1.0	"	"	"	"	"	"	
Dibromomethane	ND	1.0	"	"	"	"	"	"	
cis-1,3-Dichloropropene	ND	1.0	"	"	"	"	"	"	
trans-1,3-Dichloropropene	ND	1.0	"	"	"	"	"	"	
1,1,2-Trichloroethane	ND	1.0	"	"	"	"	"	"	
1,3-Dichloropropane	ND	2.0	"	"	"	"	"	"	
Tetrachloroethene	ND	1.0	"	"	"	"	"	"	
Dibromochloromethane	ND	1.0	"	"	"	"	"	"	
1,2-Dibromoethane	ND	1.0	"	"	"	"	"	"	
Chlorobenzene	ND	1.0	"	"	"	"	"	"	
1,1,1,2-Tetrachloroethane	ND	1.0	"	"	"	"	"	"	
Bromoform	ND	1.0	"	"	"	"	"	"	
1,1,2,2-Tetrachloroethane	ND	1.0	"	"	"	"	"	"	
1,2,3-Trichloropropane	ND	1.0	"	"	"	"	"	"	
Bromobenzene	ND	1.0	"	"	"	"	"	"	
2-Chlorotoluene	ND	1.0	"	"	"	"	"	"	
4-Chlorotoluene	ND	1.0	"	"	"	"	"	"	
1,3-Dichlorobenzene	ND	0.50	"	"	"	"	"	"	

Sequoia Analytical - Petaluma

The results in this report apply to the samples analyzed in accordance with the chain of custody document. This analytical report must be reproduced in its entirety.



Conor Pacific / EFW
2580 Wyandotte St., Suite G
Mountain View CA, 94043

Project: Cargill Salt
Project Number: CRA102.02
Project Manager: Martha Watson

Reported:
12/13/01 12:52

Volatile Organics by EPA Method 8021B
Sequoia Analytical - Walnut Creek

Analyte	Result	Reporting Limit	Units	Dilution	Batch	Prepared	Analyzed	Method	Notes
B19 (P112180-04) Water Sampled: 12/06/01 12:00 Received: 12/07/01 15:10									
1,4-Dichlorobenzene	ND	1.0	ug/l	1	1L10028	12/11/01	12/11/01	EPA 8021B	
1,2-Dichlorobenzene	ND	1.0	"	"	"	"	"	"	
1,2-Dibromo-3-chloropropane	ND	1.0	"	"	"	"	"	"	
1,2,4-Trichlorobenzene	ND	0.50	"	"	"	"	"	"	
Hexachlorobutadiene	ND	0.50	"	"	"	"	"	"	
1,2,3-Trichlorobenzene	ND	0.50	"	"	"	"	"	"	
Surrogate: Dibromodifluoromethane		124 %	50-150	"	"	"	"	"	
Surrogate: 4-Bromofluorobenzene		111 %	50-150	"	"	"	"	"	
B20 (P112180-05) Water Sampled: 12/06/01 13:00 Received: 12/07/01 15:10									
Dichlorodifluoromethane	ND	1.0	ug/l	1	1L10028	12/11/01	12/11/01	EPA 8021B	
Chloromethane	ND	2.0	"	"	"	"	"	"	
Vinyl chloride	ND	1.0	"	"	"	"	"	"	
Bromomethane	ND	1.0	"	"	"	"	"	"	
Chloroethane	ND	1.0	"	"	"	"	"	"	
Trichlorofluoromethane	ND	1.0	"	"	"	"	"	"	
1,1-Dichloroethene	1.3	1.0	"	"	"	"	"	"	
Methylene chloride	ND	5.0	"	"	"	"	"	"	
trans-1,2-Dichloroethene	ND	1.0	"	"	"	"	"	"	
1,1-Dichloroethane	ND	1.0	"	"	"	"	"	"	
2,2-Dichloropropane	ND	1.0	"	"	"	"	"	"	
cis-1,2-Dichloroethene	ND	1.0	"	"	"	"	"	"	
Chloroform	ND	1.0	"	"	"	"	"	"	
Bromochloromethane	ND	1.0	"	"	"	"	"	"	
1,1,1-Trichloroethane	ND	1.0	"	"	"	"	"	"	
1,1-Dichloropropene	ND	1.0	"	"	"	"	"	"	
Carbon tetrachloride	ND	1.0	"	"	"	"	"	"	
1,2-Dichloroethane	ND	2.0	"	"	"	"	"	"	
Trichloroethene	11	1.0	"	"	"	"	"	"	
1,2-Dichloropropane	ND	1.0	"	"	"	"	"	"	
Bromodichloromethane	ND	1.0	"	"	"	"	"	"	
Dibromomethane	ND	1.0	"	"	"	"	"	"	
cis-1,3-Dichloropropene	ND	1.0	"	"	"	"	"	"	
trans-1,3-Dichloropropene	ND	1.0	"	"	"	"	"	"	
1,1,2-Trichloroethane	ND	1.0	"	"	"	"	"	"	
1,3-Dichloropropane	ND	2.0	"	"	"	"	"	"	
Tetrachloroethene	120	5.0	"	5	"	"	"	"	
Dibromochloromethane	ND	1.0	"	1	"	"	"	"	



Conor Pacific / EFW
2580 Wyandotte St., Suite G
Mountain View CA, 94043

Project: Cargill Salt
Project Number: CRA102.02
Project Manager: Martha Watson

Reported:
12/13/01 12:52

Volatile Organics by EPA Method 8021B
Sequoia Analytical - Walnut Creek

Analyte	Result	Reporting Limit	Units	Dilution	Batch	Prepared	Analyzed	Method	Notes
B20 (P112180-05) Water Sampled: 12/06/01 13:00 Received: 12/07/01 15:10									
1,2-Dibromoethane	ND	1.0	ug/l	1	1L10028	12/11/01	12/11/01	EPA 8021B	
Chlorobenzene	ND	1.0	"	"	"	"	"	"	
1,1,1,2-Tetrachloroethane	ND	1.0	"	"	"	"	"	"	
Bromoforn	ND	1.0	"	"	"	"	"	"	
1,1,2,2-Tetrachloroethane	ND	1.0	"	"	"	"	"	"	
1,2,3-Trichloropropane	ND	1.0	"	"	"	"	"	"	
Bromobenzene	ND	1.0	"	"	"	"	"	"	
2-Chlorotoluene	ND	1.0	"	"	"	"	"	"	
4-Chlorotoluene	ND	1.0	"	"	"	"	"	"	
1,3-Dichlorobenzene	ND	0.50	"	"	"	"	"	"	
1,4-Dichlorobenzene	ND	1.0	"	"	"	"	"	"	
1,2-Dichlorobenzene	ND	1.0	"	"	"	"	"	"	
1,2-Dibromo-3-chloropropane	ND	1.0	"	"	"	"	"	"	
1,2,4-Trichlorobenzene	ND	0.50	"	"	"	"	"	"	
Hexachlorobutadiene	ND	0.50	"	"	"	"	"	"	
1,2,3-Trichlorobenzene	ND	0.50	"	"	"	"	"	"	
Surrogate: Dibromodifluoromethane		133 %		50-150	"	"	"	"	
Surrogate: 4-Bromofluorobenzene		115 %		50-150	"	"	"	"	



Conor Pacific / EFW
2580 Wyandotte St., Suite G
Mountain View CA, 94043

Project: Cargill Salt
Project Number: CRA102.02
Project Manager: Martha Watson

Reported:
12/13/01 12:52

**Volatile Organics by EPA Method 8021B - Quality Control
Sequoia Analytical - Walnut Creek**

Analyte	Result	Reporting Limit	Units	Spike Level	Source Result	%REC	%REC Limits	RPD	RPD Limit	Notes
---------	--------	-----------------	-------	-------------	---------------	------	-------------	-----	-----------	-------

Batch 1L10028 - EPA 5030B [P/T]

Blank (1L10028-BLK2)

Prepared & Analyzed: 12/11/01

Dichlorodifluoromethane	ND	1.0	ug/l							
Chloromethane	ND	2.0	"							
Vinyl chloride	ND	1.0	"							
Bromomethane	ND	1.0	"							
Chloroethane	ND	1.0	"							
Trichlorofluoromethane	ND	1.0	"							
1,1-Dichloroethene	ND	1.0	"							
Methylene chloride	ND	5.0	"							
trans-1,2-Dichloroethene	ND	1.0	"							
1,1-Dichloroethane	ND	1.0	"							
2,2-Dichloropropane	ND	1.0	"							
cis-1,2-Dichloroethene	ND	1.0	"							
Chloroform	ND	1.0	"							
Bromochloromethane	ND	1.0	"							
1,1,1-Trichloroethane	ND	1.0	"							
1,1-Dichloropropene	ND	1.0	"							
Carbon tetrachloride	ND	1.0	"							
1,2-Dichloroethane	ND	2.0	"							
Trichloroethene	ND	1.0	"							
1,2-Dichloropropane	ND	1.0	"							
Bromodichloromethane	ND	1.0	"							
Dibromomethane	ND	1.0	"							
cis-1,3-Dichloropropene	ND	1.0	"							
trans-1,3-Dichloropropene	ND	1.0	"							
1,1,2-Trichloroethane	ND	1.0	"							
1,3-Dichloropropane	ND	2.0	"							
Tetrachloroethene	ND	1.0	"							
Dibromochloromethane	ND	1.0	"							
1,2-Dibromoethane	ND	1.0	"							
Chlorobenzene	ND	1.0	"							
1,1,1,2-Tetrachloroethane	ND	1.0	"							
Bromoform	ND	1.0	"							
1,1,2,2-Tetrachloroethane	ND	1.0	"							
1,2,3-Trichloropropane	ND	1.0	"							
Bromobenzene	ND	1.0	"							
2-Chlorotoluene	ND	1.0	"							



Conor Pacific / BFW
2580 Wyandotte St., Suite G
Mountain View CA, 94043

Project: Cargill Salt
Project Number: CRA102.02
Project Manager: Martha Watson

Reported:
12/13/01 12:52

Volatile Organics by EPA Method 8021B - Quality Control
Sequoia Analytical - Walnut Creek

Analyte	Result	Reporting Limit	Units	Spike Level	Source Result	%REC	%REC Limits	RPD	RPD Limit	Notes
---------	--------	-----------------	-------	-------------	---------------	------	-------------	-----	-----------	-------

Batch 1L10028 - EPA 5030B [P/T]

Blank (1L10028-BLK2)

Prepared & Analyzed: 12/11/01

4-Chlorotoluene	ND	1.0	ug/l							
1,3-Dichlorobenzene	ND	0.50	"							
1,4-Dichlorobenzene	ND	1.0	"							
1,2-Dichlorobenzene	ND	1.0	"							
1,2-Dibromo-3-chloropropane	ND	1.0	"							
1,2,4-Trichlorobenzene	ND	0.50	"							
Hexachlorobutadiene	ND	0.50	"							
1,2,3-Trichlorobenzene	ND	0.50	"							

Surrogate: Dibromodifluoromethane	12.8		"	10.0		128	50-150			
Surrogate: 4-Bromofluorobenzene	10.8		"	10.0		108	50-150			

LCS (1L10028-BS2)

Prepared & Analyzed: 12/11/01

1,1-Dichloroethene	17.7	1.0	ug/l	20.0		88	65-135			
Trichloroethene	18.1	1.0	"	20.0		90	70-130			
Chlorobenzene	17.4	1.0	"	20.0		87	70-130			

Surrogate: Dibromodifluoromethane	13.3		"	10.0		133	50-150			
Surrogate: 4-Bromofluorobenzene	8.16		"	10.0		82	50-150			

Matrix Spike (1L10028-MS1)

Source: W112046-01

Prepared & Analyzed: 12/10/01

1,1-Dichloroethene	15.8	1.0	ug/l	20.0	ND	79	60-140			
Trichloroethene	17.2	1.0	"	20.0	ND	86	60-140			
Chlorobenzene	16.8	1.0	"	20.0	ND	84	60-140			

Surrogate: Dibromodifluoromethane	12.2		"	10.0		122	50-150			
Surrogate: 4-Bromofluorobenzene	9.29		"	10.0		93	50-150			

Matrix Spike Dup (1L10028-MSD1)

Source: W112046-01

Prepared & Analyzed: 12/10/01

1,1-Dichloroethene	16.2	1.0	ug/l	20.0	ND	81	60-140	3	25	
Trichloroethene	17.7	1.0	"	20.0	ND	88	60-140	3	25	
Chlorobenzene	17.7	1.0	"	20.0	ND	88	60-140	5	25	

Surrogate: Dibromodifluoromethane	11.4		"	10.0		114	50-150			
Surrogate: 4-Bromofluorobenzene	9.54		"	10.0		95	50-150			

Sequoia Analytical - Petaluma

The results in this report apply to the samples analyzed in accordance with the chain of custody document. This analytical report must be reproduced in its entirety.



Conor Pacific / EFW
2580 Wyandotte St., Suite G
Mountain View CA, 94043

Project: Cargill Salt
Project Number: CRA102.02
Project Manager: Martha Watson

Reported:
12/13/01 12:52

**Volatile Organics by EPA Method 8021B - Quality Control
Sequoia Analytical - Walnut Creek**

Analyte	Result	Reporting	Spike	Source	%REC	%REC	RPD	RPD	Notes
		Limit							

Batch 1L10028 - EPA 5030B [P/T]

Matrix Spike Dup (1L10028-MSD1) Source: W112046-01 Prepared & Analyzed: 12/10/01



Conor Pacific / EFW
2580 Wyandotte St., Suite G
Mountain View CA, 94043

Project: Cargill Salt
Project Number: CRA102.02
Project Manager: Martha Watson

Reported:
12/13/01 12:52

Notes and Definitions

DET Analyte DETECTED
ND Analyte NOT DETECTED at or above the reporting limit
NR Not Reported
dry Sample results reported on a dry weight basis
RPD Relative Percent Difference

CHAIN OF CUSTODY

PROJECT NO.: <u>CAR102.02</u>		SITE NAME: <u>CARGILL ALAMEDA</u>		ANALYSES <div style="border: 1px solid black; padding: 5px; width: fit-content; margin: 0 auto;"> EDD required? <input type="checkbox"/> Yes <input checked="" type="checkbox"/> No </div>								
SAMPLER(S): <u>MRS. WATSON</u> (printed) <u>Mrs Watson</u> (signature)												
CONTRACT LABORATORY: <u>SEQUOIA-Petaluma</u>			Container Info	60213 LST								
TURN-AROUND TIME: <u>STD</u>			Type/Vol.									
Sample I.D.	Lab I.D.	Collection		Matrix	Depth	Filter		Preserv.	HCL	HCL	Cont. Qty.	Remarks
		Date	Time									
B16	A12180-01	12/6	9:00	W		41 ml T			✓		2	
B17	-02		9:30			VOA			✓		2	
B18	-03		10:30						✓		2	
B19	-04		12:00						✓		3	
B20	-05		13:00						✓		3	
COOLER CUSTODY SEALS INTACT NOT INTACT COOLER TEMPERATURE <u>4.0</u> °C												
Relinquished by: (signature) <u>Maria Watson</u>				Received by: (signature) <u>Jim Co</u>				Date/Time: <u>12/6/16 1615</u>		SEND RESULTS TO: Attn: <u>MARIA WATSON</u> Conor Pacific/EFW 2580 Wyandotte St., Suite G Mountain View, CA 94043 Phone (650) 386-3828 Fax (650) 386-3815		
Relinquished by: (signature)				Received by: (signature)				Date/Time: <u>12-7-16 18:00</u>				
Relinquished by: (signature)				Received by: (signature) <u>Sal Grillo</u>				Date/Time: <u>12-7-16 1570</u>				



COOPER TESTING LABORATORY

1951 Colony St., Unit X, Mountain View, CA 94043

Tel: 650 968-9472 Fax: 650 968-4228

1360-D Industrial Ave., Petaluma, CA 94952

Tel: 707 765-2589 Fax: 707 765-1227

email: cooper@coopertestinglabs.com

www.coopertestinglabs.com

LETTER OF TRANSMITTAL

TO: Conor Pacific
2580 Wyandotte St., Suite G
Mountain View CA 94043
Attn: M. Watson

DATE: January 3, 2002

PROJECT: CRA102.02

CTL #: 072-018

ENCLOSED: Laboratory soil test data.

REMARKS:

David R. Cooper

COOPER TESTING LABS



Moisture-Density-Porosity Report

Cooper Testing Labs, Inc.

Job No: 072-018 Date: 1/0/1900
 Client: Conor Pacific By: 0
 Project: CRA102.02 / Gargill

Boring:	B21-8	B21-15					
Sample:							
Depth:							
Description	brown mottled gray silty SAND	brown silty SAND					
Actual G_s	2.69	2.68					
Assumed G_s							
Moisture, %	18.8	16.9					
Wet Unit, pcf	132.1	134.5					
Dry Unit, pcf	111.2	115.0					
Saturation, %	98.9	99.3					
Porosity, %	33.8	31.3					
Void Ratio	0.511	0.455					
Series	2	3	4	5	6	7	8

Moisture-Density

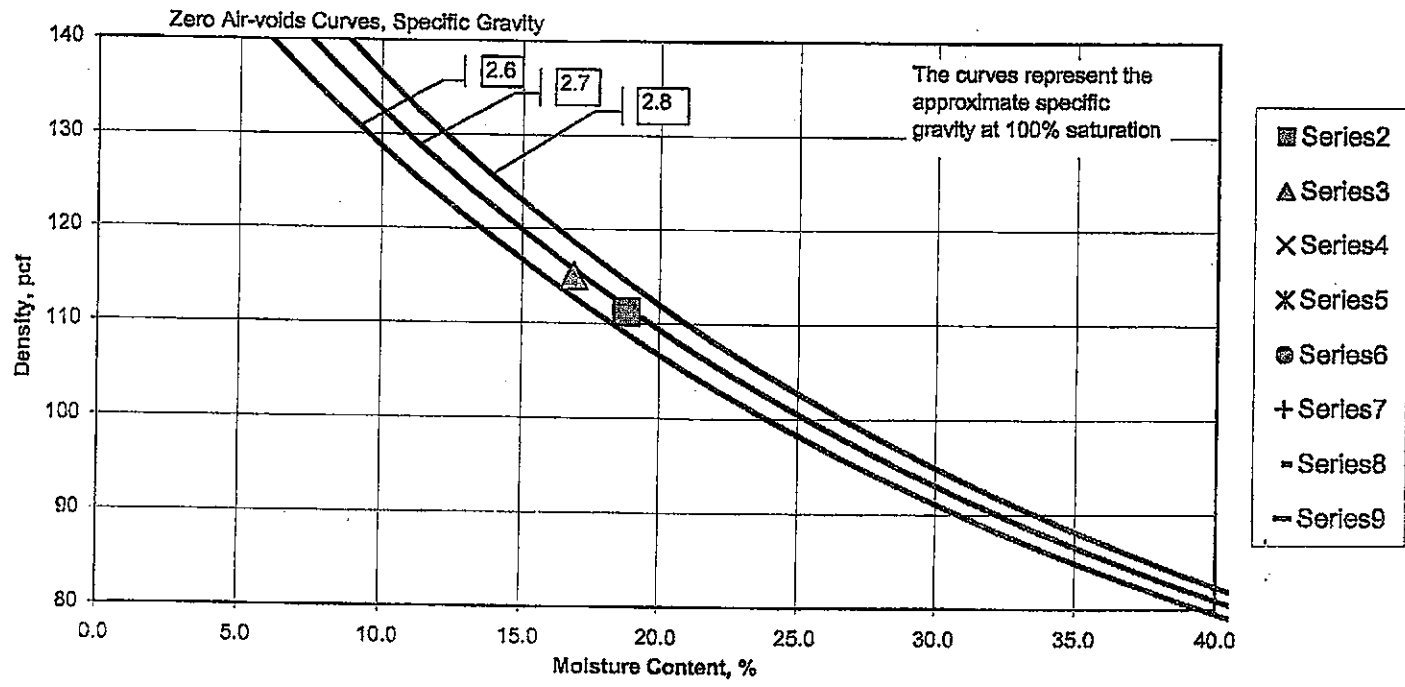



Specific Gravity by Pycnometer

ASTM D 854

Job#:	072-018	Date:	01/02/02
Client:	Conor Pacific	By:	DC
Project:	CRA102.02		

Boring: Sample: Depth, ft.:	B-21-8	B-21-15				
Soil Description (visual)	see porosity report					
Wb	714	722.9				
T °C	19.3	19.3				
Wa	662.96	671.64				
Wo	81.23	81.76				
K	1	1				
Gs = $\frac{K \cdot Wo}{Wo + Wa - Wb}$ Specific Gravity (20°C)	2.69	2.68				

Wb = Weight of Pycnometer, Soil & Water

T = Temperature

Wo = Weight of Air-Dried Soil

Wa = Weight of Pycnometer & Water

K = Temperature Correction Factor

Note

The temperature correction factor will be shown as 1 if the weight of pycnometer and water was taken from the temperature correction curve in the laboratory or if the temp was 20c.



**Percent Organic Content Test
ASTM D 2974**

JOB NO.: 072-018
CLIENT : Conor Pacific
PROJECT: CRA102.02

DATE: 1/2/2002
BY: DC

Boring :	B-21-8	B-21-15				
Sample :						
Depth :						
Visual Description:	See Porosity Report					
Soil, Org & Dish, gm	152.87	156.97				
Soil & Dish, gm	152.33	156.53				
Dish, gm	81.57	80.21				
Soil, gm	70.76	76.32	0	0	0	0
Soil & Organics, gm	71.3	76.76	0	0	0	0
Organic Content: %	0.8	0.6	#DIV/0!	#DIV/0!	#DIV/0!	#DIV/0!

Remarks:

Halogenated Volatile Organic Compounds by 8021



Crawford Consulting INC.	☐ 2 North First Street 4th Floor San Jose, CA 95113-1212
Attn: Mark Wheeler	Phone: (408) 287-9934 Fax: (408) 287-9937
CS1606	Project: Alameda Facility

STL San Francisco
1220 Quarry Lane
Pleasanton, CA 94566

Tel 925 484 1919
Fax 925 484 1096
www.stl-inc.com
www.chromalab.com

CA DHS ELAP#1094

Samples Reported

Sample ID	Matrix	Date Sampled	Lab #
MW-1	Water	12/17/2001 15:13	1
MW-2	Water	12/17/2001 13:23	2
MW-3	Water	12/17/2001 14:23	3
MW-4	Water	12/17/2001 12:28	4
DUP-1	Water	12/17/2001	5

Halogenated Volatile Organic Compounds by 8021

Crawford Consulting INC.

Test Method: 8021B

Attn: Mark Wheeler

Prep Method: 5030B

STL San Francisco
1220 Quarry Lane
Pleasanton, CA 94566Tel 925 484 1919
Fax 925 484 1096
www.stl-inc.com
www.chromalab.com

CA DHS ELAP#1094

Sample ID: MW-1	Lab Sample ID: 2001-12-0305-001
Project: CS1606 Alameda Facility	Received: 12/17/2001 16:30
Sampled: 12/17/2001 15:13	Extracted: 12/21/2001 02:49
Matrix: Water	QC-Batch: 2001/12/20-01.26
Sample/Analysis Flag: o (See Legend & Note section)	

Compound	Result	Rep.Limit	Units	Dilution	Analyzed	Flag
Dichlorodifluoromethane	ND	25	ug/L	25.00	12/21/2001 02:49	
Vinyl chloride	ND	13	ug/L	25.00	12/21/2001 02:49	
Chloroethane	ND	13	ug/L	25.00	12/21/2001 02:49	
Trichlorofluoromethane	ND	13	ug/L	25.00	12/21/2001 02:49	
1,1-Dichloroethene	ND	13	ug/L	25.00	12/21/2001 02:49	
Methylene chloride	ND	130	ug/L	25.00	12/21/2001 02:49	
trans-1,2-Dichloroethene	ND	13	ug/L	25.00	12/21/2001 02:49	
cis-1,2-Dichloroethene	ND	13	ug/L	25.00	12/21/2001 02:49	
1,1-Dichloroethane	ND	13	ug/L	25.00	12/21/2001 02:49	
Chloroform	ND	13	ug/L	25.00	12/21/2001 02:49	
1,1,1-Trichloroethane	ND	13	ug/L	25.00	12/21/2001 02:49	
Carbon tetrachloride	ND	13	ug/L	25.00	12/21/2001 02:49	
1,2-Dichloroethane	ND	13	ug/L	25.00	12/21/2001 02:49	
Trichloroethene	190	13	ug/L	25.00	12/21/2001 02:49	
1,2-Dichloropropane	ND	13	ug/L	25.00	12/21/2001 02:49	
Bromodichloromethane	ND	13	ug/L	25.00	12/21/2001 02:49	
2-Chloroethylvinyl ether	ND	13	ug/L	25.00	12/21/2001 02:49	
trans-1,3-Dichloropropene	ND	13	ug/L	25.00	12/21/2001 02:49	
cis-1,3-Dichloropropene	ND	13	ug/L	25.00	12/21/2001 02:49	
1,1,2-Trichloroethane	ND	13	ug/L	25.00	12/21/2001 02:49	
Tetrachloroethene	1400	25	ug/L	50.00	12/21/2001 14:56	
Dibromochloromethane	ND	13	ug/L	25.00	12/21/2001 02:49	
Chlorobenzene	ND	13	ug/L	25.00	12/21/2001 02:49	
Bromoform	ND	50	ug/L	25.00	12/21/2001 02:49	
1,1,2,2-Tetrachloroethane	ND	13	ug/L	25.00	12/21/2001 02:49	
1,3-Dichlorobenzene	ND	13	ug/L	25.00	12/21/2001 02:49	
1,4-Dichlorobenzene	ND	13	ug/L	25.00	12/21/2001 02:49	
1,2-Dichlorobenzene	ND	13	ug/L	25.00	12/21/2001 02:49	
Trichlorotrifluoroethane	ND	50	ug/L	25.00	12/21/2001 02:49	
Chloromethane	ND	25	ug/L	25.00	12/21/2001 02:49	
Bromomethane	ND	25	ug/L	25.00	12/21/2001 02:49	
Surrogate(s)						
1-Chloro-2-fluorobenzene	93.4	70-130	%	50.00	12/21/2001 02:49	

Halogenated Volatile Organic Compounds by 8021

Crawford Consulting INC.

Test Method: 8021B

Attn: Mark Wheeler

Prep Method: 5030B

STL San Francisco
1220 Quarry Lane
Pleasanton, CA 94566

Tel 925 484 1919
Fax 925 484 1096
www.stl-inc.com
www.chromalab.com

CA DHS ELAP#1094

Sample ID: MW-2	Lab Sample ID: 2001-12-0305-002
Project: CS1606 Alameda Facility	Received: 12/17/2001 16:30
Sampled: 12/17/2001 13:23	Extracted: 12/21/2001 13:06
Matrix: Water	QC-Batch: 2001/12/21-01.26
Sample/Analysis Flag: o (See Legend & Note section)	

Compound	Result	Rep.Limit	Units	Dilution	Analyzed	Flag
Dichlorodifluoromethane	ND	50	ug/L	50.00	12/21/2001 13:06	
Vinyl chloride	ND	25	ug/L	50.00	12/21/2001 13:06	
Chloroethane	ND	25	ug/L	50.00	12/21/2001 13:06	
Trichlorofluoromethane	ND	25	ug/L	50.00	12/21/2001 13:06	
1,1-Dichloroethene	ND	25	ug/L	50.00	12/21/2001 13:06	
Methylene chloride	ND	250	ug/L	50.00	12/21/2001 13:06	
trans-1,2-Dichloroethene	ND	25	ug/L	50.00	12/21/2001 13:06	
cis-1,2-Dichloroethene	ND	25	ug/L	50.00	12/21/2001 13:06	
1,1-Dichloroethane	ND	25	ug/L	50.00	12/21/2001 13:06	
Chloroform	ND	25	ug/L	50.00	12/21/2001 13:06	
1,1,1-Trichloroethane	ND	25	ug/L	50.00	12/21/2001 13:06	
Carbon tetrachloride	ND	25	ug/L	50.00	12/21/2001 13:06	
1,2-Dichloroethane	ND	25	ug/L	50.00	12/21/2001 13:06	
Trichloroethene	ND	25	ug/L	50.00	12/21/2001 13:06	
1,2-Dichloropropane	ND	25	ug/L	50.00	12/21/2001 13:06	
Bromodichloromethane	ND	25	ug/L	50.00	12/21/2001 13:06	
2-Chloroethylvinyl ether	ND	25	ug/L	50.00	12/21/2001 13:06	
trans-1,3-Dichloropropene	ND	25	ug/L	50.00	12/21/2001 13:06	
cis-1,3-Dichloropropene	ND	25	ug/L	50.00	12/21/2001 13:06	
1,1,2-Trichloroethane	ND	25	ug/L	50.00	12/21/2001 13:06	
Tetrachloroethene	1700	25	ug/L	50.00	12/21/2001 13:06	
Dibromochloromethane	ND	25	ug/L	50.00	12/21/2001 13:06	
Chlorobenzene	ND	25	ug/L	50.00	12/21/2001 13:06	
Bromoform	ND	100	ug/L	50.00	12/21/2001 13:06	
1,1,2,2-Tetrachloroethane	ND	25	ug/L	50.00	12/21/2001 13:06	
1,3-Dichlorobenzene	ND	25	ug/L	50.00	12/21/2001 13:06	
1,4-Dichlorobenzene	ND	25	ug/L	50.00	12/21/2001 13:06	
1,2-Dichlorobenzene	ND	25	ug/L	50.00	12/21/2001 13:06	
Trichlorotrifluoroethane	ND	100	ug/L	50.00	12/21/2001 13:06	
Chloromethane	ND	50	ug/L	50.00	12/21/2001 13:06	
Bromomethane	ND	50	ug/L	50.00	12/21/2001 13:06	
Surrogate(s)						
1-Chloro-2-fluorobenzene	100.8	70-130	%	1.00	12/21/2001 13:06	

Halogenated Volatile Organic Compounds by 8021

Crawford Consulting INC.

Test Method: 8021B

Attn: Mark Wheeler

Prep Method: 5030B

STL San Francisco
1220 Quarry Lane
Pleasanton, CA 94566

Tel 925 484 1919
Fax 925 484 1096
www.stl-inc.com
www.chromalab.com

CA DHS ELAP#1094

Sample ID: MW-3	Lab Sample ID: 2001-12-0305-003
Project: CS1606 Alameda Facility	Received: 12/17/2001 16:30
Sampled: 12/17/2001 14:23	Extracted: 12/21/2001 13:48
Matrix: Water	QC-Batch: 2001/12/21-01.26

Compound	Result	Rep.Limit	Units	Dilution	Analyzed	Flag
Dichlorodifluoromethane	ND	1.0	ug/L	1.00	12/21/2001 13:48	
Vinyl chloride	ND	0.50	ug/L	1.00	12/21/2001 13:48	
Chloroethane	ND	0.50	ug/L	1.00	12/21/2001 13:48	
Trichlorofluoromethane	ND	0.50	ug/L	1.00	12/21/2001 13:48	
1,1-Dichloroethene	ND	0.50	ug/L	1.00	12/21/2001 13:48	
Methylene chloride	ND	5.0	ug/L	1.00	12/21/2001 13:48	
trans-1,2-Dichloroethene	ND	0.50	ug/L	1.00	12/21/2001 13:48	
cis-1,2-Dichloroethene	ND	0.50	ug/L	1.00	12/21/2001 13:48	
1,1-Dichloroethane	ND	0.50	ug/L	1.00	12/21/2001 13:48	
Chloroform	ND	0.50	ug/L	1.00	12/21/2001 13:48	
1,1,1-Trichloroethane	ND	0.50	ug/L	1.00	12/21/2001 13:48	
Carbon tetrachloride	ND	0.50	ug/L	1.00	12/21/2001 13:48	
1,2-Dichloroethane	ND	0.50	ug/L	1.00	12/21/2001 13:48	
Trichloroethene	ND	0.50	ug/L	1.00	12/21/2001 13:48	
1,2-Dichloropropane	ND	0.50	ug/L	1.00	12/21/2001 13:48	
Bromodichloromethane	ND	0.50	ug/L	1.00	12/21/2001 13:48	
2-Chloroethylvinyl ether	ND	0.50	ug/L	1.00	12/21/2001 13:48	
trans-1,3-Dichloropropene	ND	0.50	ug/L	1.00	12/21/2001 13:48	
cis-1,3-Dichloropropene	ND	0.50	ug/L	1.00	12/21/2001 13:48	
1,1,2-Trichloroethane	ND	0.50	ug/L	1.00	12/21/2001 13:48	
Tetrachloroethene	0.81	0.50	ug/L	1.00	12/21/2001 13:48	
Dibromochloromethane	ND	0.50	ug/L	1.00	12/21/2001 13:48	
Chlorobenzene	ND	0.50	ug/L	1.00	12/21/2001 13:48	
Bromoform	ND	2.0	ug/L	1.00	12/21/2001 13:48	
1,1,2,2-Tetrachloroethane	ND	0.50	ug/L	1.00	12/21/2001 13:48	
1,3-Dichlorobenzene	ND	0.50	ug/L	1.00	12/21/2001 13:48	
1,4-Dichlorobenzene	ND	0.50	ug/L	1.00	12/21/2001 13:48	
1,2-Dichlorobenzene	ND	0.50	ug/L	1.00	12/21/2001 13:48	
Trichlorotrifluoroethane	ND	2.0	ug/L	1.00	12/21/2001 13:48	
Chloromethane	ND	1.0	ug/L	1.00	12/21/2001 13:48	
Bromomethane	ND	1.0	ug/L	1.00	12/21/2001 13:48	
Surrogate(s)						
1-Chloro-2-fluorobenzene	95.5	70-130	%	1.00	12/21/2001 13:48	

Halogenated Volatile Organic Compounds by 8021

Crawford Consulting INC.

Test Method: 8021B

Attn: Mark Wheeler

Prep Method: 5030B

STL San Francisco
1220 Quarry Lane
Pleasanton, CA 94566

Sample ID: MW-4	Lab Sample ID: 2001-12-0305-004
Project: CS1606 Alameda Facility	Received: 12/17/2001 16:30
Sampled: 12/17/2001 12:28	Extracted: 12/26/2001 14:30
Matrix: Water	QC-Batch: 2001/12/26-01.25

Tel 925 484 1919
Fax 925 484 1096
www.stl-inc.com
www.chromalab.com

CA DHS ELAP#1094

Compound	Result	Rep.Limit	Units	Dilution	Analyzed	Flag
Dichlorodifluoromethane	ND	1.0	ug/L	1.00	12/26/2001 14:30	
Vinyl chloride	ND	0.50	ug/L	1.00	12/26/2001 14:30	
Chloroethane	ND	0.50	ug/L	1.00	12/26/2001 14:30	
Trichlorofluoromethane	ND	0.50	ug/L	1.00	12/26/2001 14:30	
1,1-Dichloroethene	ND	0.50	ug/L	1.00	12/26/2001 14:30	
Methylene chloride	ND	5.0	ug/L	1.00	12/26/2001 14:30	
trans-1,2-Dichloroethene	ND	0.50	ug/L	1.00	12/26/2001 14:30	
cis-1,2-Dichloroethene	ND	0.50	ug/L	1.00	12/26/2001 14:30	
1,1-Dichloroethane	ND	0.50	ug/L	1.00	12/26/2001 14:30	
Chloroform	ND	0.50	ug/L	1.00	12/26/2001 14:30	
1,1,1-Trichloroethane	ND	0.50	ug/L	1.00	12/26/2001 14:30	
Carbon tetrachloride	ND	0.50	ug/L	1.00	12/26/2001 14:30	
1,2-Dichloroethane	ND	0.50	ug/L	1.00	12/26/2001 14:30	
Trichloroethene	ND	0.50	ug/L	1.00	12/26/2001 14:30	
1,2-Dichloropropane	ND	0.50	ug/L	1.00	12/26/2001 14:30	
Bromodichloromethane	ND	0.50	ug/L	1.00	12/26/2001 14:30	
2-Chloroethylvinyl ether	ND	0.50	ug/L	1.00	12/26/2001 14:30	
trans-1,3-Dichloropropene	ND	0.50	ug/L	1.00	12/26/2001 14:30	
cis-1,3-Dichloropropene	ND	0.50	ug/L	1.00	12/26/2001 14:30	
1,1,2-Trichloroethane	ND	0.50	ug/L	1.00	12/26/2001 14:30	
Tetrachloroethene	2.6	0.50	ug/L	1.00	12/26/2001 14:30	
Dibromochloromethane	ND	0.50	ug/L	1.00	12/26/2001 14:30	
Chlorobenzene	ND	0.50	ug/L	1.00	12/26/2001 14:30	
Bromoform	ND	2.0	ug/L	1.00	12/26/2001 14:30	
1,1,2,2-Tetrachloroethane	ND	0.50	ug/L	1.00	12/26/2001 14:30	
1,3-Dichlorobenzene	ND	0.50	ug/L	1.00	12/26/2001 14:30	
1,4-Dichlorobenzene	ND	0.50	ug/L	1.00	12/26/2001 14:30	
1,2-Dichlorobenzene	ND	0.50	ug/L	1.00	12/26/2001 14:30	
Trichlorotrifluoroethane	ND	2.0	ug/L	1.00	12/26/2001 14:30	
Chloromethane	ND	1.0	ug/L	1.00	12/26/2001 14:30	
Bromomethane	ND	1.0	ug/L	1.00	12/26/2001 14:30	
Surrogate(s)						
1-Chloro-2-fluorobenzene	91.0	70-130	%	1.00	12/26/2001 14:30	

Halogenated Volatile Organic Compounds by 8021

Crawford Consulting INC.

Test Method: 8021B

Attn: Mark Wheeler

Prep Method: 5030B

 STL San Francisco
 1220 Quarry Lane
 Pleasanton, CA 94566

 Tel 925 484 1919
 Fax 925 484 1096
 www.stl-inc.com
 www.chromalab.com

CA DHS ELAP#1094

Sample ID: DUP-1	Lab Sample ID: 2001-12-0305-005
Project: CS1606 Alameda Facility	Received: 12/17/2001 16:30
Sampled: 12/17/2001	Extracted: 12/21/2001 15:52
Matrix: Water	QC-Batch: 2001/12/21-01.25
Sample/Analysis Flag: o (See Legend & Note section)	

Compound	Result	Rep.Limit	Units	Dilution	Analyzed	Flag
Dichlorodifluoromethane	ND	50	ug/L	50.00	12/21/2001 15:52	
Vinyl chloride	ND	25	ug/L	50.00	12/21/2001 15:52	
Chloroethane	ND	25	ug/L	50.00	12/21/2001 15:52	
Trichlorofluoromethane	ND	25	ug/L	50.00	12/21/2001 15:52	
1,1-Dichloroethene	ND	25	ug/L	50.00	12/21/2001 15:52	
Methylene chloride	ND	250	ug/L	50.00	12/21/2001 15:52	
trans-1,2-Dichloroethene	ND	25	ug/L	50.00	12/21/2001 15:52	
cis-1,2-Dichloroethene	ND	25	ug/L	50.00	12/21/2001 15:52	
1,1-Dichloroethane	ND	25	ug/L	50.00	12/21/2001 15:52	
Chloroform	ND	25	ug/L	50.00	12/21/2001 15:52	
1,1,1-Trichloroethane	ND	25	ug/L	50.00	12/21/2001 15:52	
Carbon tetrachloride	ND	25	ug/L	50.00	12/21/2001 15:52	
1,2-Dichloroethane	ND	25	ug/L	50.00	12/21/2001 15:52	
Trichloroethene	210	25	ug/L	50.00	12/21/2001 15:52	
1,2-Dichloropropane	ND	25	ug/L	50.00	12/21/2001 15:52	
Bromodichloromethane	ND	25	ug/L	50.00	12/21/2001 15:52	
2-Chloroethylvinyl ether	ND	25	ug/L	50.00	12/21/2001 15:52	
trans-1,3-Dichloropropene	ND	25	ug/L	50.00	12/21/2001 15:52	
cis-1,3-Dichloropropene	ND	25	ug/L	50.00	12/21/2001 15:52	
1,1,2-Trichloroethane	ND	25	ug/L	50.00	12/21/2001 15:52	
Tetrachloroethene	1300	25	ug/L	50.00	12/21/2001 15:52	
Dibromochloromethane	ND	25	ug/L	50.00	12/21/2001 15:52	
Chlorobenzene	ND	25	ug/L	50.00	12/21/2001 15:52	
Bromoform	ND	100	ug/L	50.00	12/21/2001 15:52	
1,1,2,2-Tetrachloroethane	ND	25	ug/L	50.00	12/21/2001 15:52	
1,3-Dichlorobenzene	ND	25	ug/L	50.00	12/21/2001 15:52	
1,4-Dichlorobenzene	ND	25	ug/L	50.00	12/21/2001 15:52	
1,2-Dichlorobenzene	ND	25	ug/L	50.00	12/21/2001 15:52	
Trichlorotrifluoroethane	ND	100	ug/L	50.00	12/21/2001 15:52	
Chloromethane	ND	50	ug/L	50.00	12/21/2001 15:52	
Bromomethane	ND	50	ug/L	50.00	12/21/2001 15:52	
Surrogate(s)						
1-Chloro-2-fluorobenzene	101.5	70-130	%	50.00	12/21/2001 15:52	

Halogenated Volatile Organic Compounds by 8021

Batch QC report

Test Method: 8021B

Prep Method: 5030B

STL San Francisco
1220 Quarry Lane
Pleasanton, CA 94566

Method Blank

Water

QC Batch # 2001/12/20-01.26

MB: 2001/12/20-01.26-004

Date Extracted: 12/20/2001 09:56

Tel 925 484 1919
Fax 925 484 1096
www.stl-inc.com
www.chromalab.com

CA DHS ELAP#1094

Compound	Result	Rep.Limit	Unit	Analyzed	Flag
Dichlorodifluoromethane	ND	1.0	ug/L	12/20/2001 09:56	
Vinyl chloride	ND	0.5	ug/L	12/20/2001 09:56	
Chloroethane	ND	0.5	ug/L	12/20/2001 09:56	
Trichlorofluoromethane	ND	0.5	ug/L	12/20/2001 09:56	
1,1-Dichloroethene	ND	0.5	ug/L	12/20/2001 09:56	
Methylene chloride	ND	5.0	ug/L	12/20/2001 09:56	
trans-1,2-Dichloroethene	ND	0.5	ug/L	12/20/2001 09:56	
cis-1,2-Dichloroethene	ND	0.5	ug/L	12/20/2001 09:56	
1,1-Dichloroethane	ND	0.5	ug/L	12/20/2001 09:56	
Chloroform	ND	0.5	ug/L	12/20/2001 09:56	
1,1,1-Trichloroethane	ND	0.5	ug/L	12/20/2001 09:56	
Carbon tetrachloride	ND	0.5	ug/L	12/20/2001 09:56	
1,2-Dichloroethane	ND	0.5	ug/L	12/20/2001 09:56	
Trichloroethene	ND	0.5	ug/L	12/20/2001 09:56	
1,2-Dichloropropane	ND	0.5	ug/L	12/20/2001 09:56	
Bromodichloromethane	ND	0.5	ug/L	12/20/2001 09:56	
2-Chloroethylvinyl ether	ND	0.5	ug/L	12/20/2001 09:56	
trans-1,3-Dichloropropene	ND	0.5	ug/L	12/20/2001 09:56	
cis-1,3-Dichloropropene	ND	0.5	ug/L	12/20/2001 09:56	
1,1,2-Trichloroethane	ND	0.5	ug/L	12/20/2001 09:56	
Tetrachloroethene	ND	0.5	ug/L	12/20/2001 09:56	
Dibromochloromethane	ND	0.5	ug/L	12/20/2001 09:56	
Chlorobenzene	ND	0.5	ug/L	12/20/2001 09:56	
Bromoform	ND	2.0	ug/L	12/20/2001 09:56	
1,1,2,2-Tetrachloroethane	ND	0.5	ug/L	12/20/2001 09:56	
1,3-Dichlorobenzene	ND	0.5	ug/L	12/20/2001 09:56	
1,4-Dichlorobenzene	ND	0.5	ug/L	12/20/2001 09:56	
1,2-Dichlorobenzene	ND	0.5	ug/L	12/20/2001 09:56	
Trichlorotrifluoroethane	ND	2.0	ug/L	12/20/2001 09:56	
Chloromethane	ND	1.0	ug/L	12/20/2001 09:56	
Bromomethane	ND	1.0	ug/L	12/20/2001 09:56	
Surrogate(s)					
1-Chloro-2-fluorobenzene	100.0	70-130	%	12/20/2001 09:56	

Halogenated Volatile Organic Compounds by 8021

Batch QC report

Test Method: 8021B

Prep Method: 5030B

 STL San Francisco
 1220 Quarry Lane
 Pleasanton, CA 94566

Method Blank

Water

QC Batch # 2001/12/21-01.26

MB: 2001/12/21-01.26-004

Date Extracted: 12/21/2001 09:23

 Tel 925 484 1919
 Fax 925 484 1096
 www.stl-inc.com
 www.chromalab.com

CA DHS ELAP#1094

Compound	Result	Rep.Limit	Unit	Analyzed	Flag
Dichlorodifluoromethane	ND	1.0	ug/L	12/21/2001 09:23	
Vinyl chloride	ND	0.5	ug/L	12/21/2001 09:23	
Chloroethane	ND	0.5	ug/L	12/21/2001 09:23	
Trichlorofluoromethane	ND	0.5	ug/L	12/21/2001 09:23	
1,1-Dichloroethene	ND	0.5	ug/L	12/21/2001 09:23	
Methylene chloride	ND	5.0	ug/L	12/21/2001 09:23	
trans-1,2-Dichloroethene	ND	0.5	ug/L	12/21/2001 09:23	
cis-1,2-Dichloroethene	ND	0.5	ug/L	12/21/2001 09:23	
1,1-Dichloroethane	ND	0.5	ug/L	12/21/2001 09:23	
Chloroform	ND	0.5	ug/L	12/21/2001 09:23	
1,1,1-Trichloroethane	ND	0.5	ug/L	12/21/2001 09:23	
Carbon tetrachloride	ND	0.5	ug/L	12/21/2001 09:23	
1,2-Dichloroethane	ND	0.5	ug/L	12/21/2001 09:23	
Trichloroethene	ND	0.5	ug/L	12/21/2001 09:23	
1,2-Dichloropropane	ND	0.5	ug/L	12/21/2001 09:23	
Bromodichloromethane	ND	0.5	ug/L	12/21/2001 09:23	
2-Chloroethylvinyl ether	ND	0.5	ug/L	12/21/2001 09:23	
trans-1,3-Dichloropropene	ND	0.5	ug/L	12/21/2001 09:23	
cis-1,3-Dichloropropene	ND	0.5	ug/L	12/21/2001 09:23	
1,1,2-Trichloroethane	ND	0.5	ug/L	12/21/2001 09:23	
Tetrachloroethene	ND	0.5	ug/L	12/21/2001 09:23	
Dibromochloromethane	ND	0.5	ug/L	12/21/2001 09:23	
Chlorobenzene	ND	0.5	ug/L	12/21/2001 09:23	
Bromoform	ND	2.0	ug/L	12/21/2001 09:23	
1,1,2,2-Tetrachloroethane	ND	0.5	ug/L	12/21/2001 09:23	
1,3-Dichlorobenzene	ND	0.5	ug/L	12/21/2001 09:23	
1,4-Dichlorobenzene	ND	0.5	ug/L	12/21/2001 09:23	
1,2-Dichlorobenzene	ND	0.5	ug/L	12/21/2001 09:23	
Trichlorotrifluoroethane	ND	2.0	ug/L	12/21/2001 09:23	
Chloromethane	ND	1.0	ug/L	12/21/2001 09:23	
Bromomethane	ND	1.0	ug/L	12/21/2001 09:23	
Surrogate(s)					
1-Chloro-2-fluorobenzene	95.2	70-130	%	12/21/2001 09:23	

Halogenated Volatile Organic Compounds by 8021

Batch QC report

Test Method: 8021B

Prep Method: 5030B

 STL San Francisco
 1220 Quarry Lane
 Pleasanton, CA 94566

Method Blank

Water

QC Batch # 2001/12/21-01.25

MB: 2001/12/21-01.25-004

Date Extracted: 12/21/2001 10:17

 Tel 925 484 1919
 Fax 925 484 1096
 www.stl-inc.com
 www.chromalab.com

CA DHS ELAP#1094

Compound	Result	Rep.Limit	Unit	Analyzed	Flag
Dichlorodifluoromethane	ND	1.0	ug/L	12/21/2001 10:17	
Vinyl chloride	ND	0.5	ug/L	12/21/2001 10:17	
Chloroethane	ND	0.5	ug/L	12/21/2001 10:17	
Trichlorofluoromethane	ND	0.5	ug/L	12/21/2001 10:17	
1,1-Dichloroethene	ND	0.5	ug/L	12/21/2001 10:17	
Methylene chloride	ND	5.0	ug/L	12/21/2001 10:17	
trans-1,2-Dichloroethene	ND	0.5	ug/L	12/21/2001 10:17	
cis-1,2-Dichloroethene	ND	0.5	ug/L	12/21/2001 10:17	
1,1-Dichloroethane	ND	0.5	ug/L	12/21/2001 10:17	
Chloroform	ND	0.5	ug/L	12/21/2001 10:17	
1,1,1-Trichloroethane	ND	0.5	ug/L	12/21/2001 10:17	
Carbon tetrachloride	ND	0.5	ug/L	12/21/2001 10:17	
1,2-Dichloroethane	ND	0.5	ug/L	12/21/2001 10:17	
Trichloroethene	ND	0.5	ug/L	12/21/2001 10:17	
1,2-Dichloropropane	ND	0.5	ug/L	12/21/2001 10:17	
Bromodichloromethane	ND	0.5	ug/L	12/21/2001 10:17	
2-Chloroethylvinyl ether	ND	0.5	ug/L	12/21/2001 10:17	
trans-1,3-Dichloropropene	ND	0.5	ug/L	12/21/2001 10:17	
cis-1,3-Dichloropropene	ND	0.5	ug/L	12/21/2001 10:17	
1,1,2-Trichloroethane	ND	0.5	ug/L	12/21/2001 10:17	
Tetrachloroethene	ND	0.5	ug/L	12/21/2001 10:17	
Dibromochloromethane	ND	0.5	ug/L	12/21/2001 10:17	
Chlorobenzene	ND	0.5	ug/L	12/21/2001 10:17	
Bromoform	ND	2.0	ug/L	12/21/2001 10:17	
1,1,2,2-Tetrachloroethane	ND	0.5	ug/L	12/21/2001 10:17	
1,3-Dichlorobenzene	ND	0.5	ug/L	12/21/2001 10:17	
1,4-Dichlorobenzene	ND	0.5	ug/L	12/21/2001 10:17	
1,2-Dichlorobenzene	ND	0.5	ug/L	12/21/2001 10:17	
Trichlorotrifluoroethane	ND	2.0	ug/L	12/21/2001 10:17	
Chloromethane	ND	1.0	ug/L	12/21/2001 10:17	
Bromomethane	ND	1.0	ug/L	12/21/2001 10:17	
Surrogate(s)					
1-Chloro-2-fluorobenzene	86.5	70-130	%	12/21/2001 10:17	

Halogenated Volatile Organic Compounds by 8021

Batch QC report

Test Method: 8021B

Prep Method: 5030B

STL San Francisco
1220 Quarry Lane
Pleasanton, CA 94566Tel 925 484 1919
Fax 925 484 1096
www.stl-inc.com
www.chromalab.com

Method Blank

Water

QC Batch # 2001/12/26-01.25

MB: 2001/12/26-01.25-004

Date Extracted: 12/26/2001 13:02

CA DHS ELAP#1094

Compound	Result	Rep.Limit	Unit	Analyzed	Flag
Dichlorodifluoromethane	ND	1.0	ug/L	12/26/2001 13:02	
Vinyl chloride	ND	0.5	ug/L	12/26/2001 13:02	
Chloroethane	ND	0.5	ug/L	12/26/2001 13:02	
Trichlorofluoromethane	ND	0.5	ug/L	12/26/2001 13:02	
1,1-Dichloroethene	ND	0.5	ug/L	12/26/2001 13:02	
Methylene chloride	ND	5.0	ug/L	12/26/2001 13:02	
trans-1,2-Dichloroethene	ND	0.5	ug/L	12/26/2001 13:02	
cis-1,2-Dichloroethene	ND	0.5	ug/L	12/26/2001 13:02	
1,1-Dichloroethane	ND	0.5	ug/L	12/26/2001 13:02	
Chloroform	ND	0.5	ug/L	12/26/2001 13:02	
1,1,1-Trichloroethane	ND	0.5	ug/L	12/26/2001 13:02	
Carbon tetrachloride	ND	0.5	ug/L	12/26/2001 13:02	
1,2-Dichloroethane	ND	0.5	ug/L	12/26/2001 13:02	
Trichloroethene	ND	0.5	ug/L	12/26/2001 13:02	
1,2-Dichloropropane	ND	0.5	ug/L	12/26/2001 13:02	
Bromodichloromethane	ND	0.5	ug/L	12/26/2001 13:02	
2-Chloroethylvinyl ether	ND	0.5	ug/L	12/26/2001 13:02	
trans-1,3-Dichloropropene	ND	0.5	ug/L	12/26/2001 13:02	
cis-1,3-Dichloropropene	ND	0.5	ug/L	12/26/2001 13:02	
1,1,2-Trichloroethane	ND	0.5	ug/L	12/26/2001 13:02	
Tetrachloroethene	ND	0.5	ug/L	12/26/2001 13:02	
Dibromochloromethane	ND	0.5	ug/L	12/26/2001 13:02	
Chlorobenzene	ND	0.5	ug/L	12/26/2001 13:02	
Bromoform	ND	2.0	ug/L	12/26/2001 13:02	
1,1,2,2-Tetrachloroethane	ND	0.5	ug/L	12/26/2001 13:02	
1,3-Dichlorobenzene	ND	0.5	ug/L	12/26/2001 13:02	
1,4-Dichlorobenzene	ND	0.5	ug/L	12/26/2001 13:02	
1,2-Dichlorobenzene	ND	0.5	ug/L	12/26/2001 13:02	
Trichlorotrifluoroethane	ND	2.0	ug/L	12/26/2001 13:02	
Chloromethane	ND	1.0	ug/L	12/26/2001 13:02	
Bromomethane	ND	1.0	ug/L	12/26/2001 13:02	
Surrogate(s)					
1-Chloro-2-fluorobenzene	92.4	70-130	%	12/26/2001 13:02	

Halogenated Volatile Organic Compounds by 8021

Batch QC report

Test Method: 8021B

Prep Method: 5030B

STL San Francisco
1220 Quarry Lane
Pleasanton, CA 94566

Laboratory Control Spike (LCS/LCSD) Water QC Batch # 2001/12/20-01.26
 LCS: 2001/12/20-01.26-002 Extracted: 12/20/2001 08:32 Analyzed: 12/20/2001 08:32
 LCSD: 2001/12/20-01.26-003 Extracted: 12/20/2001 09:14 Analyzed: 12/20/2001 09:14

Tel 925 484 1919
Fax 925 484 1096
www.stl-inc.com
www.chromalab.com

CA DHS ELAP#1094

Compound	Conc. [ug/L]		Exp.Conc. [ug/L]		Recovery		RPD	Ctrl.Limits [%]		Flags	
	LCS	LCSD	LCS	LCSD	LCS	LCSD	[%]	Recover	RPD	LCS	LCSD
1,1-Dichloroethene	22.9	22.2	20.0	20.0	114.5	111.0	3.1	70-130	20		
Trichloroethene	21.4	20.9	20.0	20.0	107.0	104.5	2.4	70-130	20		
Chlorobenzene	19.8	19.4	20.0	20.0	99.0	97.0	2.0	70-130	20		
Surrogate(s)											
1-Chloro-2-fluorobenz	17.7	17.1	20	20	88.5	85.5		70-130			



Halogenated Volatile Organic Compounds by 8021

Batch QC report

Test Method: 8021B

Prep Method: 5030B

STL San Francisco
1220 Quarry Lane
Pleasanton, CA 94566

Laboratory Control Spike (LCS/LCSD) Water QC Batch # 2001/12/21-01.26
 LCS: 2001/12/21-01.26-002 Extracted: 12/21/2001 07:58 Analyzed: 12/21/2001 07:58
 LCSD: 2001/12/21-01.26-003 Extracted: 12/21/2001 08:40 Analyzed: 12/21/2001 08:40

Tel 925 484 1919
Fax 925 484 1096
www.stl-inc.com
www.chromalab.com

CA DHS ELAP#1094

Compound	Conc. [ug/L]		Exp.Conc. [ug/L]		Recovery		RPD	Ctrl.Limits [%]		Flags	
	LCS	LCSD	LCS	LCSD	LCS	LCSD	[%]	Recover	RPD	LCS	LCSD
1,1-Dichloroethene	22.5	21.9	20.0	20.0	112.5	109.5	2.7	70-130	20		
Trichloroethene	20.5	20.5	20.0	20.0	102.5	102.5	0.0	70-130	20		
Chlorobenzene	20.2	20.0	20.0	20.0	101.0	100.0	1.0	70-130	20		
Surrogate(s)											
1-Chloro-2-fluorobenz	17.4	17.2	20	20	87.0	86.0		70-130			

Halogenated Volatile Organic Compounds by 8021

Batch QC report

Test Method: 8021B

Prep Method: 5030B

STL San Francisco
1220 Quarry Lane
Pleasanton, CA 94566

Laboratory Control Spike (LCS/LCSD) Water QC Batch # 2001/12/21-01.25
 LCS: 2001/12/21-01.25-002 Extracted: 12/21/2001 08:23 Analyzed: 12/21/2001 08:23
 LCSD: 2001/12/21-01.25-003 Extracted: 12/21/2001 09:20 Analyzed: 12/21/2001 09:20

Tel 925 484 1919
Fax 925 484 1096
www.stl-inc.com
www.chromalab.com

CA DHS ELAP#1094

Compound	Conc. [ug/L]		Exp.Conc. [ug/L]		Recovery		RPD	Ctrl.Limits [%]		Flags	
	LCS	LCSD	LCS	LCSD	LCS	LCSD	[%]	Recover	RPD	LCS	LCSD
1,1-Dichloroethene	21.2	20.0	20.0	20.0	106.0	100.0	5.8	70-130	20		
Trichloroethene	21.0	20.6	20.0	20.0	105.0	103.0	1.9	70-130	20		
Chlorobenzene	20.3	22.1	20.0	20.0	101.5	110.5	8.5	70-130	20		
Surrogate(s)											
1-Chloro-2-fluorobenz	16.5	19.9	20	20	82.5	99.5		70-130			

Halogenated Volatile Organic Compounds by 8021

Batch QC report

Test Method: 8021B

Prep Method: 5030B

STL San Francisco
1220 Quarry Lane
Pleasanton, CA 94566

Tel 925 484 1919
Fax 925 484 1096
www.stl-inc.com
www.chromalab.com

CA DHS ELAP#1094

Laboratory Control Spike (LCS/LCSD) Water QC Batch # 2001/12/26-01.25
 LCS: 2001/12/26-01.25-002 Extracted: 12/26/2001 11:35 Analyzed: 12/26/2001 11:35
 LCSD: 2001/12/26-01.25-003 Extracted: 12/26/2001 12:18 Analyzed: 12/26/2001 12:18

Compound	Conc. [ug/L]		Exp.Conc. [ug/L]		Recovery		RPD	Ctrl.Limits [%]		Flags	
	LCS	LCSD	LCS	LCSD	LCS	LCSD	[%]	Recover	RPD	LCS	LCSD
1,1-Dichloroethene	20.5	19.8	20.0	20.0	102.5	99.0	3.5	70-130	20		
Trichloroethene	21.0	20.8	20.0	20.0	105.0	104.0	1.0	70-130	20		
Chlorobenzene	21.4	21.4	20.0	20.0	107.0	107.0	0.0	70-130	20		
Surrogate(s)											
1-Chloro-2-fluorobenz	18.3	18.2	20	20	91.5	91.0		70-130			

Submission #: 2001-12-0305



Halogenated Volatile Organic Compounds by 8021

Legend & Notes

Test Method: 8021B

Prep Method: 5030B

STL San Francisco
1220 Quarry Lane
Pleasanton, CA 94566

Tel 925 484 1919
Fax 925 484 1096
www.stl-inc.com
www.chromalab.com

Analysis Flags

o

Reporting limits were raised due to high level of analyte present in the sample.

CA DHS ELAP#1094

APPENDIX D

SLUG TEST ANALYSIS PROCEDURES

Spreadsheet Evaluation of Slug Tests

Karl DeBisschop

Contents

Description
Theory of Slug Testing
Required Data
Additional Data
Performing the Analysis
Spreadsheet Validation
Conducting Slug Tests
References
Notes
Attachment - Equipment and Data Collection

Description

This paper describes an Excel spreadsheet for estimating the hydraulic conductivity of saturated geologic materials. Results are generated simultaneously using the methods of *Bouwer and Rice (1976, 1989, 1989a)* and of *Hvorslev (1951)*. The spreadsheet-based platform allows open access to calculation formulae, allowing modification and improvement by users.

It is assumed that users are familiar with the theory and practice of slug testing. Once familiar with the operation of the worksheet, users typically perform a complete analysis of ASCII formatted time-level data in 15 to 30 minutes. If data are not of sufficient quality to quickly identify a linear range for analysis, additional evaluation will be required. Workers and managers who encounter such data should evaluate the applicability of the theory supporting this type of analysis and make case-by-case decisions regarding the validity of the results.

Features

Primary features of the worksheet include:

- *Double Straight-Line Effect.* In "water table" or "drained" wells, where the length of the open interval equals or exceeds the length of the well, sand pack drainage is automatically calculated and compensated for by the worksheet.
- *Estimation of Effective Radius.* Bouwer and Rice parameters A, B, and C are automatically estimated for each test, based on a fifth-order polynomial regression to the curves presented in the original paper.
- *Response Curve Selection.* The straight-line portion of the response is selected by the user on the basis of a graphic display of the test data. This increases quality by ensuring that the data used for computation of the hydraulic conductivity do fit a straight line in the test data, a prerequisite for accurate analysis. Final output includes a graph of the predicted drawdown line and the observed data, encouraging visual evaluation of the quality of the data and the solution.
- *Macro Support.* Data import and regression of the fit line can be performed by macro, in addition to the manual procedure that is integral to the spreadsheet format.

Distribution

This template may be distributed and used and reproduced freely in accordance with the general public license of the Free Software Foundation (this, however, does not imply that this code was developed or reviewed by the FSF).

In transferring the software, users should ensure that all supporting documentation and code is included, and all internal validation data sets and routines remain intact. This documentation file is 'slug096b.htm' and the spreadsheet files is slug096b.xls (the numeric part of the file name reflects the current version number, and will increase with each upgrade).

Version 0.95 has been used in practice with Excel 5, but is considered late-BETA because it has not undergone a period of open testing. Version 0.96 changes are to convert to Excel 97 (and 2000 when I get a license). Primary goals for Version 1.0 will be to document independent testing, and to incorporate checksum/PGP based verification into the distribution.

Users who update or improve the application are encouraged to submit their modifications for possible inclusion in future versions. All users are encouraged to provide comments and suggestions regarding future improvements to the primary author, [Karl DeBisschop](mailto:kdebisschop@users.sourceforge.net) (kdebisschop@users.sourceforge.net).

Theory of Slug Testing

A slug test involves inducing a rapid change in water level in a test well (see note: slug). By measuring and recording the rate of return to static conditions (recovery), one is able to estimate the local horizontal hydraulic conductivity of the material surrounding the well. Slug test data are generally analyzed using relatively standard analytical solutions to the equations which govern groundwater flow. Homogeneity and constant aquifer thickness are common assumptions for conditions within the area of influence of the test. In practice, these are usually met because the radius of influence of most slug tests is fairly small.

Two classes of solutions are generally used in evaluating slug test data. The class of solutions which includes the Bouwer and Rice, and Hvorslev Methods relies on the assumption that water and soil are incompressible - that is, aquifer storativity is zero. This assumption allows use of a modified Thiem equation to predict well response. The potential which drives flow into or out of the well is expressed as a difference between head in the well and at a so-called "radius of influence." Using the somewhat artificial concept of radius of influence eliminates the need to consider aquifer storage in this treatment. (see note: Thiem)

Alternate methods of analysis, including the Cooper-Bredehoeft-Papadopoulos method, assume a non-zero storativity which must be calculated to obtain the correct solution. These methods yield solutions analogous to the Theis equation for radial flow to a well. Bedrock aquifers generally meet, in a rough sense, the assumptions of the analysis and may potentially be analyzed with this spreadsheet, though extreme caution should be taken in interpreting the results. For many applications, however, the zone of interest may be a single fracture or discrete fracture zone (e.g. multilevel monitoring wells and packer testing). It may therefore be misleading to present results as hydraulic conductivity without knowing the thickness of the fracture or fracture zone. In such cases, techniques such as CBP may be more appropriate.

Another point of concern lies in the fact that the upper boundary condition for the Thiem analysis is a no-flow boundary, whereas the saturated overburden is more likely to act as a constant head condition. Considering the anisotropy of the roughly horizontal fractures which a vertical well is likely to intersect, direct leakage from overburden will frequently serve simply as the means by which the condition of constant water level at infinite distance is maintained. The satisfaction of this condition, however, cannot generally be confirmed on the basis of the slug test data.

Basic Development

Figure 1 shows a schematic of a typical well installation.

Figure 1. Typical Test Well

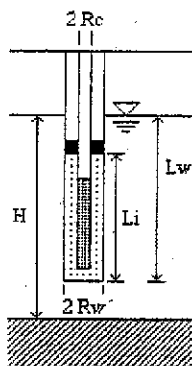

To solve for drawdown in a well following the slug test, consider the Thiem equation:

$$Q = 2 \pi K y / \ln(R_E/R_W) \quad (\text{eq. 1})$$

where

- K is the hydraulic conductivity of the aquifer;
- y is the vertical distance between the water level in the well and the equilibrium water table in the aquifer;
- L_I is the well intake length;
- R_E is the effective radius over which drawdown y is dissipated; and
- R_W is the horizontal distance from the well center to the original aquifer material; and

The rate of water level change in the well is related to the rate of water level recovery by conservation of mass

$$dy/dt = -Q / \pi R_C^2 \quad (\text{eq. 2})$$

where R_C is the radius of the well casing. Combining these equations and integrating between the limits y_0 at time = 0 and y_t at time = t, yields

$$K = (R_C^2 \ln(y_0/y_t)) / Ft \quad (\text{eq. 3})$$

where F is a shape factor which includes terms dependent on the well geometry.

Shape Factors

Although presented in different forms, the time lag procedure described in Hvorslev's original paper is equivalent to the slope of line procedure described by Bouwer and Rice. Therefore, the determination of shape factors is the only substantive difference between Hvorslev's method and the method of Bouwer and Rice.

Hvorslev

A series of analytical solutions is presented in *Hvorslev (1951)*. A critical review of shape factors and their validity is presented in *Chapuis (1989)*. Chapuis particularly identifies discrepancies in practice that affect wells with L_I/R_W less than 16 (for typical environmental wells drilled with an 8-inch auger, this means sand pack lengths less than 5 feet). It is also useful to note that many authors use approximations to the exact analytical shape factors, which are only valid for large length and/or anisotropy. The worksheet currently uses 5 shape factors based on the geometry of the well:

$$\begin{aligned} &4 R \text{ for } L_I=0, L_W=0 \text{ (a)} \\ &5.5 R \text{ for } L_I=0, L_W>0 \text{ (b)} \\ &2 \pi K L_I / \sqrt{L_I / [(2R_W) + 0.25]} \text{ for } L_I < 16R_W \text{ (c)} \\ &2 \pi K L_I / \ln[mL_I/R_W + \sqrt{1 + [mL_I/R_W]^2}] \text{ for } L_I = L_W \text{ (d)} \\ &2 \pi K L_I / \ln[mL_I/2R_W + \sqrt{1 + [mL_I/2R_W]^2}] \text{ for } L_I < L_W \text{ (e)} \end{aligned} \quad (\text{eq. 4})$$

where the transform factor, m, reflects aquifer anisotropy, and is the square-root of the quotient of horizontal and vertical hydraulic conductivity $[(K_h/K_v)^{1/2}]$. These formulae are exact representations of the analytical solution, and do not use the approximation for large L_I noted above.

Chapuis (1989) also suggests that many cases the contribution of well bottom flow (5.5 R) should be subtracted from the 4c, 4d, and 4e above. In practice, environmental monitoring wells often have a highly permeable sand pack which defines the boundary of the well (rather than the actual slotted casing). In such cases, flow does occur through the bottom of the well bore, and this correction is not recommended. For wells in which the gravel pack is not significantly more

permeable than the formation, this correction can be applied, but it must be asked in such cases if slug test data are measuring the aquifer response, or the response of the sand pack. For typical environmental applications, the value of this correction term is less than 5 percent. There is a logical parameter in the function definition for determination of the Hvorslev shape factor which, when changed to a non-zero value, causes this correction to be included.

Cedergren (1989) provides additional shape factors for short wells screened at the top of an aquifer and for fully-penetrating wells, but these are not typically used because 1) the appropriate range of applicability is poorly defined, 2) the transition between domains is not smooth, and 3) there is no provision for anisotropy. If well geometries enter this range, a reference to Cedergren's text is provided, and the shape factor formula can be modified on a case-by-case basis if the user wishes to incorporate these cases. Typical corrections due to this factor seem to be on the order of 20 percent. A parameter is provided in the Hvorslev shape factor definition to control inclusion of this factor.

Bouwer and Rice

Bouwer and Rice (1976) proposed a shape factor of the form

$$F = 2 p L_I / \ln(R_E / R_W) \tag{eq. 5}$$

Values for $\ln(R_E / R_W)$ were determined by electrical resistance network for various combinations of well length (L_W), well radius (R_W), aquifer thickness (H), and intake length (L_I). Results of the network simulation are given as curves of three parameters A, B, and C. As part of the development of this spreadsheet, an analytic expression for the values of these parameters was formulated by regression analysis. The resulting expressions are:

Function A(x) (eq. 6a)

If $x < 2.554422663$ Then

$$A = 1.638445671 + 0.166908063 * x + 0.000740459 * \text{Exp}(6.17105281 * x - 1.054747686 * x * x)$$

Else

$$A = 11.00393028 - 170.7752217 * \text{Exp}(-1.509639982 * x)$$

End If

Function B(x) (eq. 6b)

If $x < 2.596774459$ Then

$$B = 0.174811819 + 0.060059188 * x + 0.007965502 * \text{Exp}(2.053376868 * x - 0.007790328 * x * x)$$

Else

$$B = 4.133124586 - 93.06136936 * \text{Exp}(-1.435370997 * x)$$

End If

Function C(x) (eq. 6c)

If $x < 2.200426117$ Then

$$C = 0.074711376 + 1.083958569 * x + 0.00557352 * \text{Exp}(2.929493814 * x - 0.001028433 * x * x)$$

Else

$$C = 15.66887372 - 178.4329289 * \text{Exp}(-1.322779744 * x)$$

End If

where x is $\log(L_I / R_W)$. Figure 2 shows a comparison of the values predicted by these equations with the published curves. The RMS error for these curve fits are 0.017 for A (64 data points), 0.0059 for B (88 data points), and 0.048 for C (88 data points). The greatest error is 3 percent, which occurs for small values of B. All other errors are 1 percent or less.

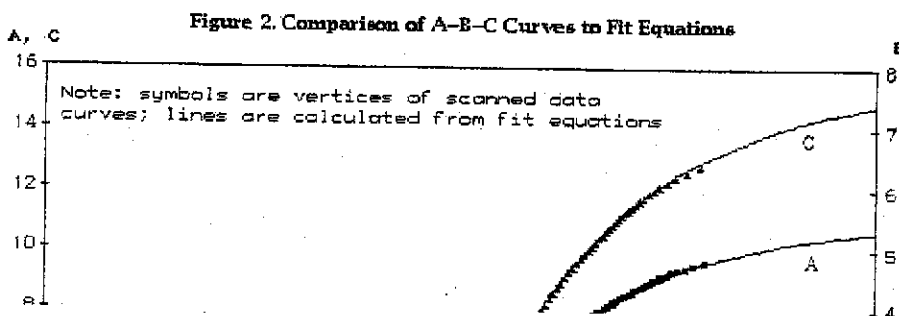

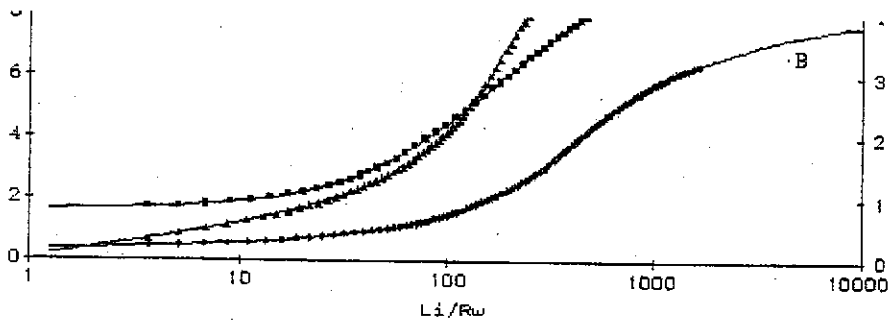

Double Straight-Line Effect

Bower (1989) discusses a phenomena he terms the "double straight-line effect" which can occur in wells with a sand pack intersecting the water table. In such situations, the drainage out of or into the sand pack contributes to the volumetric flow term of the governing equations for the slug test. An initial drainage curve is observed, followed by the aquifer response curve on which the analysis should be conducted. An intriguing suggestion in a letter following the 1989 update involves using the known volume of the slug to aid in estimating the porosity or radius of the sand pack for this calculation. In the response, details of this methodology are left for the reader. Two separate treatments of this issue are used for this spreadsheet implementation, either of which can be used based on the judgement of the user. These are discussed under the Casing Radius topic of the Required Data section of this paper.

Confined Aquifers

Another comment in the update indicates that the Bouwer and Rice method is applicable to confined aquifers. There are no intrinsic difficulties in the use of these methods in confined aquifers. Some care, however, is required to choose the correct values for the well geometry. The aquifer thickness is taken, as expected, to be the distance between the upper and lower boundaries of the physical aquifer of concern. The intake length, as described by *Bouwer and Rice (1976)* is the length of the well screen, or the length of the sand pack or developed zone if significantly more permeable than the aquifer itself. The length of the well is taken as the distance between the upper aquifer surface and the bottom of the well. Casual inspection of Figure 1 in *Bouwer and Rice (1976)* might suggest that the water table should be taken as the upper surface for these quantities, but it must be remembered that the original paper was written to address the unconfined case only.

Required Data

The worksheet has been implemented in Excel version 5. Earlier version were implemented in Lotus-123 version 2.3, but no further development is planned in Lotus. User data input fields are all located in column C of the upper 24 lines the spreadsheet, except the water level response data which is entered or imported starting at row 60.

Well Geometry

Well geometry data are recorded both at the time of installation and at the time of testing. The user will generally enter these data manually at the time of test analysis. Although dimensions are labeled in the spreadsheet for convenience, spreadsheet calculations are internally consistent and may be used with any consistent set of units after modifying data labels as required. The following subsections discuss each item in detail.

Aquifer Thickness

The aquifer thickness (H) is the total thickness of saturated aquifer material through which flow to the well may take place. In an unconfined aquifer the aquifer extends from the water table to the top of the underlying low-permeability layer. If the depth of the aquifer becomes large, the spreadsheet automatically sets the quantity $\ln[(H-L_w)/R_w]$ to a maximum value of 6 as indicated by *Bouwer and Rice (1976)*.

Well Length

The well length (L_W) is the actual length the well, measured from the top of the aquifer (confining layer or water table) to the bottom of the well, developed zone, or sand pack. In practice, the decision to include the sand pack is based on knowledge of the contrast in grain size between the aquifer and the sand pack material. If the sand pack or developed zone intersects the water table, the presence of the double straight-line effect would suggest that the sand pack or developed zone should be included in the calculations.

Intake Length

The intake length (L_I) is the actual length of water flow to the well, sand pack, or developed zone. L_I is taken from the top to the bottom of the intake for wells which are entirely below the water table. If the user specifies an intake length greater than the well length, it is assumed that part of the intake lies above the water table. The spreadsheet sets L_I to L_W and performs all further calculations allowing for sand pack or developed zone drainage.

Casing Radius

The casing radius (R_C) is always set equal to the radius of the open well bore through which the water column rises or falls. If the intake length is greater than or equal to the well length, it is assumed that the water column also moves through a sand pack or developed zone, and subsequent calculations are performed with a calculated equivalent radius (Requiv). The equivalent radius is calculated according to the formula (Bouwer 1989a):

$$\text{Requiv} = [(1-n)R_C^2 + n R_W^2]^{1/2} \quad (\text{eq. 7})$$

The calculation of equivalent radius probably is the most subtle aspect of the spreadsheet as implemented, and creates the greatest potential for user error or misinterpretation. Discussion of the implications of these substitutions and related derivations will recur throughout this documentation. If the double straight-line effect is not apparent in plots of the time-drawdown data, substitution of R_{equiv} for R_C can be defeated by setting L_I slightly less than L_W .

If a spreadsheet calculations are performed in the "drained" mode, hydraulic conductivity will be calculated by each of three different methods:

- The well radius, casing radius, and porosity supplied by the user are used to determine Requiv.
- The well radius is estimated from the difference between the drawdown at time to predicted from user-specified regression and the drawdown that would be observed if the area through which the water column moved was determined from the casing radius. The porosity specified by the user completes the equation.
- The porosity is estimated, as above, from the difference between the regression drawdown and the drawdown corresponding to the given casing area. The well radius specified by the user completes the equation.

In practice, result of the second and third substitutions will be very similar. Regardless of the substitution chosen, it is important to confirm that the porosity and well radius predicted by fluid balance constraints are realistic. The spreadsheet includes a warning to this effect if the predicted porosity is less than 10 percent or greater than 50 percent.

Well Radius

The well radius (R_W) is the radius of the sand pack or developed zone, if present. If no sand pack or developed zone is present, the well radius is the outside radius of the well screen.

In practice, the decision to include the sand pack is based on knowledge of the contrast between the grain size distributions of the aquifer and the sand pack material. If the sand pack or developed zone intersects the water table, the presence of the double straight-line effect would suggest that the sand pack or developed zone should be included in the calculations.

Additional Data

Additional data are described below.

Sand Pack Porosity

An estimate of the sand pack porosity (n) is provided by the user. This value is only significant if the well geometry is drained. In such cases, a second estimate of porosity is calculated by the spreadsheet from regressed drawdown data and well geometry.

Slug Volume

It is essential to know the volume of the slug used for the test in order to conduct quality assurance checks on slug test results. This information is also used to estimate Requiv for drained well geometries.

Static Water Level

Many electronic data loggers save the static water level as the first recorded value. The spreadsheet assumes this behavior and copies the value into this cell during data import via macro. The user should always verify that the static level is set correctly prior to performing regression on the straight-line portion of the response curve, and may substitute another value into this cell if required.

Offset Time

The offset time allows the user to correct for a time lag between initiation of data acquisition and the onset of the slug test. This value is only used for determination of Requiv, and therefore is only significant for drained well geometries, which use an estimated of sand pack porosity or well radius. Undrained well calculations are not affected, nor are calculations based on user defined porosity and well radius.

Water Level Recovery Data

Water level recovery data are generally recorded with an electronic data logging device (e.g. Thor, Hermit, Troll) and imported into the spreadsheet as an ASCII file. Macros used to automate importation of data assume that each data file consists of a series of data pairs separated by spaces or tabs. Each data pair consists of the time and the measured water level. By manually importing data, other formats may be accommodated.

Input of time-drawdown pairs generated automatically by the data-logger is discouraged. The procedure used by many system is prone to error if the transducer is disturbed, and quality assurance is reduced by uncritical acceptance of such data. Adopting a practice of importing water levels, rather than drawdown, encourages the user to be more careful in evaluating the data (see note: Using data loggers).

Performing the Analysis

The basic procedure for analysis of slug test data includes the following steps:

- Bringing the data into the spreadsheet.
- The natural logarithm of drawdown is plotted against the time since the start of the test. The analysis portion of the test should form a straight line portion of the response curve.
- The slope of the straight line data is determined by linear regression and applied to equation 3.
- The values for well geometry are substituted into equation 3 to obtain a value for the hydraulic conductivity K .

These will generally be accomplished through macros built into the spreadsheet, but may also be conducted by direct access to spreadsheet cells and functions.

Importing Data

To import data using the macro feature, chose "Import..." from the TOOLS menu.

Performing Regression

The regression is performed automatically based on the range values entered by the user (cells B32 and B33). By changing these values, the user selects the rows that will be regressed and achieves a good fit to the linear portion of the data. If the well and aquifer geometry data has been entered, the test result shown by the spreadsheet may be correct at this point. For responsible analysis, however, a few more items should be evaluated.

If this is a drained well geometry, are the predicted well radius and sand pack porosity reasonable? Do the data indicate a clear double straight-line effect? If either of these conditions are not met, consider forcing to analysis to the undrained calculation by increasing the well length to a value slightly greater than the intake length.

If this is an undrained well geometry, does your known slug volume compare well to the change in water level observed? If not, explain the discrepancy, take steps to ensure that future tests are more accurate and reproducible, and consider whether a drained geometry may apply.

Help

In addition to this document, general program help is available from the instructions worksheet of the application. Error messages and warnings are described on the sheet called errors.

Spreadsheet Validation

As distributed, the spreadsheet programs contain validation data from *Bouwer and Rice (1976)*, and from *Domenico and Schwartz (1996)* for Hvorslev's method. If during use of the spreadsheet, there is reason to believe that program internals have been modified and are no longer accurate, these validation tests can be invoked by running the validate macro. The correct results are also integral to the program and will be printed in the comments section for each test.

This integral documentation of the accuracy of the worksheet implementation is an essential feature of the worksheet, and should be made available to all parties reviewing slug test analyses conducted with this worksheet.

Conducting Slug Tests

Basic procedures for conducting slug tests have been described in many references. In general, the test is conducted by adding (or removing) a slug to raise (or lower) the water level from its original equilibrium level, and measuring the rate of water level recovery. Other means of displacing the water column, such as compressed air, are equally amenable to analysis by these methods. Due to the relatively long duration of the "slug", the method of directly adding water to the well is not used frequently in current practice.

Water level changes are usually measured with pressure transducers and recorded by an electronic data logger. This equipment has the primary advantage of allowing measurement as water level recovery in wells with very rapid response times. This section will describe a few tip and tricks that can help produce more useful and defensible test data. A more complete description of the procedure and equipment required is presented in Attachment A.

- Measure the water level in each well before disturbing the water column and make sure that the water level in the well returns to equilibrium level before conducting the test
- Use a slug of known volume to conduct the test
- Use a slug of small enough length to be removed in one continuous stroke - a three foot long slug is usually appropriate and a five foot slug is demonstrably too long for most people
- Experience indicates that the analyst should prefer data from a rising head test to data from a falling head test, particularly for wells with rapid response times where the time required for a slug to sink into the well may be comparable to the aquifer response time
- Use the most rapid initial measurement rate available - this information can be important in assessing data limitations and the presence of the double straight line effect

Attachment - Equipment and Data Collection

A-1 Equipment

- Slug (generally no longer than 3 feet; should produce between 0.5 and 1.5 feet of drawdown in well; volume of the slug should be known prior to testing)
- Water level sounding tape
- Field Book
- Transducer and Data logger
- Decontamination/health and safety equipment, as required

A-2 Data Collection Procedure

1. Open the well.
2. Measure and record static water level in well. Be sure to allow time for equilibration with atmospheric pressure for wells with unvented caps. If dedicated bailer or other sampling apparatus in place interferes with initial reading, minimize disturbance as much as possible, and allow time for re-equilibration. Wait and re-check measurement to confirm the well is at steady-state.
3. Remove any equipment which will interfere with placing the transducer or conducting the slug test.
4. Measure and record the total depth of the well to ensure that the screen has not been partly silted in.
5. Place transducer in well to appropriate depth (see depth limits for individual transducers, or manufacturers specifications). Do not place transducer so that its range will be exceeded, or so that the transducer interferes with movement of the slug.
6. Place slug in well, above the transducer. If desired, a falling head test can be run at this point. It is often found in highly permeable materials, however, that the time required for the slug to fall through the water column may be comparable to the recovery time, and this data will not be usable.
7. When the water level has returned to static height, initialize the data logger.
8. Remove the slug. Use auto-start feature if available, or start data logger by hand.
9. Test may be terminated after recovery is complete, or after 10 to 15 minutes for wells with slow recovery. If possible, screen data in the field to ensure data quality prior to demobilization.

A-3 Quality Assurance

The following measures will help ensure quality data and analytical procedures.

- Determine depth of each well before testing. Sediment infilling may affect well response.
- Determine static water level before placing any equipment in the well. Ensure that the water level has returned to static before conducting the test or taking data logger baseline samples.
- If practical, allow the well to return to static level prior to termination of data collection.
- Generally, do not analyze ambiguous data.
- If any wells must be discarded, (e.g. the response may have been too fast to record, etc.) be sure to note this in overall summary of hydraulic properties, and in determination of averages and other statistics.
- Always compare actual water displacement to the slug volume. Large discrepancies may be a cause for discarding a data set.
- Use slugs that can be removed in one continuous pull. Remove slug rapidly.
- If sand pack grain size is greater than that of the aquifer, use dimension of the sand pack to determine well geometry. For finer sand pack, consider using casing dimensions.
- Beware of computer generated drawdowns. The baseline for the data logger may not be correct. If the test is long enough, always check to confirm that drawdown converges to zero.
- If tests are analyzed by Thiem-based methods, use only the linear part of the response curve. If the log-response is not linear, the test cannot be analyzed with this method.
- Duplicate tests should be conducted at least every tenth well, and once per site. In addition, duplicates may be advisable for rapidly recovering wells due to the difficulties in accurate logging of rapid responses. At many sites, duplicate tests are conducted for each well, and only a subset of the tests will be analyzed.

- Do not force the data - if a clear straight-line does not exist, these methods of Bouwer & Rice/Hvorslev are probably inappropriate

References

- Bouwer, Herman. 1989. The Bouwer and Rice slug test-an update. *Ground Water*, vol. 27, no. 3, pp. 304-309.
- Bouwer, Herman. 1989a. Discussion of "The Bouwer and Rice slug test-an update." *Ground Water*, vol. 27, no. 5, p. 715.
- Bouwer, Herman and R. C. Rice. 1976. A slug test for determining hydraulic conductivity of unconfined aquifers with completely or partially penetrating wells. *Water Resources Research*, vol. 12, no. 3, pp. 423-428.
- Cedergren, H. R. 1967. *Seepage, Drainage, and Flow Nets*. John Wiley & Sons, New York.
- Chapuis, Robert A. 1989. Shape factors for permeability tests in boreholes and piezometers. *Ground Water*, vol. 27, no. 5.
- Hvorslev, M. Juul. 1951. Time lag and soil permeability in ground-water observations. U.S. Army Corps of Engineers, Waterways Experiment Station, Bulletin No. 36.

See also:

- Bredehoeft, John D., Hilton H. Cooper, Jr., and Istavros S. Papadopoulos. 1966. Inertial and storage effects in well-aquifer systems: an analog investigation. *Water Resources Research*, vol. 2, no. 4.
- Brown, David L., T. N. Narasimhan, and Z. Demir. 1995. An evaluation of the Bouwer and Rice method of slug test analysis. *Water Resources Research*, vol. 31, no. 5.
- Cooper, Hilton H. Jr., John D. Bredehoeft, and Istavros S. Papadopoulos. 1967. Response of a finite-diameter well to an instantaneous charge of water. *Water Resources Research*, vol. 3, no. 1.
- Kruseman, G.P. and N.A. de Ridder. 1990. *Analysis and Evaluation of Pumping Test Data*. International Institute for Land Development and Improvement.
- McLane, Gerald A., Deborah A. Harrity, and Kurt O. Thomsen. 1990?. Slug testing in highly permeable aquifer using a pneumatic method. *Superfund '90*, pp 300-303.
- Pandit, Nintin S., and Robert F. Miner. 1986. Interpretation of slug test data. *Ground Water*, vol. 24, no. 6.
- Papadopoulos, Stavros S., John D. Bredehoeft, and Hilton H. Cooper, Jr. 1973. On the analysis of 'slug test' data. *Water Resources Research*, vol. 9, no. 4.
- U.S. EPA. September 1986. *Test Methods for Evaluating Solid Waste (S-846), Method 9100*, pp 41-43.
- van der Kamp, Garth. 1976. Determining aquifer transmissivity by means of well response tests: the underdamped case. *Water Resources Research*, vol. 12, no. 1.
- Wylie, Allan and Thomas R. Wood. 1990. A program to calculate hydraulic conductivity using slug tests. *Ground Water*, vol. 28, no. 5.

Notes

Slug

Water level changes are induced by quickly adding or removing a volume of water or a solid mass to/from the well, or using compressed air to displace the water column. The means of water column displacement are generally not significant in analysis, as long as water level recovery can be accurately measured.

Thiem Equation

The Thiem equation is a steady state expression of radial flow to a well, and thus initially seems significantly different from the time varying solutions required for slug test analysis. Inasmuch as aquifer storage is not present in the Hvorslev, and Bouwer and Rice methods, the time independent equation of Thiem can be used for this case. At any given instant, flow into the well is given by the Thiem equation, where the appropriate radius of influence is determined by techniques associated with the methods of test analysis. By this means, a problem involving integration in time and two-dimensional radial space is reduce to integration in time alone, as the spatial aspect is inherent in the Thiem equation.

Using data loggers

To aid in data quality evaluation, note that typical data loggers report results with a precision of 0.005, and the graph of $\ln(\text{drawdown})$ will therefore have a lower limit of -5.3; if the response curve levels off at a significantly different value, data reduction errors may be present. In addition, a concave-down trend to late time data also may reflect miscalculated drawdown due to on incorrect assignment of initial water level.

Slug Test Analysis - Bouwer & Rice/Hvorslev's Methods

Client: Cargil Alameda
 Proj. Name: CRA102
 Test by: Martha Watson
 Test Date: 01/15/02

Version: 0.96b
 Revised: 1999-07-10
 Well ID: MW-1

Calculation Set Number		
CRA102.03		
Calc. by	Chkd. by	Apvd. by
MJW	MJW	
Date	Date	Date
2/8/02	2/24/02	

User Input Data

Aquifer Thickness	50.0
Well Length (L_w)	15.45
Intake Length (L_r)	12.00
Well Radius (R_w)	0.104
Casing Radius (R_c)	0.042
Xform ratio, $m [(K_p/K_v)^{0.5}]$	1
Sandpack Porosity	0.33
Slug Volume	0.045
Static Level	10.429
Offset time	0.000

R_{equiv}	-1.000	-1.000	-1.000
Estimated Porosity & R_w	-1.000	-1.000	-1.000
$\ln(R_E/R_w)$		3.296	-1.000
Shape Factor		15.884	-1.000
Drawdown:	<u>Max. Y_t</u>	<u>Regr. Y_o</u>	<u>Casing Y_o</u>
	8.07	8.57	8.20

(undrained)
 (unconfined)

Drained Options

	A	B	C	D
	Undrained	User n/R_w	Est. n	Est. R_w
Bouwer & Rice - consistent units	3.9E-05			
<cm/sec>	2.0E-05			
Hvorslev - consistent units	5.6E-05			
<cm/sec>	2.9E-05			
Potentially acceptable solutions:	A			
Conversion factor for user units:	<cm/sec>	0.508		

Intercept 2.148
 Slope -0.164
 No. of Observations 122
 Starting Row 49
 Ending Row 170

COMMENTS:

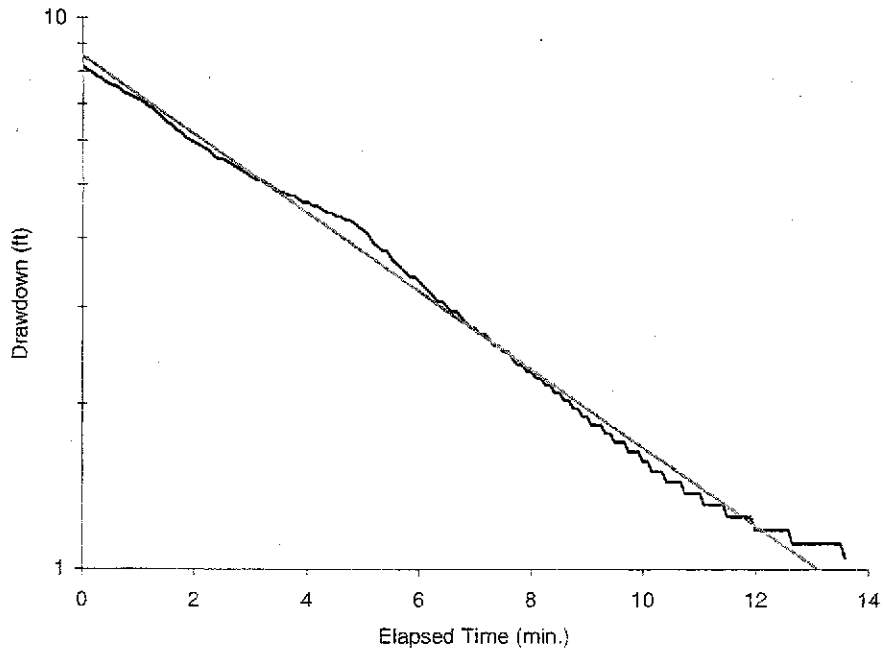

Time
<minutes>

level
<feet>

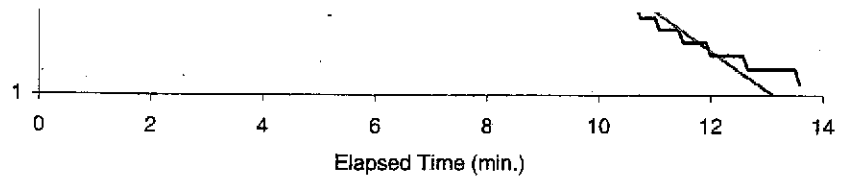

Time <minutes>	level <feet>					
0.000	2.231					
0.083	2.362					
0.167	2.427	8.002	2.080	2.080	8.335	<==
0.250	2.558	7.870	2.063	2.063	8.222	<==
0.333	2.623	7.806	2.055	2.055	8.111	<==
0.417	2.754	7.674	2.038	2.038	8.001	<==
0.500	2.821	7.607	2.029	2.029	7.893	<==
0.583	2.886	7.543	2.021	2.021	7.786	<==
0.667	2.950	7.478	2.012	2.012	7.681	<==
0.750	3.082	7.347	1.994	1.994	7.577	<==
0.833	3.149	7.280	1.985	1.985	7.474	<==
0.917	3.213	7.215	1.976	1.976	7.373	<==
1.000	3.280	7.148	1.967	1.967	7.273	<==
1.083	3.345	7.084	1.958	1.958	7.174	<==
1.167	3.476	6.952	1.939	1.939	7.077	<==
1.250	3.541	6.888	1.930	1.930	6.981	<==
1.333	3.672	6.756	1.910	1.910	6.887	<==
1.417	3.804	6.625	1.891	1.891	6.794	<==
1.500	3.935	6.493	1.871	1.871	6.702	<==
1.583	4.000	6.429	1.861	1.861	6.611	<==
1.667	4.131	6.297	1.840	1.840	6.521	<==
1.750	4.198	6.230	1.829	1.829	6.433	<==
1.833	4.327	6.101	1.808	1.808	6.346	<==
1.917	4.394	6.034	1.797	1.797	6.260	<==
2.000	4.459	5.970	1.787	1.787	6.175	<==
2.083	4.526	5.903	1.775	1.775	6.091	<==
2.167	4.590	5.838	1.764	1.764	6.009	<==
2.250	4.657	5.771	1.753	1.753	5.928	<==
2.333	4.786	5.642	1.730	1.730	5.847	<==
2.417	4.853	5.575	1.718	1.718	5.768	<==
2.500	4.853	5.575	1.718	1.718	5.690	<==
2.583	4.918	5.511	1.707	1.707	5.613	<==
2.667	4.985	5.444	1.694	1.694	5.537	<==
2.750	5.049	5.379	1.683	1.683	5.462	<==
2.833	5.116	5.312	1.670	1.670	5.388	<==
2.917	5.181	5.248	1.658	1.658	5.315	<==
3.000	5.248	5.181	1.645	1.645	5.243	<==
3.083	5.312	5.116	1.632	1.632	5.172	<==
3.167	5.312	5.116	1.632	1.632	5.102	<==
3.250	5.377	5.052	1.620	1.620	5.033	<==
3.333	5.444	4.985	1.606	1.606	4.965	<==
3.417	5.508	4.920	1.593	1.593	4.897	<==
3.500	5.575	4.853	1.580	1.580	4.831	<==
3.583	5.575	4.853	1.580	1.580	4.766	<==
3.667	5.640	4.789	1.566	1.566	4.701	<==
3.750	5.640	4.789	1.566	1.566	4.637	<==
3.833	5.707	4.722	1.552	1.552	4.575	<==
3.917	5.771	4.657	1.538	1.538	4.513	<==

Slug Test Analysis - Bouwer & Rice/Hvorslev's Methods

Client: Cargil Alameda
 Proj. Name: CRA102
 Test by: Martha Watson
 Test Date: 01/15/02

Version: 0.96b
 Revised: 1999-07-10
 Well ID: MW-1

Calculation Set Number		
CRA102.03		
Calc. by	Chkd. by	Apvd. by
MJW	MJW	
Date	Date	Date
2/8/02	2/24/02	

User Input Data

Aquifer Thickness	50.0
Well Length (L _w)	15.45
Intake Length (L _i)	12.00
Well Radius (R _w)	0.104
Casing Radius (R _c)	0.042
Xform ratio, m [(K _b /K _v) ^{0.5}]	1
Sandpack Porosity	0.33
Slug Volume	0.045
Static Level	10.429
Offset time	0.000

R _{equiv}	-1.000	-1.000	-1.000
Estimated Porosity & R _w		-1.000	-1.000
ln(R _E /R _w)		3.296	-1.000
Shape Factor		15.884	-1.000
Drawdown:	<u>Max. Y_t</u>	<u>Regr. Y_o</u>	<u>Casing Y_o</u>
	8.07	8.57	8.20

(undrained)

(unconfined)

Drained Options

	A	B	C	D
	Undrained	User n/R _w	Est. n	Est. R _w
Bouwer & Rice - consistent units	3.9E-05			
<cm/sec>	2.0E-05			
Hvorslev - consistent units	5.6E-05			
<cm/sec>	2.9E-05			
Potentially acceptable solutions:	A			
Conversion factor for user units:	<cm/sec>	0.508		

Intercept 2.148
 Slope -0.164
 No. of Observations 122
 Starting Row 49
 Ending Row 170

COMMENTS:

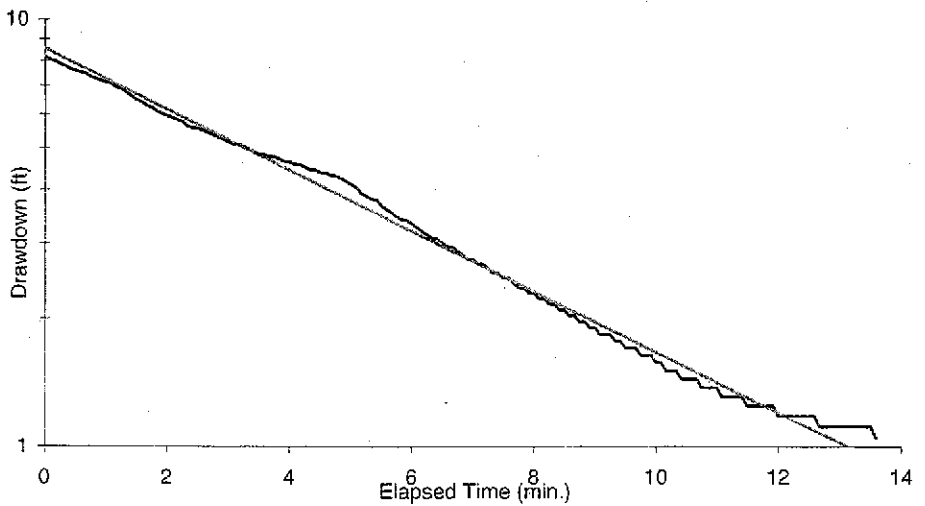

Time <minutes>	level <feet>	Drawdown Y(t)	ln(Y)	Est. Regression ln(Y) Range
0.000	2.231	8.198	2.104	2.104 8.566 <==
0.083	2.362	8.067	2.088	2.088 8.450 <==
0.167	2.427	8.002	2.080	2.080 8.335 <==
0.250	2.558	7.870	2.063	2.063 8.222 <==
0.333	2.623	7.806	2.055	2.055 8.111 <==
0.417	2.754	7.674	2.038	2.038 8.001 <==
0.500	2.821	7.607	2.029	2.029 7.893 <==
0.583	2.886	7.543	2.021	2.021 7.786 <==
0.667	2.950	7.478	2.012	2.012 7.681 <==
0.750	3.082	7.347	1.994	1.994 7.577 <==
0.833	3.149	7.280	1.985	1.985 7.474 <==
0.917	3.213	7.215	1.976	1.976 7.373 <==
1.000	3.280	7.148	1.967	1.967 7.273 <==
1.083	3.345	7.084	1.958	1.958 7.174 <==
1.167	3.476	6.952	1.939	1.939 7.077 <==
1.250	3.541	6.888	1.930	1.930 6.981 <==
1.333	3.672	6.756	1.910	1.910 6.887 <==
1.417	3.804	6.625	1.891	1.891 6.794 <==
1.500	3.935	6.493	1.871	1.871 6.702 <==
1.583	4.000	6.429	1.861	1.861 6.611 <==
1.667	4.131	6.297	1.840	1.840 6.521 <==
1.750	4.198	6.230	1.829	1.829 6.433 <==
1.833	4.327	6.101	1.808	1.808 6.346 <==
1.917	4.394	6.034	1.797	1.797 6.260 <==
2.000	4.459	5.970	1.787	1.787 6.175 <==
2.083	4.526	5.903	1.775	1.775 6.091 <==
2.167	4.590	5.838	1.764	1.764 6.009 <==
2.250	4.657	5.771	1.753	1.753 5.928 <==
2.333	4.786	5.642	1.730	1.730 5.847 <==
2.417	4.853	5.575	1.718	1.718 5.768 <==
2.500	4.853	5.575	1.718	1.718 5.690 <==
2.583	4.918	5.511	1.707	1.707 5.613 <==
2.667	4.985	5.444	1.694	1.694 5.537 <==
2.750	5.049	5.379	1.683	1.683 5.462 <==
2.833	5.116	5.312	1.670	1.670 5.388 <==
2.917	5.181	5.248	1.658	1.658 5.315 <==
3.000	5.248	5.181	1.645	1.645 5.243 <==
3.083	5.312	5.116	1.632	1.632 5.172 <==
3.167	5.312	5.116	1.632	1.632 5.102 <==
3.250	5.377	5.052	1.620	1.620 5.033 <==
3.333	5.444	4.985	1.606	1.606 4.965 <==
3.417	5.508	4.920	1.593	1.593 4.897 <==
3.500	5.575	4.853	1.580	1.580 4.831 <==
3.583	5.575	4.853	1.580	1.580 4.766 <==
3.667	5.640	4.789	1.566	1.566 4.701 <==
3.750	5.640	4.789	1.566	1.566 4.637 <==
3.833	5.707	4.722	1.552	1.552 4.575 <==
3.917	5.771	4.657	1.538	1.538 4.513 <==

Time <minutes>	level <feet>	Drawdown Y(t)	ln(Y)		Est. Regression ln(Y) Range
4.000	5.771	4.657	1.538	1.538	4.452 <=>
4.083	5.836	4.593	1.524	1.524	4.391 <=>
4.167	5.836	4.593	1.524	1.524	4.332 <=>
4.250	5.903	4.526	1.510	1.510	4.273 <=>
4.333	5.967	4.461	1.495	1.495	4.215 <=>
4.417	5.967	4.461	1.495	1.495	4.158 <=>
4.500	6.034	4.394	1.480	1.480	4.102 <=>
4.583	6.034	4.394	1.480	1.480	4.046 <=>
4.667	6.099	4.330	1.465	1.465	3.991 <=>
4.750	6.099	4.330	1.465	1.465	3.937 <=>
4.833	6.166	4.263	1.450	1.450	3.884 <=>
4.917	6.230	4.198	1.435	1.435	3.832 <=>
5.000	6.295	4.134	1.419	1.419	3.780 <=>
5.083	6.362	4.067	1.403	1.403	3.728 <=>
5.167	6.493	3.935	1.370	1.370	3.678 <=>
5.250	6.558	3.871	1.353	1.353	3.628 <=>
5.333	6.625	3.804	1.336	1.336	3.579 <=>
5.417	6.625	3.804	1.336	1.336	3.531 <=>
5.500	6.754	3.675	1.301	1.301	3.483 <=>
5.583	6.821	3.608	1.283	1.283	3.436 <=>
5.667	6.885	3.543	1.265	1.265	3.389 <=>
5.750	6.952	3.476	1.246	1.246	3.343 <=>
5.833	7.017	3.412	1.227	1.227	3.298 <=>
5.917	7.017	3.412	1.227	1.227	3.253 <=>
6.000	7.084	3.345	1.207	1.207	3.209 <=>
6.083	7.148	3.280	1.188	1.188	3.166 <=>
6.167	7.213	3.216	1.168	1.168	3.123 <=>
6.250	7.280	3.149	1.147	1.147	3.080 <=>
6.333	7.345	3.084	1.126	1.126	3.039 <=>
6.417	7.345	3.084	1.126	1.126	2.998 <=>
6.500	7.411	3.017	1.104	1.104	2.957 <=>
6.583	7.476	2.953	1.083	1.083	2.917 <=>
6.667	7.476	2.953	1.083	1.083	2.877 <=>
6.750	7.543	2.886	1.060	1.060	2.838 <=>
6.833	7.607	2.821	1.037	1.037	2.800 <=>
6.917	7.672	2.757	1.014	1.014	2.762 <=>
7.000	7.672	2.757	1.014	1.014	2.725 <=>
7.083	7.739	2.690	0.989	0.989	2.688 <=>
7.167	7.739	2.690	0.989	0.989	2.651 <=>
7.250	7.804	2.625	0.965	0.965	2.615 <=>
7.333	7.870	2.558	0.939	0.939	2.580 <=>
7.417	7.870	2.558	0.939	0.939	2.545 <=>
7.500	7.935	2.494	0.914	0.914	2.511 <=>
7.583	7.935	2.494	0.914	0.914	2.477 <=>
7.667	8.002	2.427	0.887	0.887	2.443 <=>
7.750	8.067	2.362	0.860	0.860	2.410 <=>
7.833	8.067	2.362	0.860	0.860	2.377 <=>
7.917	8.131	2.297	0.832	0.832	2.345 <=>

Time <minutes>	level <feet>	Drawdown Y(t)	ln(Y)	Est. Regression ln(Y) Range
8.000	8.131	2.297	0.832	0.832 2.313 <==
8.083	8.198	2.231	0.802	0.802 2.282 <==
8.167	8.198	2.231	0.802	0.802 2.251 <==
8.250	8.263	2.166	0.773	0.773 2.221 <==
8.333	8.263	2.166	0.773	0.773 2.191 <==
8.417	8.329	2.099	0.742	0.742 2.161 <==
8.500	8.329	2.099	0.742	0.742 2.132 <==
8.583	8.394	2.035	0.710	0.710 2.103 <==
8.667	8.394	2.035	0.710	0.710 2.074 <==
8.750	8.461	1.968	0.677	0.677 2.046 <==
8.833	8.461	1.968	0.677	0.677 2.019 <==
8.917	8.526	1.903	0.643	0.643 1.991 <==
9.000	8.526	1.903	0.643	0.643 1.964 <==
9.083	8.592	1.836	0.608	0.608 1.938 <==
9.167	8.592	1.836	0.608	0.608 1.911 <==
9.250	8.592	1.836	0.608	0.608 1.885 <==
9.333	8.657	1.772	0.572	0.572 1.860 <==
9.417	8.657	1.772	0.572	0.572 1.835 <==
9.500	8.722	1.707	0.535	0.535 1.810 <==
9.583	8.722	1.707	0.535	0.535 1.785 <==
9.667	8.722	1.707	0.535	0.535 1.761 <==
9.750	8.789	1.640	0.495	0.495 1.737 <==
9.833	8.789	1.640	0.495	0.495 1.714 <==
9.917	8.789	1.640	0.495	0.495 1.691 <==
10.000	8.853	1.575	0.455	0.455 1.668 <==
10.083	8.853	1.575	0.455	0.455 1.645 <==
10.167	8.920	1.509	0.411	1.623
10.250	8.920	1.509	0.411	1.601
10.333	8.920	1.509	0.411	1.579
10.417	8.985	1.444	0.367	1.558
10.500	8.985	1.444	0.367	1.537
10.583	8.985	1.444	0.367	1.516
10.667	8.985	1.444	0.367	1.495
10.750	9.051	1.377	0.320	1.475
10.833	9.051	1.377	0.320	1.455
10.917	9.051	1.377	0.320	1.435
11.000	9.051	1.377	0.320	1.416
11.083	9.116	1.313	0.272	1.397
11.167	9.116	1.313	0.272	1.378
11.250	9.116	1.313	0.272	1.359
11.333	9.116	1.313	0.272	1.341
11.417	9.116	1.313	0.272	1.323
11.500	9.181	1.248	0.221	1.305
11.583	9.181	1.248	0.221	1.287
11.667	9.181	1.248	0.221	1.270
11.750	9.181	1.248	0.221	1.252
11.833	9.181	1.248	0.221	1.236
11.917	9.181	1.248	0.221	1.219

Time <minutes>	level <feet>	Drawdown Y(t)	ln(Y)	Est. Regression ln(Y) Range
12.000	9.248	1.181	0.166	1.202
12.083	9.248	1.181	0.166	1.186
12.167	9.248	1.181	0.166	1.170
12.250	9.248	1.181	0.166	1.154
12.333	9.248	1.181	0.166	1.138
12.417	9.248	1.181	0.166	1.123
12.500	9.248	1.181	0.166	1.108
12.583	9.248	1.181	0.166	1.093
12.667	9.312	1.116	0.110	1.078
12.750	9.312	1.116	0.110	1.063
12.833	9.312	1.116	0.110	1.049
12.917	9.312	1.116	0.110	1.035
13.000	9.312	1.116	0.110	1.021
13.083	9.312	1.116	0.110	1.007
13.167	9.312	1.116	0.110	0.993
13.250	9.312	1.116	0.110	0.980
13.333	9.312	1.116	0.110	0.967
13.417	9.312	1.116	0.110	0.954
13.500	9.312	1.116	0.110	0.941
13.583	9.379	1.050	0.048	0.928

Slug Test Analysis - Bouwer & Rice/Hvorslev's Methods

Client: Cargil Alameda
 Proj. Name: CRA102
 Test by: Martha Watson
 Test Date: 01/15/02

Version: 0.96b
 Revised: 1999-07-10
 Well ID: MW-2

Calculation Set Number		
CRA102.03		
Calc. by	Chkd. by	Apvd. by
MJW	MJW	
Date	Date	Date
2/8/02	2/24/02	

User Input Data

Aquifer Thickness	50.0
Well Length (L_w)	22.25
Intake Length (L_I)	12.00
Well Radius (R_w)	0.104
Casing Radius (R_c)	0.042
Xform ratio, $m [(K_b/K_v)^{0.5}]$	1
Sandpack Porosity	0.33
Slug Volume	0.059
Static Level	11.607
Offset time	0.000

R_{equiv}	-1.000	-1.000	-1.000
Estimated Porosity & R_w	-1.000	-1.000	-1.000
$\ln(R_E/R_w)$		3.486	-1.000
Shape Factor		15.884	-1.000
Drawdown:	<u>Max. Y_i</u>	<u>Regr. Y_o</u>	<u>Casing Y_o</u>
	10.69	15.24	10.75

(undrained)

(unconfined)

Drained Options

	A	B	C	D
	Undrained	User n/R_w	Est. n	Est. R_w
Bouwer & Rice - consistent units	3.0E-05			
<cm/sec>	1.5E-05			
Hvorslev - consistent units	4.1E-05			
<cm/sec>	2.1E-05			
Potentially acceptable solutions:	A			
Conversion factor for user units:	<cm/sec>	0.508		

Intercept 2.724
 Slope -0.119
 No. of Observations 161
 Starting Row 75
 Ending Row 235
 222-276

COMMENTS:

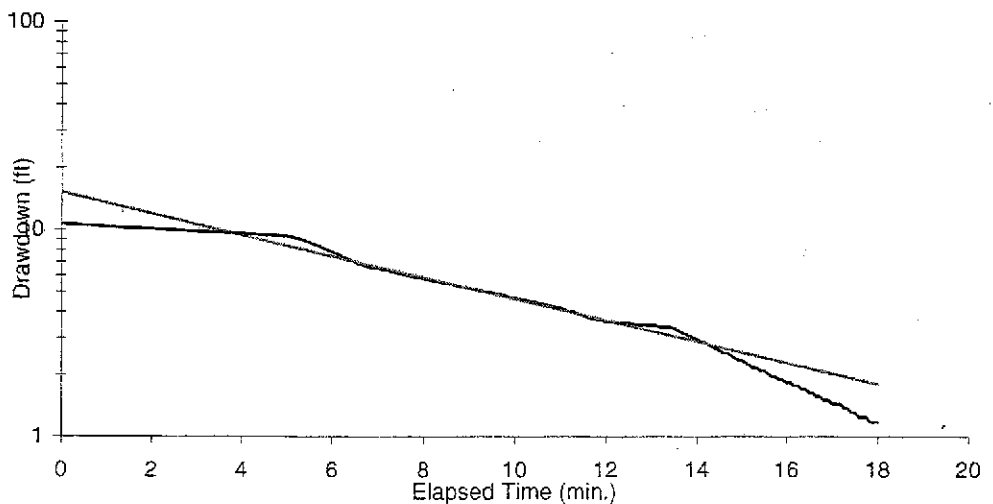

Time <minutes>	level <feet>	Drawdown Y(t)	ln(Y)		Est. Regression ln(Y) Range
0.000	0.853	10.754	2.375		15.244
0.083	0.918	10.689	2.369		15.094
0.167	0.983	10.625	2.363		14.946
0.250	0.983	10.625	2.363		14.799
0.333	0.983	10.625	2.363		14.653
0.417	1.050	10.558	2.357		14.509
0.500	1.050	10.558	2.357		14.366
0.583	1.114	10.493	2.351		14.225
0.667	1.114	10.493	2.351		14.085
0.750	1.114	10.493	2.351		13.946
0.833	1.181	10.426	2.344		13.809
0.917	1.181	10.426	2.344		13.673
1.000	1.246	10.362	2.338		13.538
1.083	1.246	10.362	2.338		13.405
1.167	1.246	10.362	2.338		13.273
1.250	1.313	10.295	2.332		13.143
1.333	1.313	10.295	2.332		13.013
1.417	1.377	10.230	2.325		12.885
1.500	1.377	10.230	2.325		12.759
1.583	1.377	10.230	2.325		12.633
1.667	1.377	10.230	2.325		12.509
1.750	1.377	10.230	2.325		12.386
1.833	1.442	10.166	2.319		12.264
1.917	1.442	10.166	2.319		12.143
2.000	1.442	10.166	2.319		12.024
2.083	1.509	10.099	2.312		11.905
2.167	1.509	10.099	2.312	2.312	11.788 <==
2.250	1.509	10.099	2.312	2.312	11.672 <==
2.333	1.573	10.034	2.306	2.306	11.557 <==
2.417	1.573	10.034	2.306	2.306	11.444 <==
2.500	1.573	10.034	2.306	2.306	11.331 <==
2.583	1.640	9.967	2.299	2.299	11.220 <==
2.667	1.640	9.967	2.299	2.299	11.109 <==
2.750	1.640	9.967	2.299	2.299	11.000 <==
2.833	1.705	9.903	2.293	2.293	10.892 <==
2.917	1.705	9.903	2.293	2.293	10.785 <==
3.000	1.705	9.903	2.293	2.293	10.678 <==
3.083	1.772	9.836	2.286	2.286	10.573 <==
3.167	1.772	9.836	2.286	2.286	10.469 <==
3.250	1.772	9.836	2.286	2.286	10.366 <==
3.333	1.772	9.836	2.286	2.286	10.264 <==
3.417	1.836	9.771	2.279	2.279	10.163 <==
3.500	1.836	9.771	2.279	2.279	10.063 <==
3.583	1.836	9.771	2.279	2.279	9.964 <==
3.667	1.903	9.704	2.273	2.273	9.866 <==
3.750	1.903	9.704	2.273	2.273	9.769 <==

Time <minutes>	level <feet>	Drawdown Y(t)	ln(Y)		Est. Regression ln(Y) Range
3.833	1.903	9.704	2.273	2.273	9.673 <==
3.917	1.968	9.640	2.266	2.266	9.578 <==
4.000	1.968	9.640	2.266	2.266	9.484 <==
4.083	1.968	9.640	2.266	2.266	9.390 <==
4.167	2.032	9.575	2.259	2.259	9.298 <==
4.250	2.032	9.575	2.259	2.259	9.206 <==
4.333	2.032	9.575	2.259	2.259	9.116 <==
4.417	2.099	9.508	2.252	2.252	9.026 <==
4.500	2.099	9.508	2.252	2.252	8.937 <==
4.583	2.099	9.508	2.252	2.252	8.849 <==
4.667	2.099	9.508	2.252	2.252	8.762 <==
4.750	2.164	9.444	2.245	2.245	8.676 <==
4.833	2.164	9.444	2.245	2.245	8.591 <==
4.917	2.231	9.377	2.238	2.238	8.506 <==
5.000	2.231	9.377	2.238	2.238	8.423 <==
5.083	2.295	9.312	2.231	2.231	8.340 <==
5.167	2.427	9.181	2.217	2.217	8.258 <==
5.250	2.491	9.116	2.210	2.210	8.176 <==
5.333	2.623	8.985	2.196	2.196	8.096 <==
5.417	2.754	8.853	2.181	2.181	8.016 <==
5.500	2.886	8.722	2.166	2.166	7.937 <==
5.583	3.017	8.590	2.151	2.151	7.859 <==
5.667	3.149	8.459	2.135	2.135	7.782 <==
5.750	3.280	8.327	2.120	2.120	7.705 <==
5.833	3.476	8.131	2.096	2.096	7.630 <==
5.917	3.608	8.000	2.079	2.079	7.555 <==
6.000	3.739	7.868	2.063	2.063	7.480 <==
6.083	3.868	7.739	2.046	2.046	7.407 <==
6.167	4.000	7.607	2.029	2.029	7.334 <==
6.250	4.198	7.409	2.003	2.003	7.262 <==
6.333	4.327	7.280	1.985	1.985	7.190 <==
6.417	4.459	7.148	1.967	1.967	7.119 <==
6.500	4.590	7.017	1.948	1.948	7.049 <==
6.583	4.722	6.885	1.929	1.929	6.980 <==
6.667	4.853	6.754	1.910	1.910	6.911 <==
6.750	4.918	6.689	1.901	1.901	6.843 <==
6.833	4.985	6.623	1.890	1.890	6.776 <==
6.917	5.049	6.558	1.881	1.881	6.709 <==
7.000	5.049	6.558	1.881	1.881	6.643 <==
7.083	5.116	6.491	1.870	1.870	6.578 <==
7.167	5.181	6.426	1.860	1.860	6.513 <==
7.250	5.248	6.360	1.850	1.850	6.449 <==
7.333	5.312	6.295	1.840	1.840	6.386 <==
7.417	5.377	6.230	1.829	1.829	6.323 <==
7.500	5.444	6.164	1.819	1.819	6.261 <==
7.583	5.508	6.099	1.808	1.808	6.199 <==

Time <minutes>	level <feet>	Drawdown Y(t)	ln(Y)		Est. Regression ln(Y) Range
7.667	5.575	6.032	1.797	1.797	6.138 <==
7.750	5.640	5.967	1.786	1.786	6.078 <==
7.833	5.640	5.967	1.786	1.786	6.018 <==
7.917	5.707	5.901	1.775	1.775	5.959 <==
8.000	5.771	5.836	1.764	1.764	5.900 <==
8.083	5.836	5.771	1.753	1.753	5.842 <==
8.167	5.903	5.704	1.741	1.741	5.784 <==
8.250	5.903	5.704	1.741	1.741	5.728 <==
8.333	5.967	5.640	1.730	1.730	5.671 <==
8.417	6.034	5.573	1.718	1.718	5.615 <==
8.500	6.099	5.508	1.706	1.706	5.560 <==
8.583	6.099	5.508	1.706	1.706	5.505 <==
8.667	6.166	5.442	1.694	1.694	5.451 <==
8.750	6.230	5.377	1.682	1.682	5.398 <==
8.833	6.295	5.312	1.670	1.670	5.345 <==
8.917	6.295	5.312	1.670	1.670	5.292 <==
9.000	6.362	5.245	1.657	1.657	5.240 <==
9.083	6.426	5.181	1.645	1.645	5.188 <==
9.167	6.426	5.181	1.645	1.645	5.137 <==
9.250	6.493	5.114	1.632	1.632	5.087 <==
9.333	6.558	5.049	1.619	1.619	5.037 <==
9.417	6.558	5.049	1.619	1.619	4.987 <==
9.500	6.625	4.982	1.606	1.606	4.938 <==
9.583	6.689	4.918	1.593	1.593	4.889 <==
9.667	6.689	4.918	1.593	1.593	4.841 <==
9.750	6.754	4.853	1.580	1.580	4.794 <==
9.833	6.821	4.786	1.566	1.566	4.747 <==
9.917	6.885	4.722	1.552	1.552	4.700 <==
10.000	6.885	4.722	1.552	1.552	4.654 <==
10.083	6.952	4.655	1.538	1.538	4.608 <==
10.167	7.017	4.590	1.524	1.524	4.562 <==
10.250	7.017	4.590	1.524	1.524	4.518 <==
10.333	7.084	4.523	1.509	1.509	4.473 <==
10.417	7.084	4.523	1.509	1.509	4.429 <==
10.500	7.148	4.459	1.495	1.495	4.386 <==
10.583	7.213	4.394	1.480	1.480	4.342 <==
10.667	7.213	4.394	1.480	1.480	4.300 <==
10.750	7.280	4.327	1.465	1.465	4.257 <==
10.833	7.345	4.263	1.450	1.450	4.215 <==
10.917	7.345	4.263	1.450	1.450	4.174 <==
11.000	7.411	4.196	1.434	1.434	4.133 <==
11.083	7.476	4.131	1.419	1.419	4.092 <==
11.167	7.543	4.064	1.402	1.402	4.052 <==
11.250	7.543	4.064	1.402	1.402	4.012 <==
11.333	7.607	4.000	1.386	1.386	3.973 <==
11.417	7.672	3.935	1.370	1.370	3.934 <==

Time <minutes>	level <feet>	Drawdown Y(t)	ln(Y)		Est. Regression ln(Y) Range
11.500	7.739	3.868	1.353	1.353	3.895 <==
11.583	7.804	3.804	1.336	1.336	3.857 <==
11.667	7.870	3.737	1.318	1.318	3.819 <==
11.750	7.870	3.737	1.318	1.318	3.781 <==
11.833	7.935	3.672	1.301	1.301	3.744 <==
11.917	7.935	3.672	1.301	1.301	3.707 <==
12.000	8.002	3.605	1.282	1.282	3.671 <==
12.083	8.002	3.605	1.282	1.282	3.634 <==
12.167	8.002	3.605	1.282	1.282	3.599 <==
12.250	8.067	3.541	1.264	1.264	3.563 <==
12.333	8.067	3.541	1.264	1.264	3.528 <==
12.417	8.067	3.541	1.264	1.264	3.493 <==
12.500	8.067	3.541	1.264	1.264	3.459 <==
12.583	8.067	3.541	1.264	1.264	3.425 <==
12.667	8.131	3.476	1.246	1.246	3.391 <==
12.750	8.131	3.476	1.246	1.246	3.358 <==
12.833	8.131	3.476	1.246	1.246	3.325 <==
12.917	8.131	3.476	1.246	1.246	3.292 <==
13.000	8.131	3.476	1.246	1.246	3.260 <==
13.083	8.131	3.476	1.246	1.246	3.228 <==
13.167	8.198	3.409	1.227	1.227	3.196 <==
13.250	8.198	3.409	1.227	1.227	3.165 <==
13.333	8.198	3.409	1.227	1.227	3.133 <==
13.417	8.198	3.409	1.227	1.227	3.103 <==
13.500	8.263	3.345	1.207	1.207	3.072 <==
13.583	8.329	3.278	1.187	1.187	3.042 <==
13.667	8.394	3.213	1.167	1.167	3.012 <==
13.750	8.461	3.146	1.146	1.146	2.982 <==
13.833	8.526	3.082	1.125	1.125	2.953 <==
13.917	8.592	3.015	1.104	1.104	2.924 <==
14.000	8.657	2.950	1.082	1.082	2.895 <==
14.083	8.722	2.886	1.060	1.060	2.867 <==
14.167	8.722	2.886	1.060	1.060	2.838 <==
14.250	8.789	2.819	1.036	1.036	2.810 <==
14.333	8.853	2.754	1.013	1.013	2.783 <==
14.417	8.920	2.687	0.989	0.989	2.755 <==
14.500	8.985	2.623	0.964	0.964	2.728 <==
14.583	9.051	2.556	0.938	0.938	2.701 <==
14.667	9.051	2.556	0.938	0.938	2.675 <==
14.750	9.116	2.491	0.913	0.913	2.649 <==
14.833	9.181	2.427	0.887	0.887	2.623 <==
14.917	9.248	2.360	0.859	0.859	2.597 <==
15.000	9.248	2.360	0.859	0.859	2.571 <==
15.083	9.312	2.295	0.831	0.831	2.546 <==
15.167	9.379	2.228	0.801	0.801	2.521 <==
15.250	9.444	2.164	0.772	0.772	2.496 <==

Time <minutes>	level <feet>	Drawdown Y(t)	ln(Y)		Est. Regression ln(Y) Range
15.333	9.444	2.164	0.772	0.772	2.471 <==
15.417	9.511	2.097	0.740	0.740	2.447 <==
15.500	9.511	2.097	0.740	0.740	2.423 <==
15.583	9.575	2.032	0.709		2.399
15.667	9.640	1.968	0.677		2.376
15.750	9.640	1.968	0.677		2.352
15.833	9.707	1.901	0.642		2.329
15.917	9.707	1.901	0.642		2.306
16.000	9.771	1.836	0.608		2.283
16.083	9.771	1.836	0.608		2.261
16.167	9.838	1.769	0.571		2.239
16.250	9.838	1.769	0.571		2.217
16.333	9.903	1.705	0.533		2.195
16.417	9.903	1.705	0.533		2.173
16.500	9.970	1.638	0.493		2.152
16.583	9.970	1.638	0.493		2.131
16.667	10.034	1.573	0.453		2.110
16.750	10.034	1.573	0.453		2.089
16.833	10.099	1.509	0.411		2.069
16.917	10.099	1.509	0.411		2.048
17.000	10.166	1.442	0.366		2.028
17.083	10.166	1.442	0.366		2.008
17.167	10.166	1.442	0.366		1.988
17.250	10.230	1.377	0.320		1.969
17.333	10.230	1.377	0.320		1.949
17.417	10.297	1.310	0.270		1.930
17.500	10.297	1.310	0.270		1.911
17.583	10.362	1.246	0.220		1.892
17.667	10.362	1.246	0.220		1.874
17.750	10.362	1.246	0.220		1.855
17.833	10.429	1.179	0.164		1.837
17.917	10.429	1.179	0.164		1.819
18.000	10.429	1.179	0.164		1.801

Slug Test Analysis - Bouwer & Rice/Hvorslev's Methods

Version: 0.96b

Client: Cargil Alameda

Revised: 1999-07-10

Proj. Name: CRA102

Well ID: MW-3

Test by: Martha Watson

Test Date: 01/15/02

Calculation Set Number		
CRA102.03		
Calc. by	Chkd. by	Apvd. by
MJW	MJW	
Date	Date	Date
2/8/02	2/24/02	

User Input Data

Aquifer Thickness	50.0
Well Length (L _w)	14.36
Intake Length (L _i)	12.00
Well Radius (R _w)	0.104
Casing Radius (R _c)	0.042
Xform ratio, m [(K _h /K _v) ^{0.5}]	1
Sandpack Porosity	0.33
Slug Volume	0.035
Static Level	10.166
Offset time	0.000

R _{equiv}	-1.000	-1.000	-1.000
Estimated Porosity & R _w	-1.000	-1.000	
ln(R _E /R _w)		3.259	-1.000
Shape Factor (F)		15.884	-1.000
Drawdown:	<u>Max. Y_t</u>	<u>Regr. Y_o</u>	<u>Casing Y_o</u>
	6.43	6.54	6.43

(undrained)

(unconfined)

Drained Options

	A	B	C	D
	Undrained	User n/R _w	Est. n	Est. R _w
Bouwer & Rice - consistent units	4.9E-06			
<cm/sec>	2.50E-06			
Hvorslev - consistent units	7.2E-06			
<cm/sec>	3.6E-06			
Potentially acceptable solutions:	A			
Conversion factor for user units:	<cm/sec>	0.508		

Intercept 1.878
 Slope -0.021
 No. of Observations 452
 Starting Row 49
 Ending Row 500

COMMENTS:

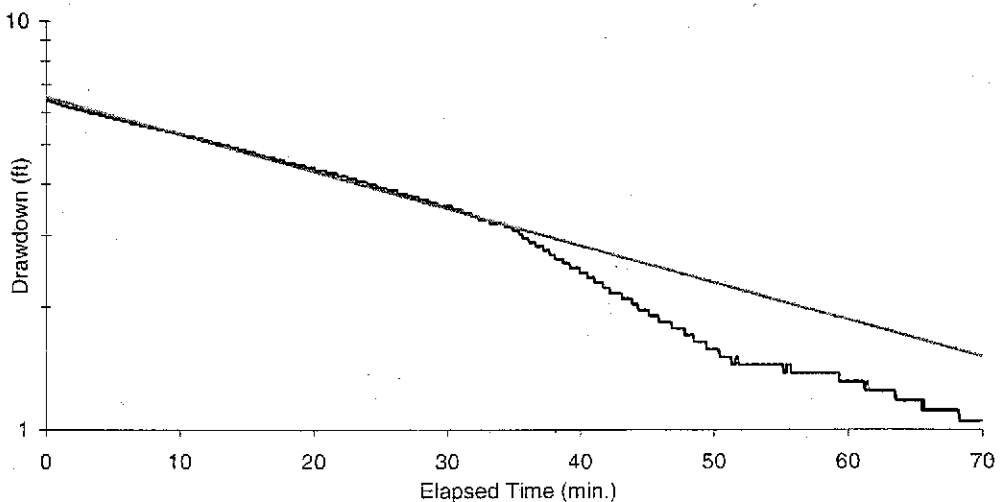

Time <minutes>	level <feet>	Drawdown Y(t)	ln(Y)		Est. Regression ln(Y) Range
0.000	3.739	6.426	1.860	1.860	6.539 <==
0.083	3.739	6.426	1.860	1.860	6.528 <==
0.167	3.739	6.426	1.860	1.860	6.516 <==
0.250	3.739	6.426	1.860	1.860	6.505 <==
0.333	3.804	6.362	1.850	1.850	6.494 <==
0.417	3.804	6.362	1.850	1.850	6.482 <==
0.500	3.804	6.362	1.850	1.850	6.471 <==
0.583	3.804	6.362	1.850	1.850	6.460 <==
0.667	3.804	6.362	1.850	1.850	6.448 <==
0.750	3.868	6.297	1.840	1.840	6.437 <==
0.833	3.868	6.297	1.840	1.840	6.426 <==
0.917	3.868	6.297	1.840	1.840	6.415 <==
1.000	3.868	6.297	1.840	1.840	6.404 <==
1.083	3.868	6.297	1.840	1.840	6.393 <==
1.167	3.935	6.230	1.829	1.829	6.381 <==
1.250	3.935	6.230	1.829	1.829	6.370 <==
1.333	3.935	6.230	1.829	1.829	6.359 <==
1.417	3.935	6.230	1.829	1.829	6.348 <==
1.500	3.935	6.230	1.829	1.829	6.337 <==
1.583	3.935	6.230	1.829	1.829	6.326 <==
1.667	4.000	6.166	1.819	1.819	6.315 <==
1.750	4.000	6.166	1.819	1.819	6.304 <==
1.833	4.000	6.166	1.819	1.819	6.293 <==
1.917	4.000	6.166	1.819	1.819	6.282 <==
2.000	4.000	6.166	1.819	1.819	6.271 <==
2.083	4.000	6.166	1.819	1.819	6.260 <==
2.167	4.000	6.166	1.819	1.819	6.249 <==
2.250	4.067	6.099	1.808	1.808	6.238 <==
2.333	4.067	6.099	1.808	1.808	6.228 <==
2.417	4.067	6.099	1.808	1.808	6.217 <==
2.500	4.067	6.099	1.808	1.808	6.206 <==
2.583	4.067	6.099	1.808	1.808	6.195 <==
2.667	4.067	6.099	1.808	1.808	6.184 <==
2.750	4.131	6.034	1.797	1.797	6.174 <==
2.833	4.131	6.034	1.797	1.797	6.163 <==
2.917	4.131	6.034	1.797	1.797	6.152 <==
3.000	4.131	6.034	1.797	1.797	6.141 <==
3.083	4.131	6.034	1.797	1.797	6.131 <==
3.167	4.131	6.034	1.797	1.797	6.120 <==
3.250	4.198	5.967	1.786	1.786	6.109 <==
3.333	4.198	5.967	1.786	1.786	6.099 <==
3.417	4.198	5.967	1.786	1.786	6.088 <==
3.500	4.198	5.967	1.786	1.786	6.077 <==
3.583	4.198	5.967	1.786	1.786	6.067 <==
3.667	4.198	5.967	1.786	1.786	6.056 <==
3.750	4.198	5.967	1.786	1.786	6.046 <==

Time <minutes>	level <feet>	Drawdown Y(t)	In(Y)		Est. Regression In(Y) Range
3.833	4.198	5.967	1.786	1.786	6.035 <==
3.917	4.198	5.967	1.786	1.786	6.025 <==
4.000	4.263	5.903	1.775	1.775	6.014 <==
4.083	4.263	5.903	1.775	1.775	6.004 <==
4.167	4.263	5.903	1.775	1.775	5.993 <==
4.250	4.263	5.903	1.775	1.775	5.983 <==
4.333	4.263	5.903	1.775	1.775	5.972 <==
4.417	4.263	5.903	1.775	1.775	5.962 <==
4.500	4.327	5.838	1.764	1.764	5.952 <==
4.583	4.327	5.838	1.764	1.764	5.941 <==
4.667	4.327	5.838	1.764	1.764	5.931 <==
4.750	4.327	5.838	1.764	1.764	5.921 <==
4.833	4.327	5.838	1.764	1.764	5.910 <==
4.917	4.327	5.838	1.764	1.764	5.900 <==
5.000	4.327	5.838	1.764	1.764	5.890 <==
5.083	4.394	5.771	1.753	1.753	5.880 <==
5.167	4.394	5.771	1.753	1.753	5.869 <==
5.250	4.394	5.771	1.753	1.753	5.859 <==
5.333	4.394	5.771	1.753	1.753	5.849 <==
5.417	4.394	5.771	1.753	1.753	5.839 <==
5.500	4.394	5.771	1.753	1.753	5.829 <==
5.583	4.394	5.771	1.753	1.753	5.818 <==
5.667	4.459	5.707	1.742	1.742	5.808 <==
5.750	4.459	5.707	1.742	1.742	5.798 <==
5.833	4.459	5.707	1.742	1.742	5.788 <==
5.917	4.459	5.707	1.742	1.742	5.778 <==
6.000	4.459	5.707	1.742	1.742	5.768 <==
6.083	4.459	5.707	1.742	1.742	5.758 <==
6.167	4.459	5.707	1.742	1.742	5.748 <==
6.250	4.459	5.707	1.742	1.742	5.738 <==
6.333	4.526	5.640	1.730	1.730	5.728 <==
6.417	4.526	5.640	1.730	1.730	5.718 <==
6.500	4.526	5.640	1.730	1.730	5.708 <==
6.583	4.526	5.640	1.730	1.730	5.698 <==
6.667	4.526	5.640	1.730	1.730	5.688 <==
6.750	4.526	5.640	1.730	1.730	5.678 <==
6.833	4.526	5.640	1.730	1.730	5.668 <==
6.917	4.526	5.640	1.730	1.730	5.658 <==
7.000	4.590	5.575	1.718	1.718	5.648 <==
7.083	4.590	5.575	1.718	1.718	5.639 <==
7.167	4.590	5.575	1.718	1.718	5.629 <==
7.250	4.590	5.575	1.718	1.718	5.619 <==
7.333	4.590	5.575	1.718	1.718	5.609 <==
7.417	4.590	5.575	1.718	1.718	5.599 <==
7.500	4.590	5.575	1.718	1.718	5.590 <==
7.583	4.590	5.575	1.718	1.718	5.580 <==

Time <minutes>	level <feet>	Drawdown Y(t)	ln(Y)	Est. Regression ln(Y) Range
7.667	4.657	5.508	1.706	1.706 5.570 <==
7.750	4.657	5.508	1.706	1.706 5.561 <==
7.833	4.657	5.508	1.706	1.706 5.551 <==
7.917	4.657	5.508	1.706	1.706 5.541 <==
8.000	4.657	5.508	1.706	1.706 5.532 <==
8.083	4.657	5.508	1.706	1.706 5.522 <==
8.167	4.657	5.508	1.706	1.706 5.512 <==
8.250	4.657	5.508	1.706	1.706 5.503 <==
8.333	4.722	5.444	1.694	1.694 5.493 <==
8.417	4.722	5.444	1.694	1.694 5.484 <==
8.500	4.722	5.444	1.694	1.694 5.474 <==
8.583	4.722	5.444	1.694	1.694 5.465 <==
8.667	4.722	5.444	1.694	1.694 5.455 <==
8.750	4.722	5.444	1.694	1.694 5.446 <==
8.833	4.722	5.444	1.694	1.694 5.436 <==
8.917	4.722	5.444	1.694	1.694 5.427 <==
9.000	4.786	5.379	1.683	1.683 5.417 <==
9.083	4.786	5.379	1.683	1.683 5.408 <==
9.167	4.786	5.379	1.683	1.683 5.398 <==
9.250	4.786	5.379	1.683	1.683 5.389 <==
9.333	4.786	5.379	1.683	1.683 5.379 <==
9.417	4.786	5.379	1.683	1.683 5.370 <==
9.500	4.786	5.379	1.683	1.683 5.361 <==
9.583	4.786	5.379	1.683	1.683 5.351 <==
9.667	4.786	5.379	1.683	1.683 5.342 <==
9.750	4.853	5.312	1.670	1.670 5.333 <==
9.833	4.853	5.312	1.670	1.670 5.324 <==
9.917	4.853	5.312	1.670	1.670 5.314 <==
10.000	4.853	5.312	1.670	1.670 5.305 <==
10.083	4.853	5.312	1.670	1.670 5.296 <==
10.167	4.853	5.312	1.670	1.670 5.287 <==
10.250	4.853	5.312	1.670	1.670 5.277 <==
10.333	4.853	5.312	1.670	1.670 5.268 <==
10.417	4.918	5.248	1.658	1.658 5.259 <==
10.500	4.918	5.248	1.658	1.658 5.250 <==
10.583	4.918	5.248	1.658	1.658 5.241 <==
10.667	4.918	5.248	1.658	1.658 5.232 <==
10.750	4.918	5.248	1.658	1.658 5.222 <==
10.833	4.918	5.248	1.658	1.658 5.213 <==
10.917	4.918	5.248	1.658	1.658 5.204 <==
11.000	4.918	5.248	1.658	1.658 5.195 <==
11.083	4.918	5.248	1.658	1.658 5.186 <==
11.167	4.985	5.181	1.645	1.645 5.177 <==
11.250	4.985	5.181	1.645	1.645 5.168 <==
11.333	4.985	5.181	1.645	1.645 5.159 <==
11.417	4.985	5.181	1.645	1.645 5.150 <==

Time <minutes>	level <feet>	Drawdown Y(t)	ln(Y)		Est. Regression ln(Y) Range
11.500	4.985	5.181	1.645	1.645	5.141 <==
11.583	4.985	5.181	1.645	1.645	5.132 <==
11.667	4.985	5.181	1.645	1.645	5.123 <==
11.750	5.049	5.116	1.632	1.632	5.114 <==
11.833	5.049	5.116	1.632	1.632	5.105 <==
11.917	5.049	5.116	1.632	1.632	5.097 <==
12.000	5.049	5.116	1.632	1.632	5.088 <==
12.083	5.049	5.116	1.632	1.632	5.079 <==
12.167	5.049	5.116	1.632	1.632	5.070 <==
12.250	5.049	5.116	1.632	1.632	5.061 <==
12.333	5.049	5.116	1.632	1.632	5.052 <==
12.417	5.116	5.049	1.619	1.619	5.044 <==
12.500	5.116	5.049	1.619	1.619	5.035 <==
12.583	5.116	5.049	1.619	1.619	5.026 <==
12.667	5.116	5.049	1.619	1.619	5.017 <==
12.750	5.116	5.049	1.619	1.619	5.009 <==
12.833	5.116	5.049	1.619	1.619	5.000 <==
12.917	5.116	5.049	1.619	1.619	4.991 <==
13.000	5.116	5.049	1.619	1.619	4.982 <==
13.083	5.181	4.985	1.606	1.606	4.974 <==
13.167	5.181	4.985	1.606	1.606	4.965 <==
13.250	5.181	4.985	1.606	1.606	4.956 <==
13.333	5.181	4.985	1.606	1.606	4.948 <==
13.417	5.181	4.985	1.606	1.606	4.939 <==
13.500	5.181	4.985	1.606	1.606	4.931 <==
13.583	5.181	4.985	1.606	1.606	4.922 <==
13.667	5.181	4.985	1.606	1.606	4.913 <==
13.750	5.248	4.918	1.593	1.593	4.905 <==
13.833	5.248	4.918	1.593	1.593	4.896 <==
13.917	5.248	4.918	1.593	1.593	4.888 <==
14.000	5.248	4.918	1.593	1.593	4.879 <==
14.083	5.248	4.918	1.593	1.593	4.871 <==
14.167	5.248	4.918	1.593	1.593	4.862 <==
14.250	5.248	4.918	1.593	1.593	4.854 <==
14.333	5.248	4.918	1.593	1.593	4.845 <==
14.417	5.312	4.853	1.580	1.580	4.837 <==
14.500	5.312	4.853	1.580	1.580	4.829 <==
14.583	5.312	4.853	1.580	1.580	4.820 <==
14.667	5.312	4.853	1.580	1.580	4.812 <==
14.750	5.312	4.853	1.580	1.580	4.803 <==
14.833	5.312	4.853	1.580	1.580	4.795 <==
14.917	5.312	4.853	1.580	1.580	4.787 <==
15.000	5.377	4.789	1.566	1.566	4.778 <==
15.083	5.377	4.789	1.566	1.566	4.770 <==
15.167	5.377	4.789	1.566	1.566	4.762 <==
15.250	5.377	4.789	1.566	1.566	4.753 <==

Time <minutes>	level <feet>	Drawdown Y(t)	ln(Y)		Est. Regression ln(Y) Range
15.333	5.377	4.789	1.566	1.566	4.745 <==
15.417	5.377	4.789	1.566	1.566	4.737 <==
15.500	5.377	4.789	1.566	1.566	4.729 <==
15.583	5.377	4.789	1.566	1.566	4.720 <==
15.667	5.444	4.722	1.552	1.552	4.712 <==
15.750	5.444	4.722	1.552	1.552	4.704 <==
15.833	5.444	4.722	1.552	1.552	4.696 <==
15.917	5.444	4.722	1.552	1.552	4.688 <==
16.000	5.444	4.722	1.552	1.552	4.679 <==
16.083	5.444	4.722	1.552	1.552	4.671 <==
16.167	5.444	4.722	1.552	1.552	4.663 <==
16.250	5.444	4.722	1.552	1.552	4.655 <==
16.333	5.508	4.657	1.538	1.538	4.647 <==
16.417	5.508	4.657	1.538	1.538	4.639 <==
16.500	5.508	4.657	1.538	1.538	4.631 <==
16.583	5.508	4.657	1.538	1.538	4.623 <==
16.667	5.508	4.657	1.538	1.538	4.615 <==
16.750	5.508	4.657	1.538	1.538	4.607 <==
16.833	5.508	4.657	1.538	1.538	4.599 <==
16.917	5.508	4.657	1.538	1.538	4.591 <==
17.000	5.508	4.657	1.538	1.538	4.583 <==
17.083	5.508	4.657	1.538	1.538	4.575 <==
17.167	5.575	4.590	1.524	1.524	4.567 <==
17.250	5.575	4.590	1.524	1.524	4.559 <==
17.333	5.575	4.590	1.524	1.524	4.551 <==
17.417	5.575	4.590	1.524	1.524	4.543 <==
17.500	5.575	4.590	1.524	1.524	4.535 <==
17.583	5.575	4.590	1.524	1.524	4.527 <==
17.667	5.575	4.590	1.524	1.524	4.519 <==
17.750	5.575	4.590	1.524	1.524	4.511 <==
17.833	5.640	4.526	1.510	1.510	4.503 <==
17.917	5.640	4.526	1.510	1.510	4.496 <==
18.000	5.640	4.526	1.510	1.510	4.488 <==
18.083	5.640	4.526	1.510	1.510	4.480 <==
18.167	5.640	4.526	1.510	1.510	4.472 <==
18.250	5.640	4.526	1.510	1.510	4.464 <==
18.333	5.640	4.526	1.510	1.510	4.457 <==
18.417	5.640	4.526	1.510	1.510	4.449 <==
18.500	5.640	4.526	1.510	1.510	4.441 <==
18.583	5.640	4.526	1.510	1.510	4.433 <==
18.667	5.707	4.459	1.495	1.495	4.426 <==
18.750	5.707	4.459	1.495	1.495	4.418 <==
18.833	5.707	4.459	1.495	1.495	4.410 <==
18.917	5.707	4.459	1.495	1.495	4.402 <==
19.000	5.707	4.459	1.495	1.495	4.395 <==
19.083	5.707	4.459	1.495	1.495	4.387 <==

Time <minutes>	level <feet>	Drawdown Y(t)	ln(Y)		Est. Regression ln(Y) Range
19.167	5.707	4.459	1.495	1.495	4.380 <==
19.250	5.707	4.459	1.495	1.495	4.372 <==
19.333	5.707	4.459	1.495	1.495	4.364 <==
19.417	5.771	4.394	1.480	1.480	4.357 <==
19.500	5.771	4.394	1.480	1.480	4.349 <==
19.583	5.771	4.394	1.480	1.480	4.342 <==
19.667	5.771	4.394	1.480	1.480	4.334 <==
19.750	5.771	4.394	1.480	1.480	4.326 <==
19.833	5.771	4.394	1.480	1.480	4.319 <==
19.917	5.771	4.394	1.480	1.480	4.311 <==
20.000	5.771	4.394	1.480	1.480	4.304 <==
20.083	5.771	4.394	1.480	1.480	4.296 <==
20.167	5.836	4.330	1.465	1.465	4.289 <==
20.250	5.836	4.330	1.465	1.465	4.281 <==
20.333	5.836	4.330	1.465	1.465	4.274 <==
20.417	5.836	4.330	1.465	1.465	4.267 <==
20.500	5.836	4.330	1.465	1.465	4.259 <==
20.583	5.836	4.330	1.465	1.465	4.252 <==
20.667	5.836	4.330	1.465	1.465	4.244 <==
20.750	5.836	4.330	1.465	1.465	4.237 <==
20.833	5.836	4.330	1.465	1.465	4.230 <==
20.917	5.836	4.330	1.465	1.465	4.222 <==
21.000	5.903	4.263	1.450	1.450	4.215 <==
21.083	5.903	4.263	1.450	1.450	4.207 <==
21.167	5.903	4.263	1.450	1.450	4.200 <==
21.250	5.903	4.263	1.450	1.450	4.193 <==
21.333	5.903	4.263	1.450	1.450	4.186 <==
21.417	5.903	4.263	1.450	1.450	4.178 <==
21.500	5.903	4.263	1.450	1.450	4.171 <==
21.583	5.903	4.263	1.450	1.450	4.164 <==
21.667	5.903	4.263	1.450	1.450	4.156 <==
21.750	5.903	4.263	1.450	1.450	4.149 <==
21.833	5.967	4.198	1.435	1.435	4.142 <==
21.917	5.967	4.198	1.435	1.435	4.135 <==
22.000	5.967	4.198	1.435	1.435	4.128 <==
22.083	5.967	4.198	1.435	1.435	4.120 <==
22.167	5.967	4.198	1.435	1.435	4.113 <==
22.250	5.967	4.198	1.435	1.435	4.106 <==
22.333	5.967	4.198	1.435	1.435	4.099 <==
22.417	5.967	4.198	1.435	1.435	4.092 <==
22.500	5.967	4.198	1.435	1.435	4.085 <==
22.583	6.034	4.131	1.419	1.419	4.078 <==
22.667	6.034	4.131	1.419	1.419	4.070 <==
22.750	6.034	4.131	1.419	1.419	4.063 <==
22.833	6.034	4.131	1.419	1.419	4.056 <==
22.917	6.034	4.131	1.419	1.419	4.049 <==

Time <minutes>	level <feet>	Drawdown Y(t)	ln(Y)		Est. Regression ln(Y) Range
23.000	6.034	4.131	1.419	1.419	4.042 <==
23.083	6.034	4.131	1.419	1.419	4.035 <==
23.167	6.034	4.131	1.419	1.419	4.028 <==
23.250	6.099	4.067	1.403	1.403	4.021 <==
23.333	6.099	4.067	1.403	1.403	4.014 <==
23.417	6.099	4.067	1.403	1.403	4.007 <==
23.500	6.099	4.067	1.403	1.403	4.000 <==
23.583	6.099	4.067	1.403	1.403	3.993 <==
23.667	6.099	4.067	1.403	1.403	3.986 <==
23.750	6.099	4.067	1.403	1.403	3.979 <==
23.833	6.099	4.067	1.403	1.403	3.972 <==
23.917	6.099	4.067	1.403	1.403	3.965 <==
24.000	6.099	4.067	1.403	1.403	3.958 <==
24.083	6.166	4.000	1.386	1.386	3.952 <==
24.167	6.166	4.000	1.386	1.386	3.945 <==
24.250	6.166	4.000	1.386	1.386	3.938 <==
24.333	6.166	4.000	1.386	1.386	3.931 <==
24.417	6.166	4.000	1.386	1.386	3.924 <==
24.500	6.166	4.000	1.386	1.386	3.917 <==
24.583	6.166	4.000	1.386	1.386	3.910 <==
24.667	6.166	4.000	1.386	1.386	3.904 <==
24.750	6.230	3.935	1.370	1.370	3.897 <==
24.833	6.230	3.935	1.370	1.370	3.890 <==
24.917	6.230	3.935	1.370	1.370	3.883 <==
25.000	6.230	3.935	1.370	1.370	3.877 <==
25.083	6.230	3.935	1.370	1.370	3.870 <==
25.167	6.230	3.935	1.370	1.370	3.863 <==
25.250	6.230	3.935	1.370	1.370	3.856 <==
25.333	6.230	3.935	1.370	1.370	3.850 <==
25.417	6.230	3.935	1.370	1.370	3.843 <==
25.500	6.295	3.871	1.353	1.353	3.836 <==
25.583	6.295	3.871	1.353	1.353	3.830 <==
25.667	6.295	3.871	1.353	1.353	3.823 <==
25.750	6.295	3.871	1.353	1.353	3.816 <==
25.833	6.295	3.871	1.353	1.353	3.810 <==
25.917	6.295	3.871	1.353	1.353	3.803 <==
26.000	6.295	3.871	1.353	1.353	3.796 <==
26.083	6.295	3.871	1.353	1.353	3.790 <==
26.167	6.295	3.871	1.353	1.353	3.783 <==
26.250	6.295	3.871	1.353	1.353	3.777 <==
26.333	6.362	3.804	1.336	1.336	3.770 <==
26.417	6.362	3.804	1.336	1.336	3.763 <==
26.500	6.362	3.804	1.336	1.336	3.757 <==
26.583	6.362	3.804	1.336	1.336	3.750 <==
26.667	6.362	3.804	1.336	1.336	3.744 <==
26.750	6.362	3.804	1.336	1.336	3.737 <==

Time <minutes>	level <feet>	Drawdown Y(t)	ln(Y)		Est. Regression ln(Y) Range
26.833	6.362	3.804	1.336	1.336	3.731 <==
26.917	6.362	3.804	1.336	1.336	3.724 <==
27.000	6.362	3.804	1.336	1.336	3.718 <==
27.083	6.426	3.739	1.319	1.319	3.711 <==
27.167	6.426	3.739	1.319	1.319	3.705 <==
27.250	6.426	3.739	1.319	1.319	3.698 <==
27.333	6.426	3.739	1.319	1.319	3.692 <==
27.417	6.426	3.739	1.319	1.319	3.685 <==
27.500	6.426	3.739	1.319	1.319	3.679 <==
27.583	6.426	3.739	1.319	1.319	3.673 <==
27.667	6.426	3.739	1.319	1.319	3.666 <==
27.750	6.426	3.739	1.319	1.319	3.660 <==
27.833	6.426	3.739	1.319	1.319	3.654 <==
27.917	6.493	3.672	1.301	1.301	3.647 <==
28.000	6.493	3.672	1.301	1.301	3.641 <==
28.083	6.493	3.672	1.301	1.301	3.634 <==
28.167	6.493	3.672	1.301	1.301	3.628 <==
28.250	6.493	3.672	1.301	1.301	3.622 <==
28.333	6.493	3.672	1.301	1.301	3.616 <==
28.417	6.493	3.672	1.301	1.301	3.609 <==
28.500	6.493	3.672	1.301	1.301	3.603 <==
28.583	6.493	3.672	1.301	1.301	3.597 <==
28.667	6.558	3.608	1.283	1.283	3.590 <==
28.750	6.558	3.608	1.283	1.283	3.584 <==
28.833	6.558	3.608	1.283	1.283	3.578 <==
28.917	6.558	3.608	1.283	1.283	3.572 <==
29.000	6.558	3.608	1.283	1.283	3.565 <==
29.083	6.558	3.608	1.283	1.283	3.559 <==
29.167	6.558	3.608	1.283	1.283	3.553 <==
29.250	6.558	3.608	1.283	1.283	3.547 <==
29.333	6.625	3.541	1.264	1.264	3.541 <==
29.417	6.625	3.541	1.264	1.264	3.535 <==
29.500	6.625	3.541	1.264	1.264	3.528 <==
29.583	6.625	3.541	1.264	1.264	3.522 <==
29.667	6.625	3.541	1.264	1.264	3.516 <==
29.750	6.625	3.541	1.264	1.264	3.510 <==
29.833	6.625	3.541	1.264	1.264	3.504 <==
29.917	6.625	3.541	1.264	1.264	3.498 <==
30.000	6.625	3.541	1.264	1.264	3.492 <==
30.083	6.625	3.541	1.264	1.264	3.486 <==
30.167	6.625	3.541	1.264	1.264	3.480 <==
30.250	6.625	3.541	1.264	1.264	3.473 <==
30.333	6.625	3.541	1.264	1.264	3.467 <==
30.417	6.689	3.476	1.246	1.246	3.461 <==
30.500	6.689	3.476	1.246	1.246	3.455 <==
30.583	6.689	3.476	1.246	1.246	3.449 <==

Time <minutes>	level <feet>	Drawdown Y(t)	ln(Y)		Est. Regression ln(Y) Range
30.667	6.689	3.476	1.246	1.246	3.443 <==
30.750	6.689	3.476	1.246	1.246	3.437 <==
30.833	6.689	3.476	1.246	1.246	3.431 <==
30.917	6.689	3.476	1.246	1.246	3.425 <==
31.000	6.689	3.476	1.246	1.246	3.419 <==
31.083	6.689	3.476	1.246	1.246	3.413 <==
31.167	6.754	3.412	1.227	1.227	3.408 <==
31.250	6.754	3.412	1.227	1.227	3.402 <==
31.333	6.754	3.412	1.227	1.227	3.396 <==
31.417	6.754	3.412	1.227	1.227	3.390 <==
31.500	6.754	3.412	1.227	1.227	3.384 <==
31.583	6.754	3.412	1.227	1.227	3.378 <==
31.667	6.754	3.412	1.227	1.227	3.372 <==
31.750	6.754	3.412	1.227	1.227	3.366 <==
31.833	6.821	3.345	1.207	1.207	3.360 <==
31.917	6.821	3.345	1.207	1.207	3.354 <==
32.000	6.821	3.345	1.207	1.207	3.349 <==
32.083	6.821	3.345	1.207	1.207	3.343 <==
32.167	6.821	3.345	1.207	1.207	3.337 <==
32.250	6.821	3.345	1.207	1.207	3.331 <==
32.333	6.821	3.345	1.207	1.207	3.325 <==
32.417	6.885	3.280	1.188	1.188	3.320 <==
32.500	6.885	3.280	1.188	1.188	3.314 <==
32.583	6.885	3.280	1.188	1.188	3.308 <==
32.667	6.885	3.280	1.188	1.188	3.302 <==
32.750	6.885	3.280	1.188	1.188	3.297 <==
32.833	6.885	3.280	1.188	1.188	3.291 <==
32.917	6.885	3.280	1.188	1.188	3.285 <==
33.000	6.885	3.280	1.188	1.188	3.279 <==
33.083	6.885	3.280	1.188	1.188	3.274 <==
33.167	6.952	3.213	1.167	1.167	3.268 <==
33.250	6.952	3.213	1.167	1.167	3.262 <==
33.333	6.952	3.213	1.167	1.167	3.257 <==
33.417	6.952	3.213	1.167	1.167	3.251 <==
33.500	6.952	3.213	1.167	1.167	3.245 <==
33.583	6.952	3.213	1.167	1.167	3.240 <==
33.667	6.952	3.213	1.167	1.167	3.234 <==
33.750	6.952	3.213	1.167	1.167	3.228 <==
33.833	6.952	3.213	1.167	1.167	3.223 <==
33.917	6.952	3.213	1.167	1.167	3.217 <==
34.000	6.952	3.213	1.167	1.167	3.211 <==
34.083	6.952	3.213	1.167	1.167	3.206 <==
34.167	6.952	3.213	1.167	1.167	3.200 <==
34.250	6.952	3.213	1.167	1.167	3.195 <==
34.333	7.017	3.149	1.147	1.147	3.189 <==
34.417	7.017	3.149	1.147	1.147	3.184 <==

Time <minutes>	level <feet>	Drawdown Y(t)	ln(Y)		Est. Regression ln(Y) Range
34.500	7.017	3.149	1.147	1.147	3.178 <==
34.583	7.017	3.149	1.147	1.147	3.173 <==
34.667	7.017	3.149	1.147	1.147	3.167 <==
34.750	7.017	3.149	1.147	1.147	3.161 <==
34.833	7.017	3.149	1.147	1.147	3.156 <==
34.917	7.084	3.082	1.125	1.125	3.150 <==
35.000	7.084	3.082	1.125	1.125	3.145 <==
35.083	7.084	3.082	1.125	1.125	3.140 <==
35.167	7.084	3.082	1.125	1.125	3.134 <==
35.250	7.084	3.082	1.125	1.125	3.129 <==
35.333	7.084	3.082	1.125	1.125	3.123 <==
35.417	7.148	3.017	1.104	1.104	3.118 <==
35.500	7.148	3.017	1.104	1.104	3.112 <==
35.583	7.148	3.017	1.104	1.104	3.107 <==
35.667	7.213	2.953	1.083	1.083	3.101 <==
35.750	7.213	2.953	1.083	1.083	3.096 <==
35.833	7.213	2.953	1.083	1.083	3.091 <==
35.917	7.213	2.953	1.083	1.083	3.085 <==
36.000	7.213	2.953	1.083	1.083	3.080 <==
36.083	7.213	2.953	1.083	1.083	3.075 <==
36.167	7.280	2.886	1.060	1.060	3.069 <==
36.250	7.280	2.886	1.060	1.060	3.064 <==
36.333	7.280	2.886	1.060	1.060	3.059 <==
36.417	7.280	2.886	1.060	1.060	3.053 <==
36.500	7.280	2.886	1.060	1.060	3.048 <==
36.583	7.280	2.886	1.060	1.060	3.043 <==
36.667	7.345	2.821	1.037	1.037	3.037 <==
36.750	7.345	2.821	1.037	1.037	3.032 <==
36.833	7.345	2.821	1.037	1.037	3.027 <==
36.917	7.345	2.821	1.037	1.037	3.021 <==
37.000	7.345	2.821	1.037	1.037	3.016 <==
37.083	7.345	2.821	1.037	1.037	3.011 <==
37.167	7.345	2.821	1.037	1.037	3.006 <==
37.250	7.411	2.754	1.013	1.013	3.000 <==
37.333	7.411	2.754	1.013	1.013	2.995 <==
37.417	7.411	2.754	1.013	1.013	2.990 <==
37.500	7.411	2.754	1.013	1.013	2.985 <==
37.583	7.411	2.754	1.013	1.013	2.980 <==
37.667	7.411	2.754	1.013		2.974
37.750	7.476	2.690	0.989		2.969
37.833	7.476	2.690	0.989		2.964
37.917	7.476	2.690	0.989		2.959
38.000	7.476	2.690	0.989		2.954
38.083	7.476	2.690	0.989		2.949
38.167	7.543	2.623	0.964		2.943
38.250	7.543	2.623	0.964		2.938

Time <minutes>	level <feet>	Drawdown Y(t)	ln(Y)	Est. Regression ln(Y) Range
38.333	7.543	2.623	0.964	2.933
38.417	7.543	2.623	0.964	2.928
38.500	7.543	2.623	0.964	2.923
38.583	7.543	2.623	0.964	2.918
38.667	7.543	2.623	0.964	2.913
38.750	7.607	2.558	0.939	2.908
38.833	7.607	2.558	0.939	2.903
38.917	7.607	2.558	0.939	2.898
39.000	7.607	2.558	0.939	2.893
39.083	7.607	2.558	0.939	2.888
39.167	7.607	2.558	0.939	2.883
39.250	7.672	2.494	0.914	2.878
39.333	7.672	2.494	0.914	2.873
39.417	7.672	2.494	0.914	2.868
39.500	7.672	2.494	0.914	2.863
39.583	7.672	2.494	0.914	2.858
39.667	7.672	2.494	0.914	2.853
39.750	7.672	2.494	0.914	2.848
39.833	7.672	2.494	0.914	2.843
39.917	7.672	2.494	0.914	2.838
40.000	7.739	2.427	0.887	2.833
40.083	7.739	2.427	0.887	2.828
40.167	7.739	2.427	0.887	2.823
40.250	7.739	2.427	0.887	2.818
40.333	7.739	2.427	0.887	2.813
40.417	7.739	2.427	0.887	2.808
40.500	7.739	2.427	0.887	2.803
40.583	7.804	2.362	0.860	2.798
40.667	7.804	2.362	0.860	2.794
40.750	7.804	2.362	0.860	2.789
40.833	7.804	2.362	0.860	2.784
40.917	7.804	2.362	0.860	2.779
41.000	7.804	2.362	0.860	2.774
41.083	7.870	2.295	0.831	2.769
41.167	7.870	2.295	0.831	2.764
41.250	7.870	2.295	0.831	2.760
41.333	7.870	2.295	0.831	2.755
41.417	7.870	2.295	0.831	2.750
41.500	7.870	2.295	0.831	2.745
41.583	7.870	2.295	0.831	2.740
41.667	7.870	2.295	0.831	2.736
41.750	7.935	2.231	0.802	2.731
41.833	7.935	2.231	0.802	2.726
41.917	7.935	2.231	0.802	2.721
42.000	7.935	2.231	0.802	2.717
42.083	7.935	2.231	0.802	2.712

Time <minutes>	level <feet>	Drawdown Y(t)	ln(Y)	Est. Regression ln(Y) Range
42.167	7.935	2.231	0.802	2.707
42.250	8.002	2.164	0.772	2.703
42.333	8.002	2.164	0.772	2.698
42.417	8.002	2.164	0.772	2.693
42.500	8.002	2.164	0.772	2.688
42.583	8.002	2.164	0.772	2.684
42.667	8.002	2.164	0.772	2.679
42.750	8.002	2.164	0.772	2.674
42.833	8.002	2.164	0.772	2.670
42.917	8.002	2.164	0.772	2.665
43.000	8.002	2.164	0.772	2.660
43.083	8.002	2.164	0.772	2.656
43.167	8.067	2.099	0.742	2.651
43.250	8.067	2.099	0.742	2.647
43.333	8.067	2.099	0.742	2.642
43.417	8.067	2.099	0.742	2.637
43.500	8.067	2.099	0.742	2.633
43.583	8.067	2.099	0.742	2.628
43.667	8.067	2.099	0.742	2.624
43.750	8.067	2.099	0.742	2.619
43.833	8.067	2.099	0.742	2.615
43.917	8.131	2.035	0.710	2.610
44.000	8.131	2.035	0.710	2.605
44.083	8.131	2.035	0.710	2.601
44.167	8.131	2.035	0.710	2.596
44.250	8.131	2.035	0.710	2.592
44.333	8.198	1.968	0.677	2.587
44.417	8.198	1.968	0.677	2.583
44.500	8.198	1.968	0.677	2.578
44.583	8.198	1.968	0.677	2.574
44.667	8.198	1.968	0.677	2.569
44.750	8.198	1.968	0.677	2.565
44.833	8.198	1.968	0.677	2.560
44.917	8.198	1.968	0.677	2.556
45.000	8.198	1.968	0.677	2.551
45.083	8.198	1.968	0.677	2.547
45.167	8.263	1.903	0.643	2.543
45.250	8.263	1.903	0.643	2.538
45.333	8.263	1.903	0.643	2.534
45.417	8.263	1.903	0.643	2.529
45.500	8.263	1.903	0.643	2.525
45.583	8.263	1.903	0.643	2.521
45.667	8.263	1.903	0.643	2.516
45.750	8.263	1.903	0.643	2.512
45.833	8.263	1.903	0.643	2.507
45.917	8.329	1.836	0.608	2.503

Time <minutes>	level <feet>	Drawdown Y(t)	ln(Y)	Est. Regression ln(Y) Range
46.000	8.329	1.836	0.608	2.499
46.083	8.329	1.836	0.608	2.494
46.167	8.329	1.836	0.608	2.490
46.250	8.329	1.836	0.608	2.486
46.333	8.329	1.836	0.608	2.481
46.417	8.329	1.836	0.608	2.477
46.500	8.329	1.836	0.608	2.473
46.583	8.329	1.836	0.608	2.468
46.667	8.329	1.836	0.608	2.464
46.750	8.329	1.836	0.608	2.460
46.833	8.394	1.772	0.572	2.456
46.917	8.394	1.772	0.572	2.451
47.000	8.394	1.772	0.572	2.447
47.083	8.394	1.772	0.572	2.443
47.167	8.394	1.772	0.572	2.438
47.250	8.394	1.772	0.572	2.434
47.333	8.394	1.772	0.572	2.430
47.417	8.394	1.772	0.572	2.426
47.500	8.394	1.772	0.572	2.422
47.583	8.394	1.772	0.572	2.417
47.667	8.394	1.772	0.572	2.413
47.750	8.394	1.772	0.572	2.409
47.833	8.461	1.705	0.533	2.405
47.917	8.461	1.705	0.533	2.400
48.000	8.461	1.705	0.533	2.396
48.083	8.461	1.705	0.533	2.392
48.167	8.461	1.705	0.533	2.388
48.250	8.461	1.705	0.533	2.384
48.333	8.461	1.705	0.533	2.380
48.417	8.461	1.705	0.533	2.376
48.500	8.526	1.640	0.495	2.371
48.583	8.526	1.640	0.495	2.367
48.667	8.526	1.640	0.495	2.363
48.750	8.526	1.640	0.495	2.359
48.833	8.526	1.640	0.495	2.355
48.917	8.526	1.640	0.495	2.351
49.000	8.526	1.640	0.495	2.347
49.083	8.526	1.640	0.495	2.343
49.167	8.526	1.640	0.495	2.339
49.250	8.526	1.640	0.495	2.334
49.333	8.526	1.640	0.495	2.330
49.417	8.592	1.573	0.453	2.326
49.500	8.592	1.573	0.453	2.322
49.583	8.592	1.573	0.453	2.318
49.667	8.592	1.573	0.453	2.314
49.750	8.592	1.573	0.453	2.310

Time <minutes>	level <feet>	Drawdown Y(t)	ln(Y)	Est. Regression ln(Y) Range
49.833	8.592	1.573	0.453	2.306
49.917	8.592	1.573	0.453	2.302
50.000	8.592	1.573	0.453	2.298
50.083	8.592	1.573	0.453	2.294
50.167	8.592	1.573	0.453	2.290
50.250	8.592	1.573	0.453	2.286
50.333	8.592	1.573	0.453	2.282
50.417	8.657	1.509	0.411	2.278
50.500	8.657	1.509	0.411	2.274
50.583	8.657	1.509	0.411	2.270
50.667	8.657	1.509	0.411	2.266
50.750	8.657	1.509	0.411	2.262
50.833	8.657	1.509	0.411	2.258
50.917	8.657	1.509	0.411	2.255
51.000	8.657	1.509	0.411	2.251
51.083	8.657	1.509	0.411	2.247
51.167	8.657	1.509	0.411	2.243
51.250	8.657	1.509	0.411	2.239
51.333	8.722	1.444	0.367	2.235
51.417	8.722	1.444	0.367	2.231
51.500	8.722	1.444	0.367	2.227
51.583	8.722	1.444	0.367	2.223
51.667	8.657	1.509	0.411	2.219
51.750	8.657	1.509	0.411	2.216
51.833	8.722	1.444	0.367	2.212
51.917	8.722	1.444	0.367	2.208
52.000	8.722	1.444	0.367	2.204
52.083	8.722	1.444	0.367	2.200
52.167	8.722	1.444	0.367	2.196
52.250	8.722	1.444	0.367	2.193
52.333	8.722	1.444	0.367	2.189
52.417	8.722	1.444	0.367	2.185
52.500	8.722	1.444	0.367	2.181
52.583	8.722	1.444	0.367	2.177
52.667	8.722	1.444	0.367	2.173
52.750	8.722	1.444	0.367	2.170
52.833	8.722	1.444	0.367	2.166
52.917	8.722	1.444	0.367	2.162
53.000	8.722	1.444	0.367	2.158
53.083	8.722	1.444	0.367	2.155
53.167	8.722	1.444	0.367	2.151
53.250	8.722	1.444	0.367	2.147
53.333	8.722	1.444	0.367	2.143
53.417	8.722	1.444	0.367	2.140
53.500	8.722	1.444	0.367	2.136
53.583	8.722	1.444	0.367	2.132

Time <minutes>	level <feet>	Drawdown Y(t)	ln(Y)	Est. Regression ln(Y) Range
53.667	8.722	1.444	0.367	2.129
53.750	8.722	1.444	0.367	2.125
53.833	8.722	1.444	0.367	2.121
53.917	8.722	1.444	0.367	2.117
54.000	8.722	1.444	0.367	2.114
54.083	8.722	1.444	0.367	2.110
54.167	8.722	1.444	0.367	2.106
54.250	8.722	1.444	0.367	2.103
54.333	8.722	1.444	0.367	2.099
54.417	8.722	1.444	0.367	2.095
54.500	8.722	1.444	0.367	2.092
54.583	8.722	1.444	0.367	2.088
54.667	8.722	1.444	0.367	2.084
54.750	8.722	1.444	0.367	2.081
54.833	8.722	1.444	0.367	2.077
54.917	8.722	1.444	0.367	2.074
55.000	8.722	1.444	0.367	2.070
55.083	8.722	1.444	0.367	2.066
55.167	8.722	1.444	0.367	2.063
55.250	8.789	1.377	0.320	2.059
55.333	8.789	1.377	0.320	2.056
55.417	8.789	1.377	0.320	2.052
55.500	8.722	1.444	0.367	2.048
55.583	8.722	1.444	0.367	2.045
55.667	8.722	1.444	0.367	2.041
55.750	8.722	1.444	0.367	2.038
55.833	8.789	1.377	0.320	2.034
55.917	8.789	1.377	0.320	2.031
56.000	8.789	1.377	0.320	2.027
56.083	8.789	1.377	0.320	2.024
56.167	8.789	1.377	0.320	2.020
56.250	8.789	1.377	0.320	2.017
56.333	8.789	1.377	0.320	2.013
56.417	8.789	1.377	0.320	2.010
56.500	8.789	1.377	0.320	2.006
56.583	8.789	1.377	0.320	2.003
56.667	8.789	1.377	0.320	1.999
56.750	8.789	1.377	0.320	1.996
56.833	8.789	1.377	0.320	1.992
56.917	8.789	1.377	0.320	1.989
57.000	8.789	1.377	0.320	1.985
57.083	8.789	1.377	0.320	1.982
57.167	8.789	1.377	0.320	1.978
57.250	8.789	1.377	0.320	1.975
57.333	8.789	1.377	0.320	1.971
57.417	8.789	1.377	0.320	1.968

Time <minutes>	level <feet>	Drawdown Y(t)	ln(Y)	Est. Regression ln(Y) Range
57.500	8.789	1.377	0.320	1.965
57.583	8.789	1.377	0.320	1.961
57.667	8.789	1.377	0.320	1.958
57.750	8.789	1.377	0.320	1.954
57.833	8.789	1.377	0.320	1.951
57.917	8.789	1.377	0.320	1.947
58.000	8.789	1.377	0.320	1.944
58.083	8.789	1.377	0.320	1.941
58.167	8.789	1.377	0.320	1.937
58.250	8.789	1.377	0.320	1.934
58.333	8.789	1.377	0.320	1.931
58.417	8.789	1.377	0.320	1.927
58.500	8.789	1.377	0.320	1.924
58.583	8.789	1.377	0.320	1.921
58.667	8.789	1.377	0.320	1.917
58.750	8.789	1.377	0.320	1.914
58.833	8.789	1.377	0.320	1.911
58.917	8.789	1.377	0.320	1.907
59.000	8.789	1.377	0.320	1.904
59.083	8.789	1.377	0.320	1.901
59.167	8.789	1.377	0.320	1.897
59.250	8.789	1.377	0.320	1.894
59.333	8.789	1.377	0.320	1.891
59.417	8.853	1.313	0.272	1.887
59.500	8.853	1.313	0.272	1.884
59.583	8.853	1.313	0.272	1.881
59.667	8.853	1.313	0.272	1.878
59.750	8.853	1.313	0.272	1.874
59.833	8.853	1.313	0.272	1.871
59.917	8.853	1.313	0.272	1.868
60.000	8.853	1.313	0.272	1.864
60.083	8.853	1.313	0.272	1.861
60.167	8.853	1.313	0.272	1.858
60.250	8.853	1.313	0.272	1.855
60.333	8.853	1.313	0.272	1.852
60.417	8.853	1.313	0.272	1.848
60.500	8.853	1.313	0.272	1.845
60.583	8.853	1.313	0.272	1.842
60.667	8.853	1.313	0.272	1.839
60.750	8.853	1.313	0.272	1.835
60.833	8.853	1.313	0.272	1.832
60.917	8.853	1.313	0.272	1.829
61.000	8.853	1.313	0.272	1.826
61.083	8.853	1.313	0.272	1.823
61.167	8.853	1.313	0.272	1.820
61.250	8.920	1.246	0.220	1.816

Time <minutes>	level <feet>	Drawdown Y(t)	ln(Y)	Est. Regression ln(Y) Range
61.333	8.920	1.246	0.220	1.813
61.417	8.853	1.313	0.272	1.810
61.500	8.920	1.246	0.220	1.807
61.583	8.920	1.246	0.220	1.804
61.667	8.920	1.246	0.220	1.801
61.750	8.920	1.246	0.220	1.797
61.833	8.920	1.246	0.220	1.794
61.917	8.920	1.246	0.220	1.791
62.000	8.920	1.246	0.220	1.788
62.083	8.920	1.246	0.220	1.785
62.167	8.920	1.246	0.220	1.782
62.250	8.920	1.246	0.220	1.779
62.333	8.920	1.246	0.220	1.776
62.417	8.920	1.246	0.220	1.773
62.500	8.920	1.246	0.220	1.769
62.583	8.920	1.246	0.220	1.766
62.667	8.920	1.246	0.220	1.763
62.750	8.920	1.246	0.220	1.760
62.833	8.920	1.246	0.220	1.757
62.917	8.920	1.246	0.220	1.754
63.000	8.920	1.246	0.220	1.751
63.083	8.920	1.246	0.220	1.748
63.167	8.920	1.246	0.220	1.745
63.250	8.920	1.246	0.220	1.742
63.333	8.920	1.246	0.220	1.739
63.417	8.920	1.246	0.220	1.736
63.500	8.920	1.246	0.220	1.733
63.583	8.985	1.181	0.166	1.730
63.667	8.985	1.181	0.166	1.727
63.750	8.985	1.181	0.166	1.724
63.833	8.985	1.181	0.166	1.721
63.917	8.985	1.181	0.166	1.718
64.000	8.985	1.181	0.166	1.715
64.083	8.985	1.181	0.166	1.712
64.167	8.985	1.181	0.166	1.709
64.250	8.985	1.181	0.166	1.706
64.333	8.985	1.181	0.166	1.703
64.417	8.985	1.181	0.166	1.700
64.500	8.985	1.181	0.166	1.697
64.583	8.985	1.181	0.166	1.694
64.667	8.985	1.181	0.166	1.691
64.750	8.985	1.181	0.166	1.688
64.833	8.985	1.181	0.166	1.685
64.917	8.985	1.181	0.166	1.682
65.000	8.985	1.181	0.166	1.679
65.083	8.985	1.181	0.166	1.676

Time <minutes>	level <feet>	Drawdown Y(t)	ln(Y)	Est. Regression ln(Y) Range
65.167	8.985	1.181	0.166	1.674
65.250	8.985	1.181	0.166	1.671
65.333	8.985	1.181	0.166	1.668
65.417	8.985	1.181	0.166	1.665
65.500	8.985	1.181	0.166	1.662
65.583	9.051	1.114	0.108	1.659
65.667	8.985	1.181	0.166	1.656
65.750	9.051	1.114	0.108	1.653
65.833	9.051	1.114	0.108	1.650
65.917	9.051	1.114	0.108	1.647
66.000	9.051	1.114	0.108	1.645
66.083	9.051	1.114	0.108	1.642
66.167	9.051	1.114	0.108	1.639
66.250	9.051	1.114	0.108	1.636
66.333	9.051	1.114	0.108	1.633
66.417	9.051	1.114	0.108	1.630
66.500	9.051	1.114	0.108	1.627
66.583	9.051	1.114	0.108	1.625
66.667	9.051	1.114	0.108	1.622
66.750	9.051	1.114	0.108	1.619
66.833	9.051	1.114	0.108	1.616
66.917	9.051	1.114	0.108	1.613
67.000	9.051	1.114	0.108	1.611
67.083	9.051	1.114	0.108	1.608
67.167	9.051	1.114	0.108	1.605
67.250	9.051	1.114	0.108	1.602
67.333	9.051	1.114	0.108	1.599
67.417	9.051	1.114	0.108	1.597
67.500	9.051	1.114	0.108	1.594
67.583	9.051	1.114	0.108	1.591
67.667	9.051	1.114	0.108	1.588
67.750	9.051	1.114	0.108	1.585
67.833	9.051	1.114	0.108	1.583
67.917	9.051	1.114	0.108	1.580
68.000	9.051	1.114	0.108	1.577
68.083	9.051	1.114	0.108	1.574
68.167	9.051	1.114	0.108	1.572
68.250	9.051	1.114	0.108	1.569
68.333	9.116	1.050	0.048	1.566
68.417	9.116	1.050	0.048	1.564
68.500	9.116	1.050	0.048	1.561
68.583	9.116	1.050	0.048	1.558
68.667	9.116	1.050	0.048	1.555
68.750	9.116	1.050	0.048	1.553
68.833	9.116	1.050	0.048	1.550
68.917	9.116	1.050	0.048	1.547

Time <minutes>	level <feet>	Drawdown Y(t)	ln(Y)	Est. Regression ln(Y) Range
69.000	9.116	1.050	0.048	1.545
69.083	9.116	1.050	0.048	1.542
69.167	9.116	1.050	0.048	1.539
69.250	9.116	1.050	0.048	1.537
69.333	9.116	1.050	0.048	1.534
69.417	9.116	1.050	0.048	1.531
69.500	9.116	1.050	0.048	1.529
69.583	9.116	1.050	0.048	1.526
69.667	9.116	1.050	0.048	1.523
69.750	9.116	1.050	0.048	1.521
69.833	9.116	1.050	0.048	1.518
69.917	9.116	1.050	0.048	1.515
70.000	9.116	1.050	0.048	1.513
70.083	9.116	1.050	0.048	1.510
70.167	9.116	1.050	0.048	1.507
70.250	9.116	1.050	0.048	1.505
70.333	9.116	1.050	0.048	1.502
70.417	9.116	1.050	0.048	1.499
70.500	9.116	1.050	0.048	1.497
70.583	9.181	0.985	-0.015	1.494
70.667	9.181	0.985	-0.015	1.492
70.750	9.181	0.985	-0.015	1.489
70.833	9.181	0.985	-0.015	1.486
70.917	9.181	0.985	-0.015	1.484
71.000	9.181	0.985	-0.015	1.481
71.083	9.181	0.985	-0.015	1.479
71.167	9.181	0.985	-0.015	1.476
71.250	9.181	0.985	-0.015	1.474
71.333	9.181	0.985	-0.015	1.471
71.417	9.181	0.985	-0.015	1.468
71.500	9.181	0.985	-0.015	1.466
71.583	9.181	0.985	-0.015	1.463
71.667	9.181	0.985	-0.015	1.461
71.750	9.181	0.985	-0.015	1.458
71.833	9.181	0.985	-0.015	1.456
71.917	9.181	0.985	-0.015	1.453
72.000	9.181	0.985	-0.015	1.451
72.083	9.181	0.985	-0.015	1.448
72.167	9.181	0.985	-0.015	1.446
72.250	9.181	0.985	-0.015	1.443
72.333	9.181	0.985	-0.015	1.441
72.417	9.181	0.985	-0.015	1.438
72.500	9.181	0.985	-0.015	1.436
72.583	9.181	0.985	-0.015	1.433
72.667	9.181	0.985	-0.015	1.431
72.750	9.181	0.985	-0.015	1.428

APPENDIX E

**DATA FROM GROUNDWATER MONITORING
AND PREVIOUS INVESTIGATIONS**

Table 1
Summary of Analytical Results - Groundwater Grab Sampling
Cargill Salt, Alameda Facility

Transect Sample Designation	Sample Depth ft. bgs	Analytical Results ¹				
		PCE ug/l	TCE ug/l	1,1-DCE ug/l	c-1,2-DCE ug/l	1,1,1-TCA ug/l
B-1-7.5	7.0-8.0	1250	<50.0	<50.0	<50.0	<50.0
B-1-11.5	10.5-12.0	2090	<100	<100	<100	<100
B-1-16.5	14.5-17.0	33.1	<1.00	<1.00	<1.00	<1.00
B-1-22.5	21.0-23.0	4.01	<0.500	<0.500	<0.500	<0.500
B-2-7.5	7.0-8.0	102	<5.00	<5.00	<5.00	<5.00
B-2-11.5	10.0-13.0	25.5	<1.00	<1.00	<1.00	<1.00
B-2-16.5	15.5-17.0	0.532	<0.500	<0.500	<0.500	<0.500
B-2-22.5	21.0-23.0	0.613	<0.500	<0.500	<0.500	<0.500
B-2-27.5	27.0-28.0	<0.500	<0.500	<0.500	<0.500	<0.500
B-3-6.5	5.0-7.5	59.6	<2.50	<2.50	<2.50	<2.50
B-3-11.5	10.0-13.0	<0.500	<0.500	<0.500	<0.500	<0.500
B-3-16.5	15.0-17.0	<0.500	<0.500	<0.500	<0.500	<0.500
B-3-22.5	21.0-23.0	2.16	<0.500	<0.500	<0.500	<0.500
B-4-6.5	5.0-7.0	73.1	<2.50	<2.50	<2.50	<2.50
B-4-11.5	9.0-12.5	1.86	<0.500	<0.500	<0.500	<0.500
B-4-16.5	15.5-17.5	<0.500	<0.500	<0.500	<0.500	<0.500
B-4-22.5	21.5-23.5	<0.500	<0.500	<0.500	<0.500	<0.500
B-5-6.5	5.0-7.5	0.723	3.90	<0.500	<0.500	<0.500
B-5-11.5	10.5-12.5	<0.500	<0.500	<0.500	<0.500	<0.500
B-5-16.5	15.5-17.5	<0.500	<0.500	<0.500	<0.500	<0.500
B-5-22.5	21.5-23.5	<0.500	<0.500	<0.500	<0.500	<0.500
B-6-5.0	4.0-6.0	1.09	11.6	<0.500	0.87	<0.500
B-6-10.0	9.0-11.0	<0.500	<0.500	<0.500	<0.500	<0.500
B-6-15.0	14.0-16.0	<0.500	<0.500	<0.500	<0.500	<0.500
B-6-21.0	20.0-22.0	<0.500	<0.500	<0.500	<0.500	<0.500
B-7-6.5	5.0-7.5	29.8	2.66	<1.00	<1.00	<1.00
B-7-11.5	10.5-12.5	177	19.1	<2.50	<2.50	<2.50
B-7-16.5	15.0-18.0	406	41.2	<10.0	<10.0	<10.0
B-7-22.5	21.5-23.5	<0.500	<0.500	<0.500	<0.500	<0.500
B-8-6.5	5.0-7.5	20.5	0.867	<0.500	<0.500	<0.500
B-8-11.5	11.0-11.5	90.5 ^{2,3}	12.5	<0.500	<0.500	0.664 ⁴
B-8-16.5	15.0-18.0	503	75.6	<10.0	<10.0	<10.0
B-8-22.5	21.5-23.5	278	51.2	<5.00	<5.00	<5.00
B-9-6.5	5.0-7.5	58.8	3.21	<2.50	<2.50	<2.50
B-9-11.5	10.0-13.0	327	47.4	<10.0	<10.0	<10.0
B-9-16.5	15.0-18.0	1100	227	<25.0	<25.0	<25.0
B-9-22.5	21.5-23.5	0.672	<0.500	<0.500	<0.500	<0.500
B-10-6.5	5.0-7.5	386	34.4	<10.0	<10.0	<10.0
B-10-11.5	10.0-13.0	1600	266	<50.0	<50.0	<50.0
B-10-16.5	15.0-18.0	823	178	<25.0	<25.0	<25.0
B-10-22.5	21.5-23.5	1.91	<0.500	<0.500	<0.500	<0.500
B-11-6.5	5.0-7.5	574	44.0	<12.5	<12.5	<12.5
B-11-11.5	10.0-13.0	576	152	10.9	<10.0	<10.0
B-11-16.5	15.0-18.0	316	64.4	6.04	<5.00	<5.00
B-11-22.5	21.5-23.5	1.02	<0.500	<0.500	<0.500	<0.500
B-12-6.5	5.0-7.5	147	6.80	<5.00	<5.00	<5.00
B-12-11.5	10.0-13.0	275	46.7	<5.00	<5.00	<5.00
B-12-16.5	15.0-18.0	411	84.8	<10.0	<10.0	<10.0
B-12-22.5	21.5-23.5	0.575	<0.500	<0.500	<0.500	<0.500

Notes:

ft. bgs = feet below ground surface

PCE = Tetrachloroethene

TCE = Trichloroethene

1,1-DCE = 1,1-Dichloroethene

c-1,2-DCE = cis-1,2-Dichloroethene

1,1,1-TCA = 1,1,1-Trichloroethane

ug/l = concentration in micrograms per liter

¹ Groundwater sampled by EPA Method 8021B, only Method 8010 list reported,

all other Method 8010 list constituents not reported in this table are below the reporting limit

² This value is considered an estimate

³ Due to insufficient sample availability, a dilution could not be analyzed on this sample

⁴ Due to insufficient sample availability, a confirmation could not be analyzed for this sample

Table 2. Summary of Groundwater Monitoring Well Data

Well No. Field Date	MW-1								
	11/16/1999	3/30/2000	5/16/2000	7/28/2000	11/30/2000	3/26/2001	6/25/2001	9/28/2001	12/17/2001
DCE	<50.0	13	<10	15	14	<13	14	15	<13
CFC 113	na	1.4	<10	<10	<8.3	<50	<50	<50	<50
DCA	<50.0	0.8	<10	<10	<4.2	<13	<13	<13	<13
Chloroform	<50.0	0.6*	<10	<10	<8.3	<13	<13	<13	<13
TCA	<50.0	1.6	<10	<10	<4.2	<13	<13	<13	<13
TCE	178	150	190	170	130	180	250	210	190
PCE	906	1,400	1,900	1,200	880	1,000	1,400	1,000	1,400
All other 8010/8021B analyte	nd	nd	nd	nd	nd	nd	nd	nd	nd

Notes and abbreviations:

All values in micrograms per liter [$\mu\text{g/L}$]

CFC 113 = Trichlorotrifluoroethane

DCA = 1,1-Dichloroethane

DCE = 1,1-Dichloroethene

nd = not detected

na = not analyzed

ne = not established or none applicable

PCE = Tetrachloroethene

TCA = 1,1,1-Trichloroethane

TCE = Trichloroethene

* Chloroform detected in equipment blank at 1.6 $\mu\text{g/L}$

Table 2. Summary of Groundwater Monitoring Well Data

Well No. Field Date	MW-2								
	11/16/1999	3/30/2000	5/16/2000	7/28/2000	11/30/2000	3/26/2001	6/25/2001	9/28/2001	12/17/2001
DCE	<50.0	<0.5	<25	<25	<8.3	<25	<25	<25	<25
CFC 113	na	<0.5	<25	<25	<17	<100	<100	<100	<100
DCA	<50.0	<0.5	<25	<25	<8.3	<25	<25	<25	<25
Chloroform	<50.0	<0.5	<25	<25	<17	<25	<25	<25	<25
TCA	<50.0	5.0	<25	<25	<8.3	<25	<25	<25	<25
TCE	<50	29	53	<25	20	40	78	<25	<25
PCE	840	3,600	3,200	3,300	1,700	2,200	4,400	1,700	1,700
All other 8010/8021B analyte	nd	nd	nd	nd	nd	nd	nd	nd	nd

Notes and abbreviations:

All values in micrograms per liter [$\mu\text{g/L}$]

CFC 113 = Trichlorotrifluoroethane

DCA = 1,1-Dichloroethane

DCE = 1,1-Dichloroethene

nd = not detected

na = not analyzed

ne = not established or none applicable

PCE = Tetrachloroethene

TCA = 1,1,1-Trichloroethane

TCE = Trichloroethene

Table 2. Summary of Groundwater Monitoring Well Data

Well No. Field Date	MW-3									MW-4
	11/16/1999	3/30/2000	5/16/2000	7/28/2000	11/30/2000	3/26/2001	6/25/2001	9/28/2001	12/17/2001	12/17/2001
DCE	<0.500	<0.5	<0.5	<0.5	<0.5	<0.5	<0.5	<0.5	<0.5	<0.5
CFC 113	na	<0.5	<0.5	<0.5	<1.0	<2.0	<2.0	<2.0	<2.0	<2.0
DCA	<0.500	<0.5	<0.5	<0.5	<0.5	<0.5	<0.5	<0.5	<0.5	<0.5
Chloroform	<0.500	<0.5	<0.5	<0.5	<1.0	<0.5	<0.5	<0.5	<0.5	<0.5
TCA	<0.500	<0.5	<0.5	<0.5	<0.5	<0.5	<0.5	<0.5	<0.5	<0.5
TCE	<0.500	<0.5	<0.5	<0.5	<0.5	<0.5	<0.5	<0.5	<0.5	<0.5
PCE	<0.500	<0.5	<0.5	0.8	<0.5	<0.5	<0.5	<0.5	0.81	2.6
All other 8010/8021B analyte	nd	nd	nd	nd	nd	nd	nd	nd	nd	nd

Notes and abbreviations:
 All values in micrograms per liter [$\mu\text{g/L}$]
 CFC 113 = Trichlorotrifluoroethane
 DCA = 1,1-Dichloroethane
 DCE = 1,1-Dichloroethene
 nd = not detected
 na = not analyzed
 ne = not established or none applicable
 PCE = Tetrachloroethene
 TCA = 1,1,1-Trichloroethane
 TCE = Trichloroethene

Table 3. Groundwater Level Data

Well/ Piezometer	Date	Time	Casing Elevation (feet, MSL)	Depth to Water (feet)	Water Elevation (feet, MSL)	Elev. Change from Last Measurement
MW-1	11/16/1999	09:56	6.75	3.75	3.00	NA
MW-1	3/30/2000	10:09	6.75	2.81	3.94	0.94
MW-1	5/16/2000	09:43	6.75	3.32	3.43	-0.51
MW-1	7/28/2000	09:11	6.75	3.58	3.17	-0.26
MW-1	11/30/2000	08:36	6.75	3.52	3.23	0.06
MW-1	3/26/2001	08:47	6.75	3.15	3.60	0.37
MW-1	6/25/2001	10:19	6.75	3.53	3.22	-0.38
MW-1	9/28/2001	09:32	6.75	3.96	2.79	-0.43
MW-1	12/17/2001	10:47	6.75	3.23	3.52	0.73
MW-2	11/16/1999	11:15	9.81	5.22	4.59	NA
MW-2	3/30/2000	10:05	9.81	2.80	7.01	2.42
MW-2	5/16/2000	09:35	9.81	4.13	5.68	-1.33
MW-2	7/28/2000	09:17	9.81	4.85	4.96	-0.72
MW-2	11/30/2000	08:32	9.81	4.75	5.06	0.10
MW-2	3/26/2001	08:40	9.81	3.28	6.53	1.47
MW-2	6/25/2001	12:12	9.81	4.75	5.06	-1.47
MW-2	9/28/2001	12:20	9.81	5.41	4.40	-0.66
MW-2	12/17/2001	10:44	9.81	4.07	5.74	1.34
MW-3	11/16/1999	15:43	6.92	4.34	2.58	NA
MW-3	3/30/2000	10:01	6.92	2.77	4.15	1.57
MW-3	5/16/2000	09:46	6.92	3.44	3.48	-0.67
MW-3	7/28/2000	09:05	6.92	3.72	3.20	-0.28
MW-3	11/30/2000	08:34	6.92	3.73	3.19	-0.01
MW-3	3/26/2001	08:54	6.92	3.51	3.41	0.22
MW-3	6/25/2001	10:21	6.92	3.65	3.27	-0.14
MW-3	9/28/2001	09:30	6.92	3.96	2.96	-0.31
MW-3	12/17/2001	10:38	6.92	3.28	3.64	0.68
MW-4	12/17/2001	10:40	6.01	2.55	3.46	NA

Key:

NA = Not available

feet, MSL = feet, relative to Mean Sea Level

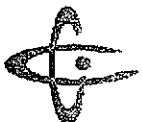
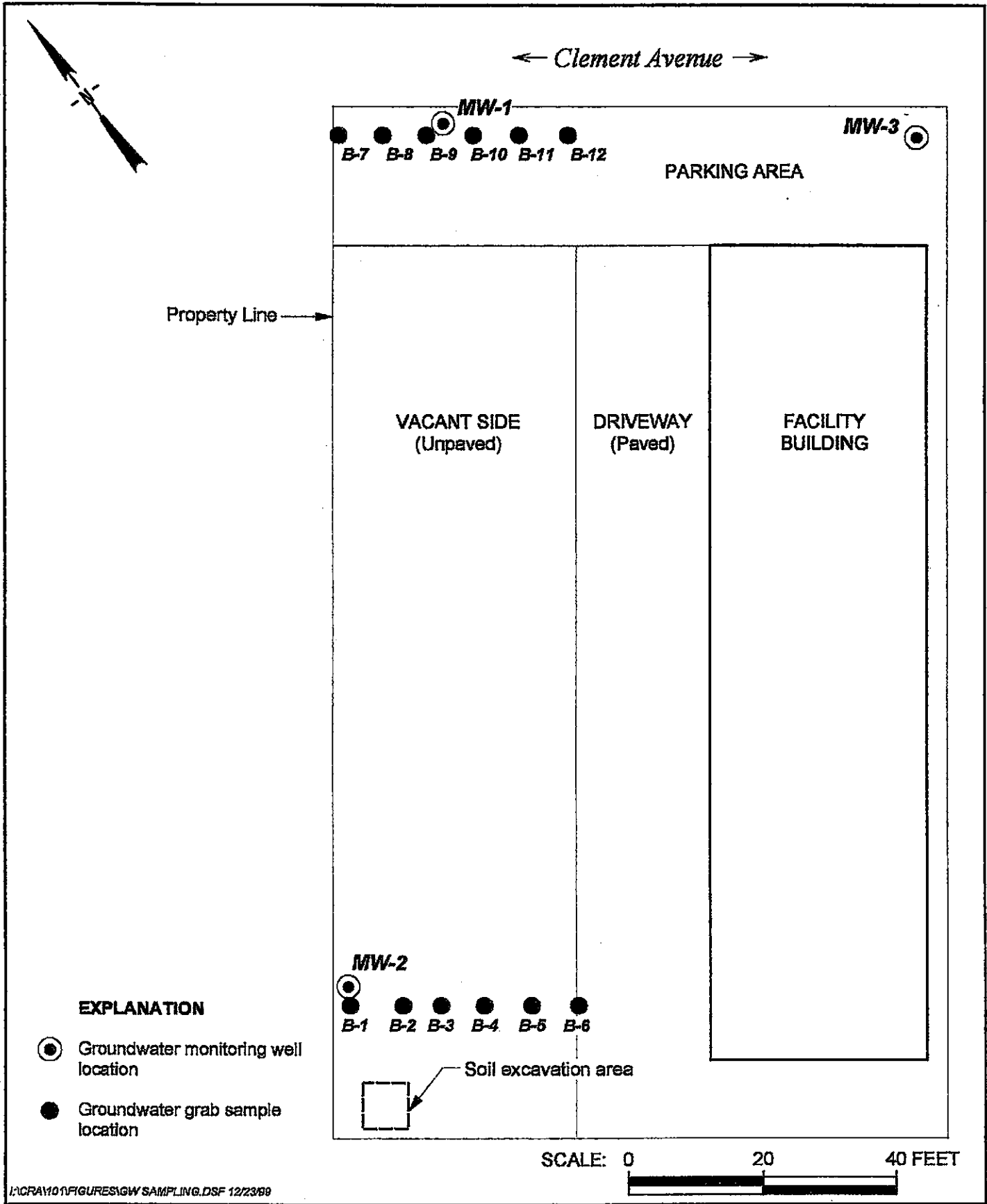

**CRAWFORD
CONSULTING
INC.**

Cargill Salt Dispensing Systems Division
 2016 Clement Avenue, Alameda, California
**Figure 2. Groundwater Sampling and Monitoring Well
 Locations**

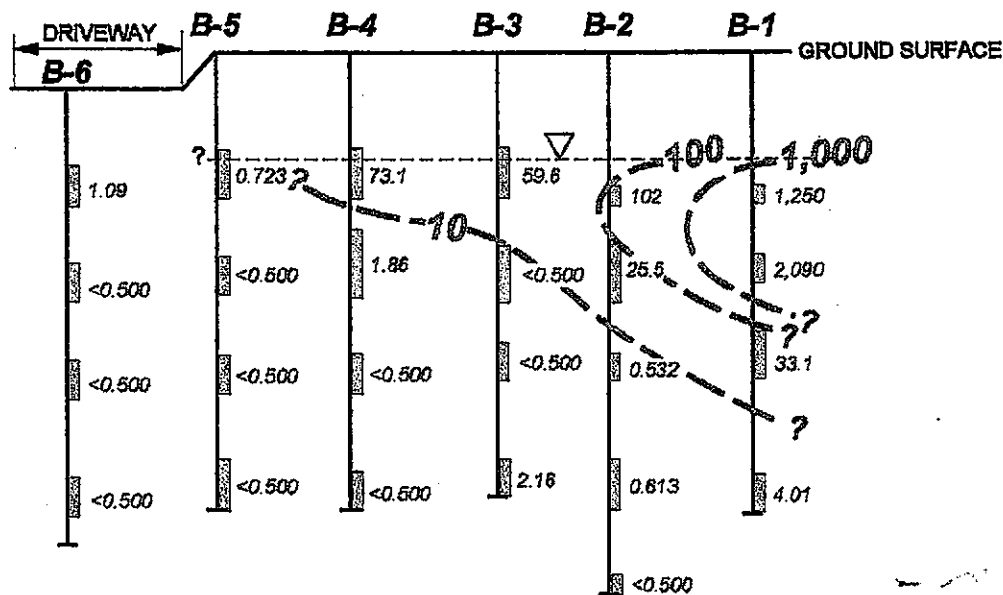

TRANSECT B-1 TO B-6 PCE CONCENTRATIONS (ug/L)
(LOOKING SOUTHWARD)

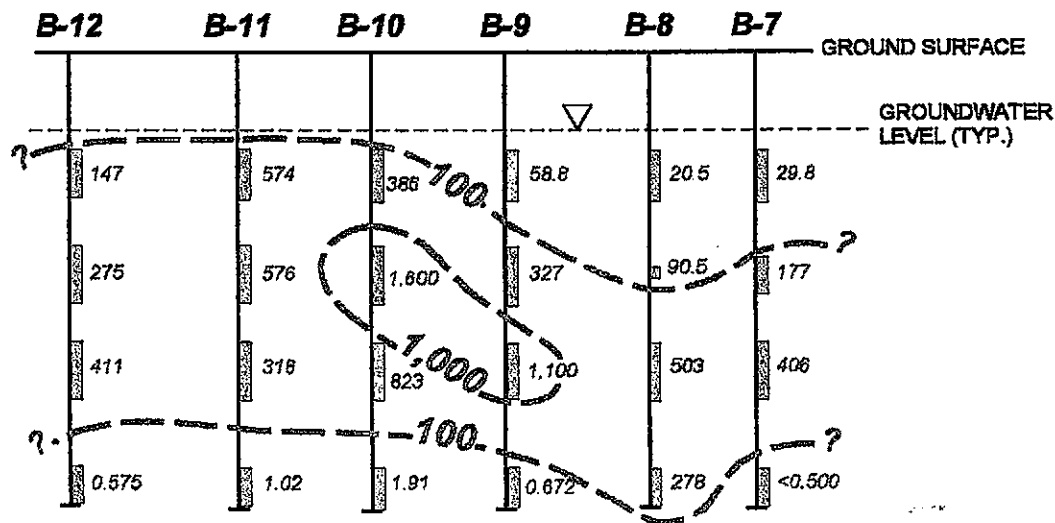

TRANSECT B-7 TO B-12 PCE CONCENTRATIONS (ug/L)
(LOOKING SOUTHWARD)

EXPLANATION

- B-6 — Boring designation
- 1.09 — Sample interval showing PCE concentration (ug/L)
- 10 — PCE isoconcentration contour (ug/L)

SCALE: 0 10 FEET

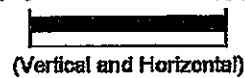

I:\CRA\101\FIGURES\PCE IN GW.DSF 1/4/00



**CRAWFORD
CONSULTING
INC.**

Cargill Salt Dispensing Systems Division
2016 Clement Avenue, Alameda, California
Figure 3. Transect PCE Concentrations in Groundwater

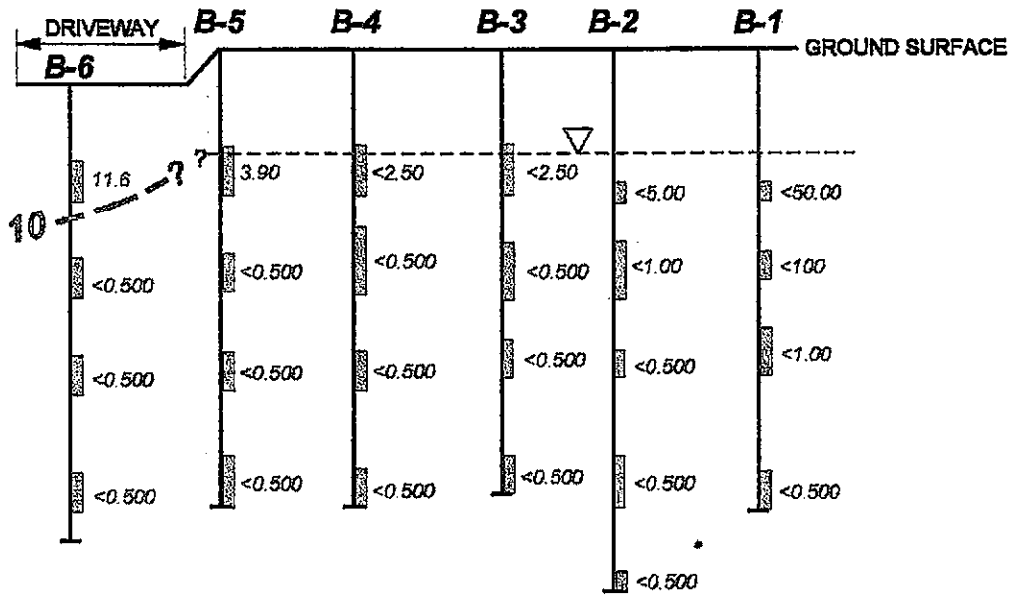

TRANSECT B-1 TO B-6 TCE CONCENTRATIONS (ug/L)
(LOOKING SOUTHWARD)

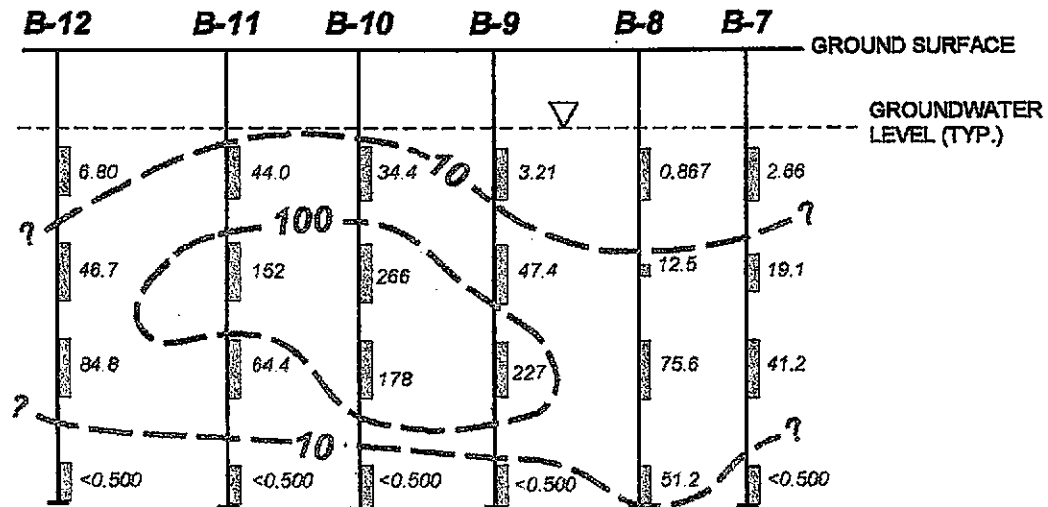

TRANSECT B-7 TO B-12 TCE CONCENTRATIONS (ug/L)
(LOOKING SOUTHWARD)

EXPLANATION

- B-6 — Boring designation
- 11.6 — Sample interval showing TCE concentration (ug/L)
- 10 — TCE isoconcentration contour (ug/L)

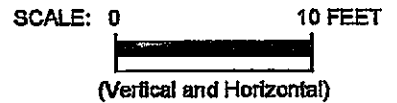

I:\CRAW\01\FIGURES\TCE IN GW.DSF 1/1/00



**CRAWFORD
CONSULTING
INC.**

Cargill Salt Dispensing Systems Division
2016 Clement Avenue, Alameda, California
Figure 4. Transect TCE Concentrations in Groundwater

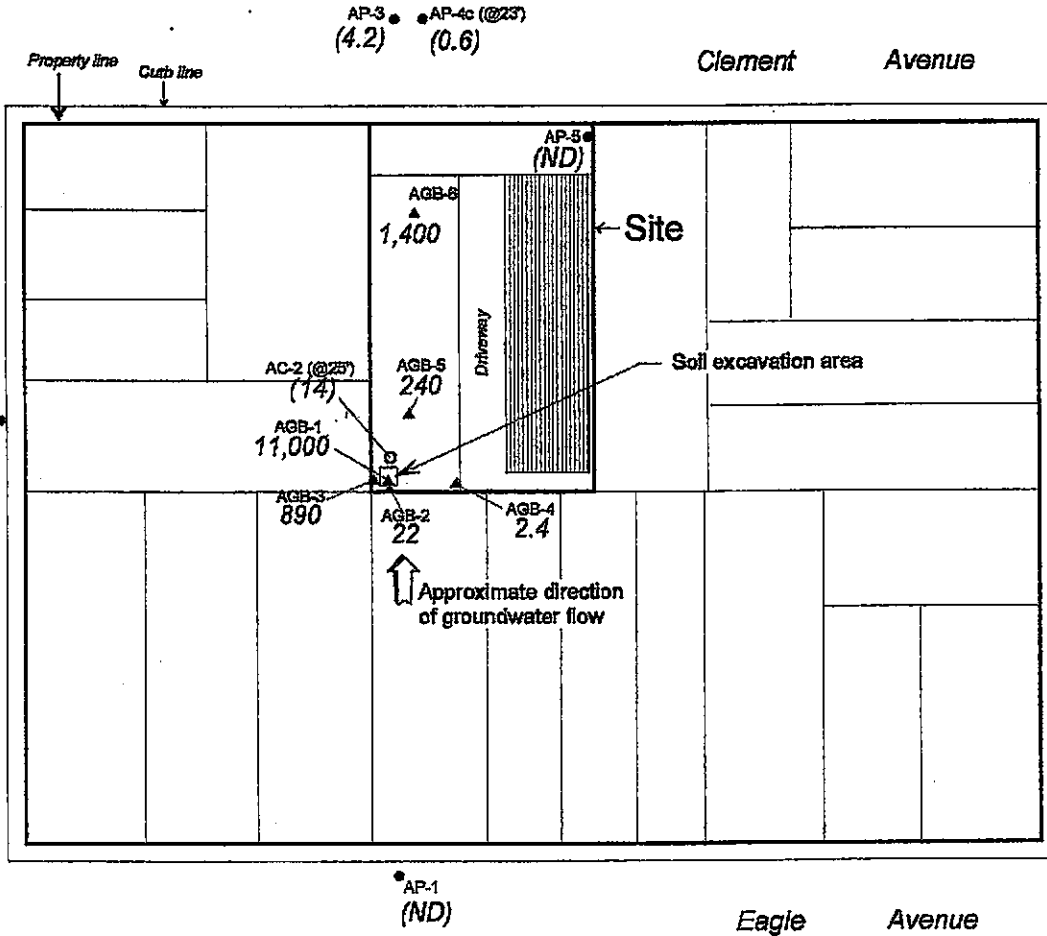

Explanation

- ▲ AGB-5 Hand-augered groundwater sampling boring (Oct-93)
- AP-1 Groundwater sampling probe (Sept-94)
- AC-2 Soil-core boring grab sample (Sept-94)
- 240 PCE concentration (µg/L) in groundwater (Oct-93)
- (4.2) PCE concentration (µg/L) in groundwater (Sept-94)
- ND Not detected

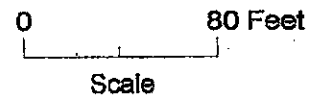

I:\CRA\FIGURES\PCE9394-FIG5.DSF 1/3/00



**CRAWFORD
CONSULTING
INC.**

Cargill Salt Dispensing Systems Division
2016 Clement Avenue, Alameda, California
**Figure 5. PCE Concentrations in Groundwater
(October 1993 and September 1994)**

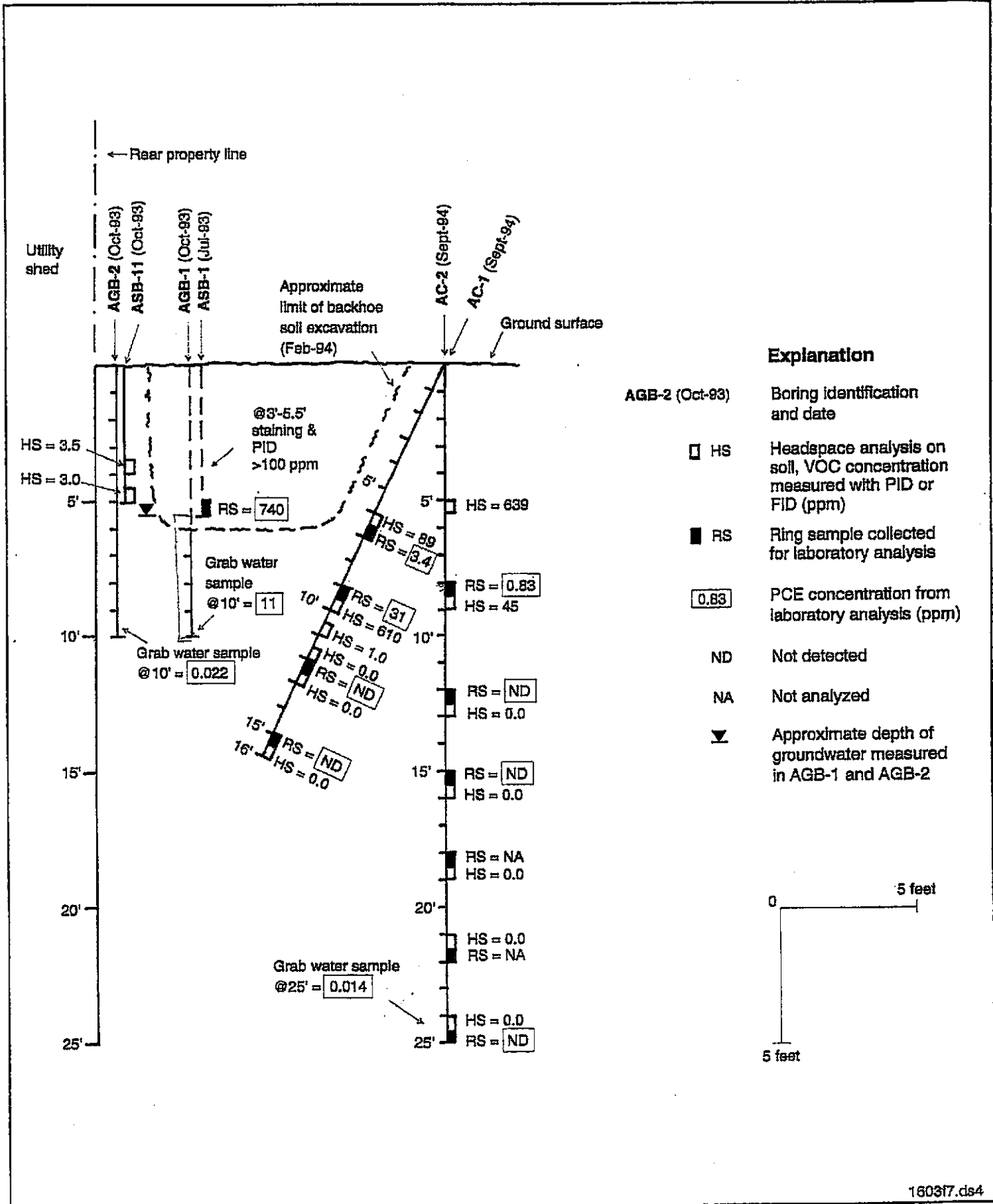

160317.ds4