



November 27, 1991
Sample Log 3575

Paul Ferreira
Scott Company
1919 Market Street
Oakland, CA 94607

Subject: Analytical Results for 3 Soil sample(s)
Identified as: Coulter Steel
Received: 11/26/91
Purchase Order: 95332-50680-73-7001

Dear Mr. Ferreira:

Analysis of the sample(s) referenced above has been completed. This report is written to confirm results communicated on November 27, 1991 and describes procedures used to analyze the samples.

Sample(s) were received in brass sleeves that were sealed with PTFE sheets and plastic endcaps. Each sample was transported and received under documented chain of custody and stored at 4 degrees C until analysis was performed.

Sample(s) were analyzed using the following method(s):

"TPH as Diesel, Motor Oil, Jet/Kerosene" (Mod. 8015/Extraction)

Please refer to the following table(s) for summarized analytical results and contact us at 916-757-4650 if you have questions regarding procedures or results. The chain-of-custody document is enclosed.

Approved by:

Stewart Podolsky
Senior Chemist



November 27, 1991
Sample Log 3575

Table 1: TPH Results for 3 Soil Sample(s)
From : Coulter Steel
Received 11/26/91

--all concentrations are units of mg/kg--

Sample	Product ID and Conc.
S1	Diesel: 630 Motor Oil: <10
S4	Diesel: 670 Motor Oil: <10
Composite 1	Diesel: 1300 Motor Oil: <10
1A	
1B	
1C	
1D	
(Reporting Limit	10)

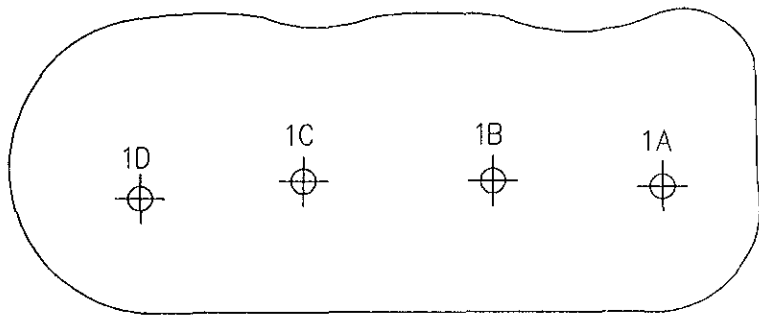

STOCKPILE
5 FEET HIGH

EXCAVATION
10.5 FEET DEEP

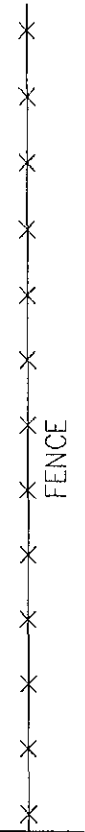
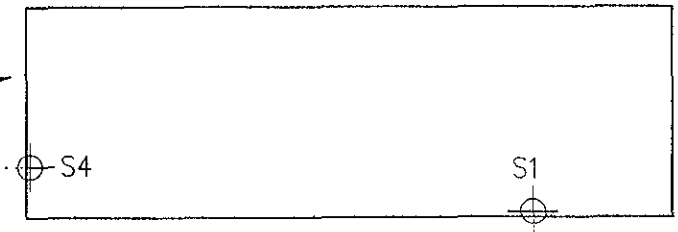

NOTES.

- ▷ Samples S1 and S4 were taken from the sidewalls at the soil/water interface, 10 feet below grade.
- ▷ There is no sample S2.
- ▷ Sample S3 is not to be analyzed; therefore its location is not indicated.
- ▷ Samples 1A through 1D were composited in the laboratory.

FOLGER AVENUE

COULTER STEEL (SCOTT CO.)
722 FOLGER AVENUE
BERKELEY, CALIFORNIA

Sample Log#: 3575
DATE: 11/26/1991
SCALE 1:120

WEST Western Environmental
Science & Technology
1046 Olive Drive #3, Davis, CA 95616
Phone: (916) 753-9500

Drawn by: TGT

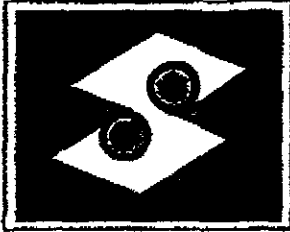

SCOTT CO.

MECHANICAL CONTRACTORS
1919 Market Street
P.O. Box 12954
Oakland, California 94604
(415) 834-2333

Contractors License No. 184480

TELECOPY COVER SHEET

DATE: 12-19-91

COMPANY TO: Alameda County Environmental Health

ATTENTION: Susan Halgo

FROM: Michael Schwickert - Staff

NUMBER OF PAGES BEING SENT (INCLUDING THIS COVER SHEET). 5

PLEASE CONTACT Michael AT (415 834-2333, EXT. 3455
IF YOU HAVE ANY QUESTIONS.

SCOTT CO. FAX FOR 2014 MARKET STREET (THIS LOCATION) IS (415) 763-0106.

COMMENTS:



November 27, 1991
Sample Log 3575

Paul Ferreira
Scott Company
1919 Market Street
Oakland, CA 94607

Subject: Analytical Results for 3 Soil sample(s)
Identified as: Coulter Steel
Received: 11/26/91
Purchase Order: 95332-50680-73-7001

Dear Mr. Ferreira:

Analysis of the sample(s) referenced above has been completed. This report is written to confirm results communicated on November 27, 1991 and describes procedures used to analyze the samples.

Sample(s) were received in brass sleeves that were sealed with PTFE sheets and plastic endcaps. Each sample was transported and received under documented chain of custody and stored at 4 degrees C until analysis was performed.

Sample(s) were analyzed using the following method(s):

"TPH as Diesel, Motor Oil, Jet/Kerosene" (Mod. 8015/Extraction)

Please refer to the following table(s) for summarized analytical results and contact us at 916-757-4650 if you have questions regarding procedures or results. The chain-of-custody document is enclosed.

Approved by:

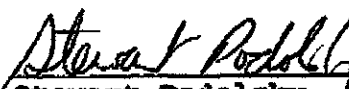
Stewart Podolsky
Senior Chemist



November 27, 1991
 Sample Log 3575

Table 1: TPH Results for 3 Soil Sample(s)
From : Coulter Steel
Received 11/26/91

--all concentrations are units of mg/kg--

Sample	Product ID and Conc.
S1	Diesel: 630 Motor Oil: <10
S4	Diesel: 670 Motor Oil: <10
Composite 1	Diesel: 1300 Motor Oil: <10
1A	
1B	
1C	
1D	
(Reporting Limit	10)

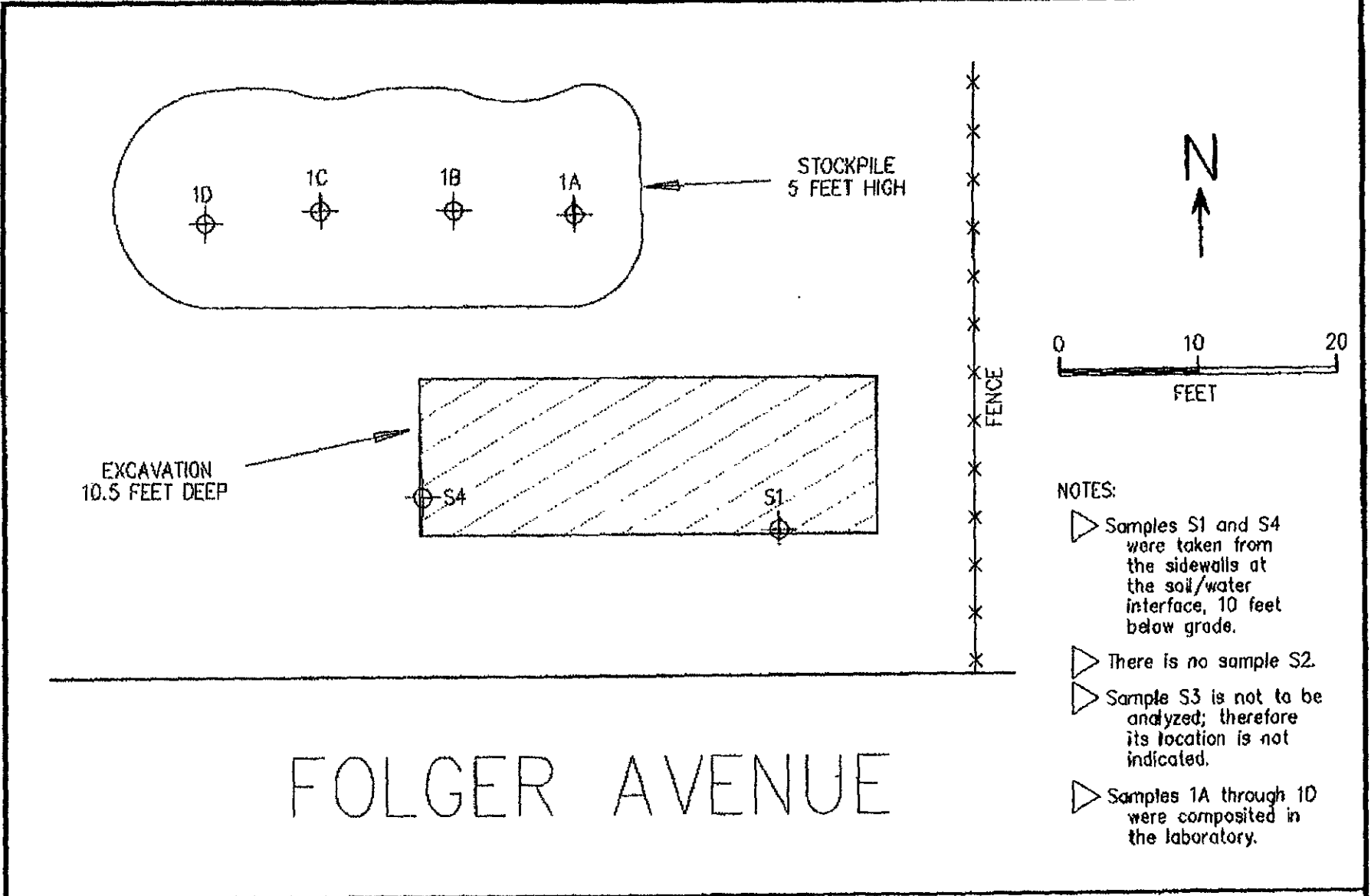

- NOTES:
- ▷ Samples S1 and S4 were taken from the sidewalls at the soil/water interface, 10 feet below grade.
 - ▷ There is no sample S2.
 - ▷ Sample S3 is not to be analyzed; therefore its location is not indicated.
 - ▷ Samples 1A through 1D were composited in the laboratory.

COULTER STEEL (SCOTT CO.) 722 FOLGER AVENUE BERKELEY, CALIFORNIA	Sample Log#: 3575 DATE: 11/26/1991	 Western Environmental Science & Technology 1046 Olive Drive #3, Davis, CA 95616 Phone: (916) 753-9500
	SCALE 1:120	

