

ALAMEDA COUNTY  
HEALTH CARE SERVICES  
AGENCY  
ALEX BRISCOE, Agency Director



ENVIRONMENTAL HEALTH SERVICES  
ENVIRONMENTAL PROTECTION  
1131 Harbor Bay Parkway, Suite 250  
Alameda, CA 94502-6577  
(510) 567-6700  
FAX (510) 337-9335

August 6, 2010

Mr. Denis Brown  
Shell Oil Products US  
20945 S. Wilmington Ave.  
Carson, CA 90810-1039

Subject: Case Closure for Fuel Leak Case No. RO0000495 and Geotracker Global ID T0600101246, Shell #13-5765, 29 Wildwood Avenue, Piedmont, CA 94610

Dear Mr. Brown:

This letter transmits the enclosed underground storage tank (UST) case closure letter in accordance with Chapter 6.75 (Article 4, Section 25299.37[h]). The State Water Resources Control Board adopted this letter on February 20, 1997. As of March 1, 1997, the Alameda County Environmental Health (ACEH) is required to use this case closure letter for all UST leak sites. We are also transmitting to you the enclosed case closure summary. These documents confirm the completion of the investigation and cleanup of the reported release at the subject site. The subject fuel leak case is closed. This case closure letter and the case closure summary can also be viewed on the State Water Resources Control Board's Geotracker website (<http://geotracker.swrcb.ca.gov>) and the Alameda County Environmental Health website (<http://www.acgov.org/aceh/index.htm>).

#### SITE INVESTIGATION AND CLEANUP SUMMARY

Please be advised that the following conditions exist at the site:

- Total Petroleum Hydrocarbons as gasoline remain in soil at concentrations up to 6,500 ppm.
- Total Petroleum Hydrocarbons as gasoline remain in groundwater at concentrations up to 1,800 ppb.
- As described in section IV of the attached Case Closure Summary, the case was closed with Site Management Requirements that limit future land use to commercial land use only.

If you have any questions, please call Jerry Wickham at (510) 567-6791. Thank you.

Sincerely,

A handwritten signature in black ink, appearing to read "Donna L. Drogos".

Donna L. Drogos, P.E.  
Division Chief

Enclosures:

1. Remedial Action Completion Certification
2. Case Closure Summary

cc:

Leroy Griffin (w/enc)  
Oakland Fire Department  
250 Frank H. Ogawa Plaza, Ste. 3341  
Oakland, CA 94612-2032  
(Sent via E-mail to: [lgriffin@oaklandnet.com](mailto:lgriffin@oaklandnet.com)),

Closure Unit (w/enc)  
State Water Resources Control Board  
UST Cleanup Fund  
P.O. Box 944212  
Sacramento, CA 94244-2120

Peter Schaefer (w/enc)  
Conestoga-Rovers & Associates  
5900 Hollis Street, Suite A  
Emeryville, CA 94608  
(Sent via E-mail to: [pschaefer@croworld.com](mailto:pschaefer@croworld.com))

Donna Drogos, ACEH (Sent via E-mail to: [donna.drogos@acgov.org](mailto:donna.drogos@acgov.org))  
Jerry Wickham, ACEH (w/o enc)

Geotracker (w/enc)  
File (w/orig enc)



ENVIRONMENTAL HEALTH SERVICES  
ENVIRONMENTAL PROTECTION  
1131 Harbor Bay Parkway, Suite 250  
Alameda, CA 94502-6577  
(510) 567-6700  
FAX (510) 337-9335

**REMEDIAL ACTION COMPLETION CERTIFICATION**

August 6, 2010

Mr. Denis Brown  
Shell Oil Products US  
20945 S. Wilmington Ave.  
Carson, CA 90810-1039

Subject: Case Closure for Fuel Leak Case No. RO0000495 and Geotracker Global ID T0600101246,  
Shell #13-5765, 29 Wildwood Avenue, Piedmont, CA 94610

Dear Mr. Brown:

This letter confirms the completion of a site investigation and remedial action for the underground storage tanks formerly located at the above-described location. Thank you for your cooperation throughout this investigation. Your willingness and promptness in responding to our inquiries concerning the former underground storage tank(s) are greatly appreciated.

Based on information in the above-referenced file and with the provision that the information provided to this agency was accurate and representative of site conditions, this agency finds that the site investigation and corrective action carried out at your underground storage tank(s) site is in compliance with the requirements of subdivisions (a) and (b) of Section 25296.10 of the Health and Safety Code and with corrective action regulations adopted pursuant to Section 25299.3 of the Health and Safety Code and that no further action related to the petroleum release(s) at the site is required.

This notice is issued pursuant to subdivision (h) of Section 25296.10 of the Health and Safety Code. Please contact our office if you have any questions regarding this matter.

Sincerely,

  
Ariu Levi  
Director  
Alameda County Environmental Health

**CASE CLOSURE SUMMARY  
LEAKING UNDERGROUND FUEL STORAGE TANK - LOCAL OVERSIGHT PROGRAM**

**I. AGENCY INFORMATION**

Date: March 30, 2010

Agency Name: Alameda County Environmental Health	Address: 1131 Harbor Bay Parkway
City/State/Zip: Alameda, CA 94502-6577	Phone: (510) 567-6791
Responsible Staff Person: Jerry Wickham	Title: Senior Hazardous Materials Specialist

**II. CASE INFORMATION**

Site Facility Name: Shell-#13-5765		
Site Facility Address: 29 Wildwood Avenue, Piedmont, CA 94610		
RB Case No.: 01-1351	STID No.: 1107	LOP Case No.: RO0000495
URF Filing Dates: June 8, 1990	Geotracker ID: T0600101246	APN: 51-4638-14
Responsible Parties	Addresses	Phone Numbers
Denis Brown Shell Oil Products US	20945 S. Wilmington Avenue, Carson, CA 90810	(707) 865-0251
---	---	---
---	---	---

Tank I.D. No	Size in Gallons	Contents	Closed In Place/Removed?	Date
1	550	Waste Oil	Removed	5/09/2007
---	---	---	---	---
---	---	---	---	---
---	---	---	---	---
Piping			Dispenser replacement	4/30/2005

**III. RELEASE AND SITE CHARACTERIZATION INFORMATION**

Cause and Type of Release: Unknown. USTs intact upon removal.		
Site characterization complete? Yes	Date Approved By Oversight Agency: ----	
Monitoring wells installed? Yes	Number: 6	Proper screened interval? ---
Highest GW Depth Below Ground Surface: 1.65 feet bgs	Lowest Depth: 8.84 feet bgs	Flow Direction: Southwest
Most Sensitive Current Use: Potential drinking water source.		

Summary of Production Wells in Vicinity: No water supply wells have been identified within ½ mile of the site.	
Are drinking water wells affected? No	Aquifer Name: East Bay Plain
Is surface water affected? No	Nearest SW Name: Lake Merritt is approximately 4,000 feet south of site.
Off-Site Beneficial Use Impacts (Addresses/Locations): None	
Reports on file? Yes	Where are reports filed? Alameda County Environmental Health.

TREATMENT AND DISPOSAL OF AFFECTED MATERIAL			
Material	Amount (Include Units)	Action (Treatment or Disposal w/Destination)	Date
Tank	1 tank	The 550-gallon single-wall fiberglass UST was removed from the site; disposal destination was not reported.	5/09/2007
Piping	----	----	----
Free Product	----	----	----
Soil	----	----	----
Groundwater	----	----	----

**MAXIMUM DOCUMENTED CONTAMINANT CONCENTRATIONS BEFORE AND AFTER CLEANUP**  
 (Please see Attachments 1-6 for additional information on contaminant locations and concentrations)

Contaminant	Soil (ppm)		Water (ppb)	
	Before	After	Before	After
TPH (Gas)	6,500	6,500	12,000(1)	1,800(1)
TPH (Diesel)	890	890	Not analyzed	Not analyzed
Oil and Grease	17	17	Not analyzed	Not analyzed
Benzene	6.3	0.068	610(2)	21(2)
Toluene	24	<0.05	520(1)	2.6(1)
Ethylbenzene	18	8.0	120(1)	1.2(1)
Xylenes	160	0.66	620(1)	3.8(1)
Heavy Metals (Cd, Cr, Pb, Ni, Zn)	11(3)	11(3)	Not analyzed	Not analyzed
MTBE	36(4)	0.18(4)	4,600(5)	17(6)
Other (8240/8270)	Not detected at various detection limits (7)	Not detected at various detection limits (7)	250(8)	250(8)

Footnotes:

- (1) The maximum concentration before cleanup is from a groundwater sample collected from well MW-3 on 10/30/1990; the maximum concentration after cleanup is from a groundwater sample collected from well MW-3 during the most recent groundwater monitoring event on 09/11/2009.
- (2) The maximum concentration before cleanup is from a groundwater sample collected from well MW-3 on 05/03/1993; the maximum concentration after cleanup is from a groundwater sample collected from well MW-3 during the most recent groundwater monitoring event on 09/11/2009.
- (3) Lead = 11 ppm; nickel = 37 ppm; chromium = 33 ppm; zinc = 38 ppm; and cadmium <0.5 ppm.
- (4) MTBE = 11.0 ppm; no other fuel oxygenates, EDB, or EDC detected in soil at various reporting limits.
- (5) MTBE = 4,600 ppb; TBA = 610 ppb; DIPE <2 ppb; ETBE <2 ppb; TAME = 7.4 ppb; ethanol = 150,000 ppb; EDB <5.0 ppb; and EDC <0.5 ppb.
- (6) MTBE = 17 ppb; TBA = 53 ppb; DIPE <2 ppb; ETBE <2 ppb; TAME = 7.4 ppb; ethanol <100 ppb; EDB and EDC not analyzed during 09/11/2009 sampling event.
- (7) Halogenated VOCs, SVOCs, PCP, creosote, and PCBs not detected at various reporting limits.
- (8) Tetrachloroethene = 250 ppb; trichloroethene = 28 ppb; and cis-1,2-dichloroethene = 16 ppb. Halogenated VOCs were detected in groundwater from off-site wells MW-4 and MW-5 and are suspected to be from an off-site source.

#### Site History and Description of Corrective Actions:

The site is currently an operating gasoline service station located in a mixed commercial and residential area of Oakland, California. The triangular-shaped site is located at the former confluence of Pleasant Valley Creek and Bushy Dell Creek. Both creeks are currently channeled in underground culverts beneath Grand Avenue (former Pleasant Valley Creek) and Wildwood Avenue (former Bushy Dell Creek). Drainage flows south through the culverts to discharge to Lake Merritt approximately 4,000 feet to the south.

Following the removal and replacement of underground storage tanks (USTs) in August 1984, four soil borings (E-1 through E-4) were advanced at the site on August 6, 2008. Petroleum hydrocarbons were observed at approximately 5 feet bgs in three of the borings completed within the tank backfill.

In June 1987, a 550-gallon waste oil tank was replaced. Soil samples collected during the waste oil tank removal did not contain petroleum hydrocarbons or volatile organic compounds at concentrations above reporting limits.

In August 1988, five soil borings (B-1 through B-5) were advanced to 15.5 feet bgs adjacent to the USTs. Up to 6,500 ppm of total petroleum hydrocarbons as gasoline (TPHg) was detected in boring B-3 and up to 750 ppm of TPHg was detected in B-4.

In July 1989, six soil borings were advanced (BH-D through BH-I) and three groundwater monitoring wells were installed (MW-1 through MW-3). Up to 710 ppm of TPHg was detected in soil samples collected from four of the borings. Petroleum hydrocarbons were detected in the initial groundwater samples collected from wells MW-2 and MW-3.

In January 1990, three soil borings (BH-J through BH-L) were advanced and two groundwater monitoring wells were installed (MW-4 and MW-5). Petroleum hydrocarbons were not detected in soil samples collected from the three soil borings.

On June 16, 1995, monitoring well MW-4, which was a flowing artesian well installed in a lower water-bearing zone, was decommissioned.

The dispensers and piping were upgraded in March 1998. Petroleum hydrocarbons were detected in the soil sample collected beneath the northwestern dispenser at concentrations of 1,600 TPHg and 6.3 ppm benzene (D-2 at 2 feet bgs).

The dispensers and piping were again upgraded in April 2005. Soil samples collected beneath the dispensers contained up to 610 ppm of TPHg and 890 ppm of TPHd. One 550-gallon waste oil tank was removed on May 9, 2007.

Quarterly groundwater monitoring has been conducted at the site since July 1989. During the third quarter 2009 groundwater sampling event, groundwater from MW-3 contained 1,800 ppb TPHg, 21 ppb benzene, 17 ppb MTBE, and 53 ppb TBA. Groundwater samples were analyzed for halogenated VOCs from May 1998 through July 2001. Halogenated VOCs were detected in groundwater from off-site wells MW-4 and MW-5, which are located on the opposite side of Grand Avenue from the site, but were not detected in the on-site monitoring wells. The halogenated VOCs are likely from an off-site source.

**IV. CLOSURE**

Does completed corrective action protect existing beneficial uses per the Regional Board Basin Plan? Yes		
Does completed corrective action protect potential beneficial uses per the Regional Board Basin Plan? Yes		
Does corrective action protect public health for current land use? Alameda County Environmental Health staff does not make specific determinations concerning public health risk. However, based upon the information available in our files to date, it does not appear that the release would present a risk to human health based upon current land use and conditions.		
Site Management Requirements: Case closure for this fuel leak site is granted for the current commercial land use only. If a change in land use to any residential or other conservative land use scenario occurs at this site, Alameda County Environmental Health (ACEH) must be notified as required by Government Code Section 65850.2.2. ACEH will re-evaluate the case upon receipt of approved development/construction plans.		
Excavation or construction activities in the areas of residual contamination require planning and implementation of appropriate health and safety procedures by the responsible party prior to and during excavation and construction activities.		
Should corrective action be reviewed if land use changes? Yes.		
Was a deed restriction or deed notification filed? No		Date Recorded: --
Monitoring Wells Decommissioned: Yes	Number Decommissioned: 1	Number Retained: 5
List Enforcement Actions Taken: None		
List Enforcement Actions Rescinded: --		

**V. ADDITIONAL COMMENTS, DATA, ETC.**

Considerations and/or Variances:

No soil vapor sampling was conducted for the site. Based on the apparent absence of BTEX in soil samples, the minimal BTEX concentrations in groundwater samples, and the age of the historic release, soil vapor sampling does not appear to be necessary.

Halogenated VOCs were detected in groundwater from off-site wells MW-4 and MW-5, which are located on the opposite side of Grand Avenue from the site, but were not detected in the on-site monitoring wells. The halogenated VOCs are likely from an off-site source.

Conclusion:

Alameda County Environmental Health staff believe that the levels of residual contamination do not pose a significant threat to water resources, public health and safety, and the environment under the current commercial land use based upon the information available in our files to date. No further investigation or cleanup for the fuel leak case is necessary unless a change in land use to any residential or other conservative land use scenario occurs at the site. ACEH staff recommend closure for this site.

**VI. LOCAL AGENCY REPRESENTATIVE DATA**

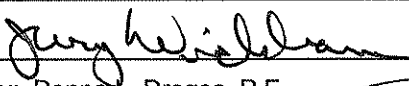
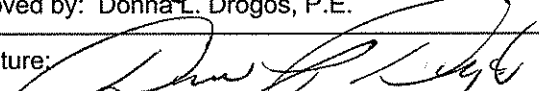
Prepared by: Jerry Wickham	Title: Senior Hazardous Materials Specialist
Signature: 	Date: 04/28/10
Approved by: Donna L. Drogos, P.E.	Title: Chief
Signature: 	Date: 04/28/10



This closure approval is based upon the available information and with the provision that the information provided to this agency was accurate and representative of site conditions.

### VII. REGIONAL BOARD NOTIFICATION

Regional Board Staff Name: Cherie McCaulou	Title: Engineering Geologist
Notification Date: 04/28/10	

### VIII. MONITORING WELL DECOMMISSIONING

Date Requested by ACEH: 04/28/10	Date of Well Decommissioning Report: 08/05/10	
All Monitoring Wells Decommissioned: Yes	Number Decommissioned: 5	Number Retained: 0
Reason Wells Retained: NA		
Additional requirements for submittal of groundwater data from retained wells: None		
ACEH Concurrence - Signature: <i>Jerry Wiselgram</i>	Date: 08/06/10	

Attachments:

1. Site Vicinity Map (1 pp)
2. Site Plan and Recent Results (2 pp)
3. Groundwater Elevation Contours; Time Concentrations Graphs and Cross Section (4 pp)
4. Soil Analytical Data (5 pp)
5. Groundwater Analytical Data (13 pp)
6. Boring Logs (23 pp)

This document and the related CASE CLOSURE LETTER & REMEDIAL ACTION COMPLETION CERTIFICATE shall be retained by the lead agency as part of the official site file.

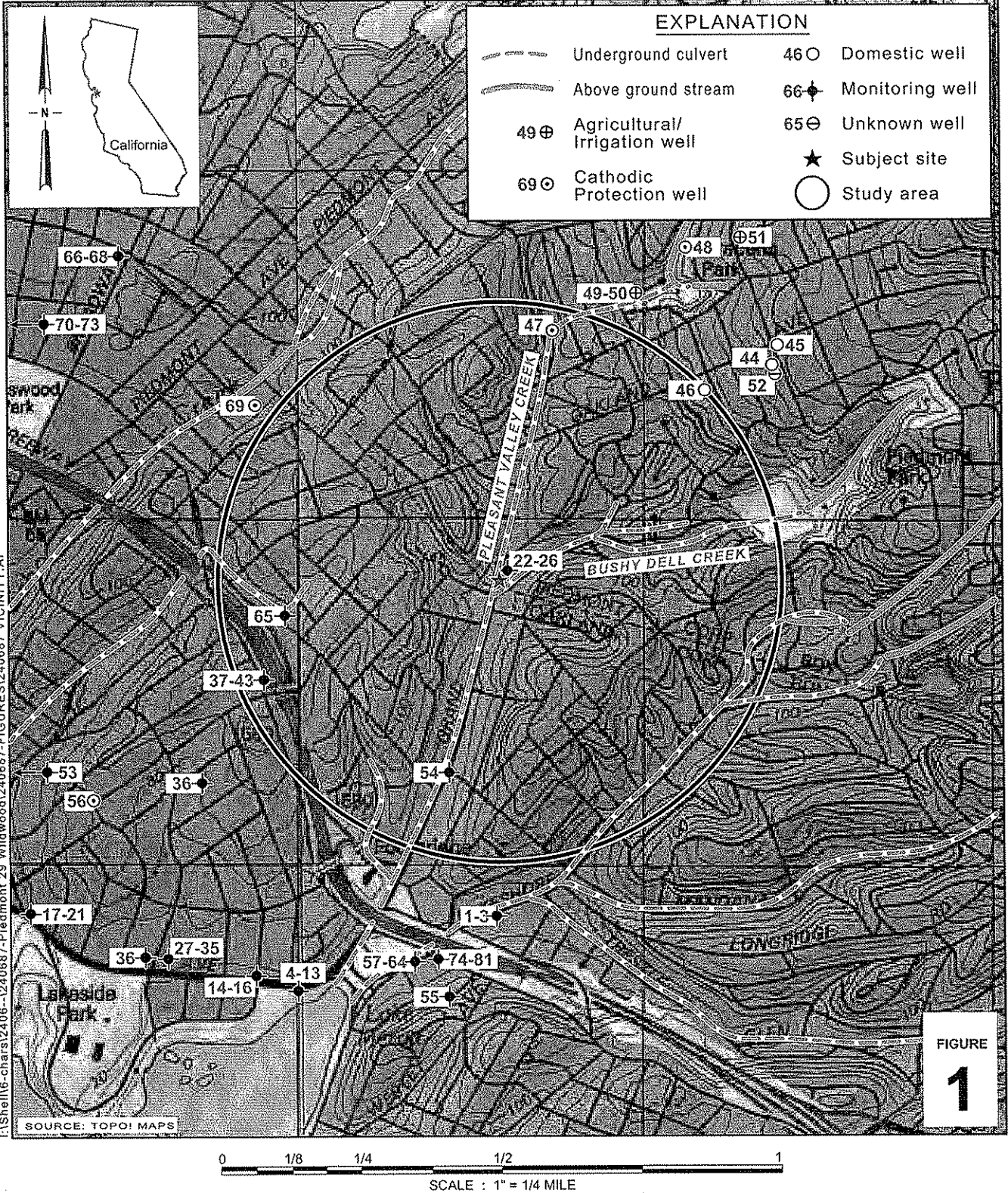

I:\Shell\6-char\st2406-1240687-Piedmont 29 Wildwood\240687-FIGURES\240687 VICINITY.A1

SOURCE: TOPOI MAPS

FIGURE  
**1**

**Shell-branded Service Station**  
29 Wildwood Avenue  
Piedmont, California



**CONESTOGA-ROVERS & ASSOCIATES**

Vicinity Map

**ATTACHMENT 1**

I:\Shell\chart\2406-240687-P\figment 20 Wildwood\240687-FIGURES\240687 SITE PLAN.DWG

11/16/05

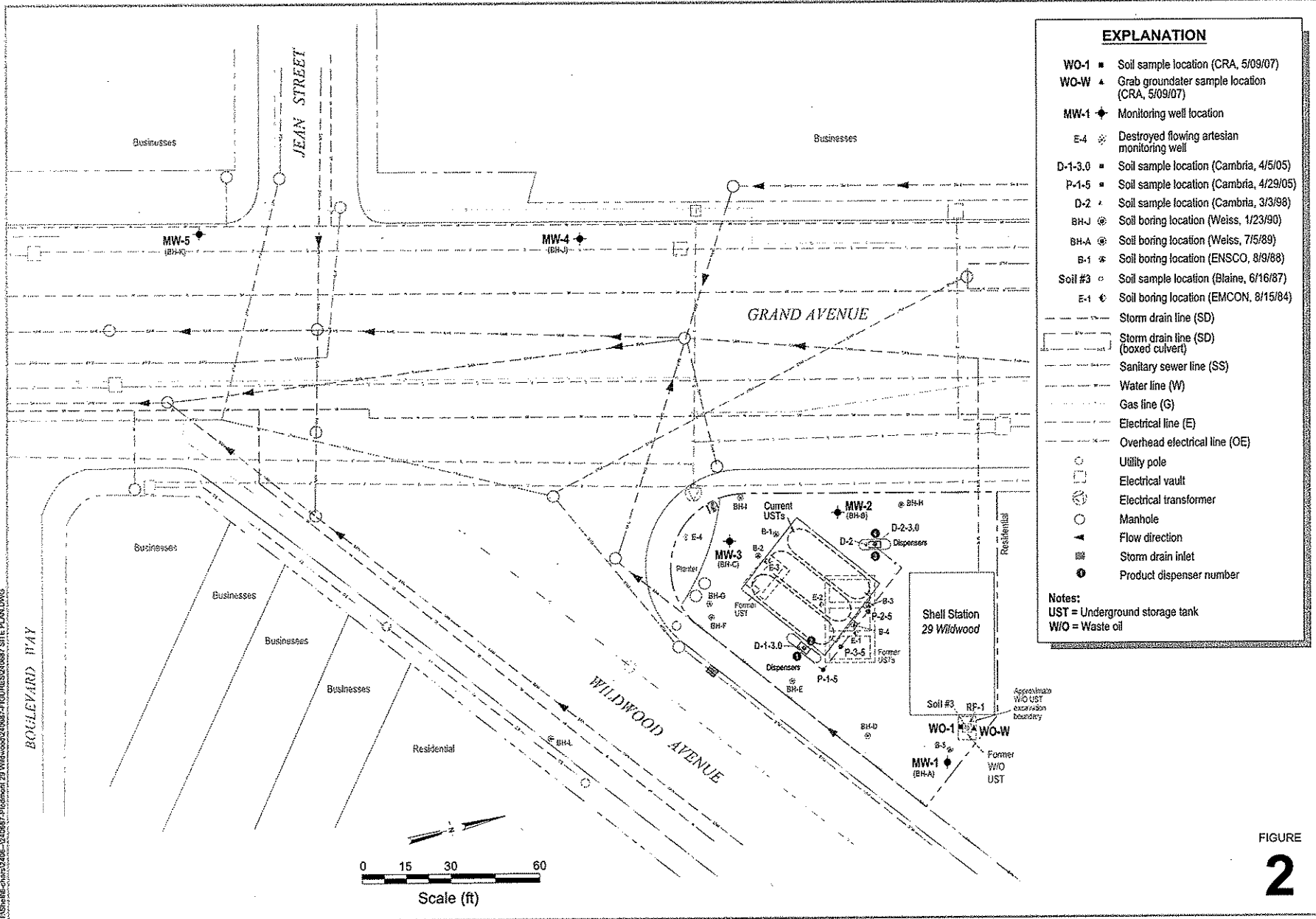

**EXPLANATION**

- WO-1 ■ Soil sample location (CRA, 5/09/07)
- WO-W ▲ Grab groundwater sample location (CRA, 5/09/07)
- MW-1 ◆ Monitoring well location
- E-4 ✳ Destroyed flowing artesian monitoring well
- D-1-3.0 ■ Soil sample location (Cambria, 4/5/05)
- P-1-5 ■ Soil sample location (Cambria, 4/29/05)
- D-2 ▲ Soil sample location (Cambria, 3/3/96)
- BH-J ⊗ Soil boring location (Weiss, 1/23/90)
- BH-A ⊗ Soil boring location (Weiss, 7/5/89)
- B-1 ✳ Soil boring location (ENSCO, 8/9/88)
- Soil #3 ○ Soil sample location (Blaine, 6/16/87)
- E-1 ◆ Soil boring location (EMCON, 8/15/84)
- Storm drain line (SD)
- Storm drain line (SD) (boxed culvert)
- Sanitary sewer line (SS)
- Water line (W)
- Gas line (G)
- Electrical line (E)
- Overhead electrical line (OE)
- Utility pole
- Electrical vault
- ⊗ Electrical transformer
- Manhole
- ▲ Flow direction
- Storm drain inlet
- Product dispenser number

**Notes:**  
 UST = Underground storage tank  
 W/O = Waste oil

Site Plan

**ATTACHMENT 2**



CONESTOGA-ROVERS & ASSOCIATES

**Shell-branded Service Station**  
 29 Wildwood Avenue  
 Piedmont, California

**FIGURE 2**

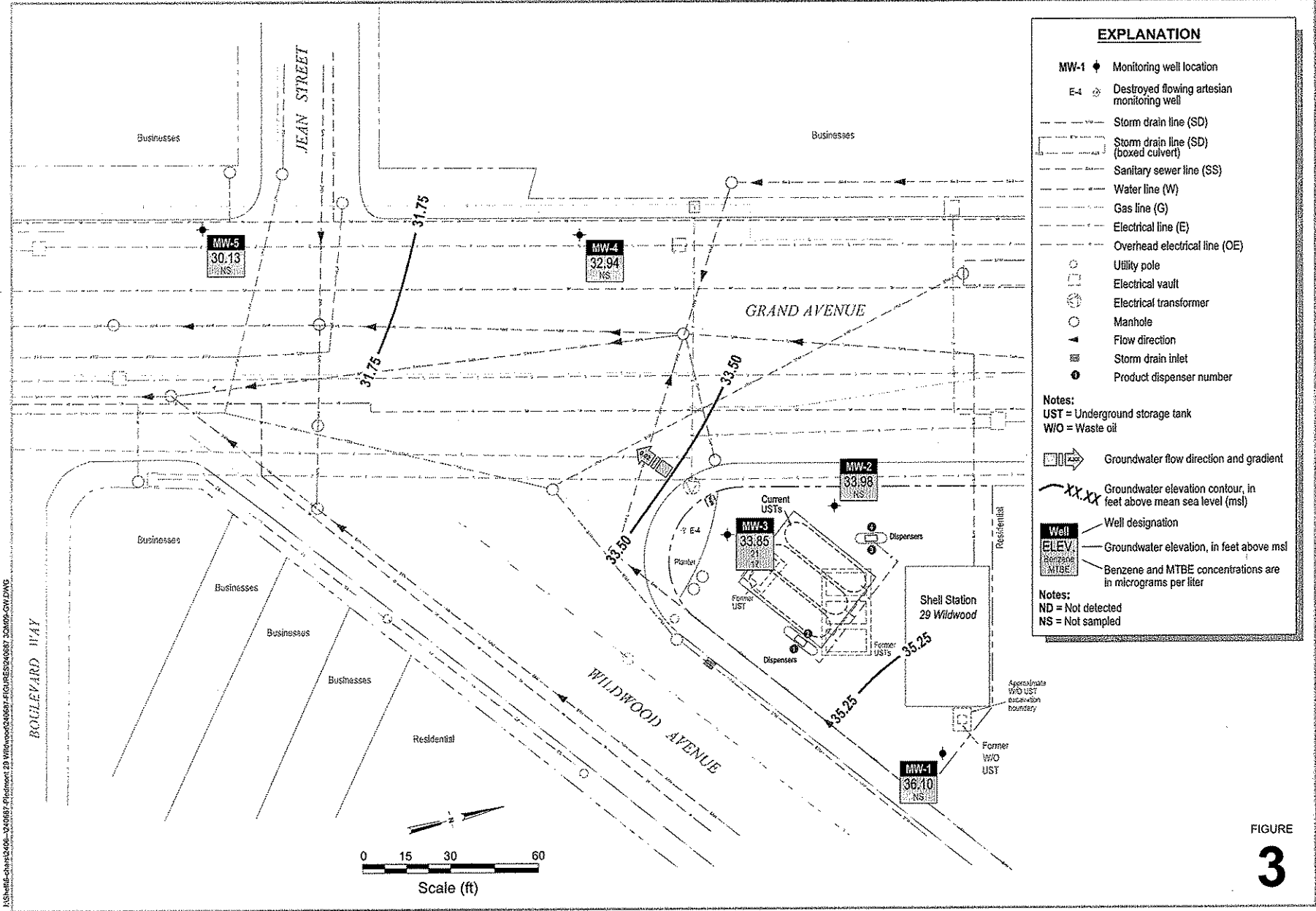

AS:\shell-station\29-wildwood\29-wildwood\11-09-09\11-09-09.dwg

Groundwater Contour and  
Chemical Concentration Map  
**ATTACHMENT 3**



Shell-branded Service Station  
29 Wildwood Avenue  
Piedmont, California

FIGURE  
**3**

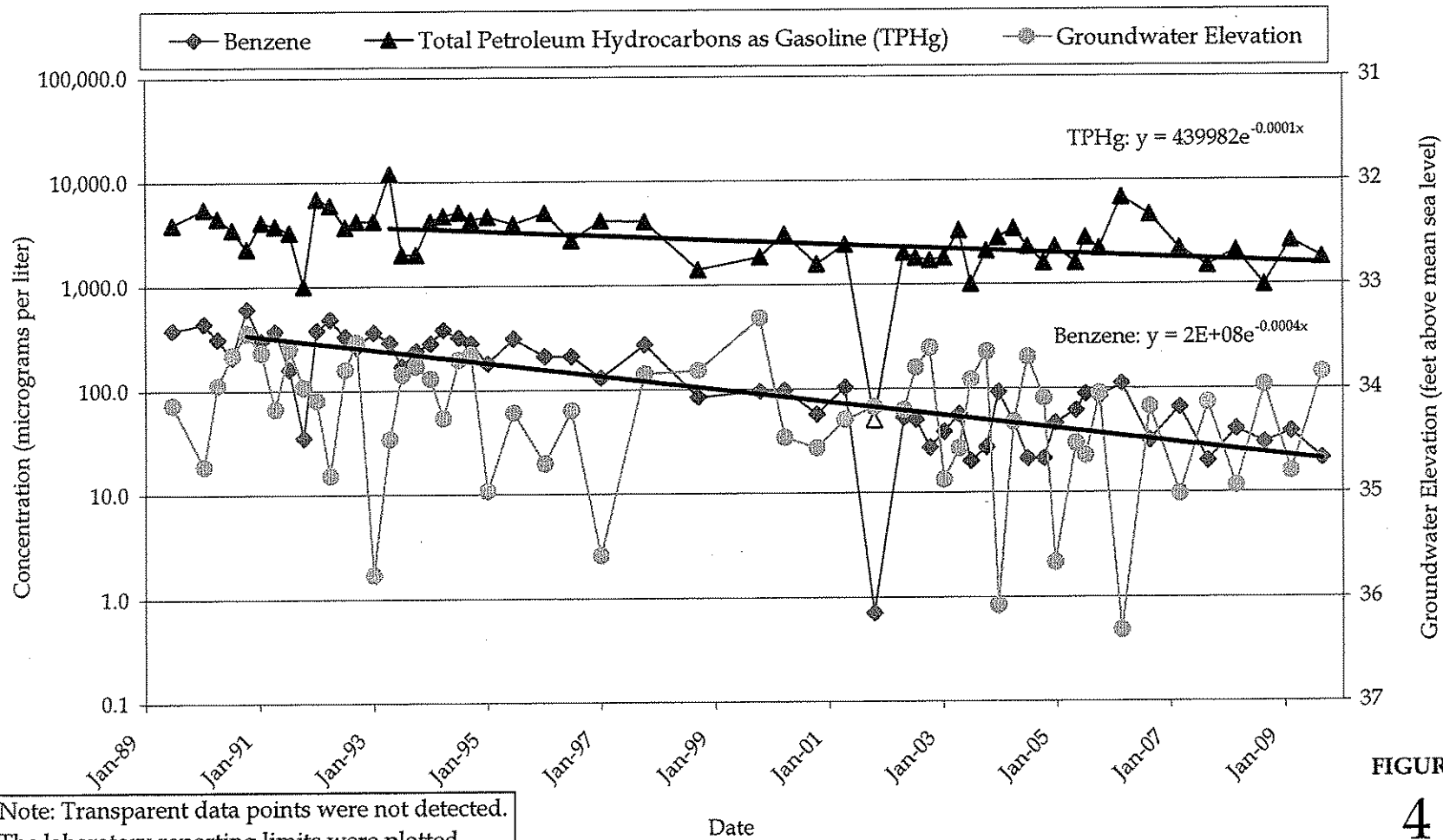

FIGURE 4

Shell-branded Service Station   
 29 Wildwood Avenue   
 Piedmont, California



MW-3: TPHg and Benzene Concentrations   
 and Groundwater Elevation versus Time

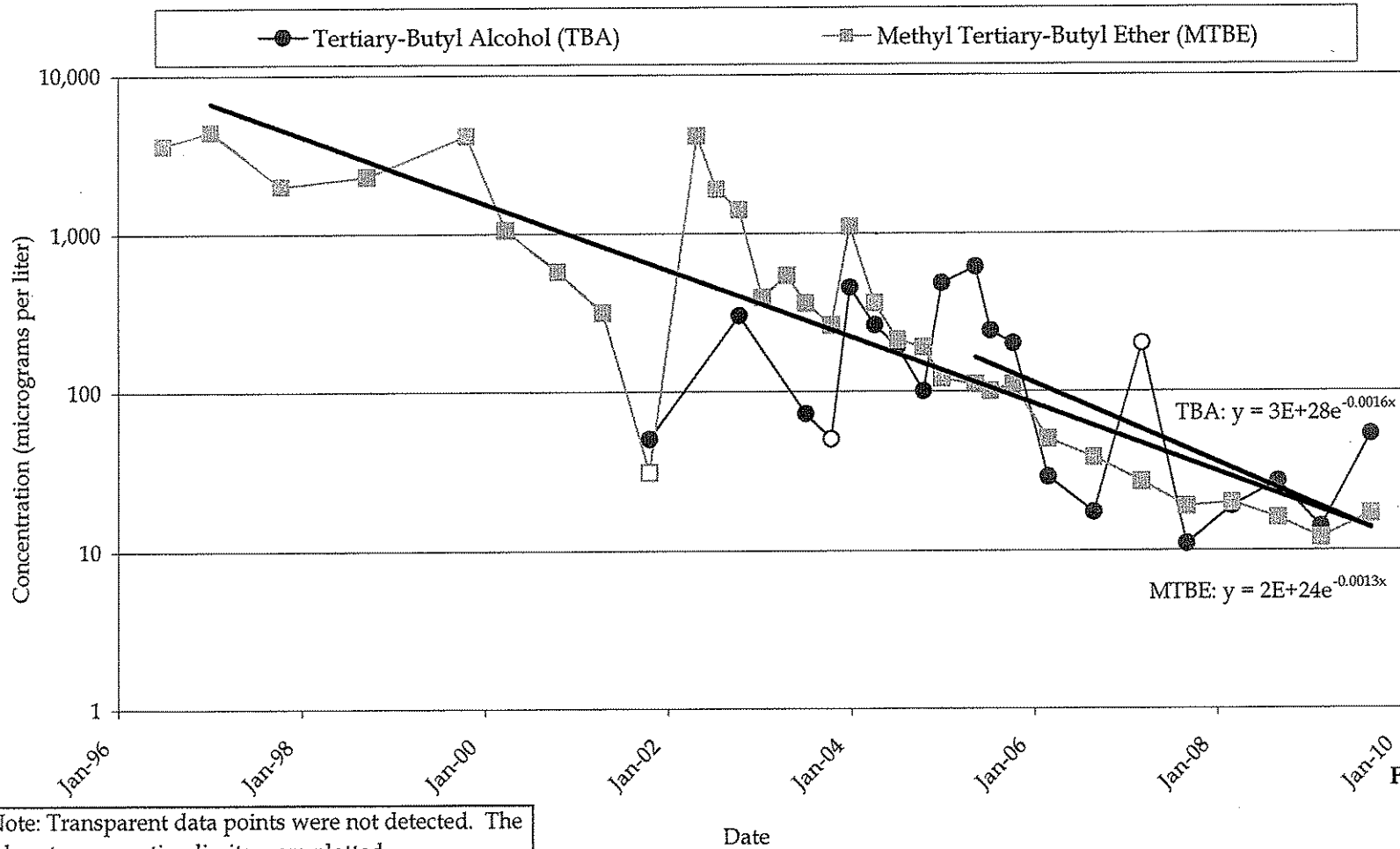

FIGURE  
5

Shell-branded Service Station  
 29 Wildwood Avenue  
 Piedmont, California



MW-3: MTBE and TBA Concentrations  
 versus Time

080265

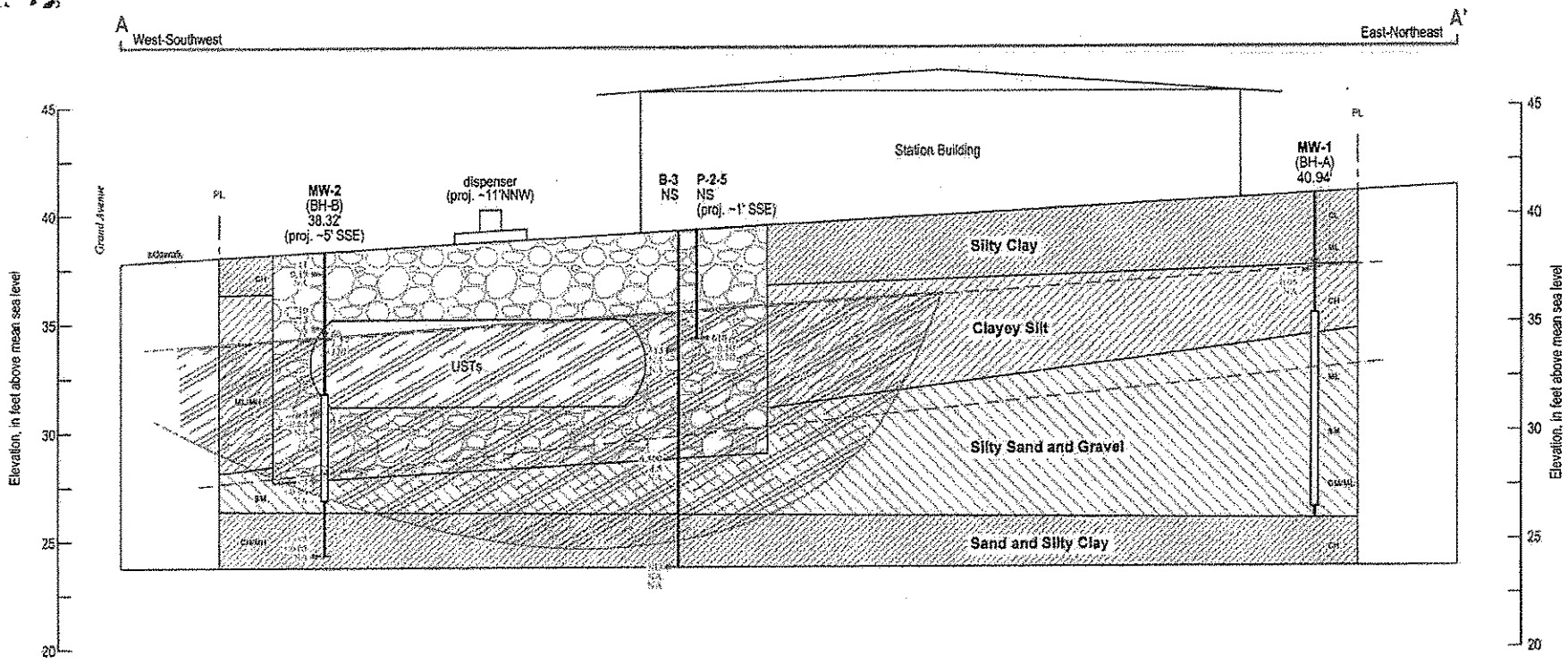

Geological Cross Section A-A



C A M B R I A

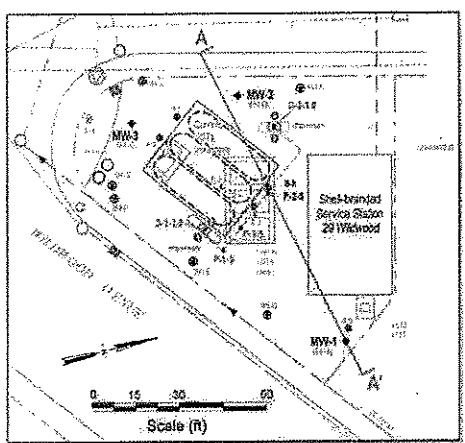

**EXPLANATION**

- = Low Permeability Soils
  - ch - Inorganic Clay
  - cl - Clay
  - sc - Clayey Sand
- = Moderate Permeability Soils
  - ml - Clayey Silt
  - sm - Silty Sand
- = High Permeability Soils
  - sp - Poorly Graded Sand
  - sw - Well Graded Sand
- = Fill (Tank Pit)
- = TPHg and BTEX in soil and groundwater
- = Approximate sample location

Hydrocarbon concentrations in Soil, in parts per million

Hydrocarbon concentrations in Groundwater, in parts per billion

Well ID — Well Designation

Elev. — Top of Casing Elevation

(elev.)

Groundwater Monitoring Well

Well Screen Interval

Bottom of boring

33 Depth of Groundwater - at drilling (1989)

34 Depth of Groundwater - 05/19/05

0.000g/g (0.000%)

0.000g/g (0.000%)

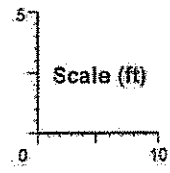

FIGURE  
**3**

**Shell-branded Service Station**

28 Wildwood Avenue  
Piedmont, California  
Incident No. 9895922

G:\PIEDMONT 28 WILDWOOD\FOURREN\SCT A-A.DWG

TABLE 1

**HISTORICAL SOIL ANALYTICAL DATA: TPHG, TPHD, BTEX, AND MTBE  
SHELL-BRANDED SERVICE STATION  
29 WILDWOOD AVENUE, PIEDMONT, CALIFORNIA**

<i>Sample ID</i>	<i>Date</i>	<i>Depth (fbg)</i>	<i>TPHg</i>	<i>TPHd</i>	<i>Benzene</i>	<i>Toluene</i>	<i>Ethyl- benzene</i>	<i>Total Xylenes</i>	<i>MTBE</i>
BH-E	7/5/1989	2	<5	--	<0.05	<0.1	<0.1	<0.3	--
BH-E	7/5/1989	5.8	<5	--	<0.05	<0.1	<0.1	<0.3	--
BH-H	7/5/1989	3.5	8	--	0.07	<0.1	<0.1	<0.1	--
BH-H	7/5/1989	7	<5	--	<0.05	<0.1	<0.1	<0.3	--
BH-I	7/5/1989	6	540	--	<1	<2	<4	<10	--
BH-I	7/5/1989	7.5	29	--	<0.2	<0.1	<0.2	<0.3	--
BH-I	7/5/1989	10	<5	--	<0.05	<0.1	<0.1	<0.3	--
<i>1990 Subsurface Investigation</i>									
BH-J (MW-4)	1/23/1990	2.4	<1	--	<0.0025	<0.0025	<0.0025	<0.0025	--
BH-J (MW-4)	1/23/1990	5.2	<1	--	<0.0025	<0.0025	<0.0025	<0.0025	--
BH-J (MW-4)	1/23/1990	18.2	<1	--	<0.0025	<0.0025	<0.0025	<0.0025	--
BH-K (MW-5)	1/23/1990	3.2	<1	--	<0.0025	<0.0025	<0.0025	<0.0025	--
BH-K (MW-5)	1/23/1990	5.2	<1	--	<0.0025	<0.0025	<0.0025	<0.0025	--
BH-K (MW-5)	1/23/1990	18	<1	--	<0.0025	<0.0025	<0.0025	<0.0025	--
BH-L	1/23/1990	3.2	<1	--	<0.0025	<0.0025	<0.0025	<0.0025	--
BH-L	1/23/1990	6.4	<1	--	<0.0025	<0.0025	<0.0025	<0.0025	--
BH-L	1/23/1990	15.2	<1	--	<0.0025	<0.0025	<0.0025	<0.0025	--
BH-L	1/23/1990	25.2	<1	--	<0.0025	<0.0025	<0.0025	<0.0025	--
<i>1998 Upgrade Sampling</i>									
D-2 <sup>a</sup>	3/3/1998	2	1,600 <sup>b</sup>	--	6.3 <sup>c</sup>	24 <sup>c</sup>	18 <sup>c</sup>	160 <sup>c</sup>	36 <sup>c</sup>
RF-1	3/6/1998	2	<1.0 <sup>b</sup>	10	--	--	--	--	--
<i>2005 Upgrade Sampling</i>									
D-1-3.0	4/5/2005	3	500	890	0.068	<0.050	8.0	0.66	0.18
D-2-3.0	4/5/2005	3	<1.0	9.3	<0.0050	<0.0050	<0.0050	<0.0050	<0.0050
P-1-5	4/29/2005	5	<1.0	--	<0.0050	<0.0050	<0.0050	<0.0050	<0.0050
P-2-5	4/29/2005	5	610	--	<0.50	<0.50	7.8	<0.50	<0.50
P-3-5	4/29/2005	5	51	--	<0.50	<0.50	<0.50	<0.50	<0.50



TABLE 1

HISTORICAL SOIL ANALYTICAL DATA: TPHG, TPHD, BTEX, AND MTBE  
SHELL-BRANDED SERVICE STATION  
29 WILDWOOD AVENUE, PIEDMONT, CALIFORNIA

Sample ID	Date	Depth (fbg)	TPHg	TPHd	Benzene	Toluene	Ethyl- benzene	Total Xylenes	MTBE
<i>1987 Underground Storage Tank Removal</i>									
Soil #3	6/16/1987	8	---	<1.0	<50	<50	<50	---	---
<i>1988 Soil Investigation</i>									
B-1-1	8/9/1988	4.5-5	ND	---	---	---	---	---	---
B-2-1	8/9/1988	5-5.5	ND	---	---	---	---	---	---
B-3-1	8/9/1988	5-5.5	13	---	---	---	---	---	---
B-3-2	8/9/1988	10-10.5	6,500	---	4.5	1.6	28	2.5	---
B-3-3	8/9/1988	15-15.5	ND	---	---	---	---	---	---
B-4-1	8/9/1988	10-10.5	750	---	3.4	3.4	1.2	1.7	---
B-4-2	8/9/1988	15-15.5	ND	---	---	---	---	---	---
B-5-(1-2) (composite)	8/9/1988	5-5.5 and 10-10.5	ND	---	---	---	---	---	---
<i>1989 Well Installations</i>									
BH-A (MW-1)	7/5/1989	3.6	<5	---	<0.05	<0.1	<0.1	<0.3	---
BH-B (MW-2)	7/5/1989	1	11	---	0.19	<0.1	0.1	<0.3	---
BH-B (MW-2)	7/5/1989	3.5	710	---	3	5	17	71	---
BH-B (MW-2)	7/5/1989	7.4	5	---	<0.05	<0.1	<0.1	<0.3	---
BH-B (MW-2)	7/5/1989	10.5	<5	---	<0.05	<0.1	<0.1	<0.3	---
BH-B (MW-2)	7/5/1989	14	<5	---	<0.05	<0.1	<0.1	<0.3	---
BH-C (MW-3)	7/5/1989	3.5	<5	---	1.3	0.3	0.2	0.7	---
BH-C (MW-3)	7/5/1989	5.5	72	---	1.2	3.1	8.3	42	---
BH-C (MW-3)	7/5/1989	9	270	---	<0.05	<0.1	<0.1	<0.3	---
BH-D	7/5/1989	2.5	<5	---	<0.05	<0.1	<0.1	<0.3	---
BH-D	7/5/1989	6	<5	---	<0.05	<0.1	<0.1	<0.3	---
BH-D	7/5/1989	9.5	<5	---	<0.05	<0.1	<0.1	<0.3	---
BH-D	7/5/1989	15	<5	---	<0.05	<0.1	<0.1	<0.3	---

TABLE 1

HISTORICAL SOIL ANALYTICAL DATA: TPHG, TPHD, BTEX, AND MTBE  
SHELL-BRANDED SERVICE STATION  
29 WILDWOOD AVENUE, PIEDMONT, CALIFORNIA

Sample ID	Date	Depth (fbg)	TPHg	TPHd	Benzene	Toluene	Ethyl-benzene	Total Xylenes	MTBE
2007 Waste Oil Tank Removal									
WO-1-5'	5/9/2007	5	<1.0	1.7	<0.0050	<0.0050	<0.0050	<0.0050	<0.0050

Shallow Soil (<10 fbg) ESL			180	180	0.27	93	47	11	5.1
Deep Soil (>10 fbg) ESL			180	180	2.0	93	47	11	5.1

Notes:

All results in milligrams per kilogram (mg/kg) unless otherwise indicated.

fbg = Feet below grade

TPHg = Total petroleum hydrocarbons as gasoline analyzed by modified EPA Method 8260B unless otherwise noted

TPHd = Total petroleum hydrocarbons as diesel, analyzed by EPA 8015M

Benzene, toluene, ethylbenzene, and xylenes analyzed by EPA Method 8260 unless otherwise noted

MTBE = Methyl tertiary-butyl ether analyzed by EPA Method 8260B unless otherwise noted.

ND = Not detected; detection limit unknown

<x = Not detected at reporting limit x

--- = Not analyzed

ESL = Environmental screening level

Results in bold equal or exceed applicable ESL

a = Sample location subsequently excavated during 2005 dispenser upgrades

b = Analyzed by modified EPA Method 8015

c = Analyzed by EPA Method 8020

d = San Francisco Bay Regional Water Quality Control Board commercial/industrial ESL for soil where groundwater is not a source of drinking water (Tables B and D of *Screening for Environmental Concerns at Sites With Contaminated Soil and Groundwater*, California Regional Water Quality Control Board, Interim Final - November 2007 [Revised May 2008]).

TABLE 2

**HISTORICAL SOIL ANALYTICAL DATA: ADDITIONAL PARAMETERS  
SHELL-BRANDED SERVICE STATION  
29 WILDWOOD AVENUE, PIEDMONT, CALIFORNIA**

Sample ID	Date	Depth (fbg)	O&G	TRPH	HVOCs	VOCs	SVOCs	Bis (2-Ethylhexyl) Phthalate	PCP	Creosote	Chlorinated Hydrocarbons	OXYs	Ethanol	1,2-DCA	EDB	Cd	Cr	Pb	Ni	Zn	PCBs
<i>1987 Underground Storage Tank Removal</i>																					
Soil #3	6/16/1987	8	<30 <sup>a</sup>	--	ND	--	--	--	--	--	--	--	--	--	--	--	--	--	--	--	--
<i>1998 Upgrade Sampling</i>																					
RF-1	3/6/1998	2	--	<15	--	ND	ND	<500	<500	--	--	--	--	--	--	<0.50	33.0	11.0	37.0	38.0	--
<i>2007 Waste Oil Tank Removal</i>																					
WO-1-5'	5/9/2007	5	17	--	--	--	<sup>b</sup>	1.4	<2.5	<0.50	ND	<0.0050	<0.010	<0.0050	<0.0050	<0.500	33.1	6.33	34.8	25.2	<0.05
<i>Shallow Soil (&lt;10 fbg) ESL<sup>c</sup>:</i>			NA	2,500	Various	Various	Various	120	5.0	NA	Various	Various	NA	0.48	0.044	7.4	750	750	150	600	0.74

Notes:

All results in milligrams per kilogram (mg/kg) unless otherwise indicated.

fbg = Feet below grade

O&G = Oil and grease as hexane extractable material analyzed by EPA Method 1664 A (Modified) unless otherwise noted

TRPH = Total recoverable petroleum hydrocarbons analyzed by EPA Method 418.1

HVOCs = Halogenated volatile organic compounds analyzed by EPA Method 8020.

VOCs = Volatile organic compounds analyzed by EPA Method 8240

SVOCs = Semi-volatile organic compounds analyzed by EPA Method 8270

Bis (2-Ethylhexyl) Phthalate analyzed by EPA Method 8270C.

PCP = Pentachlorophenol analyzed by EPA Method 8270C

Creosote analyzed by EPA Method 8270C. It is reported as a combination of naphthalene, acenaphthylene, fluorene, phenanthrene, anthracene, fluoranthene, pyrene, 1-methylnaphthalene, and 2-methylnaphthalene.

Chlorinated hydrocarbons analyzed by EPA Method 8260B.

OXYs = Di-isopropyl ether, ethyl tertiary-butyl ether, tertiary-amyl methyl ether, and tertiary-butyl alcohol analyzed by EPA Method 8260B

Ethanol analyzed by EPA Method 8260B

1,2-DCA = 1,2-Dichloroethane analyzed by EPA Method 8260B

EDB = 1,2-Dibromoethane analyzed by EPA Method 8260B

Cd = Cadmium analyzed by EPA Method 6010B

Cr = Chromium analyzed by EPA Method 6010B

Pb = Lead analyzed by EPA Method 6010B

Ni = Nickel analyzed by EPA Method 6010B

Zn = Zinc analyzed by EPA Method 6010B

TABLE 2

**HISTORICAL SOIL ANALYTICAL DATA: ADDITIONAL PARAMETERS  
SHELL-BRANDED SERVICE STATION  
29 WILDWOOD AVENUE, PIEDMONT, CALIFORNIA**

PCBs = Polychlorinated biphenyls analyzed by EPA Method 8082; see laboratory analytical report for a complete list of specific constituents

ND = Not detected. All detected constituents tabulated. See laboratory report for complete results.

<x = Not detected at reporting limit x

— = Not analyzed

ESL = Environmental screening level

NA = No applicable ESL

a = Analyzed by standard methods 503E

b = All detected constituents tabulated. See laboratory report for complete results.

c = San Francisco Bay Regional Water Quality Control Board commercial/industrial ESL for soil where groundwater is not a source of drinking water (Tables B and D of *Screening for Environmental Concerns at Sites With Contaminated Soil and Groundwater*, California Regional Water Quality Control Board, Interim Final - November 2007 [Revised May 2008]).

**WELL CONCENTRATIONS**  
**Shell-branded Service Station**  
**29 Wildwood Avenue**  
**Piedmont, CA**

Well ID	Date	TPPH (ug/L)	B (ug/L)	T (ug/L)	E (ug/L)	X (ug/L)	MTBE 8020 (ug/L)	MTBE 8260 (ug/L)	DIPE (ug/L)	ETBE (ug/L)	TAME (ug/L)	TBA (ug/L)	Ethanol (ug/L)	1,2- DCA (ug/L)	EDB (ug/L)	TOC (MSL)	Depth to Water (ft.)	GW Elevation (MSL)	DO Reading (ppm)
MW-1	07/12/1989	<50	<0.5	<1	<1	<3	NA	NA	NA	NA	NA	NA	NA	NA	NA	37.96	2.76	35.20	NA
MW-1	01/30/1990	<50	<0.5	<0.5	<0.5	<0.5	NA	NA	NA	NA	NA	NA	NA	NA	NA	37.96	3.10	34.86	NA
MW-1	04/27/1990	<50	<0.5	<0.5	<0.5	<0.5	NA	NA	NA	NA	NA	NA	NA	NA	NA	37.96	3.24	34.72	NA
MW-1	07/31/1990	<50	<0.5	<0.5	<0.5	<0.5	NA	NA	NA	NA	NA	NA	NA	NA	NA	37.96	4.26	33.70	NA
MW-1	10/30/1990	<50	<0.5	<0.5	<0.5	<0.5	NA	NA	NA	NA	NA	NA	NA	NA	NA	37.96	4.25	33.71	NA
MW-1	01/31/1991	<50	<0.5	<0.5	<0.5	<0.5	NA	NA	NA	NA	NA	NA	NA	NA	NA	37.96	3.66	34.30	NA
MW-1	04/30/1991	<50	0.8	<0.5	0.6	1.2	NA	NA	NA	NA	NA	NA	NA	NA	NA	37.96	3.46	34.50	NA
MW-1	07/30/1991	<50	<0.5	<0.5	<0.5	<0.5	NA	NA	NA	NA	NA	NA	NA	NA	NA	37.96	4.14	33.82	NA
MW-1	10/29/1991	<50	<0.5	<0.5	<0.5	<0.5	NA	NA	NA	NA	NA	NA	NA	NA	NA	37.96	3.96	34.00	NA
MW-1	01/20/1992	<30	<0.3	<0.3	<0.3	<0.3	NA	NA	NA	NA	NA	NA	NA	NA	NA	37.96	3.59	34.37	NA
MW-1	04/14/1992	<50	<0.5	<0.5	<0.5	<0.5	NA	NA	NA	NA	NA	NA	NA	NA	NA	37.96	3.18	31.71	NA
MW-1	07/21/1992	<50	<0.5	<0.5	<0.5	<0.5	NA	NA	NA	NA	NA	NA	NA	NA	NA	37.96	4.17	33.79	NA
MW-1	10/02/1992	<50	<0.5	<0.5	<0.5	<0.5	NA	NA	NA	NA	NA	NA	NA	NA	NA	37.96	4.29	33.67	NA
MW-1	01/20/1993	<50	<0.5	<0.5	<0.5	<0.5	NA	NA	NA	NA	NA	NA	NA	NA	NA	37.96	2.32	35.64	NA
MW-1	05/03/1993	<50	<0.5	<0.5	<0.5	<0.5	NA	NA	NA	NA	NA	NA	NA	NA	NA	37.96	3.50	34.46	1.9
MW-1	06/28/1993	NA	NA	NA	NA	NA	NA	NA	NA	NA	NA	NA	NA	NA	NA	37.96	3.76	34.20	NA
MW-1	07/21/1993	<50	<0.5	<0.5	<0.5	<0.5	NA	NA	NA	NA	NA	NA	NA	NA	NA	37.96	4.09	33.87	4.6
MW-1	10/19/1993	50	<0.5	<0.5	<0.5	<0.5	NA	NA	NA	NA	NA	NA	NA	NA	NA	37.96	3.58	34.38	4.3
MW-1	01/20/1994	Well inaccessible	NA	NA	NA	NA	NA	NA	NA	NA	NA	NA	NA	NA	NA	37.96	NA	NA	NA
MW-1	04/12/1994	<50	<0.5	<0.5	<0.5	<0.5	NA	NA	NA	NA	NA	NA	NA	NA	NA	37.96	3.60	34.36	7.5
MW-1	07/20/1994	<50	<0.5	<0.5	<0.5	<0.5	NA	NA	NA	NA	NA	NA	NA	NA	NA	37.96	4.10	33.86	3.2
MW-1	10/06/1994	<50	<0.5	<0.5	<0.5	<0.5	NA	NA	NA	NA	NA	NA	NA	NA	NA	37.96	4.30	33.66	3.2
MW-1	01/20/1995	<50	<0.5	<0.5	<0.5	<0.5	NA	NA	NA	NA	NA	NA	NA	NA	NA	37.96	2.94	35.02	10.6
MW-1	07/06/1995	<50	<0.5	<0.5	<0.5	<0.5	NA	NA	NA	NA	NA	NA	NA	NA	NA	37.96	3.68	34.28	NA
MW-1	01/24/1996	<50	<0.5	<0.5	<0.5	<0.5	NA	NA	NA	NA	NA	NA	NA	NA	NA	37.96	2.12	35.84	NA
MW-1	07/12/1996	<50	<0.5	<0.5	<0.5	<0.5	<2.5	NA	NA	NA	NA	NA	NA	NA	NA	37.96	3.58	34.38	2.7
MW-1	01/18/1997	120	14	10	3.6	14	<2.5	NA	NA	NA	NA	NA	NA	NA	NA	37.96	2.30	35.66	3
MW-1	10/24/1997	<50	<0.50	<0.50	<0.50	<0.50	8.6	NA	NA	NA	NA	NA	NA	NA	NA	37.96	3.66	34.30	4.5
MW-1	05/13/1998	<50	<0.50	<0.50	<0.50	<0.50	<2.5	NA	NA	NA	NA	NA	NA	NA	NA	37.96	2.81	35.15	5.1
MW-1	10/01/1998	<50	<0.50 c	<0.50 c	<0.50 c	<0.50 c	<2.5 c	NA	NA	NA	NA	NA	NA	NA	NA	37.96	3.75	34.21	5.0
MW-1	04/29/1999	<50	<0.50	<0.50	<0.50	<0.50	<2.5	NA	NA	NA	NA	NA	NA	NA	NA	37.96	3.52	34.44	4.1
MW-1	11/01/1999	<50.0	<0.500	<0.500	<0.500	<0.500	5.03	NA	NA	NA	NA	NA	NA	NA	NA	37.96	4.05	33.91	3.6
MW-1	04/05/2000	<50.0	<0.500	<0.500	<0.500	<0.500	3.22	NA	NA	NA	NA	NA	NA	NA	NA	37.96	3.74	34.22	4.2
MW-1	10/30/2000	<50.0	<0.500	<0.500	<0.500	<0.500	<2.50	NA	NA	NA	NA	NA	NA	NA	NA	37.96	2.19	35.77	4.1

**WELL CONCENTRATIONS**  
**Shell-branded Service Station**  
**29 Wildwood Avenue**  
**Piedmont, CA**

Well ID	Date	TPPH (ug/L)	B (ug/L)	T (ug/L)	E (ug/L)	X (ug/L)	MTBE 8020 (ug/L)	MTBE 8260 (ug/L)	DIPE (ug/L)	ETBE (ug/L)	TAME (ug/L)	TBA (ug/L)	Ethanol (ug/L)	1,2- DCA (ug/L)	EDB (ug/L)	TOC (MSL)	Depth to Water (ft.)	GW Elevation (MSL)	DO Reading (ppm)
MW-1	04/27/2001	<50.0	<0.500	<0.500	<0.500	<0.500	<2.50	NA	NA	NA	NA	NA	NA	NA	NA	37.96	4.43	33.53	1.9
MW-1	10/31/2001	<50	<0.50	<0.50	<0.50	<0.50	NA	<5.0	NA	NA	NA	NA	NA	NA	NA	37.96	4.34	33.62	2.4
MW-1	05/09/2002	Well inaccessible		NA	NA	NA	NA	NA	NA	NA	NA	NA	NA	NA	NA	37.96	NA	NA	NA
MW-1	07/25/2002	<50	<0.50	<0.50	<0.50	<0.50	NA	<5.0	NA	NA	NA	NA	NA	NA	NA	37.96	3.53	34.43	1.2
MW-1	10/23/2002	<50	<0.50	<0.50	<0.50	<0.50	NA	<0.50	<2.0	<2.0	<2.0	<50	NA	<2.0	<2.0	40.94	3.68	37.26	3.5
MW-1	01/22/2003	Well inaccessible		NA	NA	NA	NA	NA	NA	NA	NA	NA	NA	NA	NA	40.94	NA	NA	NA
MW-1	01/29/2003	<50	<0.50	<0.50	<0.50	<0.50	NA	<5.0	NA	NA	NA	NA	NA	NA	NA	40.94	3.25	37.69	3.7
MW-1	04/30/2003	<50	<0.50	<0.50	<0.50	<1.0	NA	<5.0	NA	NA	NA	NA	NA	NA	NA	40.94	2.76	38.18	3.6
MW-1	07/14/2003	<50	<0.50	<0.50	<0.50	<1.0	NA	<1.4	<2.0	<2.0	<2.0	<5.0	NA	NA	NA	40.94	3.15	37.79	0.5
MW-1	10/23/2003	<50	<0.50	<0.50	<0.50	<1.0	NA	0.64	<2.0	<2.0	<2.0	<5.0	NA	NA	NA	40.94	3.82	37.12	3.9
MW-1	01/05/2004	<50	<0.50	<0.50	<0.50	<1.0	NA	<0.50	<2.0	<2.0	<2.0	<5.0	NA	NA	NA	40.94	3.39	37.55	1.8
MW-1	04/14/2004	<50	<0.50	<0.50	<0.50	<1.0	NA	<0.50	<2.0	<2.0	<2.0	<5.0	NA	NA	NA	40.94	3.43	37.51	4.5
MW-1	07/13/2004	<50	<0.50	<0.50	0.53	1.4	NA	<0.50	<2.0	<2.0	<2.0	<5.0	NA	NA	NA	40.94	3.70	37.24	2.5
MW-1	10/25/2004	<50	<0.50	<0.50	<0.50	<1.0	NA	<0.50	<2.0	<2.0	<2.0	<5.0	NA	NA	NA	40.94	3.60	37.34	5.45
MW-1	01/06/2005	<50	<0.50	<0.50	<0.50	<1.0	NA	<0.50	<2.0	<2.0	<2.0	<5.0	NA	NA	NA	40.94	2.90	38.04	1.5
MW-1	05/19/2005	<50	<0.50	<0.50	<0.50	1.2	NA	<0.50	<2.0	<2.0	<2.0	<5.0	NA	NA	NA	40.94	3.35	37.59	1.2
MW-1	07/19/2005	<50	<0.50	<0.50	<0.50	1.3	NA	<0.50	<2.0	<2.0	<2.0	<5.0	NA	NA	NA	40.94	3.45	37.49	NA
MW-1	10/17/2005	<50	<0.50	<0.50	<0.50	<1.0	NA	<0.50	<2.0	<2.0	<2.0	<5.0	NA	NA	NA	40.94	3.45	37.49	0.31
MW-1	03/07/2006	<50.0	<0.500	<0.500	<0.500	<0.500	NA	<0.500	<0.500	<0.500	<0.500	<10.0	NA	NA	NA	40.94	2.05	38.89	0.5
MW-1	09/05/2006	NA	NA	NA	NA	NA	NA	NA	NA	NA	NA	NA	NA	NA	NA	40.94	3.34	37.60	NA
MW-1	03/16/2007	<50	<0.50	<0.50	<0.50	<0.50	NA	<0.50	<0.50	<0.50	<0.50	<20	NA	NA	NA	40.94	2.67	38.27	0.77
MW-1	09/11/2007	NA	NA	NA	NA	NA	NA	NA	NA	NA	NA	NA	NA	NA	NA	40.94	3.68	37.26	NA
MW-1	03/10/2008	<50 h	<0.50	<1.0	<1.0	<1.0	NA	<1.0	<2.0	<2.0	<2.0	<10	<100	NA	NA	40.94	4.04	36.90	2.01
MW-1	09/08/2008	NA	NA	NA	NA	NA	NA	NA	NA	NA	NA	NA	NA	NA	NA	40.94	3.51	37.43	NA
MW-1	02/25/2009	<50	<0.50	<1.0	<1.0	<1.0	NA	<1.0	<2.0	<2.0	<2.0	<10	NA	NA	NA	40.94	2.80	38.14	0.69
MW-1	09/11/2009	NA	NA	NA	NA	NA	NA	NA	NA	NA	NA	NA	NA	NA	NA	40.94	4.84	36.10	NA
MW-2	07/12/1989	60	2.7	<1	<1	<3	NA	NA	NA	NA	NA	NA	NA	NA	NA	34.89	3.66	31.23	NA
MW-2	01/30/1990	<50	6.6	<0.5	0.54	0.93	NA	NA	NA	NA	NA	NA	NA	NA	NA	34.89	3.49	31.40	NA
MW-2	04/27/1990	60	2.1	<0.5	<0.5	<0.5	NA	NA	NA	NA	NA	NA	NA	NA	NA	34.89	3.79	31.10	NA
MW-2	07/31/1990	70	1.5	<0.5	<0.5	<0.5	NA	NA	NA	NA	NA	NA	NA	NA	NA	34.89	4.03	30.86	NA
MW-2	10/30/1990	70	<0.5	0.7	<0.5	1.6	NA	NA	NA	NA	NA	NA	NA	NA	NA	34.89	4.21	30.68	NA
MW-2	01/31/1991	80	<0.5	<0.5	0.9	1.9	NA	NA	NA	NA	NA	NA	NA	NA	NA	34.89	4.09	30.80	NA
MW-2	04/30/1991	100	5.9	0.6	0.7	2	NA	NA	NA	NA	NA	NA	NA	NA	NA	34.89	3.95	30.94	NA

**WELL CONCENTRATIONS**  
**Shell-branded Service Station**  
**29 Wildwood Avenue**  
**Piedmont, CA**

Well ID	Date	TPPH (ug/L)	B (ug/L)	T (ug/L)	E (ug/L)	X (ug/L)	MTBE 8020 (ug/L)	MTBE 8260 (ug/L)	DIPE (ug/L)	ETBE (ug/L)	TAME (ug/L)	TBA (ug/L)	Ethanol (ug/L)	1,2- DCA (ug/L)	EDB (ug/L)	TOC (MSL)	Depth to Water (ft.)	GW Elevation (MSL)	DO Reading (ppm)
MW-2	07/30/1991	<50	<0.5	<0.7	<0.5	<0.5	NA	NA	NA	NA	NA	NA	NA	NA	NA	34.89	4.07	30.82	NA
MW-2	10/29/1991	<50	<0.5	<0.5	<0.5	<0.5	NA	NA	NA	NA	NA	NA	NA	NA	NA	34.89	4.11	30.78	NA
MW-2	01/20/1992	<30	0.84	<0.3	<0.41	<0.48	NA	NA	NA	NA	NA	NA	NA	NA	NA	34.89	3.86	31.03	NA
MW-2	04/14/1992	70	16	<0.5	3.1	2.1	NA	NA	NA	NA	NA	NA	NA	NA	NA	34.89	3.66	34.30	NA
MW-2	07/21/1992	<50	<0.5	<0.5	<0.5	<0.5	NA	NA	NA	NA	NA	NA	NA	NA	NA	34.89	3.92	30.97	NA
MW-2	10/02/1992	<50	<0.5	<0.5	<0.5	<0.5	NA	NA	NA	NA	NA	NA	NA	NA	NA	34.89	4.45	30.44	NA
MW-2	01/20/1993	<50	3.8	<0.5	0.52	<0.5	NA	NA	NA	NA	NA	NA	NA	NA	NA	34.89	3.74	31.15	NA
MW-2	05/03/1993	680a	2.8	<0.5	<0.5	<0.5	NA	NA	NA	NA	NA	NA	NA	NA	NA	34.89	3.77	31.12	0.9
MW-2	06/28/1993	NA	NA	NA	NA	NA	NA	NA	NA	NA	NA	NA	NA	NA	NA	34.89	3.96	30.93	NA
MW-2	07/21/1993	<50	8	1.2	1.8	7.9	NA	NA	NA	NA	NA	NA	NA	NA	NA	34.89	4.39	30.50	5.9
MW-2	10/19/1993	<50	<0.5	<0.5	<0.5	<0.5	NA	NA	NA	NA	NA	NA	NA	NA	NA	34.89	3.92	30.97	5.7
MW-2	01/20/1994	<50	1.5	<0.5	<0.5	<0.5	NA	NA	NA	NA	NA	NA	NA	NA	NA	34.89	4.45	30.44	3.2
MW-2	04/12/1994	<50	2.9	<0.5	<0.5	<0.5	NA	NA	NA	NA	NA	NA	NA	NA	NA	34.89	4.72	30.17	11.4
MW-2	07/20/1994	<50	<0.5	<0.5	<0.5	<0.5	NA	NA	NA	NA	NA	NA	NA	NA	NA	34.89	5.32	29.57	2.4
MW-2	10/06/1994	<50	<0.5	<0.5	<0.5	<0.5	NA	NA	NA	NA	NA	NA	NA	NA	NA	34.89	4.03	30.86	2.9
MW-2	01/20/1995	290	28	<0.5	<0.5	<0.5	NA	NA	NA	NA	NA	NA	NA	NA	NA	34.89	3.89	31.00	4.6
MW-2	07/06/1995	120	3	<0.5	<0.5	<0.5	NA	NA	NA	NA	NA	NA	NA	NA	NA	34.89	8.84	26.05	NA
MW-2	01/24/1996	70	3.1	<0.5	0.8	1.5	NA	NA	NA	NA	NA	NA	NA	NA	NA	34.89	3.80	31.09	NA
MW-2 (D)	01/24/1996	70	3.2	0.5	0.7	1.5	NA	NA	NA	NA	NA	NA	NA	NA	NA	34.89	NA	NA	NA
MW-2	07/12/1996	<50	0.68	<0.5	<0.5	<0.5	270	NA	NA	NA	NA	NA	NA	NA	NA	34.89	3.85	31.04	3.8
MW-2	01/16/1997	230	34	1.6	1.6	4.2	460	NA	NA	NA	NA	NA	NA	NA	NA	34.89	3.84	31.05	NA
MW-2	10/24/1997	<50	<0.50	<0.50	<0.50	<0.50	54	NA	NA	NA	NA	NA	NA	NA	NA	34.89	3.75	31.14	2.9
MW-2	05/13/1998	NA	NA	NA	NA	NA	NA	NA	NA	NA	NA	NA	NA	NA	NA	34.89	3.78	31.11	NA
MW-2	10/01/1998	<50	<0.50 c	<0.50 c	<0.50 c	<0.50 c	100	NA	NA	NA	NA	NA	NA	NA	NA	34.89	4.90	29.99	3.0
MW-2	04/29/1999	NA	NA	NA	NA	NA	NA	NA	NA	NA	NA	NA	NA	NA	NA	34.89	4.69	30.20	NA
MW-2	11/01/1999	<50.0	<0.500	1.29	0.669	4.52	7.21	NA	NA	NA	NA	NA	NA	NA	NA	34.89	5.24	29.65	2.9
MW-2	04/05/2000	376 d	68.1 d	3.10 d	2.88 d	5.35 d	729 d	NA	NA	NA	NA	NA	NA	NA	NA	34.89	3.43	31.46	3.6
MW-2	10/30/2000	5,790	59.2	315	162	1320	346	NA	NA	NA	NA	NA	NA	NA	NA	34.89	2.35	32.54	2.8
MW-2	04/27/2001	2,720	90.8	22.8	18.1	165	512	578	NA	NA	NA	NA	NA	NA	NA	34.89	4.67	30.22	0.9
MW-2	10/31/2001	<10,000	<100	<100	<100	<100	NA	<100	<100	<100	<100	<1,000	150,000	NA	NA	34.89	3.68	31.21	1.3
MW-2	05/09/2002	490	1.5	7.8	2.1	14	NA	200	NA	NA	NA	NA	NA	NA	NA	34.89	3.18	31.71	1.1
MW-2	07/25/2002	1,200	1.0	3.3	1.3	8.3	NA	45	NA	NA	NA	NA	NA	NA	NA	34.89	3.30	31.59	0.4
MW-2	10/23/2002	1,100	0.85	3.8	1.3	7.9	NA	140	<2.0	<2.0	<2.0	<50	NA	<2.0	<2.0	37.87	3.87	34.00	0.8
MW-2	01/22/2003	730	<0.50	100	0.96	5.4	NA	230	NA	NA	NA	NA	NA	NA	NA	37.87	2.68	35.19	1.5

**WELL CONCENTRATIONS**  
**Shell-branded Service Station**  
**29 Wildwood Avenue**  
**Piedmont, CA**

Well ID	Date	TPPH (ug/L)	B (ug/L)	T (ug/L)	E (ug/L)	X (ug/L)	MTBE 8020 (ug/L)	MTBE 3260 (ug/L)	DIPE (ug/L)	ETBE (ug/L)	TAME (ug/L)	TBA (ug/L)	Ethanol (ug/L)	1,2- DCA (ug/L)	EDB (ug/L)	TOC (MSL)	Depth to Water (ft.)	GW Elevation (MSL)	DO Reading (ppm)
MW-2	04/30/2003	<500	<5.0	23	<5.0	<10	NA	410	NA	NA	NA	NA	NA	NA	NA	37.87	3.42	34.45	0.1
MW-2	07/14/2003	<800	1.2	59	1.4	9.8	NA	60	<2.0	<2.0	<2.0	8.6	7,000	NA	NA	37.87	3.50	34.37	1.1
MW-2	10/23/2003	2,000	1.7	0.88	1.5	<1.0	NA	0.98	<2.0	<2.0	<2.0	<5.0	<50	NA	NA	37.87	5.08	32.79	0.8
MW-2	01/05/2004	240	<0.50	8.3	<0.50	1.8	NA	64	<2.0	<2.0	<2.0	<5.0	<50	NA	NA	37.87	2.59	35.28	0.4
MW-2	04/14/2004	81	4.8	10	1.0	5.3	NA	170	<2.0	<2.0	<2.0	9.7	<50	NA	NA	37.87	4.15	33.72	0.2
MW-2	07/13/2004	280	1.1	44	2.4	10	NA	85	<2.0	<2.0	<2.0	5.1	<50	NA	NA	37.87	4.20	33.67	0.1
MW-2	10/25/2004	150	0.75	13	1.3	6.3	NA	41	<2.0	<2.0	<2.0	5.1	<50	NA	NA	38.32 f	4.65	33.67	3.30
MW-2	01/06/2005	180	7.1	4.3	0.79	3.3	NA	120	<2.0	<2.0	<2.0	14	<50	NA	NA	38.32	3.30	35.02	0.5
MW-2	05/19/2005	130	<0.50	4.4	0.90	4.0	NA	16	<2.0	<2.0	<2.0	<5.0	<50	NA	NA	38.32	4.00	34.32	0.5
MW-2	07/19/2005	60	1.2	0.70	<0.50	1.2	NA	120	<2.0	<2.0	<2.0	13	<50	NA	NA	38.32	4.00	34.32	1.64
MW-2	10/17/2005	86	<0.50	1.1	<0.50	2.1	NA	86	<2.0	<2.0	<2.0	24	<50	NA	NA	38.32	3.62	34.70	0.31
MW-2	03/07/2006	217	<0.500	0.870	0.660	3.22	NA	54.6	<0.500	<0.500	<0.500	12.1	<50.0	NA	NA	38.32	3.10	35.22	0.2
MW-2	09/05/2006	NA	NA	NA	NA	NA	NA	NA	NA	NA	NA	NA	NA	NA	NA	38.32	3.98	34.34	NA
MW-2	03/16/2007	<50	4.7	<0.50	<0.50	<0.50	NA	14	<0.50	<0.50	<0.50	<20	<100	NA	NA	38.32	3.62	34.70	0.21
MW-2	09/11/2007	NA	NA	NA	NA	NA	NA	NA	NA	NA	NA	NA	NA	NA	NA	38.32	3.93	34.39	NA
MW-2	03/10/2008	87 h	11	<1.0	<1.0	<1.0	NA	18	<2.0	<2.0	<2.0	17	<100	NA	NA	38.32	3.70	34.62	0.25
MW-2	09/08/2008	NA	NA	NA	NA	NA	NA	NA	NA	NA	NA	NA	NA	NA	NA	38.32	3.72	34.60	NA
MW-2	09/08/2008	NA	NA	NA	NA	NA	NA	NA	NA	NA	NA	NA	NA	NA	NA	38.32	3.79	34.53	0.65
MW-2	02/25/2009	<50	3.2	<1.0	<1.0	<1.0	NA	6.5	<2.0	<2.0	<2.0	11	<100	NA	NA	38.32	4.34	33.98	NA
MW-2	09/11/2009	NA	NA	NA	NA	NA	NA	NA	NA	NA	NA	NA	NA	NA	NA	38.32	4.34	33.98	NA
MW-3	07/12/1989	3,900	380	41	99	30	NA	NA	NA	NA	NA	NA	NA	NA	NA	35.00	3.83	31.17	NA
MW-3	01/30/1990	5,500	440	35	79	130	NA	NA	NA	NA	NA	NA	NA	NA	NA	35.00	3.24	31.76	NA
MW-3	04/27/1990	4,500	310	26	37	110	NA	NA	NA	NA	NA	NA	NA	NA	NA	35.00	4.02	30.98	NA
MW-3	07/31/1990	3,500	210	17	8.4	62	NA	NA	NA	NA	NA	NA	NA	NA	NA	35.00	4.31	30.69	NA
MW-3	10/30/1990	2,300	610	<0.5	<0.5	28	NA	NA	NA	NA	NA	NA	NA	NA	NA	35.00	4.52	30.48	NA
MW-3	01/31/1991	4,100	300	20	19	81	NA	NA	NA	NA	NA	NA	NA	NA	NA	35.00	4.33	30.67	NA
MW-3	04/30/1991	3,800	370	19	8.6	60	NA	NA	NA	NA	NA	NA	NA	NA	NA	35.00	3.79	31.21	NA
MW-3	07/30/1991	3,300	160	13	15	87	NA	NA	NA	NA	NA	NA	NA	NA	NA	35.00	4.37	30.63	NA
MW-3	10/29/1991	1,000	35	2.8	2.9	8.1	NA	NA	NA	NA	NA	NA	NA	NA	NA	35.00	4.00	31.00	NA
MW-3	01/20/1992	6,900	380	18	47	48	NA	NA	NA	NA	NA	NA	NA	NA	NA	35.00	3.87	31.13	NA
MW-3	04/14/1992	6,000	480	38	41	55	NA	NA	NA	NA	NA	NA	NA	NA	NA	35.00	3.15	31.85	NA
MW-3	07/21/1992	3,700	330	13	30	23	NA	NA	NA	NA	NA	NA	NA	NA	NA	35.00	4.17	30.83	NA
MW-3	10/02/1992	4,200	260	10	13	12	NA	NA	NA	NA	NA	NA	NA	NA	NA	35.00	4.43	30.57	NA
MW-3	01/20/1993	4,200	360	15	32	26	NA	NA	NA	NA	NA	NA	NA	NA	NA	35.00	2.20	32.80	NA



**WELL CONCENTRATIONS**  
**Shell-branded Service Station**  
**29 Wildwood Avenue**  
**Piedmont, CA**

Well ID	Date	TPPH (ug/L)	B (ug/L)	T (ug/L)	E (ug/L)	X (ug/L)	MTBE 3020 (ug/L)	MTBE 8260 (ug/L)	DIPE (ug/L)	ETBE (ug/L)	TAME (ug/L)	TBA (ug/L)	Ethanol (ug/L)	1,2- DCA (ug/L)	EDB (ug/L)	TOC (MSL)	Depth to Water (ft.)	GW Elevation (MSL)	DO Reading (ppm)
MW-3 (D)	01/20/1993	3,900	370	15	32	26	NA	NA	NA	NA	NA	NA	NA	NA	NA	35.00	NA	NA	NA
MW-3	05/03/1993	12,000	290	520	120	620	NA	NA	NA	NA	NA	NA	NA	NA	NA	35.00	3.50	31.50	0.6
MW-3	06/28/1993	NA	NA	NA	NA	NA	NA	NA	NA	NA	NA	NA	NA	NA	NA	35.00	4.08	30.92	NA
MW-3	07/21/1993	2,000	170	12	<10	11	NA	NA	NA	NA	NA	NA	NA	NA	NA	35.00	4.12	30.88	4.3
MW-3 (D)	07/21/1993	2,000	170	10	<10	14	NA	NA	NA	NA	NA	NA	NA	NA	NA	35.00	NA	NA	NA
MW-3	10/19/1993	2,000	240	<0.5	<0.5	<0.5	NA	NA	NA	NA	NA	NA	NA	NA	NA	35.00	4.20	30.80	5.7
MW-3	01/20/1994	4,200	280	<10	<10	<10	NA	NA	NA	NA	NA	NA	NA	NA	NA	35.00	4.08	30.92	4.1
MW-3 (D)	01/20/1994	3,800	250	<10	<10	<10	NA	NA	NA	NA	NA	NA	NA	NA	NA	35.00	NA	NA	4.1
MW-3	04/12/1994	4,700	380	<10	<10	<10	NA	NA	NA	NA	NA	NA	NA	NA	NA	35.00	3.70	31.30	10.6
MW-3 (D)	04/12/1994	3,400	370	<25	<25	<25	NA	NA	NA	NA	NA	NA	NA	NA	NA	35.00	NA	NA	NA
MW-3	07/20/1994	5,100	320	77	15	34	NA	NA	NA	NA	NA	NA	NA	NA	NA	35.00	4.26	30.74	2.3
MW-3 (D)	07/20/1994	4,400	250	14	13	32	NA	NA	NA	NA	NA	NA	NA	NA	NA	35.00	NA	NA	NA
MW-3	10/06/1994	4,300	280	9.7	4	15	NA	NA	NA	NA	NA	NA	NA	NA	NA	35.00	4.31	30.69	2.3
MW-3	01/20/1995	4,600	180	18	16	10	NA	NA	NA	NA	NA	NA	NA	NA	NA	35.00	3.00	32.00	11.1
MW-3 (D)	01/20/1995	4,300	170	12	15	7.2	NA	NA	NA	NA	NA	NA	NA	NA	NA	35.00	NA	NA	NA
MW-3	07/06/1995	3,900	310	<0.5	7.6	13	NA	NA	NA	NA	NA	NA	NA	NA	NA	35.00	3.75	31.25	NA
MW-3 (D)	07/06/1995	4,100	330	<0.5	7.9	2.4	NA	NA	NA	NA	NA	NA	NA	NA	NA	35.00	NA	NA	NA
MW-3	01/24/1996	5,000	210	14	14	12	NA	NA	NA	NA	NA	NA	NA	NA	NA	35.00	3.26	31.74	NA
MW-3	07/12/1996	2,700	210	<0.5	<0.5	<0.5	3,600	NA	NA	NA	NA	NA	NA	NA	NA	35.00	3.77	31.23	2.4
MW-3 (D)	07/12/1996	2,800	210	<0.5	<0.5	<0.5	3,400	NA	NA	NA	NA	NA	NA	NA	NA	35.00	NA	NA	2.4
MW-3	01/16/1997	4,200	130	19	10	34	4,400	4,600	NA	NA	NA	NA	NA	NA	NA	35.00	2.38	32.62	2.3
MW-3	10/24/1997	4,100	270	9	5.1	8.8	2,000	NA	NA	NA	NA	NA	NA	NA	NA	35.00	4.12	30.88	1.9
MW-3 (D)	10/24/1997	1,700	220	<5.0	<5.0	<5.0	1,500	NA	NA	NA	NA	NA	NA	NA	NA	35.00	NA	NA	1.9
MW-3	05/13/1998	NA	NA	NA	NA	NA	NA	NA	NA	NA	NA	NA	NA	NA	NA	35.00	4.15	30.85	2.0
MW-3	10/01/1998	1,400	84 c	<5.0 c	<5.0 c	<5.0 c	2,300	NA	NA	NA	NA	NA	NA	NA	NA	35.00	NA	NA	2.0
MW-3 (D)	10/01/1998	2,100	100 c	<10 c	<10 c	<10 c	2,600	NA	NA	NA	NA	NA	NA	NA	NA	35.00	4.27	30.73	NA
MW-3	04/29/1999	NA	NA	NA	NA	NA	NA	NA	NA	NA	NA	NA	NA	NA	NA	35.00	4.65	30.35	2.2
MW-3	11/01/1999	1,850	94.3	6.09	<5.00	6.67	4,140	NA	NA	NA	NA	NA	NA	NA	NA	35.00	3.50	31.50	2.7
MW-3	04/05/2000	3,070	96.9	12.1	<10.0	<10.0	1,050	NA	NA	NA	NA	NA	NA	NA	NA	35.00	3.40	31.60	3.1
MW-3	10/30/2000	1,570	56.8	1.91	1.39	3.06	572	524	NA	NA	NA	NA	NA	NA	NA	35.00	3.67	31.33	0.9
MW-3	04/27/2001	2,420	103	12.6	<5.00	15.6	314	NA	NA	NA	NA	NA	NA	NA	NA	35.00	3.79	31.21	1.6
MW-3	10/31/2001	<50	0.71	<0.50	<0.50	<0.50	NA	31	<2.0	<2.0	<2.0	<50	<500	NA	NA	35.00	3.76	31.24	0.9
MW-3	05/09/2002	2,000	52	<10	<10	<10	NA	4,100	NA	NA	NA	NA	NA	NA	NA	35.00	4.17	30.83	3.7
MW-3	07/25/2002	1,800	50	<5.0	<5.0	<5.0	NA	1,900	NA	NA	NA	NA	NA	NA	NA	35.00	4.17	30.83	3.7

**WELL CONCENTRATIONS**  
**Shell-branded Service Station**  
**29 Wildwood Avenue**  
**Piedmont, CA**

Well ID	Date	TPPH (ug/L)	B (ug/L)	T (ug/L)	E (ug/L)	X (ug/L)	MTBE 8020 (ug/L)	MTBE 8260 (ug/L)	DIPE (ug/L)	ETBE (ug/L)	TAME (ug/L)	TBA (ug/L)	Ethanol (ug/L)	1,2- DCA (ug/L)	EDB (ug/L)	TOC (MSL)	Depth to Water (ft.)	GW Elevation (MSL)	DO Reading (ppm)
MW-3	10/23/2002	1,700	27	<5.0	<5.0	<5.0	NA	1,400	<5.0	<5.0	7.4	300	NA	<5.0	<5.0	37.97	4.36	33.61	1.6
MW-3	01/22/2003	1,800	38	2.4	1.5	2.4	NA	390	NA	NA	NA	NA	NA	NA	NA	37.97	3.09	34.88	1.3
MW-3	04/30/2003	3,300	56	5.2	<5.0	<10	NA	540	NA	NA	NA	NA	NA	NA	NA	37.97	3.39	34.58	1.5
MW-3	07/14/2003	1,000	20	2.7	<2.5	<5.0	NA	360	<10	<10	<10	72	<250	NA	NA	37.97	4.05	33.92	1.5
MW-3	10/23/2003	2,100	27	<5.0	<5.0	<10	NA	260	<20	<20	<20	<50	<500	NA	NA	37.97	4.32	33.65	1.0
MW-3	01/05/2004	2,800	91	6.0	<5.0	<10	NA	1,100	<20	<20	<20	450	510	NA	NA	37.97	1.89	36.08	1.8
MW-3	04/14/2004	3,400	47	<5.0	<5.0	<10	NA	360	<20	<20	<20	260	<500	NA	NA	37.97	3.64	34.33	3.6
MW-3	07/13/2004	2,300	21	<5.0	<5.0	<10	NA	210	<20	<20	<20	190	<500	NA	NA	37.97	4.27	33.70	2.7
MW-3	10/25/2004	1,600	21	<5.0	<5.0	<10	NA	190	<20	<20	<20	100	<500	NA	NA	37.97	3.87	34.10	3.65
MW-3	01/06/2005	2,300	46	4.3	2.9	5.8	NA	120	<8.0	<8.0	<8.0	480	<200	NA	NA	37.97	2.30	35.67	2.5
MW-3	05/19/2005	1,600	61	4.1	1.9	3.1	NA	110	<2.0	<2.0	<2.0	610	<50	NA	NA	37.97	3.44	34.53	1.1
MW-3	07/19/2005	2,800	88	8.2	4.3	6.5	NA	100	<10	<10	<10	240	<250	NA	NA	37.97	3.32	34.65	3.08
MW-3	10/17/2005	2,200	83	5.9	2.8	5.2	NA	110	<2.0	<2.0	<2.0	200	<50	NA	NA	37.97	3.92	34.05	0.18
MW-3	03/07/2006	6,820	110	7.59	4.41	8.48	NA	49.8	<0.500	<0.500	<0.500	28.9	<50.0	NA	NA	37.97	1.65	36.32	0.3
MW-3	09/05/2006	4,630	31.5	3.75	1.40	4.18	NA	38.4	<0.500	<0.500	<0.500	17.4	<50.0	NA	NA	37.97	3.79	34.18	0.75
MW-3	03/16/2007	2,200	65	<5.0	<5.0	<5.0	NA	27	<5.0	<5.0	<5.0	<200	<1,000	NA	NA	37.97	2.95	35.02	0.21
MW-3	09/11/2007	1,500 h	20	2.2	0.80 i	2.77 i	NA	19	<2.0	<2.0	<2.0	11	<100	NA	NA	37.97	3.83	34.14	0.08
MW-3	03/10/2008	2,100 h	40	3.0	1.2	2.5	NA	20	<2.0	<2.0	<2.0	19	<100	NA	NA	37.97	3.03	34.94	0.55
MW-3	09/08/2008	980	30	14	5.5	27.0	NA	16	<2.0	<2.0	<2.0	27	<100	NA	NA	37.97	4.00	33.97	0.16
MW-3	02/25/2009	2,600	38	2.9	1.4	2.6	NA	12	<2.0	<2.0	<2.0	14	<100	NA	NA	37.97	3.17	34.80	0.88
MW-3	09/11/2009	1,800	21	2.6	1.2	3.8	NA	17	<2.0	<2.0	<2.0	53	<100	NA	NA	37.97	4.12	33.85	0.64
MW-4	01/30/1990	<50	<0.5	<0.5	<0.5	<0.5	NA	NA	NA	NA	NA	NA	NA	NA	NA	33.73	4.50	29.23	NA
MW-4	04/27/1990	130 a	<0.5	<0.5	<0.5	<0.5	NA	NA	NA	NA	NA	NA	NA	NA	NA	33.73	3.62	30.11	NA
MW-4	07/31/1990	<50	<0.5	<0.5	<0.5	<0.5	NA	NA	NA	NA	NA	NA	NA	NA	NA	33.73	4.19	29.54	NA
MW-4	10/30/1990	<50	<0.5	<0.5	<0.5	<0.5	NA	NA	NA	NA	NA	NA	NA	NA	NA	33.73	4.49	29.24	NA
MW-4	01/31/1991	50a	<0.5	<0.5	<0.5	<0.5	NA	NA	NA	NA	NA	NA	NA	NA	NA	33.73	4.02	29.71	NA
MW-4	04/30/1991	<50	<0.5	<0.5	<0.5	<0.5	NA	NA	NA	NA	NA	NA	NA	NA	NA	33.73	4.39	29.34	NA
MW-4	07/30/1991	<50	<0.5	<0.5	<0.5	<0.5	NA	NA	NA	NA	NA	NA	NA	NA	NA	33.73	3.75	29.98	NA
MW-4	10/29/1991	<50	<0.5	<0.5	<0.5	<0.5	NA	NA	NA	NA	NA	NA	NA	NA	NA	33.73	3.94	29.79	NA
MW-4	01/20/1992	<30	<0.3	<0.3	<0.3	<0.3	NA	NA	NA	NA	NA	NA	NA	NA	NA	33.73	3.71	30.02	NA
MW-4	04/14/1992	<50	<0.5	<0.5	<0.5	<0.5	NA	NA	NA	NA	NA	NA	NA	NA	NA	33.73	4.02	29.71	NA
MW-4	07/21/1992	<50	<0.5	<0.5	<0.5	<0.5	NA	NA	NA	NA	NA	NA	NA	NA	NA	33.73	4.13	29.60	NA
MW-4	10/02/1992	<50	<0.5	<0.5	<0.5	<0.5	NA	NA	NA	NA	NA	NA	NA	NA	NA	33.73	4.13	29.60	NA

**WELL CONCENTRATIONS**  
**Shell-branded Service Station**  
**29 Wildwood Avenue**  
**Piedmont, CA**

Well ID	Date	TPPH (ug/L)	B (ug/L)	T (ug/L)	E (ug/L)	X (ug/L)	MTBE 8020 (ug/L)	MTBE 8260 (ug/L)	DIPE (ug/L)	ETBE (ug/L)	TAME (ug/L)	TBA (ug/L)	Ethanol (ug/L)	1,2- DCA (ug/L)	EDB (ug/L)	TOC (MSL)	Depth to Water (ft.)	GW Elevation (MSL)	DO Reading (ppm)
MW-4	01/20/1993	<50	<0.5	<0.5	<0.5	<0.5	NA	NA	NA	NA	NA	NA	NA	NA	NA	33.73	3.10	30.63	NA
MW-4	05/03/1993	<50	<0.5	<0.5	<0.5	<0.5	NA	NA	NA	NA	NA	NA	NA	NA	NA	33.73	3.70	30.03	1.7
MW-4	06/28/1993	NA	NA	NA	NA	NA	NA	NA	NA	NA	NA	NA	NA	NA	NA	33.73	3.81	29.92	NA
MW-4	07/21/1993	<50	0.56	<0.5	<0.5	<0.5	NA	NA	NA	NA	NA	NA	NA	NA	NA	33.73	3.81	29.92	4.5
MW-4	10/19/1993	<50	<0.5	<0.5	<0.5	<0.5	NA	NA	NA	NA	NA	NA	NA	NA	NA	33.73	3.94	29.79	5.8
MW-4	01/20/1994	<50	0.71	<0.5	<0.5	<0.5	NA	NA	NA	NA	NA	NA	NA	NA	NA	33.73	4.00	29.73	4.4
MW-4	04/12/1994	<50	<0.5	<0.5	<0.5	<0.5	NA	NA	NA	NA	NA	NA	NA	NA	NA	33.73	4.01	29.72	7.3
MW-4	07/20/1994	160	<0.5	<0.5	<0.5	<0.5	NA	NA	NA	NA	NA	NA	NA	NA	NA	33.73	3.91	29.82	6.4
MW-4	10/06/1994	410	<0.5	<0.5	<0.5	<0.5	NA	NA	NA	NA	NA	NA	NA	NA	NA	33.73	3.99	29.74	5.0
MW-4	01/20/1995	<50	<0.5	<0.5	<0.5	<0.5	NA	NA	NA	NA	NA	NA	NA	NA	NA	33.73	3.56	30.17	4.9
MW-4	07/06/1995	<50	<0.5	<0.5	<0.5	<0.5	NA	NA	NA	NA	NA	NA	NA	NA	NA	33.73	3.85	29.88	NA
MW-4	01/24/1996	<50	<0.5	<0.5	0.6	1.8	NA	NA	NA	NA	NA	NA	NA	NA	NA	33.73	2.56	31.17	NA
MW-4	07/12/1996	<50	<0.5	<0.5	<0.5	<0.5	b	NA	NA	NA	NA	NA	NA	NA	NA	33.73	3.36	30.37	2.7
MW-4	01/16/1997	Well inaccessible		NA	NA	NA	NA	NA	NA	NA	NA	NA	NA	NA	NA	33.73	NA	NA	NA
MW-4	10/24/1997	Well inaccessible		NA	NA	NA	NA	NA	NA	NA	NA	NA	NA	NA	NA	33.73	NA	NA	NA
MW-4	05/13/1998	Well inaccessible		NA	NA	NA	NA	NA	NA	NA	NA	NA	NA	NA	NA	33.73	NA	NA	NA
MW-4	10/01/1998	<50	<0.50 c	<0.50 c	<0.50 c	0.74 c	8.1	NA	NA	NA	NA	NA	NA	NA	NA	33.73	3.90	29.83	2.5
MW-4	04/29/1999	<50	<0.50	<0.50	<0.50	<0.50	5.7	NA	NA	NA	NA	NA	NA	NA	NA	33.73	3.97	29.76	2.1
MW-4	11/01/1999	Well inaccessible		NA	NA	NA	NA	NA	NA	NA	NA	NA	NA	NA	NA	33.73	NA	NA	NA
MW-4	04/05/2000	<50.0	<0.500	<0.500	<0.500	<0.500	3.64	NA	NA	NA	NA	NA	NA	NA	NA	33.73	3.63	30.10	2.1
MW-4	10/30/2000	<50.0	<0.500	<0.500	<0.500	<0.500	<2.50	NA	NA	NA	NA	NA	NA	NA	NA	33.73	3.33	30.40	3.0
MW-4	04/27/2001	<50.0	<0.500	<0.500	<0.500	<0.500	<2.50	NA	NA	NA	NA	NA	NA	NA	NA	33.73	3.48	30.25	2.2
MW-4	10/31/2001	<50	<0.50	<0.50	<0.50	<0.50	NA	<5.0	NA	NA	NA	NA	NA	NA	NA	33.73	3.58	30.15	2.8
MW-4	05/09/2002	<50	<0.50	<0.50	<0.50	<0.50	NA	<5.0	NA	NA	NA	NA	NA	NA	NA	33.73	3.74	29.99	2.0
MW-4	07/25/2002	<50	<0.50	<0.50	<0.50	<0.50	NA	<5.0	NA	NA	NA	NA	NA	NA	NA	33.73	3.71	30.02	1.3
MW-4	10/23/2002	<50	<0.50	<0.50	<0.50	<0.50	NA	<0.50	<2.0	<2.0	<2.0	<5.0	NA	<2.0	<2.0	36.72	3.93	32.79	2.6
MW-4	01/22/2003	<50	<0.50	<0.50	<0.50	<0.50	NA	<5.0	NA	NA	NA	NA	NA	NA	NA	36.72	3.67	33.05	3.1
MW-4	04/30/2003	<50	<0.50	<0.50	<0.50	<1.0	NA	<5.0	NA	NA	NA	NA	NA	NA	NA	36.72	3.46	33.26	2.8
MW-4	07/14/2003	56 a	<0.50	<0.50	<0.50	<1.0	NA	<0.50	<2.0	<2.0	<2.0	<5.0	NA	NA	NA	36.72	3.75	32.97	2.4
MW-4	10/23/2003	<50	<0.50	<0.50	<0.50	<1.0	NA	<0.50	<2.0	<2.0	<2.0	<5.0	NA	NA	NA	36.72	3.93	32.79	2.0
MW-4	01/05/2004	<50	<0.50	<0.50	<0.50	<1.0	NA	<0.50	<2.0	<2.0	<2.0	<5.0	NA	NA	NA	36.72	3.72	33.00	0.8
MW-4	04/14/2004	<50	<0.50	<0.50	<0.50	<1.0	NA	<0.50	<2.0	<2.0	<2.0	<5.0	NA	NA	NA	36.72	3.81	32.91	1.1
MW-4	07/13/2004	<50	<0.50	<0.50	<0.50	<1.0	NA	<0.50	NA	NA	NA	NA	NA	NA	NA	36.72	3.82	32.90	1.6
MW-4	10/25/2004	<50	<0.50	<0.50	<0.50	<1.0	NA	<0.50	NA	NA	NA	NA	NA	NA	NA	36.72	3.63	33.09	2.66

**WELL CONCENTRATIONS**  
**Shell-branded Service Station**  
**29 Wildwood Avenue**  
**Piedmont, CA**

Well ID	Date	TPPH (ug/L)	B (ug/L)	T (ug/L)	E (ug/L)	X (ug/L)	MTBE 8020 (ug/L)	MTBE 8260 (ug/L)	DIPE (ug/L)	ETBE (ug/L)	TAME (ug/L)	TBA (ug/L)	Ethanol (ug/L)	1,2- DCA (ug/L)	EDB (ug/L)	TOC (MSL)	Depth to Water (ft.)	GW Elevation (MSL)	DO Reading (ppm)
MW-4	01/06/2005	<50	<0.50	<0.50	<0.50	<1.0	NA	<0.50	NA	NA	NA	NA	NA	NA	NA	36.72	3.20	33.52	1.6
MW-4	05/19/2005	<50	<0.50	<0.50	<0.50	<1.0	NA	<0.50	NA	NA	NA	NA	NA	NA	NA	36.72	2.95	33.77	0.9
MW-4	07/19/2005	<50	<0.50	<0.50	<0.50	<1.0	NA	<0.50	NA	NA	NA	NA	NA	NA	NA	36.72	3.85	32.87	2.78
MW-4	10/17/2005	<50 g	<0.50	<0.50	<0.50	<1.0	NA	<0.50	NA	NA	NA	NA	NA	NA	NA	36.72	3.80	32.92	0.19
MW-4	03/07/2006	<50.0	<0.500	<0.500	<0.500	<0.500	NA	<0.500	NA	NA	NA	NA	NA	NA	NA	36.72	2.10	34.62	0.2
MW-4	09/05/2006	NA	NA	NA	NA	NA	NA	NA	NA	NA	NA	NA	NA	NA	NA	36.72	3.80	32.92	NA
MW-4	03/16/2007	<50	<0.50	<0.50	<0.50	<0.50	NA	0.63	NA	NA	NA	NA	NA	NA	NA	36.72	3.80	32.92	0.24
MW-4	09/11/2007	NA	NA	NA	NA	NA	NA	NA	NA	NA	NA	NA	NA	NA	NA	36.72	3.70	33.02	NA
MW-4	09/11/2007	NA	NA	NA	NA	NA	NA	NA	NA	NA	NA	NA	NA	NA	NA	36.72	3.80	32.92	2.67
MW-4	03/10/2008	<50 h	<0.50	<1.0	<1.0	<1.0	NA	2.6	NA	NA	NA	NA	NA	NA	NA	36.72	2.46	34.26	NA
MW-4	09/08/2008	NA	NA	NA	NA	NA	NA	NA	NA	NA	NA	NA	NA	NA	NA	36.72	2.41	34.31	1.14
MW-4	02/25/2009	<50	<0.50	<1.0	<1.0	<1.0	NA	3.5	NA	NA	NA	NA	NA	NA	NA	36.72	2.41	34.31	1.14
MW-4	09/11/2009	NA	NA	NA	NA	NA	NA	NA	NA	NA	NA	NA	NA	NA	NA	36.72	3.78	32.94	NA
MW-5	01/30/1990	<50	<0.5	<0.5	<0.5	<0.5	NA	NA	NA	NA	NA	NA	NA	NA	NA	31.38	7.12	24.26	NA
MW-5	04/27/1990	210 a	<0.5	<0.5	<0.5	<0.5	NA	NA	NA	NA	NA	NA	NA	NA	NA	31.38	4.19	27.19	NA
MW-5	07/31/1990	90	<0.5	<0.5	<0.5	<0.5	NA	NA	NA	NA	NA	NA	NA	NA	NA	31.38	4.09	27.29	NA
MW-5	10/30/1990	100	0.8	0.7	0.6	1.4	NA	NA	NA	NA	NA	NA	NA	NA	NA	31.38	4.39	26.99	NA
MW-5	01/31/1991	80 a	<0.5	<0.5	<0.5	<0.5	NA	NA	NA	NA	NA	NA	NA	NA	NA	31.38	4.49	26.89	NA
MW-5	04/30/1991	90	<0.5	<0.5	<0.5	<0.5	NA	NA	NA	NA	NA	NA	NA	NA	NA	31.38	4.27	27.11	NA
MW-5	07/30/1991	90	<0.5	<0.5	<0.5	<0.5	NA	NA	NA	NA	NA	NA	NA	NA	NA	31.38	4.32	27.06	NA
MW-5	10/29/1991	<50	<0.5	<0.5	<0.5	<0.5	NA	NA	NA	NA	NA	NA	NA	NA	NA	31.38	3.79	27.59	NA
MW-5	01/20/1992	<30	<0.3	<0.3	<0.3	<0.3	NA	NA	NA	NA	NA	NA	NA	NA	NA	31.38	4.09	27.29	NA
MW-5	04/14/1992	<50 a	<0.5	<0.5	<0.5	<0.5	NA	NA	NA	NA	NA	NA	NA	NA	NA	31.38	4.12	27.26	NA
MW-5	07/21/1992	74 a	<0.5	<0.5	<0.5	<0.5	NA	NA	NA	NA	NA	NA	NA	NA	NA	31.38	4.13	27.25	NA
MW-5	10/02/1992	76 a	<0.5	<0.5	<0.5	<0.5	NA	NA	NA	NA	NA	NA	NA	NA	NA	31.38	4.30	27.08	NA
MW-5	01/20/1993	72 a	<0.5	<0.5	<0.5	<0.5	NA	NA	NA	NA	NA	NA	NA	NA	NA	31.38	3.12	28.26	NA
MW-5	05/03/1993	70 a	<0.5	<0.5	<0.5	<0.5	NA	NA	NA	NA	NA	NA	NA	NA	NA	31.38	4.07	27.31	1.6
MW-5 (D)	05/04/1993	80 a	<0.5	<0.5	<0.5	<0.5	NA	NA	NA	NA	NA	NA	NA	NA	NA	31.38	NA	NA	NA
MW-5	06/28/1993	NA	NA	NA	NA	NA	NA	NA	NA	NA	NA	NA	NA	NA	NA	31.38	4.08	27.30	NA
MW-5	07/21/1993	<50	<0.5	<0.5	<0.5	<0.5	NA	NA	NA	NA	NA	NA	NA	NA	NA	31.38	4.05	27.33	3.5
MW-5	10/19/1993	51	<0.5	<0.5	<0.5	<0.5	NA	NA	NA	NA	NA	NA	NA	NA	NA	31.38	4.20	27.18	3.8
MW-5	01/20/1994	90	<0.5	<0.5	<0.5	<0.5	NA	NA	NA	NA	NA	NA	NA	NA	NA	31.38	4.40	26.98	4.2
MW-5	04/12/1994	67	<0.5	<0.5	<0.5	<0.5	NA	NA	NA	NA	NA	NA	NA	NA	NA	31.38	4.18	27.20	NA
MW-5	07/20/1994	<50	<0.5	<0.5	<0.5	<0.5	NA	NA	NA	NA	NA	NA	NA	NA	NA	31.38	4.06	27.32	3.2

**WELL CONCENTRATIONS**  
**Shell-branded Service Station**  
**29 Wildwood Avenue**  
**Piedmont, CA**

Well ID	Date	TPPH (ug/L)	B (ug/L)	T (ug/L)	E (ug/L)	X (ug/L)	MTBE 8020 (ug/L)	MTBE 8260 (ug/L)	DIPE (ug/L)	ETBE (ug/L)	TAME (ug/L)	TBA (ug/L)	Ethanol (ug/L)	1,2- DCA (ug/L)	EDB (ug/L)	TOC (MSL)	Depth to Water (ft.)	GW Elevation (MSL)	DO Reading (ppm)
MW-5	10/06/1994	80	<0.5	<0.5	<0.5	<0.5	NA	NA	NA	NA	NA	NA	NA	NA	NA	31.38	4.01	27.37	2.1
MW-5 (D)	10/06/1994	60	<0.5	<0.5	<0.5	<0.5	NA	NA	NA	NA	NA	NA	NA	NA	NA	31.38	NA	NA	NA
MW-5	01/20/1995	<50	<0.5	<0.5	<0.5	<0.5	NA	NA	NA	NA	NA	NA	NA	NA	NA	31.38	3.49	27.89	3.2
MW-5	07/06/1995	<50	<0.5	<0.5	<0.5	<0.5	NA	NA	NA	NA	NA	NA	NA	NA	NA	31.38	4.06	27.32	NA
MW-5	01/24/1996	70	<0.5	<0.5	0.8	2.9	NA	NA	NA	NA	NA	NA	NA	NA	NA	31.38	2.90	28.48	NA
MW-5	07/12/1998	62	<0.5	<0.5	<0.5	<0.5	b	NA	NA	NA	NA	NA	NA	NA	NA	31.38	4.02	27.36	1.9
MW-5	01/16/1997	66	0.91	0.89	<0.50	1.7	<2.5	NA	NA	NA	NA	NA	NA	NA	NA	31.38	2.59	28.79	2.2
MW-5 (D)	01/16/1997	<50	0.7	0.78	<0.50	1.3	<2.5	NA	NA	NA	NA	NA	NA	NA	NA	31.38	NA	NA	2.2
MW-5	10/24/1997	59	<0.50	<0.50	<0.50	<0.50	17	NA	NA	NA	NA	NA	NA	NA	NA	31.38	4.15	27.23	4.6
MW-5	05/13/1998	72	<0.50	<0.50	<0.50	<0.50	<2.5	NA	NA	NA	NA	NA	NA	NA	NA	31.38	3.64	27.74	2.1
MW-5 (D)	05/13/1998	70	<0.50	<0.50	<0.50	<0.50	<2.5	NA	NA	NA	NA	NA	NA	NA	NA	31.38	NA	NA	2.1
MW-5	10/01/1998	57	<0.50 c	<0.50 c	<0.50 c	0.62 c	20	NA	NA	NA	NA	NA	NA	NA	NA	31.38	4.25	27.13	2.2
MW-5	04/29/1999	<50	<0.50	<0.50	<0.50	<0.50	16	NA	NA	NA	NA	NA	NA	NA	NA	31.38	4.56	26.82	2.0
MW-5	11/01/1999	<50.0	<0.500	<0.500	<0.500	<0.500	3.06	NA	NA	NA	NA	NA	NA	NA	NA	31.38	4.19	27.19	2.2
MW-5	04/05/2000	<50.0	<0.500	<0.500	<0.500	<0.500	22.5	NA	NA	NA	NA	NA	NA	NA	NA	31.38	4.34	27.04	2.2
MW-5	10/30/2000	<50.0	<0.500	<0.500	<0.500	<0.500	19.3	NA	NA	NA	NA	NA	NA	NA	NA	31.38	3.25	28.13	4.0
MW-5	04/27/2001	51.5	<0.500	<0.500	<0.500	<0.500	4.29	NA	NA	NA	NA	NA	NA	NA	NA	31.38	4.07	27.31	1.0
MW-5	10/31/2001	210	<0.50	<0.50	<0.50	<0.50	NA	<5.0	NA	NA	NA	NA	NA	NA	NA	31.38	4.02	27.36	1.5
MW-5	05/09/2002	280	0.71	<0.50	<0.50	<0.50	NA	<5.0	NA	NA	NA	NA	NA	NA	NA	31.38	4.31	27.07	1.7
MW-5	07/25/2002	410	<0.50	<0.50	<0.50	<0.50	NA	<5.0	NA	NA	NA	NA	NA	NA	NA	31.38	4.32	27.06	0.7
MW-5	10/23/2002	290	<0.50	<0.50	<0.50	<0.50	NA	<0.50	<2.0	<2.0	<2.0	<50	NA	<2.0	<2.0	34.36	4.37	29.99	2.3
MW-5	01/22/2003	260	<0.50	<0.50	<0.50	<0.50	NA	<5.0	NA	NA	NA	NA	NA	NA	NA	34.36	4.12	30.24	2.4
MW-5	04/30/2003	90 a	<0.50	<0.50	<0.50	<1.0	NA	<5.0	NA	NA	NA	NA	NA	NA	NA	34.36	3.88	30.48	1.5
MW-5	07/14/2003	72 a	<0.50	<0.50	<0.50	<1.0	NA	<0.50	<2.0	<2.0	<2.0	<5.0	NA	NA	NA	34.36	4.57	29.79	1.0
MW-5	10/23/2003	120 e	<0.50	<0.50	<0.50	<1.0	NA	<0.50	<2.0	<2.0	<2.0	<5.0	NA	NA	NA	34.36	4.45	29.91	1.8
MW-5	01/05/2004	120 a	<0.50	<0.50	<0.50	1.1	NA	<0.50	<2.0	<2.0	<2.0	<5.0	NA	NA	NA	34.36	3.33	31.03	0.6
MW-5	04/14/2004	180 a	<0.50	<0.50	<0.50	<1.0	NA	<0.50	<2.0	<2.0	<2.0	<5.0	NA	NA	NA	34.36	4.52	29.84	0.6
MW-5	07/13/2004	150 a	<0.50	<0.50	<0.50	<1.0	NA	<0.50	NA	NA	NA	NA	NA	NA	NA	34.36	4.42	29.94	0.1
MW-5	10/25/2004	85 g	<0.50	<0.50	<0.50	<1.0	NA	<0.50	NA	NA	NA	NA	NA	NA	NA	34.36	4.04	30.32	2.21
MW-5	01/06/2005	88 g	<0.50	<0.50	<0.50	<1.0	NA	<0.50	NA	NA	NA	NA	NA	NA	NA	34.36	4.00	30.36	0.5
MW-5	05/19/2005	99 g	<0.50	<0.50	<0.50	<1.0	NA	<0.50	NA	NA	NA	NA	NA	NA	NA	34.36	4.20	30.16	1.0
MW-5	07/19/2005	100 g	<0.50	<0.50	<0.50	<1.0	NA	0.56	NA	NA	NA	NA	NA	NA	NA	34.36	4.42	29.94	1.19
MW-5	10/17/2005	<50 g	<0.50	<0.50	<0.50	<1.0	NA	0.79	NA	NA	NA	NA	NA	NA	NA	34.36	4.18	30.18	0.84
MW-5	03/07/2006	<50.0	<0.500	<0.500	<0.500	<0.500	NA	2.03	NA	NA	NA	NA	NA	NA	NA	34.36	3.45	30.91	0.8

**WELL CONCENTRATIONS**  
**Shell-branded Service Station**  
**29 Wildwood Avenue**  
**Piedmont, CA**

Well ID	Date	TPPH (ug/L)	B (ug/L)	T (ug/L)	E (ug/L)	X (ug/L)	MTBE 8020 (ug/L)	MTBE 8260 (ug/L)	DIPE (ug/L)	ETBE (ug/L)	TAME (ug/L)	TBA (ug/L)	Ethanol (ug/L)	1,2- DCA (ug/L)	EDB (ug/L)	TOC (MSL)	Depth to Water (ft.)	GW Elevation (MSL)	DO Reading (ppm)
MW-5	09/05/2006	NA	NA	NA	NA	NA	NA	NA	NA	NA	NA	NA	NA	NA	NA	34.36	4.21	30.15	NA
MW-5	03/16/2007	75	<0.50	<0.50	<0.50	<0.50	NA	1.9	NA	NA	NA	NA	NA	NA	NA	34.36	4.42	29.94	0.62
MW-5	09/11/2007	NA	NA	NA	NA	NA	NA	NA	NA	NA	NA	NA	NA	NA	NA	34.36	3.96	30.40	NA
MW-5	03/10/2008	71 h	<0.50	<1.0	<1.0	<1.0	NA	2.9	NA	NA	NA	NA	NA	NA	NA	34.36	4.51	29.85	4.03
MW-5	09/08/2008	NA	NA	NA	NA	NA	NA	NA	NA	NA	NA	NA	NA	NA	NA	34.36	3.87	30.49	NA
MW-5	02/25/2009	120	<0.50	<1.0	<1.0	<1.0	NA	4.1	NA	NA	NA	NA	NA	NA	NA	34.36	3.06	31.30	0.97
MW-5	09/11/2009	NA	NA	NA	NA	NA	NA	NA	NA	NA	NA	NA	NA	NA	NA	34.36	4.23	30.13	NA
E-4	07/12/1989	<50	<0.5	<1	<1	<3	NA	NA	NA	NA	NA	NA	NA	NA	NA	34.63	NA	>39.13	NA
E-4	01/30/1990	<50	<0.5	<0.5	<0.5	<0.5	NA	NA	NA	NA	NA	NA	NA	NA	NA	34.63	NA	>34.63	NA
E-4	04/27/1990	120a	<0.5	<0.5	<0.5	<0.5	NA	NA	NA	NA	NA	NA	NA	NA	NA	34.63	NA	>34.63	NA
E-4	07/31/1990	<50	<0.5	<0.5	<0.5	<0.5	NA	NA	NA	NA	NA	NA	NA	NA	NA	34.63	NA	>34.63	NA
E-4	10/30/1990	<50	<0.5	<0.5	<0.5	<0.5	NA	NA	NA	NA	NA	NA	NA	NA	NA	34.63	NA	>34.63	NA
E-4	01/31/1991	<50	<0.5	<0.5	<0.5	<0.5	NA	NA	NA	NA	NA	NA	NA	NA	NA	34.63	NA	>34.63	NA
E-4	04/30/1991	<50	<0.5	<0.5	<0.5	<0.5	NA	NA	NA	NA	NA	NA	NA	NA	NA	34.63	NA	>34.63	NA
E-4	07/30/1991	<50	<0.5	0.6	<0.5	<0.5	NA	NA	NA	NA	NA	NA	NA	NA	NA	34.63	NA	>34.63	NA
E-4	10/29/1991	<50	<0.5	<0.5	<0.5	<0.5	NA	NA	NA	NA	NA	NA	NA	NA	NA	34.63	NA	>34.63	NA
E-4	01/20/1992	<30	<0.3	<0.3	<0.3	<0.3	NA	NA	NA	NA	NA	NA	NA	NA	NA	34.63	NA	>34.63	NA
E-4	04/14/1992	<50	<0.5	<0.5	<0.5	<0.5	NA	NA	NA	NA	NA	NA	NA	NA	NA	34.63	NA	>34.63	NA
E-4	07/21/1992	<50	<0.5	<0.5	<0.5	<0.5	NA	NA	NA	NA	NA	NA	NA	NA	NA	34.63	NA	>34.63	NA
E-4	10/02/1992	<50	<0.5	<0.5	<0.5	<0.5	NA	NA	NA	NA	NA	NA	NA	NA	NA	34.63	NA	>34.63	NA
E-4	01/20/1993	<50	<0.5	<0.5	<0.5	<0.5	NA	NA	NA	NA	NA	NA	NA	NA	NA	34.63	NA	>34.63	NA
E-4	05/03/1993	<50	<0.5	<0.5	<0.5	<0.5	NA	NA	NA	NA	NA	NA	NA	NA	NA	34.63	NA	>34.63	0.6
E-4	06/28/1993	NA	NA	NA	NA	NA	NA	NA	NA	NA	NA	NA	NA	NA	NA	34.63	NA	>34.63	NA
E-4	07/21/1993	<50	5.4	0.72	1	4.4	NA	NA	NA	NA	NA	NA	NA	NA	NA	34.63	NA	>34.63	5.4
E-4	10/19/1993	<50	<0.5	<0.5	<0.5	<0.5	NA	NA	NA	NA	NA	NA	NA	NA	NA	34.63	NA	>34.63	5.6
E-4	01/20/1994	<50	<0.5	<0.5	<0.5	<0.5	NA	NA	NA	NA	NA	NA	NA	NA	NA	34.63	NA	>34.63	NA
E-4	04/12/1994	<50	<0.5	<0.5	<0.5	<0.5	NA	NA	NA	NA	NA	NA	NA	NA	NA	34.63	NA	>34.63	9.4
E-4	07/20/1994	<50	<0.5	<0.5	<0.5	<0.5	NA	NA	NA	NA	NA	NA	NA	NA	NA	34.63	NA	>34.63	2.0
E-4	10/06/1994	<50	<0.5	<0.5	<0.5	<0.5	NA	NA	NA	NA	NA	NA	NA	NA	NA	34.63	NA	>34.63	1.3
E-4	01/20/1995	<50	<0.5	<0.5	<0.5	<0.5	NA	NA	NA	NA	NA	NA	NA	NA	NA	34.63	NA	>34.63	3.7
E-4	05/16/1995	Well abandoned		NA	NA	NA	NA	NA	NA	NA	NA	NA	NA	NA	NA	NA	NA	NA	NA

**WELL CONCENTRATIONS**  
**Shell-branded Service Station**  
**29 Wildwood Avenue**  
**Piedmont, CA**

Well ID	Date	TPPH (ug/L)	B (ug/L)	T (ug/L)	E (ug/L)	X (ug/L)	MTBE 8020 (ug/L)	MTBE 8260 (ug/L)	DIPE (ug/L)	ETBE (ug/L)	TAME (ug/L)	TBA (ug/L)	Ethanol (ug/L)	1,2- DCA (ug/L)	EDB (ug/L)	TOC (MSL)	Depth to Water (ft.)	GW Elevation (MSL)	DO Reading (ppm)
---------	------	----------------	-------------	-------------	-------------	-------------	------------------------	------------------------	----------------	----------------	----------------	---------------	-------------------	-----------------------	---------------	--------------	----------------------------	--------------------------	------------------------

Abbreviations:

TPPH = Total petroleum hydrocarbons as gasoline by EPA Method 8260B; prior to October 31, 2001, analyzed by EPA Method 8015.

BTEX = Benzene, toluene, ethylbenzene, xylenes by EPA Method 8260B; prior to October 31, 2001, analyzed by EPA Method 8020.

MTBE = Methyl tertiary butyl ether

DIPE = Di-isopropyl ether, analyzed by EPA Method 8260B

ETBE = Ethyl tertiary butyl ether, analyzed by EPA Method 8260B

TAME = Tertiary amyl methyl ether, analyzed by EPA Method 8260B

TBA = Tertiary butyl alcohol, analyzed by EPA Method 8260B

1,2-DCA = 1,2-Dichloroethane, analyzed by EPA Method 8260B

EDB = 1,2-Dibromoethane, analyzed by EPA Method 8260B

TOC = Top of Casing Elevation

SPH = Separate-Phase Hydrocarbons

GW = Groundwater

DO = Dissolved Oxygen

ug/L = Parts per billion

ppm = Parts per million

MSL = Mean sea level

ft. = Feet

<n = Below detection limit

(D) = Duplicate sample

NA = Not applicable

**WELL CONCENTRATIONS**  
**Shell-branded Service Station**  
**29 Wildwood Avenue**  
**Piedmont, CA**

Well ID	Date	TPPH (ug/L)	B (ug/L)	T (ug/L)	E (ug/L)	X (ug/L)	MTBE 8020 (ug/L)	MTBE 8260 (ug/L)	DIPE (ug/L)	ETBE (ug/L)	TAME (ug/L)	TBA (ug/L)	Ethanol (ug/L)	1,2- DCA (ug/L)	EDB (ug/L)	TOC (MSL)	Depth to Water (ft.)	GW Elevation (MSL)	DO Reading (ppm)
---------	------	----------------	-------------	-------------	-------------	-------------	------------------------	------------------------	----------------	----------------	----------------	---------------	-------------------	-----------------------	---------------	--------------	----------------------------	--------------------------	------------------------

Notes:

- a = Chromatogram pattern indicated an unidentified hydrocarbon/Hydrocarbon reported does not match laboratory's standard.
  - b = Due to coelution with early eluters, no result could be determined for MTBE.
  - c = Laboratory reported 1.3 ug/L benzene, 11 ug/L toluene, 0.98 ug/L ethyl benzene, and 6.5 ug/L total xylenes in the equipment blank.
  - d = Result reported was generated out of hold time.
  - e = Sample contains discrete peaks which are Chlorinated solvents, in addition to gasoline.
  - f = Top of casing altered +0.45 feet due to wellhead maintenance on August 2, 2004.
  - g = The concentration reported reflects individual or discrete unidentified peaks not matching a typical fuel pattern.
  - h = Analyzed by EPA Method 8015B (M).
  - i = Analyte was detected at a concentration below the reporting limit and above the laboratory method detection limit. Reported value is estimated.
- Ethanol analyzed by EPA Method 8260B.
- Well E-4 is a flowing artesian well; potentiometric surface above top of casing elevation.
- Site surveyed March 5, 2002 by Virgil Chavez Land Surveying of Vallejo, CA.



**Table 1. Groundwater Analytical Data - Volatile Organic Compounds - Shell-branded Service Station, Incident #98995822 - 29 Wildwood Avenue, Piedmont, California**

Well ID (Qtrs Sampled)	Sample Date	cis-1,2-Dichloroethene	trans-1,2-Dichloroethene	Tetrachloroethene	Trichloroethene	Notes
		←————— (Concentrations in ppb) —————→				
MW-1 (2nd & 4th)	05/13/98	<0.50	<0.50	<0.50	<0.50	a
	10/01/98	<0.50	<0.50	<0.50	<0.50	
	04/29/99	<0.50	<0.50	<0.50	<0.50	
	11/01/99	<0.500	<0.500	<0.500	<0.500	
	04/05/00	<0.500	<0.500	<0.500	<0.500	
	10/30/00	<0.500	<0.500	<0.500	<0.500	
	04/27/01	<0.500	<0.500	<0.500	<0.500	
MW-2 (4th)	10/01/98	<0.50	<0.50	<0.50	<0.50	
	11/01/99	<0.500	<0.500	<0.500	<0.500	
	04/05/00	<0.500	<0.500	<0.500	<0.500	
	10/30/00	<5.00	<5.00	<5.00	<5.00	
	04/27/01	<0.500	<0.500	<0.500	<0.500	
MW-3 (4th)	10/01/98	<0.50	<0.50	<0.50	<0.50	duplicate
	10/01/98	<0.50	<0.50	<0.50	<0.50	
	11/01/99	<0.500	<0.500	<0.500	<0.500	
	04/05/00	<0.500	<0.500	<0.500	<0.500	
	10/30/00	<5.00	<5.00	<5.00	<5.00	
	04/27/01	<0.500	<0.500	<0.500	<0.500	
MW-4 (2nd & 4th)	05/13/98	---	---	---	---	b
	10/01/98	2.5	1.5	3.2	1.1	
	04/29/99	2.2	0.58	2.5	0.78	
	11/01/99	---	---	---	---	b
	04/05/00	1.14	0.655	2.26	0.838	
	10/30/00	2.81	1.24	2.28	1.25	d
	04/27/01	0.687	<0.500	2.31	<0.500	
MW-5 (2nd & 4th)	05/13/98	16	9.3	200	28	a
	05/13/98	16	8.7	190	19	a, duplicate
	10/01/98	9	5.1	95	12	
	04/29/99	6.6	3.3	100	10	
	11/01/99	6.08	<2.50	91.9	11.7	
	04/05/00	8.26	<5.00	130	15.7	c
	10/30/00	<5.00	<5.00	118	12.1	
	04/27/01	<10.0	<10.0	250	14.3	

# LOG OF EXPLORATORY BORING

PROJECT NUMBER 438-37.01

BORING NO. E-1

BY BH DATE 8/15/84

SURFACE ELEV. -

CLASSIFICATION DATA			FIELD DATA			Depth in Ft.	Ground Water Levels	Samples	DESCRIPTION
% Fines (No. 200)	Liquid Limit	Plasticity Index	Compressive Strength (TSF)	Penetration (Blows/Ft.)					
						5			4-inch Concrete FILL - Dark gray (2.5Y N4/0) fine SAND has a very strong product odor - damp (very dark grayish brown (2.5Y 3/2) sandy CLAY has product sheen - wet) BOTTOM OF BORING
						10			

REMARKS: Boring was backfilled to 4-inch with cuttings and capped with 4-inches of concrete.



**ATTACHMENT 6**



# LOG OF EXPLORATORY BORING

PROJECT NUMBER 438-37.01  
 BY BH DATE 8/15/84

BORING NO. E-3  
 SURFACE ELEV. -

CLASSIFICATION DATA			FIELD DATA			Depth in Ft.	Ground Water Levels	Samples	DESCRIPTION
% Finer (No. 200)	Liquid Limit	Plasticity Index	Compressive Strength (TSF)	Penetration (Blow/Ft.)					
				8 5		5		A.A.	4-inch Concrete FILL - Dark olive gray (5Y 3/2) fine SAND has strong product odor - damp  (has strong product sheen)
						10			BOTTOM OF BORING

REMARKS: Boring was backfilled to 4-inches with cuttings and capped with 4-inches of concrete.



# LOG OF EXPLORATORY BORING

PROJECT NUMBER 438-37.01

BORING NO. E-4

BY BH DATE 8/15/84

SURFACE ELEV. -

CLASSIFICATION DATA			FIELD DATA			Depth in Ft.	Ground Water Levels	Sampling	DESCRIPTION
% Fines (No. 200)	Liquid Limit	Plasticity Index	Compressive Strength (TSF)	Penetration (Blows/Ft.)					
						29	5		2-inch Asphalt and 4-inch Baserock (SC)Very dark grayish brown (10YR 3/2) clayey SAND - damp (CL)Dark olive gray (5Y 3/2) sandy CLAY - damp (SC)Dark olive gray (5Y 3/2) clayey SAND - damp (CL)Dark yellowish brown (10YR 3/6) fine sandy CLAY - damp (brown (7.5YR 5/2) sandy - damp to dry) (contains thin gravelly interbeds) (dark brown (7.5YR 3/4) sandy damp)
						35	10		
						35	15		
						70	20		(gray (5Y 5/1) silty very fine sandy - damp to dry)
						58	25		(light olive gray (5Y 6/2) very fine sandy contains minor medium to coarse sand - damp to dry)
						55	30		(SM)Olive gray (5Y 5/2) silty fine SAND - wet (CL)Mottled brown (7.5YR 4/2) and dark yellowish brown (10YR 4/6) CLAY - damp to dry (mottled brown (7.5YR 4/2) and yellowish brown (10YR 5/6) sandy contains thin gravelly interbeds - damp to dry
						65	35		BOTTOM OF BORING

**REMARKS:** Boring was converted to a ground-water monitoring well with the installation of 35 feet of 3-inch PVC casing. The lower 12 feet of casing was slotted and the annular space backfilled to 15 feet with coarse aquarium sand. A bentonite-concrete seal was placed from 15 feet to 1 foot. The well was capped with a protective vault box and a locking device.





ensco  
environmental  
services, inc.

# EXPLORATORY BORING LOG

PROJECT NAME: SHELL STATION  
29 WILDWOOD AVE.  
PIEDMONT, CA

BORING NO. B-1

DATE DRILLED: 8/9/88

PROJECT NUMBER: 1856G

LOGGED BY: RAG

DEPTH (ft.)	SAMPLE No	BLOYS/FOOT 140 ft./lbs.	UNIFIED SOIL CLASSIFICATION	SOIL DESCRIPTION	WATER LEVEL	OVA READING ppm
1	B-1-1	11		Asphalt - 3", baserock - 9"		
2			CH	SILTY CLAY, dark gray (7.5YR 4/0), some fine grained sands, petroleum odor, high plasticity, medium stiff, moist		
3			CL	SANDY CLAY, yellowish brown (10YR 5/6), fine grained sand up to 20%, slight petroleum odor, medium stiff, moist		
4			CL	SANDY CLAY, light gray to olive yellow (2.5YR 7/0 to 2.5 YR 6/6), fine grained sand to 40%, possible petroleum odor, moist, stiff		
5				SANDY CLAY to CLAYEY SAND, mottled light gray to strong brown (7.5YR 7/0 to 7.5YR 5/8), line grained sands at 40 to 60%, no petroleum odor, very stiff to medium dense, very moist to wet. 8/9/88, Groundwater encountered - 9.5 ft.		
6	B-1-2	30	CL-SC	Increasing gravels, up to 0.5" across	▽	0
7				Bottom of boring = 10.5 feet		
8						
9						
10						
11						
12						
13						
14						
15						
16						
17						
18						
19						
20						
21						

SUPERVISED AND APPROVED BY R.G./C.E.G.



ensco  
environmental  
services, Inc.

# EXPLORATORY BORING LOG

PROJECT NAME: SHELL STATION  
29 WILDWOOD AVE.  
PIEDMONT, CA

BORING NO. B-2

DATE DRILLED: 8/9/88

PROJECT NUMBER: 1856G

LOGGED BY: RAG

DEPTH (ft.)	SAMPLE No	BLOYS/FOOT 140 ft/lbs.	UNIFIED SOIL CLASSIFICATION	SOIL DESCRIPTION	WATER LEVEL	COVA READING ppm
1	B-2-1	7		Asphalt - 3", baserock - 9"	▽	175
2			CH	SILTY CLAY, dark gray (7.5YR 4/0), some fine grained sands, no petroleum odor, high plasticity medium stiff, moist		
3			SC	CLAYEY SAND, dark brown (10YR 3/3), fine to medium grained sands, some gravels up to 0.5" across, faint petroleum odor, loose, moist		
4			SW	SAND, dark gray (10YR 4/1), fine to medium grained, strong petroleum odor, loose, very moist, something very hard and resistant at 7 feet, large fragments of red chert 6" across in cuttings		
5				8/9/88. Groundwater encountered - 6 ft.		
6				Refusal at 7 feet		
7						
8						
9						
10						
11						
12						
13						
14						
15						
16						
17						
18						
19						
20						
21						

SUPERVISED AND APPROVED BY R.G./C.E.G.



ensco  
environmental  
services, Inc.

## EXPLORATORY BORING LOG

PROJECT NAME: SHELL STATION  
29 WILDWOOD AVE.  
PIEDMONT, CA

BORING NO. B-3

DATE DRILLED: 8/10/88

PROJECT NUMBER: 1856G

LOGGED BY: RAG

DEPTH (ft.)	SAMPLE No	BLOYS/FOOT 140 ft./lbs.	UNIFIED SOIL CLASSIFICATION	SOIL DESCRIPTION	WATER LEVEL	OVA READING ppm
1				Concrete - 6"		
2				Pea gravel backfill		
3						
4			SC	CLAYEY SAND, brown (10YR 5/3), fine grained sands up to 60%, petroleum odor, loose, moist to very moist		
5	B-3-1	6	CH	SILTY CLAY, black (2.5YR 2/0), some isolated gravels, petroleum odor, high plasticity, medium stiff, moist to very moist		90
6						
7						
8				8/10/88, Groundwater encountered - 8 ft.	▽	
9			CL-SC	SANDY CLAY to CLAYEY SAND, dark gray to gray (2.5y 4/0 to 2.5Y 6/0), fine grained sands, localized clayey and sandy areas, some gravels up to 2" across, strong petroleum odor, medium dense to very stiff, wet		>200
10	B-3-2	20				
11						
12						
13			CL	SILTY CLAY, reddish brown (5YR 4/3), some medium grained sands, possible petroleum odor, hard, damp to moist		
14						
15	B-3-3	74				10
16				Bottom of boring = 15.5 feet		
17						
18						
19						
20						
21						

SUPERVISED AND APPROVED BY R.G./C.E.G.





ensco  
environmental  
services, Inc.

## EXPLORATORY BORING LOG

PROJECT NAME: SHELL STATION  
29 WILDWOOD AVE.  
PIEDMONT, CA

BORING NO. B-4

DATE DRILLED: 8/10/88

PROJECT NUMBER: 1856G

LOGGED BY: FAG

DEPTH (ft.)	SAMPLE No	BLOWS/FOOT 140 ft/lbs.	UNIFIED SOIL CLASSIFICATION	SOIL DESCRIPTION	WATER LEVEL	OVA READING PPM
1				Concrete - 6"		
2				Pea gravel backfill		
3						
4						
5		3		No sample recovery		
6						
7			SP	SAND, dark gray to very dark gray (7.5YR 4/0 to 7.5YR 3/0), fine grained sand, up to 10% clay, strong petroleum odor, loose, very moist to wet, petroleum sheen on sand	▽	
8				8/10/88, Groundwater encountered - 8 ft.		
9						
10	B-4-1	13				250
11			SC	CLAYEY SAND, greenish gray (5G 5/1), fine grained sands up to 60%, some rounded gravels up to 2" across, slight petroleum odor, loose, moist		
12						
13			CL	SILTY CLAY, reddish brown (5YR 4/3), some medium grained sands, slight petroleum odor, hard, damp		
14						
15	B-4-2	68				20
16				Bottom of boring = 15 feet		
17						
18						
19						
20						
21						

SUPERVISED AND APPROVED BY R.G.C.E.G.



ensco  
environmental  
services, inc.

## EXPLORATORY BORING LOG

PROJECT NAME: SHELL STATION  
29 WILDWOOD AVE.  
PIEDMONT, CA

BORING NO. B-5

DATE DRILLED: 8/10/88

PROJECT NUMBER: 1856G

LOGGED BY: RAG

DEPTH (ft.)	SAMPLE No	BLOWS/FOOT 140 ft/lbs.	UNIFIED SOIL CLASSIFICATION	SOIL DESCRIPTION	WATER LEVEL	OVA READING ppm
1				Asphalt - 4", baserock - 8"		
2			CH	SILTY CLAY, grayish brown (10YR 5/2), no petroleum odor, high plasticity, stiff, moist		
3			CH	SILTY CLAY, very dark grayish brown (10YR 3/2), some fine sands and medium gravels, high plasticity, slight petroleum odor, stiff, moist		
4			CH	SILTY CLAY, very dark grayish brown (10YR 3/2), some fine sands and medium gravels, high plasticity, slight petroleum odor, stiff, moist		
5	B-5-1	16	CL	SILTY CLAY to SANDY CLAY, mottled dark gray to strong brown (10YR 4/0 to 10YR 4/6), fine grained sands up to 40%, some medium sized gravels, petroleum odor, stiff, moist		20
6			CL	SILTY CLAY to SANDY CLAY, mottled dark gray to strong brown (10YR 4/0 to 10YR 4/6), fine grained sands up to 40%, some medium sized gravels, petroleum odor, stiff, moist		
7			CL-SC	SANDY CLAY to CLAYEY SAND, mottled dark grayish brown to dark brown (10YR 4/2 to 10YR 4/3), 40 to 60% fine grained sands, no petroleum odor, stiff to medium dense, moist		
8			SC	SANDY CLAY to CLAYEY SAND, mottled dark grayish brown to dark brown (10YR 4/2 to 10YR 4/3), 40 to 60% fine grained sands, no petroleum odor, stiff to medium dense, moist	8/10/88, Water level - 9 ft.	
9			SC	CLAYEY SAND, light yellowish brown, fine grained sands up to 70%, no petroleum odor, medium dense, moist		
10	B-5-2	14	SC-SP	CLAYEY SAND to SAND, mottled light gray to yellowish brown (10YR 7/1 to 10YR 5/6), 70 to 90% fine grained sands, no petroleum odor, medium dense, wet		0
11			SC-SP	CLAYEY SAND to SAND, mottled light gray to yellowish brown (10YR 7/1 to 10YR 5/6), 70 to 90% fine grained sands, no petroleum odor, medium dense, wet		
12				Bottom of boring = 10.5 feet		
13						
14						
15						
16						
17						
18						
19						
20						
21						

SUPERVISED AND APPROVED BY R.G./C.E.G.

### WELL MW-1 (BH-A)

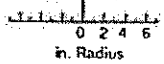
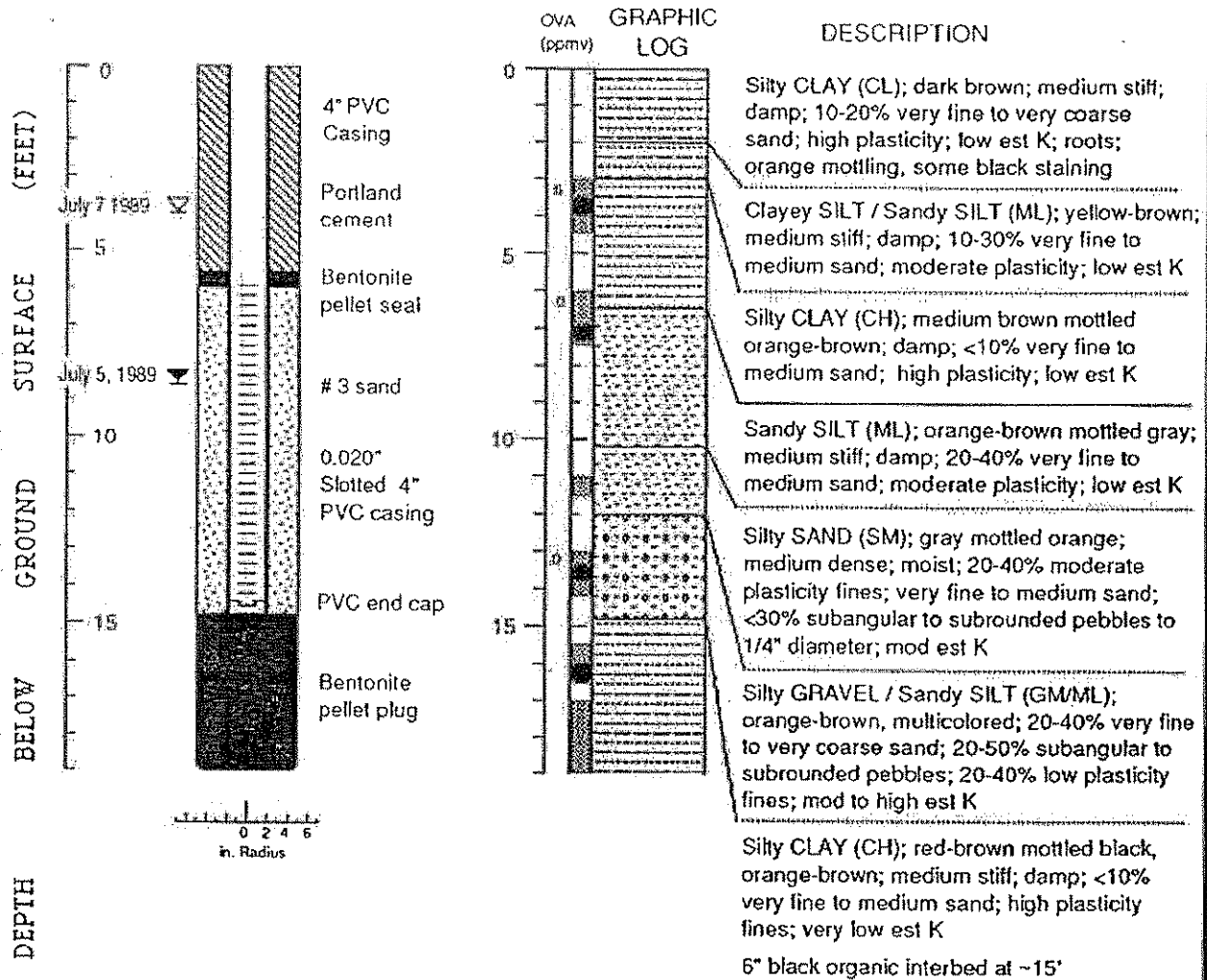

#### EXPLANATION





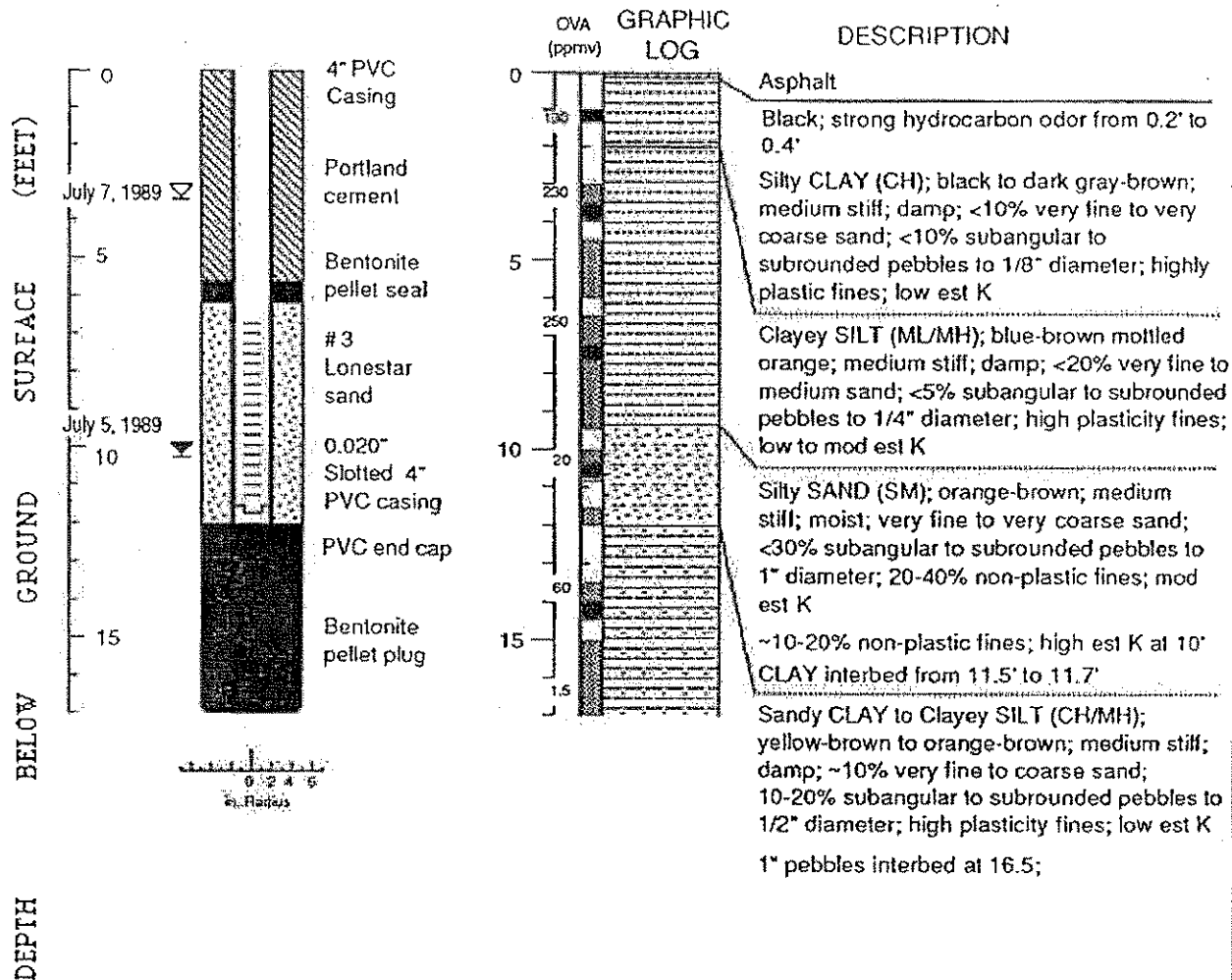

- Water level during drilling (date)
- Water level (date)
- Contact (dotted where approx.)
- Uncertain contact
- Location of recovered drive sample
- Location of drive sample sealed for chemical analysis
- Cutting sample
- K** = Estimated hydraulic conductivity

Logged by: Jack Gardner  
 Supervisor: Richard Weiss; EG 1112  
 Drilling Company: Bay Area Exploration, Suisun, CA  
 Driller: Carr / Mossman  
 Drilling Method: Hollow stem auger  
 Dates Drilled: July 5 to 6, 1989  
 Well Head Completion: Locking cap with traffic-rated vault  
 Type of sampler: Split barrel (1.5", 2.0", 2.5" ID)

### WELL MW-2 (BH-B)



#### EXPLANATION

-  Water level during drilling (date)
-  Water level (date)
-  Contact (dotted where approx.)
-  Uncertain contact
-  Location of recovered drive sample
-  Location of drive sample sealed for chemical analysis
-  Cutting sample
- K** = Estimated hydraulic conductivity

Logged by: Jack Gardner  
 Supervisor: Richard Weiss; EG 1112  
 Drilling Company: Bay Area Exploration, Suisun, CA  
 Driller: Carr/Mossmann  
 Drilling Method: Hollow stem auger  
 Dates Drilled: July 5, 1989  
 Well Head Completion: Locking cap with traffic-rated vault  
 Type of sampler: Split barrel (1.5", 2.0", 2.5" ID)

### WELL MW-3 (BH-C)

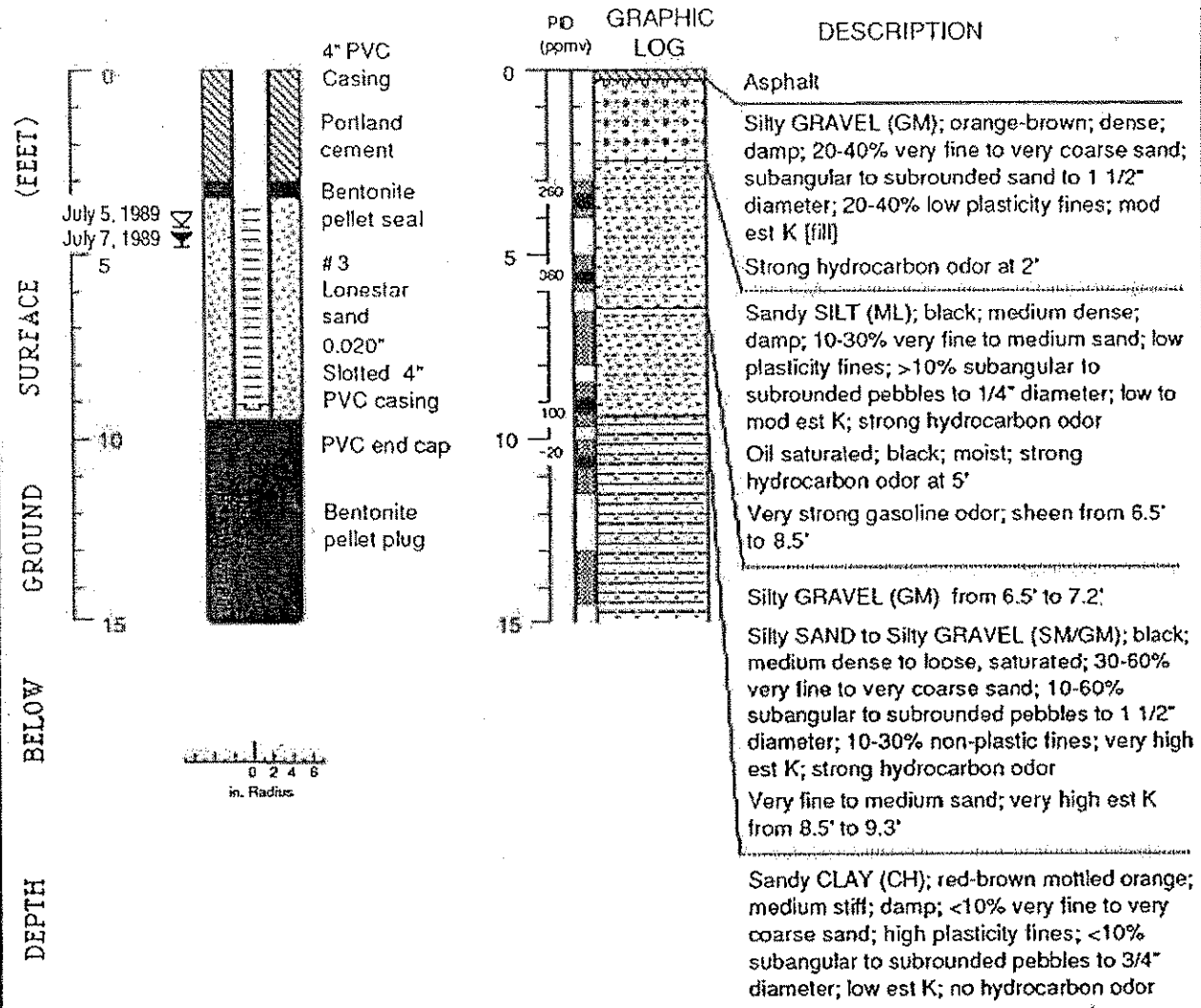

**DESCRIPTION**

Asphalt

Silty GRAVEL (GM); orange-brown; dense; damp; 20-40% very fine to very coarse sand; subangular to subrounded sand to 1 1/2" diameter; 20-40% low plasticity fines; mod est K [fill]

Strong hydrocarbon odor at 2'

Sandy SILT (ML); black; medium dense; damp; 10-30% very fine to medium sand; low plasticity fines; >10% subangular to subrounded pebbles to 1/4" diameter; low to mod est K; strong hydrocarbon odor

Oil saturated; black; moist; strong hydrocarbon odor at 5'

Very strong gasoline odor; sheen from 6.5' to 8.5'

Silty GRAVEL (GM) from 6.5' to 7.2'

Silty SAND to Silty GRAVEL (SM/GM); black; medium dense to loose, saturated; 30-60% very fine to very coarse sand; 10-60% subangular to subrounded pebbles to 1 1/2" diameter; 10-30% non-plastic fines; very high est K; strong hydrocarbon odor

Very fine to medium sand; very high est K from 8.5' to 9.3'

Sandy CLAY (CH); red-brown mottled orange; medium stiff; damp; <10% very fine to very coarse sand; high plasticity fines; <10% subangular to subrounded pebbles to 3/4" diameter; low est K; no hydrocarbon odor

#### EXPLANATION

- Water level during drilling (date)
- Water level (date)
- Contact (dotted where approx.)
- Uncertain contact
- Location of recovered drive sample
- Location of drive sample sealed for chemical analysis
- Cutting sample
- K = Estimated hydraulic conductivity

Logged by: Jack Gardner  
 Supervisor: Richard Weiss; EG 1112  
 Drilling Company: Bay Area Exploration, Suisun, CA  
 Driller: Carr/Mossman  
 Drilling Method: Hollow stem auger  
 Dates Drilled: July 5 to 6, 1989  
 Well Head Completion: Locking cap with traffic-rated vault  
 Type of sampler: Split barrel (1.5", 2.0", 2.5" ID)



### BORING BH-D

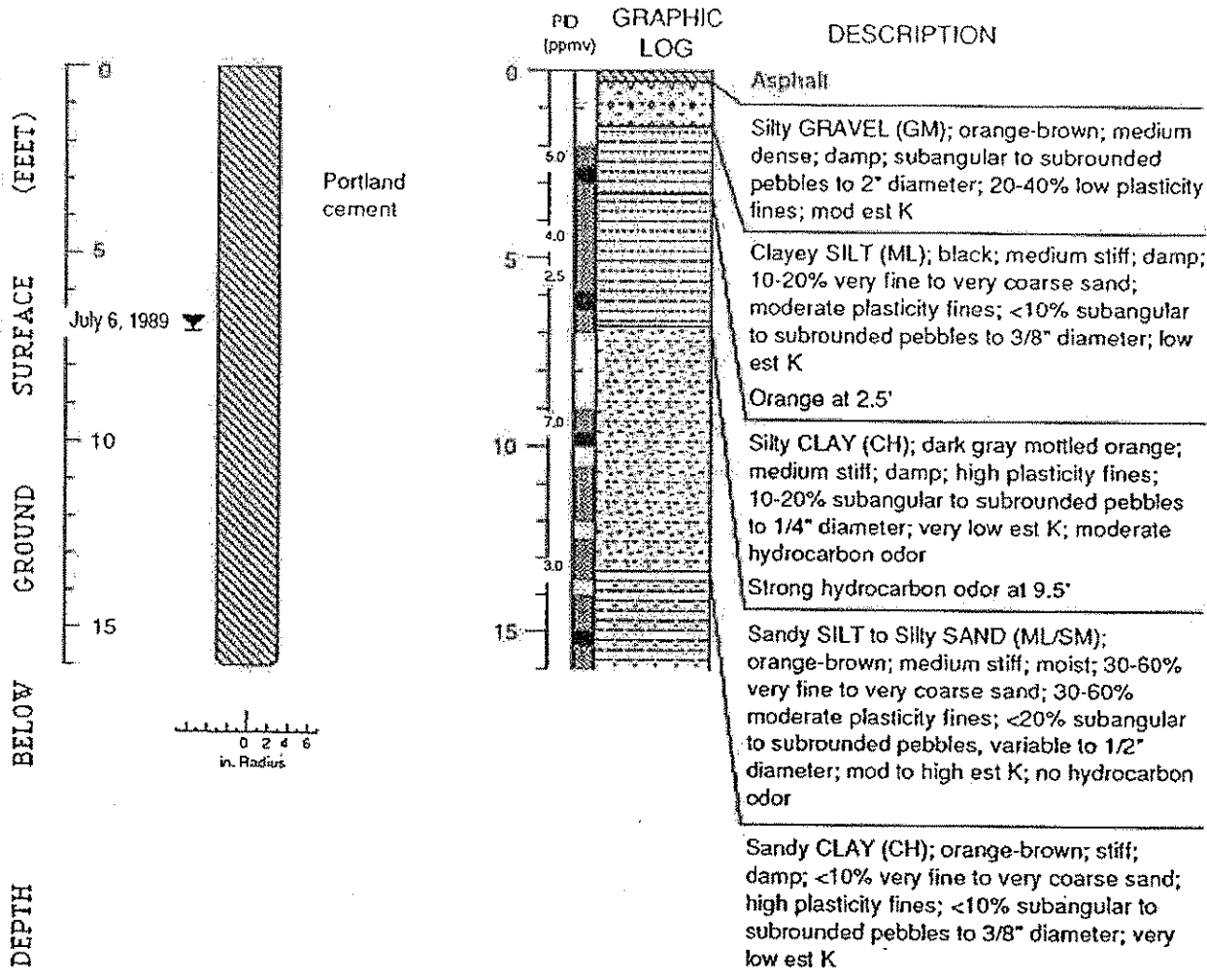

#### EXPLANATION

- Water level during drilling (date)
- Water level (date)
- Contact (dotted where approx.)
- Uncertain contact
- Location of recovered drive sample
- Location of drive sample sealed for chemical analysis
- Cutting sample
- K** = Estimated hydraulic conductivity

Logged by: Jack Gardner  
 Supervisor: Richard Weiss; EG 1112  
 Drilling Company: Bay Area Exploration, Suisun, CA  
 Driller: Carr/Mossmann  
 Drilling Method: Hollow stem auger  
 Dates Drilled: July 6, 1989  
 Well Head Completion: Locking-cap with traffic-rated vault  
 Type of sampler: Split barrel (1.5", 2.0", 2.5" ID)

Boring Log - Boring BH-D

Shell Service Station, 29 Wildwood Ave.,  
Piedmont, California



### BORING BH-E

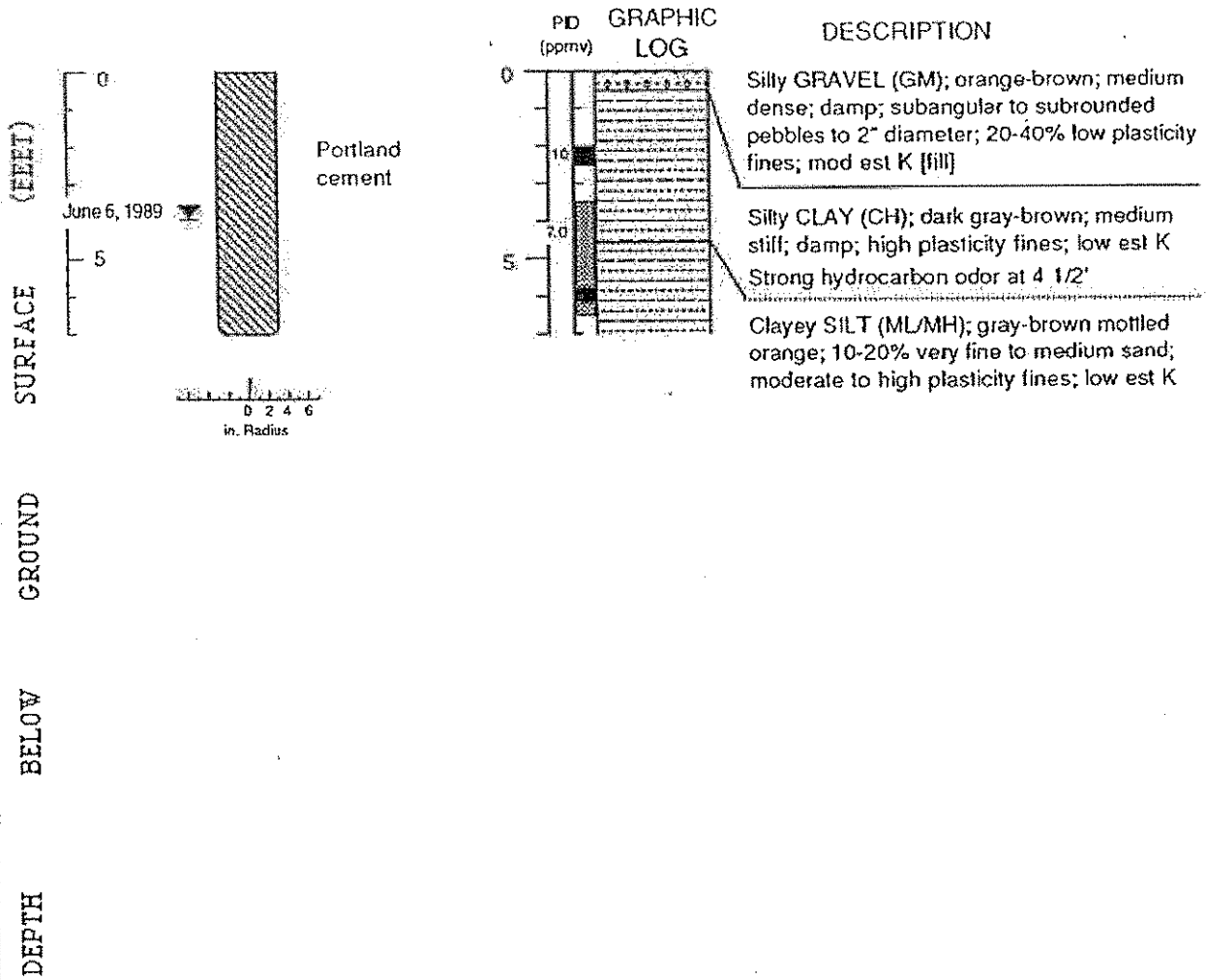

#### EXPLANATION

- Water level during drilling (date)
- Water level (date)
- Contact (dotted where approx.)
- Uncertain contact
- Location of recovered drive sample
- Location of drive sample sealed for chemical analysis
- Cutting sample
- K = Estimated hydraulic conductivity

Logged by: Jack Gardner  
 Supervisor: Richard Weiss; EG 1112  
 Drilling Company: Bay Area Exploration, Suisun, CA  
 Driller: Carr/Mossman  
 Drilling Method: Hollow stem auger  
 Dates Drilled: July 6, 1989  
 Well Head Completion: Locking cap with traffic-rated vault  
 Type of sampler: Split barrel (1.5", 2.0", 2.5" ID)

Boring Log - Boring BH-E

Shell Service Station, 29 Wildwood Ave.,  
Piedmont, California

### BORING BH-F

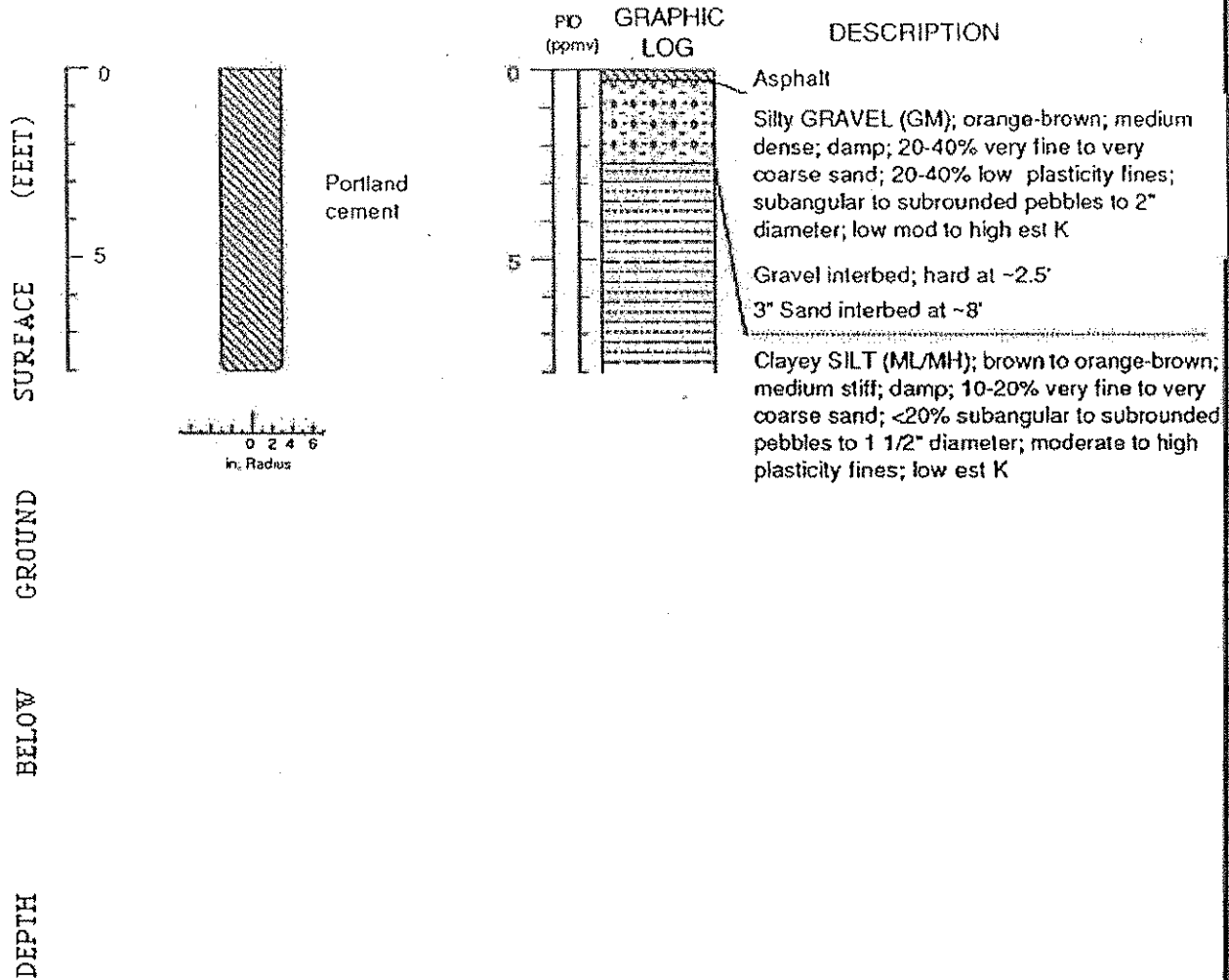

#### EXPLANATION

- Water level during drilling (date)
- Water level (date)
- Contact (dotted where approx.)
- Uncertain contact
- Location of recovered drive sample
- Location of drive sample sealed for chemical analysis
- Cutting sample
- K** = Estimated hydraulic conductivity

Logged by: Jack Gardner  
 Supervisor: Richard Weiss; EG 1112  
 Drilling Company: Bay Area Exploration, Suisun, CA  
 Driller: Carl/Mossman  
 Drilling Method: Hollow stem auger  
 Dates Drilled: July 6, 1989  
 Well Head Completion: Locking cap with traffic-rated vault  
 Type of sampler: Split barrel (1.5", 2.0", 2.5" ID)

Boring Log - Boring BH-F

Shell Service Station, 29 Wildwood Ave.,  
Piedmont, California





### BORING BH-G

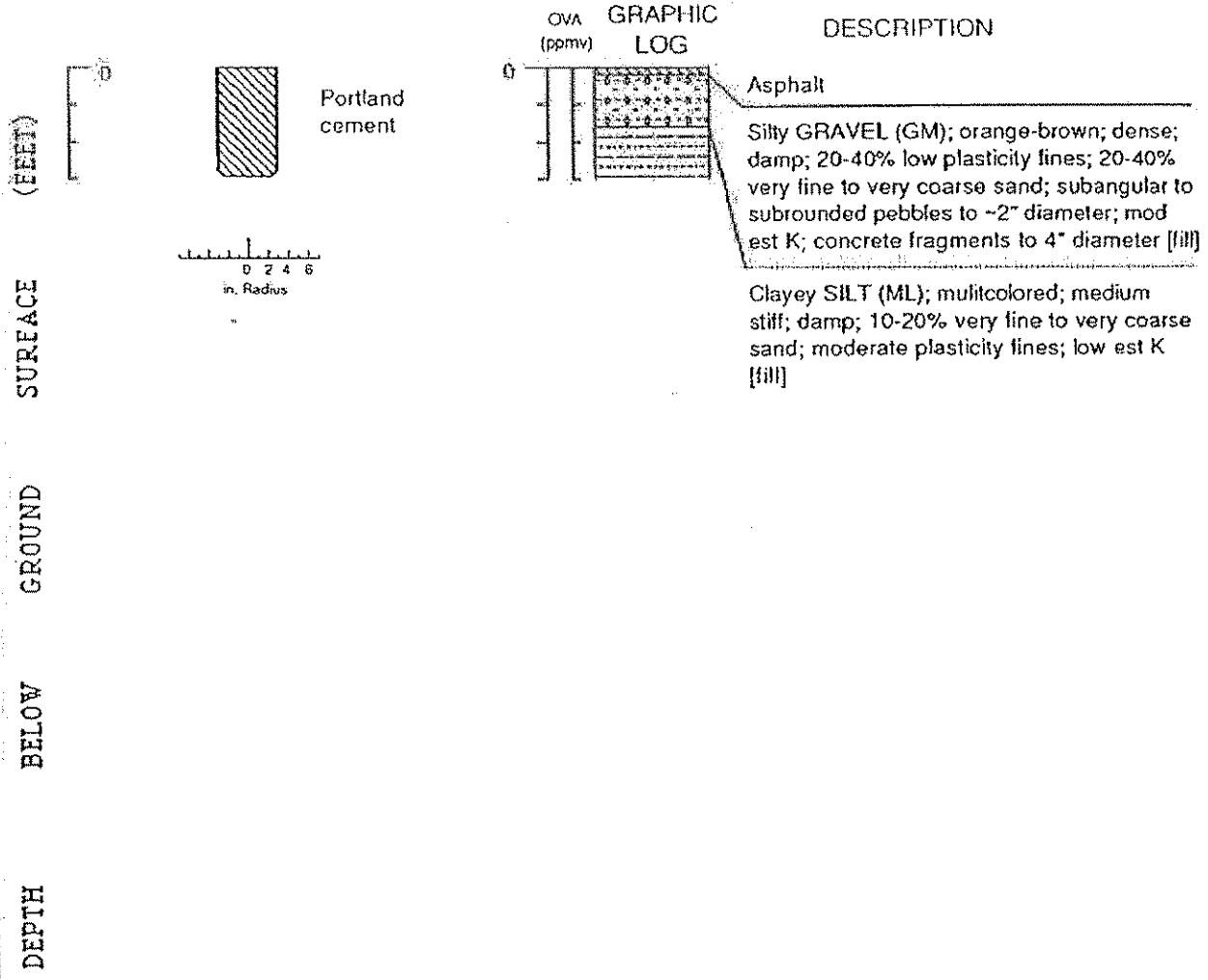

#### EXPLANATION

- Water level during drilling (date)
- Water level (date)
- Contact (dotted where approx.)
- Uncertain contact
- Location of recovered drive sample
- Location of drive sample sealed for chemical analysis
- Cutting sample
- K** = Estimated hydraulic conductivity

Logged by: Jack Gardner  
 Supervisor: Richard Weiss; EG 1112  
 Drilling Company: Bay Area Exploration, Suisun, CA  
 Driller: Carr/Mossman  
 Drilling Method: Hollow stem auger  
 Dates Drilled: July 6, 1989  
 Well Head Completion: Locking cap with traffic-rated vault  
 Type of sampler: Split barrel (1.5", 2.0", 2.5" ID)

Boring Log - Boring BH-G

Shell Service Station, 29 Wildwood Ave.,  
Piedmont, California

### BORING BH-H

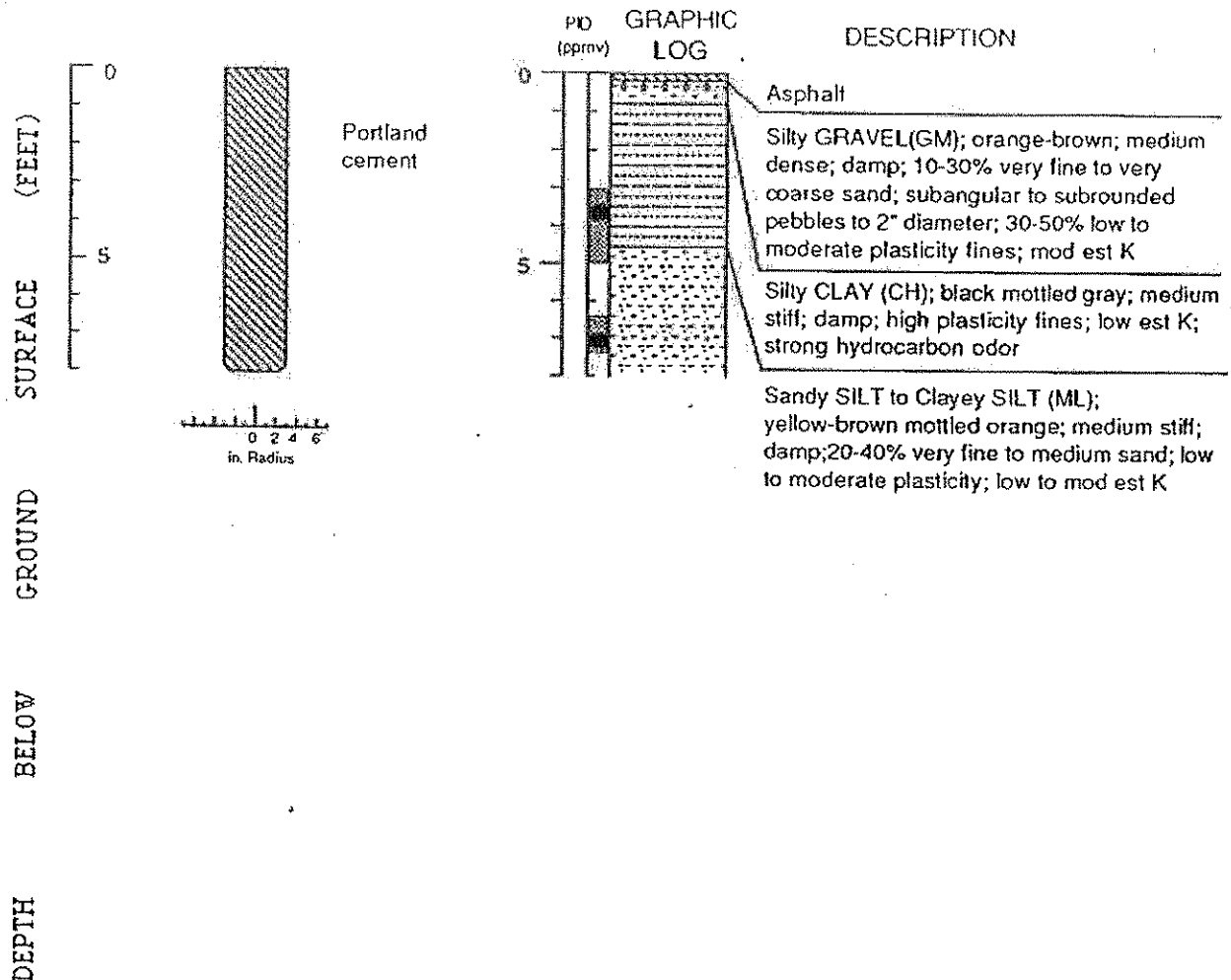

#### EXPLANATION

- Water level during drilling (date)
- Water level (date)
- Contact (dotted where approx.)
- Uncertain contact
- Location of recovered drive sample
- Location of drive sample sealed for chemical analysis
- Cutting sample
- K = Estimated hydraulic conductivity

Logged by: Jack Gardner  
 Supervisor: Richard Weiss; EG 1112  
 Drilling Company: Bay Area Exploration, Suisun, CA  
 Driller: Carr/Mossman  
 Drilling Method: Hollow stem auger  
 Dates Drilled: July 6, 1989  
 Well Head Completion: Locking-cap with traffic-rated vault  
 Type of sampler: Split barrel (1.5", 2.0", 2.5" ID)

### BORING BH-1

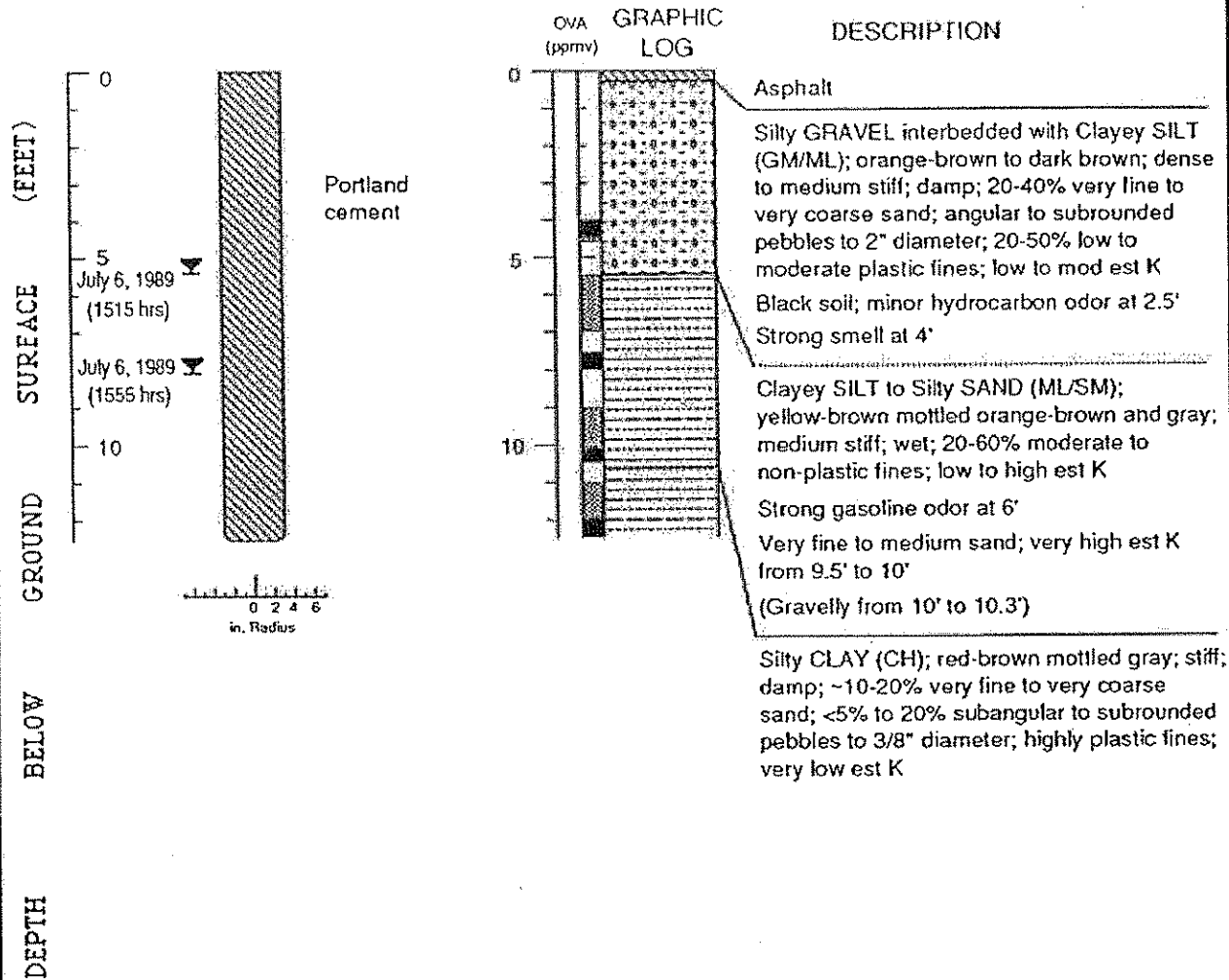

#### EXPLANATION

- Water level during drilling (date)
- Water level (date)
- Contact (dotted where approx.)
- Uncertain contact
- Location of recovered drive sample
- Location of drive sample sealed for chemical analysis
- Cutting sample
- K** = Estimated hydraulic conductivity

Logged by: Jack Gardner  
 Supervisor: Richard Weiss; EG 1112  
 Drilling Company: Bay Area Exploration, Suisun, CA  
 Driller: Carr/Mossman  
 Drilling Method: Hollow stem auger  
 Dates Drilled: July 6, 1989  
 Well Head Completion: Locking cap with traffic-rated vault  
 Type of sampler: Split barrel (1.5", 2.0", 2.5" ID)

Boring Log - Boring BH-1

Shell Service Station, 29 Wildwood Ave.,  
Piedmont, California



## WELL MW-4 (BH-J)

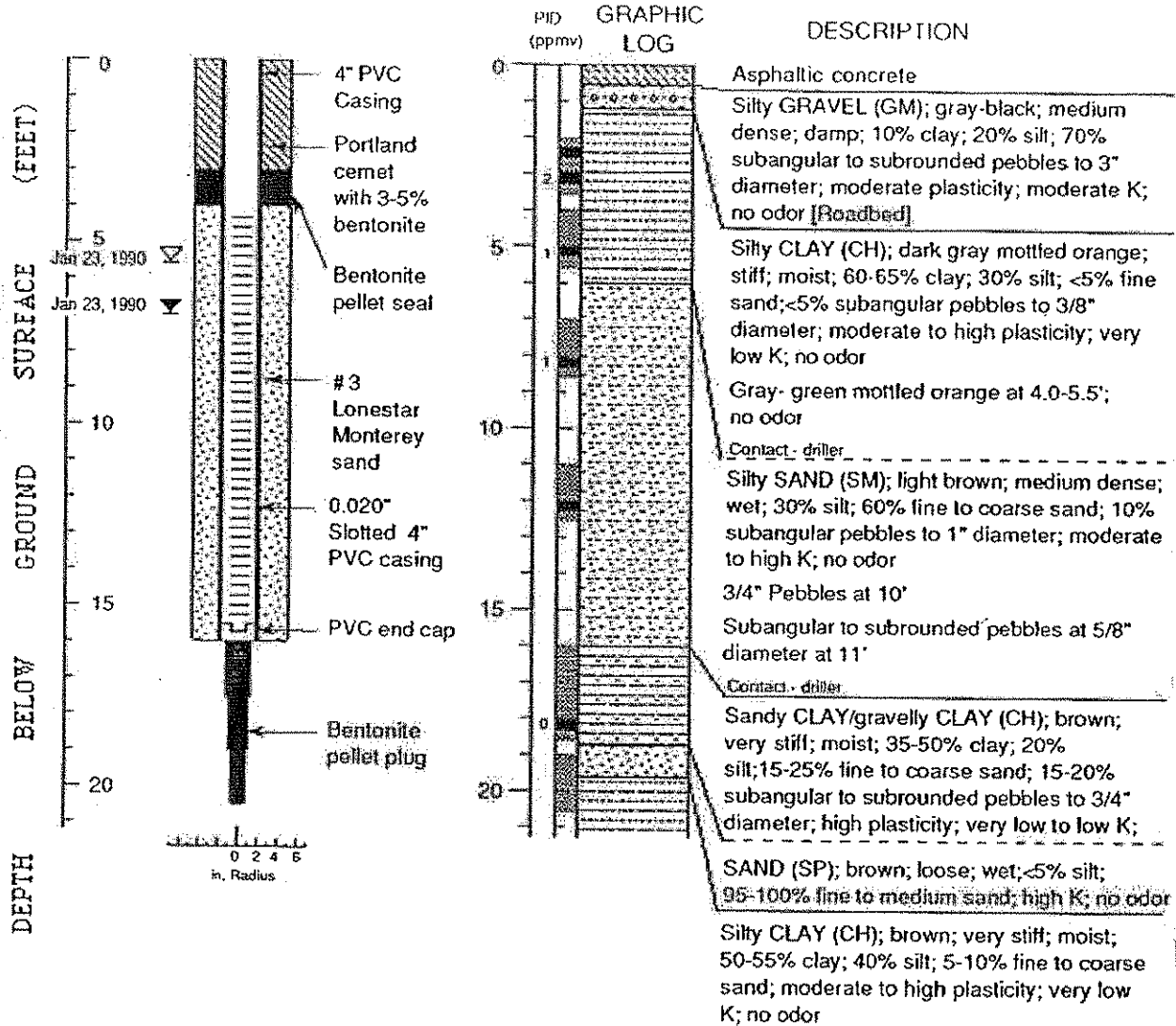

### EXPLANATION

- ▼ Water level during drilling (date)
- ▽ Water level (date)
- Contact (dotted where approx.)
- - - Uncertain contact
- [Pattern] Location of recovered drive sample
- [Pattern] Location of drive sample sealed for chemical analysis
- [Pattern] Cutting sample
- K = Estimated hydraulic conductivity

Logged by: N. Scott MacLeod  
 Supervisor: Richard Weiss; EG 1112  
 Drilling Company: Soil Exploration Services, Vacaville, CA  
 Driller: Russ Ellis  
 Drilling Method: Hollow stem auger  
 Date Drilled: January 23, 1990  
 Well Head Completion: Locking wellcap, traffic-rated vault  
 Type of Sampler: Split barrel (1.5", 2.0", 2.5" I.D.)  
 Ground Surface Elevation: 34.03'

Well Construction and Boring Log - Well MW-4 (BH-J)

Shell Service Station  
 WIC #204-6001-0109  
 Piedmont, California

### WELL MW-5 (BH-K)

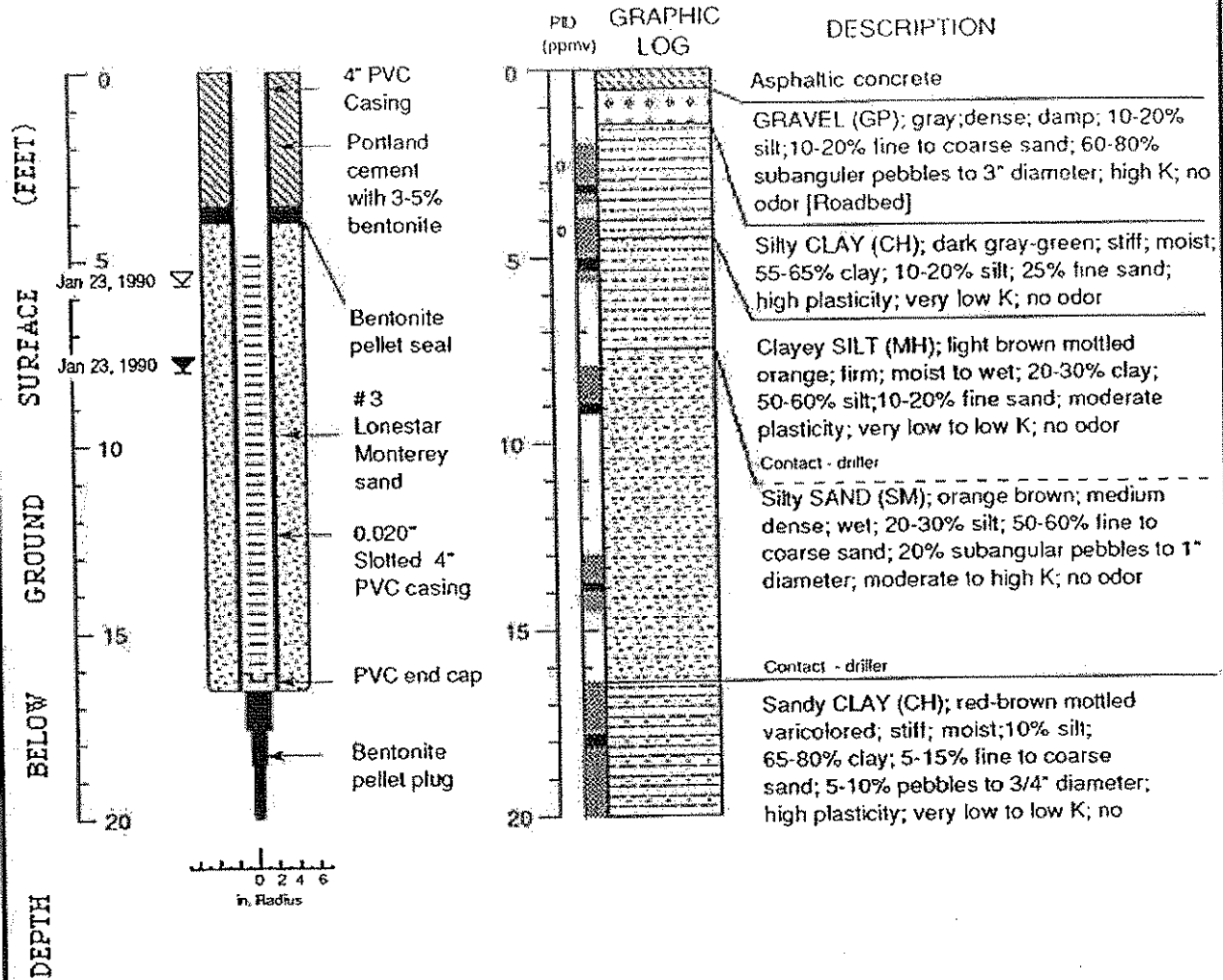

#### EXPLANATION

- Water level during drilling (date)
- Water level (date)
- Contact (dotted where approx.)
- Uncertain contact
- Location of recovered drive sample
- Location of drive sample sealed for chemical analysis
- Cutting sample
- K** = Estimated hydraulic conductivity

Logged by: N. Scott MacLeod  
 Supervisor: Richard Weiss; EG 1112  
 Drilling Company: Soils Exploration Services, Vacaville, CA  
 Driller: Russ Ellis  
 Drilling Method: Hollow stem auger  
 Date Drilled: January 23, 1990  
 Well Head Completion: Locking wellcap, traffic-rated vault  
 Type of sampler: Split barrel (1.5", 2.0", 2.5" I.D.)  
 Ground Surface Elevation: 31.61'

Well Construction and Boring Log - Well MW-5 (BH-K)

Shell Service Station  
 WIC #204-6001-0109  
 Piedmont, California



### BORING BH-L

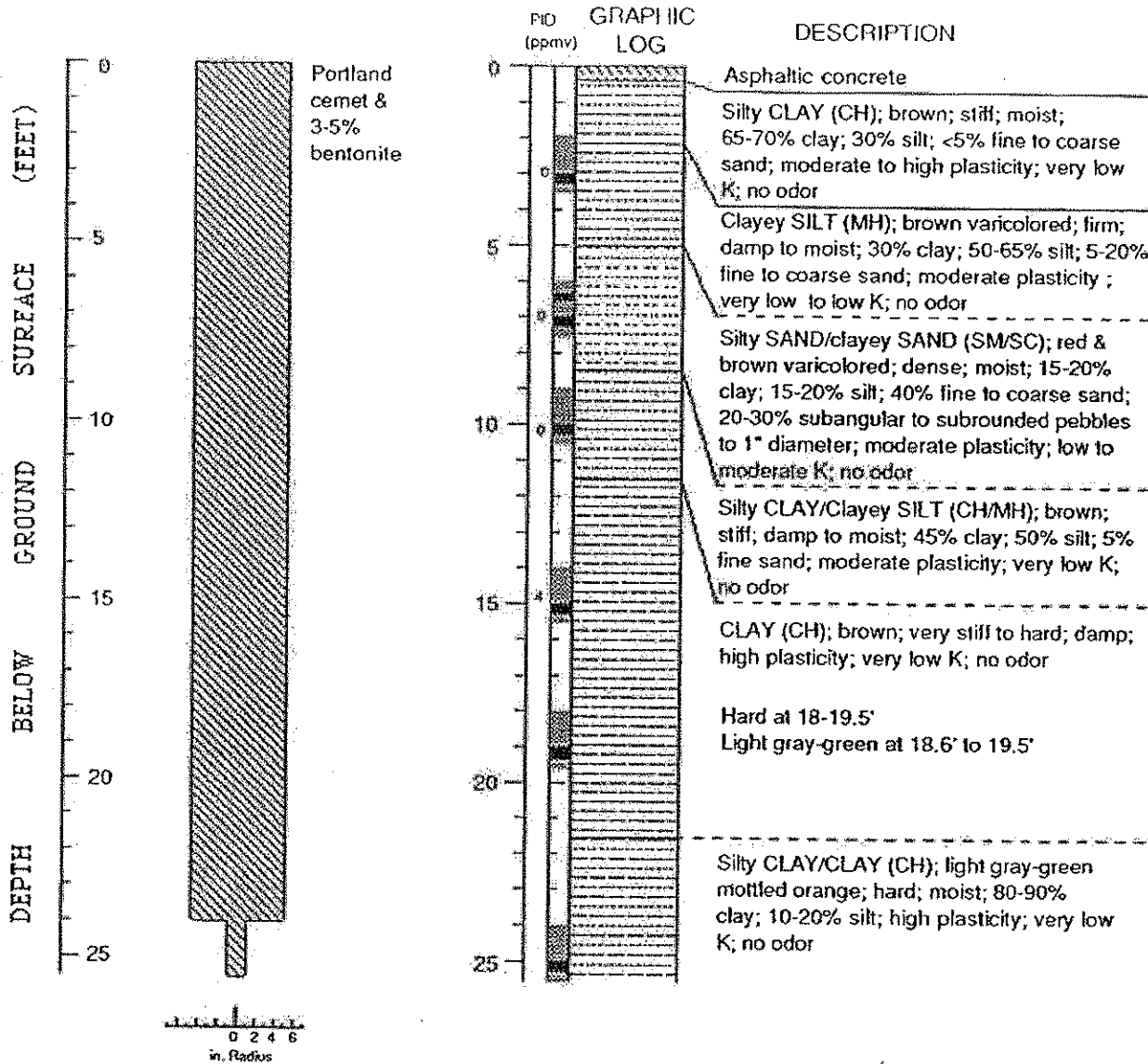

#### EXPLANATION

- ▼ Water level during drilling (date)
- ▽ Water level (date)
- Contact (dotted where approx.)
- - - Uncertain contact
- ▨ Location of recovered drive sample
- Location of drive sample sealed for chemical analysis
- ⊗ Cutting sample
- K = Estimated hydraulic conductivity

Logged by: N. Scott MacLeod  
 Supervisor: Richard Weiss; EG 1112  
 Drilling Company: Soils Exploration Services, Vacaville, CA  
 Driller: Russ Ellis  
 Drilling Method: Hollow stem auger  
 Date Drilled: January 24, 1990  
 Type of sampler: Split barrel (2.0" I.D.)

Boring Log - BH-L

Shell Service Station  
 WIC #204-6001-0109  
 Piedmont, California

Table 1. Soil Analytical Data - Shell-branded Service Station, 29 Wildwood Avenue, Piedmont, California

Sample ID	Date Sampled	Depth	O&G	TPHd	TPHg	BTEX	Chlorinated Hydrocarbons	OXYs	Ethanol	1,2-DCA	EDB	Cd	Cr	Pb	Ni	Zn	Bis (2-Ethylhexyl) Phthalate	PCP	Creosote	PCBs
WO-1-5'	09-May-07	5	17	1.7	<1.0	<0.0050	ND	<0.0050	<0.010	<0.0050	<0.0050	<0.500	33.1	6.33	34.8	25.2	1.4	<2.5	<0.50	<0.05
<b>SFBRWQCB ESLs for shallow soil where groundwater is a current or potential drinking water source (Residential Land Use)</b>																				
			-	100	100	Varies	Varies	Varies	45	0.0045	0.00033	1.7	58	150	150	600	66	4.4	--	0.22

**Abbreviations and Notes:**

O&amp;G = Oil and grease as hexane extractable material by EPA Method 1664 A (Modified)

TPHd = Total petroleum hydrocarbons as diesel by EPA Method 8015 (Modified)

TPHg = Total petroleum hydrocarbons as gasoline by EPA Method 8260B

BTEX = Benzene, toluene, ethylbenzene, and total xylenes by EPA Method 8260B

Chlorinated hydrocarbons by EPA Method 8260B; see laboratory analytical report for a complete list of specific constituents

OXYs = Methyl tertiary-butyl ether, di-isopropyl ether, ethyl tertiary-butyl ether, tertiary-amyl methyl ether, and tertiary-butanol by EPA Method 8260B

Ethanol by EPA Method 8260B

1,2-DCA = 1,2-Dichloroethane by EPA Method 8260B

EDB = 1,2-Dibromoethane by EPA Method 8260B

Cd = Cadmium by EPA Method 6010B

Cr = Chromium by EPA Method 6010B

Pb = Lead by EPA Method 6010B

Ni = Nickel by EPA Method 6010B

Zn = Zinc by EPA Method 6010B

Bis (2-Ethylhexyl) Phthalate by EPA Method 8270C.

PCP = Pentachlorophenol by EPA Method 8270C

Creosote analyzed by EPA Method 8270C. It is reported as a combination of naphthalene, acenaphthylene, fluorene, phenanthrene, anthracene, fluoranthene, pyrene, 1-methylnaphthalene, and 2-methylnaphthalene.

PCBs = Polychlorinated biphenyls by EPA Method 8082; see laboratory analytical report for a complete list of specific constituents

fbg = Feet below grade

mg/kg = Milligrams per kilogram (parts per million)

&lt;x = Not detected at reporting limit x

ND = Not detected; see laboratory analytical report for constituent-specific reporting limits

-- = No applicable environmental screening level

All detected constituents tabulated. See laboratory report for complete results.

Data in **BOLD** equals or exceeds applicable San Francisco Bay Regional Water Quality Control Board (SFBRWQCB) environmental screening level (ESL) value

Table 2. Grab Water Analytical Data - Shell-branded Service Station, 29 Wildwood Avenue, Piedmont, California

Sample ID	Date Sampled	O&G	TPHd	TPHg	Benzene	Toluene	Ethyl-benzene	Total Xylenes	OXYs	Ethanol	1,2-DCA	EDB	Methylene Chloride	Cd	Cr	Pb	Ni	Zn	Benzyl Alcohol	Benzoic Acid	PCP	Creosote	PCBs
													(ug/L)										
WO-W	09-May-07	1,300	710	1,100 a	6.2	84	1.1	3.2	ND	14	<0.50	<0.50	99	<5.00	66.0	98.5	87.8	1,820	35	1,000	<10	<10	<1.0
SFBRWQCB ESLs for groundwater which is not a current or potential drinking water source (Residential or Commercial Land Use)																							
		--	640	500	46	130	290	100	Varies	50,000	200	150	2,200	1.1	180	2.5	8.2	81	--	--	7.9	--	0.014

**Abbreviations and Notes:**

- O&G = Oil and grease as hexane extractable material by EPA Method 1664 A (Modified)
- TPHd = Total petroleum hydrocarbons as diesel by EPA Method 8015 (Modified)
- TPHg = Total petroleum hydrocarbons as gasoline by EPA Method 8260B
- Benzene, toluene, ethylbenzene, and total xylenes by EPA Method 8260B
- OXYs = Methyl tertiary-butyl ether, di-isopropyl ether, ethyl tertiary-butyl ether, tertiary-amyl methyl ether, and tertiary-butanol by EPA Method 8260B
- Ethanol by EPA Method 8260B
- 1,2-DCA = 1,2-Dichloroethane by EPA Method 8260B
- EDB = 1,2-Dibromoethane by EPA Method 8260B
- Methylene chloride by EPA Method 8260B
- Cd = Cadmium by EPA Method 6010B
- Cr = Chromium by EPA Method 6010B
- Pb = Lead by EPA Method 6010B
- Ni = Nickel by EPA Method 6010B
- Zn = Zinc by EPA Method 6010B
- Benzyl alcohol and benzoic acid by EPA Method 8270C
- PCP = Pentachlorophenol by EPA Method 8270C
- Creosote analyzed by EPA Method 8270C. It is reported as a combination of naphthalene, acenaphthylene, fluorenc, phenanthrene, anthracene, fluoranthene, pyrene, 1-methylnaphthalene, and 2-methylnaphthene.
- PCBs = Polychlorinated biphenyls by EPA Method 8082; see laboratory analytical report for a complete list of specific constituents
- ug/L = Micrograms per liter (parts per billion)
- <x = Not detected at reporting limit x
- ND = Not detected; see laboratory analytical report for constituent-specific reporting limits
- = No applicable environmental screening level

a = Hydrocarbons reported as TPHg do not exhibit a typical gasoline chromatographic pattern.

All detected constituents tabulated. See laboratory report for a complete list of specific constituents and results.

Data in **BOLD** equals or exceeds San Francisco Bay Regional Water Quality Control Board (SFBRWQCB) environmental screening level (ESL) value (Table B)