

RECEIVED

By Alameda County Environmental Health 3:43 pm, Jan 19, 2017



ENVIRONMENTAL ENGINEERING, INC.
6620 Owens Drive, Suite A • Pleasanton, CA 94588
TEL (925)734-6400 • FAX (925)734-6401
www.somaenv.com

January 19, 2017

Mr. Mark Detterman, PG, CEG
Alameda County Health Care Services Agency
1131 Harbor Bay Parkway, Suite 250
Alameda, California 94502-6577

Subject: Freedom Food and Gas (Formerly Freedom ARCO Mini-Mart)
Site Address: 15101 Freedom Avenue, San Leandro, California
STID 4473/RO0000473

Dear Mr. Detterman:

SOMA's "Fourth Quarter 2016 Groundwater Monitoring and Remediation Progress Report" for the subject property has been uploaded to the State's GeoTracker database and Alameda County's FTP site for your review.

Thank you for your time in reviewing our report. Please do not hesitate to call me at (925) 734-6400, if you have questions or comments.

Sincerely,

A handwritten signature in black ink, appearing to read 'Mansour Sepehr', written over a light blue horizontal line.

Mansour Sepehr, Ph.D., PE
Principal Hydrogeologist

cc: Mr. Mohammad Pazdel w/report enclosure



**Fourth Quarter 2016
Groundwater Monitoring and
Remediation Progress Report**

**Freedom Food and Gas
15101 Freedom Avenue
San Leandro, California**

January 19, 2016

Project 2551/2553

Prepared for

**Mr. Mohammad Pazdel
1770 Pistacia Court
Fairfield, California**



ENVIRONMENTAL ENGINEERING, INC.

6620 Owens Drive Suite A Pleasanton CA 94588 Ph: 925.734.6400 F: 925.734-6401 www.somaenv.com

ACKNOWLEDGEMENT STATEMENT

Site Location: 15101 Freedom Avenue, San Leandro, CA

"I have read and acknowledge the content, recommendations and/or conclusions contained in the attached document or report submitted on my behalf to ACDEH's FTP server and the SWRCB's Geotracker website."



Mohammad Pazdel
1770 Pistacia Court
Fairfield, California 94533
Responsible Party

CERTIFICATION

SOMA Environmental Engineering, Inc. has prepared this report on behalf of the responsible party, Mr. Mohammad Pazdel, for property located at 15101 Freedom Avenue, San Leandro, California, to comply with Alameda County Health Care Services requirements for the Fourth Quarter 2016 groundwater monitoring event.

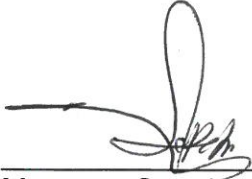

Mansour Sepehr, PhD, PE
Principal Hydrogeologist



TABLE OF CONTENTS

CERTIFICATION	i
TABLE OF CONTENTS.....	ii
LIST OF FIGURES	iii
LIST OF TABLES.....	iii
LIST OF APPENDICES	iv
1. INTRODUCTION	1
1.1 Field Activities.....	1
1.2 Laboratory Analysis	2
2. RESULTS	2
2.1 Field Measurements, First WBZ Wells.....	2
2.2 Laboratory Analysis, First WBZ Wells.....	2
3. OPERATION OF TREATMENT SYSTEM.....	4
4. MULTI-PHASE EXTRACTION EVENTS	5
5. CONCLUSIONS AND RECOMMENDATIONS.....	6
6. REPORT LIMITATIONS	7

LIST OF FIGURES

- Figure 1: Site vicinity map
- Figure 2: Site Map Showing Locations of USTs, Fuel Dispensers, Soil Borings, Vapor Samples, and Groundwater Monitoring Wells
- Figure 3: Groundwater Elevation Contour Map in Feet, First WBZ, December 14, 2016
- Figure 4: Contour Map of TPH-g Concentrations in Groundwater, First WBZ, December 14 and 15, 2016
- Figure 5: Contour Map of Benzene Concentrations in Groundwater, First WBZ, December 14 and 15, 2016
- Figure 6: Contour Map of MtBE Concentrations in Groundwater, First WBZ, December 14 and 15, 2016
- Figure 7: Contour Map of TBA Concentrations and map of ETBE Concentrations in Groundwater, First WBZ, December 14 and 15, 2016
- Figure 8: Schematic Diagram of Groundwater Remediation System
- Figure 9: Cumulative Mass of VOCs Removed

LIST OF TABLES

- Table 1: Historical Groundwater Elevation Data and Analytical Results
- Table 2: Historical Gasoline Oxygenates Results
- Table 3: Effluent Chemical Analytical Results and Operational History of Remediation System
- Table 4: Cumulative Masses of Petroleum Hydrocarbons Removed from the Groundwater Since Installation of the Treatment System

LIST OF APPENDICES

- Appendix A: Standard Operating Procedures for Conducting Groundwater Monitoring Activities
- Appendix B: Elevations and Coordinates on Monitoring Wells, Field Measurements of Physical and Chemical Parameters of Groundwater Samples, and Groundwater Gradient Calculations
- Appendix C: Laboratory Reports and Chain of Custody Forms for the Fourth Quarter 2016 Monitoring Event

1. INTRODUCTION

SOMA Environmental Engineering, Inc. (SOMA) has prepared this report on behalf of the responsible party, Mr. Mohammad Pazdel, for property located at 15101 Freedom Avenue, San Leandro, California. The site is located in an area of primarily residential properties and adjacent commercial areas (Figure 1). The property was formerly owned by Mr. Mohammad Pazdel. In late 2009, the property was sold to DDH, LLC, Assignee and in early 2010 it was sold to Mr. Mohammad Mashhoon. Under the new management, the site is currently operational with the business name “Freedom Food and Gas” (formerly “Freedom Arco Mini-Mart”).

This report summarizes results of the Fourth Quarter 2016 groundwater monitoring event conducted on December 14 and 15, 2016, 2016. It includes physical and chemical properties measured in the field and laboratory analysis results for each groundwater sample. It also presents the remediation progress report for Fourth Quarter 2016, which includes a summary of historical multi-phase extraction events and a status update of groundwater extraction and treatment system.

1.1 Field Activities

In December 2016, SOMA’s field crew conducted a groundwater monitoring event in accordance with procedures and guidelines of Alameda County Health Care Services (ACHCS) and the California Regional Water Quality Control Board (CRWQCB). Figure 2 shows well locations.

On December 14, 2016, the following wells were measured for depth to groundwater: five on-site monitoring wells (MW-1 to MW-5) and four off-site wells (MW-6, MW-7, MW-10 and MW-11) in the First water-bearing zone (WBZ); one extraction well (EX-1), and two MPE wells (MPE-1 and MPE-2). On December 14 and 15, 2016, additional field measurements and groundwater samples were collected from all First WBZ monitoring and remediation wells except EX-2. No sample could be retrieved from EX-2 due to the presence of a downhole pump inside the well. Free product (FP) was not observed in any well during this monitoring event. Properties measured include pH, temperature, and electrical conductivity (EC).

Groundwater monitoring of Second WBZ has been discontinued based on ACEH’s directive dated October 28, 2015. Therefore, MW-1D, MW-3D, and MW-4D were not measured for depth to water or sampled during this monitoring event.

A natural attenuation study was conducted during this event to determine whether petroleum hydrocarbons in groundwater are biodegrading. Dissolved

oxygen (DO) and oxidation reduction potential (ORP) measurements were taken for all monitoring and MPE wells.

1.2 Laboratory Analysis

Curtis & Tompkins Laboratories, a California state-certified laboratory, analyzed groundwater samples for the following: total petroleum hydrocarbons as gasoline (TPH-g); benzene, toluene, ethylbenzene, total xylenes (collectively termed BTEX); methyl tertiary-butyl ether (MtBE); and gasoline oxygenates, ethanol and lead scavengers. Samples were prepared using EPA Method 5030B and analyzed using EPA Method 8260B.

2. RESULTS

Following are results of field measurements and laboratory analysis for the Fourth Quarter 2016 groundwater monitoring event.

2.1 Field Measurements, First WBZ Wells

Table 1 presents calculated groundwater elevations and depths to groundwater for each monitoring well. Depths to groundwater ranged from 12.30 feet in MW-11 to 22.87 feet in MW-1. As mentioned above in Section 1.1, no FP was observed in any First WBZ well. Appendix A includes the procedure for FP measurement.

Corresponding groundwater elevations ranged from 30.15 feet in MW-11 to 31.68 feet in MW-2 (Table 1).

Figure 3 displays the contour map of groundwater elevations. As illustrated, groundwater flows southwesterly, at a gradient of 0.0047 feet/feet. No capture zone can be seen in the figure because the downhole pumps in the extraction wells (EX-1 and EX-2) have not been operating based on comments received from the UST Cleanup Fund. Groundwater gradient calculations are attached in Appendix B.

Field measurements recorded during this monitoring event are included in Appendix B.

2.2 Laboratory Analysis, First WBZ Wells

Appendix C includes the laboratory report and chain-of-custody form for this monitoring event.

Table 1 presents TPH-g, BTEX, and MtBE analysis results for the current and historical groundwater monitoring events.

TPH-g was below laboratory reporting-limit in EX-1 and MPE-1 and was detected in concentrations ranging from 65 µg/L in MW-11 to 7,100 µg/L in MPE-2. Since the previous monitoring event (Third Quarter 2016), TPH-g has increased in MW-5 and decreased in all other sampled wells. The decrease is significant in MW-1, MW-3, and MW-10R.

Figure 4 displays the contour map of TPH-g concentrations in groundwater. As illustrated, the highest TPH-g impact is observed in the northeast section of the site in the vicinity of MPE-2.

The following BTEX concentrations were observed:

- All BTEX analytes were below laboratory reporting-limits in MW-1, MW-2, and EX-1.
- Benzene was also below laboratory-reporting limits in MW-7, MW-10R, and MW-11. Detectable benzene concentrations ranged from 0.68 µg/L in MPE-1 to 490 µg/L in MPE-2.
- Toluene was below laboratory-reporting limits in all samples.
- Ethylbenzene was below laboratory-reporting limits in MW-4 and MPE-1 and was detected in concentrations ranging from 1.2 µg/L in MW-6 to 230 µg/L in MPE-2.
- Total xylenes were below laboratory-reporting limits in MW-5 and EX-1. Detectable concentrations ranged from 0.82 µg/L in MPE-1 to 206.5 µg/L in MW-10R.

Figure 5 displays the contour map of benzene in groundwater. The highest benzene impact is in the northeast corner of the site in the vicinity of MPE-2. Since the previous monitoring event (Third Quarter 2016), detectable benzene concentrations have slightly increased in MW-5 and decreased in MW-1, MW-3, MW-4, MW-6, MW-7, MW-10R, EX-1, MPE-1, and MPE-2.

MtBE was below the laboratory-reporting limit in MW-1, MW-2, MW-3, MW-6, MW-10R, MW-11, and MPE-1. Detectable MtBE ranged from 0.87 µg/L in MW-5 to 6 µg/L in MPE-2. Figure 6 displays the contour map of MtBE concentrations in groundwater. Since the previous monitoring event (Third Quarter 2016), MtBE has increased in MW-7 and EX-1, decreased in MW-4, MW-5, and MPE-1, and remained below laboratory-reporting limit in MW-1, MW-2, MW-3, MW-6, MW-10R, and MW-11.

MW-3, MPE-1, and MPE-2 are the more impacted on-site wells where free-product has been observed in the past and MW-6 and MW-10R are the more impacted off-site wells. As shown in Table 1, since the previous monitoring event

(Third Quarter 2016), detectable concentrations of TPH-g and benzene have decreased in all these wells.

Laboratory report and chain-of-custody form are attached in Appendix C.

Table 2 shows analysis results for gasoline oxygenate and lead scavenger concentrations for the current as well as historical events.

The following gasoline oxygenate and lead scavenger concentrations were observed:

- In MW-1, MW-2, MW-3, MW-5, MW-6, MW-7, MW-10R, MW-11, and MPE-1 all gasoline oxygenates and lead scavengers were below laboratory-reporting limits.
- tertiary-butyl alcohol (TBA) was detected in MW-4, EX-1, and MPE-2 at 16 µg/L, 15 µg/L, and 150 µg/L, respectively. Figure 7 shows the contour map of TBA concentrations in First WBZ wells. Since the previous monitoring event (Third Quarter 2016), TBA increased in EX-1 and decreased in MW-1, MW-3, MW-4, MW-10R, and MPE-2.
- Ethyl tertiary-butyl ether (ETBE) was detected in EX-1 at 0.81 µg/L and was below laboratory-reporting limit in other wells. Figure 7 shows the map of ETBE concentrations in First WBZ wells. Since the previous monitoring event (Third Quarter 2016), ETBE slightly increased in EX-1 and decreased in MW-4.
- Methyl ter-amyl ether (TAME), 1,2-dichloroethane (1,2-DCA), Isopropyl ether (DIPE), 1,2-dibromoethane (EDB), and ethanol were below laboratory-reporting limits in all groundwater samples. Analysis results for ethanol are shown in Appendix C.

3. OPERATION OF TREATMENT SYSTEM

SOMA installed a groundwater treatment system at the site in December 2009. The system includes two extraction wells (EX-1 and EX-2), trenching containing influent and effluent lines and electrical conduits, and the treatment system compound. During system operation, extracted groundwater is pumped from extraction wells through underground piping to a fenced treatment compound, adjacent to the existing service station building.

In the treatment compound, groundwater is treated using granular activated carbon (GAC) and subsequently discharged to the sanitary sewer. Two GAC vessels are connected in series. The first unit (1,000 gallons) serves as the primary treatment unit, and the second (55 gallons) polishing drum provides an additional safety buffer prior to discharge. Effectiveness of the GAC units is monitored by collection and analysis of samples from the system discharge,

including a sample collected from water that has passed only through the first GAC unit. When analytical results indicate that the first GAC unit is no longer effectively treating groundwater, the vessel will be removed from the treatment line and refurbished with new carbon. The polishing unit was replaced on June 16, 2014.

Since the system began discharging, approximately 3,973,478 gallons of groundwater have been treated and discharged at the site (as of September 22, 2016). Since March 7, 2016, the treatment system has not been operating actively. The treatment system operated on August 5, 2016 and September 22, 2016 to process MPE and monitoring water. Both these times the extraction wells (EX-1 and EX-2) remained inoperative.

The treatment system operates under discharge permit issued by Oro Loma Sanitary District (OLSD) in May 2009. This discharge permit was most recently renewed in May 2016. Treated groundwater has been discharging to the OLSD sewer since December 9, 2009. Figure 8 shows the schematic diagram of the groundwater treatment system. Treatment system effluent is sampled each month of operation to comply with OLSD discharge permit requirements. Table 3 includes analytical results and operational history of the treatment system. As shown in Table 4, as of August 4, 2016, cumulative masses of TPH-g and BTEX extracted from groundwater were approximately 40.57 pounds, 1.52 pounds, 0.37 pounds, 1.00 pounds, and 5.17 pounds, respectively. The treatment system has not been operational since September 22, 2016. Therefore, no effluent samples were collected during Fourth Quarter 2016.

4. MULTI-PHASE EXTRACTION EVENTS

No MPE events were performed during the Fourth Quarter 2016. The overall estimated total mass of VOCs extracted by previous and the current MPE events is 3,629 pounds. This includes the following:

Event	Mass Removed (pounds)
November 2007 (Pilot Test)	106
October 2009	243
November 2009	72
December 2009	97
February 2010	17
March 2010	11
June 2010	30
August 2010	30
October 2010	79
April 2011	27
August 2011	94
May 2013	300

August 2013	841
October 2013	790
September 2014	565
November 2015	280
August 2016	47

Figure 9 shows the cumulative extracted mass of VOCs during different MPE events at the site.

5. CONCLUSIONS AND RECOMMENDATIONS

Fourth Quarter 2016 groundwater monitoring and MPE events results are summarized below.

- No FP was observed during this monitoring event.
- Groundwater flows southwesterly across the site in First WBZ. The downhole pumps in the extraction wells (EX-1 and EX-2) have been offline since March 7, 2016 based on comments received from the UST Cleanup Fund.
- The highest TPH-g and benzene concentrations were observed in the northeast section of the site in the vicinity of MPE-2.
- Since the previous monitoring event (Third Quarter 2016), TPH-g has increased in MW-5 and decreased in all other sampled wells; detectable benzene concentrations have slightly increased in MW-5 and decreased in MW-1, MW-3, MW-4, MW-6, MW-7, MW-10R, EX-1, MPE-1, and MPE-2.
- An MPE event was conducted from August 2 to August 5, 2016 utilizing off-site well MW-10R. Since then, contaminant concentrations in MW-10R have decreased significantly. Since the previous monitoring event (Third Quarter 2016), all contaminant concentrations have also decreased in MW-3. Additionally, no sheen or free-product was detected and no rebounding concentrations were observed in any well during this monitoring event.
- The total mass of hydrocarbon removed by MPE operations (as of August 2016) at the site is estimated to be 3,629 pounds.

Based on results of the Fourth Quarter 2016 groundwater monitoring event it is apparent that all contaminant concentration are showing a decreasing trend. SOMA's workplan dated November 22, 2016 was approved by the ACDEH on January 6, 2017. Based on ACDEH's comments, SOMA will implement the workplan which will include sampling of MW-3 and MW-10R during January and February of 2017 in order to monitor the concentration trends in these two wells and locating and sampling of neighborhood domestic wells.

6. REPORT LIMITATIONS

This report is the summary of work done by SOMA, including observations and descriptions of site conditions. It includes analysis results produced by Curtis & Tompkins Laboratories for the current groundwater monitoring event. Quantities and locations of wells were selected to provide the required information, but may not be representative of entire site conditions. All conclusions and recommendations are based on laboratory analysis results. Conclusions beyond those specifically stated in this document should not be inferred from this report.

SOMA warrants that services were provided in accordance with generally accepted practices in the environmental engineering and consulting field at the time of this sampling.

Figures

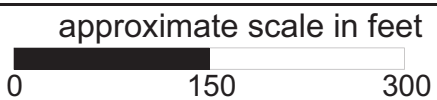
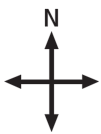
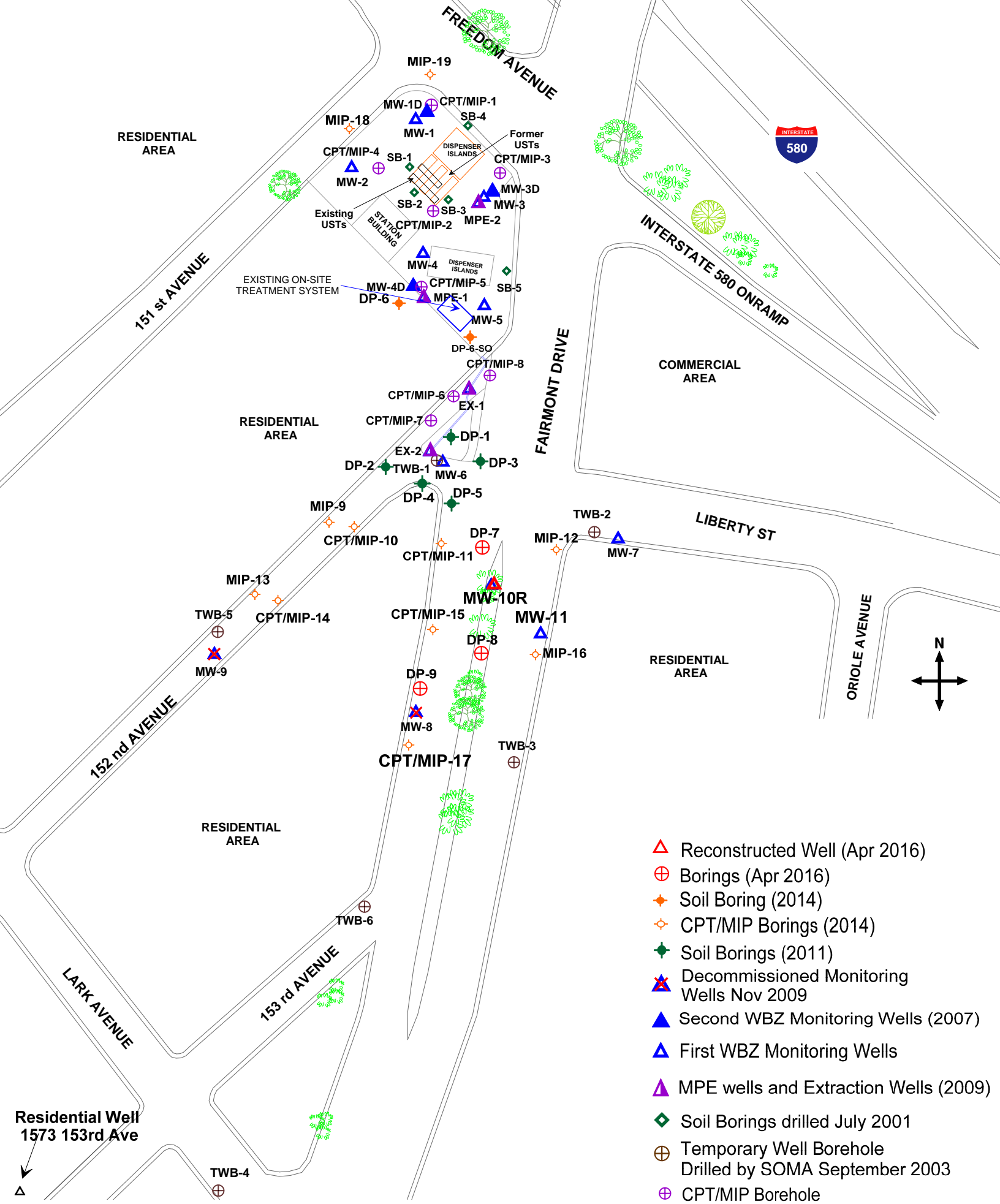

Figure 1: Site vicinity map.



Residential Well
1573 153rd Ave

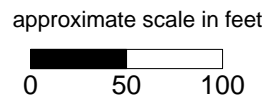

Figure 2: Site Map Showing Locations of USTs, Fuel Dispensers, Soil Borings, Vapor Samples, and Groundwater Monitoring Wells



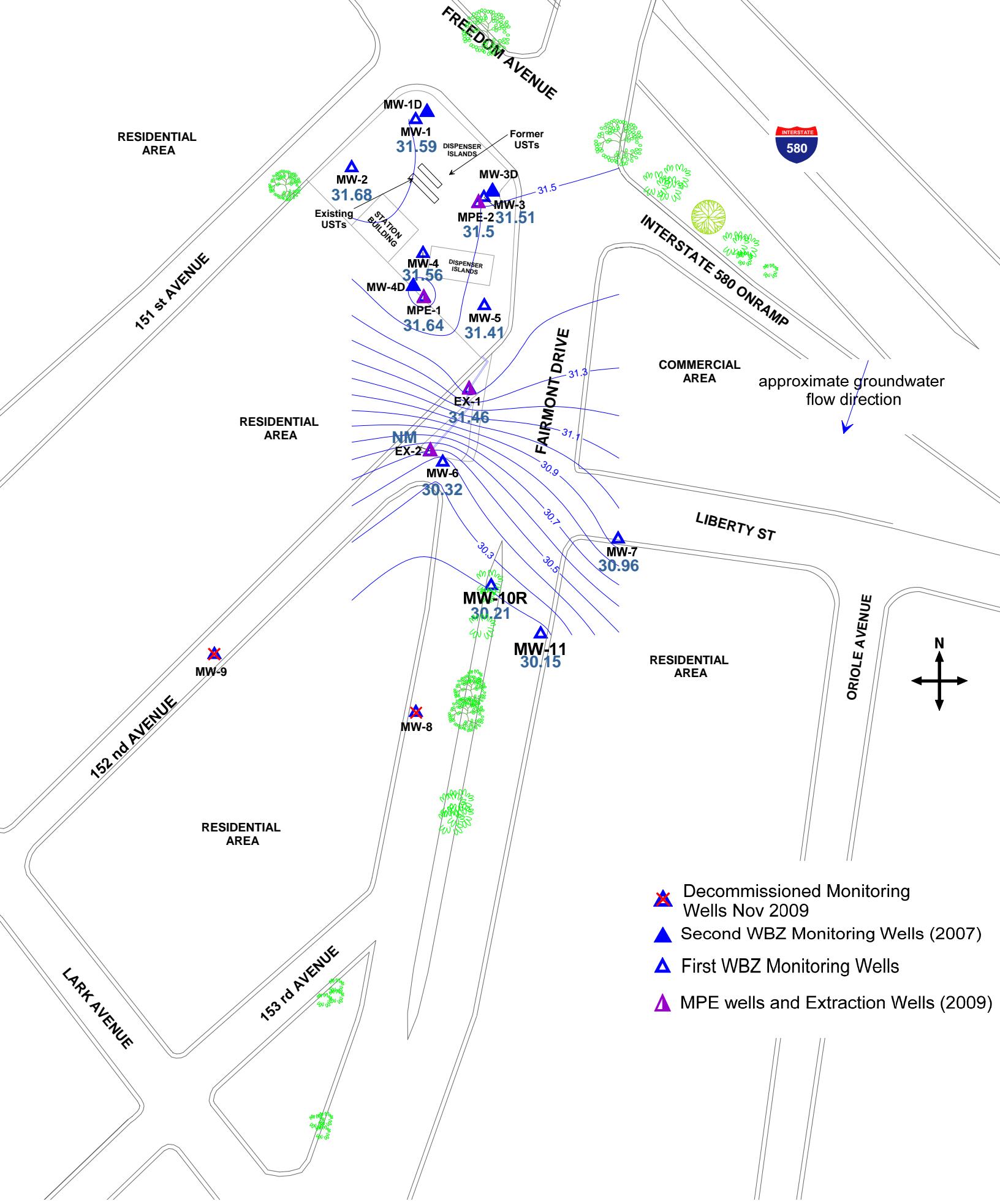



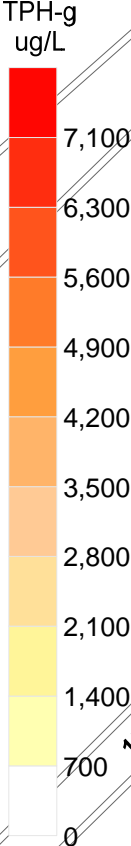
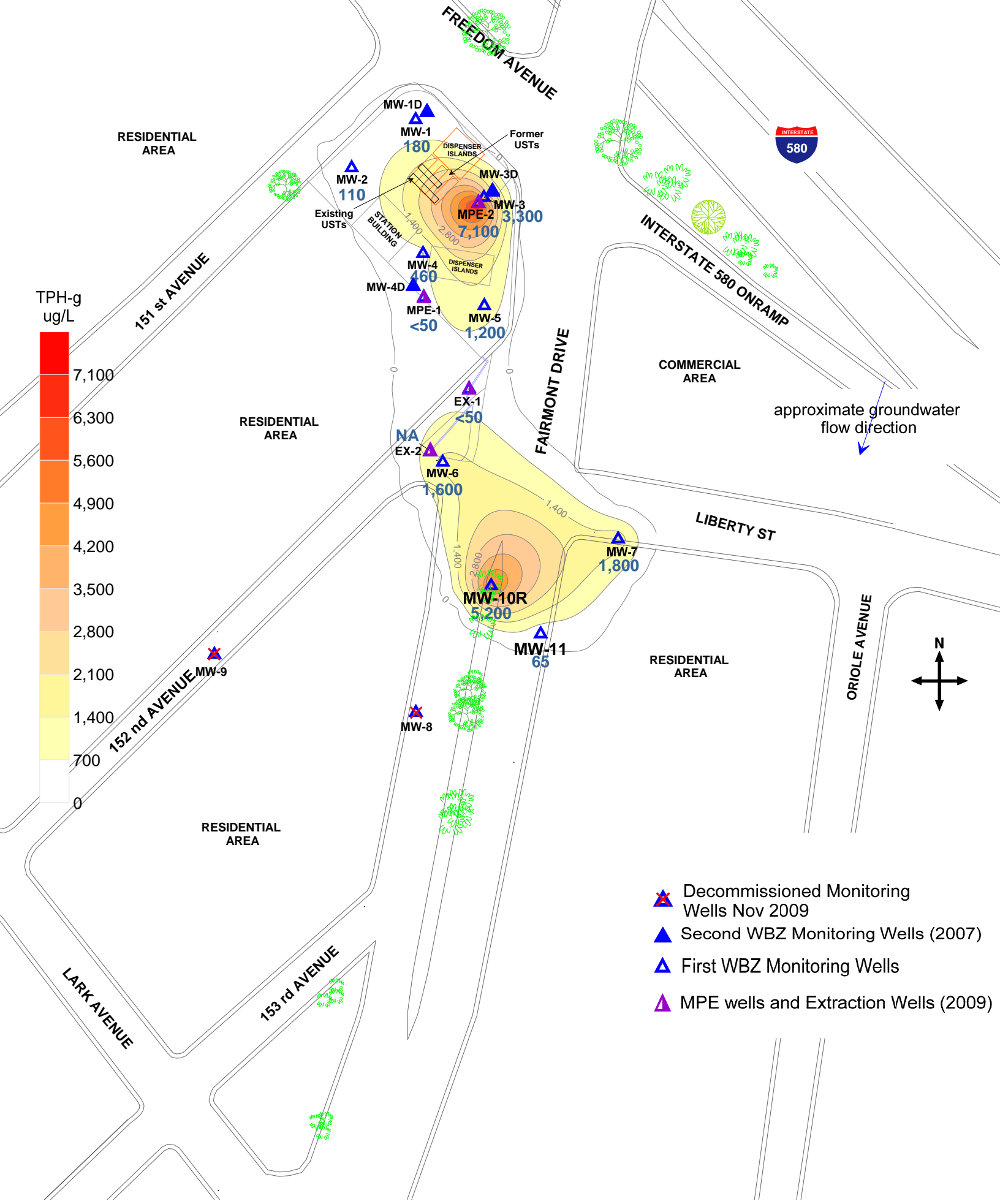

Figure 3: Groundwater Elevation Contour Map in Feet, First WBZ, December 14, 2016

approximate scale in feet
 0 50 100

-  Decommissioned Monitoring Wells Nov 2009
-  Second WBZ Monitoring Wells (2007)
-  First WBZ Monitoring Wells
-  MPE wells and Extraction Wells (2009)



- Decommissioned Monitoring Wells Nov 2009
- Second WBZ Monitoring Wells (2007)
- First WBZ Monitoring Wells
- MPE wells and Extraction Wells (2009)

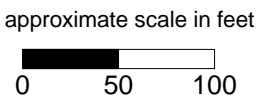
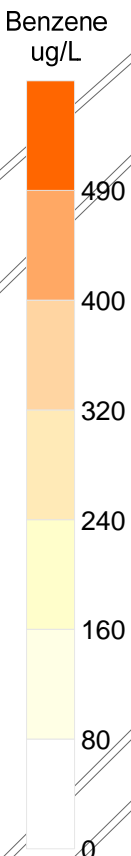
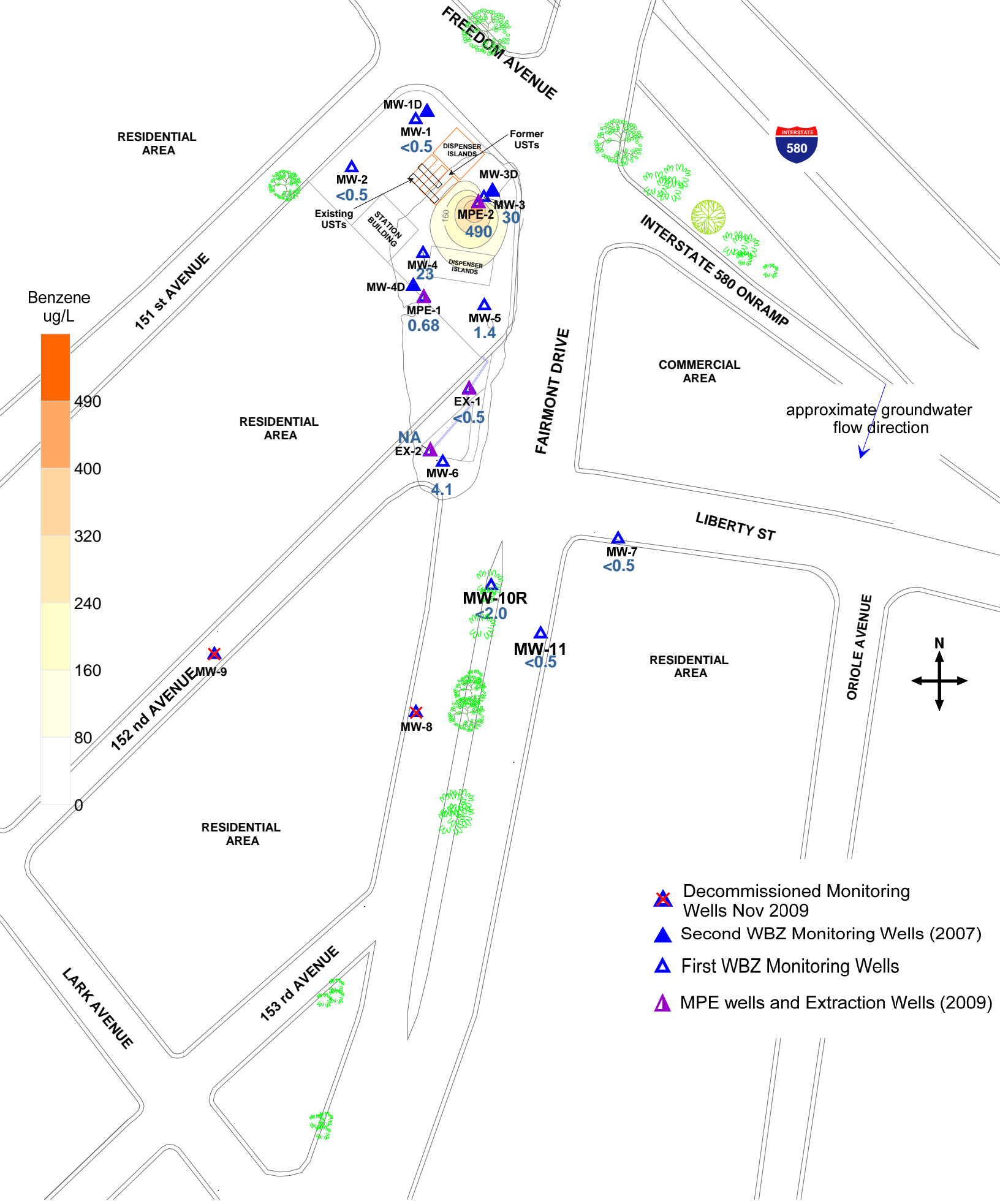





Figure 4: Contour Map of TPH-g Concentrations in Groundwater, First WBZ, December 14 and 15, 2016



-  Decommissioned Monitoring Wells Nov 2009
-  Second WBZ Monitoring Wells (2007)
-  First WBZ Monitoring Wells
-  MPE wells and Extraction Wells (2009)

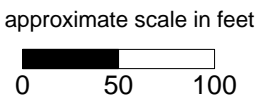

Figure 5: Contour Map of benzene Concentrations in Groundwater, First WBZ, December 14 and 15, 2016

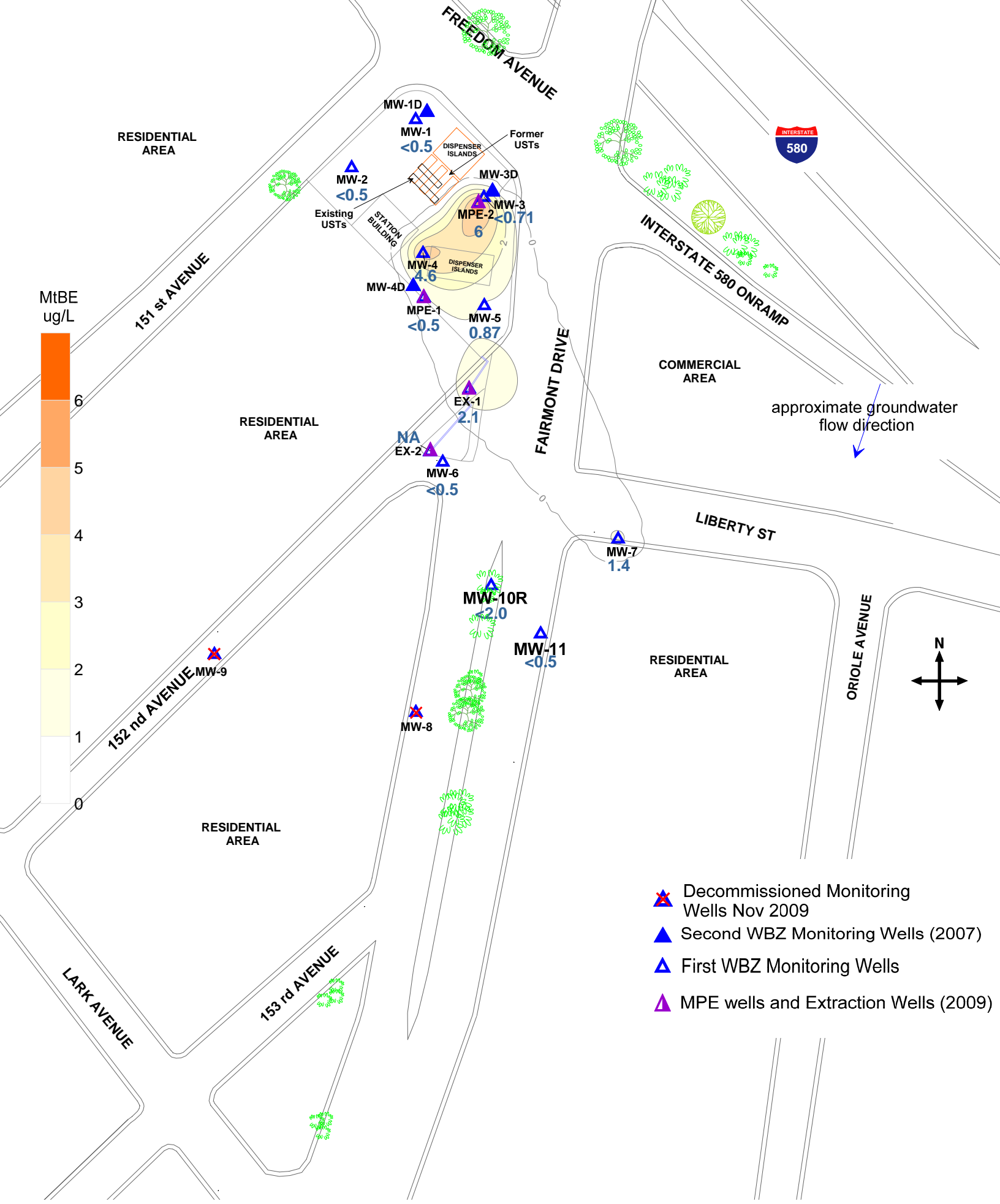

Figure 6: Contour Map of MtBE Concentrations in Groundwater, First WBZ, December 14 and 15, 2016

approximate scale in feet
 0 50 100

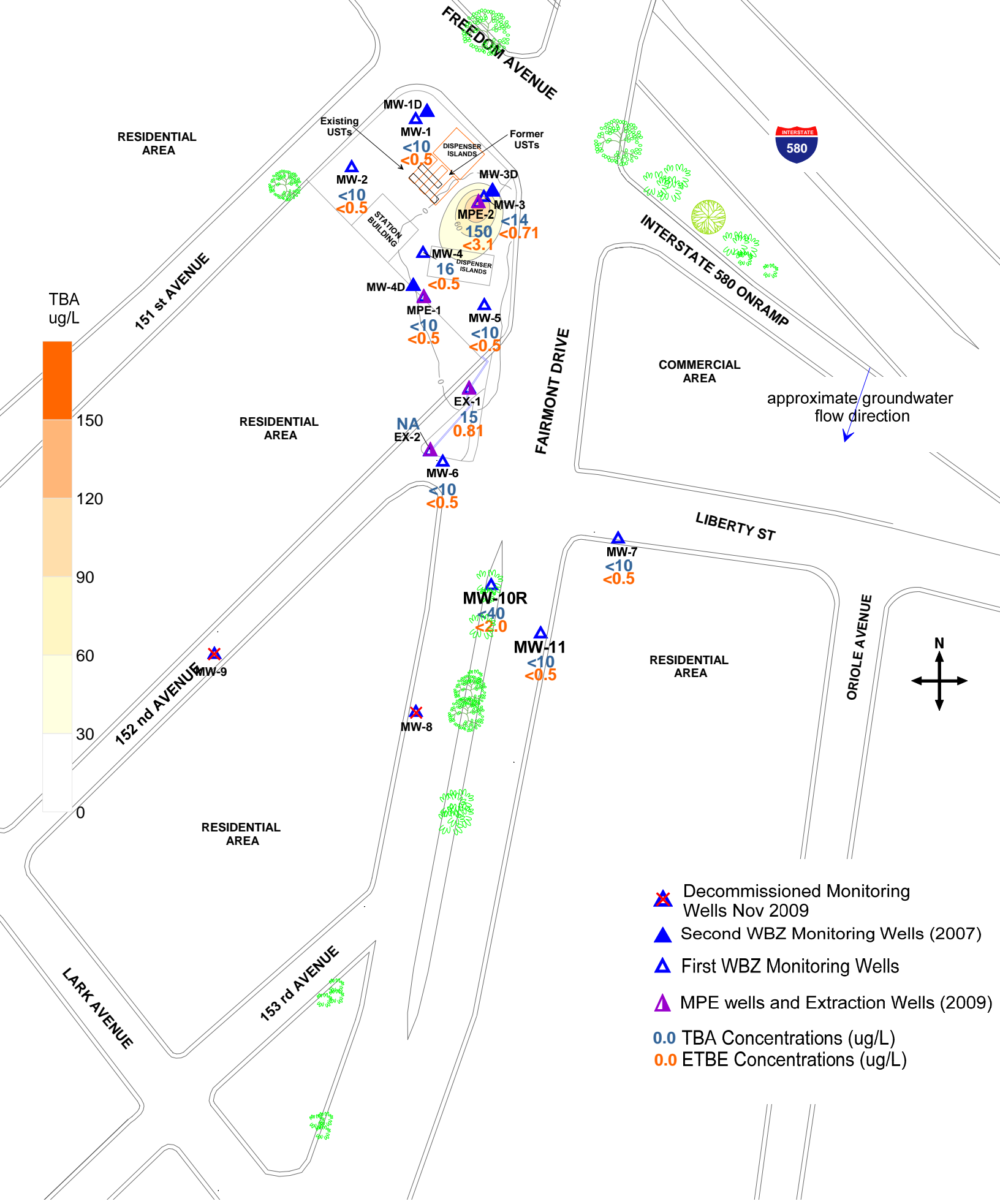
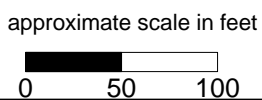

Figure 7: Contour Map of TBA Concentrations and Map of ETBE Concentrations in Groundwater, December 14 and 15, 2016



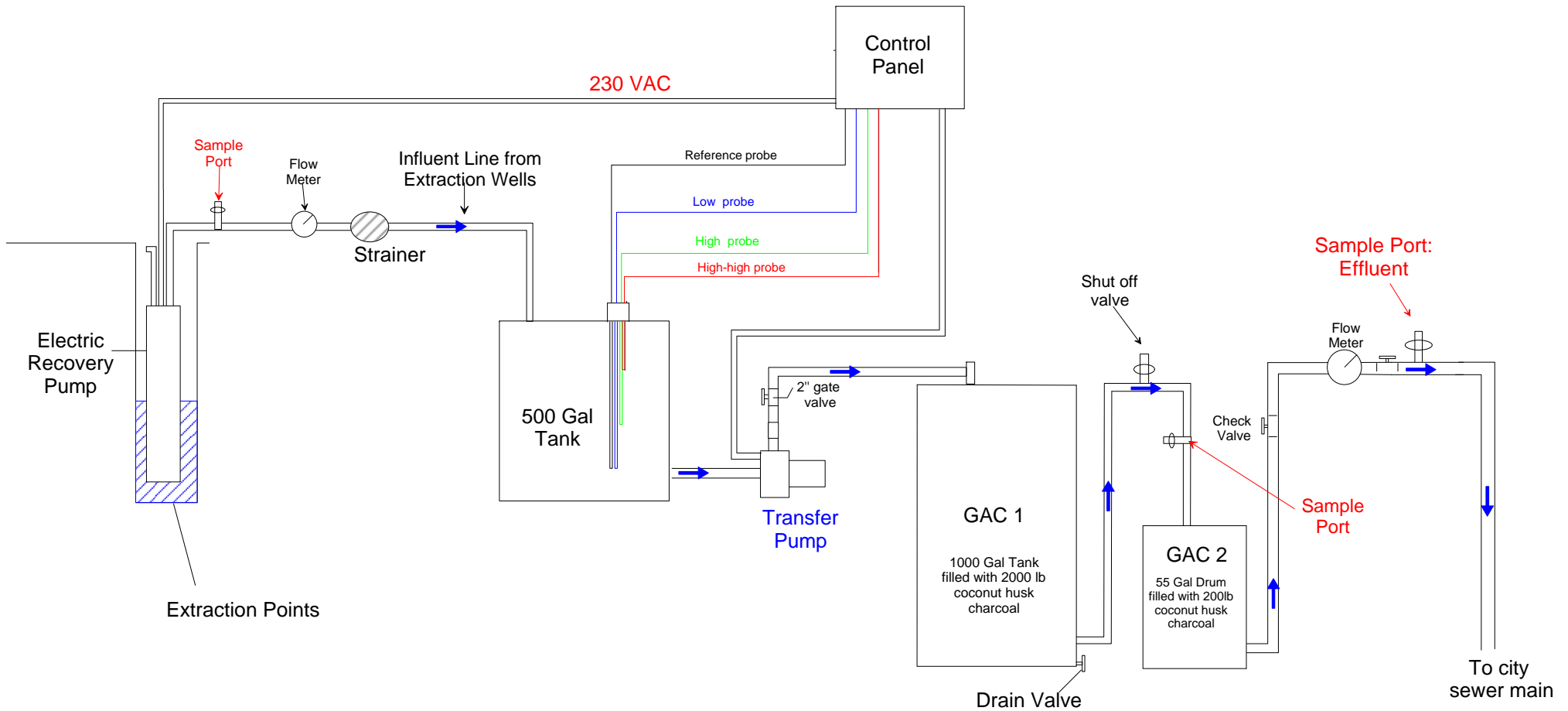

Figure 8: Schematic diagram of Groundwater Remediation System

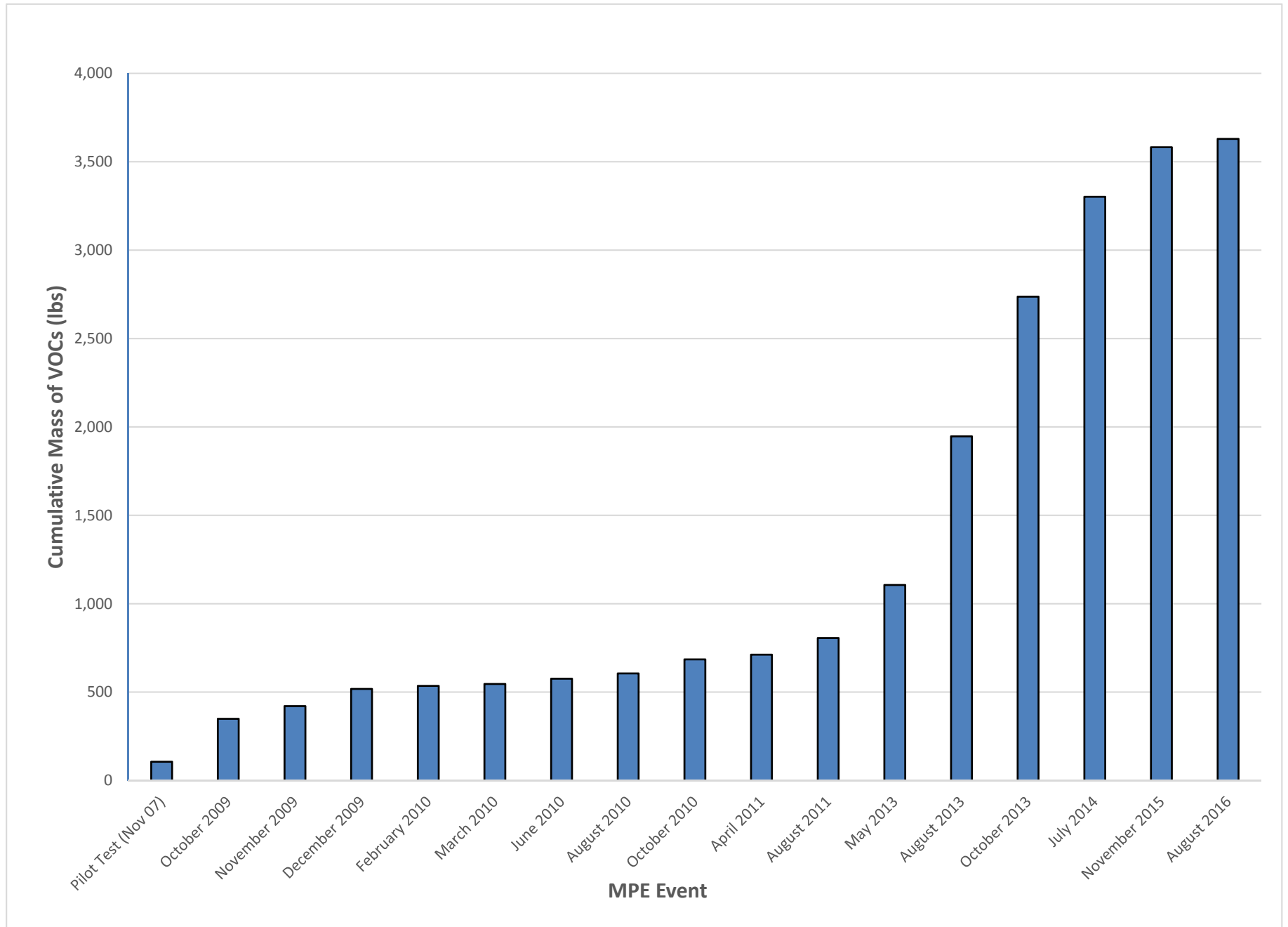

Figure 9: Cumulative Mass of VOCs Removed

Tables

Table 1
Historical Groundwater Elevation Data and Analytical Results
15101 Freedom Avenue, San Leandro, CA

Monitoring Well	Date	Casing Elevation ¹ (feet)	Depth to Groundwater (feet)	Free-Product (feet)/ Sheen (Y/N)	Groundwater Elevation (feet)	TPH-g (µg/L)	Benzene (µg/L)	Toluene (µg/L)	Ethyl-benzene (µg/L)	Total Xylenes (µg/L)	MtBE 8260B ² (µg/L)
1st WBZ											
MW-1	5/10/2002	51.71	22.85	-	28.86	5,700	360	4.5	340	450	2
	8/8/2002	51.71	23.31	-	28.40	9,100	590	2.6	830	362	<1.3
	11/8/2002	51.71	23.58	-	28.13	7,900	570	3.1	680	392	< 1.0
	2/21/2003	51.71	22.62	-	29.09	2,900	160	1.6 C	170	211	<0.5
	5/28/2003	51.71	22.43	-	29.28	1,700	55	<0.5	90	115	2.00
	8/12/2003	51.71	21.30	-	30.41	2,600	2.5	<0.5	190	130	<0.5
	10/9/2003	51.71	23.49	-	28.22	9,200	560.0	2.7 C	670	648	<1.0
	1/15/2004	51.71	22.43	-	29.28	5,500	190	<1.0	220	124.4	<0.5
	5/25/2004	51.71	22.94	-	28.77	8,000	400	1.50	420	393	3.40
	9/21/2004	54.46	23.49	-	30.97	9,300	580	9.30	690	683	4.60
	12/14/2004	54.46	23.01	-	31.45	7,360	337	<4.3	731	633	<4.3
	3/11/2005	54.46	21.48	-	32.98	2,510	45.2	<0.5	23.2	39.63	2.80
	6/15/2005	54.46	22.42	-	32.04	1,690	36.3	<2.0	59.5	28.73	2.01
	8/26/2005	54.46	23.00	-	31.46	7,310	318	<8.60	475	316	5.15
	11/11/2005	54.46	21.40	-	33.06	9,640	341	<8.6	467	329.7	6.04
	2/9/2006	54.46	21.81	-	32.65	775	14	<2.0	12.6	10.32	4.01
	5/9/2006	54.46	21.68	-	32.78	444	7.80	<2.0	12.1	6.31	1.75
	8/10/2006	54.46	22.79	-	31.67	5,090	324	<8.60	108	59.9	8.24
10/26/2006	54.46	23.19	-	31.27	6,950	556	<4.0	190	136.09	8.61	
1/25/2007	54.46	22.82	-	31.64	2,640	196	<2.0	105	25.5	7.92	
4/26/2007	54.46	22.67	-	31.79	861	95.5	<2.0	17	6.36	4.00	
7/25/2007	54.46	23.25	-	31.21	4,520	412	<4.0	182	77.9	7.48	
10/23/2007	54.46	23.42	-	31.04	3,900	117	<2.0	87.1	23.87	4.54	

Table 1
Historical Groundwater Elevation Data and Analytical Results
15101 Freedom Avenue, San Leandro, CA

Monitoring Well	Date	Casing Elevation ¹ (feet)	Depth to Groundwater (feet)	Free-Product (feet)/ Sheen (Y/N)	Groundwater Elevation (feet)	TPH-g (µg/L)	Benzene (µg/L)	Toluene (µg/L)	Ethyl-benzene (µg/L)	Total Xylenes (µg/L)	MtBE 8260B ² (µg/L)
MW-1 cont.	1/22/2008	54.46	22.59	-	31.87	2,260	81.3	<2.0	17.5	<2.0	4.23
	4/16/2008	54.46	22.89	-	31.57	2,320	248	<2.0	54.1	37.3	<0.5
	7/3/2008	54.46	23.33	-	31.13	5,240	414	<2.0	168	94	6.56
	10/15/2008	54.46	23.76	-	30.70	4,500 ^Y	260	<1.0	150	130	3.40
	1/7/2009	54.46	23.25	-	31.21	4,800	140	<1.3	48	32	1.70
	4/14/2009	54.46	22.52	-	31.94	1,800 ^Y	78	<0.5	35	18	2.50
	8/27/2009	54.46	23.6	-	30.86	4,500	330	<2.0	97	42	4.60
	12/2/2009	54.46	23.43	-	31.03	3,800 ^Y	250	<2.0	110	25	2.50
	3/17/2010	54.46	22.32	-	32.14	1,100	33	<0.50	46	18	1.70
	6/3/2010	54.46	22.88	-	31.58	10,000	330	4.3	680	841.5	5.20
	9/2/2010	54.46	23.28	-	31.18	8,900	440	<5.0	510	310	<5.0
	12/2/2010	54.46	23.21	-	31.25	7,400	250	<3.1	390	180	<3.1
	3/4/2011	54.46	21.95	N	32.51	2,400	67	<0.5	45	8.4	2.20
	5/20/2011	54.46	22.8	N	31.66	9,500	260	6.2	970	480	<3.6
	9/9/2011	54.46	22.81	N	31.65	6,400	220	<1.3	380	160	2.30
	12/2/2011	54.46	21.97	N	32.49	4,700 ^x	96	<1.7	310	200	<3.3
	3/2/2012	54.46	22.82	N	31.64	6,800	320	<2.5	430	120	<2.5
	6/7/2012	54.46	22.92	N	31.54	5,600	130	<2.5	360	160	2.9
	9/21/2012	54.46	23.56	N	30.90	8,000	300	<2.5	410	340	2.6
	12/14/2012	54.46	22.77	N	31.69	5,900	130	<2.5	320	97	<2.5
3/28/2013	54.46	23.15	N	31.31	5,100	230	<2.5	280	48	3.6	
6/11/2013	54.46	23.48	N	30.98	6,800	200	<2.5	300	120	<2.5	
9/17/2013	54.46	23.84	N	30.62	7,500	120	<2.5	410	260	<2.5	
12/6/2013	54.46	24.16	N	30.30	5,300	71	<1.7	240	84	<1.7	

Table 1
Historical Groundwater Elevation Data and Analytical Results
15101 Freedom Avenue, San Leandro, CA

Monitoring Well	Date	Casing Elevation ¹ (feet)	Depth to Groundwater (feet)	Free-Product (feet)/ Sheen (Y/N)	Groundwater Elevation (feet)	TPH-g (µg/L)	Benzene (µg/L)	Toluene (µg/L)	Ethyl-benzene (µg/L)	Total Xylenes (µg/L)	MtBE 8260B ² (µg/L)
MW-1 cont.	3/13/2014	54.46	23.47	N	30.99	2,800	16	<0.5	74	15	1.4
	6/6/2014	54.46	23.46	N	31.00	5,000	47	<0.5	240	58	0.9
	9/23/2014	54.46	24.49	N	29.97	6,700	44	<1.7	200	71	<1.7
	12/23/2014	54.46	21.52	N	32.94	730	2.2	<0.5	0.84	<0.5	<0.5
	3/20/2015	54.46	22.83	N	31.63	1,200	8.6	1.9	17	<0.5	0.59
	6/4/2015	54.46	23.22	N	31.24	5,100	23	<0.71	110	3.6	0.73
	9/11/2015	54.46	23.76	N	30.70	4,200	3.3	<1.7	18	<1.7	<1.7
	12/28/2015	54.46	23.39	N	31.07	590	<0.5	<0.5	1.4	0.55	<0.5
	3/23/2016	54.46	21.38	N	33.08	98	<0.5	<0.5	<0.5	<0.5	<0.5
	6/15/2016	54.46	21.41	N	33.05	1,300	37	<0.5	99	9.3	0.79
	9/21/2016	54.46	23.53	N	30.93	4,800	47	0.57	74	0.62	<0.5
	12/14/2016	54.46	22.87	N	31.59	180	<0.5	<0.5	<0.5	<0.5	<0.5
	MW-2	5/10/2002	49.66	22.83	-	26.83 *	3,100	67	8	250	215
8/8/2002		49.66	21.41	-	28.25	2,700	4.6	<0.5	310	140	<0.5
11/8/2002		49.66	21.79	-	27.87	3,400	4.6	< 0.5	310	160	< 0.5
2/21/2003		49.66	20.51	-	29.15	890	1.7 C	0.80 C	68	38.92 C	<0.5
5/28/2003		49.66	20.33	-	29.33	2,700	5.2 C	<0.5	120	140	1.2
8/12/2003		49.66	23.18	-	26.48*	8,500	640	<2.5	560	659	<0.8
10/9/2003		49.66	21.71	-	27.95	3100 H	4.3 C	<0.5	210	160	<0.5
1/15/2004		49.66	20.31	-	29.35	660 H	1.5 C	<0.5	8.9	25	<0.5
5/25/2004		49.66	21.09	-	28.57	4,500	5.1 C	<0.5	190	230	0.70
9/21/2004		52.41	21.71	-	30.70	370	0.76 C	<0.5	25	16	0.50
12/14/2004		52.41	21.20	-	31.21	880	1.0	<0.5	66	52	<0.5
3/11/2005		52.41	19.15	-	33.26	564	<0.5	<0.5	21	11.9	<0.5
6/15/2005		52.41	20.30	-	32.11	2,040	1.2	<2.0	78.2	22	<0.5
8/26/2005		52.41	20.97	-	31.44	1,500	0.930	<2.00	87.6	21	0.86
11/11/2005		52.41	25.30	-	27.11	2,140	1.08	<2.0	104	29	0.79
2/9/2006		52.41	19.41	-	33.00	1,410	<0.5	<2.0	99.6	21.4	0.72
5/9/2006	52.41	19.41	-	33.00	1,100	<0.5	<2.0	86.5	17	<0.5	
8/10/2006	52.41	20.8	-	31.61	3,180	2.87	<2.0	88.9	24.8	<0.50	
10/26/2006	52.41	21.22	-	31.19	1,200	<0.5	<2.0	23.5	4.79	0.6	

Table 1
Historical Groundwater Elevation Data and Analytical Results
15101 Freedom Avenue, San Leandro, CA

Monitoring Well	Date	Casing Elevation ¹ (feet)	Depth to Groundwater (feet)	Free-Product (feet)/ Sheen (Y/N)	Groundwater Elevation (feet)	TPH-g (µg/L)	Benzene (µg/L)	Toluene (µg/L)	Ethyl-benzene (µg/L)	Total Xylenes (µg/L)	MtBE 8260B ² (µg/L)
MW-2 cont.	1/25/2007	52.41	20.89	-	31.52	623	0.64	<2.0	42.4	4.37	0.66
	4/26/2007	52.41	20.65	-	31.76	169	<0.5	<2.0	15.2	2.3	<0.5
	7/25/2007	52.41	21.43	-	30.98	276	0.78	<2.0	22.1	4.04	<0.5
	10/23/2007	52.41	21.59	-	30.82	535	<0.5	<2.0	18	5.11	<0.5
	1/22/2008	52.31	20.45	-	31.86	132	<0.5	<2.0	12.2	<2.0	<0.5
	4/15/2008	52.41	20.89	-	31.52	852	<0.5	<2.0	27.2	4.78	<0.5
	7/2/2008	52.41	21.5	-	30.91	98.3	<0.5	<2.0	2.76	<2.0	<0.5
	10/15/2008	52.41	22.06	-	30.35	1,400 ^Y	<0.5	<0.5	60	17	<0.5
	1/7/2009	52.41	21.35	-	31.06	93	<0.5	<0.5	2.1	0.74	<0.5
	4/13/2009	52.41	20.52	-	31.89	480 ^Y	<0.5	<0.5	20	5.5	<0.5
	8/27/2009	52.41	21.85	-	30.56	130	<0.5	<0.5	2.5	0.61	<0.5
	12/1/2009	52.41	21.59	-	30.82	760 ^Y	<0.5	<0.5	14	1.5	<0.5
	3/17/2010	52.41	20.11	-	32.30	480	<0.5	<0.5	30	6.9	<0.5
	6/3/2010	52.41	21	-	31.41	690	<0.5	<0.5	14	2.6	<0.5
	9/2/2010	52.41	21.42	-	30.99	470	<0.5	<0.5	7.6	1	<0.5
	12/2/2010	52.41	21.44	-	30.97	470	<0.5	<0.5	7.6	3.3	<0.5
	3/4/2011	52.41	19.65	N	32.76	240	<0.5	<0.5	6.6	0.8	<0.5
	5/20/2011	52.41	20.75	N	31.66	310	<0.5	<0.5	4.8	<0.5	<0.5
	9/9/2011	52.41	21.05	N	31.36	1,000	<0.5	<0.5	12	0.76	<0.5
	12/2/2011	52.41	20.14	N	32.27	900 ^x	<2.9	<1.7	14	1.9	<3.3
3/2/2012	52.41	19.98	N	32.43	880	<0.5	<0.5	5.3	0.58	<0.5	
6/7/2012	52.41	21.04	N	31.37	720	<0.5	<0.5	7.9	0.79	<0.5	
9/21/2012	52.41	21.78	N	30.63	1,400	<0.5	<0.5	11	<0.5	<0.5	
12/14/2012	52.41	20.71	N	31.70	760	<0.5	<0.5	10	1.5	<0.5	

Table 1
Historical Groundwater Elevation Data and Analytical Results
15101 Freedom Avenue, San Leandro, CA

Monitoring Well	Date	Casing Elevation ¹ (feet)	Depth to Groundwater (feet)	Free-Product (feet)/ Sheen (Y/N)	Groundwater Elevation (feet)	TPH-g (µg/L)	Benzene (µg/L)	Toluene (µg/L)	Ethyl-benzene (µg/L)	Total Xylenes (µg/L)	MtBE 8260B ² (µg/L)
MW-2 cont.	3/28/2013	52.41	21.24	N	31.17	890	<0.5	<0.5	4.3	<0.5	<0.5
	6/11/2013	52.41	21.67	N	30.74	510	150	<0.5	15	12.3	3.1
	9/16/2013	52.41	22.15	N	30.26	210	<0.5	<0.5	1.1	<0.5	<0.5
	12/6/2013	52.41	22.52	N	29.89	290	1.4	<0.5	1.1	<0.5	<0.5
	3/13/2014	52.41	21.56	N	30.85	190	<0.5	<0.5	<0.5	<0.5	<0.5
	6/6/2014	52.41	21.7	N	30.71	97	<0.5	<0.5	<0.5	<0.5	<0.5
	9/23/2014	52.41	22.95	N	29.46	80	<0.5	<0.5	<0.5	<0.5	<0.5
	12/23/2014	52.41	18.91	N	33.50	140	<0.5	0.7	1.8	<0.5	<0.5
	3/20/2015	52.41	20.76	N	31.65	380	<0.5	0.8	0.86	<0.5	<0.5
	6/4/2015	52.41	21.3	N	31.11	700	<0.5	<0.5	0.72	<0.5	<0.5
	9/11/2015	52.41	21.95	N	30.46	1,900	<1.0	<1.0	2.3	<1.0	<1.0
	12/28/2015	52.41	21.38	N	31.03	170	<0.5	<0.5	0.51	<0.5	<0.5
	3/23/2016	52.41	18.88	N	33.53	170	<0.5	<0.5	<0.5	<0.5	<0.5
	6/15/2016	52.41	18.91	N	33.50	380	<0.5	<0.5	<0.5	<0.5	<0.5
	9/21/2016	52.41	21.71	N	30.70	680	<0.5	<0.5	<0.5	<0.5	<0.5
	12/14/2016	52.41	20.73	N	31.68	110	<0.5	<0.5	<0.5	<0.5	<0.5
MW-3	5/10/2002	51.16	22.28	-	28.88	44,000	6,000	900	1,500	6,200	2,400
	8/8/2002	51.16	22.88	-	28.28	40,000	5,800	1,100	1,600	6,500	1,300
	11/8/2002	51.16	23.19	-	27.97	47,000	5,300	1,200	2,200	8,600	1,000
	2/21/2003	51.16	22.02	-	29.14	39,000	5,500	1,500	2,000	8,600	1,300
	5/28/2003	51.16	21.89	-	29.27	52,000	7,300	3,000	2,800	12,700	2,100
	8/12/2003	51.16	22.66	-	28.50	31,000	6,100	860	1,500	6,900	1,200
	10/9/2003	51.16	23.06	-	28.10	41,000	6,100	1,100	2,200	10,200	960
	1/15/2004	51.16	21.85	-	29.31	51,000	4,100	1,100	2,000	8,400	590
	5/25/2004	51.16	22.55	-	28.61	65,000	4,300	1,300	2,500	10,500	720
	9/21/2004	53.91	23.08	-	30.83	42,000	4,900	890	2,200	8,700	480
	12/14/2004	53.91	22.52	-	31.39	35,151	4,066	972	2,942	13,032	491
	3/11/2005	53.91	20.90	-	33.01	42,600	3,040	1,100	1,530	6,670	968
	6/15/2005	53.91	21.85	-	32.06	84,100	5,110	2,160	3,030	8,800	2,670
8/26/2005	53.91	22.49	-	31.42	43,500	3,630	1,080	2,500	6,830	1,440	
11/11/2005	53.91	22.81	-	31.10	47,700	4,240	520	2,170	6,320	1,390	

Table 1
Historical Groundwater Elevation Data and Analytical Results
15101 Freedom Avenue, San Leandro, CA

Monitoring Well	Date	Casing Elevation ¹ (feet)	Depth to Groundwater (feet)	Free-Product (feet)/ Sheen (Y/N)	Groundwater Elevation (feet)	TPH-g (µg/L)	Benzene (µg/L)	Toluene (µg/L)	Ethyl-benzene (µg/L)	Total Xylenes (µg/L)	MtBE 8260B ² (µg/L)
MW-3 cont.	2/9/2006	53.91	21.12	-	32.79	44,500	5,070	1360	1,920	4,840	3,280
	5/9/2006	53.91	21.09	-	32.82	48,100	2,510	1,140	1,950	5,030	2,210
	8/10/2006	53.91	22.26	-	31.65	42,100	3,450	869	1,760	5,650	3,570
	10/26/2006	53.91	22.73	-	31.18	33,400	4,800	331	1,170	3,510	4,790
	1/25/2007	53.91	22.34	-	31.57	19,300	4,820	167	1,540	3,740	3,430
	4/26/2007	53.91	22.24	-	31.67	30,700	2,350	158	1,470	4,320	1,330
	7/25/2007	53.91	22.83	-	31.08	34,900	5,400	364	2,080	6,360	1,980
	10/23/2007	53.91	23.01	-	30.9	22,600	4,070	<86	1,120	3,095	970
	1/22/2008	53.96	22.04	-	31.92	22,100	1,280	453	1,330	3,520	490
	4/16/2008	53.91	22.4	-	31.51	20,700	2,790	182	860	3,389	263
	7/3/2008	53.91	22.9	-	31.01	48,500	3,760	346	3,130	12,980	573
	10/16/2008	53.91	23.36	-	30.55	50,000	3,900	300	3,100	11,000	460
	1/8/2009	53.91	22.82	-	31.09	54,000	2,600	180	2,500	8,800	220
	4/13/2009	53.91	22.06	-	31.85	49,000	2,900	170	2,100	8,100	490
	8/27/2009	53.91	23.11	-	30.80	43,000	2,500	160	1,900	7,000	210
	12/2/2009	53.91	23.00	-	30.91	30,000	2,100	180	1,600	5,600	91
	3/17/2010	53.91	21.90	-	32.01	24,000	970	81	1,100	3,700	38
	6/3/2010	53.91	22.49	-	31.42	31,000	1,200	110	1,300	4,400	34
	9/2/2010	53.91	22.76	-	31.15	26,000	1,100	81	1,200	3,810	26
	12/2/2010	53.91	22.86	-	31.05	18,000	830	47	780	2,360	14
3/4/2011	53.91	21.44	N	32.47	18,000	410	32	850	2,480	16	
5/20/2011	53.91	22.36	N	31.55	12,000	710	24	620	1,460	11	
9/9/2011	53.91	22.44	N	31.47	11,000	1,100	26	580	1,430	7.8	
12/2/2011	53.91	21.60	N	32.31	5,100 ^x	280	12	370	740	<1.7	

Table 1
Historical Groundwater Elevation Data and Analytical Results
15101 Freedom Avenue, San Leandro, CA

Monitoring Well	Date	Casing Elevation ¹ (feet)	Depth to Groundwater (feet)	Free-Product (feet)/ Sheen (Y/N)	Groundwater Elevation (feet)	TPH-g (µg/L)	Benzene (µg/L)	Toluene (µg/L)	Ethyl-benzene (µg/L)	Total Xylenes (µg/L)	MtBE 8260B ² (µg/L)	
MW-3 cont.	3/2/2012	53.91	22.39	N	31.52	13,000	440	23	690	1,570	<5.0	
	6/7/2012	53.91	22.50	N	31.41	9,000	290	9.3	520	900	<5.0	
	9/21/2012	53.91	23.17	N	30.74	12,000	710	26	630	1,230	8.2	
	12/14/2012	53.91	22.32	Y	31.59	8,500	350	8.7	550	1,003	<5	
	3/28/2013	53.91	22.69	Y	31.22	9,300	790	8.2	760	974	8.7	
	6/11/2013	53.91	23.06	Y	30.85	14,000	700	26	860	1,630	6.1	
	9/17/2013	53.91	23.41	Y	30.50	28,000	570	37	1,800	3,560	<10	
	12/6/2013	53.91	23.76	Y	30.15	23,000	360	26	1,700	3,330	<10	
	3/12/2014	53.91	23.13	22.98	30.88	FP	FP	FP	FP	FP	FP	FP
	6/5/2014	53.91	23.08	23.06	30.84	FP	FP	FP	FP	FP	FP	FP
	9/23/2014	53.91	24.16	Y	29.75	41,000	230	84	1,000	4,500	<10	
	12/23/2014	53.91	20.83	N	33.08	13,000	64	28	250	1,250	<3.6	
	3/20/2015	53.91	22.32	Y	31.59	18,000	140	24	730	1,870	<3.6	
	6/4/2015	53.91	22.77	Y	31.14	32,000	200	17	680	1,820	<6.3	
	9/11/2015	53.91	23.31	Y	30.60	24,000	260	<6.3	380	1,144	<6.3	
	12/29/2015	53.91	22.95	Y	30.96	13,000	74	<5.0	220	628	<5.0	
	3/24/2016	53.91	20.75	Y	33.16	7,600	180	2	130	263	3.2	
	6/16/2016	53.91	20.78	Y	33.13	10,000	98	2.6	250	507	1.7	
	9/21/2016	53.91	23.12	N	30.79	12,000	380	<2.5	250	424	<2.5	
12/14/2016	53.91	22.4	N	31.51	3,300	30	<0.71	63	94.6	<0.71		
MW-4	5/10/2002	50.54	21.78	-	28.76	880	25	1.0C	110	52	12,000	
	8/8/2002	50.54	22.50	-	28.04	3,800	70	<5.0	300	115	4,800	
	11/8/2002	50.54	22.81	-	27.73	5,100	150	10	460	258	2,400	
	2/21/2003	50.54	21.48	-	29.06	3,200	98	66	220	360	6,600	
	5/28/2003	50.54	21.24	-	29.30	6,200	140	46	200	790	2,300	
	8/12/2003	50.54	22.32	-	28.22	7,500	180	57	220	1450	1,900	
	10/9/2003	50.54	22.74	-	27.80	5,800	250	32	300	970	7,800	
	1/15/2004	50.54	21.19	-	29.35	5,900	270	17 C	150	640	7,300	
	5/25/2004	50.54	22.03	-	28.51	9,100	210	51	200	1190	1800	
	9/21/2004	53.31	22.76	-	30.55	5,200	290	12	370	600	7300	
	12/14/2004	53.31	21.99	-	31.32	8,937	538	114	416	2379	5021	

Table 1
Historical Groundwater Elevation Data and Analytical Results
15101 Freedom Avenue, San Leandro, CA

Monitoring Well	Date	Casing Elevation ¹ (feet)	Depth to Groundwater (feet)	Free-Product (feet)/ Sheen (Y/N)	Groundwater Elevation (feet)	TPH-g (µg/L)	Benzene (µg/L)	Toluene (µg/L)	Ethyl-benzene (µg/L)	Total Xylenes (µg/L)	MtBE 8260B ² (µg/L)
MW-4 cont.	3/11/2005	53.31	20.01	-	33.30	12,300	225	39.6	80.1	1465	3870
	6/15/2005	53.31	21.25	-	32.06	7,690	114	32.6	77.1	555	1150
	8/26/2005	53.31	22.03	-	31.28	8,850	175	24.6	150	851	1380
	11/11/2005	53.31	22.43	-	30.88	9,990	356	<43	196	700	3,640
	2/9/2006	53.31	20.31	-	33.00	6,850	205	<43	67.2	255.2	5,120
	5/9/2006	53.31	20.33	-	32.98	1,290	18.1	<8.6	12.9	25.87	799
	8/10/2006	53.31	21.74	-	31.57	7,830	118	<8.60	25.3	174.6	919
	10/26/2006	53.31	22.29	-	31.02	1,540	81.9	<43	96	46.4	3,610
	1/25/2007	53.31	21.86	-	31.45	4,370	163	<8.6	85.1	269.1	1,050
	4/26/2007	53.31	21.63	-	31.68	4,380	140	<8.6	67	276.8	576
	7/25/2007	53.31	22.49	-	30.82	4,970	220	<8.60	198	241.5	1,040
	10/23/2007	53.31	22.69	-	30.62	4,200	267	<8.6	147	155.5	1,220
	1/22/2008	53.36	21.39	-	31.97	2,180	133	<22.0	43.1	32.2	1,800
	4/15/2008	53.31	21.9	-	31.41	4,240	90.4	<22.0	107	380	674
	7/2/2008	53.31	22.55	-	30.76	2,300	193	<22.0	212	183	4,050
	10/16/2008	53.31	23.13	-	30.18	8,900	320	3.7	430	1,160	450
	1/8/2009	53.31	22.42	-	30.89	19,000	430	44	590	3,380	440
	4/13/2009	53.31	21.51	-	31.80	21,000	400	38	450	2,880	330
	8/27/2009	53.31	22.94	-	30.37	16,000	960	64	560	2,120	290
	12/2/2009	53.31	22.36	-	30.95	4,400	480	6	170	640	110
3/17/2010	53.31	21.39	-	31.92	14,000	260	6	230	1,220	93	
6/3/2010	53.31	22.23	-	31.08	18,000	240	4	310	770	41	
9/2/2010	53.31	22.51	-	30.80	1,800	800	<3.6	150	25	33	
12/2/2010	53.31	22.71	-	30.60	3,800	1,500	<10	200	115	29	

Table 1
Historical Groundwater Elevation Data and Analytical Results
15101 Freedom Avenue, San Leandro, CA

Monitoring Well	Date	Casing Elevation ¹ (feet)	Depth to Groundwater (feet)	Free-Product (feet)/ Sheen (Y/N)	Groundwater Elevation (feet)	TPH-g (µg/L)	Benzene (µg/L)	Toluene (µg/L)	Ethyl-benzene (µg/L)	Total Xylenes (µg/L)	MtBE 8260B ² (µg/L)
MW-4 cont.	3/3/2011	53.31	20.64	N	32.67	2,400	28	<0.71	28	17	3
	5/19/2011	53.31	21.84	N	31.47	1,800	27	<0.5	29	11.2	4.8
	9/8/2011	53.31	22.11	N	31.20	3,600	300	2.6	270	68.5	59
	12/1/2011	53.31	21.38	N	31.93	1,400 ^x	370	<0.84	110	30.6	110
	3/2/2012	53.31	22.02	N	31.29	3,100	780	<2.0	150	59.6	50
	6/7/2012	53.31	22.24	N	31.07	2,000	290	<2.5	66	23	29
	9/21/2012	53.31	22.87	N	30.44	2,900	820	<2.5	75	17	72
	12/14/2012	53.31	21.84	N	31.47	840	48	<0.5	14	4.5	2.5
	3/28/2013	53.31	22.24	N	31.07	790	650	<5.0	26	<5.0	15
	6/11/2013	53.31	22.71	N	30.60	1,100	860	<5.0	64	<5.0	35
	9/17/2013	53.31	23.23	N	30.08	<1,000	1,300	<10	22	<10	44
	12/6/2013	53.31	23.6	N	29.71	2,300	3,300	<10	78	199	42
	3/13/2014	53.31	22.6	N	30.71	<630	600	<6.3	7.0	21	6.8
	6/6/2014	53.31	22.97	N	30.34	<630	710	<6.3	21	<6.3	17.0
	9/23/2014	53.31	24.22	N	29.09	<630	1,100	<6.3	10	6.6	7.5
	12/23/2014	53.31	19.78	N	33.53	<50	0.95	<0.5	<0.5	<0.5	<0.5
	3/20/2015	53.31	21.75	N	31.56	56	1.8	<0.5	2.00	<0.5	8.7
	6/4/2015	53.31	22.29	N	31.02	210	35	<0.5	4.10	0.54	12
	9/11/2015	53.31	23.02	N	30.29	1,200	140	1.1	7.30	19	39
	12/29/2015	53.31	24.5	N	28.81	440	91	<0.5	0.84	0.74	17
3/23/2016	53.31	19.81	N	33.50	62	12	<0.5	<0.5	<0.5	7.4	
6/16/2016	53.31	19.84	N	33.47	120	18	0.75	0.53	<0.5	4.1	
9/21/2016	53.31	22.72	N	30.59	620	87	<0.5	5	9.90	35	
12/14/2016	53.31	21.75	N	31.56	460	23	<0.5	<0.5	4.80	4.60	
MW-5	5/10/2002	47.79	19.02	-	28.77	25,000	1,000	1200	1,100	3,060	1,800
	8/8/2002	47.79	19.80	-	27.99	18,000	1,000	660	950	1,720	1,500
	11/8/2002	47.79	20.14	-	27.65	16,000	1,300	380	930	1,550	1,200
	2/21/2003	47.79	18.70	-	29.09	12,000	390	71	770	1,100	860
	5/28/2003	47.79	18.52	-	29.27	9,100	210	31	560	790	600
	8/12/2003	47.79	19.54	-	28.25	12,000	660	75	660	1,110	1,000
	10/9/2003	47.79	20.06	-	27.73	15,000	1,000	130	1,000	1,430	1,700

Table 1
Historical Groundwater Elevation Data and Analytical Results
15101 Freedom Avenue, San Leandro, CA

Monitoring Well	Date	Casing Elevation ¹ (feet)	Depth to Groundwater (feet)	Free-Product (feet)/ Sheen (Y/N)	Groundwater Elevation (feet)	TPH-g (µg/L)	Benzene (µg/L)	Toluene (µg/L)	Ethyl-benzene (µg/L)	Total Xylenes (µg/L)	MtBE 8260B ² (µg/L)
MW-5 cont.	1/15/2004	47.79	18.42	-	29.37	9,900	450 C	16	500	431	1,100
	5/25/2004	47.79	19.30	-	28.49	9,200	380	24	490	536	720
	9/21/2004	50.53	20.15	-	30.38	10,000	980	71	560	770	1200
	12/14/2004	50.53	19.30	-	31.23	10,502	587	64	1040	1133	1015
	3/11/2005	50.53	17.20	-	33.33	8,390	407	<5.5	83	42.5	1530
	6/15/2005	50.53	18.54	-	31.99	9,350	147	18.3	435	146.2	573
	8/26/2005	50.53	19.31	-	31.22	9,500	261	<22	726	321.3	749
	11/11/2005	50.53	19.75	-	30.78	10,000	443	41.5	527	278.5	1,430
	2/9/2006	50.53	17.58	-	32.95	7,640	237	<22	187	50.2	2,050
	5/9/2006	50.53	17.54	-	32.99	8,360	111	<8.6	300	75.84	566
	8/10/2006	50.53	19.02	-	31.51	16,100	250	<22	455	187.4	1,590
	10/26/2006	50.53	19.61	-	30.92	10,100	430	<22	375	192.6	3,060
	1/25/2007	50.53	19.19	-	31.34	3,960	340	<22	323	150.1	1,740
	4/26/2007	50.53	18.89	-	31.64	4,590	187	<8.6	307	116.5	861
	7/25/2007	50.53	19.81	-	30.72	6,490	419	21.8	413	223.2	913
	10/23/2007	50.53	19.98	-	30.55	6,120	550	11	284	141.4	433
	1/22/2008	50.18	18.69	-	31.49	9,810	572	22	574	184.1	126
	4/15/2008	50.18	19.16	-	31.02	8,890	335	15.1	477	397.5	136
	7/3/2008	50.53	19.88	-	30.65	13,100	949	34.4	875	825.5	176
	10/16/2008	50.53	20.45	-	30.08	11,000	870	25	820	668	160
1/8/2009	50.53	19.72	-	30.81	12,000	490	21	690	456	76	
4/13/2009	50.53	18.81	-	31.72	9,000 ^Y	200	11	390	198	44	
8/27/2009	50.53	21.30	-	29.23	7,400	610	15	320	185	66	
12/2/2009	50.53	20.00	-	30.53	8,400 ^Y	400	12	540	296	45	

Table 1
Historical Groundwater Elevation Data and Analytical Results
15101 Freedom Avenue, San Leandro, CA

Monitoring Well	Date	Casing Elevation ¹ (feet)	Depth to Groundwater (feet)	Free-Product (feet)/ Sheen (Y/N)	Groundwater Elevation (feet)	TPH-g (µg/L)	Benzene (µg/L)	Toluene (µg/L)	Ethyl-benzene (µg/L)	Total Xylenes (µg/L)	MtBE 8260B ² (µg/L)
MW-5 cont.	3/17/2010	50.53	18.73	-	31.80	4,800	120	8.7	120	107	14
	6/4/2010	50.53	19.60	-	30.93	7,200	160	5.7	190	149.2	24
Pre-MPE	9/2/2010	50.53	19.82	-	30.71	9,200	110	12	270	318	35
	12/2/2010	50.53	20.10	-	30.43	9,100	170	6.7	350	442	23
	3/4/2011	50.53	18.00	N	32.53	2,600	18	0.62	54	18.1	3
	5/20/2011	50.53	19.18	N	31.35	4,000	91	8.5	110	106	33
	8/4/2011	50.53	NM	-	NC	3,000	23	0.95	92	43.7	5.4
	9/9/2011	50.53	19.41	N	31.12	4,200	120	2.8	140	61.1	22
	12/2/2011	50.53	18.59	N	31.94	6,900 ^x	96	12	220	104	32
	3/2/2012	50.53	19.30	N	31.23	5,400	43	1.8	110	85	7
	6/7/2012	50.53	19.45	N	31.08	3,700	32	<1.0	100	59	4.4
	9/21/2012	50.53	20.17	N	30.36	3,900	68	1.5	140	88.5	9.8
	12/14/2012	50.53	19.12	N	31.41	3,100	48	6.7	100	62.3	5.2
	3/28/2013	50.53	19.47	N	31.06	1,900	30	<1.0	59	48.4	4.5
	6/11/2013	50.53	20.03	N	30.50	2,900	22	3.9	110	131	3.0
	9/17/2013	50.53	20.54	N	29.99	4,200	55	7.9	180	229	5.2
	12/6/2013	50.53	20.86	N	29.67	3,600	35	2.1	160	241	2.5
	3/13/2014	50.53	19.91	N	30.62	2,100	23	<1.0	130	73	1.4
	6/6/2014	50.53	20.27	N	30.26	1,700	8.2	0.56	63	40.2	0.75
	9/23/2014	50.53	21.61	N	28.92	1,700	38	0.52	45	29.8	1.60
	12/23/2014	50.53	17.12	N	33.41	<50	<0.5	<0.5	<0.5	<0.5	<0.5
	3/20/2015	50.53	18.91	N	31.62	130	<0.5	<0.5	4.5	3.4	<0.5
6/4/2015	50.53	19.49	N	31.04	340	0.7	<0.5	4	3.7	<0.5	
9/11/2015	50.53	20.29	N	30.24	1,300	3.1	<0.5	13	13	<0.5	
12/29/2015	50.53	19.89	N	30.64	260	1.5	<0.5	1.1	0.89	<0.5	
3/23/2016	50.53	17.07	N	33.46	300	<0.5	<0.5	<0.5	<0.5	<0.5	
6/16/2016	50.53	17.10	N	33.43	520	0.68	<0.5	<0.5	<0.5	<0.5	
9/21/2016	50.53	19.97	N	30.56	590	0.73	<0.5	<0.5	<0.5	1.90	
	12/14/2016	50.53	19.12	N	31.41	1,200	1.4	<0.5	1.8	<0.5	0.87
MW-6	9/21/2004	45.82	17.64	-	28.18	34,000	150	130	2200	8100	0.6
	12/14/2004	45.82	15.75	-	30.07	5,161	137	7	436	1136	<5.5

Table 1
Historical Groundwater Elevation Data and Analytical Results
15101 Freedom Avenue, San Leandro, CA

Monitoring Well	Date	Casing Elevation ¹ (feet)	Depth to Groundwater (feet)	Free-Product (feet)/ Sheen (Y/N)	Groundwater Elevation (feet)	TPH-g (µg/L)	Benzene (µg/L)	Toluene (µg/L)	Ethyl-benzene (µg/L)	Total Xylenes (µg/L)	MtBE 8260B ² (µg/L)
MW-6 cont.	3/11/2005	45.82	13.80	-	32.02	6,040	125	3.22	260	722.1	4.94
	6/15/2005	45.82	14.78	-	31.04	5,590	44.3	6.60	272	382	5.85
	8/26/2005	45.82	15.91	-	29.91	6,130	99	<8.6	378	492.9	5.66
	11/11/2005	45.82	16.55	-	29.27	11,400	101	<8.6	645	834.7	4.33
	2/9/2006	45.82	13.92	-	31.90	2,790	32.3	<8.6	131	131.22	7.30
	5/9/2006	45.82	13.95	-	31.87	3,730	25	<2.0	213	207.82	5.87
	8/10/2006	45.82	15.28	-	30.54	4,800	41.9	<2.0	201	189	10.4
	10/26/2006	45.82	16.11	-	29.71	6,080	37.4	<2.0	116	183	9.78
	1/25/2007	45.82	15.76	-	30.06	3,220	25.2	<2.0	219	174	14.7
	4/26/2007	45.82	15.18	-	30.64	3,110	28	<2.0	165	138.47	14.6
	7/25/2007	45.82	16.82	-	29.00	4,960	54.1	<2.0	199	255.87	8.05
	10/23/2007	45.82	16.91	-	28.91	9,610	64.3	<2.0	188	302.6	5.81
	1/21/2008	45.82	15.36	-	30.46	3,290	33	<2.0	149	131.31	3.86
	4/15/2008	45.82	15.73	-	30.09	2,070	10.8	<2.0	51.1	67	<0.5
	7/2/2008	45.82	16.9	-	28.92	7,900	42.4	<2.0	194	296	3.58
	10/15/2008	45.82	17.21	-	28.61	18,000 ^Y	42	1.4	320	673	1.7
	1/7/2009	45.82	17.08	-	28.74	13,000	47	<3.1	210	425	<3.1
	4/13/2009	45.82	15.52	-	30.30	7,200 ^Y	26	<1.3	170	312.6	2.6
	8/26/2009	45.82	17.82	-	28.00	10,000 ^Y	25	<2.0	130	294	2.2
	12/1/2009	45.82	17.34	-	28.48	11,000 ^Y	31	6.1	220	539	<2.0
	3/16/2010	45.82	14.81	-	31.01	31,000	63	140	970	4,200	64
	6/3/2010	45.82	15.72	-	30.10	27,000	22	67	840	3,100	32
	9/1/2010	45.82	16.86	-	28.96	33,000	24	34	1,100	3,780	12
	12/2/2010	45.82	16.98	-	28.84	70,000	32	55	1,700	5,670	18
3/3/2011	45.82	14.35	Y	31.47	7,000	18	<2.5	97	237	11	
5/20/2011	45.82	14.95	Y	30.87	14,000	14	<2.5	300	823	7.2	
9/8/2011	45.82	16.14	Y	29.68	23,000	28	<2.5	360	812	3.4	
12/1/2011	45.82	16.17	16.15	29.66	FP	FP	FP	FP	FP	FP	

Table 1
Historical Groundwater Elevation Data and Analytical Results
15101 Freedom Avenue, San Leandro, CA

Monitoring Well	Date	Casing Elevation ¹ (feet)	Depth to Groundwater (feet)	Free-Product (feet)/ Sheen (Y/N)	Groundwater Elevation (feet)	TPH-g (µg/L)	Benzene (µg/L)	Toluene (µg/L)	Ethyl-benzene (µg/L)	Total Xylenes (µg/L)	MtBE 8260B ² (µg/L)
MW-6 cont.	3/2/2012	45.82	16.11	Y	29.71	14,000	23	<4.2	400	694.4	<4.2
	6/6/2012	45.82	16.31	Y	29.51	9,200	12	<1.7	210	320	<1.7
	9/20/2012*	45.82	17.36	17.32	28.49	FP	FP	FP	FP	FP	FP
	12/13/2012	45.82	15.46	Y	30.36	13,000	22	<0.71	83	62.8	5.1
	3/27/2013	45.82	16.3	Y	29.52	7,400	27	<1.3	190	221.8	<1.3
	6/10/2013	45.82	17.37	Y	28.45	12,000	20	<2.5	280	230	<2.5
	9/16/2013	45.82	18.11	18.06	27.74	FP	FP	FP	FP	FP	FP
	12/5/2013	45.82	18.75	Y	27.07	18,000	220	330	460	2,030	6.1
	3/12/2014	45.82	17	Y	28.82	8,900	42	5.4	290	760	<2.5
	6/5/2014	45.82	18.15	Y	27.67	9,600	29	<2.5	370	295	<2.5
	9/22/2014	45.82	19.33	Y	26.49	31,000	140	140	1,600	3,590	4.3
	12/22/2014	45.82	13.43	Y	32.39	2,700	20	<0.5	70	55.4	0.63
	3/19/2015	45.82	16.1	N	29.72	2,900	8.2	<0.5	48	3.6	<0.5
	6/3/2015	45.82	17.21	N	28.61	4,600	13	<0.5	53	3.4	<0.5
	9/10/2015	45.82	18.25	N	27.57	4,200	8.8	<5.0	27	<5.0	<5.0
	12/28/2015	45.82	16.64	N	29.18	4,600	27	<1.0	160	24	<1.0
	3/24/2016	45.82	14.35	N	31.47	700	3.4	<0.5	4.4	2.64	<0.5
	6/16/2016	45.82	14.38	N	31.44	2,900	9.7	<0.5	18	17	<0.5
	9/21/2016	45.82	17.57	N	28.25	2,600	8.5	<1.0	1.9	<1.0	<1.0
	12/15/2016	45.82	15.5	N	30.32	1,600	4.1	<0.5	1.2	2.1	<0.5
MW-7	9/21/2004	44.74	15.21	-	29.53	2,900	<0.5	<0.5	52	61	8.1
	12/14/2004	44.74	13.90	-	30.84	<50	1.6	<0.5	29	58	6.0
	3/11/2005	44.74	11.46	-	33.28	2,230	<2.5	<2.5	39.4	51.4	12.4
	6/15/2005	44.74	12.97	-	31.77	2,940	0.85	<2.0	50.6	31.9	13.7
	8/26/2005	44.74	14.10	-	30.64	2,310	<0.50	<2.0	55.7	29.6	4.01
	11/11/2005	44.74	14.59	-	30.15	3,030	<0.5	<2.0	66.5	42.3	9.76
	2/9/2006	44.74	NM	-	NM	NA	NA	NA	NA	NA	NA
	5/9/2006	44.74	12.02	-	32.72	1,400	<0.5	<2.0	19.8	12.4	2.30
	8/10/2006	44.74	13.72	-	31.02	604	<0.50	<2.0	6.2	4.63	1.42
	10/26/2006	44.74	14.38	-	30.36	1350	<0.50	<2.0	16.6	10.8	1.87

Table 1
Historical Groundwater Elevation Data and Analytical Results
15101 Freedom Avenue, San Leandro, CA

Monitoring Well	Date	Casing Elevation ¹ (feet)	Depth to Groundwater (feet)	Free-Product (feet)/ Sheen (Y/N)	Groundwater Elevation (feet)	TPH-g (µg/L)	Benzene (µg/L)	Toluene (µg/L)	Ethyl-benzene (µg/L)	Total Xylenes (µg/L)	MtBE 8260B ² (µg/L)
MW-7 cont.	1/25/2007	44.74	13.93	-	30.81	340	<0.5	<2.0	6.84	2.44	1.63
	4/26/2007	44.74	14.44	-	30.30	552	<0.5	<2.0	11.4	6.11	4.12
	7/25/2007	44.74	14.79	-	29.95	1,230	<0.5	<2.0	27	19.24	3.2
	10/23/2007	44.74	14.88	-	29.86	1,730	0.67	<2.0	20.7	17.31	8.44
	1/21/2008	44.74	13.34	-	31.40	610	1.15	<2.0	8.4	4.34	17.2
	4/15/2008	44.74	13.91	-	30.83	1,460	<0.5	<2.0	15.9	19.7	17.3
	7/2/2008	44.74	14.87	-	29.87	1,450	<0.5	<2.0	11	6.8	22.1
	10/15/2008	44.74	15.68	-	29.06	1,900 ^Y	0.56	1.2	27	39.5	55
	1/7/2009	44.74	14.72	-	30.02	2,700	1.2	2.9	11	25	39
	4/13/2009	44.74	13.54	-	31.20	2,300 ^Y	<0.5	<0.5	15	6.3	63
	8/26/2009	44.74	15.84	-	28.90	2,700 ^Y	<0.5	<0.5	48	53	140
	12/1/2009	44.74	15.03	-	29.71	1,800 ^Y	<0.5	<0.5	22	15	120
	3/16/2010	44.74	12.56	-	32.18	1,100	<0.5	<0.5	3.2	1.4	65
	6/3/2010	44.74	13.80	-	30.94	740	<0.5	<0.5	1.8	0.62	28
	9/1/2010	44.74	14.84	-	29.90	1,200	<0.5	<0.5	10	3.2	29
	12/2/2010	44.74	14.74	-	30.00	1,400	<0.5	<0.5	8	0.74	21
	3/3/2011	44.74	13.31	N	31.43	1,000	<0.5	<0.5	1.8	<0.5	16
	5/19/2011	44.74	13.43	N	31.31	810	<0.5	<0.5	2.2	0.79	7.8
	9/8/2011	44.74	14.38	N	30.36	1,000	<0.5	<0.5	8.3	2.9	5.4
	12/1/2011	44.74	13.57	N	31.17	1,500 ^x	<0.33	<0.19	12	5.7	13
	3/2/2012	44.74	14.16	N	30.58	1,000	<0.5	<0.5	4	1.1	5.1
	6/6/2012	44.74	14.00	N	30.74	780	<0.5	<0.5	2.9	1.0	2.6
	9/20/2012	44.74	15.26	N	29.48	1,200	<0.5	<0.5	4.3	0.92	2.7
	12/13/2012	44.74	13.34	N	31.40	1,100	<0.5	<0.5	0.99	<0.5	3.4
	3/27/2013	44.74	14.30	N	30.44	680	<0.5	<0.5	1.8	<0.5	4.2
	6/10/2013	44.74	15.06	N	29.68	890	<0.5	<0.5	2.6	<0.5	2.3
9/16/2013	44.74	15.78	N	28.96	1,400	<0.5	<0.5	7.9	2.7	4.1	
12/5/2013	44.74	16.21	N	28.53	1,800	<0.5	<0.5	8	3.1	5.7	

Table 1
Historical Groundwater Elevation Data and Analytical Results
15101 Freedom Avenue, San Leandro, CA

Monitoring Well	Date	Casing Elevation ¹ (feet)	Depth to Groundwater (feet)	Free-Product (feet)/ Sheen (Y/N)	Groundwater Elevation (feet)	TPH-g (µg/L)	Benzene (µg/L)	Toluene (µg/L)	Ethyl-benzene (µg/L)	Total Xylenes (µg/L)	MtBE 8260B ² (µg/L)
MW-7 cont.	3/12/2014	44.74	14.56	N	30.18	920	<0.5	<0.5	3.7	1.5	4.6
	6/5/2014	44.74	15.18	N	29.56	1,600	<0.5	<0.5	11	3.0	5.7
	9/22/2014	44.74	16.63	N	28.11	1,900	<0.5	<0.5	9.6	3.5	5.3
	12/22/2014	44.74	11.37	N	33.37	320	<0.5	<0.5	2.2	2.3	1.7
	3/19/2015	44.74	13.82	N	30.92	1,400	<0.5	<0.5	4.6	2.0	4.7
	6/3/2015	44.74	14.53	N	30.21	2,000	<0.5	<0.5	12	5.4	4.4
	9/10/2015	44.74	15.62	N	29.12	2,200	<1.7	<1.7	9.9	1.7	4.0
	12/28/2015	44.74	14.75	N	29.99	2,500	<0.5	<0.5	5.2	4.0	3.1
	3/24/2016	44.74	11.46	N	33.28	1,800	<0.5	<0.5	1.7	<0.5	3.1
	6/16/2016	44.74	11.49	N	33.25	2,400	<0.5	<0.5	2.3	<0.5	1.4
	9/21/2016	44.74	16.32	N	28.42	2,000	1.9	0.63	11	12.1	<0.5
	12/15/2016	44.74	13.78	N	30.96	1,800	<0.5	<0.5	3.4	1.9	1.4
	MW-8	9/21/2004	41.14	12.98	-	28.16	<50	<0.5	<0.5	<0.5	<0.5
12/14/2004		41.14	11.22	-	29.92	<50	<0.5	<0.5	<0.5	<1.0	<0.5
3/11/2005		41.14	NM	-	NM	NA	NA	NA	NA	NA	NA
6/15/2005		41.14	10.46	-	30.68	<200	0.53	<2.0	<0.5	<1.0	<0.5
8/26/2005		41.14	11.53	-	29.61	<50	<0.50	<2.0	<0.50	<1.0	<0.50
11/11/2005		41.14	11.92	-	29.22	<50	<0.5	<2.0	1.36	1.8	<0.5
2/9/2006		41.14	9.74	-	31.40	<50	<0.50	<2.0	<0.50	<1.0	<0.50
5/9/2006		41.14	9.90	-	31.24	<50	<0.50	<2.0	<0.50	<1.0	<0.50
8/10/2006		41.14	10.9	-	30.24	<50	<0.50	<2.0	<0.50	<1.0	<0.50
10/26/2006		41.14	11.68	-	29.46	<50	<0.50	<2.0	3.37	<1.0	<0.50
1/25/2007		41.14	11.44	-	29.70	<50	<0.5	<2.0	<0.5	<2.0	<0.5
4/26/2007		41.14	10.81	-	30.33	<50	<0.5	<2.0	4.29	<2.0	<0.5
7/25/2007		41.14	12.31	-	28.83	<50	<0.5	<2.0	4.39	<2.0	<0.5
10/23/2007		41.14	12.37	-	28.77	<50	<0.5	<2.0	4.31	<2.0	<0.5
1/21/2008		41.14	11.02	-	30.12	<50	<0.5	<2.0	<0.5	<2.0	<0.5
4/15/2008		41.14	11.44	-	29.70	<50	<0.5	<2.0	<0.5	<2.0	<0.5
7/2/2008	41.14	12.39	-	28.75	94.8	<0.5	<2.0	1.0	<2.0	<0.5	
10/15/2008	41.14	13.42	-	27.72	<50	<0.5	<0.5	<0.5	<0.5	<0.5	

Table 1
Historical Groundwater Elevation Data and Analytical Results
15101 Freedom Avenue, San Leandro, CA

Monitoring Well	Date	Casing Elevation ¹ (feet)	Depth to Groundwater (feet)	Free-Product (feet)/ Sheen (Y/N)	Groundwater Elevation (feet)	TPH-g (µg/L)	Benzene (µg/L)	Toluene (µg/L)	Ethyl-benzene (µg/L)	Total Xylenes (µg/L)	MtBE 8260B ² (µg/L)
MW-8 cont.	1/7/2009	41.14	12.50	-	28.64	<50	<0.5	<0.5	<0.5	0.6	<0.5
	4/13/2009	41.14	11.23	-	29.91	<50	<0.5	<0.5	<0.5	<0.5	<0.5
	8/27/2009	41.14	13.24	-	27.90	<50	<0.5	<0.5	<0.5	<0.5	<0.5
Well Decommissioned 11/13/2009											
MW-9	9/21/2004	40.26	12.18	-	28.08	<50	<0.5	<0.5	<0.5	<0.5	<0.5
	12/14/2004	40.26	10.91	-	29.35	<50	<0.5	<0.5	<0.5	<1.0	<0.5
	3/11/2005	40.26	10.52	-	29.74	<200	<0.5	<0.5	<0.5	<1.0	<0.5
	6/15/2005	40.26	14.73	-	25.53	<200	<0.5	<2.0	<0.5	<1.0	<0.5
	8/26/2005	40.26	10.59	-	29.67	<50	<0.50	<2.0	<0.50	<1.0	<0.50
	11/11/2005	40.26	11.25	-	29.01	<50	<0.5	<2.0	<0.5	<1.0	<0.5
	2/9/2006	40.26	10.05	-	30.21	<50	<0.50	<2.0	<0.50	<1.0	<0.50
	5/9/2006	40.26	9.06	-	31.20	<50	<0.50	<2.0	<0.50	<1.0	<0.50
	8/10/2006	40.26	10.01	-	30.25	<50	<0.50	<2.0	<0.50	<1.0	<0.50
	10/26/2006	40.26	10.81	-	29.45	<50	<0.50	<2.0	<0.50	<1.0	<0.50
	1/25/2007	40.26	10.67	-	29.59	<50	<0.5	<2.0	<0.5	<2.0	<0.5
	4/26/2007	40.26	10.05	-	30.21	<50	<0.5	<2.0	<0.5	<2.0	<0.5
	7/25/2007	40.26	11.44	-	28.82	<50	<0.5	<2.0	<0.5	<2.0	<0.5
	10/23/2007	40.26	11.59	-	28.67	<50	<0.5	<2.0	<0.5	<2.0	<0.5
	1/21/2008	40.26	10.37	-	29.89	<50	<0.5	<2.0	<0.5	<2.0	<0.5
	4/15/2008	40.26	10.56	-	29.70	<50	<0.5	<2.0	<0.5	<2.0	<0.5
	7/2/2008	40.26	11.95	-	28.31	161	<0.5	<2.0	2.15	<2.0	<0.5
	10/15/2008	40.26	12.64	-	27.62	<50	<0.5	<0.5	<0.5	<0.5	<0.5
	1/7/2009	40.26	11.75	-	28.51	<50	<0.5	<0.5	<0.5	<0.5	<0.5
4/13/2009	40.26	10.89	-	29.37	<50	<0.5	<0.5	<0.5	<0.5	<0.5	
8/26/2009	40.26	12.50	-	27.76	<50	<0.5	<0.5	<0.5	<0.5	<0.5	
Well Decommissioned 11/13/2009											

Table 1
Historical Groundwater Elevation Data and Analytical Results
15101 Freedom Avenue, San Leandro, CA

Monitoring Well	Date	Casing Elevation ¹ (feet)	Depth to Groundwater (feet)	Free-Product (feet)/ Sheen (Y/N)	Groundwater Elevation (feet)	TPH-g (µg/L)	Benzene (µg/L)	Toluene (µg/L)	Ethyl-benzene (µg/L)	Total Xylenes (µg/L)	MtBE 8260B ² (µg/L)
MW-10	9/22/2014	44.66	17.84	N	26.82	23,000	<10	<10	1200	2,610	<10
	12/22/2014	44.66	12.33	N	32.33	6,000	<2.5	<2.5	390	802	<2.5
	3/19/2015	44.66	15.01	N	29.65	3,500	<1.0	<1.0	130	279	<1.0
	6/3/2015	44.66	15.81	N	28.85	24,000	<5.0	<5.0	870	1,358	<5.0
	9/10/2015	44.66	17.03	N	27.63	28,000	<10	<10	1,200	2,173	<10
	12/28/2015	44.66	15.18	N	29.48	22,000	<10	<10	930	1,737	<10
MW-10R Post MPE	3/24/2016	44.66	13.1	N	31.56	22,000	<5	<5	620	1,038	<5
	6/15/2016	45.13	13.6	N	31.53	28,000	<10	<10	720	1,454	<10
	8/8/2016	45.13	NA	N	NA	8,100	<4.2	<4.2	150	267.1	<4.2
	9/21/2016	45.13	16.84	N	28.29	10,000	9.6	<2.0	340	432	<2.0
	12/15/2016	45.13	14.92	N	30.21	5,200	<2.0	<2.0	170	206.5	<2.0
MW-11	9/22/2014	42.45	15.52	N	26.93	2,100	<0.5	<0.5	2.7	4.5	<0.5
	12/22/2014	42.45	10.08	N	32.37	310	<0.5	<0.5	1.8	2.7	<0.5
	3/19/2015	42.45	12.77	N	29.68	870	<0.5	<0.5	1.4	2.2	<0.5
	6/3/2015	42.45	13.5	N	28.95	330	<0.5	<0.5	2.0	3.1	<0.5
	9/10/2015	42.45	14.79	N	27.66	78	<0.5	<0.5	<0.5	<0.5	<0.5
	12/28/2015	42.45	13.07	N	29.38	170	<0.5	<0.5	3.0	4.2	<0.5
	3/23/2016	42.45	10.48	N	31.97	110	<0.5	<0.5	<0.5	<0.5	<0.5
	6/16/2016	42.45	10.51	N	31.94	100	<0.5	<0.5	<0.5	<0.5	<0.5
	9/21/2016	42.45	14.05	N	28.40	75	<0.5	<0.5	1.5	1.7	<0.5
12/15/2016	42.45	12.3	N	30.15	65	<0.5	<0.5	1.4	1.7	<0.5	
Extraction Wells											
EX-1	12/2/2009	47.36	17.02	-	30.34	2,900	120	4	64	410	25
	3/16/2010	47.36	19.08	-	28.28	2,200	150	18	94	326	210
	6/3/2010	47.36	17.02	-	30.34	3,600	180	6.3	150	428	83
	9/1/2010	47.36	16.88	-	30.48	550	6.5	0.5	6.9	31.7	38
	12/2/2010	47.36	19.84	-	27.52	<200	3.1	<2.0	<2.0	<2.0	210

Table 1
Historical Groundwater Elevation Data and Analytical Results
15101 Freedom Avenue, San Leandro, CA

Monitoring Well	Date	Casing Elevation ¹ (feet)	Depth to Groundwater (feet)	Free-Product (feet)/ Sheen (Y/N)	Groundwater Elevation (feet)	TPH-g (µg/L)	Benzene (µg/L)	Toluene (µg/L)	Ethyl-benzene (µg/L)	Total Xylenes (µg/L)	MtBE 8260B ² (µg/L)
EX-1 cont.	3/3/2011	47.36	14.96	N	32.4	530	51	0.94	15	31.3	110
	5/19/2011	47.36	16.12	N	31.24	370	42	<0.71	7.6	17.2	110
	9/8/2011	47.36	16.47	N	30.89	110	5	<0.5	2.2	6.4	12
	12/1/2011	47.36	16.1	N	31.26	780 ^x	91	3	29	85	150
	3/2/2012	47.36	16.35	N	31.01	140	6	<0.5	3.5	8	14
	6/6/2012	47.36	24.76	N	22.6	250	22	<0.5	4.7	20	71
	9/20/2012	47.36	17.26	N	30.1	95	24	<0.5	<0.5	2.61	36
	12/13/2012	47.36	16.55	N	30.81	1,000	73	2.3	47	110	48
	3/27/2013	47.36	16.15	N	31.21	69	4.1	<0.5	3.3	10	1.8
	6/10/2013	47.36	24.25	N	23.11	340	37	<0.5	5.9	15.1	62
	9/16/2013	47.36	22.54	N	24.82	97	14	<0.5	<0.5	<0.5	65
	12/5/2013	47.36	22.53	N	24.83	390	42	2.5	9.8	32.6	76
	3/12/2014	47.36	21.15	N	26.21	250	12	<0.5	4.7	17.2	40
	6/5/2014	47.36	21.31	N	26.05	1,700	70	11	92	208	40
	9/22/2014	47.36	21.15	N	26.21	1,500	23	1.3	73	161	51
	12/22/2014	47.36	19.74	N	27.62	530	8.6	<0.5	3.2	29.3	11
	3/19/2015	47.36	15.59	N	31.77	<50	1.2	<0.5	<0.5	1.0	<0.5
	6/3/2015	47.36	22.89	N	24.47	770	31	<0.5	8.2	17.1	22
	9/10/2015	47.36	22.57	N	24.79	<50	0.66	<0.5	<0.5	1.53	<0.5
	12/28/2015	47.36	22.7	N	24.66	400	27	<0.5	4.6	10.9	21
3/24/2016	47.36	13.45	N	33.91	57	3.9	<0.5	<0.5	<0.5	3.5	
6/15/2016	47.36	13.83	N	33.53	140	9.1	<0.5	<0.5	<0.5	<0.5	
9/21/2016	47.36	16.75	N	30.61	260	1.2	<0.5	5.3	1.7	<0.5	
12/14/2016	47.36	15.9	N	31.46	<50	<0.5	<0.5	<0.5	<0.5	<0.5	2.1
EX-2	12/2/2009	45.96	17.56	-	28.4	7,100 ^Y	9.3	3.2	440	770	<3.1
	3/16/2010	45.96	19.65	-	26.31	13,000	600	360	770	2,250	15
	6/3/2010	45.96	17.10	-	28.86	16,000	590	400	700	2,500	9.5
	9/1/2010	45.96	16.99	-	28.97	6,100	230	74	200	890	11
	12/2/2010	45.96	20.87	-	25.09	14,000	510	270	640	2,170	15

Table 1
Historical Groundwater Elevation Data and Analytical Results
15101 Freedom Avenue, San Leandro, CA

Monitoring Well	Date	Casing Elevation ¹ (feet)	Depth to Groundwater (feet)	Free-Product (feet)/ Sheen (Y/N)	Groundwater Elevation (feet)	TPH-g (µg/L)	Benzene (µg/L)	Toluene (µg/L)	Ethyl-benzene (µg/L)	Total Xylenes (µg/L)	MtBE 8260B ² (µg/L)
EX-2 cont.	3/3/2011	45.96	14.61	N	31.35	8,600	340	52	460	1,350	13
	5/19/2011	45.96	15.08	N	30.88	7,500	260	65	390	1,080	11
	9/8/2011	45.96	16.34	N	29.62	3,400	190	28	160	451	5.4
	12/1/2011	45.96	22.60	N	23.36	9,900 ^x	630	200	690	1,760	<3.3
	3/2/2012	45.96	16.48	N	29.48	5,000	220	25	200	600	7.1
	6/6/2012	45.96	18.90	N	27.06	6,900	290	97	310	790	5.2
	9/20/2012	45.96	17.49	N	28.47	1,800	170	14	62	204	5.0
	12/13/2012	45.96	15.96	N	30	7,300	490	180	610	1,290	5.2
	3/27/2013	45.96	16.59	N	29.37	2,200	130	9.6	100	288	4.3
	6/10/2013	45.96	23.11	N	22.85	2,600	190	20	100	248	6.8
	9/20/2013	45.96	23.11	N	22.85	3,900	210	37	170	450	6.3
	12/5/2013	45.96	23.28	N	22.68	3,700	160	46	110	394	7.2
	3/12/2014	45.96	22.04	N	23.92	3,700	100	9.8	220	498	5.7
	6/5/2014	45.96	23.41	N	22.55	4,400	120	37	280	590	5.4
	9/22/2014	45.96	23.20	N	22.76	2,200	63	8.8	88	240	7.1
	12/22/2014	45.96	20.22	N	25.74	1,600	42	4.2	94	148	6.0
	3/19/2015	45.96	16.46	N	29.50	890	42	<0.5	54	10.5	<0.5
	6/3/2015	45.96	21.06	N	24.90	4,700	100	8.7	120	311	1.9
	9/10/2015	45.96	21.15	N	24.81	670	8.1	<1.0	13	27.4	<1.0
	12/28/2015	45.96	20.75	N	25.21	3,500	46	6	120	266	4.5
3/24/2016	45.96	13.97	N	31.99	1,500	22	0.86	42	75	1.7	
6/15/2016	45.96	14.00	-	31.96	NA	NA	NA	NA	NA	NA	
MPE Wells											
MPE-1	12/1/2009	51.96	21.41	-	30.55	NA	NA	NA	NA	NA	NA
	3/16/2010	51.96	20.22	-	31.74	NA	NA	NA	NA	NA	NA
	6/3/2010	51.96	21.18	-	30.78	NA	NA	NA	NA	NA	NA
	9/1/2010	51.96	21.25	-	30.71	NA	NA	NA	NA	NA	NA
	12/2/2010	51.96	21.64	-	30.32	NA	NA	NA	NA	NA	NA

Table 1
Historical Groundwater Elevation Data and Analytical Results
15101 Freedom Avenue, San Leandro, CA

Monitoring Well	Date	Casing Elevation ¹ (feet)	Depth to Groundwater (feet)	Free-Product (feet)/ Sheen (Y/N)	Groundwater Elevation (feet)	TPH-g (µg/L)	Benzene (µg/L)	Toluene (µg/L)	Ethyl-benzene (µg/L)	Total Xylenes (µg/L)	MtBE 8260B ² (µg/L)
MPE-1 cont.	3/3/2011	51.96	19.33	-	32.63	NA	NA	NA	NA	NA	NA
	5/19/2011	51.96	20.6	-	31.36	NA	NA	NA	NA	NA	NA
Pre-MPE	8/4/2011	51.96	NM	-	NC	49,000	210	100	840	7,070	45
	9/8/2011	51.96	20.83	-	31.13	NA	NA	NA	NA	NA	NA
Post-MPE	9/26/2011	51.96	20.94	Y	31.02	62,000	6,300	3,700	1,800	9,400	1,200
	12/2/2011	51.96	20.14	Y	31.82	56,000	9,000	7,700	2,200	10,800	2,600
	3/2/2012	51.96	20.73	Y	31.23	97,000	11,000	11,000	2,600	12,600	2,700
	6/6/2012	51.96	20.96	Y	31.00	78,000	4,500	4,900	2,300	10,700	750
	9/20/2012	51.96	21.58	Y	30.38	89,000	8,600	9,200	3,400	14,800	1,900
	12/14/2012	51.96	20.57	Y	31.39	98,000	7,400	9,600	2,900	13,300	1,300
	3/27/2013	51.96	20.91	Y	31.05	61,000	6,600	4,500	2,200	9,400	1,500
	6/10/2013	51.96	21.47	Y	30.49	42,000	1,900	980	630	4,400	670
	9/17/2013	51.96	21.98	Y	29.98	45,000	2,400	1,400	1,200	8,000	150
	12/6/2013	51.96	22.41	Y	29.55	27,000	1,600	220	990	5,000	110
	3/13/2014	51.96	21.33	Y	30.63	67,000	1,800	3,500	1,800	10,100	170
	6/5/2014	51.96	21.89	21.8	30.13	FP	FP	FP	FP	FP	FP
	9/23/2014	51.96	23.12	Y	28.84	12,000	380	31	100	1,630	39
	12/23/2014	51.96	18.3	Y	33.66	3,100	23	24	23	220	<1.0
	3/20/2015	51.96	20.14	Y	31.82	9,700	58	43	77	1,000	<2.5
	6/4/2015	51.96	21.00	Y	30.96	14,000	110	49	66	620	10
	9/11/2015	51.96	21.77	Y	30.19	9,600	590	150	83	590	50
	12/29/2015	51.96	21.13	Y	30.83	3,100	24	11	8.2	237	0.88
	3/24/2016	51.96	18.22	N	33.74	98	<0.5	<0.5	<0.5	0.79	<0.5
	6/16/2016	51.96	18.45	Y	33.51	310	8.6	<0.5	1.2	16.10	0.68
	9/21/2016	51.96	21.31	N	30.65	1,200	35	<0.5	3.2	6.10	1.50
	12/14/2016	51.96	20.32	N	31.64	<50	0.68	<0.5	<0.5	0.82	<0.5
MPE-2	12/1/2009	53.72	22.87	-	30.85	NA	NA	NA	NA	NA	NA
	3/16/2010	53.72	21.7	-	32.02	NA	NA	NA	NA	NA	NA
	6/3/2010	53.72	22.35	-	31.37	NA	NA	NA	NA	NA	NA
	9/1/2010	53.72	23.7	-	30.02	NA	NA	NA	NA	NA	NA
	12/2/2010	53.72	22.7	-	31.02	NA	NA	NA	NA	NA	NA

Table 1
Historical Groundwater Elevation Data and Analytical Results
15101 Freedom Avenue, San Leandro, CA

Monitoring Well	Date	Casing Elevation ¹ (feet)	Depth to Groundwater (feet)	Free-Product (feet)/ Sheen (Y/N)	Groundwater Elevation (feet)	TPH-g (µg/L)	Benzene (µg/L)	Toluene (µg/L)	Ethyl-benzene (µg/L)	Total Xylenes (µg/L)	MtBE 8260B ² (µg/L)
MPE-2 cont.	3/3/2011	53.72	21.25	-	32.47	NA	NA	NA	NA	NA	NA
	5/19/2011	53.72	22.19	-	31.53	NA	NA	NA	NA	NA	NA
Pre-MPE	8/4/2011	53.72	NM	-	NC	46,000	2,100	80	1,900	5,300	75
	9/8/2011	53.72	22.31	-	31.41	NA	NA	NA	NA	NA	NA
Post-MPE	9/26/2011	53.72	22.38	N	31.34	37,000	1,800	33	1,700	2,760	<17
	12/2/2011	53.72	21.44	N	32.28	26,000	1,600	43	1,800	3,370	<17
	3/2/2012	53.72	22.24	N	31.48	36,000	1,100	19	1,700	2,970	<17
	6/7/2012	53.72	22.35	N	31.37	33,000	1,800	27	1,600	2,700	29
	9/21/2012	53.72	23.03	N	30.69	31,000	1,700	13	1,900	2,747	14
	12/14/2012	53.72	22.17	N	31.55	31,000	1,700	20	1,800	2,490	16
	3/28/2013	53.72	22.53	N	31.19	20,000	2,200	<20	1,300	960	<20
	6/11/2013	53.72	22.9	N	30.82	26,000	920	<13	1,500	1,352	<13
	9/17/2013	53.72	23.29	N	30.43	23,000	680	15	1,400	1,059	<13
	12/5/2013	53.72	23.73	23.61	30.07	FP	FP	FP	FP	FP	FP
	3/12/2014	53.72	22.89	22.85	30.86	FP	FP	FP	FP	FP	FP
	6/5/2014	53.72	22.96	22.94	30.77	FP	FP	FP	FP	FP	FP
	9/23/2014	53.72	24.05	Y	29.67	22,000	550	340	760	2,760	<6.3
	12/23/2014	53.72	20.65	N	33.07	12,000	430	77	420	1,670	4.6
	3/20/2015	53.72	22.16	Y	31.56	14,000	670	21	630	1,150	6.9
	6/4/2015	53.72	22.6	Y	31.12	27,000	730	6.5	930	1,343	6.9
	9/11/2015	53.72	23.15	Y	30.57	21,000	1,000	<7.1	1,200	760	9.3
	12/29/2015	53.72	22.86	Y	30.86	16,000	220	10	210	990	<6.3
	3/24/2016	53.72	20.55	Y	33.17	9,500	960	<6.3	180	370	11
	6/16/2016	53.72	20.58	Y	33.14	13,000	570	<5.0	350	351	7.0
	9/21/2016	53.72	22.96	N	30.76	12,000	630	<6.3	300	190	<6.3
	12/14/2016	53.72	22.22	N	31.50	7,100	490	<3.1	230	140	6.0
2nd WBZ											
MW-1D	1/3/2008	54.42		-	-	<50	<0.50	<2.0	<0.50	<2.0	<0.50
	1/22/2008	54.42	22.85	-	31.57	<50	<0.50	<2.0	<0.50	<2.0	<0.50
	4/16/2008	54.42	23.10	-	31.32	<50	<0.5	<2.0	<0.5	<2.0	<0.5
	7/3/2008	54.42	23.44	-	30.98	75.9	<0.5	<2.0	0.54	<2.0	<0.5
	10/15/2008	54.42	23.82	-	30.60	120	1.6	<0.5	2.8	3.6	<0.5

Table 1
Historical Groundwater Elevation Data and Analytical Results
15101 Freedom Avenue, San Leandro, CA

Monitoring Well	Date	Casing Elevation ¹ (feet)	Depth to Groundwater (feet)	Free-Product (feet)/ Sheen (Y/N)	Groundwater Elevation (feet)	TPH-g (µg/L)	Benzene (µg/L)	Toluene (µg/L)	Ethyl-benzene (µg/L)	Total Xylenes (µg/L)	MtBE 8260B ² (µg/L)
MW-1D cont.	1/8/2009	54.42	23.44	-	30.98	<50	<0.5	<0.5	<0.5	<0.5	<0.5
	4/14/2009	54.42	23.06	-	31.36	<50	<0.5	<0.5	<0.5	<0.5	<0.5
	8/26/2009	54.42	23.73	-	30.69	<50	<0.5	<0.5	<0.5	<0.5	<0.5
	12/1/2009	54.42	23.59	-	30.83	330 ^Y	<0.5	<0.5	1.3	2.2	<0.5
	3/16/2010	54.42	22.60	-	31.82	<50	<0.5	<0.5	<0.5	<0.5	<0.5
	6/4/2010	54.42	23.10	-	31.32	<50	<0.5	<0.5	<0.5	<0.5	<0.5
	9/1/2010	54.42	23.51	-	30.91	<50	<0.5	<0.5	0.52	1.8	<0.5
	12/3/2010	54.42	23.41	-	31.01	61	<0.5	<0.5	1.0	3.73	<0.5
	3/3/2011	54.42	22.27	N	32.15	<50	<0.5	<0.5	<0.5	<0.5	<0.5
	5/19/2011	54.42	22.89	N	31.53	<50	<0.5	<0.5	<0.5	<0.5	<0.5
	9/8/2011	54.42	23.08	N	31.34	220	<0.5	<0.5	0.6	1.4	<0.5
	12/1/2011	54.42	22.26	N	32.16	<22	<0.33	<0.19	<0.15	<0.20	<0.38
	3/2/2012	54.42	23.01	N	31.41	<50	<0.5	<0.5	<0.5	<0.5	<0.5
	6/6/2012	54.42	23.18	N	31.24	<50	<0.5	<0.5	<0.5	<0.5	<0.5
	9/20/2012	54.42	23.76	N	30.66	<50	<0.5	<0.5	<0.5	<0.5	<0.5
	12/13/2012	54.42	23.04	N	31.38	<50	<0.5	<0.5	<0.5	<0.5	<0.5
	3/27/2013	54.42	23.34	N	31.08	<50	<0.5	<0.5	<0.5	<0.5	<0.5
	6/10/2013	54.42	23.69	N	30.73	110	<0.5	<0.5	0.55	<0.5	<0.5
	9/16/2013	54.42	24.02	N	30.40	<50	<0.5	<0.5	<0.5	<0.5	<0.5
	12/5/2013	54.42	24.31	N	30.11	<50	<0.5	<0.5	<0.5	1.3	<0.5
	3/12/2014	54.42	23.68	N	30.74	<50	<0.5	<0.5	<0.5	<0.5	<0.5
	6/5/2014	54.42	23.68	N	30.74	<50	<0.5	<0.5	<0.5	<0.5	<0.5
	9/22/2014	54.42	24.65	N	29.77	<50	<0.5	<0.5	<0.5	0.88	<0.5
	12/23/2014	54.42	21.84	N	32.58	<50	<0.5	<0.5	<0.5	<0.5	<0.5
	3/19/2015	54.42	23.04	N	31.38	<50	<0.5	<0.5	<0.5	<0.5	<0.5
	6/3/2015	54.42	23.43	N	30.99	<50	<0.5	<0.5	<0.5	<0.5	<0.5
9/10/2015	54.42	23.91	N	30.51	<50	<0.5	<0.5	<0.5	<0.5	<0.5	

Table 1
Historical Groundwater Elevation Data and Analytical Results
15101 Freedom Avenue, San Leandro, CA

Monitoring Well	Date	Casing Elevation ¹ (feet)	Depth to Groundwater (feet)	Free-Product (feet)/ Sheen (Y/N)	Groundwater Elevation (feet)	TPH-g (µg/L)	Benzene (µg/L)	Toluene (µg/L)	Ethyl-benzene (µg/L)	Total Xylenes (µg/L)	MtBE 8260B ² (µg/L)
MW-3D	1/3/2008	54.10		-	-	<50	<0.50	<2.0	<0.50	<2.0	87.6
	1/22/2008	54.10	22.31	-	31.79	<50	<0.50	<2.0	<0.50	<2.0	88.3
	4/16/2008	54.10	22.64	-	31.46	<50	<0.5	<2.0	<0.5	<2.0	71.1
	7/3/2008	54.10	23.17	-	30.93	<50	<0.5	<2.0	<0.5	<2.0	67.4
	10/16/2008	54.10	23.62	-	30.48	<50	<0.5	<0.5	<0.5	<0.5	37
	1/8/2009	54.10	23.07	-	31.03	<50	<0.5	<0.5	<0.5	<0.5	29
	4/14/2009	54.10	22.36	-	31.74	<50	<0.5	<0.5	<0.5	<0.5	44
	8/26/2009	54.10	23.41	-	30.69	<50	<0.5	<0.5	<0.5	<0.5	20
	12/1/2009	54.10	23.27	-	30.83	110 Y	<0.5	<0.5	<0.5	0.52	24
	3/16/2010	54.10	22.10	-	32.00	<50	<0.5	<0.5	<0.5	<0.5	7.1
	6/4/2010	54.10	22.70	-	31.40	<50	<0.5	<0.5	<0.5	<0.5	17
	9/1/2010	54.10	23.09	-	31.01	78	<0.5	<0.5	1.1	4.71	24
	12/3/2010	54.10	22.90	-	31.20	<50	<0.5	<0.5	0.56	1.4	13
	3/3/2011	54.10	21.66	N	32.44	<50	1.3	<0.5	<0.5	0.59	14
	5/19/2011	54.10	22.61	N	31.49	<50	<0.5	<0.5	<0.5	<0.5	5.2
	9/8/2011	54.10	22.68	N	31.42	69	<0.5	<0.5	<0.5	0.62	4.8
	12/1/2011	54.10	22.86	N	31.24	<22	<0.33	<0.19	<0.15	<0.20	10
	3/2/2012	54.10	22.60	N	31.50	<50	<0.5	<0.5	<0.5	<0.5	4.2
	6/6/2012	54.10	22.77	N	31.33	<50	<0.5	<0.5	<0.5	<0.5	4.8
	9/20/2012	54.10	23.42	N	30.68	<50	<0.5	<0.5	<0.5	<0.5	5.1
	12/13/2012	54.10	22.57	N	31.53	<50	<0.5	<0.5	<0.5	<0.5	4.4
	3/27/2013	54.10	22.87	N	31.23	<50	<0.5	<0.5	<0.5	<0.5	4.4
	6/10/2013	54.10	23.27	N	30.83	<50	<0.5	<0.5	<0.5	<0.5	3.5
9/16/2013	54.10	23.65	N	30.45	<50	<0.5	<0.5	<0.5	<0.5	2.1	
12/5/2013	54.10	23.97	N	30.13	<50	<0.5	<0.5	<0.5	0.53	1.6	
3/13/2014	54.10	23.22	N	30.88	130	<0.5	2.9	2.5	16.6	0.97	
6/5/2014	54.10	23.33	N	30.77	<50	<0.5	<0.5	<0.5	0.77	1.5	
9/22/2014	54.10	24.40	N	29.70	<50	<0.5	<0.5	<0.5	<0.5	0.96	
12/23/2014	54.10	21.09	N	33.01	<50	<0.5	<0.5	<0.5	<0.5	1	

Table 1
Historical Groundwater Elevation Data and Analytical Results
15101 Freedom Avenue, San Leandro, CA

Monitoring Well	Date	Casing Elevation ¹ (feet)	Depth to Groundwater (feet)	Free-Product (feet)/ Sheen (Y/N)	Groundwater Elevation (feet)	TPH-g (µg/L)	Benzene (µg/L)	Toluene (µg/L)	Ethyl-benzene (µg/L)	Total Xylenes (µg/L)	MtBE 8260B ² (µg/L)
MW-3D cont.	3/19/2015	54.10	22.50	N	31.60	<50	<0.5	<0.5	<0.5	<0.5	1.6
	6/3/2015	54.10	22.85	N	31.25	<50	<0.5	<0.5	<0.5	<0.5	1.6
	9/10/2015	54.10	23.53	N	30.57	<50	<0.5	<0.5	<0.5	<0.5	1.4
MW-4D	1/4/2008	53.12		-	-	<50	<0.50	<2.0	<0.50	<2.0	<0.50
	1/22/2008	53.12	21.11	-	32.01	91.5	18.7	<2.0	7.08	11.42	219
	4/15/2008	53.12	21.67	-	31.45	<50	<0.5	<2.0	<0.5	<2.0	27
	7/3/2008	53.12	22.39	-	30.73	<50	<0.5	<2.0	<0.5	<2.0	6.27
	10/16/2008	53.12	22.98	-	30.14	<50	<0.5	<0.5	<0.5	<0.5	1.9
	1/8/2009	53.12	22.25	-	30.87	<50	<0.5	<0.5	<0.5	<0.5	2
	4/14/2009	53.12	21.34	-	31.78	<50	<0.5	<0.5	<0.5	<0.5	2.2
	8/27/2009	53.12	22.79	-	30.33	<50	<0.5	<0.5	<0.5	<0.5	2.2
	12/1/2009	53.12	22.49	-	30.63	120 ^Y	<0.5	<0.5	1.4	2.3	2.3
	3/16/2010	53.12	21.02	-	32.10	<50	<0.5	<0.5	<0.5	<0.5	0.65
	6/4/2010	53.12	21.93	-	31.19	<50	<0.5	<0.5	<0.5	<0.5	1.1
	9/1/2010	53.12	23.32	-	29.80	<50	<0.5	<0.5	0.85	3.76	2.2
	12/3/2010	53.12	22.46	-	30.66	<50	<0.5	<0.5	<0.5	0.67	<0.5
	3/3/2011	53.12	20.45	N	32.67	<50	<0.5	<0.5	<0.5	<0.5	0.58
	5/19/2011	53.12	21.57	N	31.55	<50	<0.5	<0.5	<0.5	<0.5	<0.5
	9/8/2011	53.12	21.92	N	31.20	59	<0.5	<0.5	<0.5	0.51	1.7
	12/1/2011	53.12	21.19	N	31.93	<22	<0.33	<0.19	<0.15	<0.20	4.2
	3/2/2012	53.12	21.8	N	31.32	<50	<0.5	<0.5	0.85	1.2	2.7
	6/6/2012	53.12	22.00	N	31.12	<50	<0.5	<0.5	<0.5	<0.5	1.3
	9/20/2012	53.12	22.67	N	30.45	<50	<0.5	<0.5	<0.5	<0.5	1.6
12/13/2012	53.12	21.55	N	31.57	<50	<0.5	<0.5	<0.5	<0.5	0.94	
3/27/2013	53.12	21.98	N	31.14	<50	<0.5	<0.5	<0.5	<0.5	2.1	
6/10/2013	53.12	22.55	N	30.57	<50	<0.5	<0.5	<0.5	<0.5	1.7	
9/16/2013	53.12	23.05	N	30.07	<50	<0.5	<0.5	<0.5	<0.5	4.6	
12/6/2013	53.12	23.43	N	29.69	<50	<0.5	<0.5	<0.5	<0.5	3.4	

Table 1
Historical Groundwater Elevation Data and Analytical Results
15101 Freedom Avenue, San Leandro, CA

Monitoring Well	Date	Casing Elevation ¹ (feet)	Depth to Groundwater (feet)	Free-Product (feet)/ Sheen (Y/N)	Groundwater Elevation (feet)	TPH-g (µg/L)	Benzene (µg/L)	Toluene (µg/L)	Ethyl-benzene (µg/L)	Total Xylenes (µg/L)	MtBE 8260B ² (µg/L)
MW-4D cont.	3/13/2014	53.12	22.38	N	30.74	<50	<0.5	<0.5	<0.5	<0.5	4.0
	6/6/2014	53.12	22.78	N	30.34	<50	<0.5	<0.5	<0.5	<0.5	1.8
	9/23/2014	53.12	24.05	N	29.07	<50	<0.5	<0.5	<0.5	<0.5	<0.5
	12/23/2014	53.12	19.66	N	33.46	<50	<0.5	<0.5	<0.5	<0.5	<0.5
	3/19/2015	53.12	21.54	N	31.58	<50	<0.5	<0.5	<0.5	<0.5	<0.5
	6/3/2015	53.12	22.10	N	31.02	75	<0.5	<0.5	<0.5	<0.5	<0.5
	9/10/2015	53.12	22.89	N	30.23	<50	<0.5	<0.5	<0.5	<0.5	<0.5
1573 153 RD	1/3/2008	NS	NM	-	NC	<50	<0.5	<2.0	<0.5	<2.0	<0.5
	7/2/2008	NS	NM	-	NC	<50	<0.5	<2.0	<0.5	<2.0	<0.5
	10/16/2008	NS	NM	-	NC	<50	<0.5	<0.5	<0.5	<0.5	<0.5
Equipment Blanks											
EB-PMP	1/21/2008	-	-	-	-	<50	<0.50	<2.0	<0.50	<2.0	<0.50
EB-PRB	1/21/2008	-	-	-	-	<50	<0.50	<2.0	<0.50	<2.0	<0.50
EB-PMP2	1/22/2008	-	-	-	-	<50	<0.50	<2.0	<0.50	<2.0	<0.50
EB-PRB2	1/22/2008	-	-	-	-	<50	<0.50	<2.0	<0.50	<2.0	<0.50
ESL (ug/L)	-	-	-	-	-	100	1	40	13	20	5

Notes:

The first time SOMA monitored this Site was in May 2002.

*: Due to minimal recharge rates in well MW-2, the groundwater elevation recorded on these dates did not match the overall site conditions, May 2002 & August 2003.

NC: Not Calculated

¹: Top of casing elevations were surveyed to a datum of 67.07 M.S.L by Kier & Wright Civil Engineers & Land Surveyors on May 7, 2002.

On October 11, 2004, the site was re-surveyed by Harrington Surveys, Inc. of Walnut Creek, CA to a datum of California Coordinate System, Zone 3, NAD 83.

² MBE analyzed by EPA Method 8021B, and confirmed by EPA Method 8260B.

<: Not detected above the laboratory reporting limit.

Y: Sample exhibits chromatographic pattern which does not resemble standard

^c Presence confirmed, but confirmation concentration differed by more than a factor of two.

C: Presence confirmed, but RPD between columns exceeds 40%.

H: Heavier hydrocarbons contributed to the quantitation.

x: Does not match pattern of reference Gasoline Standard. Hydrocarbons in the range of C5-C12 quantified as gasoline (possibly aged gasoline)

NA: Not Analyzed. Well MW-8 was inaccessible during the First Quarter 2005, car was parked over well.

Not Analyzed. Well MW-7 was inaccessible during the First Quarter 2006, car was parked over well.

NM: Not Measured. Well MW-8 was inaccessible during the First Quarter 2005, car was parked over well.

Not Measured. Well MW-7 was inaccessible during the First Quarter 2006, car was parked over well.

The first time SOMA monitored wells MW-6 to MW-9 was in September 2004.

Table 1
Historical Groundwater Elevation Data and Analytical Results
15101 Freedom Avenue, San Leandro, CA

Monitoring Well	Date	Casing Elevation ¹ (feet)	Depth to Groundwater (feet)	Free-Product (feet)/ Sheen (Y/N)	Groundwater Elevation (feet)	TPH-g (µg/L)	Benzene (µg/L)	Toluene (µg/L)	Ethyl-benzene (µg/L)	Total Xylenes (µg/L)	MtBE 8260B ² (µg/L)
-----------------	------	--------------------------------------	-----------------------------	----------------------------------	------------------------------	--------------	----------------	----------------	----------------------	----------------------	--------------------------------

EB-PMP/EB-PRB: Equipment Blanks for Pump and Probe

ESL: Environmental Screening Levels per CRWQCB SFBay Region (Revised February 2016)

Tier 1 ESL (Groundwater Screening Levels (groundwater is a drinking water resource)

MW-8 and MW-9 were decommissioned November 13, 2009

FP: Groundwater not sampled due to presence of free-product

Groundwater elevation corrected upon presence of FP as follows:

Corrected depth to groundwater is equal to (measured depth)- 0.68(free product thickness)

The correction factor is derived by the following: specific gravity of gas at 20 °C is 0.68, then specific gravity is multiplied by the thickness of free product

Table 2
Historical Gasoline Oxygenates Results
15101 Freedom Avenue, San Leandro, CA

Monitoring Well	Date	TBA (µg/L)	DIPE (µg/L)	ETBE (µg/L)	TAME (µg/L)	1,2-DCA (µg/L)	EDB (µg/L)
1st WBZ							
MW-1	8/8/2002	78	<1.3	<1.3	<1.3	NA	NA
	11/1/2002	42	<1.0	<1.0	<1.0	NA	NA
	2/21/2003	47	<0.5	<0.5	<0.5	NA	NA
	5/28/2003	25	<0.5	<0.5	<0.5	NA	NA
	8/12/2003	<10	<0.5	<0.5	<0.5	NA	NA
	10/9/2003	70	<1.0	<1.0	<1.0	NA	NA
	1/15/2004	55	<0.5	<0.5	<0.5	NA	NA
	5/25/2004	62	<0.7	<0.7	<0.7	NA	NA
	9/21/2004	<10	<0.5	<0.5	<0.5	NA	NA
	12/14/2004	<21.5	<4.3	<4.3	<17.2	NA	NA
	3/11/2005	81	<0.5	<0.5	<2.0	NA	NA
	6/15/2005	<10	<0.5	<0.5	<2.0	NA	NA
	8/26/2005	68.9	<2.15	<2.15	<8.6	NA	NA
	11/11/2005	46	<2.15	<2.15	<8.6	NA	NA
	2/9/2006	11.3	<0.5	<0.5	<2.0	NA	NA
	5/9/2006	<10	<0.5	<0.5	<2.0	0.51	<0.5
	8/10/2006	<43	<2.15	<2.15	<8.60	3.37	<2.15
	10/26/2006	39.4	<1.0	<1.0	<4.0	2.92	<1.0
	1/25/2007	41.4	<0.5	<0.5	<2.0	1.36	<0.5
	4/26/2007	39.6	<0.5	<0.5	<2.0	<0.5	<0.5
	7/25/2007	46.5	<1.0	<1.0	<4.0	<1.0	<1.0
	10/23/2007	53.7	<0.5	<0.5	<2.0	<0.5	<0.5
	1/22/2008	23.8	<0.5	<0.5	<2.16	<0.5	<0.5
	4/16/2008	8.36	<0.5	<0.5	<2.0	164	<0.5
	7/3/2008	30.5	<0.5	<0.5	<2.0	1.08	<0.5
	10/15/2008	<20	<1.0	<1.0	<1.0	<1.0	<1.0
	1/7/2009	<25	<1.3	<1.3	<1.3	<1.3	<1.3
	4/14/2009	15	<0.5	<0.5	<0.5	<0.5	<0.5
	8/27/2009	<40	<2.0	<2.0	<2.0	<2.0	<2.0
	12/2/2009	<40	<2.0	<2.0	<2.0	<2.0	<2.0
	3/17/2010	<10	<0.5	<0.5	<0.5	<0.5	<0.5
	6/3/2010	26	<0.5	<0.5	<0.5	<0.5	<0.5
	9/2/2010	<100	<5.0	<5.0	<5.0	<5.0	<5.0
	12/2/2010	<63	<3.1	<3.1	<3.1	<3.1	<3.1
	3/4/2011	40	<0.5	<0.5	<0.5	<0.5	<0.5
	5/20/2011	<71	<3.6	<3.6	<3.6	<3.6	<3.6
	9/9/2011	33	<1.3	<1.3	<1.3	<1.3	<1.3
	12/2/2011	49	<3.2	<3.5	<3.5	<2.8	<1.7
	3/2/2012	<50	<2.5	<2.5	<2.5	<2.5	<2.5
	6/7/2012	<50	<2.5	<2.5	<2.5	<2.5	<2.5
	9/21/2012	<50	<2.5	<2.5	<2.5	<2.5	<2.5
	12/14/2012	<50	<2.5	<2.5	<2.5	<2.5	<2.5
3/28/2013	<50	<2.5	<2.5	<2.5	<2.5	<2.5	
6/11/2013	<50	<2.5	<2.5	<2.5	<2.5	<2.5	
9/17/2013	<50	<2.5	<2.5	<2.5	<2.5	<2.5	
12/6/2013	<33	<1.7	<1.7	<1.7	<1.7	<1.7	
3/13/2014	<10	<0.5	<0.5	<0.5	<0.5	<0.5	
6/6/2014	<10	<0.5	<0.5	<0.5	<0.5	<0.5	
9/23/2014	<33	<1.7	<1.7	<1.7	<1.7	<1.7	
12/23/2014	4.7 J	<0.5	<0.5	<0.5	<0.5	<0.5	
3/20/2015	11	<0.5	<0.5	<0.5	<0.5	<0.5	
6/4/2015	14 J	<0.71	<0.71	<0.71	<0.71	<0.71	
9/11/2015	<33	<1.7	<1.7	<1.7	<1.7	<1.7	
12/2/2015	<10	<0.5	<0.5	<0.5	<0.5	<0.5	
3/23/2016	<10	<0.5	<0.5	<0.5	<0.5	<0.5	
6/15/2016	<10	<0.5	<0.5	<0.5	<0.5	<0.5	
9/21/2016	17	<0.5	<0.5	<0.5	<0.5	<0.5	
12/14/2016	<10	<0.5	<0.5	<0.5	<0.5	<0.5	
MW-2	8/8/2002	21	<0.5	<0.5	<0.5	NA	NA
	11/1/2002	15	<0.5	<0.5	<0.5	NA	NA
	2/21/2003	12	<0.5	<0.5	<0.5	NA	NA
	5/28/2003	31	<0.5	<0.5	<0.5	NA	NA
	8/12/2003	69	<0.8	<0.8	<0.8	NA	NA
10/9/2003	12	<0.5	<0.5	<0.5	NA	NA	

Table 2
Historical Gasoline Oxygenates Results
15101 Freedom Avenue, San Leandro, CA

Monitoring Well	Date	TBA (µg/L)	DIPE (µg/L)	ETBE (µg/L)	TAME (µg/L)	1,2-DCA (µg/L)	EDB (µg/L)
MW-2 cont.	1/15/2004	<10	<0.5	<0.5	<0.5	NA	NA
	5/25/2004	14	<0.5	<0.5	<0.5	NA	NA
	9/21/2004	<10	<0.5	<0.5	<0.5	NA	NA
	12/14/2004	<2.5	<0.5	<0.5	<2.0	NA	NA
	3/11/2005	<2.5	<0.5	<0.5	<2.0	NA	NA
	6/15/2005	<10	<0.5	<0.5	<2.0	NA	NA
	8/26/2005	<10	<0.5	<0.5	<2.0	NA	NA
	11/11/2005	<10	<0.5	<0.5	<2.0	NA	NA
	2/9/2006	<10	<0.5	<0.5	<2.0	NA	NA
	5/9/2006	<10	<0.5	<0.5	<2.0	<0.5	<0.5
	8/10/2006	<10	<0.5	<0.5	<2.0	<0.5	<0.5
	10/26/2006	<10	<0.5	<0.5	<2.0	<0.5	<0.5
	1/25/2007	<2.0	<0.5	<0.5	<2.0	<0.5	<0.5
	4/26/2007	<2.0	<0.5	<0.5	<2.0	<0.5	<0.5
	7/25/2007	<2.0	<0.5	<0.5	<2.0	<0.5	<0.5
	10/23/2007	<2.0	<0.5	<0.5	<2.0	<0.5	<0.5
	1/22/2008	<2.0	<0.5	<0.5	<2.0	<0.5	<0.5
	4/15/2008	<2.0	<0.5	<0.5	<2.0	2.44	<0.5
	7/2/2008	<2.0	<0.5	<0.5	<2.0	<0.5	<0.5
	10/15/2008	<10	<0.5	<0.5	<0.5	<0.5	<0.5
	1/7/2009	<10	<0.5	<0.5	<0.5	<0.5	<0.5
	4/13/2009	<10	<0.5	<0.5	<0.5	<0.5	<0.5
	8/27/2009	<10	<0.5	<0.5	<0.5	<0.5	<0.5
	12/1/2009	<10	<0.5	<0.5	<0.5	<0.5	<0.5
	3/17/2010	<10	<0.5	<0.5	<0.5	<0.5	<0.5
	6/3/2010	<10	<0.5	<0.5	<0.5	<0.5	<0.5
	9/2/2010	<10	<0.5	<0.5	<0.5	<0.5	<0.5
	12/2/2010	<10	<0.5	<0.5	<0.5	<0.5	<0.5
	3/4/2011	<10	<0.5	<0.5	<0.5	<0.5	<0.5
	5/20/2011	<10	<0.5	<0.5	<0.5	<0.5	<0.5
	9/9/2011	<10	<0.5	<0.5	<0.5	<0.5	<0.5
	12/2/2011	<13	<3.2	<3.5	<2.8	<2.4	<1.7
	3/2/2012	<10	<0.5	<0.5	<0.5	<0.5	<0.5
	6/7/2012	<10	<0.5	<0.5	<0.5	<0.5	<0.5
	9/21/2012	<10	<0.5	<0.5	<0.5	<0.5	<0.5
	12/14/2012	<10	<0.5	<0.5	<0.5	<0.5	<0.5
	3/28/2013	<10	<0.5	<0.5	<0.5	<0.5	<0.5
	6/11/2013	150	<0.5	1.6	<0.5	<0.5	<0.5
	9/16/2013	<10	<0.5	<0.5	<0.5	<0.5	<0.5
	12/6/2013	<10	<0.5	<0.5	<0.5	<0.5	<0.5
	3/13/2014	<10	<0.5	<0.5	<0.5	<0.5	<0.5
	6/6/2014	<10	<0.5	<0.5	<0.5	<0.5	<0.5
	9/23/2014	<10	<0.5	<0.5	<0.5	<0.5	<0.5
	12/23/2014	<10	<0.5	<0.5	<0.5	<0.5	<0.5
	3/20/2015	<10	<0.5	<0.5	<0.5	<0.5	<0.5
	6/4/2015	<1.7	<0.5	<0.5	<0.5	<0.5	<0.5
	9/11/2015	<20	<1.0	<1.0	<1.0	<1.0	<1.0
	12/2/2015	<10	<0.5	<0.5	<0.5	<0.5	<0.5
	3/23/2016	<10	<0.5	<0.5	<0.5	<0.5	<0.5
	6/15/2016	<10	<0.5	<0.5	<0.5	<0.5	<0.5
9/21/2016	<10	<0.5	<0.5	<0.5	<0.5	<0.5	
12/14/2016	<10	<0.5	<0.5	<0.5	<0.5	<0.5	
MW-3	8/8/2002	<330	<8.3	<8.3	330	NA	NA
	11/1/2002	85	< 1.3	<1.3	220	NA	NA
	2/21/2003	140	<5.0	<5.0	320	NA	NA
	5/28/2003	520	<10	<10	530	NA	NA
	8/12/2003	180	<4.2	<4.2	270	NA	NA
	10/9/2003	<170	<8.3	<8.3	200	NA	NA
	1/15/2004	<100	<5.0	<5.0	150	NA	NA
	5/25/2004	<100	<5.0	<5.0	270	NA	NA
	9/21/2004	<140	<7.1	<7.1	110	NA	NA
	12/14/2004	<100	<20	<20	154	NA	NA
	3/11/2005	<215	<43	<43	256	NA	NA
	6/15/2005	<215	<10.8	<10.8	374	NA	NA
	8/26/2005	699	<21.5	<21.5	277	NA	NA
	11/11/2005	<430	<21.5	<21.5	171	NA	NA

Table 2
Historical Gasoline Oxygenates Results
15101 Freedom Avenue, San Leandro, CA

Monitoring Well	Date	TBA (µg/L)	DIPE (µg/L)	ETBE (µg/L)	TAME (µg/L)	1,2-DCA (µg/L)	EDB (µg/L)	
MW-3 cont.	2/9/2006	<430	<21.5	<21.5	620	NA	NA	
	5/9/2006	367	<10.8	<10.8	594	<10.8	<10.8	
	8/10/2006	365	<10.8	<10.8	727	<10.8	<10.8	
	10/26/2006	591	<10.8	<10.8	899	<10.8	<10.8	
	1/25/2007	711	<10.8	<10.8	768	<10.8	<10.8	
	4/26/2007	690	<10.8	<10.8	369	<10.8	<10.8	
	7/25/2007	1,340	<10.8	<10.8	565	<10.8	<10.8	
	10/23/2007	1,050	<21.5	<21.5	301	<21.5	<21.5	
	1/22/2008	373	<10.8	<10.8	170	<0.5	<0.5	
	4/16/2008	881	<5.50	<5.50	<22.0	1,850	12.1	
	7/3/2008	426	<10.8	<10.8	124	<10.8	<10.8	
	10/16/2008	<400	<20	<20	<20	<20	<20	
	1/8/2009	<500	<25	<25	<25	<25	<25	
	4/13/2009	<500	<25	<25	<25	<25	<25	
	8/27/2009	<500	<25	<25	<25	<25	<25	
	12/2/2009	270	<13	<13	<13	<13	<13	
	3/17/2010	<250	<13	<13	<13	<13	<13	
	6/3/2010	<250	<13	<13	<13	<13	<13	
	9/2/2010	<250	<13	<13	<13	<13	<13	
	12/2/2010	<130	<6.3	<6.3	<6.3	<6.3	<6.3	
	3/4/2011	<170	<8.3	<8.3	<8.3	<8.3	<8.3	
	5/20/2011	<130	<6.3	<6.3	<6.3	<6.3	<6.3	
	9/9/2011	<140	<7.1	<7.1	<7.1	<7.1	<7.1	
	12/2/2011	<6.6	<1.6	<1.7	<1.4	<1.2	<0.86	
	3/2/2012	<100	<5.0	<5.0	<5.0	<5.0	<5.0	
	6/7/2012	<100	<5.0	<5.0	<5.0	<5.0	<5.0	
	9/21/2012	<100	<5.0	<5.0	<5.0	<5.0	<5.0	
	12/14/2012	<100	<5.0	<5.0	<5.0	<5.0	<5.0	
	3/28/2013	<100	<5.0	<5.0	<5.0	<5.0	<5.0	
	6/11/2013	<100	<5.0	<5.0	<5.0	<5.0	<5.0	
	9/17/2013	<200	<10	<10	<10	<10	<10	
	12/6/2013	<200	<10	<10	<10	<10	<10	
	3/12/2014	FP	FP	FP	FP	FP	FP	
	6/5/2014	FP	FP	FP	FP	FP	FP	
	9/23/2014	<200	<10	<10	<10	<10	<10	
	12/23/2014	<71	<3.6	<3.6	<3.6	<3.6	<3.6	
	3/20/2015	29 J	<3.6	<3.6	<3.6	<3.6	<3.6	
	6/4/2015	<17	<6.3	<6.3	<6.3	<6.3	<6.3	
	9/11/2015	<130	<6.3	<6.3	<6.3	<6.3	<6.3	
	12/29/2015	<100	<5	<5	<5	<5	<5	
	3/24/2016	60	<1.3	<1.3	<1.3	<1.3	<1.3	
	6/16/2016	38	<0.5	<0.5	<0.5	<0.5	<0.5	
	9/21/2016	140	<2.5	<2.5	<2.5	<2.5	<2.5	
	12/14/2016	<14	<0.71	<0.71	<0.71	<0.71	<0.71	
	MW-4	8/8/2002	1500	<17	<17	18	NA	NA
		11/1/2002	580	< 5.0	6	13	NA	NA
		2/21/2003	1600	<20	22	<20	NA	NA
5/28/2003		690	<8.3	<8.3	17	NA	NA	
8/12/2003		550	<7.1	7.3	18	NA	NA	
10/9/2003		1400	<31	50	<31	NA	NA	
1/15/2004		1,300	<20	25	21	NA	NA	
5/25/2004		560	<8.3	<8.3	24	NA	NA	
9/21/2004		1,300	<50	<50	<50	NA	NA	
12/14/2004		826	<10.75	21	49	NA	NA	
3/11/2005		1,110	<10.8	12.1	<43	NA	NA	
6/15/2005		<110	<5.5	<5.5	22.9	NA	NA	
8/26/2005		902	<5.50	<5.50	37.4	NA	NA	
11/11/2005		884	<10.8	<10.8	<43	NA	NA	
2/9/2006		769	<10.8	16.4	45.6	NA	NA	
5/9/2006		405	<2.15	2.95	31.3	<2.15	<2.15	
8/10/2006		306	<2.15	<2.15	35.3	<2.15	<2.15	
10/26/2006		3430	<10.8	13.8	<43	<10.8	<10.8	
1/25/2007		822	<2.15	2.4	28	2.25	<2.15	
4/26/2007		556	<2.15	2.28	29.2	<2.15	<2.15	
7/25/2007	1,860	<2.15	9.94	24	<2.15	<2.15		
10/23/2007	3,400	<2.15	18.4	25.9	<2.15	<2.15		

Table 2
Historical Gasoline Oxygenates Results
15101 Freedom Avenue, San Leandro, CA

Monitoring Well	Date	TBA (µg/L)	DIPE (µg/L)	ETBE (µg/L)	TAME (µg/L)	1,2-DCA (µg/L)	EDB (µg/L)	
MW-4 cont.	1/22/2008	2,580	<5.50	64.7	<22	<0.5	<0.5	
	4/15/2008	1,100	<5.50	11.7	<22	39.9	<5.50	
	7/2/2008	8,720	<5.50	75.2	<22	<5.50	<5.50	
	10/16/2008	700	<3.6	4.2	37	5.4	<3.6	
	1/8/2009	1,500	<3.6	9.9	41	3.6	<3.6	
	4/13/2009	1,100	<8.3	<8.3	28	<8.3	<8.3	
	8/27/2009	4,900	<5.0	24	<5.0	<5.0	<5.0	
	12/2/2009	6,800	<5.0	69	<5.0	<5.0	<5.0	
	3/17/2010	1,900	<3.6	18	<3.6	<3.6	<3.6	
	6/3/2010	930	<3.6	7.7	<3.6	<3.6	<3.6	
	9/2/2010	7,200	<3.6	57	<3.6	<3.6	<3.6	
	12/2/2010	3,800	<10	30	<10	<10	<10	
	3/3/2011	410	<0.71	3.2	<0.71	<0.71	<0.71	
	5/19/2011	130	<0.5	1.4	<0.5	<0.5	<0.5	
	9/8/2011	380	<0.5	3.5	<0.5	1.1	<0.5	
	12/1/2011	790	<1.6	5.4	8.2	<1.2	<0.86	
	3/2/2012	920	<2.0	5.9	24	<2.0	<2.0	
	6/7/2012	1,000	<2.5	13	<2.5	<2.5	<2.5	
	9/21/2012	1,300	<2.5	14	<2.5	<2.5	<2.5	
	12/14/2012	36	<0.5	0.65	<0.5	<0.5	<0.5	
	3/28/2013	2,500	<5.0	29	<5.0	<5.0	<5.0	
	6/11/2013	890	<5.0	12	<5.0	<5.0	<5.0	
	9/17/2013	1,100	<10	<10	<10	<10	<10	
	12/6/2013	1,500	<10	<10	<10	<10	<10	
	3/13/2014	190	<6.3	<6.3	<6.3	<6.3	<6.3	
	6/6/2014	360	<6.3	<6.3	<6.3	<6.3	<6.3	
	9/23/2014	1,100	<6.3	6.3	<6.3	<6.3	<6.3	
	12/23/2014	8.1 J	<0.5	<0.5	<0.5	<0.5	<0.5	
	3/20/2015	29	<0.5	<0.5	<0.5	<0.5	<0.5	
	6/4/2015	62	<0.5	0.62	<0.5	<0.5	<0.5	
	9/11/2015	82	<1.0	<1.0	<1.0	<1.0	<1.0	
	12/29/2015	32	<0.5	<0.5	1.4	<0.5	<0.5	
	3/23/2016	14	<0.5	<0.5	0.88	<0.5	<0.5	
	6/16/2016	230	<0.5	4.7	<0.5	<0.5	<0.5	
	9/21/2016	130	<0.5	2.0	4.7	<0.5	<0.5	
	12/14/2016	16	<0.5	<0.5	<0.5	<0.5	<0.5	
	MW-5	8/8/2002	<250	<6.3	<6.3	510	NA	NA
		11/1/2002	66	< 2.0	< 2.0	560	NA	NA
		2/21/2003	<63	<3.1	<3.1	280	NA	NA
		5/28/2003	<33	<1.7	<1.7	110	NA	NA
8/12/2003		130	<3.6	<3.6	270	NA	NA	
10/9/2003		<100	<5.0	<5.0	740	NA	NA	
1/15/2004		<63	<3.1	<3.1	300	NA	NA	
5/25/2004		<100	<5.0	<5.0	210	NA	NA	
9/21/2004		<130	<6.3	<6.3	550	NA	NA	
12/14/2004		40	<5.5	<5.5	444	NA	NA	
3/11/2005		88.8	<5.5	<5.5	448	NA	NA	
6/15/2005		<43	<2.15	<2.15	88.1	NA	NA	
8/26/2005		274	<5.50	<5.50	195	NA	NA	
11/11/2005		192	<5.50	<5.50	360	NA	NA	
2/9/2006		218	<5.50	<5.50	523	NA	NA	
5/9/2006		91.8	<2.15	<2.15	163	<2.15	<2.15	
8/10/2006		138	<5.50	<5.50	342	<5.50	<5.50	
10/26/2006		322	<5.50	<5.50	712	<5.50	<5.50	
1/25/2007		878	<5.50	<5.50	552	<5.50	<5.50	
4/26/2007		708	<2.15	<2.15	310	<2.15	<2.15	
7/25/2007		1,020	<2.15	<2.15	356	<2.15	<2.15	
10/23/2007		1,510	<2.15	<2.15	181	<2.15	<2.15	
1/22/2008		470	<0.5	4.56	62.1	<0.5	<0.5	
4/15/2008		566	<1.0	<1.0	29.6	231	5.66	
7/3/2008		2,320	<2.15	<2.15	53.3	<2.15	<2.15	
10/16/2008		990	<5.0	<5.0	82	<5.0	<5.0	
1/8/2009	360	<6.3	<6.3	51	<6.3	<6.3		
4/13/2009	280	<3.1	<3.1	<3.1	<3.1	<3.1		
8/27/2009	1,300	<5.0	<5.0	<5.0	<5.0	<5.0		
12/2/2009	320	<5.0	<5.0	25	<5.0	<5.0		

Table 2
Historical Gasoline Oxygenates Results
15101 Freedom Avenue, San Leandro, CA

Monitoring Well	Date	TBA (µg/L)	DIPE (µg/L)	ETBE (µg/L)	TAME (µg/L)	1,2-DCA (µg/L)	EDB (µg/L)
MW-5 cont.	3/17/2010	570	<1.0	<1.0	<1.0	<1.0	<1.0
	6/4/2010	340	<1.0	<1.0	<1.0	<1.0	<1.0
	9/2/2010	320	<2.5	<2.5	13	<2.5	<2.5
	12/2/2010	200	<3.1	<3.1	<3.1	<3.1	<3.1
	3/4/2011	180	<0.5	<0.5	<0.5	<0.5	<0.5
	5/20/2011	480	<1.0	<1.0	<1.0	<1.0	<1.0
	8/4/2011	110	<0.71	<0.71	2.6	<0.71	<0.71
	9/9/2011	260	<1.0	<1.0	11	<1.0	<1.0
	12/2/2011	95	<3.2	<3.5	14	<2.4	<1.7
	3/2/2012	59	<1.0	<1.0	4.1	<1.0	<1.0
	6/7/2012	22	<1.0	<1.0	2.8	<1.0	<1.0
	9/21/2012	66	<1.0	<1.0	<1.0	<1.0	<1.0
	12/14/2012	<20	<1.0	<1.0	4.2	<1.0	<1.0
	3/28/2013	<20	<1.0	<1.0	<1.0	<1.0	<1.0
	6/11/2013	<20	<1.0	<1.0	2.5	<1.0	<1.0
	9/17/2013	20	<1.0	<1.0	5.7	<1.0	<1.0
	12/6/2013	<20	<1.0	<1.0	3.9	<1.0	<1.0
	3/13/2014	<20	<1.0	<1.0	2.2	<1.0	<1.0
	6/6/2014	<10	<0.5	<0.5	0.81	<0.5	<0.5
	9/23/2014	<10	<0.5	<0.5	<0.5	<0.5	<0.5
12/23/2014	<10	<0.5	<0.5	<0.5	<0.5	<0.5	
3/20/2015	3.1 J	<0.5	<0.5	<0.5	<0.5	<0.5	
6/4/2015	<1.3	<0.5	<0.5	<0.5	<0.5	<0.5	
9/11/2015	<10	<0.5	<0.5	<0.5	<0.5	<0.5	
12/29/2015	<10	<0.5	<0.5	<0.5	<0.5	<0.5	
3/23/2016	19	<0.5	<0.5	<0.5	<0.5	<0.5	
6/16/2016	<10	<0.5	<0.5	<0.5	<0.5	<0.5	
9/21/2016	<10	<0.5	<0.5	<0.5	0.94	<0.5	
12/14/2016	<10	<0.5	<0.5	<0.5	<0.5	<0.5	
MW-6	9/21/2004	<10	<0.5	<0.5	<0.5	NA	NA
	12/14/2004	<5.5	<5.5	<5.5	<22	NA	NA
	3/11/2005	2.54	<0.5	<0.5	<2.0	NA	NA
	6/15/2005	<20	<1.0	<1.0	<4.0	NA	NA
	8/26/2005	<43	<2.15	<2.15	<8.6	NA	NA
	11/11/2005	<43	<2.15	<2.15	<8.6	NA	NA
	2/9/2006	<43	<2.15	<2.15	<8.6	NA	NA
	5/9/2006	<10	<0.5	<0.5	<2.0	<0.5	<0.5
	8/10/2006	<10	<0.5	<0.5	<2.0	<0.5	<0.5
	10/26/2006	<10	<0.5	<0.5	<2.0	<0.5	<0.5
	1/25/2007	<2.0	<0.5	<0.5	<2.0	<0.5	<0.5
	4/26/2007	7.21	<0.5	<0.5	<2.0	<0.5	<0.5
	7/25/2007	5.66	<0.5	<0.5	<2.0	<0.5	<0.5
	10/23/2007	6.68	<0.5	<0.5	<2.0	<0.5	<0.5
	1/21/2008	13.9	<0.5	<0.5	<2.0	<0.5	<0.5
	4/15/2008	<2.0	<0.5	<0.5	<2.0	6.78	1.49
	7/2/2008	4.54	<0.5	<0.5	<2.0	<0.5	<0.5
	10/15/2008	<10	<0.5	<0.5	<0.5	<0.5	<0.5
	1/7/2009	<63	<3.1	<3.1	<3.1	<3.1	<3.1
	4/13/2009	<25	<1.3	<1.3	<1.3	<1.3	<1.3
	8/26/2009	<40	<2.0	<2.0	<2.0	<2.0	<2.0
	12/1/2009	<40	<2.0	<2.0	<2.0	<2.0	<2.0
	3/16/2010	<40	<2.0	<2.0	<2.0	<2.0	<2.0
	6/3/2010	<40	<2.0	<2.0	<2.0	<2.0	<2.0
	9/1/2010	<200	<10	<10	<10	<10	<10
	12/2/2010	<330	<17	<17	<17	<17	<17
	3/3/2011	<50	<2.5	<2.5	<2.5	<2.5	<2.5
	5/20/2011	<50	<2.5	<2.5	<2.5	<2.5	<2.5
	9/8/2011	<50	<2.5	<2.5	<2.5	<2.5	<2.5
	12/1/2011	NA	NA	NA	NA	NA	NA
	3/2/2012	<83	<4.2	<4.2	<4.2	<4.2	<4.2
	6/6/2012	<33	<1.7	<1.7	<1.7	<1.7	<1.7
9/20/2012	NA	NA	NA	NA	NA	NA	
12/13/2012	29	<0.71	<0.71	<0.71	<0.71	<0.71	
3/27/2013	<25	<1.3	<1.3	<1.3	<1.3	<1.3	
6/10/2013	<50	<2.5	<2.5	<2.5	<2.5	<2.5	
9/16/2013	FP	FP	FP	FP	FP	FP	
12/5/2013	270	<2.5	<2.5	<2.5	<2.5	<2.5	

Table 2
Historical Gasoline Oxygenates Results
15101 Freedom Avenue, San Leandro, CA

Monitoring Well	Date	TBA (µg/L)	DIPE (µg/L)	ETBE (µg/L)	TAME (µg/L)	1,2-DCA (µg/L)	EDB (µg/L)
MW-6 cont.	3/12/2014	<50	<2.5	<2.5	<2.5	<2.5	<2.5
	6/5/2014	<50	<2.5	<2.5	<2.5	<2.5	<2.5
	9/22/2014	160	<2.5	<2.5	<2.5	<2.5	<2.5
	12/22/2014	13 J	<0.5	<0.5	<0.5	<0.5	<0.5
	3/19/2015	4.1 J	<0.5	<0.5	<0.5	<0.5	<0.5
	6/3/2015	<1.3	<0.5	<0.5	<0.5	<0.5	<0.5
	9/10/2015	<100	<5.0	<5.0	<5.0	<5.0	<5.0
	12/28/2015	<20	<1.0	<1.0	<1.0	<1.0	<1.0
	3/24/2016	<10	<0.5	<0.5	<0.5	<0.5	<0.5
	6/16/2016	<10	<0.5	<0.5	<0.5	<0.5	<0.5
	9/21/2016	<20	<1.0	<1.0	<1.0	<1.0	<1.0
	12/15/2016	<10	<0.5	<0.5	<0.5	<0.5	<0.5
	MW-7	9/21/2004	<10	<0.5	<0.5	1.5	NA
12/14/2004		<2.5	<0.5	<0.5	<2.0	NA	NA
3/11/2005		<12.5	<2.5	<2.5	<10	NA	NA
6/15/2005		<10	<0.5	<0.5	2.23	NA	NA
8/26/2005		<10	<0.5	<0.5	<2.0	NA	NA
11/11/2005		<10	<0.5	<0.5	<2.0	NA	NA
2/9/2006		NA	NA	NA	NA	NA	NA
5/9/2006		<10	<0.5	<0.5	<2.0	<0.5	<0.5
8/10/2006		<10	<0.5	<0.5	<2.0	<0.5	<0.5
10/26/2006		<10	<0.5	<0.5	<2.0	<0.5	<0.5
1/25/2007		<2.0	<0.5	<0.5	<2.0	<0.5	<0.5
4/26/2007		<2.0	<0.5	<0.5	<2.0	<0.5	<0.5
7/25/2007		<2.0	<0.5	<0.5	<2.0	<0.5	<0.5
10/23/2007		6.49	<0.5	<0.5	2.58	<0.5	<0.5
1/21/2008		<2.0	<0.5	<0.5	6.01	<0.5	<0.5
4/15/2008		8.8	<0.5	<0.5	<2.0	<0.5	1.26
7/2/2008		<2.0	<0.5	<0.5	<2.0	<0.5	<0.5
10/15/2008		<10	<0.5	<0.5	14	<0.5	<0.5
1/7/2009		<10	<0.5	<0.5	11	<0.5	<0.5
4/13/2009		<10	<0.5	<0.5	16	<0.5	<0.5
8/26/2009		<33	<0.5	<0.5	33	<0.5	<0.5
12/1/2009		<10	<0.5	<0.5	30	<0.5	<0.5
3/16/2010		11	<0.5	<0.5	<0.5	<0.5	<0.5
6/3/2010		20	<0.5	<0.5	7.1	<0.5	<0.5
9/1/2010		47	<0.5	<0.5	7.2	<0.5	<0.5
12/2/2010		22	<0.5	<0.5	4.9	<0.5	<0.5
3/4/2011		14	<0.5	<0.5	4.0	<0.5	<0.5
5/19/2011		<10	<0.5	<0.5	2.1	<0.5	<0.5
9/8/2011		<10	<0.5	<0.5	1.6	<0.5	<0.5
12/1/2011		15	<0.36	<0.40	2.4	<0.28	<0.19
3/2/2012		<10	<0.5	<0.5	0.82	<0.5	<0.5
6/6/2012		<10	<0.5	<0.5	<0.5	<0.5	<0.5
9/20/2012		<10	<0.5	<0.5	<0.5	<0.5	<0.5
12/13/2012	<10	<0.5	<0.5	<0.5	<0.5	<0.5	
3/27/2013	<10	<0.5	<0.5	<0.5	<0.5	<0.5	
6/10/2013	<10	<0.5	<0.5	<0.5	<0.5	<0.5	
9/16/2013	<10	<0.5	<0.5	<0.5	<0.5	<0.5	
12/5/2013	<10	<0.5	<0.5	0.73	<0.5	<0.5	
3/12/2014	<10	<0.5	<0.5	0.64	<0.5	<0.5	
6/5/2014	<10	<0.5	<0.5	0.76	<0.5	<0.5	
9/22/2014	<10	<0.5	<0.5	<0.5	<0.5	<0.5	
12/22/2014	<10	<0.5	<0.5	<0.5	<0.5	<0.5	
3/19/2015	3.0 J	<0.5	<0.5	0.68	<0.5	<0.5	
6/3/2015	<1.3	<0.5	<0.5	<0.5	<0.5	<0.5	
9/10/2015	<33	<1.7	<1.7	<1.7	<1.7	<1.7	
12/28/2015	<10	<0.5	<0.5	<0.5	<0.5	<0.5	
3/24/2016	<10	<0.5	<0.5	<0.5	<0.5	<0.5	
6/16/2016	<10	<0.5	<0.5	<0.5	<0.5	<0.5	
9/21/2016	<10	<0.5	<0.5	<0.5	<0.5	<0.5	
12/15/2016	<10	<0.5	<0.5	<0.5	<0.5	<0.5	
MW-8	9/21/2004	<10	<0.5	<0.5	<0.5	NA	NA
	12/14/2004	<2.5	<0.5	<0.5	<2.0	NA	NA

Table 2
Historical Gasoline Oxygenates Results
15101 Freedom Avenue, San Leandro, CA

Monitoring Well	Date	TBA (µg/L)	DIPE (µg/L)	ETBE (µg/L)	TAME (µg/L)	1,2-DCA (µg/L)	EDB (µg/L)
MW-8 cont.	3/11/2005	NA	NA	NA	NA	NA	NA
	6/15/2005	<10	<0.5	<0.5	<2.0	NA	NA
	8/26/2005	<10	<0.5	<0.5	<2.0	NA	NA
	11/11/2005	<10	<0.5	<0.5	<2.0	NA	NA
	2/9/2006	<10	<0.5	<0.5	<2.0	NA	NA
	5/9/2006	<10	<0.5	<0.5	<2.0	<0.5	<0.5
	8/10/2006	<10	<0.5	<0.5	<2.0	<0.5	<0.5
	10/26/2006	<10	<0.5	<0.5	<2.0	<0.5	<0.5
	1/25/2007	<2.0	<0.5	<0.5	<2.0	<0.5	<0.5
	4/26/2007	<2.0	<0.5	<0.5	<2.0	<0.5	<0.5
	7/25/2007	<2.0	<0.5	<0.5	<2.0	<0.5	<0.5
	10/23/2007	<2.0	<0.5	<0.5	<2.0	<0.5	<0.5
	1/21/2008	<2.0	<0.5	<0.5	<2.0	<0.5	<0.5
	4/15/2008	<2.0	<0.5	<0.5	<2.0	<0.5	<0.5
	7/2/2008	<2.0	<0.5	<0.5	<2.0	<0.5	<0.5
	10/15/2008	<10	<0.5	<0.5	<0.5	<0.5	<0.5
	1/7/2009	<10	<0.5	<0.5	<0.5	<0.5	<0.5
	4/13/2009	<10	<0.5	<0.5	<0.5	<0.5	<0.5
	8/27/2009	<10	<0.5	<0.5	<0.5	<0.5	<0.5
Well Decommissioned 11/13/2009							
MW-9	9/21/2004	<10	<0.5	<0.5	<0.5	NA	NA
	12/14/2004	<2.5	<0.5	<0.5	<2.0	NA	NA
	3/11/2005	<2.5	<0.5	<0.5	<2.0	NA	NA
	6/15/2005	<10	<0.5	<0.5	<2.0	NA	NA
	8/26/2005	<10	<0.5	<0.5	<2.0	NA	NA
	11/11/2005	<10	<0.5	<0.5	<2.0	NA	NA
	2/9/2006	<10	<0.5	<0.5	<2.0	NA	NA
	5/9/2006	<10	<0.5	<0.5	<2.0	2.8	<0.5
	8/10/2006	<10	<0.5	<0.5	<2.0	1.83	<0.5
	10/26/2006	<10	<0.5	<0.5	<2.0	3.07	<0.5
	1/25/2007	<2.0	<0.5	<0.5	<2.0	2.92	<0.5
	4/26/2007	<2.0	<0.5	<0.5	<2.0	<0.5	<0.5
	7/25/2007	<2.0	<0.5	<0.5	<2.0	<0.5	<0.5
	10/23/2007	<2.0	<0.5	<0.5	<2.0	<0.5	<0.5
	1/21/2008	<2.0	<0.5	<0.5	<2.0	1.18	<0.5
	4/15/2008	<2.0	<0.5	<0.5	<2.0	<0.5	<0.5
	7/2/2008	<2.0	<0.5	<0.5	<2.0	2.07	<0.5
	10/15/2008	<10	<0.5	<0.5	<0.5	1.5	<0.5
	1/7/2009	<10	<0.5	<0.5	<0.5	1.4	<0.5
4/13/2009	<10	<0.5	<0.5	<0.5	0.97	<0.5	
8/26/2009	<10	<0.5	<0.5	<0.5	2.6	<0.5	
Well Decommissioned 11/13/2009							
MW-10	9/22/2014	<200	<10	<10	<10	<10	<10
	12/22/2014	30 J	<2.5	<2.5	<2.5	<2.5	<2.5
	3/19/2015	85	<1.0	<1.0	<1.0	<1.0	<1.0
	6/3/2015	170 J	<5.0	<5.0	<5.0	<5.0	<5.0
	9/10/2015	<200	<10	<10	<10	<10	<10
	12/28/2015	<200	<10	<10	<10	<10	<10
	3/24/2016	140	<5	<5	<5	<5	<5
MW-10R	6/15/2016	<200	<10	<10	<10	<10	<10
	8/8/2016	91	<4.2	<4.2	<4.2	<4.2	<4.2
	9/21/2016	100	<2.0	<2.0	<2.0	<2.0	<2.0
	12/15/2016	<40	<2.0	<2.0	<2.0	<2.0	<2.0
MW-11	9/22/2014	69	<0.5	<0.5	<0.5	<0.5	<0.5
	12/22/2014	15	<0.5	<0.5	<0.5	<0.5	<0.5
	3/19/2015	3.5 J	<0.5	<0.5	<0.5	<0.5	<0.5
	6/3/2015	<2.1	<0.5	<0.5	<0.5	<0.5	<0.5
	9/10/2015	<10	<0.5	<0.5	<0.5	<0.5	<0.5
	12/28/2015	<10	<0.5	<0.5	<0.5	<0.5	<0.5
	3/23/2016	<10	<0.5	<0.5	<0.5	<0.5	<0.5
	6/16/2016	<10	<0.5	<0.5	<0.5	<0.5	<0.5
	9/21/2016	<10	<0.5	<0.5	<0.5	<0.5	<0.5
	12/15/2016	<10	<0.5	<0.5	<0.5	<0.5	<0.5

Table 2
Historical Gasoline Oxygenates Results
15101 Freedom Avenue, San Leandro, CA

Monitoring Well	Date	TBA (µg/L)	DIPE (µg/L)	ETBE (µg/L)	TAME (µg/L)	1,2-DCA (µg/L)	EDB (µg/L)
EX-1	12/2/2009	150	<1.3	<1.3	<1.3	<1.3	<1.3
	3/16/2010	980	<1.3	2.4	27	<1.3	<1.3
	6/3/2010	570	<1.3	1.9	<1.3	<1.3	<1.3
	9/1/2010	470	<0.5	1.4	2	<0.5	<0.5
	12/2/2010	1,300	<2.0	3.6	15	<2.0	<2.0
	3/3/2011	690	<0.71	2.5	12	<0.71	<0.71
	5/19/2011	370	<0.71	1.9	13	<0.71	<0.71
	9/8/2011	32	<0.5	<0.5	0.53	<0.5	<0.5
	12/1/2011	1,200	<1.6	8.3	6.8	<1.2	<0.86
	3/2/2012	31	<0.5	<0.5	<0.5	<0.5	<0.5
	6/6/2012	390	<0.5	2.9	4.8	0.57	<0.5
	9/20/2012	170	<0.5	1.5	<0.5	<0.5	<0.5
	12/13/2012	210	<0.5	2.7	5.2	<0.5	<0.5
	3/27/2013	<10	<0.5	<0.5	<0.5	<0.5	<0.5
	6/10/2013	280	<0.5	4.0	1.6	<0.5	<0.5
	9/16/2013	450	<0.5	2.4	1.9	<0.5	<0.5
	12/5/2013	230	<0.5	1.7	5.5	<0.5	<0.5
	3/12/2014	48	<0.5	0.77	3.1	<0.5	<0.5
	6/5/2014	70	<0.5	1.1	3.9	0.69	<0.5
	9/22/2014	96	<0.5	0.94	5.6	<0.5	<0.5
	12/22/2014	91	<0.5	0.84	<0.5	<0.5	<0.5
	3/19/2015	<10	<0.5	<0.5	<0.5	<0.5	<0.5
	6/3/2015	35	<0.5	1.4	<0.5	<0.5	<0.5
	9/10/2015	<10	<0.5	<0.5	<0.5	<0.5	<0.5
	12/28/2015	38	<0.5	0.7	2.4	<0.5	<0.5
	3/24/2016	<10	<0.5	<0.5	<0.5	<0.5	<0.5
	6/15/2016	<10	<0.5	<0.5	<0.5	<0.5	<0.5
	9/21/2016	<10	<0.5	<0.5	<0.5	<0.5	<0.5
12/14/2016	15	<0.5	0.81	<0.5	<0.5	<0.5	
EX-2	12/2/2009	<63	<3.1	<3.1	<3.1	<3.1	<3.1
	3/16/2010	<100	<5.0	<5.0	<5.0	<5.0	<5.0
	6/3/2010	<100	<5.0	<5.0	<5.0	<5.0	<5.0
	9/1/2010	<50	<2.5	<2.5	<2.5	<2.5	<2.5
	12/2/2010	<100	<5.0	<5.0	<5.0	<5.0	<5.0
	3/3/2011	<100	<5.0	<5.0	<5.0	<5.0	<5.0
	5/19/2011	<100	<5.0	<5.0	<5.0	<5.0	<5.0
	9/8/2011	<25	<1.3	<1.3	<1.3	<1.3	<1.3
	12/1/2011	74	<3.2	<3.5	<2.8	<2.4	<1.7
	3/2/2012	<25	<1.3	<1.3	<1.3	<1.3	<1.3
	6/6/2012	<33	<1.7	<1.7	<1.7	<1.7	<1.7
	9/20/2012	<33	<1.7	<1.7	<1.7	<1.7	<1.7
	12/13/2012	<71	<3.6	<3.6	<3.6	<3.6	<3.6
	3/27/2013	<20	<1.0	<1.0	<1.0	<1.0	<1.0
	6/10/2013	32	<1.0	<1.0	<1.0	<1.0	<1.0
	9/20/2013	<20	<1.0	<1.0	<1.0	1.4	<1.0
	12/5/2013	30	<1.0	<1.0	<1.0	1.2	<1.0
	3/12/2014	<40	<2.0	<2.0	<2.0	<2.0	<2.0
	6/5/2014	<40	<2.0	<2.0	<2.0	<2.0	<2.0
	9/22/2014	<10	<0.5	<0.5	<0.5	1.1	<0.5
	12/22/2014	37	<0.5	<0.5	<0.5	0.8	<0.5
	3/19/2015	<10	<0.5	<0.5	<0.5	<0.5	<0.5
6/3/2015	17 J	<1.0	<1.0	<1.0	<1.0	<1.0	
9/10/2015	<20	<1.0	<1.0	<1.0	<1.0	<1.0	
12/28/2015	<20	<1.0	<1.0	<1.0	<1.0	<1.0	
3/24/2016	<10	<0.5	<0.5	<0.5	<0.5	<0.5	
MPE Wells							
MPE-1	8/4/2011	<500	<25	<25	<25	<25	<25
	9/26/2011	<500	<25	<25	600	<25	<25
	12/2/2011	830	<32	<35	750	<24	<17
	3/2/2012	<710	<36	<36	1,200	<36	<36
	6/6/2012	<630	<31	<31	430	<31	<31
	9/20/2012	<1,300	<63	<63	1,200	<63	<63
12/14/2012	<1,300	<63	<63	940	<63	<63	

Table 2
Historical Gasoline Oxygenates Results
15101 Freedom Avenue, San Leandro, CA

Monitoring Well	Date	TBA (µg/L)	DIPE (µg/L)	ETBE (µg/L)	TAME (µg/L)	1,2-DCA (µg/L)	EDB (µg/L)	
MPE-1 cont.	3/27/2013	<710	<36	<36	890	<36	<36	
	6/10/2013	660	<13	<13	380	<13	<13	
	9/17/2013	1,400	<13	<13	<13	<13	<13	
	12/6/2013	1,500	<20	<20	30	<20	<20	
	3/13/2014	1,100	<20	<20	160	<20	<20	
	6/5/2014	FP	FP	FP	FP	FP	FP	
	9/23/2014	420	<3.6	3.7	24	<3.6	<3.6	
	12/23/2014	<20	<1.0	<1.0	<1.0	<1.0	<1.0	
	3/20/2015	<50	<2.5	<2.5	<2.5	<2.5	<2.5	
	6/4/2015	<13	<5.0	<5.0	9.2	<5.0	<5.0	
	9/11/2015	<100	<5.0	<5.0	85	<5.0	<5.0	
	12/29/2015	<10	<0.5	<0.5	1.6	<0.5	<0.5	
	3/24/2016	<10	<0.5	<0.5	<0.5	<0.5	<0.5	
	6/16/2016	<10	<0.5	<0.5	0.67	<0.5	<0.5	
	9/21/2016	<10	<0.5	<0.5	1.10	<0.5	<0.5	
	12/14/2016	<10	<0.5	<0.5	<0.5	<0.5	<0.5	
	MPE-2	8/4/2011	<330	<17	<17	<17	<17	<17
		9/26/2011	<330	<17	<17	<17	<17	<17
		12/2/2011	<66	<16	<17	<14	<12	<8.6
		3/2/2012	<330	<17	<17	<17	<17	<17
6/7/2012		<250	<13	<13	<13	<13	<13	
9/21/2012		<250	<13	<13	<13	<13	<13	
12/14/2012		<250	<13	<13	<13	<13	<13	
3/28/2013		<400	<20	<20	<20	<20	<20	
6/11/2013		<250	<13	<13	<13	<13	<13	
9/17/2013		<250	<13	<13	<13	<13	<13	
12/5/2013		FP	FP	FP	FP	FP	FP	
3/12/2014		FP	FP	FP	FP	FP	FP	
6/5/2014		FP	FP	FP	FP	FP	FP	
9/23/2014		<130	<6.3	<6.3	<6.3	<6.3	<6.3	
12/23/2014		23 J	<4.2	<4.2	<4.2	<4.2	<4.2	
3/20/2015		57 J	<4.2	<4.2	5.2	<4.2	<4.2	
6/4/2015		66 J	<5.0	<5.0	<5.0	<5.0	<5.0	
9/11/2015		<140	<7.1	<7.1	<7.1	<7.1	<7.1	
12/29/2015		<130	<6.3	<6.3	<6.3	<6.3	<6.3	
3/24/2016		250	<6.3	<6.3	<6.3	<6.3	<6.3	
6/16/2016	130	<5.0	<5.0	<5.0	<5.0	<5.0		
9/21/2016	210	<6.3	<6.3	<6.3	<6.3	<6.3		
12/14/2016	150	<3.1	<3.1	<3.1	<3.1	<3.1		
2nd WBZ								
MW-1D	1/3/2008	111	<0.5	<0.5	<2.0	NA	NA	
	1/22/2008	12.9	<0.5	<0.5	<2.0	<0.5	<0.5	
	4/16/2008	<2.0	<0.5	<0.5	<2.0	<0.5	<0.5	
	7/3/2008	<2.0	<0.5	<0.5	<2.0	<0.5	<0.5	
	10/15/2008	<10	<0.5	<0.5	<0.5	<0.5	<0.5	
	1/8/2009	<10	<0.5	<0.5	<0.5	<0.5	<0.5	
	4/14/2009	<10	<0.5	<0.5	<0.5	<0.5	<0.5	
	8/26/2009	<10	<0.5	<0.5	<0.5	<0.5	<0.5	
	12/1/2009	<10	<0.5	<0.5	<0.5	<0.5	<0.5	
	3/16/2010	<10	<0.5	<0.5	<0.5	<0.5	<0.5	
	6/4/2010	<10	<0.5	<0.5	<0.5	<0.5	<0.5	
	9/1/2010	<10	<0.5	<0.5	<0.5	<0.5	<0.5	
	12/3/2010	<10	<0.5	<0.5	<0.5	<0.5	<0.5	
	3/3/2011	<10	<0.5	<0.5	<0.5	<0.5	<0.5	
	5/19/2011	<10	<0.5	<0.5	<0.5	<0.5	<0.5	
	9/8/2011	<10	<0.5	<0.5	<0.5	<0.5	<0.5	
	12/1/2011	<1.5	<0.36	<0.40	<0.32	<0.28	<0.19	
	3/2/2012	<10	<0.5	<0.5	<0.5	<0.5	<0.5	
	6/6/2012	<10	<0.5	<0.5	<0.5	<0.5	<0.5	
	9/20/2012	<10	<0.5	<0.5	<0.5	<0.5	<0.5	
	12/13/2012	<10	<0.5	<0.5	<0.5	<0.5	<0.5	
	3/27/2013	<10	<0.5	<0.5	<0.5	<0.5	<0.5	
	6/10/2013	<10	<0.5	<0.5	<0.5	<0.5	<0.5	
	9/16/2013	<10	<0.5	<0.5	<0.5	<0.5	<0.5	
12/5/2013	<10	<0.5	<0.5	<0.5	<0.5	<0.5		

Table 2
Historical Gasoline Oxygenates Results
15101 Freedom Avenue, San Leandro, CA

Monitoring Well	Date	TBA (µg/L)	DIPE (µg/L)	ETBE (µg/L)	TAME (µg/L)	1,2-DCA (µg/L)	EDB (µg/L)
MW-1D cont.	3/12/2014	<10	<0.5	<0.5	<0.5	<0.5	<0.5
	6/5/2014	<10	<0.5	<0.5	<0.5	<0.5	<0.5
	9/22/2014	<10	<0.5	<0.5	<0.5	<0.5	<0.5
	12/23/2014	<10	<0.5	<0.5	<0.5	<0.5	<0.5
	3/19/2015	<10	<0.5	<0.5	<0.5	<0.5	<0.5
	6/3/2015	<2.1	<0.5	<0.5	<0.5	<0.5	<0.5
	9/10/2015	<10	<0.5	<0.5	<0.5	<0.5	<0.5
MW-3D	1/3/2008	37.3	<0.5	3.12	15.3	NA	NA
	1/22/2008	15.6	<0.5	3.1	15.3	<0.5	<0.5
	4/16/2008	17.7	<0.5	<0.5	<2.0	<0.5	<0.5
	7/3/2008	<2.0	<0.5	<0.5	7.45	<0.5	<0.5
	10/16/2008	<10	<0.5	<0.5	4.7	<0.5	<0.5
	1/8/2009	<10	<0.5	<0.5	3.4	<0.5	<0.5
	4/14/2009	<10	<0.5	<0.5	5	<0.5	<0.5
	8/26/2009	<10	<0.5	<0.5	1.6	<0.5	<0.5
	12/1/2009	<10	<0.5	<0.5	2.2	<0.5	<0.5
	3/16/2010	<10	<0.5	<0.5	0.65	<0.5	<0.5
	6/4/2010	<10	<0.5	<0.5	1.8	<0.5	<0.5
	9/1/2010	<10	<0.5	<0.5	<0.5	<0.5	<0.5
	12/3/2010	<10	<0.5	<0.5	0.93	<0.5	<0.5
	3/3/2011	<10	<0.5	<0.5	1.0	<0.5	<0.5
	5/19/2011	<10	<0.5	<0.5	<0.5	<0.5	<0.5
	9/8/2011	<10	<0.5	<0.5	<0.5	<0.5	<0.5
	12/1/2011	<1.5	<0.36	<0.40	0.52	<0.28	<0.19
	3/2/2012	<10	<0.5	<0.5	<0.5	<0.5	<0.5
	6/6/2012	<10	<0.5	<0.5	<0.5	<0.5	<0.5
	9/20/2012	<10	<0.5	<0.5	<0.5	<0.5	<0.5
	12/13/2012	<10	<0.5	<0.5	<0.5	<0.5	<0.5
	3/27/2013	<10	<0.5	<0.5	<0.5	<0.5	<0.5
	6/10/2013	<10	<0.5	<0.5	<0.5	<0.5	<0.5
	9/16/2013	<10	<0.5	<0.5	<0.5	<0.5	<0.5
	12/5/2013	<10	<0.5	<0.5	<0.5	<0.5	<0.5
	3/13/2014	<10	<0.5	<0.5	<0.5	<0.5	<0.5
	6/5/2014	<10	<0.5	<0.5	<0.5	<0.5	<0.5
9/22/2014	<10	<0.5	<0.5	<0.5	<0.5	<0.5	
12/23/2014	<10	<0.5	<0.5	<0.5	<0.5	<0.5	
3/19/2015	<10	<0.5	<0.5	<0.5	<0.5	<0.5	
6/3/2015	<2.1	<0.5	<0.5	<0.5	<0.5	<0.5	
9/10/2015	<10	<0.5	<0.5	<0.5	<0.5	<0.5	
MW-4D	1/4/2008	25	<0.5	<0.5	<2.0	NA	NA
	1/22/2008	124	<0.5	4.9	3.32	<0.5	<0.5
	4/15/2008	25.7	<0.5	<0.5	<2.0	<0.5	<0.5
	7/3/2008	3.38	<0.5	<0.5	<2.0	<0.5	<0.5
	10/16/2008	<10	<0.5	<0.5	<0.5	<0.5	<0.5
	1/8/2009	<10	<0.5	<0.5	<0.5	<0.5	<0.5
	4/14/2009	<10	<0.5	<0.5	<0.5	<0.5	<0.5
	8/27/2009	<10	<0.5	<0.5	<0.5	<0.5	<0.5
	12/1/2009	<10	<0.5	<0.5	<0.5	<0.5	<0.5
	3/16/2010	<10	<0.5	<0.5	<0.5	<0.5	<0.5
	6/4/2010	<10	<0.5	<0.5	<0.5	<0.5	<0.5
	9/1/2010	<10	<0.5	<0.5	<0.5	<0.5	<0.5
	12/3/2010	<10	<0.5	<0.5	<0.5	<0.5	<0.5
	3/3/2011	<10	<0.5	<0.5	<0.5	<0.5	<0.5
	5/19/2011	<10	<0.5	<0.5	<0.5	<0.5	<0.5
	9/8/2011	<10	<0.5	<0.5	<0.5	<0.5	<0.5
	12/1/2011	<1.5	<0.36	<0.40	<0.32	<0.28	<0.19
	3/2/2012	<10	<0.5	<0.5	<0.5	<0.5	<0.5
	6/6/2012	<10	<0.5	<0.5	<0.5	<0.5	<0.5
	9/20/2012	<10	<0.5	<0.5	<0.5	<0.5	<0.5
12/13/2012	<10	<0.5	<0.5	<0.5	<0.5	<0.5	
3/27/2013	<10	<0.5	<0.5	<0.5	<0.5	<0.5	
6/10/2013	<10	<0.5	<0.5	<0.5	<0.5	<0.5	
9/16/2013	<10	<0.5	<0.5	<0.5	<0.5	<0.5	
12/6/2013	<10	<0.5	<0.5	<0.5	<0.5	<0.5	

Table 2
Historical Gasoline Oxygenates Results
15101 Freedom Avenue, San Leandro, CA

Monitoring Well	Date	TBA (µg/L)	DIPE (µg/L)	ETBE (µg/L)	TAME (µg/L)	1,2-DCA (µg/L)	EDB (µg/L)
MW-4D cont.	3/13/2014	<10	<0.5	<0.5	<0.5	<0.5	<0.5
	6/6/2014	<10	<0.5	<0.5	<0.5	<0.5	<0.5
	9/23/2014	<10	<0.5	<0.5	<0.5	<0.5	<0.5
	12/23/2014	<10	<0.5	<0.5	<0.5	<0.5	<0.5
	3/19/2015	<10	<0.5	<0.5	<0.5	<0.5	<0.5
	6/3/2015	4.8 J	<0.5	<0.5	<0.5	<0.5	<0.5
9/10/2015	<10	<0.5	<0.5	<0.5	<0.5	<0.5	
1573 153 RD	1/3/2008	21	<0.5	<0.5	<2.0	<0.5	<2.0
	7/2/2008	<2.0	<0.5	<0.5	<2.0	<0.5	<0.5
	10/16/2008	<10	<0.5	<0.5	<0.5	<0.5	<0.5
EB-PMP	1/21/2008	<2.0	<0.5	<0.5	<2.0	<0.5	<0.5
EB-PRB	1/21/2008	<2.0	<0.5	<0.5	<2.0	<0.5	<0.5
EB-PMP2	1/22/2008	<2.0	<0.5	<0.5	<2.0	<0.5	<0.5
EB-PRB2	1/22/2008	<2.0	<0.5	<0.5	<2.0	<0.5	<0.5
ESL		12	NE	NE	NE	0.5	0.05

Notes:
August 8, 2002 was the first time that samples were analyzed for Gasoline Oxygenates
<: Not detected above the laboratory reporting limit.
NA: Not Analyzed. Well MW-8 was inaccessible during the 1Q05 & well MW-7 (1Q06) car was parked over each well.
NE: Not Established
TBA: tert-Butyl Alcohol
DIPE: Isopropyl Ether
ETBE: Ethyl tert-Butyl Ether
TAME: Methyl tert-Amyl Ether
ESL: Environmental Screening Levels per CRWQCB SFBay Region (Revised February 2016)
Tier 1 ESL (Groundwater Screening Levels (groundwater is a drinking water resource)
MW-8 and MW-9 were decommissioned November 13, 2009
FP: Groundwater not sampled due to presence of free-product in MW-6

Table 3
Effluent Chemical Analytical Results
and Operational History of Remediation System
15101 Freedom Ave, San Leandro, CA

Date	Volume (gallons)	TPH-g (µg/L)	TPH-d (µg/L)	TPH-mo (µg/L)	Benzene (µg/L)	Toluene (µg/L)	Ethylbenzene (µg/L)	Total Xylenes (µg/L)	COD (mg/L)	TSS (mg/L)	pH
2009											
8-Oct-2009	15,351	<50	120 ^Y	NA	NA	NA	NA	NA	NA	NA	NA
19-Nov-2009	8,287	<50	<50	<300	<0.5	<0.5	<0.5	<0.5	<10	<5	7.7
9-Dec-2009	0	Installation of GWETS									
16-Dec-2009	20,000	<50	<50	<300	<0.5	0.65 C	<0.5	0.84 C	<10	<5	7.4
2010											
18-Jan-2010	215,453	<50	<50	<300	<0.5	<0.5	<0.5	<0.5	<10	<5	7.4
15-Feb-2010	297,560	<50	<50	<300	<0.5	<0.5	<0.5	<0.5	11	<5	6.7
15-Mar-2010	475,245	<50	<50	<300	<0.5	<0.5	<0.5	<0.5	<10	<5.0	6.5
19-Apr-2010	621,180	<50	<50	<300	<0.5	<0.5	<0.5	<0.5	<10	8	6.6
17-May-2010	705,770	<50	<50	<300	<0.5	<0.5	<0.5	<0.5	<10	8	6.7
16-Jun-2010	825,200	<50	<50	<300	<0.5	<0.5	<0.5	<0.5	17	9	6.8
19-Jul-2010	910,652	<50	<50	<300	<0.5	<0.5	<0.5	<0.5	<10	8	6.6
16-Aug-2010	939,935	<50	<50	<300	<0.5	<0.5	<0.5	<0.5	<10	6	6.6
28-Sep-2010	970,450	<50	<50	<300	<0.5	<0.5	<0.5	<0.5	<10	10	6.8
26-Oct-2010	1,013,700	<50	<50	<300	<0.5	<0.5	<0.5	<0.5	<10	<5	7.2
15-Nov-2010	1,052,591	<50	<50	<300	<0.5	<0.5	<0.5	<0.5	<10	<5	6.5
7-Dec-2010	1,100,492	<50	<50	<300	<0.5	<0.5	<0.5	<0.5	<10	6	6.6
2011											
11-Jan-2011	1,179,075	<50	<50	<300	<0.5	<0.5	<0.5	<0.5	12	6	6.6
10-Feb-2011	1,249,569	<50	<50	<300	<0.5	<0.5	<0.5	<0.5	<10	<5	6.6
14-Mar-2011	1,336,784	<50	<50	<300	<0.5	<0.5	<0.5	<0.5	<10	<5	6.5
11-Apr-2011	1,364,272	<50	<50	<300	<0.5	<0.5	<0.5	<0.5	<10	6	6.5
10-May-2011	1,466,472	<50	<50	<300	<0.5	<0.5	<0.5	<0.5	12	7	6.6
7-Jun-2011	1,532,263	<50	<50	<300	<0.5	<0.5	<0.5	<0.5	<10	6	6.6

Table 3
Effluent Chemical Analytical Results
and Operational History of Remediation System
15101 Freedom Ave, San Leandro, CA

Date	Volume (gallons)	TPH-g (µg/L)	TPH-d (µg/L)	TPH-mo (µg/L)	Benzene (µg/L)	Toluene (µg/L)	Ethylbenzene (µg/L)	Total Xylenes (µg/L)	COD (mg/L)	TSS (mg/L)	pH
28-Jul-2011	1,573,295	<50	<50	<300	<0.5	<0.5	<0.5	<0.5	<10	5	6.3
25-Aug-2011	1,613,935	77	<50	<300	<0.5	<0.5	<0.5	<0.5	<10	<5	7.1
23-Sep-2011	1,631,273	<50	<50	<300	<0.5	<0.5	<0.5	<0.5	<10	<5	6.7
27-Oct-2011	1,642,277	<50	<50	<300	<0.5	<0.5	<0.5	<0.5	<10	7	7.1
18-Nov-2011	1,676,170	<50	<50	<300	<0.5	<0.5	<0.5	<0.5	<10	<5	7.8
1-Dec-2011	1,694,889	<50	<50	<300	<0.5	<0.5	<0.5	<0.5	<10	<5	6.97
2012											
19-Jan-2012	1,715,163	<50	<50	<300	<0.5	<0.5	<0.5	<0.5	<10	<5	7.02
23-Feb-2012	1,794,185	<50	<50	<300	<0.5	<0.5	<0.5	<0.5	<10	<5	6.98
20-Mar-2012	1,803,832	<50	<50	<300	<0.5	<0.5	<0.5	<0.5	<10	7	7.02
17-Apr-2012	1,876,439	<50	<50	<300	<0.5	<0.5	<0.5	<0.5	NA	NA	6.95
29-May-2012	1,900,111	<50	<50	<300	<0.5	<0.5	<0.5	<0.5	NA	NA	6.89
11-Jun-2012	1,914,130	<50	<50	<300	<0.5	<0.5	<0.5	<0.5	NA	NA	7.1
12-Jul-2012	1,943,456	<50	<50	<300	<0.5	<0.5	<0.5	<0.5	NA	NA	7.3
17-Aug-2012	1,955,438	<50	<52	<310	<0.5	<0.5	<0.5	<0.5	NA	NA	7.04
17-Sep-2012	1,979,852	<50	<54	<330	<0.5	<0.5	<0.5	<0.5	NA	NA	7.02
23-Oct-2012	1,989,022	<50	<49	<290	<0.5	<0.5	<0.5	<0.5	NA	NA	6.95
12-Nov-2012	1,995,170	<50	<50	<300	<0.5	<0.5	<0.5	<0.5	NA	NA	6.90
4-Dec-2012	2,024,040	<50	<49	<290	<0.5	<0.5	<0.5	<0.5	NA	NA	6.86
2013											
7-Jan-2013	2,099,002	<50	<50	<300	<0.5	<0.5	<0.5	<0.5	NA	NA	7.01
14-Feb-2013	2,186,595	<50	<50	<300	<0.5	<0.5	<0.5	<0.5	NA	NA	7.08
14-Mar-2013	2,193,121	<50	<50	<300	<0.5	<0.5	<0.5	<0.5	NA	NA	6.98
12-Apr-2013	2,198,793	<50	<50	<300	<0.5	<0.5	<0.5	<0.5	NA	NA	6.83
10-Jun-2013	2,273,686	<50	<58	<350	<0.5	<0.5	<0.5	<0.5	NA	NA	6.91

Table 3
Effluent Chemical Analytical Results
and Operational History of Remediation System
15101 Freedom Ave, San Leandro, CA

Date	Volume (gallons)	TPH-g (µg/L)	TPH-d (µg/L)	TPH-mo (µg/L)	Benzene (µg/L)	Toluene (µg/L)	Ethylbenzene (µg/L)	Total Xylenes (µg/L)	COD (mg/L)	TSS (mg/L)	pH
5-Jul-2013	2,282,444	<50	<49	<290	<0.5	<0.5	<0.5	<0.5	NA	NA	6.87
15-Aug-2013	2,403,250	<50	<50	<300	<0.5	<0.5	<0.5	<0.5	NA	NA	6.64
24-Sep-2013	2,449,583	<50	<50	<300	<0.5	<0.5	<0.5	<0.5	NA	NA	6.59
28-Oct-2013	2,551,538	<50	<50	<300	<0.5	<0.5	<0.5	<0.5	NA	NA	6.71
14-Nov-2013	2,665,016	<50	<49	<290	<0.5	<0.5	<0.5	<0.5	NA	NA	6.53
6-Dec-2013	2,770,675	<50	<49	<290	<0.5	<0.5	<0.5	<0.5	NA	NA	6.44
2014											
9-Jan-2014	2,884,292	<50	<50	<300	<0.5	<0.5	<0.5	<0.5	NA	NA	6.49
18-Feb-2014	2,953,173	<50	<50	<300	<0.5	<0.5	<0.5	<0.5	NA	NA	6.66
14-Mar-2014	2,977,698	<50	<50	<300	<0.5	<0.5	<0.5	<0.5	NA	NA	6.58
17-Apr-2014	3,035,679	89 Y	<50	<300	<0.5	<0.5	<0.5	<0.5	NA	NA	6.60
15-May-2014	3,054,723	<50	<50	<300	<0.5	<0.5	<0.5	<0.5	NA	NA	6.19
16-Jun-2014	55-Gallon polishing drum replaced due to leak										
17-Jun-2014	3,070,826	<50	<49	<290	<0.5	<0.5	<0.5	<0.5	NA	NA	6.74
21-Jul-2014	3,136,493	<50	<50	<300	<0.5	<0.5	<0.5	<0.5	NA	NA	6.92
13-Aug-2014	3,229,086	<50	<49	<290	<0.5	<0.5	<0.5	<0.5	NA	NA	6.50
9-Sep-2014	3,360,607	<50	<49	<290	<0.5	<0.5	<0.5	<0.5	NA	NA	6.44
13-Oct-2014	3,431,247	<50	<49	<290	<0.5	<0.5	<0.5	<0.5	NA	NA	6.39
18-Nov-2014	3,504,809	<50	<50	<300	<0.5	<0.5	<0.5	<0.5	NA	NA	6.51
8-Dec-2014	3,544,218	<50	<50	<300	<0.5	<0.5	<0.5	<0.5	NA	NA	6.65
2015											
13-Jan-2015	3,560,504	<50	<50	<300	<0.5	<0.5	<0.5	<0.5	NA	NA	6.44
9-Feb-2015	3,560,780	<50	<50	<300	<0.5	<0.5	<0.5	<0.5	NA	NA	6.22
20-Mar-2015	3,560,801	<50	<50	<300	<0.5	<0.5	<0.5	<0.5	NA	NA	6.38
15-Apr-2015	3,575,395	<50	<50	<300	<0.5	<0.5	<0.5	<0.5	NA	NA	6.40
21-May-2015	3,577,714	<50	<50	<300	<0.5	<0.5	<0.5	<0.5	NA	NA	6.29
4-Jun-2015	3,580,407	<50	<50	<300	<0.5	<0.5	<0.5	<0.5	NA	NA	6.66
14-Jul-2015	3,629,420	<50	<50	<300	<0.5	<0.5	<0.5	<0.5	NA	NA	6.34
18-Aug-2015	3,672,646	<50	<50	<300	<0.5	<0.5	<0.5	<0.5	NA	NA	6.21
23-Sep-2015	3,708,165	<50	<50	<300	<0.5	<0.5	<0.5	<0.5	NA	NA	6.32

Table 3
Effluent Chemical Analytical Results
and Operational History of Remediation System
15101 Freedom Ave, San Leandro, CA

Date	Volume (gallons)	TPH-g (µg/L)	TPH-d (µg/L)	TPH-mo (µg/L)	Benzene (µg/L)	Toluene (µg/L)	Ethylbenzene (µg/L)	Total Xylenes (µg/L)	COD (mg/L)	TSS (mg/L)	pH
27-Oct-2015	3,753,333	<50	<50	<300	<0.5	<0.5	<0.5	<0.5	NA	NA	6.50
19-Nov-2015	3,782,192	<50	<50	<300	<0.5	<0.5	<0.5	<0.5	NA	NA	6.43
14-Dec-2015	3,829,993	<50	<50	<300	<0.5	<0.5	<0.5	<0.5	NA	NA	6.63
2016											
12-Jan-2016	3,863,743	<50	<51	<310	<0.5	<0.5	<0.5	<0.5	NA	NA	6.39
5-Feb-2016	3,917,264	<50	<50	<300	<0.5	<0.5	<0.5	<0.5	NA	NA	6.32
7-Mar-2016	3,972,753	<50	<50	<300	<0.5	<0.5	<0.5	<0.5	NA	NA	6.82
4-Aug-2016	3,973,465	<50	<50	<300	<0.5	<0.5	<0.5	<0.5	NA	NA	6.55
22-Sep-2016	3,973,478	<50	61 Y	<300	<0.5	<0.5	<0.5	<0.5	NA	NA	6.51

Note:
NA: Not Available/Not Applicable
< : Less than Laboratory-reporting limit
Y: Sample exhibits chromatographic pattern which does not resemble standard
In October and November 2009 discharge occurred only during MPE events
GWETS and totalizer installed in December 2009.
Week # 1 sampling conducted on Oct 8, 2009
C: Presence confirmed, but RPD between column exceeds 40%
Volume discharged during the October 2009 MPE event was 18,669 gallons
Volume discharged during the November 2009 MPE event was 10,507 gallons
Volume discharged during the December 2009 MPE event was 20,298 gallons
Volume discharged during the February 2010 MPE event was 6,339 gallons
Volume discharged during the March 2010 MPE event was 3,810 gallons
Volume discharged during the June 2010 MPE event was 15,600 gallons
Volume discharged during the August 2010 MPE event was 1,421 gallons
Volume discharged during the October 2010 MPE event was 13,282 gallons
SOMA ceased COD and TSS testing based on a request from OLSA dated April 5, 2012

Table 4
Cumulative Masses of Petroleum Hydrocarbons Removed from
the Groundwater Since Installation of the Treatment System

15101 Freedom Ave, San Leandro, CA

Date	Volume (gallons)	Influent Concentration (µg/L)					Mass removed (pounds)				
		TPH-g	Benzene	Toluene	Ethyl- benzene	Total Xylenes	TPH-g	Benzene	Toluene	Ethyl- benzene	Total Xylenes
2009											
9-Dec-2009	0	Installation of GWETS, began discharging treated groundwater to site sewer main									
2010											
18-Jan-2010	215,453	1,900	79	32.00	2.4	260	3.41	0.14	0.06	0.00	0.47
19-Apr-2010	621,180	2,100	75	28	56	332	10.50	0.40	0.15	0.19	1.59
19-Jul-2010	910,652	56 ^Y	<0.5	<0.5	<0.5	<0.5	10.64	0.40	0.15	0.19	1.59
26-Oct-2010	1,013,700	2,600	200	25	68	405	12.87	0.57	0.17	0.25	1.94
2011											
11-Jan-2011	1,179,075	1,700	80	19	50	295	15.21	0.68	0.20	0.32	2.34
11-Apr-2011	1,364,272	1,200	41	3.3	23	185	17.06	0.75	0.20	0.36	2.63
28-Jul-2011	1,573,295	540	21	2.8	5.4	49	18.00	0.78	0.21	0.37	2.71
27-Oct-2011	1,642,277	<50	1.50	<0.5	<0.5	2.9	18.00	0.78	0.21	0.37	2.71
2012											
19-Jan-2012	1,715,163	110 ^Y	<0.5	<0.5	<0.5	<0.5	18.07	0.78	0.21	0.37	2.71
17-Apr-2012	1,876,439	1,100	60	6.8	24	161	19.54	0.87	0.22	0.40	2.93
12-Jul-2012	1,943,456	320	30	1.6	15	34	19.72	0.88	0.22	0.41	2.95
23-Oct-2012	1,989,022	1,400 ^Y	130	12	42	153	20.25	0.93	0.22	0.42	3.01
2013											
7-Jan-2013	2,099,002	1,500	66	9.8	37	228	21.63	0.99	0.23	0.46	3.22
12-Apr-2013	2,198,793	1,600	110	3.8	64	131	22.96	1.08	0.24	0.51	3.32
5-Jul-2013	2,282,444	680	71	1.8	22	33.9	23.43	1.13	0.24	0.52	3.35
28-Oct-2013	2,551,538	4,900	88	49	150	583	34.41	1.33	0.35	0.86	4.65
2014											
9-Jan-2014	2,884,292	590	17	4.1	9.1	68	36.04	1.38	0.36	0.89	4.84
17-Apr-2014	3,035,679	650	19	0.67	16	50.1	36.86	1.40	0.36	0.91	4.91
21-Jul-2014	3,136,493	1,000	54	1.70	35	71.1	37.70	1.45	0.36	0.94	4.97
13-Oct-2014	3,431,247	370	6.50	0.75	6.30	41	38.61	1.46	0.36	0.95	5.07
2015											
13-Jan-2015	3,560,504	550	21	<0.5	23	19	39.20	1.48	0.36	0.98	5.09
15-Apr-2015	3,575,395	1,300	46	3.30	52	136	39.36	1.49	0.36	0.98	5.10
14-Jul-2015	3,629,420	1,000	31	4.90	24	94	39.81	1.50	0.37	0.99	5.15
27-Oct-2015	3,753,333	420	9.50	0.73	3	24	40.24	1.51	0.37	1.00	5.17
2016											
12-Jan-2016	3,863,743	79	2.20	<0.5	<0.5	<0.5	40.32	1.52	0.37	1.00	5.17
4-Aug-2016	3,973,465	280	0.60	3.00	2.40	12.70	40.57	1.52	0.37	1.00	5.17

Notes:

< : Below laboratory-reporting limit

Y : sample exhibits chromatographic pattern which does not resemble standard

Appendix A

Standard Operating Procedures for Conducting Groundwater Monitoring Activities

Standard Operating Procedures for Conducting Groundwater Monitoring Activities

Water Level and Free-Product Measurements

Prior to measurement of groundwater depth at each well, equalization with the surrounding aquifer must be achieved. Initially, the well cap is removed and the pressure is allowed to dissipate, creating a more stable water table level within the well. After about 10-15 minutes, once the water level in the well stabilizes, the depth to groundwater is measured from the top of the casing to the nearest 0.01 foot using an electric sounder.

For free-product (FP) measurement, an oil-water interface probe is used. When the probe is lowered into the FP, the oil/water light and beeper are continuously on at which point a reading for depth to FP is noted. The probe is lowered further into the well until the water signal is given (light flashes and beeps intermittently). Then the probe is carefully raised until the FP signal is given and the reading is noted. This gives the depth to interface of product and water.

Purging and Field Measurements

Prior to sample collection, each well is purged using a battery-operated, 2-inch-diameter pump (Model ES-60 DC). During purging, groundwater is measured for parameters such as dissolved oxygen (DO), pH, temperature, electrical conductivity (EC), and oxygen-reduction potential (ORP) using a Hanna HI-9828 multi-parameter instrument. Turbidity is measured using a Hanna HI-98703 portable turbidimeter. The equipment is calibrated at the site using standard solutions and procedures provided by the manufacturer.

The pH of groundwater has an effect on the activity of microbial populations in the groundwater. The groundwater temperature affects the metabolic activity of bacteria. The groundwater EC is directly related to the concentration of total dissolved solids (TDS) in solution.

There is a strong correlation between the turbidity level and the biological oxygen demand of natural water bodies. The main purpose for checking the turbidity level is to provide a general overview of the extent of the suspended solids in the groundwater.

ORP is the measure of the potential for an oxidation or reduction process to occur. In the oxidation process, a molecule or ion loses one or several electrons. In the reduction process, a molecule or ion gains one or several electrons. The unit of the redox potential is the volt or millivolt. The most important redox reaction in petroleum-contaminated groundwater is the oxidation of petroleum hydrocarbons in the presence of bacteria and free molecular oxygen. Because the solubility of O₂ in water is low (9 mg/L at 25 °C and 11 mg/L at 5 °C), and

because the rate of O₂ replenishment in subsurface environments is limited, DO can be entirely consumed when the oxidation of only a small amount of petroleum hydrocarbons occurs.

Oxidation of petroleum hydrocarbons can still occur when all the dissolved O₂ in the groundwater is consumed; however, the oxidizing agents (i.e., the constituents that undergo reduction) now become NO₃⁻, MnO₂, Fe (OH)₃, SO₄²⁻ and others (Freeze and Cherry, 1979). As these oxidizing agents are consumed, the groundwater environment becomes more and more reduced. If the process advances far enough, the environment may become so strongly reduced that the petroleum hydrocarbons undergo anaerobic degradation, resulting in the production of methane and carbon dioxide. The concept of oxidation and reduction in terms of changes in oxidation states is illustrated below.

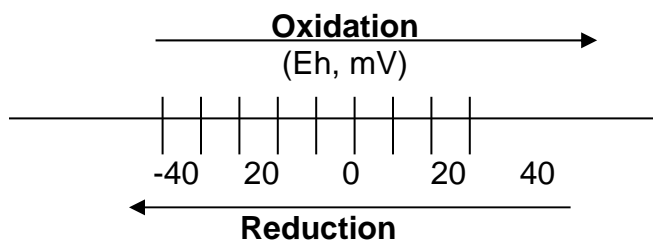

Purging of wells continues until the parameters for DO, pH, temperature, EC, turbidity, and redox stabilize, or three casing volumes are purged.

Once stabilization occurs, the groundwater samples are also tested on-site for ferrous iron (Fe⁺²), nitrate (NO₃⁻), and sulfate (SO₄⁻²) concentrations.

Fe⁺², NO₃⁻, and SO₄⁻² are measured colorimetrically using the Hach Colorimeter Model 890, a microprocessor-controlled photometer suitable for colorimetric testing in the laboratory or the field. The required reagents for each specific test are provided in AccuVac ampuls.

Sampling

For sampling purposes, after purging a disposable polyethylene bailer is used to collect sufficient samples from each monitoring well for laboratory analyses. Groundwater samples are transferred into 40-mL VOA vials and preserved with hydrochloric acid. The vials are sealed to prevent air bubbles from developing within the headspace. For TPH-d analysis, groundwater samples are collected using 1-L, amber, non-preserved glass containers. Samples are placed in an ice-filled cooler and maintained at 4°C. A chain of custody form for all samples is prepared to accompany the samples, which are promptly delivered to a California state-certified analytical laboratory.

Appendix B

Elevations and Coordinates on Monitoring Wells, Field Measurements of Physical and Chemical Parameters of Groundwater Samples, and Groundwater Gradient Calculations

DATE: 1/08/2008
 JOB NUMBER 0208101
 DATE OF SURVEY 1/03/08
 INSTRUMENT LIECA SR520

TABLE OF ELEVATIONS & COORDINATES
 ON MONITORING WELLS
 SOMA ENVIRONMENTAL, PROJECT 15101 FREEDOM DRIVE - SAN LEANDRO

WELL ID#	NORTHING (ft.) LATITUDE	EASTING (ft.) LONGITUDE	ELEVATION (ft.)	DESCRIPTION
MW-1D	2084371.23	6092127.90	54.42	MW-1D NOTCH
	37.708104856	122.123200912	54.94	MW-1D RIM
	37° 42' 29.1" N	122° 07' 23" W	54.74	PAVEMENT
MW-3D	2084303.98	6092183.53	54.10	MW-3D NOTCH
	37.707922851	122.123004590	54.56	MW-3D RIM
	37° 42' 28.5" N	122° 07' 22" W	54.47	PAVEMENT
MW-4D	2084222.77	6092116.37	53.12	MW-4D NOTCH
	37.707696648	122.123231858	53.37	MW-4D RIM
	37° 42' 27.7" N	122° 07' 23" W	53.39	PAVEMENT

BENCH MARK: NGS BENCH MARK NO. HT1871

3.0 KM (1.85 MI) NORTH FROM SAM LORENZO. 1.85 MILES NORTH ALONG INTERSTATE HIGHWAY 580 FROM THE JUNCTION OF STATE HIGHWAY 238 IN SAN LORENZO, IN THE WEST CORNER OF THE CROSSING OF 150TH AVENUE, IN TOP OF THE CONCRETE BRIDGE DECK, 15.5 FEET NORTHWEST OF THE SOUTHWEST BOUND LANES OF THE AVENUE, 10.9 FEET NORTHEAST OF THE SOUTH CORNER OF THE SOUTHWEST END OF THE NORTHWEST CONCRETE GUARDRAIL, 0.7 FOOT NORTHEAST OF THE SOUTHWEST EDGE OF THE DECK, 0.9 FOOT SOUTHEAST OF THE NORTHWEST CONCRETE GUARDRAIL, AND ABOUT LEVEL WITH THE HIGHWAY.

ELEVATION = 58.50 NAVD 88 DATUM

HORIZONTAL AND VERTICAL CONTROL BASED ON HARRINGTON SURVEY DATED 10-12-2004

FD CHABOT A, CALIFORNIA STATE PLAIN COORDINATE SYSTEM, NAD 83, ZONE 3. NORTH 2,088,584.99 EAST 6,093,351.39. LAT N 37°43'11.04190" LONG W 122°07'09.20691", ELEVATION 492.08 NAVD 88.

FD CHABOT B, CALIFORNIA STATE PLAIN COORDINATE SYSTEM, NAD 83, ZONE 3. NORTH 2,087,731.02 EAST 6,094,039.23. . LAT N 37°43'02.71762" LONG W 122°07'00.46339", ELEVATION 442.77 NAVD 88.

DATE: 12/11/2009

JOB# 09039

**TABLE OF ELEVATIONS & COORDINATES
ON MONITORING WELLS**

SOMA ENVIRONMENTAL ENGINEERING
15101 FREEDOM AVENUE
SAN LEANDRO, CA 94579

WELL ID #	NORTHING (FT.) / LATITUDE (D.DEG.)	EASTING (FT.) / LONGITUDE (D.DEG.)	ELEVATION (FT.)	DESCRIPTION
EX-1	2084135.454	6092163.720	47.36	4" PVC NOTCH NORTH SIDE
	37.707459134	122.123062972	47.61	SET PUNCH NORTH SIDE RIM
			47.60	PAVEMENT NORTH SIDE
EX-2	2084082.018	6092130.224	45.96	4" PVC NOTCH NORTH SIDE
	37.707310806	122.123175540	47.04	SET PUNCH NORTH SIDE RIM
			47.00	CONCRETE NORTH SIDE
MPE-1	2084213.168	6092125.258	51.96	4" PVC NOTCH NORTH SIDE
	37.707670702	122.123200567	52.49	SET PUNCH NORTH SIDE RIM
			52.51	CONCRETE NORTH SIDE
MPE-2	2084293.133	6092171.374	53.72	4" PVC NOTCH NORTH SIDE
	37.707892479	122.123045970	54.29	SET PUNCH NORTH SIDE RIM
			54.27	PAVEMENT NORTH SIDE

HORIZONTAL AND VERTICAL CONTROL
SURVEY BASED ON PREVIOUS SURVEY BY HARRINGTON SURVEY INC. DATED: 2/21/2008
COORDINATE VALUES ARE BASED ON THE CALIFORNIA COORDINATE SYSTEM, ZONE 3, NAD83.
ELEVATIONS ARE NAVD 88 DATUM.

MW-2, PUNCH
NORTHING 2,084323.44, EASTING 6,092063.77, ELEVATION 52.92

MW-4 PUNCH
NORTHING 2,084250.55, EASTING 6,092124.46, ELEVATION 53.74

EQUIPMENT USED: TRIMBLE S6

Edgis Land Surveying
Land Surveying and mapping
1374 Garland Avenue, Clovis, CA 93612
Phone (559) 906-3554 Fax (559) 292-0560
email: edgis@aol.com



Eduardo A. Espinoza
1 of 1



ENVIRONMENTAL ENGINEERING, INC

Well No.: MW-1
 Casing Diameter: 4 inches
 Depth of Well: 30.20 feet
 Top of Casing Elevation: 54.46 feet
 Depth to Groundwater: 22.87 feet
 Groundwater Elevation: 31.59 feet
 Water Column Height: 7.33 feet
 Purged Volume: 6 gallons

Project No.: 2551
 Address: 15101 Freedom Ave.
 San Leandro, CA
 Date: December 14, 2016
 Sampler: Davoud Bazrpash

Purging Method: Bailer Pump

Sampling Method: Bailer Pump

Color: Yes No Describe: _____

Sheen: Yes No Describe: _____

Odor: Yes No Describe: _____

Field Measurements:

Time	Volume (gallons)	pH	Temp °C	E.C. (µS/cm)
START 10:15				
10:17	1.5	5.67	20.2	152
10:22	3	5.19	20.6	98
10:25	6	5.17	20.8	109
START SAMPLING 10:30				



ENVIRONMENTAL ENGINEERING, INC

Well No.: MW-2
 Casing Diameter: 4 inches
 Depth of Well: 30.15 feet
 Top of Casing Elevation: 52.41 feet
 Depth to Groundwater: 20.73 feet
 Groundwater Elevation: 31.68 feet
 Water Column Height: 9.42 feet
 Purged Volume: 6 gallons

Project No.: 2551
 Address: 15101 Freedom Ave.
 San Leandro, CA
 Date: December 14, 2016
 Sampler: Davoud Bazrpush

Purging Method: Bailer Pump

Sampling Method: Bailer Pump

Color: Yes No Describe: cloudy

Sheen: Yes No Describe: _____

Odor: Yes No Describe: _____

Field Measurements:

Time	Volume (gallons)	pH	Temp °C	E.C. (µS/cm)
<u>STARTING</u>				
<u>9:21</u>	<u>1.5</u>	<u>5.88</u>	<u>21.1</u>	<u>370</u>
<u>9:25</u>	<u>3</u>	<u>5.57</u>	<u>21.0</u>	<u>180</u>
<u>9:30</u>	<u>6</u>	<u>5.46</u>	<u>20.9</u>	<u>201</u>
<u>SAMPLING 9:50</u>				



ENVIRONMENTAL ENGINEERING, INC

Well No.: MW-3
 Casing Diameter: 4 inches
 Depth of Well: 29.95 feet
 Top of Casing Elevation: 53.91 feet
 Depth to Groundwater: 22.40 feet
 Groundwater Elevation: 31.51 feet
 Water Column Height: 7.55 feet
 Purged Volume: 6 gallons

Project No.: 2551
 Address: 15101 Freedom Ave.
 San Leandro, CA
 Date: December 14, 2016
 Sampler: Davoud Bazrpash

Purging Method: Bailer Pump

Sampling Method: Bailer Pump

Color: Yes No Describe: _____

Sheen: Yes No Describe: _____

Odor: Yes No Describe: _____

Field Measurements:

Time	Volume (gallons)	pH	Temp °C	E.C. (µS/cm)
START				
12:03	2	6.57	20.0	446
12:08	4	6.53	20.4	455
12:12	6	6.31	20.6	460
START SAMPLING				
12:20				



ENVIRONMENTAL ENGINEERING, INC

Well No.: MW-4
 Casing Diameter: 4 inches
 Depth of Well: 30.20 feet
 Top of Casing Elevation: 53.31 feet
 Depth to Groundwater: 21.75 feet
 Groundwater Elevation: 31.56 feet
 Water Column Height: 8.45 feet
 Purged Volume: 6 gallons

Project No.: 2551
 Address: 15101 Freedom Ave.
 San Leandro, CA
 Date: December 14, 2016
 Sampler: Davoud Bazrpash

Purging Method: Bailer Pump

Sampling Method: Bailer Pump

Color: Yes No Describe: _____
 Sheen: Yes No Describe: _____
 Odor: Yes No Describe: _____

Field Measurements:

Time	Volume (gallons)	pH	Temp °C	E.C. (µS/cm)
START				
3:22	2	6.45	19.9	566
3:26	4	6.50	20.1	571
3:29	6	6.47	20.0	592
START SAMPLING				
3:35				



ENVIRONMENTAL ENGINEERING, INC

Well No.: MW-5
 Casing Diameter: 4 inches
 Depth of Well: 29.85 feet
 Top of Casing Elevation: 50.53 feet
 Depth to Groundwater: 19.12 feet
 Groundwater Elevation: 31.41 feet
 Water Column Height: 10.73 feet
 Purged Volume: 6 gallons

Project No.: 2551
 Address: 15101 Freedom Ave.
 San Leandro, CA
 Date: December 14, 2016
 Sampler: Davoud Bazrpash

Purging Method: Bailer Pump
 Sampling Method: Bailer Pump

Color: Yes No Describe: _____
 Sheen: Yes No Describe: _____
 Odor: Yes No Describe: _____

Field Measurements:

Time	Volume (gallons)	pH	Temp °C	E.C. (µS/cm)
STARTING				
12:43	2	6.31	21.3	931
12:47	4	6.45	21.5	950
12:50	6	6.51	21.5	917
START SAMPLING (1PM) 12:00				



ENVIRONMENTAL ENGINEERING, INC

Well No.: MW-6
 Casing Diameter: 4 inches
 Depth of Well: 27.45 feet
 Top of Casing Elevation: 45.82 feet
 Depth to Groundwater: 15.50 feet
 Groundwater Elevation: 30.32 feet
 Water Column Height: 11.95 feet
 Purged Volume: 5 gallons

Project No.: 2551
 Address: 15101 Freedom Ave.
 San Leandro, CA
 Date: December 15, 2016
 Sampler: Davoud Bazrpush

Purging Method: Bailer Pump

Sampling Method: Bailer Pump

Color: Yes No Describe: _____

Sheen: Yes No Describe: _____

Odor: Yes No Describe: _____

Field Measurements:

Time	Volume (gallons)	pH	Temp °C	E.C. (µS/cm)
START				
8:45	2	6.33	20.7	802
8:49	4	6.38	20.9	764
8:54	5	6.37	20.7	762
START SAMPLING				
9:25				



ENVIRONMENTAL ENGINEERING, INC

Well No.: MW-7
Casing Diameter: 2 inches
Depth of Well: 20.80 feet
Top of Casing Elevation: 44.74 feet
Depth to Groundwater: 13.78 feet
Groundwater Elevation: 30.96 feet
Water Column Height: 7.02 feet
Purged Volume: 3.5 gallons

Project No.: 2551
Address: 15101 Freedom Ave.
San Leandro, CA
Date: December 15, 2016
Sampler: Davoud Bazrpash

Purging Method: Bailer Pump

Sampling Method: Bailer Pump

Color: Yes No Describe: _____

Sheen: Yes No Describe: _____

Odor: Yes No Describe: _____

Field Measurements:

Time	Volume (gallons)	pH	Temp °C	E.C. (µS/cm)
START				
10:19	1.5	5.77	19.3	931
11:22	2.5	6.31	19.3	987
11:25	3.5	6.27	19.5	966
START SAMPLING				
11:45				



ENVIRONMENTAL ENGINEERING, INC

Well No.: MW-10R Project No.: 2551
Casing Diameter: 4 inches Address: 15101 Freedom Ave.
Depth of Well: 25.95 feet San Leandro, CA
Top of Casing Elevation: 45.13 feet Date: December 15, 2016
Depth to Groundwater: 14.92 feet Sampler: Davoud Bazrpash
Groundwater Elevation: 30.21 feet
Water Column Height: 11.03 feet
Purged Volume: 4 gallons

Purging Method: Bailer Pump
Sampling Method: Bailer Pump
Color: Yes No Describe: _____
Sheen: Yes No Describe: _____
Odor: Yes No Describe: _____

Field Measurements:

Time	Volume (gallons)	pH	Temp °C	E.C. (µS/cm)
START				
9:51	1.5	5.95	18.5	927
9:56	2.5	6.39	18.9	975
10:00	4.0	6.50	19.0	971
START SAMPLING				
10:10				



ENVIRONMENTAL ENGINEERING, INC

Well No.: MW-11
Casing Diameter: 2 inches
Depth of Well: 28.50 feet
Top of Casing Elevation: 42.45 feet
Depth to Groundwater: 12.30 feet
Groundwater Elevation: 30.15 feet
Water Column Height: 16.2 feet
Purged Volume: 6 gallons

Project No.: 2551
Address: 15101 Freedom Ave.
San Leandro, CA
Date: December 15, 2016
Sampler: Davoud Bazrpash

Purging Method: Bailer Pump

Sampling Method: Bailer Pump

Color: Yes No Describe: _____

Sheen: Yes No Describe: _____

Odor: Yes No Describe: _____

Field Measurements:

Time	Volume (gallons)	pH	Temp °C	E.C. (µS/cm)
START	<u>1.5</u>			
<u>10:41</u>	<u>1.5</u>	<u>6.36</u>	<u>18.2</u>	<u>802</u>
<u>10:45</u>	<u>3</u>	<u>6.57</u>	<u>18.5</u>	<u>802</u>
<u>10:48</u>	<u>6</u>	<u>6.60</u>	<u>18.7</u>	<u>801</u>
START SAMPLING				
<u>10:55</u>				



ENVIRONMENTAL ENGINEERING, INC

Well No.: EX-1 Project No.: 2551
 Casing Diameter: 4 inches Address: 15101 Freedom Ave.
 Depth of Well: 29.15 feet San Leandro, CA
 Top of Casing Elevation: 47.36 feet Date: December 14, 2016
 Depth to Groundwater: 0 @ 15.90 feet Sampler: Davoud Bazrpash
 Groundwater Elevation: 31.46 feet
 Water Column Height: 13.25 feet
 Purged Volume: 6 gallons

Purging Method: Bailer Pump
 Sampling Method: Bailer Pump
 Color: Yes No Describe: _____
 Sheen: Yes No Describe: _____
 Odor: Yes No Describe: _____

Field Measurements:

Time	Volume (gallons)	pH	Temp °C	E.C. (µS/cm)
START				
4:10	2	6.58	20.3	887
4:14	4	6.61	20.5	864
4:17	6	6.65	20.6	877
START SAMPLING				
4:25				



ENVIRONMENTAL ENGINEERING, INC

Well No.: EX-2
 Casing Diameter: 4 inches
 Depth of Well: - feet
 Top of Casing Elevation: 45.96 feet
 Depth to Groundwater: - feet
 Groundwater Elevation: - feet
 Water Column Height: - feet
 Purged Volume: - gallons

Project No.: 2551
 Address: 15101 Freedom Ave.
 San Leandro, CA
 Date: December 14, 2016
 Sampler: Davoud Bazrpash

Purging Method: Bailer Pump Not Purged
 Sampling Method: Bailer Pump Not Sampled

Color: Yes No Describe: Unknown
 Sheen: Yes No Describe: Unknown
 Odor: Yes No Describe: Unknown

Field Measurements:

Time	Volume (gallons)	pH	Temp °C	E.C. (µS/cm)
Groundwater inaccessible due to the presence of downhole pump in well. This well is a part of existing groundwater extraction & treatment system, it is inoperational now.				



ENVIRONMENTAL ENGINEERING, INC

Well No.: MPE-1 Project No.: 2551
 Casing Diameter: 4 inches Address: 15101 Freedom Ave.
 Depth of Well: 29.95 feet San Leandro, CA
 Top of Casing Elevation: 51.96 feet Date: December 14, 2016
 Depth to Groundwater: 20.32 feet Sampler: Davoud Bazrpash
 Groundwater Elevation: 31.64 feet
 Water Column Height: 9.63 feet
 Purged Volume: 6 gallons

Purging Method: Bailer Pump
 Sampling Method: Bailer Pump
 Color: Yes No Describe: _____
 Sheen: Yes No Describe: _____
 Odor: Yes No Describe: _____

Field Measurements:

Time	Volume (gallons)	pH	Temp °C	E.C. (µS/cm)
<u>STARTING</u>				
<u>1:23</u>	<u>2</u>	<u>6.60</u>	<u>19.9</u>	<u>681</u>
<u>13:</u>	<u>4</u>	<u>6.81</u>	<u>19.9</u>	<u>655</u>
<u>13:</u>	<u>6</u>	<u>6.88</u>	<u>20.0</u>	<u>661</u>
<u>START SAMPLING</u>				
<u>13:35</u>				



ENVIRONMENTAL ENGINEERING, INC

Well No.: MPE-2
 Casing Diameter: 4 inches
 Depth of Well: 30.00 feet
 Top of Casing Elevation: 53.72 feet
 Depth to Groundwater: 22.22 feet
 Groundwater Elevation: 31.50 feet
 Water Column Height: 7.78 feet
 Purged Volume: 6 gallons

Project No.: 2551
 Address: 15101 Freedom Ave.
 San Leandro, CA
 Date: December 14, 2016
 Sampler: Davoud Bazrpash

Purging Method: Bailer Pump

Sampling Method: Bailer Pump

Color: Yes No Describe: _____
 Sheen: Yes No Describe: _____
 Odor: Yes No Describe: _____

Field Measurements:

Time	Volume (gallons)	pH	Temp °C	E.C. (µS/cm)
STARTING				
11:32	2	6.14	20.8	992
11:36	4	6.27	20.6	999
11:40	6	6.34	20.9	1001
START SAMPLING				
11:45				

EPA On-line Tools for Site Assessment Calculation

Hydraulic Gradient -- Magnitude and Direction

Gradient Calculation from fitting a plane to as many as thirty points

$$\begin{aligned}
 a x_1 + b y_1 + c &= h_1 \\
 a x_2 + b y_2 + c &= h_2 \\
 a x_3 + b y_3 + c &= h_3 \\
 &\dots \\
 a x_{30} + b y_{30} + c &= h_{30}
 \end{aligned}$$

where (x_i, y_i) are the coordinates of the well and h_i is the head

$i = 1, 2, 3, \dots, 30$

The coefficients a , b , and c are calculated by a least-squares fitting of the the data to a plane

The gradient is calculated from the square root of $(a^2 + b^2)$ and the angle from the arctangent of a/b or b/a depending on the quadrant

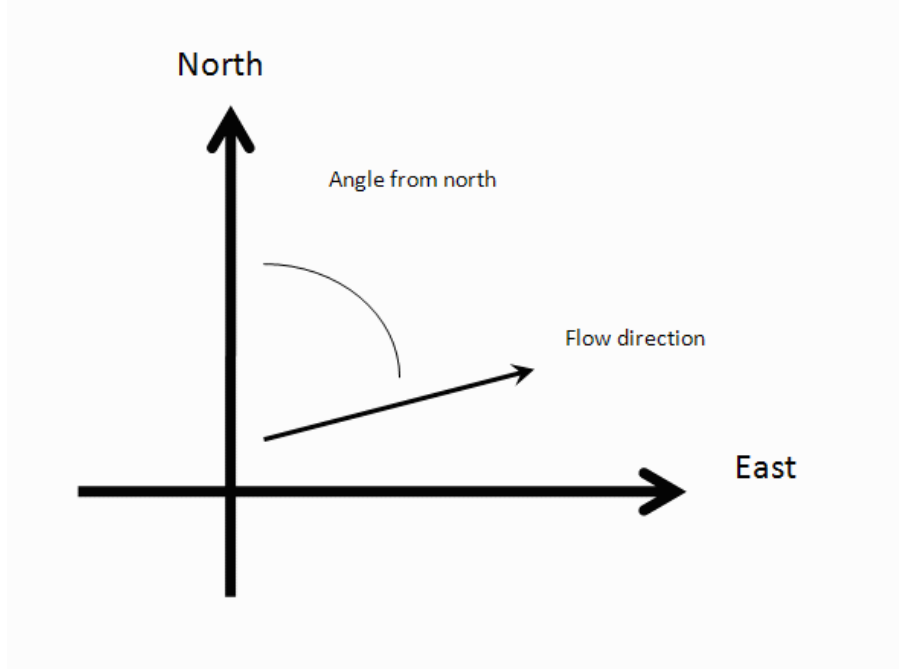

Inputs

Site Name

Date

Calculation basis

Coordinates

I.D.	x-coordinate	y-coordinate	head	ft
1) MW-1	6092119.016	2084364.691	31.59	
2) MW-2	6092063.978	2084323.224	31.68	
3) MW-3	6092176.317	2084298.343	31.51	
4) MW-4	6092124.294	2084251.598	31.56	
5) MW-5	6092177.071	2084206.361	31.41	
6) MW-6	6092140.881	2084072.911	30.32	
7) MW-7	6092290.918	2084008.071	30.96	
8) MW-10R	6092182.374	2083967.53	30.21	
9) MW-11	6092224.568	2083926.493	30.15	
10) EX-1	6092163.5	2084133.982	31.46	
11) MPE-1	6092125.048	2084212.393	31.64	
12) MPE-2	6092171.793	2084292.312	31.5	
13)				
14)				
15)				
16)				

17)				
18)				
19)				
20)				
21)				
22)				
23)				
24)				
25)				
26)				
27)				
28)				
29)				
30)				

Results

Number of Points Used in Calculation	12
Max. Difference Between Head Values	0.4663
Gradient Magnitude (i)	0.004658
Flow direction as degrees from North (positive y axis)	207.7
Coefficient of Determination (R^2)	0.801

WCMS

Last updated on 2/23/2016

Appendix C

Laboratory Reports and Chain of Custody Forms
for the Fourth Quarter 2016 Monitoring Event



Curtis & Tompkins, Ltd., Analytical Laboratories, Since 1878

2323 Fifth Street, Berkeley, CA 94710, Phone (510) 486-0900

Laboratory Job Number 284345
ANALYTICAL REPORT

SOMA Environmental Engineering Inc.
6620 Owens Dr.
Pleasanton, CA 94588

Project : 2551
Location : 15101 Freedom Avenue San Leandro
Level : II

Table with 2 columns: Sample ID and Lab ID. Rows include MW-1 through MW-11, MPE-1 through MPE-2, and EX-1.

This data package has been reviewed for technical correctness and completeness. Release of this data has been authorized by the Laboratory Manager or the Manager's designee, as verified by the following signature. The results contained in this report meet all requirements of NELAC and pertain only to those samples which were submitted for analysis. This report may be reproduced only in its entirety.

Signature: Tracy Babjar
Tracy Babjar
Project Manager
tracy.babjar@ctberk.com
(510) 204-2226 Ext 13107

Date: 12/21/2016

CASE NARRATIVE

Laboratory number: 284345
Client: SOMA Environmental Engineering Inc.
Project: 2551
Location: 15101 Freedom Avenue San Leandro
Request Date: 12/15/16
Samples Received: 12/15/16

This data package contains sample and QC results for twelve water samples, requested for the above referenced project on 12/15/16. The samples were received cold and intact.

Volatile Organics by GC/MS (EPA 8260B):

MW-10R (lab # 284345-008) was diluted due to high non-target analytes. No other analytical problems were encountered.

COOLER RECEIPT CHECKLIST



Login # 284345 Date Received 12/15/16 Number of coolers 0
 Client SOMA Project 2551

Date Opened 12/15 By (print) DTN (sign) [Signature]
 Date Logged in ↓ By (print) ↓ (sign) [Signature]
 Date Labeled ↓ By (print) HP (sign) [Signature]

1. Did cooler come with a shipping slip (airbill, etc) _____ YES NO
- Shipping info _____
- 2A. Were custody seals present? YES (circle) on cooler on samples NO
 How many _____ Name _____ Date _____
- 2B. Were custody seals intact upon arrival? _____ YES NO N/A
3. Were custody papers dry and intact when received? _____ YES NO
4. Were custody papers filled out properly (ink, signed, etc)? _____ YES NO
5. Is the project identifiable from custody papers? (If so fill out top of form) _____ YES NO
6. Indicate the packing in cooler: (if other, describe) _____

- Bubble Wrap Foam blocks Bags None
 Cloth material Cardboard Styrofoam Paper towels

7. Temperature documentation: * Notify PM if temperature exceeds 6°C
- Type of ice used: Wet Blue/Gel None Temp(°C) 4.1
- Temperature blank(s) included? Thermometer# _____ IR Gun# A
- Samples received on ice directly from the field. Cooling process had begun

8. Were Method 5035 sampling containers present? _____ YES NO
 If YES, what time were they transferred to freezer? _____
9. Did all bottles arrive unbroken/unopened? _____ YES NO
10. Are there any missing / extra samples? _____ YES NO
11. Are samples in the appropriate containers for indicated tests? _____ YES NO
12. Are sample labels present, in good condition and complete? _____ YES NO
13. Do the sample labels agree with custody papers? _____ YES NO
14. Was sufficient amount of sample sent for tests requested? _____ YES NO
15. Are the samples appropriately preserved? _____ YES NO N/A
16. Did you check preservatives for all bottles for each sample? _____ YES NO N/A
17. Did you document your preservative check? (pH strip lot# _____) YES NO N/A
18. Did you change the hold time in LIMS for unpreserved VOAs? _____ YES NO N/A
19. Did you change the hold time in LIMS for preserved terracores? _____ YES NO N/A
20. Are bubbles > 6mm absent in VOA samples? _____ YES NO N/A
21. Was the client contacted concerning this sample delivery? _____ YES NO
 If YES, Who was called? _____ By _____ Date: _____

COMMENTS

Client Sample ID : MW-6

Laboratory Sample ID :

284345-006

Analyte	Result	Flags	RL	Units	Basis	IDF	Method	Prep Method
Gasoline C7-C12	1,600		50	ug/L	As Recd	1.000	EPA 8260B	EPA 5030B
Benzene	4.1		0.50	ug/L	As Recd	1.000	EPA 8260B	EPA 5030B
Ethylbenzene	1.2		0.50	ug/L	As Recd	1.000	EPA 8260B	EPA 5030B
m,p-Xylenes	2.1		0.50	ug/L	As Recd	1.000	EPA 8260B	EPA 5030B

Client Sample ID : MW-7

Laboratory Sample ID :

284345-007

Analyte	Result	Flags	RL	Units	Basis	IDF	Method	Prep Method
Gasoline C7-C12	1,800		50	ug/L	As Recd	1.000	EPA 8260B	EPA 5030B
MTBE	1.4		0.50	ug/L	As Recd	1.000	EPA 8260B	EPA 5030B
Ethylbenzene	3.4		0.50	ug/L	As Recd	1.000	EPA 8260B	EPA 5030B
m,p-Xylenes	1.9		0.50	ug/L	As Recd	1.000	EPA 8260B	EPA 5030B

Client Sample ID : MW-10R

Laboratory Sample ID :

284345-008

Analyte	Result	Flags	RL	Units	Basis	IDF	Method	Prep Method
Gasoline C7-C12	5,200		200	ug/L	As Recd	4.000	EPA 8260B	EPA 5030B
Ethylbenzene	170		2.0	ug/L	As Recd	4.000	EPA 8260B	EPA 5030B
m,p-Xylenes	200		2.0	ug/L	As Recd	4.000	EPA 8260B	EPA 5030B
o-Xylene	6.5		2.0	ug/L	As Recd	4.000	EPA 8260B	EPA 5030B

Client Sample ID : MW-11

Laboratory Sample ID :

284345-009

Analyte	Result	Flags	RL	Units	Basis	IDF	Method	Prep Method
Gasoline C7-C12	65		50	ug/L	As Recd	1.000	EPA 8260B	EPA 5030B
Ethylbenzene	1.4		0.50	ug/L	As Recd	1.000	EPA 8260B	EPA 5030B
m,p-Xylenes	1.7		0.50	ug/L	As Recd	1.000	EPA 8260B	EPA 5030B

Client Sample ID : MPE-1

Laboratory Sample ID :

284345-010

Analyte	Result	Flags	RL	Units	Basis	IDF	Method	Prep Method
Benzene	0.68		0.50	ug/L	As Recd	1.000	EPA 8260B	EPA 5030B
m,p-Xylenes	0.82		0.50	ug/L	As Recd	1.000	EPA 8260B	EPA 5030B

Client Sample ID : MPE-2

Laboratory Sample ID :

284345-011

Analyte	Result	Flags	RL	Units	Basis	IDF	Method	Prep Method
Gasoline C7-C12	7,100		310	ug/L	As Recd	6.250	EPA 8260B	EPA 5030B
tert-Butyl Alcohol (TBA)	150		63	ug/L	As Recd	6.250	EPA 8260B	EPA 5030B
MTBE	6.0		3.1	ug/L	As Recd	6.250	EPA 8260B	EPA 5030B
Benzene	490		3.1	ug/L	As Recd	6.250	EPA 8260B	EPA 5030B
Ethylbenzene	230		3.1	ug/L	As Recd	6.250	EPA 8260B	EPA 5030B
m,p-Xylenes	140		3.1	ug/L	As Recd	6.250	EPA 8260B	EPA 5030B

Client Sample ID : EX-1

Laboratory Sample ID :

284345-012

Analyte	Result	Flags	RL	Units	Basis	IDF	Method	Prep Method
tert-Butyl Alcohol (TBA)	15		10	ug/L	As Recd	1.000	EPA 8260B	EPA 5030B
Ethyl tert-Butyl Ether (ETBE)	0.81		0.50	ug/L	As Recd	1.000	EPA 8260B	EPA 5030B
MTBE	2.1		0.50	ug/L	As Recd	1.000	EPA 8260B	EPA 5030B

Purgeable Organics by GC/MS

Lab #: 284345	Location: 15101 Freedom Avenue San Leandro
Client: SOMA Environmental Engineering Inc.	Prep: EPA 5030B
Project#: 2551	Analysis: EPA 8260B
Field ID: MW-1	Batch#: 242552
Lab ID: 284345-001	Sampled: 12/14/16
Matrix: Water	Received: 12/15/16
Units: ug/L	Analyzed: 12/19/16
Diln Fac: 1.000	

Analyte	Result	RL
Gasoline C7-C12	180	50
tert-Butyl Alcohol (TBA)	ND	10
Isopropyl Ether (DIPE)	ND	0.50
Ethyl tert-Butyl Ether (ETBE)	ND	0.50
Methyl tert-Amyl Ether (TAME)	ND	0.50
Ethanol	ND	1,000
MTBE	ND	0.50
1,2-Dichloroethane	ND	0.50
Benzene	ND	0.50
Toluene	ND	0.50
1,2-Dibromoethane	ND	0.50
Ethylbenzene	ND	0.50
m,p-Xylenes	ND	0.50
o-Xylene	ND	0.50

Surrogate	%REC	Limits
Dibromofluoromethane	100	80-128
1,2-Dichloroethane-d4	102	75-139
Toluene-d8	99	80-120
Bromofluorobenzene	98	80-120

ND= Not Detected
 RL= Reporting Limit

Purgeable Organics by GC/MS

Lab #: 284345	Location: 15101 Freedom Avenue San Leandro
Client: SOMA Environmental Engineering Inc.	Prep: EPA 5030B
Project#: 2551	Analysis: EPA 8260B
Field ID: MW-2	Batch#: 242498
Lab ID: 284345-002	Sampled: 12/14/16
Matrix: Water	Received: 12/15/16
Units: ug/L	Analyzed: 12/16/16
Diln Fac: 1.000	

Analyte	Result	RL
Gasoline C7-C12	110	50
tert-Butyl Alcohol (TBA)	ND	10
Isopropyl Ether (DIPE)	ND	0.50
Ethyl tert-Butyl Ether (ETBE)	ND	0.50
Methyl tert-Amyl Ether (TAME)	ND	0.50
Ethanol	ND	1,000
MTBE	ND	0.50
1,2-Dichloroethane	ND	0.50
Benzene	ND	0.50
Toluene	ND	0.50
1,2-Dibromoethane	ND	0.50
Ethylbenzene	ND	0.50
m,p-Xylenes	ND	0.50
o-Xylene	ND	0.50

Surrogate	%REC	Limits
Dibromofluoromethane	100	80-128
1,2-Dichloroethane-d4	100	75-139
Toluene-d8	100	80-120
Bromofluorobenzene	101	80-120

ND= Not Detected
 RL= Reporting Limit

Purgeable Organics by GC/MS

Lab #: 284345	Location: 15101 Freedom Avenue San Leandro
Client: SOMA Environmental Engineering Inc.	Prep: EPA 5030B
Project#: 2551	Analysis: EPA 8260B
Field ID: MW-3	Batch#: 242552
Lab ID: 284345-003	Sampled: 12/14/16
Matrix: Water	Received: 12/15/16
Units: ug/L	Analyzed: 12/20/16
Diln Fac: 1.429	

Analyte	Result	RL
Gasoline C7-C12	3,300	71
tert-Butyl Alcohol (TBA)	ND	14
Isopropyl Ether (DIPE)	ND	0.71
Ethyl tert-Butyl Ether (ETBE)	ND	0.71
Methyl tert-Amyl Ether (TAME)	ND	0.71
Ethanol	ND	1,400
MTBE	ND	0.71
1,2-Dichloroethane	ND	0.71
Benzene	30	0.71
Toluene	ND	0.71
1,2-Dibromoethane	ND	0.71
Ethylbenzene	63	0.71
m,p-Xylenes	93	0.71
o-Xylene	1.6	0.71

Surrogate	%REC	Limits
Dibromofluoromethane	98	80-128
1,2-Dichloroethane-d4	99	75-139
Toluene-d8	100	80-120
Bromofluorobenzene	97	80-120

ND= Not Detected
 RL= Reporting Limit

Purgeable Organics by GC/MS

Lab #: 284345	Location: 15101 Freedom Avenue San Leandro
Client: SOMA Environmental Engineering Inc.	Prep: EPA 5030B
Project#: 2551	Analysis: EPA 8260B
Field ID: MW-4	Batch#: 242498
Lab ID: 284345-004	Sampled: 12/14/16
Matrix: Water	Received: 12/15/16
Units: ug/L	Analyzed: 12/16/16
Diln Fac: 1.000	

Analyte	Result	RL
Gasoline C7-C12	460	50
tert-Butyl Alcohol (TBA)	16	10
Isopropyl Ether (DIPE)	ND	0.50
Ethyl tert-Butyl Ether (ETBE)	ND	0.50
Methyl tert-Amyl Ether (TAME)	ND	0.50
Ethanol	ND	1,000
MTBE	4.6	0.50
1,2-Dichloroethane	ND	0.50
Benzene	23	0.50
Toluene	ND	0.50
1,2-Dibromoethane	ND	0.50
Ethylbenzene	ND	0.50
m,p-Xylenes	4.8	0.50
o-Xylene	ND	0.50

Surrogate	%REC	Limits
Dibromofluoromethane	102	80-128
1,2-Dichloroethane-d4	98	75-139
Toluene-d8	98	80-120
Bromofluorobenzene	98	80-120

ND= Not Detected
 RL= Reporting Limit

Purgeable Organics by GC/MS

Lab #: 284345	Location: 15101 Freedom Avenue San Leandro
Client: SOMA Environmental Engineering Inc.	Prep: EPA 5030B
Project#: 2551	Analysis: EPA 8260B
Field ID: MW-5	Batch#: 242498
Lab ID: 284345-005	Sampled: 12/14/16
Matrix: Water	Received: 12/15/16
Units: ug/L	Analyzed: 12/16/16
Diln Fac: 1.000	

Analyte	Result	RL
Gasoline C7-C12	1,200	50
tert-Butyl Alcohol (TBA)	ND	10
Isopropyl Ether (DIPE)	ND	0.50
Ethyl tert-Butyl Ether (ETBE)	ND	0.50
Methyl tert-Amyl Ether (TAME)	ND	0.50
Ethanol	ND	1,000
MTBE	0.87	0.50
1,2-Dichloroethane	ND	0.50
Benzene	1.4	0.50
Toluene	ND	0.50
1,2-Dibromoethane	ND	0.50
Ethylbenzene	1.8	0.50
m,p-Xylenes	ND	0.50
o-Xylene	ND	0.50

Surrogate	%REC	Limits
Dibromofluoromethane	102	80-128
1,2-Dichloroethane-d4	103	75-139
Toluene-d8	98	80-120
Bromofluorobenzene	97	80-120

ND= Not Detected
 RL= Reporting Limit

Purgeable Organics by GC/MS

Lab #: 284345	Location: 15101 Freedom Avenue San Leandro
Client: SOMA Environmental Engineering Inc.	Prep: EPA 5030B
Project#: 2551	Analysis: EPA 8260B
Field ID: MW-6	Batch#: 242552
Lab ID: 284345-006	Sampled: 12/15/16
Matrix: Water	Received: 12/15/16
Units: ug/L	Analyzed: 12/19/16
Diln Fac: 1.000	

Analyte	Result	RL
Gasoline C7-C12	1,600	50
tert-Butyl Alcohol (TBA)	ND	10
Isopropyl Ether (DIPE)	ND	0.50
Ethyl tert-Butyl Ether (ETBE)	ND	0.50
Methyl tert-Amyl Ether (TAME)	ND	0.50
Ethanol	ND	1,000
MTBE	ND	0.50
1,2-Dichloroethane	ND	0.50
Benzene	4.1	0.50
Toluene	ND	0.50
1,2-Dibromoethane	ND	0.50
Ethylbenzene	1.2	0.50
m,p-Xylenes	2.1	0.50
o-Xylene	ND	0.50

Surrogate	%REC	Limits
Dibromofluoromethane	99	80-128
1,2-Dichloroethane-d4	100	75-139
Toluene-d8	100	80-120
Bromofluorobenzene	97	80-120

ND= Not Detected
 RL= Reporting Limit

Purgeable Organics by GC/MS

Lab #: 284345	Location: 15101 Freedom Avenue San Leandro
Client: SOMA Environmental Engineering Inc.	Prep: EPA 5030B
Project#: 2551	Analysis: EPA 8260B
Field ID: MW-7	Batch#: 242498
Lab ID: 284345-007	Sampled: 12/15/16
Matrix: Water	Received: 12/15/16
Units: ug/L	Analyzed: 12/16/16
Diln Fac: 1.000	

Analyte	Result	RL
Gasoline C7-C12	1,800	50
tert-Butyl Alcohol (TBA)	ND	10
Isopropyl Ether (DIPE)	ND	0.50
Ethyl tert-Butyl Ether (ETBE)	ND	0.50
Methyl tert-Amyl Ether (TAME)	ND	0.50
Ethanol	ND	1,000
MTBE	1.4	0.50
1,2-Dichloroethane	ND	0.50
Benzene	ND	0.50
Toluene	ND	0.50
1,2-Dibromoethane	ND	0.50
Ethylbenzene	3.4	0.50
m,p-Xylenes	1.9	0.50
o-Xylene	ND	0.50

Surrogate	%REC	Limits
Dibromofluoromethane	99	80-128
1,2-Dichloroethane-d4	100	75-139
Toluene-d8	98	80-120
Bromofluorobenzene	99	80-120

ND= Not Detected
 RL= Reporting Limit

Purgeable Organics by GC/MS

Lab #: 284345	Location: 15101 Freedom Avenue San Leandro
Client: SOMA Environmental Engineering Inc.	Prep: EPA 5030B
Project#: 2551	Analysis: EPA 8260B
Field ID: MW-10R	Batch#: 242498
Lab ID: 284345-008	Sampled: 12/15/16
Matrix: Water	Received: 12/15/16
Units: ug/L	Analyzed: 12/16/16
Diln Fac: 4.000	

Analyte	Result	RL
Gasoline C7-C12	5,200	200
tert-Butyl Alcohol (TBA)	ND	40
Isopropyl Ether (DIPE)	ND	2.0
Ethyl tert-Butyl Ether (ETBE)	ND	2.0
Methyl tert-Amyl Ether (TAME)	ND	2.0
Ethanol	ND	4,000
MTBE	ND	2.0
1,2-Dichloroethane	ND	2.0
Benzene	ND	2.0
Toluene	ND	2.0
1,2-Dibromoethane	ND	2.0
Ethylbenzene	170	2.0
m,p-Xylenes	200	2.0
o-Xylene	6.5	2.0

Surrogate	%REC	Limits
Dibromofluoromethane	103	80-128
1,2-Dichloroethane-d4	103	75-139
Toluene-d8	99	80-120
Bromofluorobenzene	98	80-120

ND= Not Detected
 RL= Reporting Limit

Purgeable Organics by GC/MS

Lab #: 284345	Location: 15101 Freedom Avenue San Leandro
Client: SOMA Environmental Engineering Inc.	Prep: EPA 5030B
Project#: 2551	Analysis: EPA 8260B
Field ID: MW-11	Batch#: 242498
Lab ID: 284345-009	Sampled: 12/15/16
Matrix: Water	Received: 12/15/16
Units: ug/L	Analyzed: 12/16/16
Diln Fac: 1.000	

Analyte	Result	RL
Gasoline C7-C12	65	50
tert-Butyl Alcohol (TBA)	ND	10
Isopropyl Ether (DIPE)	ND	0.50
Ethyl tert-Butyl Ether (ETBE)	ND	0.50
Methyl tert-Amyl Ether (TAME)	ND	0.50
Ethanol	ND	1,000
MTBE	ND	0.50
1,2-Dichloroethane	ND	0.50
Benzene	ND	0.50
Toluene	ND	0.50
1,2-Dibromoethane	ND	0.50
Ethylbenzene	1.4	0.50
m,p-Xylenes	1.7	0.50
o-Xylene	ND	0.50

Surrogate	%REC	Limits
Dibromofluoromethane	104	80-128
1,2-Dichloroethane-d4	105	75-139
Toluene-d8	97	80-120
Bromofluorobenzene	100	80-120

ND= Not Detected
 RL= Reporting Limit

Purgeable Organics by GC/MS

Lab #: 284345	Location: 15101 Freedom Avenue San Leandro
Client: SOMA Environmental Engineering Inc.	Prep: EPA 5030B
Project#: 2551	Analysis: EPA 8260B
Field ID: MPE-1	Batch#: 242498
Lab ID: 284345-010	Sampled: 12/14/16
Matrix: Water	Received: 12/15/16
Units: ug/L	Analyzed: 12/16/16
Diln Fac: 1.000	

Analyte	Result	RL
Gasoline C7-C12	ND	50
tert-Butyl Alcohol (TBA)	ND	10
Isopropyl Ether (DIPE)	ND	0.50
Ethyl tert-Butyl Ether (ETBE)	ND	0.50
Methyl tert-Amyl Ether (TAME)	ND	0.50
Ethanol	ND	1,000
MTBE	ND	0.50
1,2-Dichloroethane	ND	0.50
Benzene	0.68	0.50
Toluene	ND	0.50
1,2-Dibromoethane	ND	0.50
Ethylbenzene	ND	0.50
m,p-Xylenes	0.82	0.50
o-Xylene	ND	0.50

Surrogate	%REC	Limits
Dibromofluoromethane	101	80-128
1,2-Dichloroethane-d4	105	75-139
Toluene-d8	100	80-120
Bromofluorobenzene	99	80-120

ND= Not Detected
 RL= Reporting Limit

Purgeable Organics by GC/MS

Lab #: 284345	Location: 15101 Freedom Avenue San Leandro
Client: SOMA Environmental Engineering Inc.	Prep: EPA 5030B
Project#: 2551	Analysis: EPA 8260B
Field ID: MPE-2	Batch#: 242552
Lab ID: 284345-011	Sampled: 12/14/16
Matrix: Water	Received: 12/15/16
Units: ug/L	Analyzed: 12/19/16
Diln Fac: 6.250	

Analyte	Result	RL
Gasoline C7-C12	7,100	310
tert-Butyl Alcohol (TBA)	150	63
Isopropyl Ether (DIPE)	ND	3.1
Ethyl tert-Butyl Ether (ETBE)	ND	3.1
Methyl tert-Amyl Ether (TAME)	ND	3.1
Ethanol	ND	6,300
MTBE	6.0	3.1
1,2-Dichloroethane	ND	3.1
Benzene	490	3.1
Toluene	ND	3.1
1,2-Dibromoethane	ND	3.1
Ethylbenzene	230	3.1
m,p-Xylenes	140	3.1
o-Xylene	ND	3.1

Surrogate	%REC	Limits
Dibromofluoromethane	101	80-128
1,2-Dichloroethane-d4	97	75-139
Toluene-d8	98	80-120
Bromofluorobenzene	95	80-120

ND= Not Detected
 RL= Reporting Limit

Purgeable Organics by GC/MS

Lab #: 284345	Location: 15101 Freedom Avenue San Leandro
Client: SOMA Environmental Engineering Inc.	Prep: EPA 5030B
Project#: 2551	Analysis: EPA 8260B
Field ID: EX-1	Batch#: 242498
Lab ID: 284345-012	Sampled: 12/14/16
Matrix: Water	Received: 12/15/16
Units: ug/L	Analyzed: 12/16/16
Diln Fac: 1.000	

Analyte	Result	RL
Gasoline C7-C12	ND	50
tert-Butyl Alcohol (TBA)	15	10
Isopropyl Ether (DIPE)	ND	0.50
Ethyl tert-Butyl Ether (ETBE)	0.81	0.50
Methyl tert-Amyl Ether (TAME)	ND	0.50
Ethanol	ND	1,000
MTBE	2.1	0.50
1,2-Dichloroethane	ND	0.50
Benzene	ND	0.50
Toluene	ND	0.50
1,2-Dibromoethane	ND	0.50
Ethylbenzene	ND	0.50
m,p-Xylenes	ND	0.50
o-Xylene	ND	0.50

Surrogate	%REC	Limits
Dibromofluoromethane	103	80-128
1,2-Dichloroethane-d4	103	75-139
Toluene-d8	99	80-120
Bromofluorobenzene	102	80-120

ND= Not Detected
 RL= Reporting Limit

Batch QC Report

Purgeable Organics by GC/MS			
Lab #:	284345	Location:	15101 Freedom Avenue San Leandro
Client:	SOMA Environmental Engineering Inc.	Prep:	EPA 5030B
Project#:	2551	Analysis:	EPA 8260B
Matrix:	Water	Batch#:	242498
Units:	ug/L	Analyzed:	12/16/16
Diln Fac:	1.000		

Type: BS Lab ID: QC865052

Analyte	Spiked	Result	%REC	Limits
tert-Butyl Alcohol (TBA)	62.50	53.86	86	32-155
Isopropyl Ether (DIPE)	12.50	11.61	93	57-128
Ethyl tert-Butyl Ether (ETBE)	12.50	12.16	97	62-120
Methyl tert-Amyl Ether (TAME)	12.50	11.65	93	69-120
MTBE	12.50	11.31	91	65-120
1,2-Dichloroethane	12.50	12.13	97	74-133
Benzene	12.50	12.36	99	80-123
Toluene	12.50	12.49	100	80-121
1,2-Dibromoethane	12.50	11.77	94	80-120
Ethylbenzene	12.50	12.69	101	80-123
m,p-Xylenes	25.00	25.30	101	80-126
o-Xylene	12.50	12.22	98	80-126

Surrogate	%REC	Limits
Dibromofluoromethane	104	80-128
1,2-Dichloroethane-d4	103	75-139
Toluene-d8	99	80-120
Bromofluorobenzene	100	80-120

Type: BSD Lab ID: QC865053

Analyte	Spiked	Result	%REC	Limits	RPD	Lim
tert-Butyl Alcohol (TBA)	62.50	51.39	82	32-155	5	33
Isopropyl Ether (DIPE)	12.50	11.69	94	57-128	1	20
Ethyl tert-Butyl Ether (ETBE)	12.50	12.23	98	62-120	1	20
Methyl tert-Amyl Ether (TAME)	12.50	11.68	93	69-120	0	20
MTBE	12.50	11.44	92	65-120	1	22
1,2-Dichloroethane	12.50	12.59	101	74-133	4	20
Benzene	12.50	12.08	97	80-123	2	20
Toluene	12.50	12.30	98	80-121	2	20
1,2-Dibromoethane	12.50	11.60	93	80-120	2	20
Ethylbenzene	12.50	12.38	99	80-123	2	21
m,p-Xylenes	25.00	24.60	98	80-126	3	21
o-Xylene	12.50	11.84	95	80-126	3	20

Surrogate	%REC	Limits
Dibromofluoromethane	101	80-128
1,2-Dichloroethane-d4	103	75-139
Toluene-d8	100	80-120
Bromofluorobenzene	101	80-120

RPD= Relative Percent Difference

Batch QC Report

Purgeable Organics by GC/MS		
Lab #:	284345	Location: 15101 Freedom Avenue San Leandro
Client:	SOMA Environmental Engineering Inc.	Prep: EPA 5030B
Project#:	2551	Analysis: EPA 8260B
Type:	BLANK	Diln Fac: 1.000
Lab ID:	QC865054	Batch#: 242498
Matrix:	Water	Analyzed: 12/16/16
Units:	ug/L	

Analyte	Result	RL
Gasoline C7-C12	ND	50
tert-Butyl Alcohol (TBA)	ND	10
Isopropyl Ether (DIPE)	ND	0.50
Ethyl tert-Butyl Ether (ETBE)	ND	0.50
Methyl tert-Amyl Ether (TAME)	ND	0.50
Ethanol	ND	1,000
MTBE	ND	0.50
1,2-Dichloroethane	ND	0.50
Benzene	ND	0.50
Toluene	ND	0.50
1,2-Dibromoethane	ND	0.50
Ethylbenzene	ND	0.50
m,p-Xylenes	ND	0.50
o-Xylene	ND	0.50

Surrogate	%REC	Limits
Dibromofluoromethane	104	80-128
1,2-Dichloroethane-d4	104	75-139
Toluene-d8	98	80-120
Bromofluorobenzene	104	80-120

ND= Not Detected
 RL= Reporting Limit

Batch QC Report

Purgeable Organics by GC/MS			
Lab #:	284345	Location:	15101 Freedom Avenue San Leandro
Client:	SOMA Environmental Engineering Inc.	Prep:	EPA 5030B
Project#:	2551	Analysis:	EPA 8260B
Matrix:	Water	Batch#:	242498
Units:	ug/L	Analyzed:	12/16/16
Diln Fac:	1.000		

Type: BS Lab ID: QC865069

Analyte	Spiked	Result	%REC	Limits
Gasoline C7-C12	1,000	972.0	97	76-120

Surrogate	%REC	Limits
Dibromofluoromethane	105	80-128
1,2-Dichloroethane-d4	102	75-139
Toluene-d8	100	80-120
Bromofluorobenzene	101	80-120

Type: BSD Lab ID: QC865070

Analyte	Spiked	Result	%REC	Limits	RPD	Lim
Gasoline C7-C12	1,000	922.9	92	76-120	5	20

Surrogate	%REC	Limits
Dibromofluoromethane	100	80-128
1,2-Dichloroethane-d4	107	75-139
Toluene-d8	99	80-120
Bromofluorobenzene	102	80-120

RPD= Relative Percent Difference

Batch QC Report

Purgeable Organics by GC/MS			
Lab #:	284345	Location:	15101 Freedom Avenue San Leandro
Client:	SOMA Environmental Engineering Inc.	Prep:	EPA 5030B
Project#:	2551	Analysis:	EPA 8260B
Matrix:	Water	Batch#:	242552
Units:	ug/L	Analyzed:	12/19/16
Diln Fac:	1.000		

Type: BS Lab ID: QC865259

Analyte	Spiked	Result	%REC	Limits
tert-Butyl Alcohol (TBA)	62.50	55.21	88	32-155
Isopropyl Ether (DIPE)	12.50	11.83	95	57-128
Ethyl tert-Butyl Ether (ETBE)	12.50	12.48	100	62-120
Methyl tert-Amyl Ether (TAME)	12.50	11.90	95	69-120
MTBE	12.50	11.62	93	65-120
1,2-Dichloroethane	12.50	12.96	104	74-133
Benzene	12.50	12.85	103	80-123
Toluene	12.50	12.80	102	80-121
1,2-Dibromoethane	12.50	11.76	94	80-120
Ethylbenzene	12.50	12.78	102	80-123
m,p-Xylenes	25.00	25.71	103	80-126
o-Xylene	12.50	12.37	99	80-126

Surrogate	%REC	Limits
Dibromofluoromethane	104	80-128
1,2-Dichloroethane-d4	104	75-139
Toluene-d8	98	80-120
Bromofluorobenzene	98	80-120

Type: BSD Lab ID: QC865260

Analyte	Spiked	Result	%REC	Limits	RPD	Lim
tert-Butyl Alcohol (TBA)	62.50	55.11	88	32-155	0	33
Isopropyl Ether (DIPE)	12.50	11.56	92	57-128	2	20
Ethyl tert-Butyl Ether (ETBE)	12.50	12.26	98	62-120	2	20
Methyl tert-Amyl Ether (TAME)	12.50	12.05	96	69-120	1	20
MTBE	12.50	11.47	92	65-120	1	22
1,2-Dichloroethane	12.50	12.90	103	74-133	0	20
Benzene	12.50	12.29	98	80-123	4	20
Toluene	12.50	12.24	98	80-121	4	20
1,2-Dibromoethane	12.50	11.91	95	80-120	1	20
Ethylbenzene	12.50	12.42	99	80-123	3	21
m,p-Xylenes	25.00	24.66	99	80-126	4	21
o-Xylene	12.50	12.31	99	80-126	0	20

Surrogate	%REC	Limits
Dibromofluoromethane	100	80-128
1,2-Dichloroethane-d4	102	75-139
Toluene-d8	98	80-120
Bromofluorobenzene	100	80-120

RPD= Relative Percent Difference

Batch QC Report

Purgeable Organics by GC/MS		
Lab #:	284345	Location: 15101 Freedom Avenue San Leandro
Client:	SOMA Environmental Engineering Inc.	Prep: EPA 5030B
Project#:	2551	Analysis: EPA 8260B
Type:	BLANK	Diln Fac: 1.000
Lab ID:	QC865261	Batch#: 242552
Matrix:	Water	Analyzed: 12/19/16
Units:	ug/L	

Analyte	Result	RL
Gasoline C7-C12	ND	50
tert-Butyl Alcohol (TBA)	ND	10
Isopropyl Ether (DIPE)	ND	0.50
Ethyl tert-Butyl Ether (ETBE)	ND	0.50
Methyl tert-Amyl Ether (TAME)	ND	0.50
Ethanol	ND	1,000
MTBE	ND	0.50
1,2-Dichloroethane	ND	0.50
Benzene	ND	0.50
Toluene	ND	0.50
1,2-Dibromoethane	ND	0.50
Ethylbenzene	ND	0.50
m,p-Xylenes	ND	0.50
o-Xylene	ND	0.50

Surrogate	%REC	Limits
Dibromofluoromethane	105	80-128
1,2-Dichloroethane-d4	103	75-139
Toluene-d8	98	80-120
Bromofluorobenzene	104	80-120

ND= Not Detected
 RL= Reporting Limit

Batch QC Report

Purgeable Organics by GC/MS			
Lab #:	284345	Location:	15101 Freedom Avenue San Leandro
Client:	SOMA Environmental Engineering Inc.	Prep:	EPA 5030B
Project#:	2551	Analysis:	EPA 8260B
Matrix:	Water	Batch#:	242552
Units:	ug/L	Analyzed:	12/19/16
Diln Fac:	1.000		

Type: BS Lab ID: QC865262

Analyte	Spiked	Result	%REC	Limits
Gasoline C7-C12	1,000	937.2	94	76-120

Surrogate	%REC	Limits
Dibromofluoromethane	102	80-128
1,2-Dichloroethane-d4	107	75-139
Toluene-d8	98	80-120
Bromofluorobenzene	102	80-120

Type: BSD Lab ID: QC865263

Analyte	Spiked	Result	%REC	Limits	RPD	Lim
Gasoline C7-C12	1,000	938.0	94	76-120	0	20

Surrogate	%REC	Limits
Dibromofluoromethane	104	80-128
1,2-Dichloroethane-d4	108	75-139
Toluene-d8	101	80-120
Bromofluorobenzene	99	80-120

RPD= Relative Percent Difference

Date : 19-DEC-2016 18:25
Client ID:
Sample Info: s,284345-001

Instrument: MSV0A10.i

Operator: VOC
Column diameter: 2.00

Column phase:

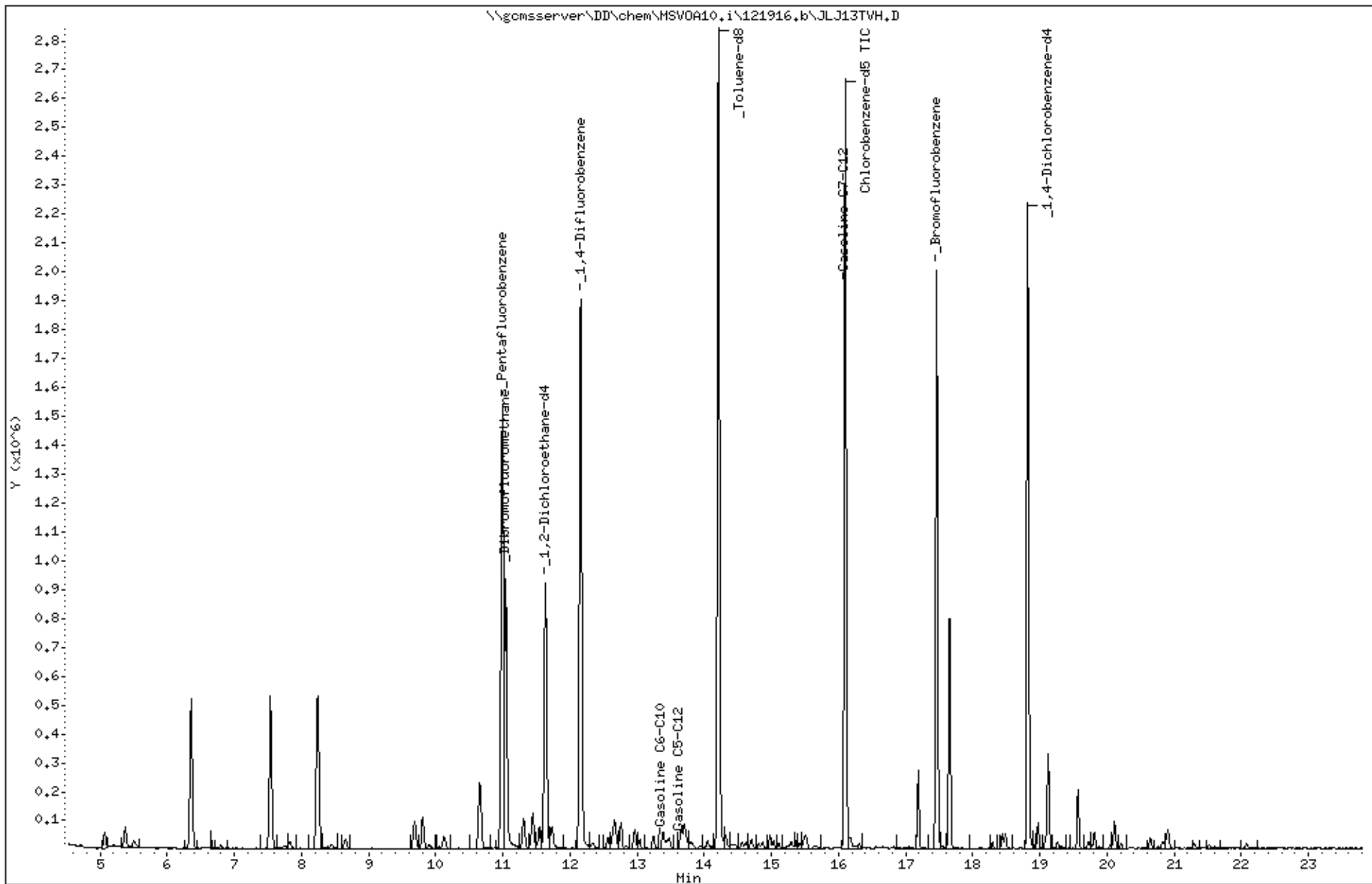

Date : 16-DEC-2016 18:05

Client ID:

Instrument: MSV0A10.i

Sample Info: s,284345-002

Operator: VOC

Column phase:

Column diameter: 2.00

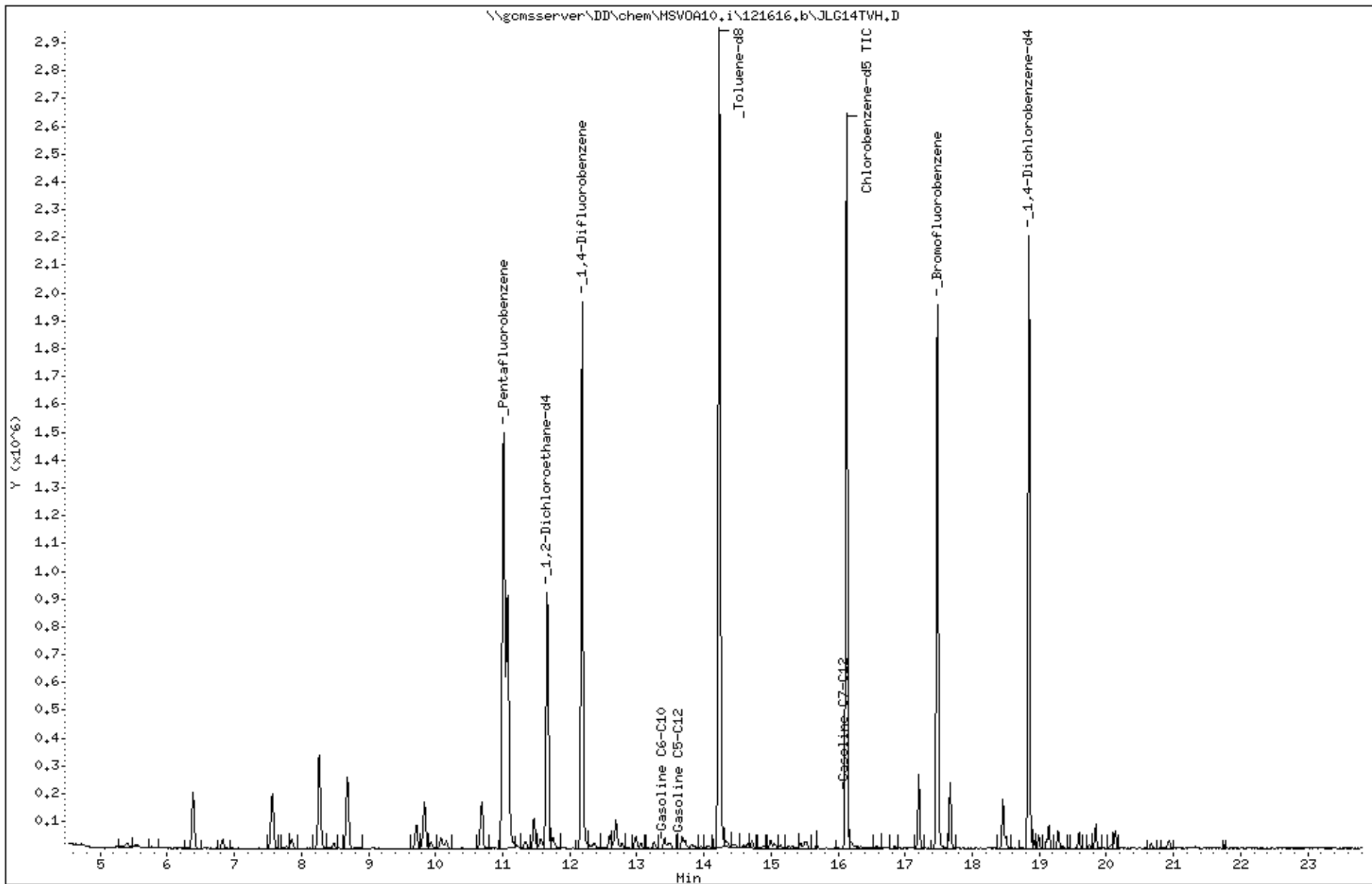

Date : 20-DEC-2016 00:07

Client ID:

Instrument: MSV0A10.i

Sample Info: s,284345-003

Operator: VOC

Column phase:

Column diameter: 2.00

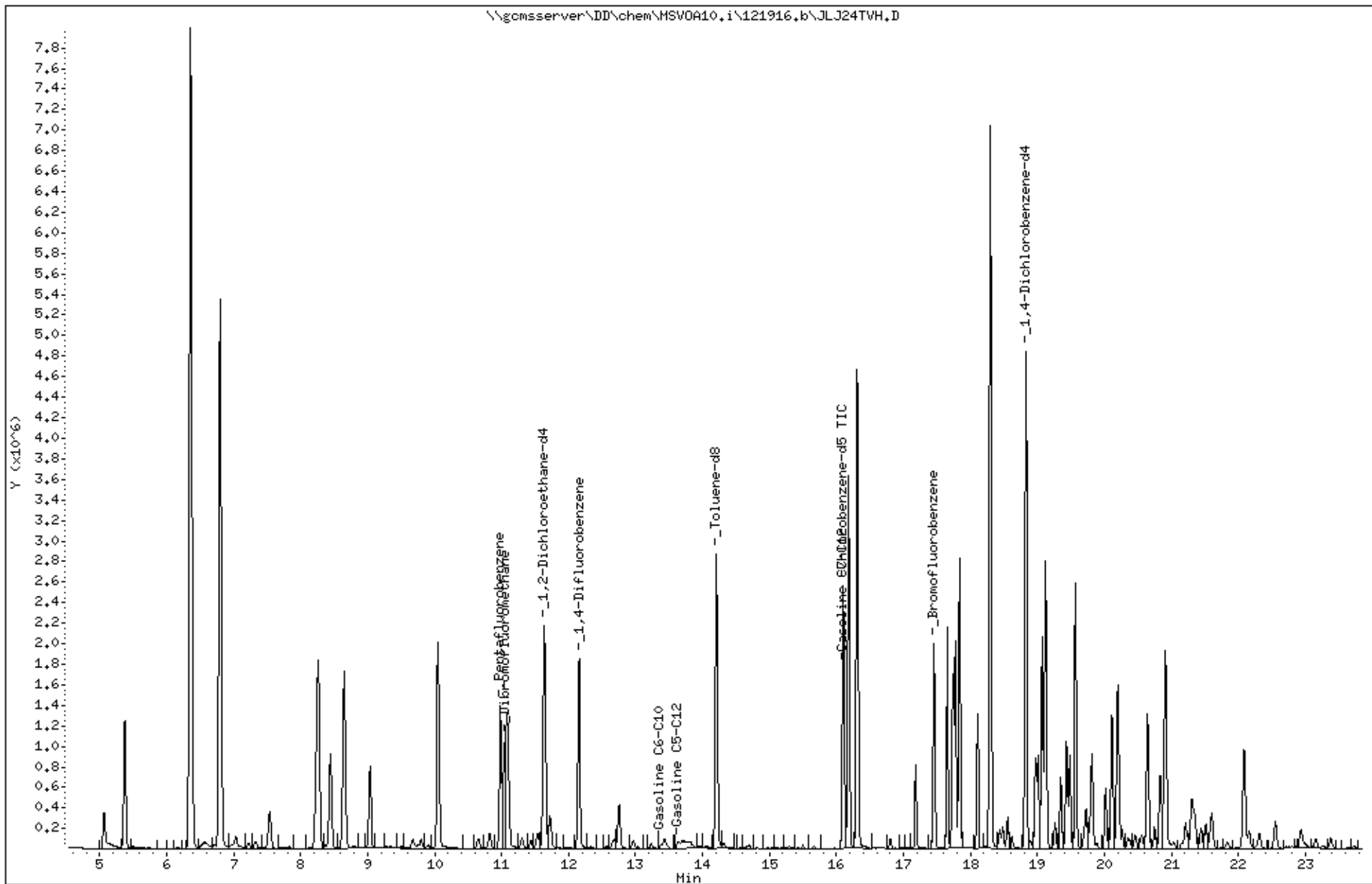

Date : 16-DEC-2016 18:36
Client ID:
Sample Info: s,284345-004

Instrument: MSV0A10.i
Operator: VOC
Column diameter: 2.00

Column phase:

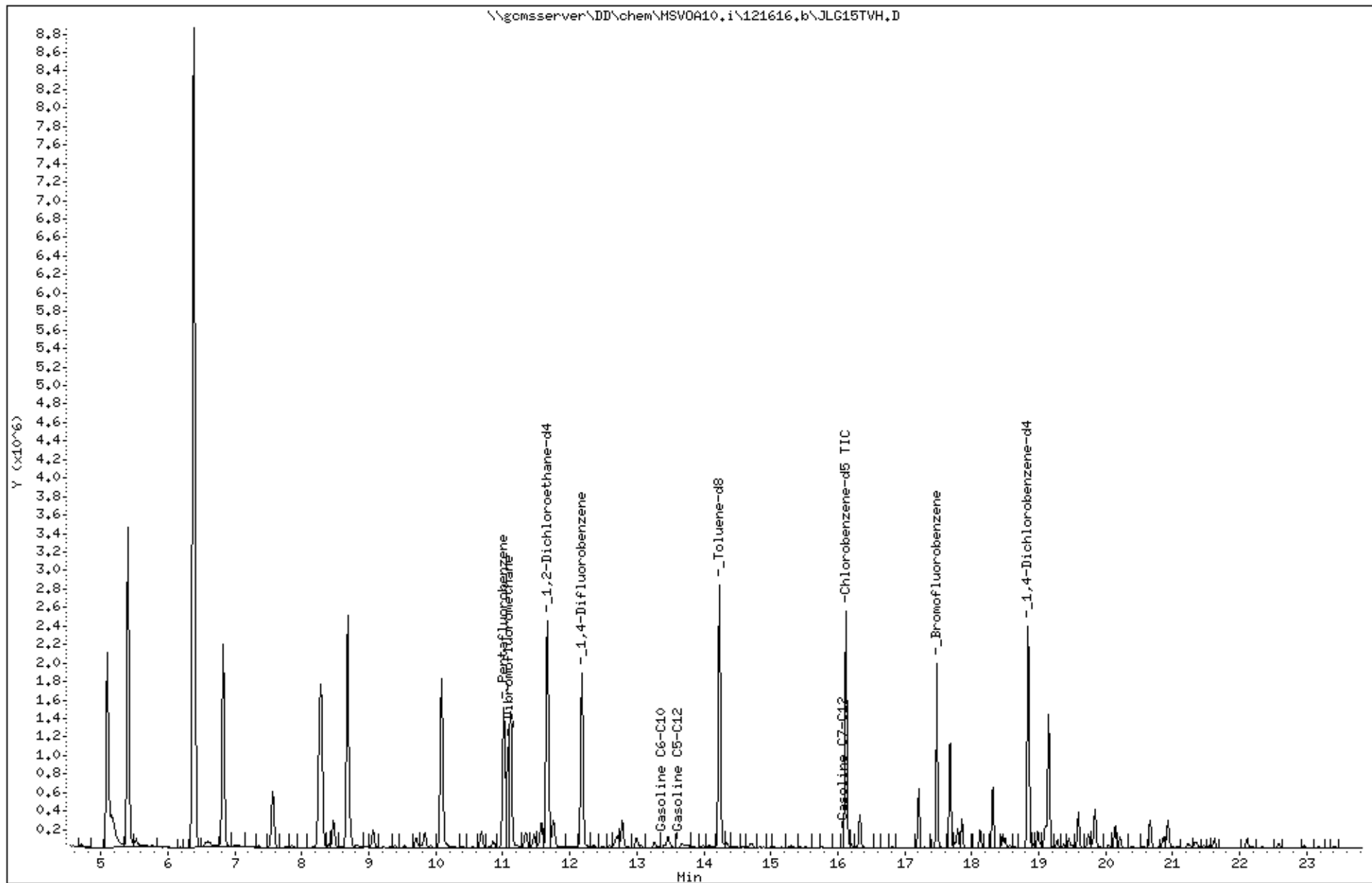

Date : 16-DEC-2016 19:07

Client ID:

Instrument: MSV0A10.i

Sample Info: s,284345-005

Operator: VOC

Column phase:

Column diameter: 2.00

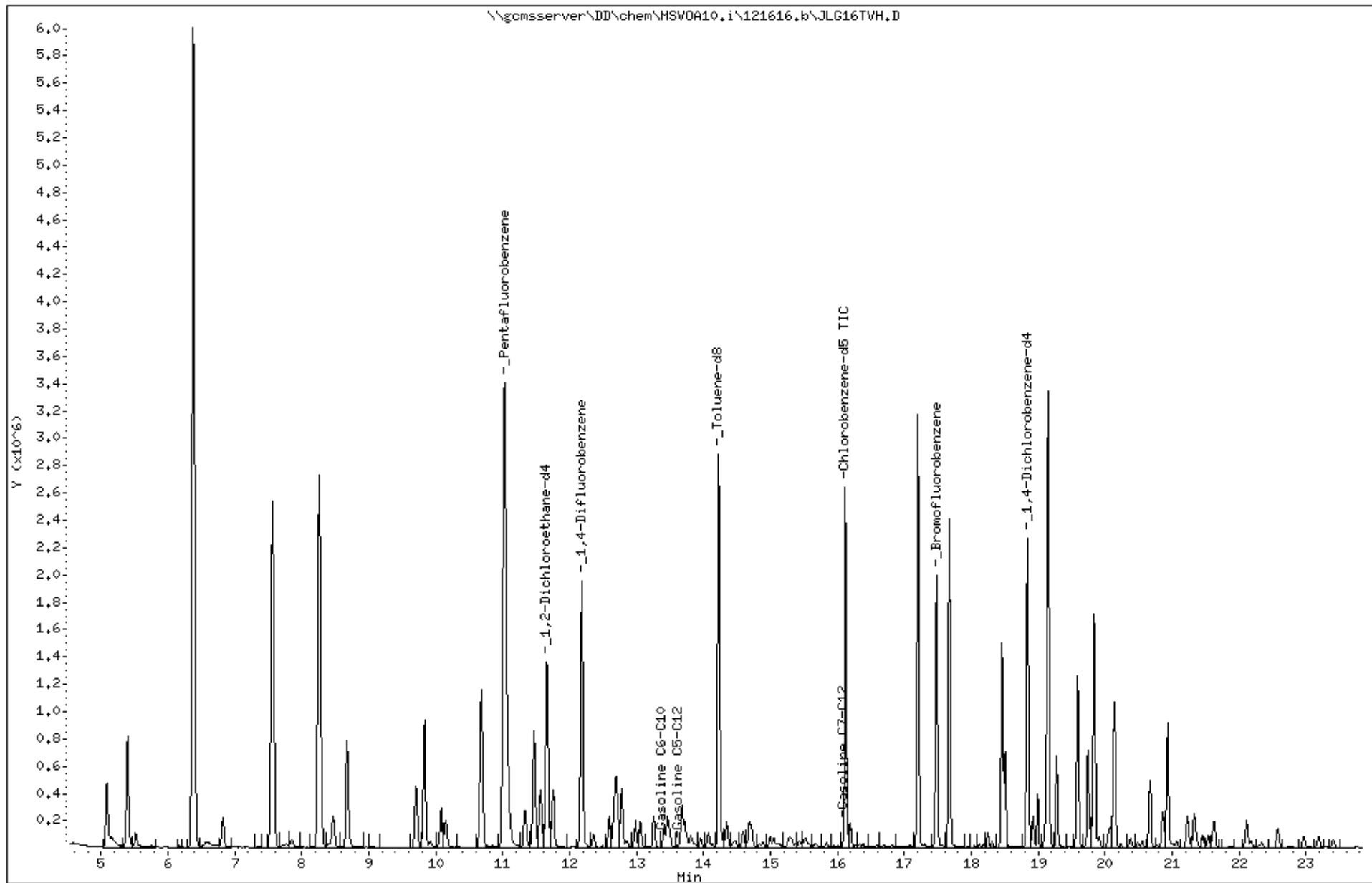

Date : 19-DEC-2016 18:56
Client ID:
Sample Info: s,284345-006

Instrument: MSV0A10.i
Operator: VOC
Column diameter: 2.00

Column phase:

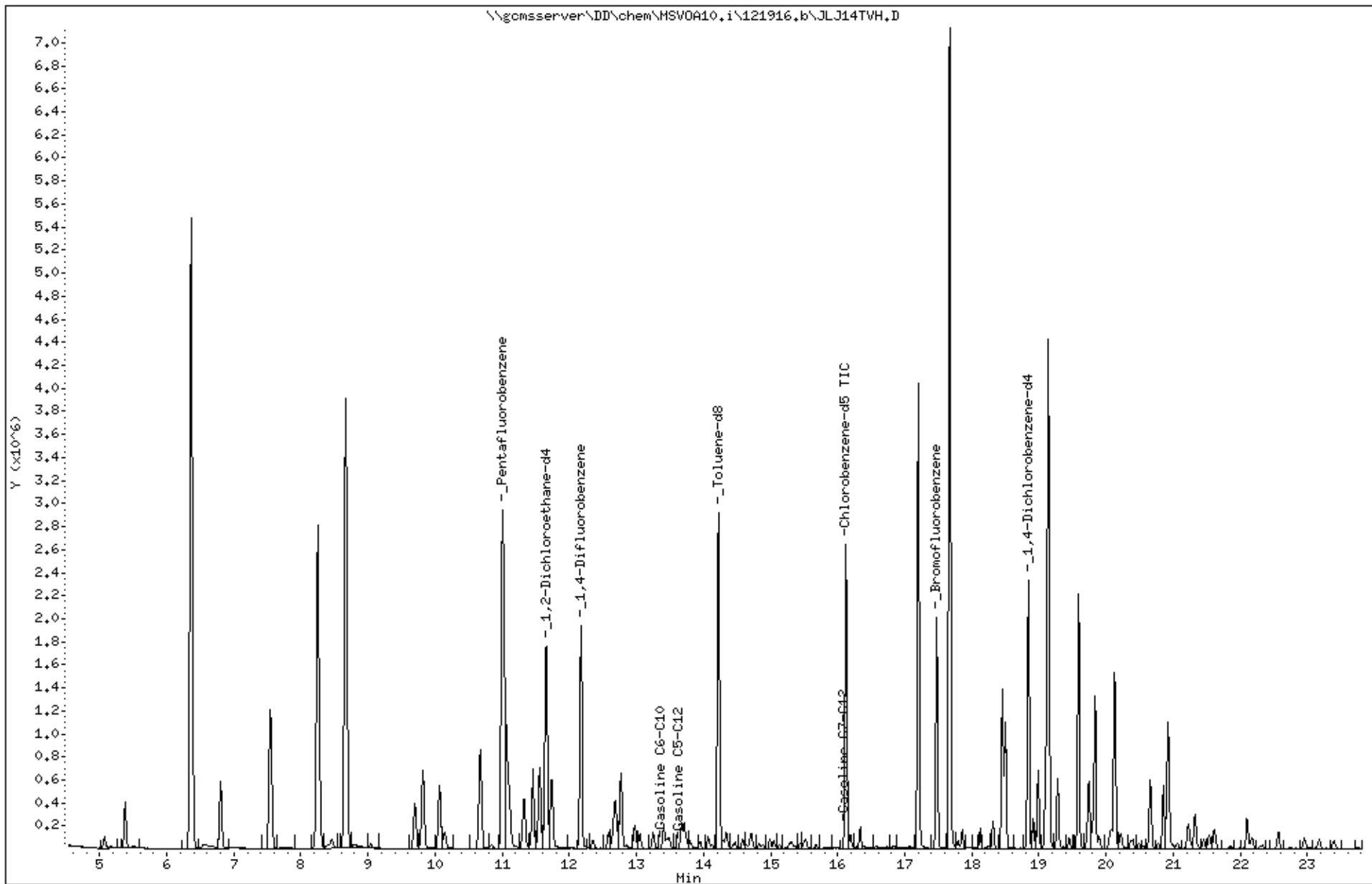

Date : 16-DEC-2016 19:38
Client ID:
Sample Info: s,284345-007

Instrument: MSV0A10.i

Operator: VOC

Column diameter: 2.00

Column phase:

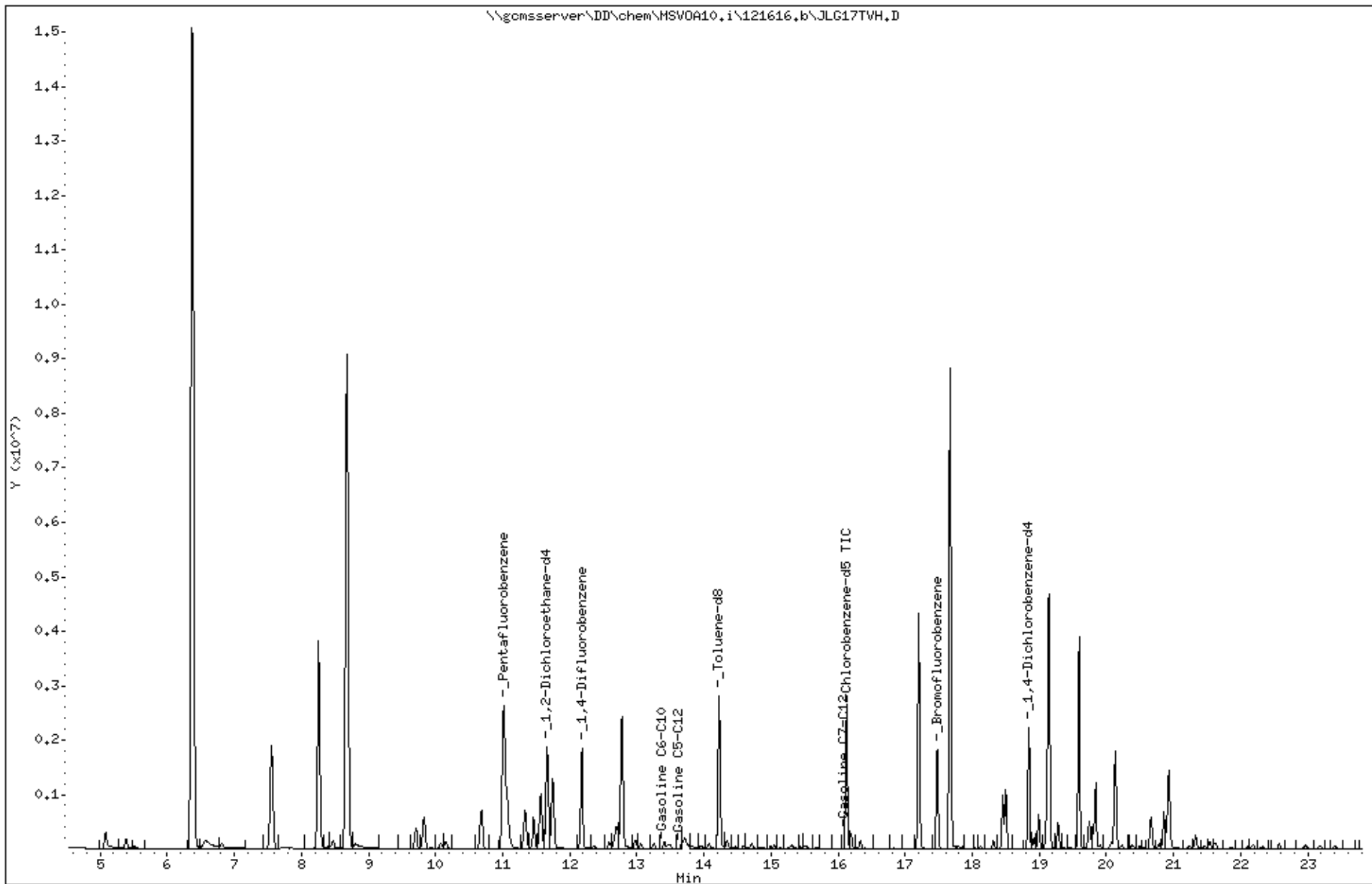

Date : 16-DEC-2016 22:45
Client ID:
Sample Info: s,284345-008

Instrument: MSV0A10.i

Operator: VOC

Column diameter: 2.00

Column phase:

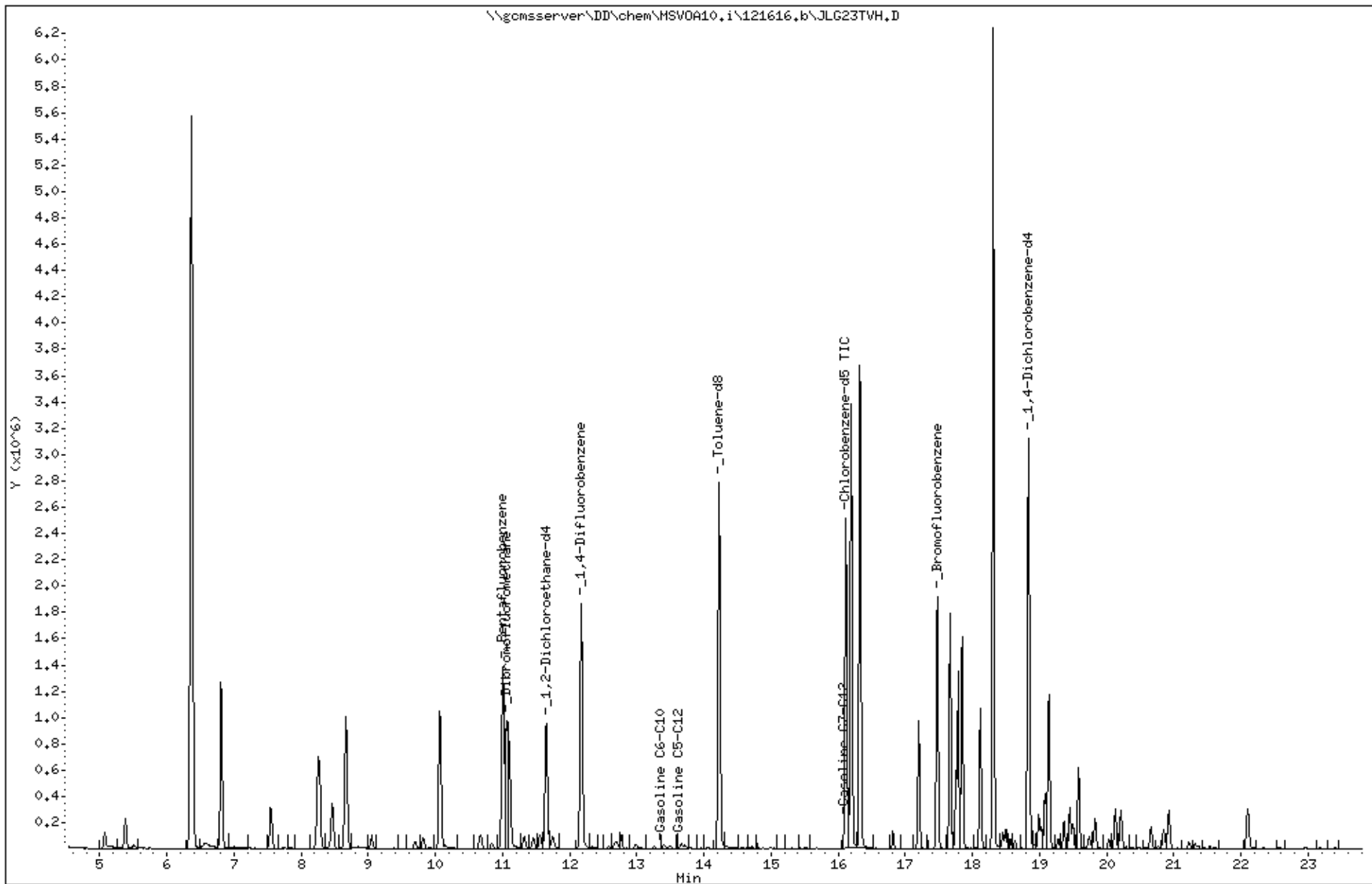

Date : 16-DEC-2016 20:09
Client ID:
Sample Info: s,284345-009

Instrument: MSV0A10.i

Operator: VOC
Column diameter: 2.00

Column phase:

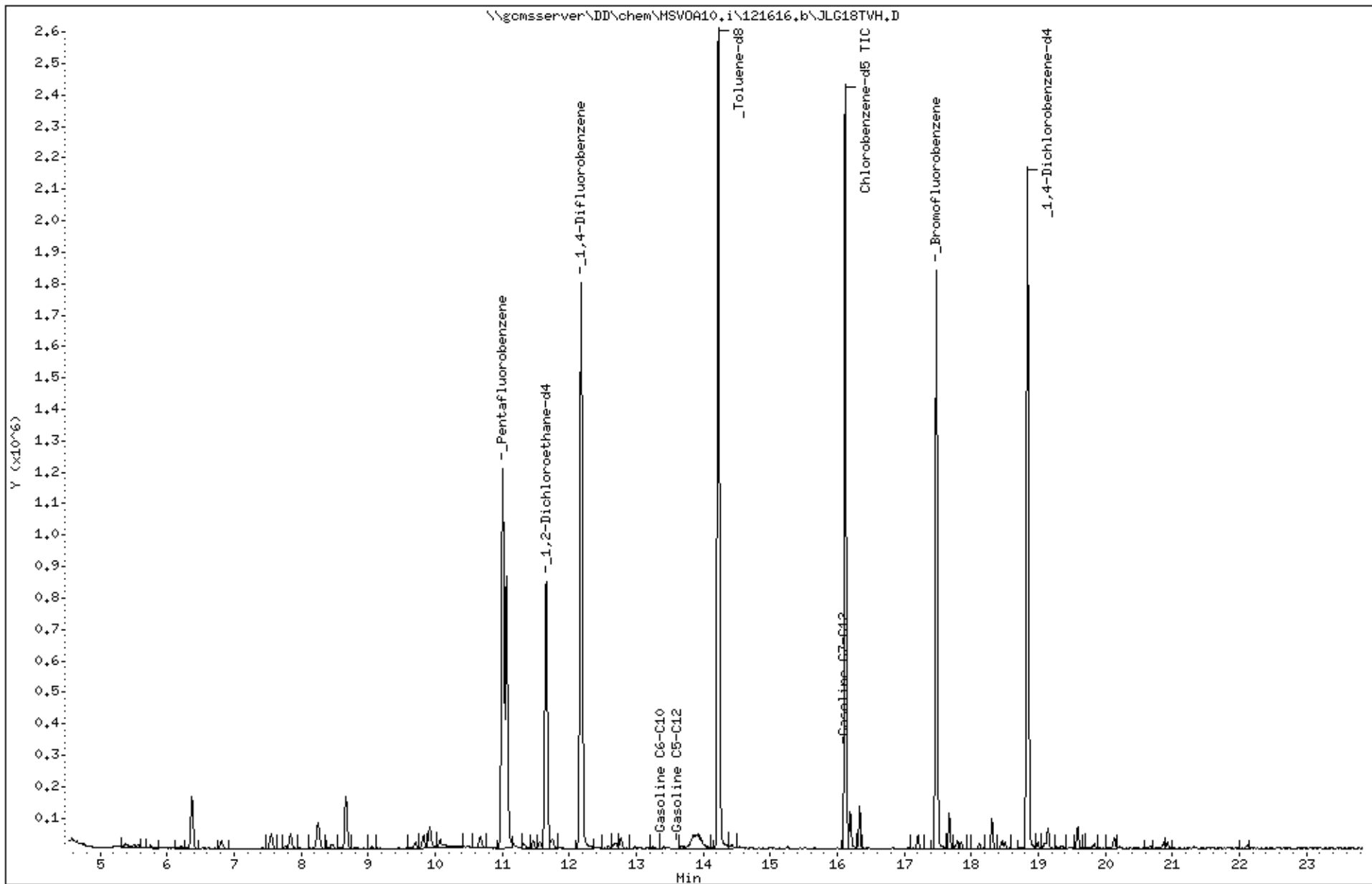

Date : 19-DEC-2016 23:36
Client ID:
Sample Info: s,284345-011

Instrument: MSV0A10.i

Operator: VOC

Column phase:

Column diameter: 2.00

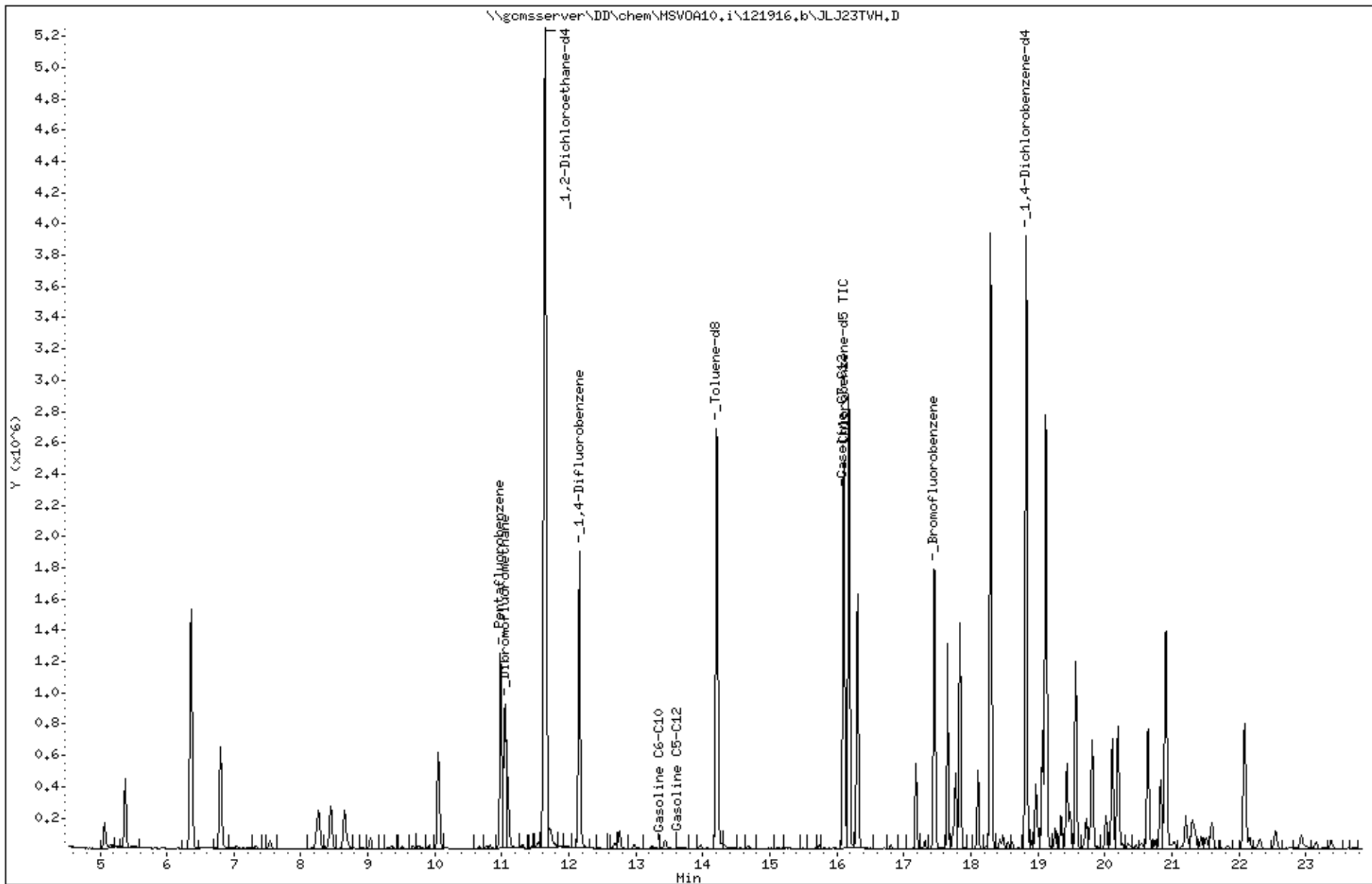

Date : 16-DEC-2016 14:28

Client ID:

Instrument: MSV0A10.i

Sample Info: ccv/bs,qc865069,242498,s30382,,01/100

Operator: VOC

Column phase:

Column diameter: 2.00

