

ENVIRONMENTAL
PROTECTION
95 MAR 24 PM 12:46

C

STD567



REPORT ON SOIL
REMEDATION AT THE
FORMER CELIS
ALLIANCE FUEL
STATION
4000 SAN PABLO AVENUE
EMERYVILLE, CALIFORNIA

Prepared for

City of Emeryville Redevelopment Agency
2200 Powell Street, 12th Floor, Suite 1200
Emeryville, California 94608-4356

January 6, 1995

Woodward-Clyde



Woodward-Clyde Consultants
500 12th Street, Suite 100
Oakland, California 94607-4014



**REPORT ON SOIL
REMEDICATION AT THE
FORMER CELIS
ALLIANCE FUEL
STATION
4000 SAN PABLO AVENUE
EMERYVILLE, CALIFORNIA**

Prepared for

City of Emeryville Redevelopment Agency
2200 Powell Street, 12th Floor, Suite 1200
Emeryville, California 94608-4356

January 6, 1995



Woodward-Clyde Consultants
500 12th Street, Suite 100
Oakland, California 94607-4014

TABLE OF CONTENTS

| <u>Section</u> | | <u>Page</u> |
|----------------|---|-------------|
| 1.0 | INTRODUCTION | 1-1 |
| 1.1 | Site Description | 1-1 |
| 1.2 | Scope of Work | 1-2 |
| 2.0 | SUMMARY OF RESULTS OF PREVIOUS SITE INVESTIGATIONS | 2-1 |
| 2.1 | Initial Investigations, June Through August 1993 | 2-1 |
| 2.2 | Additional Investigations, January 1994 | 2-3 |
| 2.3 | Building Demolition, May 1994 | 2-3 |
| 2.4 | Underground Tank Removal, May 1994 | 2-4 |
| 3.0 | PRE-EXCAVATION ACTIVITIES | 3-1 |
| 3.1 | Closure of Three Groundwater Monitoring Wells | 3-1 |
| 3.2 | Subcontractor Selection | 3-1 |
| 3.3 | Site Security | 3-2 |
| 3.4 | Utility Clearance | 3-2 |
| 3.5 | Permits | 3-2 |
| 3.6 | Soil Segregation, Analysis and Disposal Plan | 3-3 |
| 3.7 | Imported Fill Soil | 3-5 |
| 3.8 | Pre-Excavation Dewatering and Disposal | 3-5 |
| 4.0 | SOIL EXCAVATION AND DISPOSAL | 4-1 |
| 4.1 | Soil From 0- to 5-Foot Depth and From Designated Hot Spot Areas | 4-1 |
| 4.2 | Soil From 5- to 9.5-Foot Depth | 4-2 |
| 4.3 | Disposal of Drummed Soil Cuttings | 4-3 |
| 4.4 | Summary of Excavation and Disposal Volumes | 4-4 |
| 5.0 | CONFIRMATION SOIL SAMPLING IN EXCAVATION PIT | 5-1 |
| 5.1 | Sampling Locations and Method | 5-1 |
| 5.2 | Analytical Results | 5-2 |
| 6.0 | BACKFILLING | 6-1 |
| 7.0 | SUMMARY | 7-1 |

TABLE OF CONTENTS (Continued)

| <u>Section</u> | | <u>Page</u> |
|----------------|---------------------------------|-------------|
| 8.0 | CONCLUSIONS AND RECOMMENDATIONS | 8-1 |
| 9.0 | LIMITATIONS | 9-1 |
| 10.0 | REFERENCES | 10-1 |

TABLE OF CONTENTS (Continued)

LIST OF TABLES

| | |
|---------|---|
| TABLE 1 | Analytical Results for Soil Samples from Fuel Station |
| TABLE 2 | Analytical Results for Groundwater Samples |
| TABLE 3 | Soil Segregation and Analysis Requirements for Disposal |
| TABLE 4 | Analytical Results for Soil Samples from Stockpiles |
| TABLE 5 | Recorded Volumes of Soil Disposed of at Landfills |
| TABLE 6 | Analytical Results for Soil Samples Collected from Excavation Pit |

LIST OF FIGURES

| | |
|----------|---|
| FIGURE 1 | Site Location Map, Celis Alliance Gas Station |
| FIGURE 2 | Soil Boring and Monitoring Well Locations |
| FIGURE 3 | UST Excavations, Soil Sampling Locations, and Analyte Concentrations. |
| FIGURE 4 | Area Used for Temporary Stockpiling of Excavated Soil |
| FIGURE 5 | Dimensions of Excavation Area |
| FIGURE 6 | Soil Sampling Locations and Field Observations |
| FIGURE 7 | Soil Sampling Locations and Analyte Concentrations |

LIST OF APPENDIXES

| | |
|-----|--|
| A. | Well Destruction Certificates |
| A.1 | Application for Well Destruction Permit |
| A.2 | Well Destruction Permit |
| A.3 | Well Destruction Report |
| B. | Permits |
| B.1 | BAAQMD Notification Record |
| B.2 | State Excavation Notification Record |
| B.3 | Grading Permit |
| B.4 | ACHA's Written Approval of Workplan and WCC's Memorandum of Clarifications |
| C. | Water and Drum Disposal Certificates |
| C.1 | Water Disposal Certificate |
| C.2 | Empty Drum Disposal Certificate |

TABLE OF CONTENTS (Continued)

- D. Soil Disposal Records
 - D.1 Disposal Record for Soil Excavated From 0 to 5 ft Below Grade
 - D.2 Analytical Report for Soil Excavated From 0 to 5 ft Below Grade
 - D.3 Disposal Record for Soil Excavated From 5 to 9.5 ft Below Grade
 - D.4 Analytical Report for Soil Excavated From 5 to 9.5 ft Below Grade
 - D.5 Forward Landfill Waste Manifests
 - D.6 B&J/ALTA Landfill Waste Manifests
 - D.7 Excavation and Backfill Volume Calculations

- E. Confirmation Soil Sampling in Excavation Area
 - E.1 ACHA's Inspection Record
 - E.2 Field Sampling Notes
 - E.3 Laboratory Analytical Report

- F. Soil Compaction Report

1.0
INTRODUCTION

This report describes the soil remediation work performed by Woodward-Clyde Consultants (WCC) from June to October 1994 at the former Celis Alliance Fuel Station Site located at 4000 San Pablo Avenue in Emeryville, California. The work proceeded following the verbal approval of a workplan by the Alameda County Health Agency, Department of Environmental Health, Division of Hazardous Materials on June 27, 1994. The workplan was prepared by WCC (Reference 6) for additional site investigation and limited soil excavation at the subject site. The work summarized in this report pertains to the limited soil excavation part of the workplan. The additional site investigations described in the workplan have not yet been performed due to the current road construction work (40th Street extension) on the site, and will be carried out after the road construction is complete.

1.1 SITE DESCRIPTION

The former Celis Alliance Fuel Station (site) is located at 4000 San Pablo Avenue in Emeryville, California (Figure 1), within the planned 40th Street Right-of-Way extension. The site is located in a commercial area in Emeryville and is bounded by San Pablo Avenue to the west, a two-story concrete warehouse to the east, and parking lots to both the north and south (Figure 2).

In June 1993, Levine-Fricke conducted a Phase I environmental site assessment (ESA) on the subject site (Reference 2). The Phase I ESA revealed that a commercial fueling and auto service station (fuel station) had been operated at the site since 1936 (it ceased operation in April 1994). The fuel station contained a service garage with an attached office and canopy, and one fuel dispenser island, as shown on Figure 2.

Geologically, the Phase I ESA investigation found that the site is underlain by Holocene alluvial deposits, primarily unconsolidated, fine sand, silt, and clayey silt with occasional thin beds of coarse sand. The site is located approximately 1 mile east of the San Francisco Bay and is essentially level, with an approximate elevation of 40 feet above mean sea level.

1.2 SCOPE OF WORK

The soil remediation work involved the following tasks:

- Closure of three on-site groundwater monitoring wells
- Excavation of petroleum-affected soil across the site down to groundwater level
- Sampling and analyses of the excavated soil
- Off-site disposal of the excavated soil to appropriate landfills based on the soil characterization
- Dewatering before excavation and disposal of the collected water
- Disposal of drummed water and soil cuttings generated from previous site investigations
- Sampling and analyses in the excavation area
- Backfilling of the excavation pit with imported soil
- Preparation of this final report documenting the above work

SUMMARY OF RESULTS OF PREVIOUS SITE INVESTIGATIONS

2.1 INITIAL INVESTIGATIONS, JUNE THROUGH AUGUST 1993

In June 1993, Catellus Development Corporation (Catellus) of San Francisco, California, retained Levine-Fricke of Emeryville, California, to conduct a Phase I environmental site assessment for the planned 40th Street Right-of-Way extension to run between San Pablo Avenue and Adeline Street (40th St. Right-of-Way). The Celis Alliance Fuel Station (Site) is located within the extension area. The Phase I assessment revealed the existence of a fuel station on the Celis site since at least 1936 and reported the following six underground storage tanks (USTs):

- One 7,000-gallon diesel UST
- One 6,000-gallon regular gasoline UST
- One 4,000-gallon unleaded gasoline UST
- One 2,000-gallon unleaded gasoline UST
- One 3,500-gallon super unleaded gasoline UST
- One 550-gallon waste oil UST

Heavy oil stains were observed in many areas of the site. On the basis of the Phase I findings, Levine-Fricke performed a Phase II investigation for the 40th St. Right-of-Way in August 1993, which included:

- Site inspection and geophysical survey
- Drilling of 22 soil borings and collection of soil samples for lithologic description and chemical analysis. Of the 22 soil borings, 14 were from the Celis site
- Conversion of 3 soil borings to groundwater monitoring wells on the Celis site
- Collection of groundwater samples from the monitoring wells for chemical analysis

The locations of soil borings and monitoring wells are shown on Figure 2. Selected soil samples were analyzed for total petroleum hydrocarbons (TPH) as gasoline (TPHg) using EPA Method 8015/5030; benzene, toluene, ethylbenzene, and xylenes (BTEX) using EPA

Method 8020; TPH as diesel (TPHd) using EPA Method 8015/3510; TPH as motor oil (TPHmo) using EPA Method 8015/3510; total recoverable petroleum hydrocarbons as oil and grease (TRPH) using Standard Method 5520EF; and polychlorinated biphenyls (PCBs) using EPA Method 8080.

The soil analytical results are summarized in Table 1. Soil samples were generally collected at depths of 7, 9.5, and 14.5 feet below ground surface (bgs). The analytical results indicate that soil at the Celis site contains significant concentrations of petroleum hydrocarbons. TPHg was reported in 19 of the 32 soil samples analyzed, with concentrations ranging from 1 milligram per kilogram (mg/kg) to 2,800 mg/kg. Benzene was detected in all but four samples, at concentrations ranging from 0.005 to 22 mg/kg. The highest concentrations of petroleum hydrocarbons were generally reported for samples collected from 7 and 9.5 feet bgs. Four soil samples collected from soil borings SB-2 and SB-3, which were near the waste oil tank, were also analyzed for PCBs. PCB concentrations in these borings were below laboratory detection limits.

The soil encountered in the borings mainly consists of clayey silt (ML), silty clay (CL), and silty sand (SM). Some silty clay of low plasticity was also encountered.

The three groundwater monitoring wells installed on the Celis site are all 2 inches in diameter, 20 feet bgs, screened from 5 to 20 feet bgs, and constructed with polyvinyl chloride. Shallow groundwater elevations varied from approximately 8 to 9.5 feet bgs during the month of August 1993. Groundwater flow direction beneath the site is generally toward the west under a hydraulic gradient of approximately 0.03 ft/ft.

Free-phase fuel product was measured in monitoring well LF-1 at a thickness of 6.24 inches on August 20, 1993. LF-1 is located downgradient from the pump island and the diesel tank. Free-phase product has not been detected in the other two monitoring wells.

The three monitoring wells were sampled on August 7, 1993 for the analysis of TPHg, TPHd, TPHmo, BTEX, and TRPH. The results are summarized in Table 2. The results indicate that shallow groundwater beneath the Celis site has been significantly affected by petroleum hydrocarbons.

2.2 ADDITIONAL INVESTIGATIONS, JANUARY 1994

At the request of Alameda County Health Care Services Agency (ACHA), Levine-Fricke conducted additional investigations to further assess the lateral extent of petroleum hydrocarbons in groundwater downgradient (west) from the Celis site. Two soil borings were drilled, one of which was converted to a groundwater monitoring well (LF-4). Their locations are shown on Figure 2. This new monitoring well is also 2 inches in diameter, 20 feet bgs, and screened from 5 to 20 feet bgs.

Soil samples were analyzed for TPHg, TPHd, TPHmo, BTEX, and TRPH. The results are shown in Table 1. Groundwater samples were analyzed for the same constituents as soil samples and their results are given in Table 2.

Monitoring well LF-4 is located approximately 160 feet west (downgradient) of well LF-1. The soil sample at 10 feet bgs from this well showed TPHg (220 mg/kg), TPHd (19 mg/kg), and BTEX. Groundwater samples from this well also reported TPHg, TPHd, TPHmo, and BTEX. Soil boring EB-1 is approximately 150 feet west of well LF-4 (310 feet downgradient of well LF-1). Soil samples from this boring were below detection limits for TPHg, TPHd, TRPH and BTEX, but had low levels of TPHmo (17 mg/kg at 5 ft bgs and 49 mg/kg at 10 ft bgs). A grab groundwater sample (GWEB1) was also obtained from this boring and showed very low levels of TPHd (0.081 mg/l), toluene (0.00057 mg/l) and xylenes (0.0026 mg/l). These low levels of petroleum hydrocarbons in boring EB-1 may not necessarily originate from the Celis site because TPHg, which was reported at concentrations of approximately 10 times the TPHd concentration in well LF-4, was not detected in boring EB-1. TPHg is more mobile than TPHd in groundwater and usually appears downgradient before TPHd.

2.3 BUILDING DEMOLITION, MAY 1994

A WCC representative noticed during several drive-by observations from May 2 through 13, 1994, that the fuel station building and the surface pavement of the entire site were being removed. Two hydraulic lifts and associated piping and hydraulic fluid storage tank(s) in the service garage may have also been removed during that time. However, a report

documenting the field activities was not yet available to WCC for review as this report was prepared.

2.4 UNDERGROUND TANK REMOVAL, MAY 1994

Levine-Fricke removed the six underground storage tanks (UST) and associated piping during the week of May 16, 1994. All six USTs were made of welded steel and single-walled. Holes were noted in the 2,000-gallon unleaded gasoline tank and the 550-gallon waste oil tank, but not in the other four tanks. Holes were also noted in a previously abandoned product piping that appeared to have been connected to the 6,000-gallon regular gasoline tank, in the portion of the piping just north of the super unleaded gasoline tank.

A total of eight soil samples were collected from the UST excavations after the tanks were removed: five from native soils in the sidewalls of the gasoline UST excavation, two from native soils in the sidewalls of the diesel UST excavation, and one from native soil about 1 foot below the bottom of the waste oil UST excavation. Sampling locations are shown on Figure 3.

The results of TPH and BTEX analyses of soil samples are shown on Figure 3. The soil sample D1-9 in the diesel tank excavation near the monitoring well LF-1 showed a diesel concentration of 1,300 mg/kg. Free-phase product was measured previously in LF-1. Soil samples from the north side of the gasoline UST excavation showed much higher TPHg concentrations than the samples from the south side of the same excavation. No petroleum oil (TPHo) was measured above the laboratory detection limit (5 mg/kg) in the soil sample collected beneath the waste oil UST.

The soil sample (G3-9.5) taken near the regular gasoline UST was also analyzed for organic lead, and the result was below laboratory detection limit (0.5 ppm). The soil sample taken beneath the waste oil UST was also analyzed for organic lead (result below detection limit, 0.5 ppm), five LUFT metals (results were Cd < 0.1 mg/kg, Cr (total) = 27 mg/kg, Pb (total) = 2 mg/kg, Ni = 26 mg/kg, and Zn = 47 mg/kg), PCBs (result below detection limit, 0.05 mg/kg), Creosote (result below detection limit, 5 mg/kg), PNAs (polynuclear aromatics, result below detection limit, 0.2 mg/kg), and HVOCs (halogenated volatile organic compounds,

results below detection limit, 0.005 mg/kg). These results indicate that the site may have only been impacted by petroleum hydrocarbons.

PRE-EXCAVATION ACTIVITIES

3.1 CLOSURE OF THREE GROUNDWATER MONITORING WELLS

Monitoring wells LF-1, LF-2, and LF-3 are all located on the Celis site and within the area to be excavated (Figure 2). These wells were destroyed by grouting them in place on June 29, 1994. The top 9 feet of soil were removed during excavation, as described in Section 4. The well destruction procedure was as follows:

- Clean out all bridged or poorly compacted materials to the bottom of each well by inserting a tremie pipe into the well and moving the tremie pipe up and down several times
- Tremie pump neat cement into each well under 10 psig pressure and maintain the pressure for at least 15 minutes after filling each well
- Remove the top 9 feet of well casing by excavation after the seal has set

Well destruction permit and closure report are included in Appendix A.

3.2 SUBCONTRACTOR SELECTION

Remedial Solution Inc. (RSI) of Fremont, California, was contracted by WCC to conduct the field operations of soil excavation, disposal, and backfilling. RSI's address is:

43353 Osgood Road, Suite B
Fremont, California 94539
Phone (510) 651-7725
California Contractor License No.: A634555

3.3 SITE SECURITY

Before excavation began, a 6-foot-high chain-linked fence was installed along the perimeter of the Celis site. Access to the work area was limited to those personnel required to perform the various field activities.

3.4 UTILITY CLEARANCE

Levine-Fricke has identified the following five underground utility lines on the site prior to its UST removal: one sanitary sewer line, one electrical line, one water line, and two unknown lines. The electrical line was removed during the UST removal. The sanitary sewer line was also partially removed. In several phone conversations with engineers in the City of Emeryville Public Works Department in July 1994, City engineers indicated to a WCC representative that all known utility lines entering the Celis site were terminated by the City outside the site.

Prior to excavation, Underground Services Alert (USA) was notified of the proposed excavation activities. DownUnder Technologies of Hayward, a private underground utility locator, was also retained to survey the site. No additional underground utility lines other than those identified by Levine-Fricke were located.

The two unknown underground lines identified previously by Levine-Fricke were later found to be abandoned electrical lines and were removed during excavation. The inactive water line was cut off at the excavation boundary and was capped before backfilling.

3.5 PERMITS

The following regulatory agencies were contacted for appropriate permit(s) before field activities began:

- Bay Area Air Quality Management District (BAAQMD)

Per BAAQMD Regulation 8, Rule 40, a notification form for the excavation and temporary on-site stockpiling of contaminated soil was filed on July 12, 1994. A copy of the filed notification form is included in Appendix B.1.

- State of California Department of Industrial Relations, Division of Occupational Safety and Health

The contractor (RSI) retained by WCC for the field operations filed the Activity Notification Form as required per 8CCR 341.1(f). A copy of the form is included in Appendix B.2.

- City of Emeryville

A grading permit was filed with the City of Emeryville Building Department on July 18, 1994 covering the excavation and backfilling operations. The permit was signed by the City Inspector on September 2, 1994. A copy of the permit is included in Appendix B.3.

- Alameda County Health Agency (ACHA), Department of Environmental Health, Division of Hazardous Materials

The work proceeded based on the oral approval from ACHA on June 27, 1994. ACHA issued a written approval of the proposed work on August 24, 1994. A copy of the written approval letter and a subsequent WCC clarification letter are included in Appendix B.4.

3.6 SOIL SEGREGATION, ANALYSIS AND DISPOSAL PLAN

Prior to excavation, the following two waste management facilities were contacted for the disposal of excavated soil:

Alta/B&J Landfill
831 Davis Street
Vacaville, California 95687

Forward Landfill
1145 West Charter Way
Stockton, California 95206

Alta/B&J Landfill is a Class III landfill and accepts petroleum hydrocarbon contaminated soils with TPH concentrations up to 1,000 mg/kg and Benzene up to 10 mg/kg. Forward Landfill is a Class II landfill and accepts petroleum hydrocarbon contaminated soils with TPHg up to 5,900 mg/kg, TPHd up to 20,000 mg/kg, and Oil and Grease up to 10,000 mg/kg. Other limitations also exist at both landfills. Because the unit disposal cost is much less at Alta/B&J Landfill than at Forward Landfill, only those soils that have concentrations of a constituent that exceed the Alta/B&J Landfill's acceptance criteria will be reviewed by Forward Landfill for possible disposal there.

Chemical analysis results from Levine-Fricke's site investigations and tank removal were made available to both landfills for review. An agreement was reached with the landfill operators for soil segregation and additional analyses as follows:

- Soil from ground surface to 5-foot depth is to be excavated and stockpiled on-site for further sampling and analysis. For every 100 cubic yards of soil excavated, four discrete, representative soil samples will be collected and composited into one for TPHg and BTEX analyses.
- Soil from hot spot areas will be excavated in 10 ft x 10 ft squares to a depth of 9.5 ft and stockpiled separately for additional analysis as summarized in Table 3. The hot spot is defined as the waste oil tank area, and the areas that previously showed TPH concentrations exceeded 1,000 mg/kg (SB-8, SB-9, and SB-10 in Figure 2 and D1-9 in Figure 3). Soils from the SB-8, SB-9, and SB-10 hot spots may be combined since only TPHg was reported above the 1,000 mg/kg limit by Levine-Fricke at the three locations.
- In the non-hot spot areas, soil from the 5-foot to 9.5-foot depth in the portion of the site west of the eastern wall of the former gas station building, as illustrated in Figure 4, will be excavated and field screened by use of a portable organic vapor analyzer. Soils registering less than 900 ppm TPH may be disposed of at the Alta/B&J Landfill

without further analysis. Soils registering 900 TPH or greater will be stockpiled separately for additional TPHg analysis.

- Soil from the rest of the site (5-foot to 9.5-foot depth in the portion of the site east of the eastern wall of the former gas station building; see Figure 4) will be excavated and stockpiled separately for additional analysis. Soil segregation and analysis requirements are summarized in Table 3.

3.7 IMPORTED FILL SOIL

Fill soil was provided by the City of Emeryville. The soil was stockpiled near the south terminus of Shellmound Street, approximately half a mile west of the Celis site. Mr. Juan Arreguin from the City of Emeryville Public Works Department designated the soil for backfilling of this site. Mr. Arreguin also supplied the soil classification and moisture-density data for the fill soil, from an analysis performed by Kleinfelder in April 1994. The soil was described as brown clayey silt with gravels, has the maximum dry density of 131.7 lb per cubic feet, and the optimum moisture content of 11.8 percent. These data were used by WCC for on-site compaction testing. WCC did not perform laboratory compaction tests on the soil, nor any other chemical analyses to certify the cleanness of the soil, for which the City of Emeryville is responsible.

3.8 PRE-EXCAVATION DEWATERING AND DISPOSAL

Groundwater partially filled the gasoline tank and diesel tank excavation pits (Figure 3) created by Levine-Fricke in its tank removal process. The water was removed prior to excavation. A 5,000-gallon tank truck equipped with a vacuum pump from H&H Ship Service of San Francisco was on site on July 21, 1994 and removed water from the two pits. At the request of the City of Emeryville Redevelopment Agency, water contained in six 55-gallon drums was also transferred to the tank truck on the same day. The drummed water had been generated by Levine-Fricke during its groundwater sampling at the site. A total of 1,400 gallons of water was removed.

The water was recycled at Gibson Environmental Facility (Gibson) located at 475 Seaport Blvd. in Redwood City, California. Gibson reviewed the groundwater analytical data

generated by Levine-Fricke from previous site investigations and approved recycling the water at its Redwood City facility prior to shipping the water to the facility. Transportation and disposal records of the water are included in Appendix C.1.

The six empty drums are stored in WCC's Pleasant Hill Laboratory and are planned for the use of containing purge water to be generated during quarterly groundwater samplings at the site.

SOIL EXCAVATION AND DISPOSAL

Soil excavation proceeded following the segregation plan as described in Section 3.6. A Case 9020 excavator was employed for the excavation. Excavation stopped right above the groundwater table such that, except for several muddy spots, the bottom was essentially dry. Groundwater was not involved except the initial dewatering as described in Section 3.8. Excavated soil was first temporarily stockpiled on the adjacent parking area to the east, as shown on Figure 4, for further sampling and analysis. The parking area has an asphalt surface and is part of the 40th Street Right-of-Way extension. Each soil stockpile was completed, lined, and covered with 10 mil Visqueen plastic sheeting.

To protect the integrity of San Pablo Avenue, metal sheet piling was installed along the street side of the site before excavation began. For the other three sides of the excavation area, a slope of one horizontal to one vertical was maintained to provide a safe working area.

4.1 SOILS FROM 0- TO 5-FOOT DEPTH AND FROM DESIGNATED HOT SPOT AREAS

Soils from the ground surface to a 5-foot depth and from the designated hot spot areas were excavated and stockpiled separately from July 20 through 22, 1994. Soil samples were collected on July 22 and were sent to Coast-to-Coast Analytical Services, Inc. of San Jose for the specified analyses (Table 3) with 48-hour turnaround time. Field stockpiling and sampling records are included in Appendix D.1.

A total of 72 soil samples were collected from the 0- to 5-foot depth stockpile and were combined into 18 composites at the laboratory for TPHg and BTEX analyses. Four samples were collected from the TPHg-designated stockpile (from SB-8, 9, & 10 hot spots) and were combined into one for TPHg and BTEX analyses, four were from the TPHd-designated stockpile (from D1-9 hot spot) and were combined into one for TPHd analysis, and four were from the waste oil tank stockpile and were combined into one for TRPH and WET CAM 17 metal analyses. Analytical results are summarized in Table 4. Laboratory reports are included in Appendix D.2.

Samples from the 0- to 5-foot depth stockpile showed TPHg concentrations varying from 12 to 140 mg/kg, well below the 1,000 mg/kg maximum limit set by Alta/B&J Landfill. Benzene concentrations varied from below the detection limit to 0.2 mg/kg, also well below the Alta/B&J Landfill's 10 mg/kg limit. TPHg (52 mg/kg) and benzene (0.1 mg/kg) concentrations of the TPHg-designated stockpile were also well below their respective acceptable limits set by the Alta/B&J Landfill. Ms. Amy Dietz, a senior chemical specialist at Alta/B&J Landfill, reviewed the laboratory analytical reports and gave verbal approval for soil disposal at the landfill on August 2, 1994. Soil from these two stockpiles was transported to and disposed of at the landfill from August 3 to 5, 1994. A total of 104 truckloads of 18 cubic yards each were disposed of at the landfill. Copies of non-hazardous waste manifests for each truckload of soil disposed of at the landfill are included in Appendix D.6.

However, the composite sample from the TPHd-designated soil had a TPHd concentration of 3,100 mg/kg, exceeding the Alta/B&J Landfill's 1,000 mg/kg limit. WET CAM 17 metal analysis of the sample from the waste oil tank designated soil showed concentrations of arsenic at 0.08 mg/l and vanadium at 0.34 mg/l; those exceeded Alta/B&J landfill's limits of 0.05 and 0.2 mg/l for arsenic and vanadium, respectively. Other metals were within the landfill's limits. Forward Landfill then reviewed these chemical results and accepted the soils for disposal there. Eighteen loose cubic yards of the TPHd-designated soil and 17 loose cubic yards of the waste oil tank designated soil were transported to, and disposed, at the Forward Landfill on August 24, 1994. Copies of non-hazardous waste manifests for each truckload of soil disposed at the Forward Landfill are included in Appendix D.5.

4.2 SOIL FROM 5- TO 9.5-FOOT DEPTH

Soil from the 5- to 9.5-foot depth in the site west area (Figure 4) was excavated and stockpiled on the designated area on August 8 and 9, 1994. The soil was screened by use of a portable organic vapor analyzer (OVA) equipped with a photoionization detector (PID). No part of the soil registered more than 200 ppm TPH. The soil was accepted by Alta/B&J Landfill and disposed there in August 15, 1994. A total of 40 truck loads of 18 cubic yards each were disposed at the landfill. Copies of non-hazardous waste manifests for each truckload of soil disposed at the landfill are included in Appendix D.6.

Soil from 5- to 9.5-foot depth in the site east area (Figure 4) was excavated and stockpiled separately in August 9 and 10, 1994. Soil samples were collected on August 12 and were sent to Chromalab of San Ramon for TPHg and BTEX analyses with 48-hour turnaround time. Field stockpiling and sampling records are included in Appendix D.3. A total of 28 soil samples were collected and were combined into seven composites at the laboratory before analysis. Analytical results are summarized in Table 4. Laboratory reports are included in Appendix D.4.

TPHg concentrations varied from 2.4 to 140 mg/kg, well below the 1,000 mg/kg maximum limit set by Alta/B&J Landfill. Benzene concentrations varied from below the detection limit to 0.78 mg/kg, also well below the landfill's 10 mg/kg limit. Alta/B&J Landfill reviewed these chemical data and accepted the soil for disposal. A total of 34 truck loads of 18 cubic yards each were transported to and disposed of at the landfill on August 23 and 24, 1994. Copies of non-hazardous waste manifests for each truckload of soil disposed at the landfill are included in Appendix D.6.

4.3 DISPOSAL OF DRUMMED SOIL CUTTINGS

A total of 22 drums of 55-gallon size containing soil cuttings (approximately 6 cubic yards) were identified on site prior to excavation. These soil cuttings were generated during previous site investigations by Levine-Fricke. The drums were emptied onto appropriate stockpiles of excavated soil based on the label on each drum identifying the origin of the soil cuttings. For example, soil cuttings from borings SB-8, SB-9 and SB-10 by Levine-Fricke were mixed with the soil of TPHg-designated hot spots stockpile prior to sampling for TPHg analysis. Soil cuttings generated from off-site borings with high TRPH concentrations (SB-12, SB-14, SB-18 and SB-19 by Levine-Fricke, Reference 3) were mixed with the soil of the waste oil tank area designated stockpile prior to sampling. Soil cuttings from other off-site borings had primarily TPHg contamination and were thus also mixed with the soil of TPHg-designated hot spots stockpile prior to sampling. Therefore, the drummed soil cuttings were properly disposed of, along with the excavated soil, to either Alta/B&J or Forward Landfill as discussed previously.

4.4 SUMMARY OF EXCAVATION AND DISPOSAL VOLUMES

The volumes of soil excavated from the site and disposed of at the two landfills are summarized in Table 5. A recorded volume of 3,204 loose cubic yards of soil was disposed of at Alta/B&J Landfill, and a recorded volume of 35 loose cubic yards of soil was disposed of at Forward Landfill.

At the completion of the soil excavation and before backfilling, dimensions of the excavation area were measured as shown on Figure 5. The measurement indicated that the bank cubic yardage (before being excavated, or in-place cubic yards) of soil excavated was calculated to be 2,318. Detailed volume calculations are presented in Appendix D.7. The volume of the soil expanded approximately 40 percent after it had been excavated ($3,239$ loose cubic yards / $2,318$ bank cubic yards = 1.4). This expansion factor is within the expected range when consolidated clayey type soil is excavated. The soil excavated from this site consisted of primarily clayey silt and silt clay type soil.

CONFIRMATION SOIL SAMPLING IN EXCAVATION PIT

5.1 SAMPLING LOCATIONS AND METHOD

A WCC technician collected soil samples from the side walls and bottom of the excavation pit after the completion of excavation and before backfilling. The workplan approved by ACHA specified five soil samples per side wall and no samples on the bottom. However, at the completion of excavation several wet and oily looking spots were observed on the bottom of the pit, as illustrated on Figure 6. On the sampling day of August 15, 1994, Ms. Susan Hugo of ACHA was present on site and agreed with the onsite WCC representative that the original sampling plan should be modified to include soil samples on the bottom of the excavation pit. Ms. Susan Hugo's inspection record is included in Appendix E.1. The final agreed sampling locations are shown on Figure 6. Four soil samples were collected per side wall and six from the bottom of the excavation pit.

Soil samples were collected in 2.5-inch-diameter, 6-inch-long pre-cleaned brass liners using a hand-operated soil sampler with a slide hammer assembly. After each sample was collected, the ends of the brass liner were immediately covered with Teflon sheet, then plastic end caps, and finally wrapped with duct tape. Samples were labeled with identifying information, stored in an ice chest cooled with ice, and transported under chain-of-custody procedures to Chromalab of San Ramon for chemical analyses. Sampling equipment were cleaned before each sample collection by scrubbing in an Alconox solution followed by rinsing three times with deionized water.

On the side walls, soil samples were collected 6 inches above the floor of the excavation pit. At each sampling location, a 1-foot-deep hole was dug horizontally into the side wall. A hand-held sampler was inserted into the hole and hammered horizontally further into the side wall to collect the soil sample. This collection method should minimize volatilization and provide representative soil samples. On the floor of the excavation pit, however, groundwater had already seeped in at several low spots. Soil samples were collected by removing the top 3 inches of soil and driving the sampler vertically into the newly exposed floor. All samples

collected from the bottom were saturated with groundwater. Field sampling notes are included in Appendix E.2.

5.2 ANALYTICAL RESULTS

Soil samples were analyzed for BTEX, TPHg, TPHd, TRPH, and five metals (cadmium, chromium, lead, nickel, and zinc) as outlined in the workplan. PCBs, PNAs, and chlorinated hydrocarbons were not analyzed because they were not detected during previous site investigations and tank removals. Laboratory analytical reports are included in Appendix E.3. Analytical results are summarized in Table 6 and are also plotted on Figure 7.

Concentrations of the five metals are all well below their respective Total Threshold Limit Concentrations (TTLC) as given in Title 22 of the California Code of Regulations for the definition of characteristics of toxicity. Except for lead in sample B-G-1, the five metal concentrations in all samples are also below ten times those of their respective Soluble Threshold Limit Concentrations (STLC) as defined in the same regulations. The lead concentration in sample B-G-1 (54 mg/kg) marginally exceeded ten times its STLC value (5.0 mg/l). However, it must be realized that not all the lead may be solubilized during the STLC extraction process. Given that the lead concentrations in every other sample are all well below ten times the STLC value, the statistical meaning of one marginally exceeded sample may not be significant. In summary, the five metals do not appear to be at hazardous waste levels as measured by either TTLC or STLC.

Significantly elevated concentrations of petroleum hydrocarbons were detected on sidewalls and the bottom of the excavation pit, with benzene concentrations up to 3.8 mg/kg (sample B-D-1), gasoline up to 1,000 mg/kg (sample B-C-2), and diesel up to 18,000 mg/kg (also sample B-D-1). The total recoverable petroleum hydrocarbons (TRPH, Standard Method 5520E&F) includes both petroleum oil and grease and a major portion (the heavier fraction) of diesel. The reported TRPH in soil samples N-4, W-4, and B-D-1 was probably the diesel fraction (not representing the petroleum oil and grease), because the diesel was detected at much higher concentrations in these samples. Whereas the TRPH measured in sample B-G-1 (120 mg/kg) was likely petroleum oil and grease, since that sample's diesel concentration was below the detection limit (<10 mg/kg).

High diesel concentrations were detected in the former diesel tank and its downgradient area (samples N-4, W-3, W-4, and B-D-1). Sample B-D-1 had nearly 2 percent diesel, indicating the presence of free diesel product. Levine-Fricke previously also reported free product in monitoring well LF-1 (discussed in Section 2.1), which was located near the area of sample W-3. The upgradient sidewalls (east and south) of the excavation pit had little diesel contamination.

On the other hand, gasoline contamination appeared to have been widespread across the entire site, except in the W-1 area. The highest concentration (1,000 mg/kg) was detected near the former gasoline tank cluster area (sample B-C-2). However, sample N-1, which is located near the northeastern corner and not in the downgradient direction of the former gasoline tanks, also showed a very high gasoline concentration (920 mg/kg). This high gasoline contamination in the sample N-1 area may not be necessarily attributed to the leakage of onsite gasoline tanks. USTs in the neighboring properties are also potential contamination sources to this site.

In summary, diesel contamination is primarily localized in the former diesel tank and its downgradient area. Free diesel product likely still exists in the same area. Gasoline contamination has been widely spread with concentrations of up to 1,000 mg/kg. Petroleum oil and grease was not detected in the former waste-oil tank area, but was measured at 120 mg/kg in one soil sample from the former gasoline tank cluster area. The five metals (cadmium, chromium, lead, nickel, and zinc) do not appear to be measured by either TTLC or STLC.

BACKFILLING

Backfilling proceeded immediately after the confirmation soil sampling without waiting for the analytical results. This is because of the urgency, as indicated by both the site developer (Catellus) and the City of Emeryville, to build the 40th Street extension through the site. In addition, the site has been excavated horizontally to the site boundary and vertically to the groundwater table. Further excavation to below the groundwater table would require dewatering, which would increase the excavation cost dramatically and which may not be the most cost-effective way to remediate the saturated zone. Further excavation to beyond the site boundary is inappropriate at this time because the source(s) responsible for the off-site contamination has not been identified. Leaking underground storage tanks have also been identified at neighboring sites.

The source of the imported fill soil was described in Section 3.7. Soil hauling and backfilling operations were conducted by Remedial Solutions Inc. of Fremont. A WCC soil engineer was onsite full time to supervise field operations and to conduct compaction testing by nuclear probe method (ASTM D2922). Soil placement and compaction were conducted from August 16 through 22, 1994 and generally followed the Soil Excavation and Backfilling Plan contained in Appendix B of the workplan. Soil was first transported to the site, adjusted for moisture content, spread uniformly across the site in an 8-inch lift, and then compacted with a self-propelled sheepfoot roller (model CAT CP-558). Compaction tests were performed before the placement of the next lift. Any lift that did not meet the minimum of 90 percent relative compaction was recompacted and retested until the minimum compaction requirement was met.

As requested by the City of Emeryville, the site was backfilled from the bottom of excavation to approximately 3 feet below the original grade. The City will grade the top 3 feet for road construction. Approximately 1,387 bank cubic yards of soil was imported and backfilled. Appendix D.7 presents the volumetric calculations.

The sheet piling installed along the San Pablo Avenue side before excavation began was removed at the completion of backfilling. The gap (about 1 inch wide) left in place after the

sheet piling was removed was filled and compacted to the same compaction requirement. To address the concerns for street stability after removal of the sheet piling, additional soil was imported to create a 1:1 slope along the San Pablo Street side. The slope soil was also compacted, but compaction testing was not performed. The slope will be regraded later by the City during road construction.

A copy of the compaction report, which has been submitted to the City of Emeryville Public Works Department previously, is included in Appendix F. A copy of the grading permit is included in Appendix B.3.

7.0
SUMMARY

Before excavation began, the three on-site shallow groundwater monitoring wells (LF-1 through LF-3) installed previously by Levine-Fricke were destroyed in accordance with instructions from the Alameda County Flood Control and Water Conservation District, Zone 7. Soil excavation proceeded after WCC reached agreement on the segregation and analysis plan negotiated with Alta/B&J Landfill of Vacaville and Forward Landfill of Stockton. Soil was excavated to the groundwater table vertically (approximately 9.5 feet below grade), and to the site boundary horizontally except the 1:1 slope on three sides of the excavation pit. The slope was needed to maintain the stability of the sidewalls and the safe work environment. The side along San Pablo Avenue was shored with sheet piling. Excavated soil was temporarily stockpiled on the adjacent parking lot for further sampling and analyses.

Soils excavated from the former waste oil tank area and the diesel tank hot spot, a total of 35 loose cubic yards, were accepted by Forward Landfill and disposed of there. Soils from the rest of the site, a total of 3,204 loose cubic yards, were disposed of at Alta/B&J Landfill.

Dimensions of the excavation pit were taped before backfilling. Based on the field measurement, the bank cubic yards (before being excavated, or in-place cubic yards) of soil excavated was calculated to be 2,318. The volume of the soil expanded approximately 40 percent after being excavated (3,239 loose cubic yards / 2,318 bank cubic yards = 1.4). This expansion factor is within the typical range for consolidated clayey-type soil when it is excavated.

Oily-looking soils were observed on the bottom of the excavation pit near the former waste oil tank, the diesel tank, and the gasoline tank areas. A total of 22 oil samples were collected on the sidewalls and the bottom of the excavation pit and were analyzed for BTEX, TPHg, TPHd, TRPH, and five metals (cadmium, chromium, lead, nickel, and zinc). Significant elevated concentrations of BTEX and gasoline were found remaining on sidewalls and the bottom, with benzene concentrations up to 3.8 mg/kg and TPHg up to 1,000 mg/kg. Only one soil sample, obtained near the southwest corner of the excavation pit, had concentrations of BTEX and gasoline below detection limits.

High diesel concentrations (up to 18,000 mg/kg) were also detected in the former diesel tank and its downgradient area. Free diesel product likely still exists in the diesel tank area.

Petroleum oil and grease (reported as TRPH, total recoverable petroleum hydrocarbons) was not detected in samples from the former waste oil tank area, but was found in one soil sample at 120 mg/kg from the former gasoline tank cluster area. The TRPH reported in other samples was probably the heavier fraction of the diesel, not the petroleum oil and grease. The five metals do not appear to be at hazardous waste levels as measured by either TTLC or STLC in Title 22 of the California Code of Regulations for the definition of characteristics of toxicity.

The soil for backfilling was imported from the stockpile near the south terminus of Shellmound Street and owned by the City of Emeryville. Chemical and geotechnical tests were not conducted on the soil for this project, but were done previously for other projects by others. The imported soil was compacted to a minimum of 90 percent relative compaction in 8-inch lifts. Field compaction testing was performed using ASTM Method D2922. As requested by the City of Emeryville, the site was backfilled from the bottom of the excavation to approximately 3 feet below the original grade. The City will grade the top 3 feet for road construction. Approximately 1,387 bank cubic yards of soil was imported and backfilled.

CONCLUSIONS AND RECOMMENDATIONS

The analytical results of the confirmation soil samples collected in the excavation pit indicate that significant levels of gasoline contamination still exist in the soil remaining throughout the site, except a small area near the southwest corner. Free diesel product also likely exists in the former diesel tank and its downgradient area. The following actions are recommended:

- After the completion of the 40th Street construction, a 4-inch-diameter well should be constructed in the area of former monitoring well LF-1. This well will serve as both on-site monitoring well and free-product recovery well. Free-product recovery activities should be initiated as soon as possible to prevent its further migration. A 2-inch-diameter monitoring well should also be constructed in the area immediately outside the eastern boundary of the site near the southeastern corner. This well will serve as an upgradient monitoring well.
- A Problem Assessment Report (PAR) should be prepared to delineate the contamination and to evaluate remedial alternatives for groundwater and soil. Because leaking USTs have also been identified in neighboring sites and the plumes originating from different sites may be commingling in the region, we recommend a regional approach to remediation in this area. It may be very difficult to remediate contaminated groundwater and soil related to the Celis site alone since the plumes from neighboring sites, especially those upgradient, may serve as continuous sources of contamination to this site.

9.0
LIMITATIONS

This report has been prepared by the staff of Woodward-Clyde Consultants solely for the use of the client. The scope was limited to the contract-specified scope of work as defined by the client.

The data, information, interpretations, conclusions, and recommendations contained in this report are presented solely as preliminary bases and guides to the existing environmental conditions of the site. The conclusions and professional opinions presented herein were developed by Woodward-Clyde Consultants within the limits prescribed by the client and in accordance with generally accepted engineering practice in Northern California at the time this investigation was performed. As with all environmental and geotechnical reports, the opinions expressed here are subject to revisions in light of new information which may be developed in the future, and no warranties are expressed or implied. Any reliance on this report by third parties shall be at such party's sole risk.

Soil deposits may vary in type, strength and many other important properties between points of observation and exploration. Additionally, changes can occur in groundwater and soil moisture conditions due to seasonal variations, or for other reasons. Furthermore, the distribution of chemical concentrations in the soil and groundwater can vary spatially and over time. The chemical analysis results, valid as of the time of collection, are based on data collected at the sampling locations only. Therefore, it must be recognized that Woodward-Clyde Consultants does not and cannot have complete knowledge of the subsurface conditions underlying the subject site. The opinions presented are based upon the findings at the points of exploration and upon interpretative data, including interpolation and extrapolation of information obtained at points of observation.

REFERENCES

-
1. Woodward-Clyde Consultants, June 1994. Workplan for Additional Site Investigation and Limited Soil Excavation, Celis Alliance Fuel Station, 4000 San Pablo Avenue, Emeryville, California.
 2. Regional Water Quality Control Board - North Coast, San Francisco Bay, and Central Valley Regions (RWQCB), August 1990. Tri-Regional Board Staff Recommendation for Preliminary Evaluation and Investigation of Underground Tank Sites. Appendix A -Reports, August 1991.
 3. Levine-Fricke, June 1993. Phase I Environmental Site Assessment, 40th Street Right-of-Way, Emeryville, California.
 4. Levine-Fricke, September 1993. Phase II Investigation Results, Proposed 40th Street Right-of-Way, Emeryville, California.
 5. Levine-Fricke, February 1994. Update of Approximate Costs for Remediating Petroleum Hydrocarbon-Affected Soil and Ground Water at the 40th Street Right-of-Way Site, Emeryville, California.
 6. Levine-Fricke, March 1994. Further Soil and Ground-water Investigation, Fuel Station, 40th Street Right-of-Way, Emeryville, California.
 7. Levine-Fricke, July 1994. Report on Removal of Six Underground Fuel Storage Tanks and Associated Piping, Celis Alliance Fueling Station, 4000 San Pablo Avenue, Emeryville, California.

TABLES

TABLE 1
ANALYTICAL RESULTS FOR SOIL SAMPLES COLLECTED FROM THE FUEL STATION
40TH STREET RIGHT-OF-WAY, EMERYVILLE, CALIFORNIA
(concentrations in milligrams per kilogram [mg/kg])

| Sample Name | Depth (ft) | Sample Date | TPHg | TPHd | TPHmo | Benzene | Toluene | Ethyl-benzene | Total Xylenes | TRPH | PCBs |
|-------------|------------|-------------|-------|------|-------|---------|---------|---------------|---------------|------|------|
| LF-1-4.5 | 4.5 | 07-Aug-93 | 550 | 220 | 16 | 0.84 | 1.2 | 5.6 | 2.7 | 77 | NA |
| LF-1-9.5 | 9.5 | 07-Aug-93 | 470 | 18 | <10 | 0.97 | <0.005 | 6.6 | 8.9 | <30 | NA |
| LF-1-14.5 | 14.5 | 07-Aug-93 | 8.4 | 16 | <10 | 0.14 | 0.17 | 0.081 | 0.37 | 60 | NA |
| LF-2-9.5 | 9.5 | 07-Aug-93 | 740 | 14 | <10 | 4.7 | 35 | 13 | 68 | 30 | NA |
| LF-2-14.5 | 14.5 | 07-Aug-93 | <0.5 | <10 | <10 | 0.009 | 0.012 | <0.005 | 0.015 | <30 | NA |
| LF-3-9.5 | 9.5 | 07-Aug-93 | 75 | <10 | <10 | 0.062 | 0.28 | 1.1 | 1.1 | 37 | NA |
| LF-3-14.5 | 14.5 | 07-Aug-93 | <0.5 | <10 | <10 | 0.014 | <0.005 | 0.01 | 0.007 | <30 | NA |
| LF-4-5.0 | 5 | 28-Jan-94 | 0.8 | <10 | <10 | 0.083 | <0.005 | <0.005 | 0.034 | NA | NA |
| LF-4-10.0 | 10 | 28-Jan-94 | 220 | 19 | <10 | 1.7 | 6.7 | 4.5 | 24 | NA | NA |
| SB-1-7 | 7 | 08-Aug-93 | 850 | 240 | 27 | 5.4 | <0.005 | 25 | 42 | 290 | NA |
| SB-1-9.5 | 9.5 | 08-Aug-93 | 180 | 220 | <50 | 0.89 | 1.1 | 4.3 | 18 | 130 | NA |
| SB-1-14.5 | 14.5 | 08-Aug-93 | 7.4 | <10 | <10 | 0.44 | 0.44 | 0.14 | 0.61 | 60 | NA |
| SB-2-7 | 7 | 08-Aug-93 | 780 | 790 | 57 | 8 | <0.005 | 31 | 140 | 160 | ND |
| SB-2-9.5 | 9.5 | 08-Aug-93 | 720 | 200 | <50 | 2.4 | 5.2 | 14 | 59 | 210 | NA |
| SB-2-14.5 | 14.5 | 08-Aug-93 | 1 | <10 | 12 | 0.2 | 0.21 | 0.021 | 0.12 | 43 | ND |
| SB-3-9.5 | 9.5 | 07-Aug-93 | 580 | 11 | <10 | 9.7 | 50 | 15 | 90 | 37 | ND |
| SB-3-14.5 | 14.5 | 07-Aug-93 | 0.9 | <10 | <10 | 0.092 | 0.16 | 0.031 | 0.17 | 37 | ND |
| SB-4-7 | 7 | 08-Aug-93 | 380 | 13 | <10 | 3 | 5.2 | 8.2 | 18 | 70 | NA |
| SB-4-14.5 | 14.5 | 08-Aug-93 | <0.5 | <10 | <10 | 0.026 | 0.005 | 0.019 | 0.023 | 210 | NA |
| SB-5-7 | 7 | 08-Aug-93 | 410 | 15 | <10 | 2.4 | 0.6 | 16 | 6.3 | 37 | NA |
| SB-5-14.5 | 14.5 | 08-Aug-93 | <0.5 | <10 | <10 | 0.011 | <0.005 | 0.008 | 0.008 | 93 | NA |
| SB-6-9.5 | 9.5 | 08-Aug-93 | 490 | 51 | <10 | 2.7 | <0.005 | 15 | 15 | 67 | NA |
| SB-6-14.5 | 14.5 | 08-Aug-93 | <0.5 | <10 | <10 | <0.005 | <0.005 | <0.005 | <0.005 | <30 | NA |
| SB-7-9.5 | 9.5 | 07-Aug-93 | 750 | 52 | 66 | 2.5 | 8.5 | 22 | 93 | 170 | NA |
| SB-7-14.5 | 14.5 | 07-Aug-93 | 2.8 | <10 | <10 | <0.005 | <0.005 | 0.029 | 0.03 | <30 | NA |
| SB-8-9.5 | 9.5 | 08-Aug-93 | 2,800 | 110 | <50 | 22 | 9.5 | 82 | 290 | 130 | NA |
| SB-8-14.5 | 14.5 | 08-Aug-93 | <0.5 | <10 | 11 | 0.009 | <0.005 | <0.005 | <0.005 | 37 | NA |
| SB-9-7 | 7 | 07-Aug-93 | 210 | 14 | <10 | 2.8 | 13 | 5.1 | 29 | <30 | NA |
| SB-9-9.5 | 9.5 | 07-Aug-93 | 1,200 | NA | NA | 14 | 81 | 26 | 140 | NA | NA |
| SB-9-14.5 | 14.5 | 07-Aug-93 | <0.5 | <10 | <10 | 0.079 | 0.059 | 0.011 | 0.041 | 77 | NA |
| SB-10-7 | 7 | 07-Aug-93 | 73 | NA | NA | 2.6 | 4.5 | 1.6 | 7.7 | NA | NA |
| SB-10-9.5 | 9.5 | 07-Aug-93 | 1,100 | <10 | <10 | <0.005 | 7.8 | <0.005 | 22 | 40 | NA |
| SB-10-14.5 | 14.5 | 07-Aug-93 | 8.6 | <10 | <10 | 0.48 | 0.29 | 0.1 | 0.48 | <30 | NA |
| SB-11-14.5 | 14.5 | 09-Aug-93 | <0.5 | <10 | 11 | <0.005 | <0.005 | <0.005 | <0.005 | 40 | NA |
| EB-1-5.0 | 5 | 28-Jan-94 | <0.5 | <10 | 17 | <0.005 | <0.005 | <0.005 | <0.005 | NA | NA |
| EB-1-10.0 | 10 | 28-Jan-94 | <0.5 | <20 | 49 | <0.005 | <0.005 | <0.005 | <0.005 | NA | NA |

Data extracted from Levine-Fricke's Reports of September 1993 and March 1994 (References 3 and 5)

NA = not available; ND = not detected.

TPHg = total petroleum hydrocarbons as gasoline

TPHd = total petroleum hydrocarbons as diesel

TPHmo = total petroleum hydrocarbons as motor oil

TRPH = total recoverable petroleum hydrocarbons

PCBs = polychlorinated biphenyls

TABLE 2
ANALYTICAL RESULTS FOR GROUNDWATER SAMPLES
40th Street Right-of-Way, Emeryville, California
(concentrations in milligrams per liter [mg/l])

| Sample Name | Sample Date | TPHg | TPHd | TPHmo | Benzene | Toluene | Ethyl-benzene | Total Xylenes | TRPH |
|-------------|-------------|-------|-------|-------|---------|---------|---------------|---------------|------|
| LF-1AG | 7-Aug-93 | 100 | 41 | <2.5 | 13 | 9.4 | 3.1 | 14 | 11 |
| LF-2AG | 7-Aug-93 | 13 | 0.095 | <0.50 | 2.4 | 2.9 | 0.5 | 2 | <5 |
| LF-3AG | 7-Aug-93 | 11 | 0.78 | <0.25 | 1.5 | 0.17 | 2.9 | 5.1 | <5 |
| GWEB1 | 28-Jan-94 | <0.05 | 0.081 | <0.05 | <0.0005 | 0.00057 | <0.0005 | 0.0026 | NA |
| LF-4 | 28-Jan-94 | 18 | 1.4 | 0.16 | 1 | 1.9 | 0.88 | 4.7 | NA |
| LF-4dup | 28-Jan-94 | 21 | 2.2 | 0.21 | 1.1 | 2 | 0.80 | 4.2 | NA |

Data extracted from Levine-Fricke's Reports of September 1993 and March 1994 (References 3 and 5).

NA = not available; ND = not detected.

TPHg = total petroleum hydrocarbons as gasoline.

TPHd = total petroleum hydrocarbons as diesel.

TPHmo = total petroleum hydrocarbons as motor oil.

TRPH = total recoverable petroleum hydrocarbons

TABLE 3

SOIL SEGREGATION AND ANALYSIS REQUIREMENTS FOR DISPOSAL AT ALTA/B&J LANDFILL
 CELIS ALLIANCE FUEL STATION, EMERYVILLE, CALIFORNIA

| Area | Approx. size | Approx. volume of soil (bank cubic yards) (1) | Type of analysis | # of individual samples (2) | # of composite samples (2) | # of analysis |
|---|--|--|---|--------------------------------|-------------------------------|---------------|
| 0' - 5' below ground surface | 90'W x 95'L x 5'D | 1580 | TPHgas, BTEX | 72 | 18 | 18 |
| SB-8 hot spot | 10'W x 10'L x 4.5'D | 17 | TPHgas, BTEX | 4 | 1 | 1 |
| SB-9 hot spot | 10'W x 10'L x 4.5'D | 17 | TPHgas, BTEX | | | |
| BS-10 hot spot | 10'W x 10'L x 4.5'D | 17 | TPHgas, BTEX | | | |
| D1-9 hot spot | 10'W x 10'L x 4.5'D | 17 | TPHdiesel | 4 | 1 | 1 |
| Waste oil tank area | 10'W x 10'L x 4.5'D | 17 | Petroleum Oil&Grease | 4 | 1 | 1 |
| | | | WET CAM 17 metals | 4 | 1 | 1 |
| Non-hot spot areas: | | | | | | |
| 5' - 9.5', west of eastern wall of the gas station | 90'W x 60'L x 4.5'D (minus hot spots) | 850 | no analysis, haul to B&J landfill if field meter registers less than 900 ppm TPH | | | |
| 5' - 9.5', east of eastern wall of the gas station | 90'W x 40'L x 4.5'D (minus hot spots) | 550 | TPHgas, BTEX | 28 | 7 | 7 |
| Total volume: 3065 | | | | | | |

Notes:

(1) - The actual volumes of soil excavated were less due to the 1:1 slope on three sides of the excavation pit.

(2) - 4 soil samples were collected per approximately 100 cubic yards of soil, which were then composited to one at laboratory for analysis.

TABLE 4

ANALYTICAL RESULTS FOR SOIL SAMPLES COLLECTED FROM EXCAVATED SOIL STOCKPILES
 CELIS ALLIANCE FUEL STATION, EMERYVILLE, CALIFORNIA

| Soil Stockpile | Sample ID | Benzene mg/kg | Toluene mg/kg | Ethyl benzene mg/kg | Xylenes mg/kg | TPHg mg/kg | TPHd mg/kg | TRPH (1) mg/kg | WET CAM 17 metals (2) mg/l |
|---|---------------------|------------------|------------------|---------------------------|------------------|---------------|---------------|-------------------|----------------------------------|
| 0 to 5 feet below grade | S-0-5ft-1-A,B,C,D | 0.15 | 1.1 | 1.2 | 9 | 110 | NA | NA | NA |
| | S-0-5ft-2-A,B,C,D | 0.06 | 0.45 | 0.57 | 4.3 | 59 | NA | NA | NA |
| | S-0-5ft-3-A,B,C,D | 0.04 | 0.42 | 0.74 | 5.9 | 83 | NA | NA | NA |
| | S-0-5ft-4-A,B,C,D | 0.14 | 1.1 | 1.5 | 10 | 140 | NA | NA | NA |
| | S-0-5ft-5-A,B,C,D | 0.12 | 0.66 | 0.83 | 5.8 | 77 | NA | NA | NA |
| | S-0-5ft-6-A,B,C,D | 0.05 | 0.13 | 0.22 | 3.2 | 55 | NA | NA | NA |
| | S-0-5ft-7-A,B,C,D | 0.13 | 0.4 | 0.49 | 4.5 | 56 | NA | NA | NA |
| | S-0-5ft-8-A,B,C,D | 0.05 | 0.16 | 0.18 | 3.1 | 48 | NA | NA | NA |
| | S-0-5ft-9-A,B,C,D | 0.2 | 1 | 0.4 | 3.2 | 130 | NA | NA | NA |
| | S-0-5ft-10-A,B,C,D | ND(0.05) | ND(0.05) | ND(0.05) | 0.09 | 48 | NA | NA | NA |
| | S-0-5ft-11-A,B,C,D | 0.03 | 0.03 | 0.05 | 0.19 | 28 | NA | NA | NA |
| | S-0-5ft-12-A,B,C,D | 0.12 | 0.13 | 0.05 | 0.78 | 49 | NA | NA | NA |
| | S-0-5ft-13-A,B,C,D | 0.05 | 0.04 | 0.02 | 0.12 | 27 | NA | NA | NA |
| | S-0-5ft-14-A,B,C,D | 0.14 | 0.14 | 0.1 | 0.29 | 42 | NA | NA | NA |
| | S-0-5ft-15-A,B,C,D | 0.04 | 0.07 | 0.1 | 0.59 | 24 | NA | NA | NA |
| | S-0-5ft-16-A,B,C,D | ND(0.1) | 0.6 | 0.8 | 6.1 | 73 | NA | NA | NA |
| | S-0-5ft-17-A,B,C,D | 0.05 | 0.22 | 0.22 | 1.7 | 20 | NA | NA | NA |
| | S-0-5ft-18-A,B,C,D | 0.019 | 0.064 | 0.096 | 0.8 | 12 | NA | NA | NA |
| Gas hot spots | S-G-A,B,C,D | 0.1 | 1.1 | 1 | 6 | 52 | NA | NA | NA |
| Site east, 5 to 9.5 feet blow grade | S-5-9.5ft-1-A,B,C,D | 0.014 | 0.064 | 0.18 | 1.4 | 25 | NA | NA | NA |
| | S-5-9.5ft-2-A,B,C,D | 0.78 | 1.5 | 1.5 | 7.9 | 140 | NA | NA | NA |
| | S-5-9.5ft-3-A,B,C,D | ND(0.005) | ND(0.005) | ND(0.005) | 0.04 | 2.4 | NA | NA | NA |
| | S-5-9.5ft-4-A,B,C,D | 0.056 | 0.44 | 0.67 | 4.2 | 92 | NA | NA | NA |
| | S-5-9.5ft-5-A,B,C,D | 0.064 | 0.88 | 0.82 | 5.1 | 8.4 | NA | NA | NA |
| | S-5-9.5ft-6-A,B,C,D | 0.026 | 0.16 | 0.14 | 1.1 | 22 | NA | NA | NA |
| S-5-9.5ft-7-A,B,C,D | 0.017 | 0.13 | 0.17 | 1.3 | 23 | NA | NA | NA | |
| Diesel hot spot | S-D-A,B,C,D | NA | NA | NA | NA | NA | 3100 | NA | NA |
| Waste oil tank | S-O&G-A,B,C,D | NA | NA | NA | NA | NA | NA | ND(50) | Sb=ND (0.05) |
| | " | NA | NA | NA | NA | NA | NA | NA | As=0.08 |
| | " | NA | NA | NA | NA | NA | NA | NA | Ba=8.7 |
| | " | NA | NA | NA | NA | NA | NA | NA | Be=ND(0.05) |
| | " | NA | NA | NA | NA | NA | NA | NA | Cd=ND(0.05) |
| | " | NA | NA | NA | NA | NA | NA | NA | Cr=0.07 |
| | " | NA | NA | NA | NA | NA | NA | NA | Co=0.16 |
| | " | NA | NA | NA | NA | NA | NA | NA | Cu=0.07 |
| | " | NA | NA | NA | NA | NA | NA | NA | Pb=ND(0.1) |
| | " | NA | NA | NA | NA | NA | NA | NA | Hg=ND(0.0002) |
| | " | NA | NA | NA | NA | NA | NA | NA | Mo=ND(0.05) |
| | " | NA | NA | NA | NA | NA | NA | NA | Ni=0.34 |
| | " | NA | NA | NA | NA | NA | NA | NA | Se=ND(0.05) |
| | " | NA | NA | NA | NA | NA | NA | NA | Ag=ND(0.01) |
| " | NA | NA | NA | NA | NA | NA | NA | Tl=ND(0.5) | |
| " | NA | NA | NA | NA | NA | NA | NA | V=0.34 | |
| " | NA | NA | NA | NA | NA | NA | NA | Zn=0.2 | |

NOTES:

NA = not available; ND = not detected above the quantification limit given in parenthesis following the ND.

- 1 TRPH = total recoverable petroleum hydrocarbons by Standard Method 5520D&F
- 2 Sb = Antimony, As = Arsenic, Ba = Barium, Be = Beryllium, Cd = Cadmium, Cr = Chromium
 Co = Cobalt, Cu = Copper, Pb = Lead, Hg = Mercury, Mo = Molybdenum, Ni = Nickel
 Se = Selenium, Ag = Silver, Tl = Thallium, V = Vanadium, Zn = Zinc.

TABLE 5

RECORDED VOLUMES OF SOIL DISPOSED AT LANDFILLS
 CELIS ALLIANCE FUEL STATION, EMERYVILLE, CALIFORNIA

| Description | Recorded Volumes of Soil Disposed at | |
|---|--|---|
| | Alta/B&J Landfill (loose cubic yards) | Forward Landfill (loose cubic yards) |
| Soil from 0'-5' below surface | 1,818 | 0 |
| Soil from gas hot spots | 54 | 0 |
| Soil from diesel hot spots | 0 | 18 |
| Soil from waste oil tank area | 0 | 17 |
| Soil from site west, 5'-9.5' below surface | 720 | 0 |
| Soil from site east, 5'-9.5' below surface | 612 | 0 |
| TOTAL VOLUME | 3,204 | 35 |

TABLE 6

ANALYTICAL RESULTS FOR SOIL SAMPLES COLLECTED FROM SIDE WALLS AND BOTTOM OF THE EXCAVATION PIT
CELIS ALLIANCE FUEL STATION, EMERYVILLE, CALIFORNIA

| Sample ID | Benzene mg/kg | Toluene mg/kg | Ethyl benzene mg/kg | Xylenes mg/kg | TPHg mg/kg | TPHd mg/kg | TRPH (1) mg/kg | Cadmium mg/kg | Chromium (total) mg/kg | Lead mg/kg | Nickel mg/kg | Zinc mg/kg |
|-----------|------------------|------------------|---------------------------|------------------|---------------|---------------|-------------------|------------------|------------------------------|---------------|-----------------|---------------|
| E-1 | 0.33 | 3.5 | 3.4 | 16 | 240 | NA | NA | NA | NA | NA | NA | NA |
| E-2 | 0.81 | 3.4 | 1.8 | 8.9 | 170 | 2 | ND(50) | 1.4 | 18 | 4.3 | 34 | 26 |
| E-3 | 2.9 | 18 | 9.2 | 46 | 660 | NA | NA | NA | NA | NA | NA | NA |
| E-4 | 2.6 | 12 | 4.9 | 24 | 380 | 5.2 | ND(50) | 1.4 | 16 | 5.6 | 17 | 30 |
| N-1 | 2.6 | 21 | 11 | 57 | 920 | 21 | ND(50) | 2.1 | 26 | 6.1 | 37 | 40 |
| N-2 | 0.097 | 0.83 | 2.5 | 11 | 250 | 10 | ND(50) | 1.4 | 16 | 2.8 | 26 | 23 |
| N-3 | 0.38 | 3 | 3.6 | 17 | 390 | 96 | ND(50) | 2.6 | 20 | 7.3 | 25 | 40 |
| N-4 | 0.16 | ND(0.1) | 1 | 1.3 | 85 | 310 | 160 | 2.1 | 28 | 5 | 25 | 29 |
| S-1 | 1.7 | 6 | 9.9 | 41 | 800 | NA | NA | NA | NA | NA | NA | NA |
| S-2 | 0.4 | 0.2 | 4 | 12 | 430 | 60 | ND(50) | 2.3 | 28 | 7 | 39 | 43 |
| S-3 | 1.4 | ND(0.13) | 11 | 1.7 | 730 | NA | NA | NA | NA | NA | NA | NA |
| S-4 | ND(0.5) | ND(0.5) | 5.6 | 13 | 560 | 25 | ND(50) | 1.9 | 26 | 8.3 | 23 | 30 |
| W-1 | ND(0.005) | ND(0.005) | ND(0.005) | ND(0.005) | ND(1.0) | ND(1.0) | ND(50) | 2.2 | 27 | 8 | 34 | 45 |
| W-2 | 0.34 | 0.61 | 2.3 | 6.9 | 230 | 34 | ND(50) | 2.3 | 29 | 5.5 | 26 | 42 |
| W-3 | 0.012 | ND(0.01) | 0.029 | 0.043 | 20 | 180 | ND(50) | 1.4 | 19 | 5.6 | 21 | 27 |
| W-4 | ND(0.05) | 0.073 | 0.26 | 0.99 | 80 | 500 | 150 | 2 | 28 | 6.2 | 36 | 38 |
| B-C-1 | 0.081 | 0.11 | 2 | 8.4 | 260 | 68 | ND(50) | 2.3 | 31 | 6.7 | 29 | 37 |
| B-C-2 | 2.4 | 10 | 11 | 49 | 1000 | 75 | ND(50) | 1.3 | 18 | 4 | 19 | 25 |
| B-C-3 | 2.2 | 15 | 7.3 | 39 | 690 | 29 | ND(50) | 1.8 | 27 | 5.2 | 25 | 33 |
| B-O&G-1 | 2.4 | 9.9 | 6.3 | 27 | 490 | 160 | ND(50) | 2.7 | 35 | 8.3 | 41 | 39 |
| B-D-1 | 3.8 | 1.7 | 8.1 | 17 | 650 | 18000 | 15000 | 1.9 | 27 | 7 | 25 | 27 |
| B-G-1 | 0.64 | ND(0.5) | 6.5 | 12 | 540 | ND(10) | 120 | 2.9 | 25 | 54 | 21 | 200 |

NOTES (1) TRPH = total recoverable petroleum hydrocarbons as determined by Standard Method 5520 E&F
(2) NA = not available; ND = not detected above the quantification limit given in parenthesis following the ND.

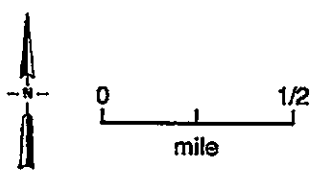

| | | | |
|-----------------------------------|-----------------|---|-------------|
| Project No. 941114NA | 40th Street UST | SITE LOCATION MAP CELI'S ALLIANCE GAS STATION SITE | Figure 1 |
| Woodward-Clyde Consultants | | | |

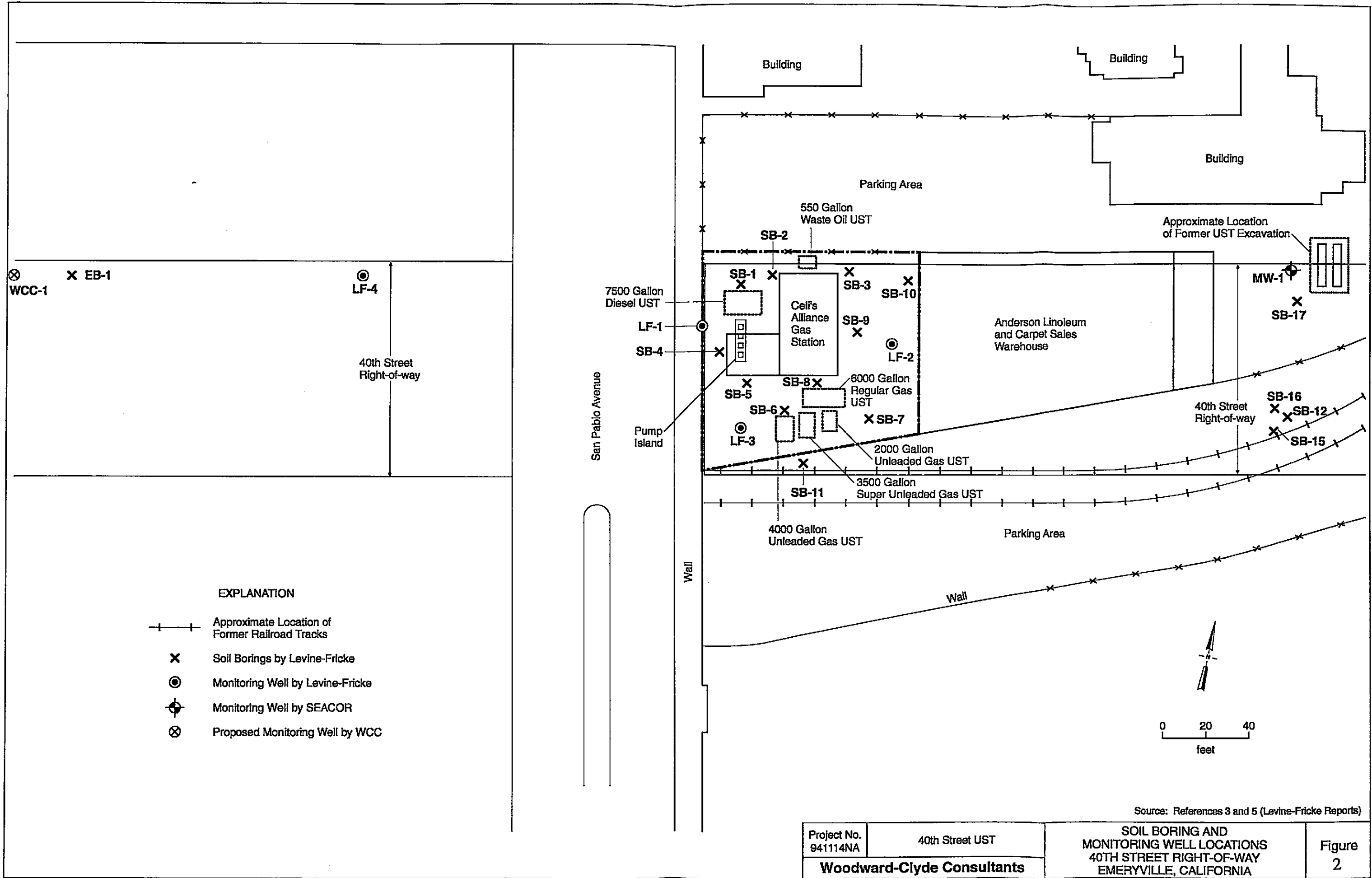

| | | | |
|----------------------------|-----------------|--|-------------|
| Project No. 941114NA | 40th Street UST | SOIL BORING AND MONITORING WELL LOCATIONS 40TH STREET RIGHT-OF-WAY EMERYVILLE, CALIFORNIA | Figure 2 |
| Woodward-Clyde Consultants | | | |

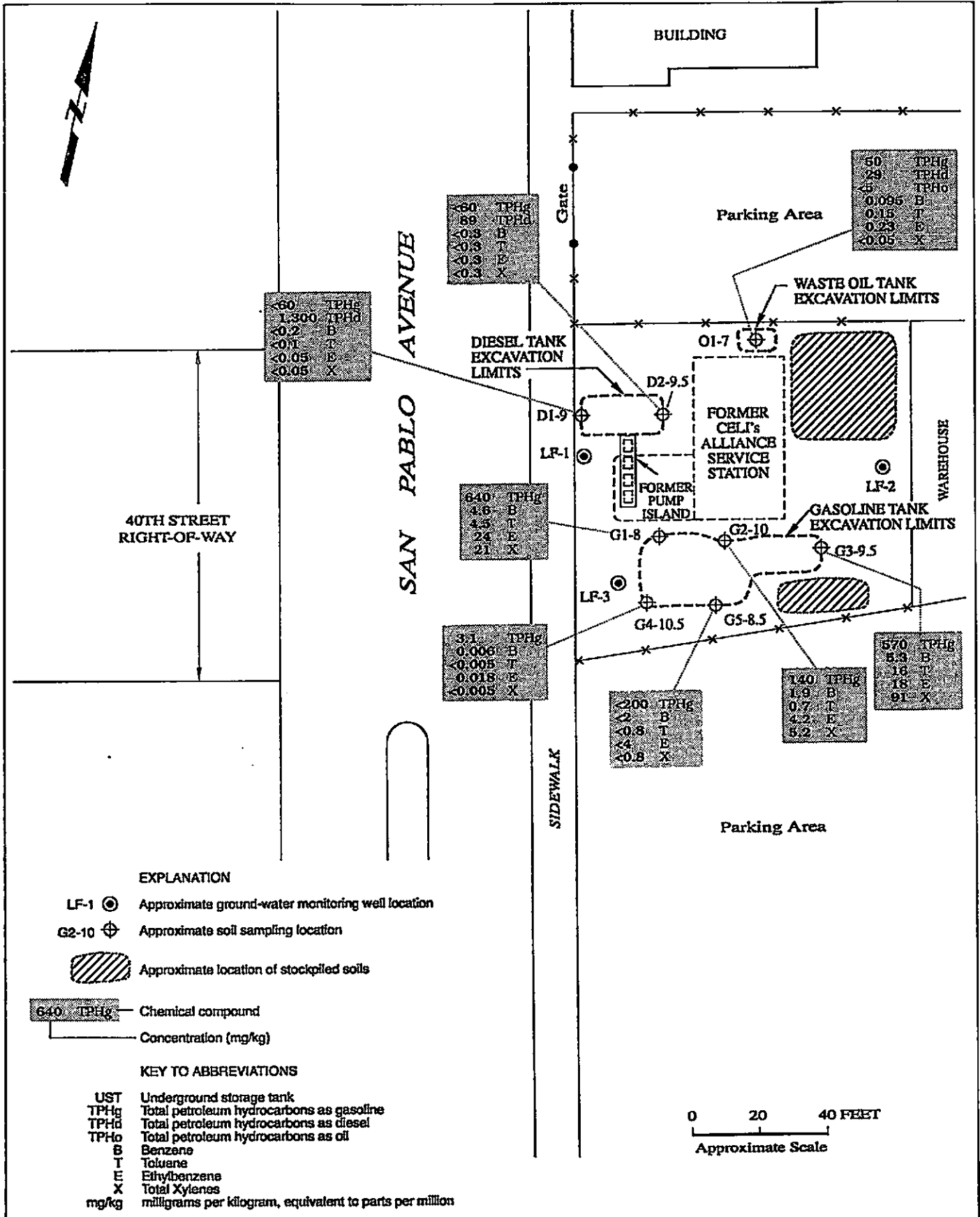

Source: Reference 7 (Levine-Fricke Report)

| | | | |
|----------------------------|-----------------|---|-------------|
| Project No. 941114NA | 40th Street UST | SITE PLAN SHOWING UST EXCAVATIONS, SAMPLING LOCATIONS AND TPH AND BTEX CONCENTRATIONS | Figure 3 |
| Woodward-Clyde Consultants | | | |

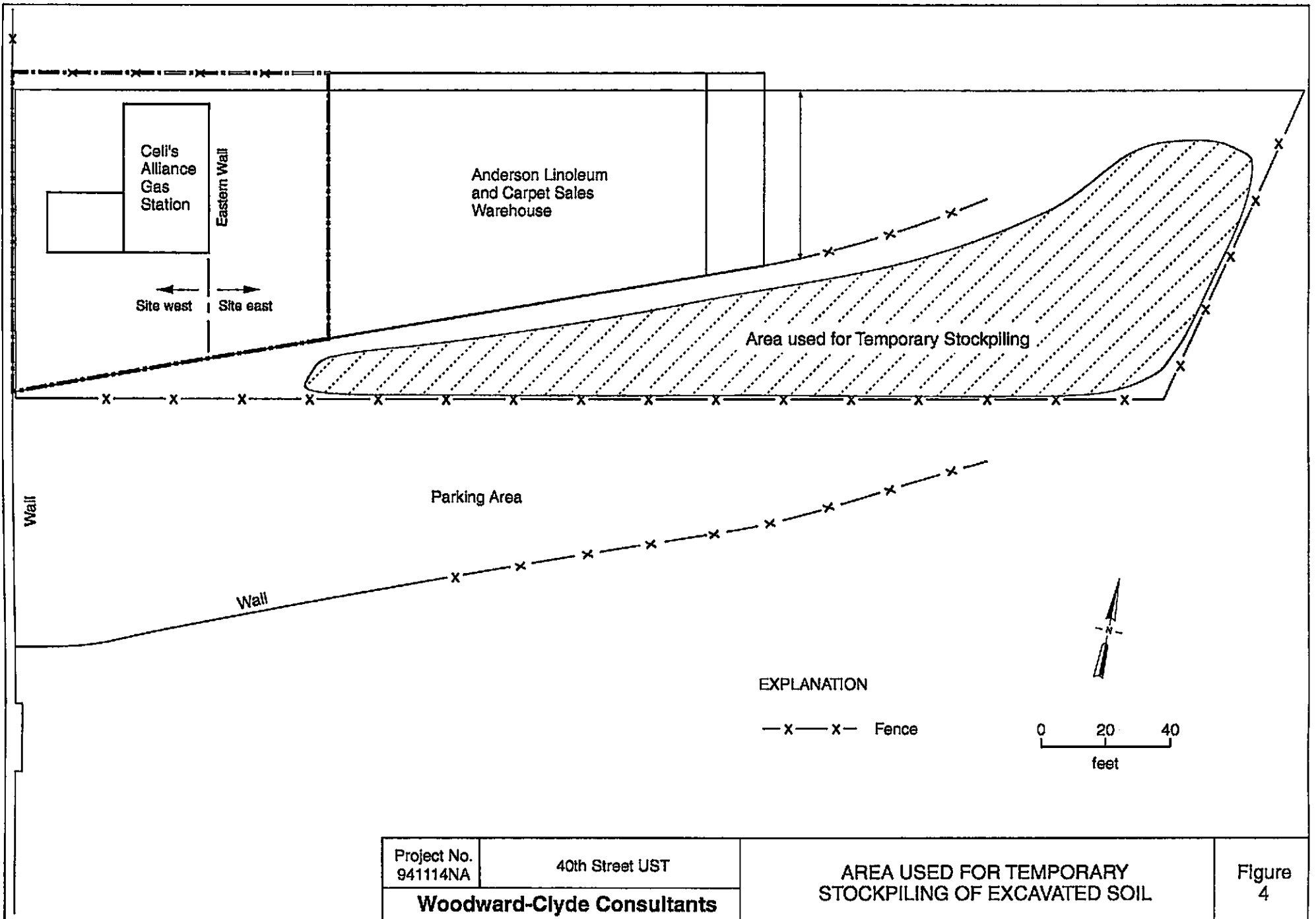

| | | | |
|----------------------------|-----------------|--|-------------|
| Project No. 941114NA | 40th Street UST | AREA USED FOR TEMPORARY STOCKPILING OF EXCAVATED SOIL | Figure 4 |
| Woodward-Clyde Consultants | | | |

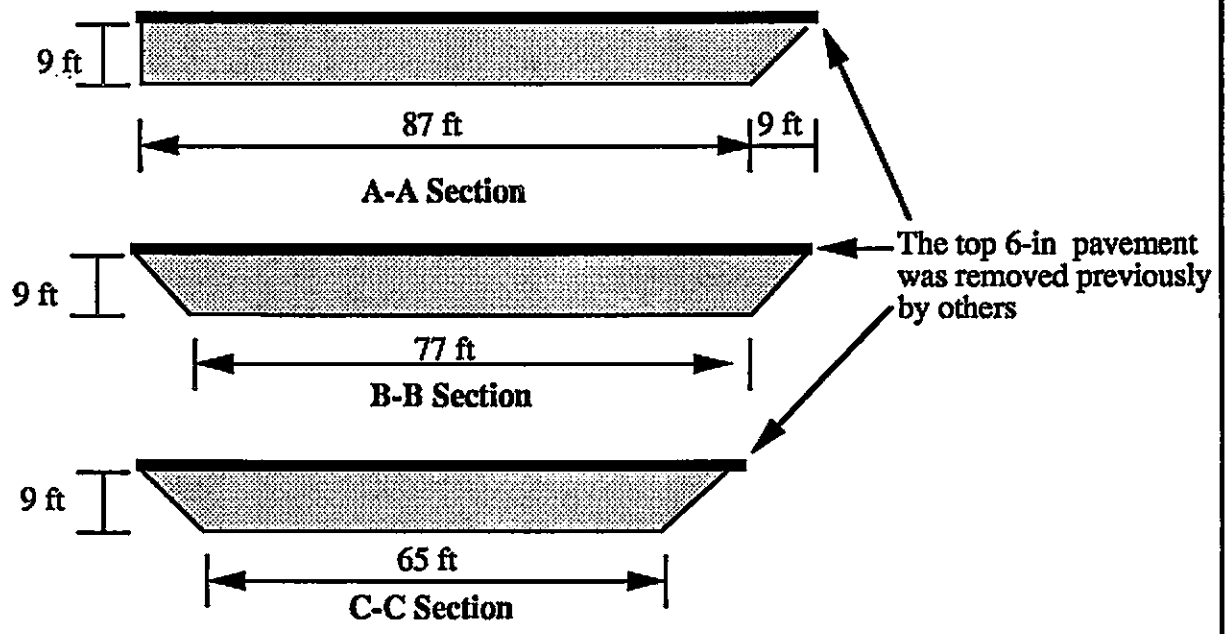
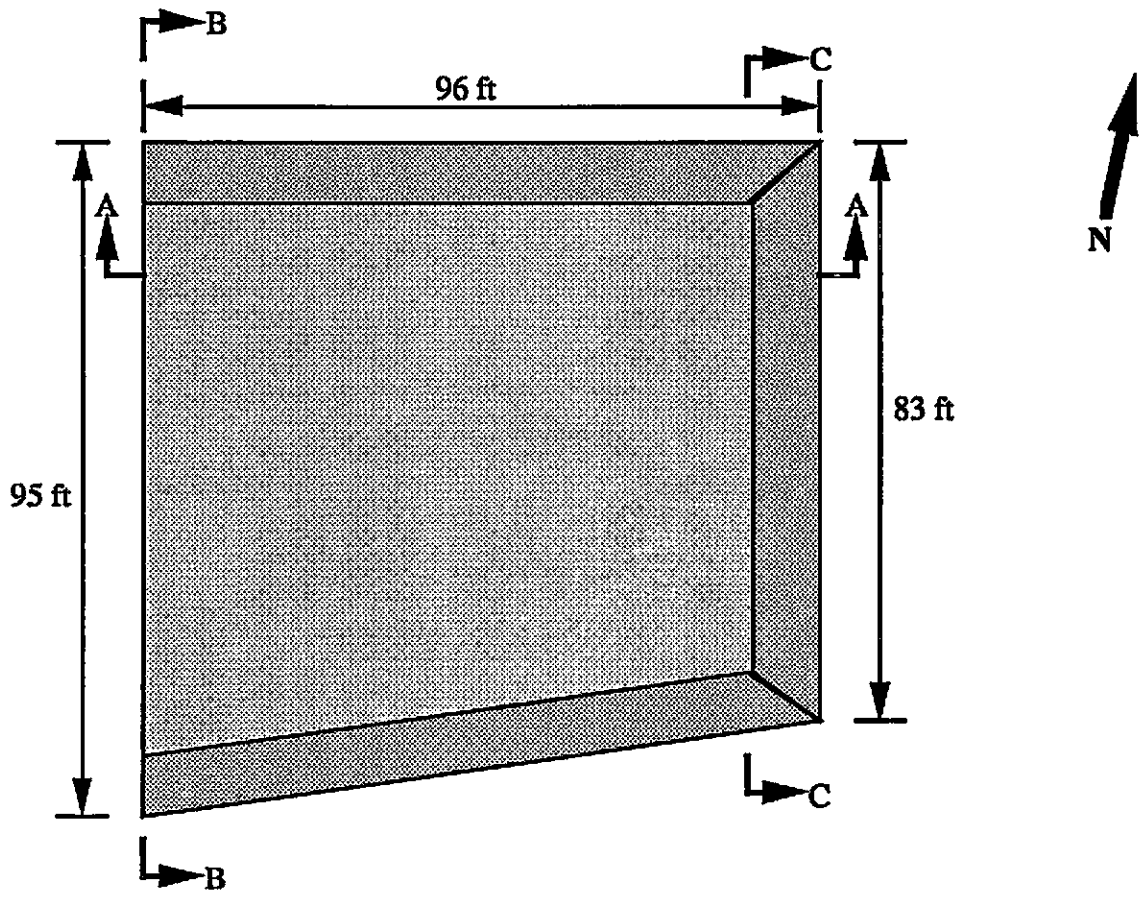

| | | | |
|----------------------------|--|---|-------------|
| Project No. 941114NA | CITY OF EMERYVILLE REDEVELOPMENT AGENCY | RECORDED DIMENSIONS AFTER EXCAVATION 40th Street UST at 4000 San Pablo Avenue | Figure 5 |
| Woodward-Clyde Consultants | | | |



Wet area, soil with strong petroleum odor, looked like saturated with free product

Oily looking soil noticed in this area

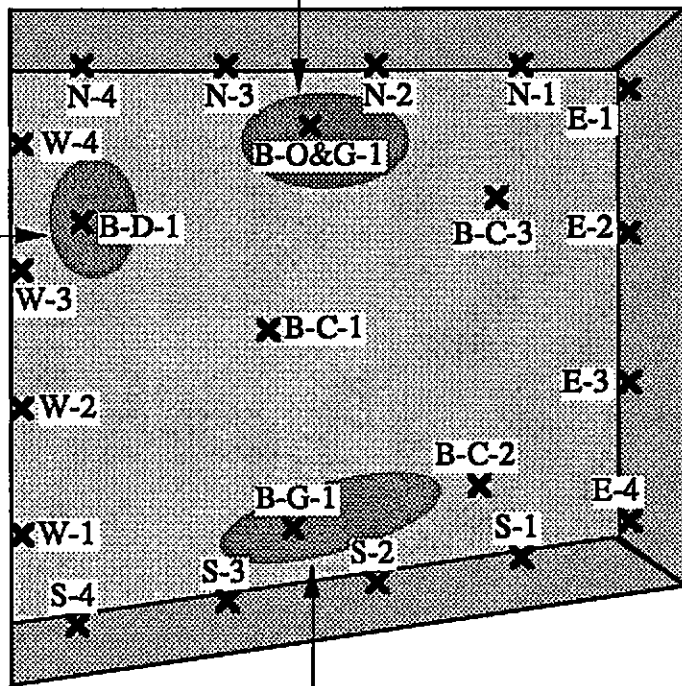

Wet area, strong petroleum odor, soil with oily stains

Project No.
941114NA

CITY OF EMERYVILLE
REDEVELOPMENT AGENCY

SOIL SAMPLING LOCATIONS
AND FIELD OBSERVATIONS

Figure
6

Woodward-Clyde Consultants

40th Street UST at 4000 San Pablo Avenue

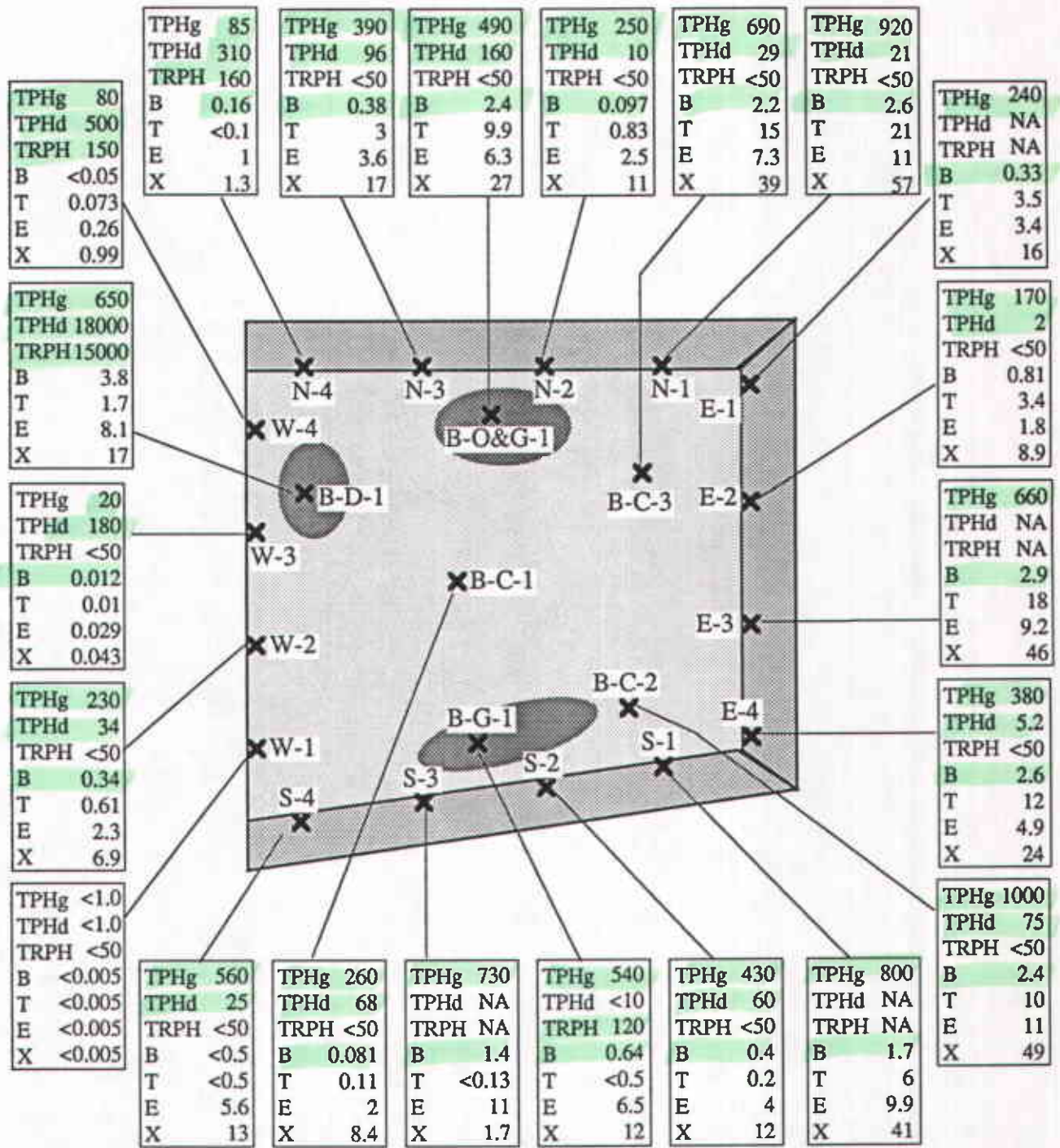

TPHg = total petroleum hydrocarbons as gasoline
 TPHd = total petroleum hydrocarbons as diesel
 TRPH = total recoverable petroleum hydrocarbons

B = benzene
 T = toluene
 E = ethyl benzene
 X = xylenes

Soil samples on side walls were collected 6-in above the bottom floor

Unit of Concentration: mg/kg

Project No.
941114NA

CITY OF EMERYVILLE
REDEVELOPMENT AGENCY

SOIL SAMPLING LOCATIONS
& ANALYTE CONCENTRATIONS

Figure
7

Woodward-Clyde Consultants

40th Street UST at 4000 San Pablo Avenue

APPENDIX A
WELL DESTRUCTION CERTIFICATES

APPENDIX A.1
APPLICATION FOR WELL DESTRUCTION PERMIT

June 21, 1994
941114NA

Mr. Wyman Hong
Alameda County Flood Control
and Water Conservation District
Zone 7
5997 Parkside Drive
Pleasanton, CA 94588

**Subject: Request for Destruction of Three Groundwater Monitoring Wells
Celis Alliance Fuel Station at 4000 San Pablo Avenue
Emeryville, California**

Dear Mr. Hong:

Woodward-Clyde Consultants (WCC) is submitting this permit application for the destruction of three groundwater monitoring wells at Celis Alliance Fuel Station located at 4000 San Pablo Avenue, Emeryville, California (Figure 1). These wells were installed in August 7, 1993, during a site investigation. Their locations are shown in Figure 2. All the three wells are 2 inches in diameter, 20 feet below ground surface (bgs), screened from 5 to 20 feet bgs, and constructed of polyvinyl chloride (PVC) piping.

Petroleum hydrocarbon contamination of shallow groundwater and soil was discovered during the site investigation. As a result of the investigation, Alameda County Health Agency (ACHA) requested the removal of underground storage tanks and contaminated soil beneath the site.

Six underground storage tanks were removed by Levine-Fricke in May 1994. ACHA has also verbally approved a plan to excavate the entire site down to approximately 9 feet bgs. Since the three wells are located within the excavation area, they will have to be destroyed prior to the start of soil excavation.

Several pits and soil piles were created on site during the tank removal operations. These pits and soil piles limit the access of drill rigs to the wells. We thus propose to close these wells with the casing in place, as described below:

- (1) Clean out all bridged or poorly compacted materials to the bottom of each well.
- (2) Neat cement is tremie-pumped into each well. A cap will be placed on top of the casing with an opening for a small-diameter tremie pipe. Sealing

Woodward-Clyde

Mr. Wyman Hong
June 21, 1994
Page 2

material (cement) will then be pumped under pressure with the casing sealed at the surface until refusal of sealing material.

- (3) After the seal has set, the top 9 feet of each well will be removed during soil excavation.

It is our opinion that the closure of the three wells in this manner will provide the required seal to protect groundwater quality. We are ready to proceed with these closures and are looking forward to receipt of permits. Please call me or Xinggang Tong, the WCC project manager, if you have any questions.

Sincerely,



Albert P. Ridley, CEG

Enclosures: Permit Application
Well Logs
Well Location Map
Laboratory Data
Groundwater Measurements



ZONE 7 WATER AGENCY

5997 PARKSIDE DRIVE

PLEASANTON, CALIFORNIA 94588

VOICE (510) 484-2600

FAX (510) 462-3914

DRILLING PERMIT APPLICATION

FOR APPLICANT TO COMPLETE

FOR OFFICE USE

LOCATION OF PROJECT 4000 San Pablo Avenue
at 40th Street Right-of-Way Extension
Emeryville, California

PERMIT NUMBER _____
LOCATION NUMBER _____

CLIENT
Name City of Emeryville Redevelopment Agency
Address 2200 Powell St., 12th Floor Voice (510) 596-4356
Emeryville, CA Zip 94608-1806

PERMIT CONDITIONS

Circled Permit Requirements Apply

APPLICANT
Name Albert Ridley
Woodward-Clyde Consultants Fax (510) 874-3268
Address 500 12th St, Suite 100 Voice (510) 874-3125
City Oakland Zip 94607-4014

A. GENERAL

1. A permit application should be submitted so as to arrive at the Zone 7 office five days prior to proposed starting date.
2. Submit to Zone 7 within 60 days after completion of permitted work the original Department of Water Resources Water Well Drillers Report or equivalent for well Projects, or drilling logs and location sketch for geotechnical projects.
3. Permit is void if project not begun within 90 days of approval date.

TYPE OF PROJECT

| | |
|--|--|
| Well Construction | Geotechnical Investigation |
| <input type="checkbox"/> Cathodic Protection | <input type="checkbox"/> General |
| <input type="checkbox"/> Water Supply | <input type="checkbox"/> Contamination |
| <input type="checkbox"/> Monitoring | <input checked="" type="checkbox"/> Well Destruction |

B. WATER WELLS, INCLUDING PIEZOMETERS

1. Minimum surface seal thickness is two inches of cement grout placed by tremie.
2. Minimum seal depth is 50 feet for municipal and industrial wells or 20 feet for domestic and irrigation wells unless a lesser depth is specially approved. Minimum seal depth for monitoring wells is the maximum depth practicable or 20 feet.

PROPOSED WATER SUPPLY WELL USE

| | | |
|------------------------------------|-------------------------------------|--------------------------------|
| Domestic <input type="checkbox"/> | Industrial <input type="checkbox"/> | Other <input type="checkbox"/> |
| Municipal <input type="checkbox"/> | Irrigation <input type="checkbox"/> | |

C. GEOTECHNICAL. Backfill bore hole with compacted cuttings or heavy bentonite and upper two feet with compacted material. In areas of known or suspected contamination, tremied cement grout shall be used in place of compacted cuttings.

DRILLING METHOD:

Mud Rotary Air Rotary Auger
 Cable Other pressure grout with casing in place

D. CATHODIC. Fill hole above anode zone with concrete placed by tremie.

DRILLER'S LICENSE NO. C57-177681

E. WELL DESTRUCTION. See attached.

WELL PROJECTS

| | | | |
|---------------------|--------------|---------|---------------|
| Drill Hole Diameter | <u>6</u> in. | Maximum | |
| Casing Diameter | <u>2</u> in. | Depth | <u>20</u> ft. |
| Surface Seal Depth | <u>3</u> ft. | Number | <u>3</u> |

GEOTECHNICAL PROJECTS

| | | | |
|-------------------|-----------|---------|-----------|
| Number of Borings | | Maximum | |
| Hole Diameter | _____ in. | Depth | _____ ft. |

ESTIMATED STARTING DATE June 28, 94
ESTIMATED COMPLETION DATE June 29, 94

Approved _____ Date _____

I hereby agree to comply with all requirements of this permit and Alameda County Ordinance No. 73-68.

APPLICANT'S SIGNATURE For Woodward-Clyde
[Signature] CEG Date 6-21-94

TABLE 3
WELL CONSTRUCTION AND GROUND-WATER ELEVATION DATA
40TH STREET RIGHT-OF-WAY, EMERYVILLE, CALIFORNIA

| Well Number | Well Elevation (feet msl) | Well Depth (feet) | Screened Interval | Date - Measured | Depth to Product | Depth to Water | Ground-Water Elevation (feet msl) | Product Thickness (feet) |
|-------------|---------------------------|-------------------|-------------------|-----------------|------------------|----------------|-----------------------------------|--------------------------|
| LF-1 | 38.95 | 20 | 5-20 | 08-Aug-93 | NA | 9.40 | 29.55 | NA |
| | | | | 20-Aug-93 | 9.48 | 10.00 | 29.36* | 0.52 |
| LF-2 | 40.25 | 20 | 5-20 | 08-Aug-93 | NA | 7.97 | 32.28 | NA |
| | | | | 20-Aug-93 | NA | 8.29 | 31.96 | NA |
| LF-3 | 39.35 | 20 | 5-20 | 08-Aug-93 | NA | 8.90 | 30.45 | NA |
| | | | | 20-Aug-93 | NA | 9.18 | 30.17 | NA |

msl = mean sea level

* The ground-water elevation for well LF-1 was corrected for the presence of free-phase fuel product using the following equation:

$$G = W + [(PT-D) - DW]$$

where

- G = the ground-water elevation
- W = the well elevation
- PT = the product thickness
- D = product density (mg/l)
- DW = the depth to water

A density of 0.796 mg/l was assumed.

TABLE 2
ANALYTICAL RESULTS FOR GROUNDWATER SAMPLES
40th Street Right-of-Way, Emeryville, California
(concentrations in milligrams per liter [mg/l])

| Sample Name | Sample Date | TPHg | TPHd | TPHmo | Benzene | Toluene | Ethyl-benzene | Total Xylenes | TRPH |
|-------------|-------------|-------|-------|-------|---------|---------|---------------|---------------|------|
| LF-1AG | 7-Aug-93 | 100 | 41 | <2.5 | 13 | 9.4 | 3.1 | 14 | 11 |
| LF-2AG | 7-Aug-93 | 13 | 0.095 | <0.50 | 2.4 | 2.9 | 0.5 | 2 | <5 |
| LF-3AG | 7-Aug-93 | 11 | 0.78 | <0.25 | 1.5 | 0.17 | 2.9 | 5.1 | <5 |
| GWEB1 | 28-Jan-94 | <0.05 | 0.081 | <0.05 | <0.0005 | 0.00057 | <0.0005 | 0.0026 | NA |
| LF-4 | 28-Jan-94 | 18 | 1.4 | 0.16 | 1 | 1.9 | 0.88 | 4.7 | NA |
| LF-4dup | 28-Jan-94 | 21 | 2.2 | 0.21 | 1.1 | 2 | 0.80 | 4.2 | NA |

Data extracted from Levine-Fricke's Reports of September 1993 and March 1994 (References 3 and 5).

NA = not available; ND = not detected.

TPHg = total petroleum hydrocarbons as gasoline.

TPHd = total petroleum hydrocarbons as diesel.

TPHmo = total petroleum hydrocarbons as motor oil.

TRPH = total recoverable petroleum hydrocarbons

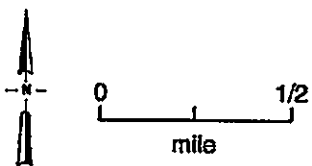

| | | | |
|-----------------------------------|-----------------|---|-------------|
| Project No. 941114NA | 40th Street UST | SITE LOCATION MAP CELI'S ALLIANCE GAS STATION SITE | Figure 1 |
| Woodward-Clyde Consultants | | | |

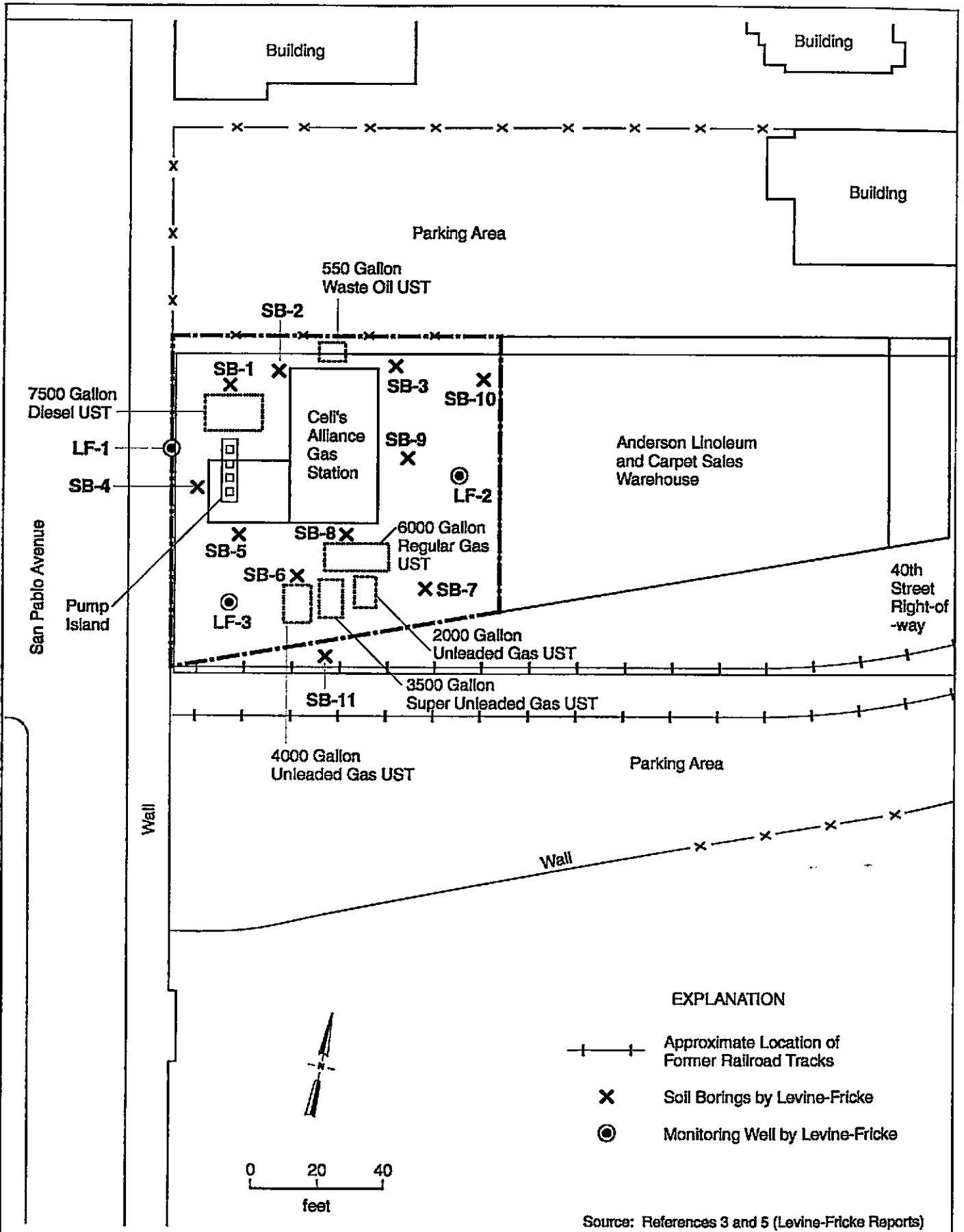

| | | | |
|-----------------------------------|-----------------|--|---------------------|
| Project No. 941114NA | 40th Street UST | SOIL BORING AND MONITORING WELL LOCATIONS 40TH STREET RIGHT-OF-WAY EMERYVILLE, CALIFORNIA | Figure 2 |
| Woodward-Clyde Consultants | | | |

WELL CONSTRUCTION

LITHOLOGY

SAMPLING DATA

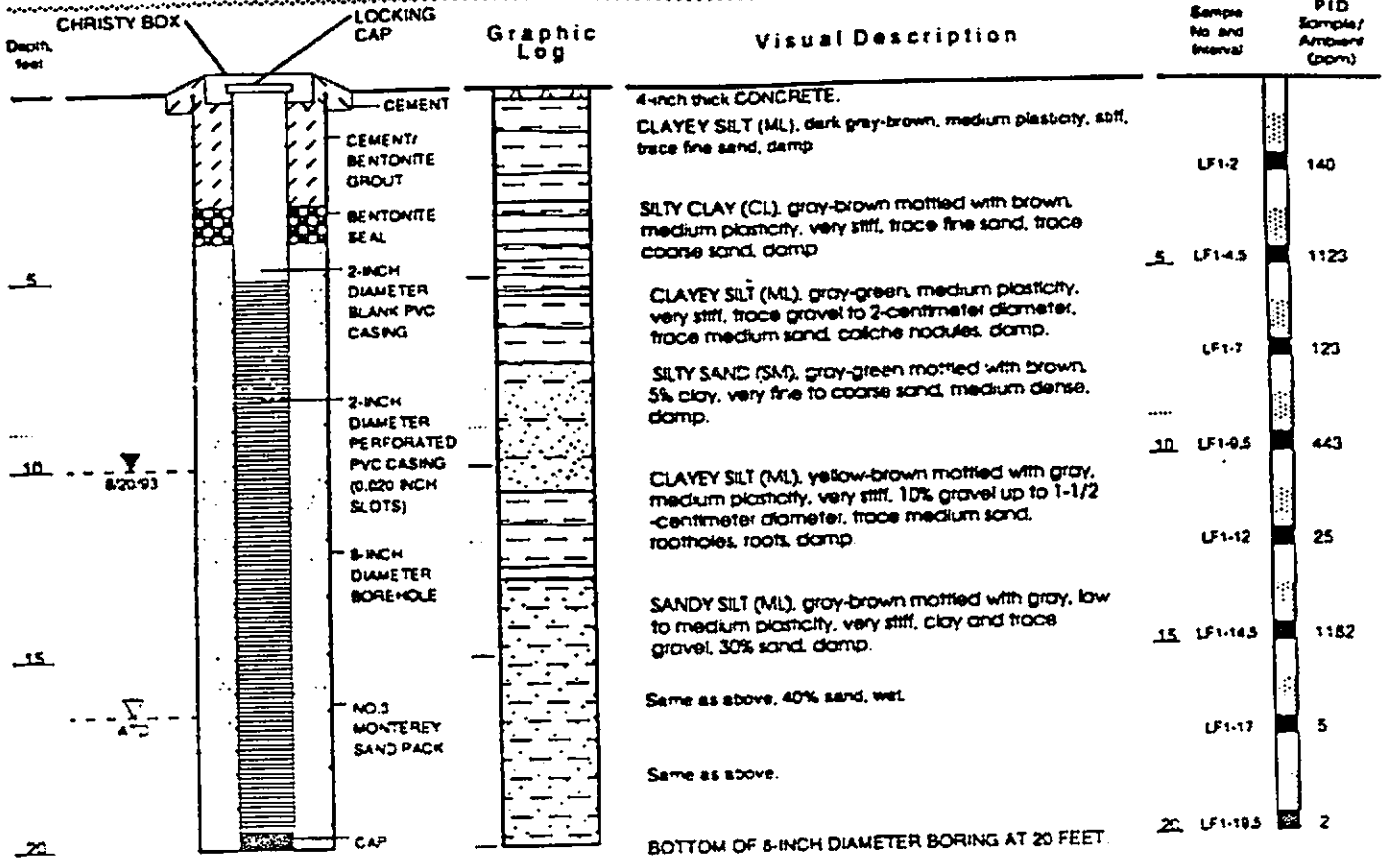

Date well drilled 08/07/93 -

Well casing elevation 38.95

L-F Geologist/Engineer, Robin Barber

Approved by *Kathleen Brown* RG # 5106

EXPLANATION

- Clay
- Silt
- Sand
- Gravel
- Interval Sampled
- Sample Retained
- Water level at time of drilling
- Static water level

WELL CONSTRUCTION AND LITHOLOGY FOR WELL LF-1

Project No. 1649.15
San Francisco Yerba Buena Phase I - 40th Street

LEVINE • FRICKE
ENGINEERS, HYDROGEOLOGISTS & APPLIED SCIENTISTS

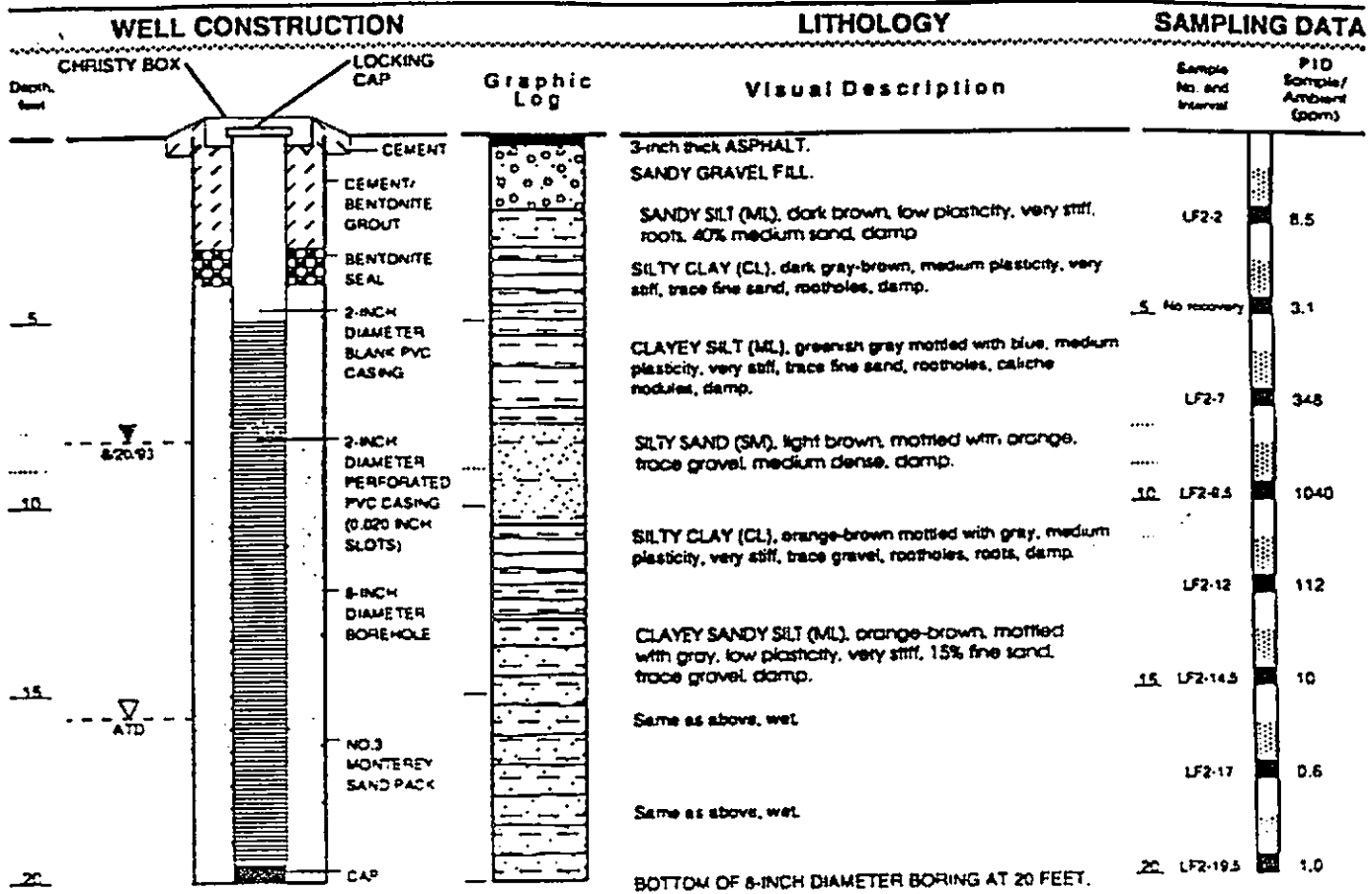

Date well drilled 08/07/93 -
 Well casing elevation 40.25
 L-F Geologist/Engineer Robin Barber
 Approved by *Kathleen Brown* RG # 5106

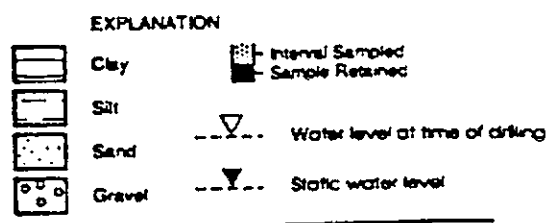

WELL CONSTRUCTION AND LITHOLOGY FOR WELL LF-2

WELL CONSTRUCTION

LITHOLOGY

SAMPLING DATA

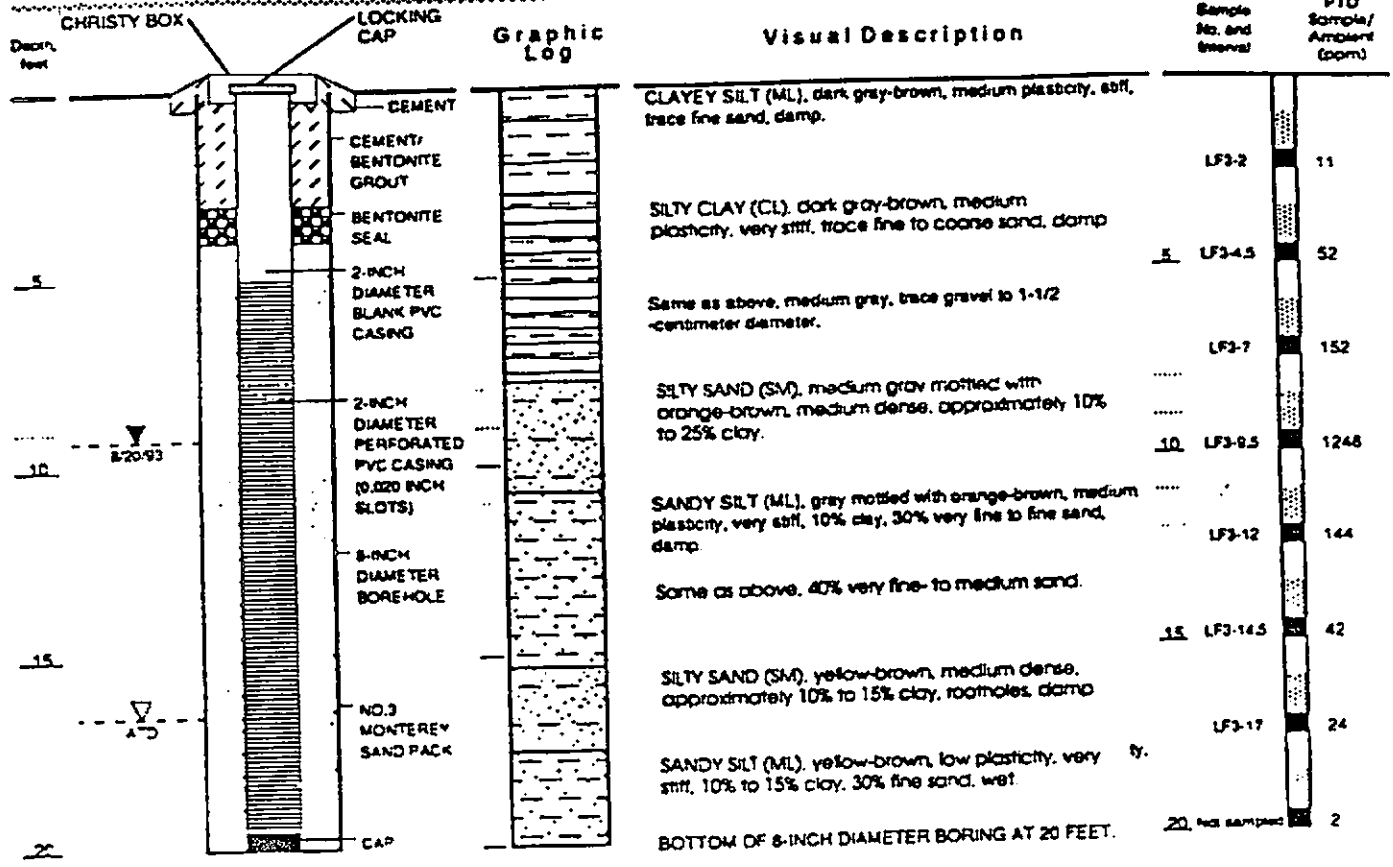

Date well drilled 08/07/93
Well casing elevation 39.35

L-F Geologist/Engineer Robin Barber

Approved by *Kate Danner* RG # 5106

EXPLANATION

- Clay
- Silt
- Sand
- Gravel
- Interval Sampled Sample Retained
- Water level at time of drilling
- Static water level

WELL CONSTRUCTION AND LITHOLOGY FOR WELL LF-3

Project No. 1649.15
San Francisco Yerba Buena Phase I - 40th Street

LEVINE • FRICKE
ENGINEERS, HYDROGEOLOGISTS & APPLIED SCIENTISTS

APPENDIX A.2
WELL DESTRUCTION PERMIT

| | | | | | |
|-------------------|----------------|---------|---------------|------------|---|
| Post-It™ Fax Note | 7671 | Date | 29 JUN 94 | # of pages | 1 |
| To | AL RIDLEY | From | W. HONG | | |
| Co./Dept | WOODWARD-CLYDE | Co. | ZONE 7 | | |
| Phone # | | Phone # | 484-2600 X235 | | |
| Fax # | 874-3268 | Fax # | | | |

27 June 1994

ZONE 7
WATER RESOURCES ENGINEERING
DRILLING ORDINANCE

CITY OF EMERYVILLE
4000 SAN PABLO AVENUE
EMERYVILLE
WELLS 1S/4W 23E80 TO 23E82
PERMIT 94368

Destruction Requirements:

1. Clean out all bridged or poorly compacted materials to the bottom of the well.
2. Pressure grout the casing to 2 feet below finished grade or original ground, whichever is the lower elevation.
3. After the seal has set, remove the top 9 feet of well casing by excavation.

These destruction requirements as proposed by Albert Ridley of Woodward-Clyde meet or exceed Zone 7 minimum requirements.

APPENDIX A.3
WELL DESTRUCTION REPORT

August 26, 1994
941114NA

Mr. Wyman Hong
Alameda County Flood Control and
Water Conservation District
Zone 7
5997 Parkside Drive
Pleasanton, CA 94588

Subject: Well Destruction Report,
Three Monitoring Wells (No. 1S/4W 23E80 to 23E82) at
4000 San Pablo Avenue, Emeryville, California

Reference: Zone 7 Permit No. 94368

Dear Mr. Hong:

On June 29, 1994, Woodward-Clyde Consultants (WCC) closed three groundwater monitoring wells located at 4000 San Pablo Avenue (formally Celis Alliance Fuel Station) in Emeryville, California. Well locations are shown on the attached Figure. The three wells are designated 1S/4W 23 E80, 23E81, and 23E82, respectively.

These wells were closed using the procedures outlined in your destruction permit No. 94368, dated June 27, 1994. Each well was first cleaned out all bridged materials to the bottom of the well and was then grouted with a cement/bentonite grout mixture using tremie method to fill the well casing from the bottom to the top. Following the removal of the tremie pipe, the casing was sealed at the top and 10 psig pressure was maintained for at least 15 minutes. Additional grout was added to the casing to bring the finished, and set, grout to within 2 feet of the ground surface.

The top 9 feet of each closed well was removed during site excavation in late July to early August 1994. Excavated materials were characterized and disposed of at appropriate landfills under manifesting.

Please call me at (510) 874-3125 if you have any questions.

Sincerely,



Albert P. Ridley, CEG



0 1/2
mile

| | | | |
|-----------------------------------|-----------------|---|-------------|
| Project No. 941114NA | 40th Street UST | SITE LOCATION MAP CELI'S ALLIANCE GAS STATION SITE | Figure 1 |
| Woodward-Clyde Consultants | | | |

APPENDIX B
PERMITS

APPENDIX B.1
BAAQMD NOTIFICATION RECORD



BAY AREA AIR QUALITY MANAGEMENT DISTRICT

939 ELLIS STREET
SAN FRANCISCO, CALIFORNIA 94109
(415) 771-6000

REGULATION 8, RULE 40 Aeration of Contaminated Soil and Removal of Underground Storage Tanks

NOTIFICATION FORM

Removal or Replacement of Tanks
 Excavation of Contaminated Soil

SITE INFORMATION

| | |
|--|---|
| SITE ADDRESS <u>4000 San Pablo Avenue</u> | |
| CITY, STATE <u>Emeryville, California</u> | ZIP <u>94608</u> |
| OWNER NAME <u>Constantino and Remedios Celis, C/o City of Emeryville</u> | |
| SPECIFIC LOCATION OF PROJECT <u>Entire site, approximately 100ft by 100ft.</u> | |
| TANK REMOVAL | CONTAMINATED SOIL EXCAVATION |
| SCHEDULED STARTUP DATE _____ | SCHEDULED STARTUP DATE <u>July 19, 1994</u> |
| VAPORS REMOVED BY: | STOCKPILES WILL BE COVERED? YES <input checked="" type="checkbox"/> NO <input type="checkbox"/> |
| <input type="checkbox"/> WATER WASH | ALTERNATIVE METHOD OF AERATION (DESCRIBE BELOW): |
| <input type="checkbox"/> VAPOR FREEING (CO ²) | _____ |
| <input type="checkbox"/> VENTILATION | (MAY REQUIRE PERMIT) |
| <u>Excavated soil will be haul to landfill for disposal</u> | |

CONTRACTOR INFORMATION

| | |
|---|-----------------------------|
| NAME <u>Remedial Solutions Inc</u> | CONTACT <u>Jay Alman</u> |
| ADDRESS <u>43353 Osgood Rd, Suite B</u> | PHONE (510) <u>651-7725</u> |
| CITY, STATE, ZIP <u>Fremont, CA 94539</u> | |

CONSULTANT INFORMATION (IF APPLICABLE)

| | |
|---|------------------------------|
| NAME <u>Woodward-Clyde Consultants</u> | CONTACT <u>Xinggong Tong</u> |
| ADDRESS <u>500 12th st., Suite 100</u> | PHONE (510) <u>874-3060</u> |
| CITY, STATE, ZIP <u>Oakland, CA 94607</u> | |

FOR OFFICE USE ONLY

| | | |
|----------------------------|------------------|----------|
| DATE RECEIVED FAX _____ | BY _____ | (init.) |
| DATE POSTMARKED _____ | BY _____ | (init.) |
| CC: INSPECTOR NO. _____ | DATE _____ | BY _____ |
| UPDATE: CONTACT NAME _____ | DATE _____ | BY _____ |
| BAAQMD N # _____ | DATA ENTRY _____ | (init.) |

INSTRUCTIONS

Specific Location of Project: Indicate where the tank removal or soil excavation is taking place.

Examples: -Northwest corner of Gas Station lot
 -Pit D of South Excavation area
 -Fuel storage area north of Auxiliary Road

Scheduled Startup Date: Indicate a correct and accurate startup date. If this date is delayed (by no more than five working days) telephone the District at (415) 771-6000, extension 128, to report the new startup date. If the project is delayed for more than five days, submit a new form and indicate the status of your previous notification.

Tank Removal: Indicate what type method will be used to remove vapors after tank is emptied of product. (Tanks must have all liquids and sludges removed to the extent possible before decommissioning.)

Soil Excavation: Indicate whether contaminated soil stockpile will be covered. If an alternative method of aeration will be used (e.g., forced air), briefly describe.

Contractor Information: Indicate the name, address, appropriate contact person and phone number of the contractor performing and responsible for the tank removal and/or soil excavation.

Consultant Information: If applicable, indicate the name, address, appropriate contact person and phone number of any environmental consultant used.

NOTE

- Notification must be postmarked at least five days prior to startup of tank removal and/or soil excavation.
- *Aeration* of contaminated soil shall be reported to the District by telephone no less than 24 hours prior to the spreading or heating of any contaminated soil. 415/749-4979
- Return this form by FAX (415) 928-0338 or mail to:

Bay Area Air Quality Management District
 939 Ellis Street
 San Francisco, CA 94109
 Attn: Enforcement Division

- Soil aeration operations do not require a BAAQMD permit unless:
 1. The project exceeds three months time or,
 2. An alternative method other than spreading the soil for evaporation will be used, or
 3. Tanks are being replaced (new installation).
- Use this form to meet the reporting requirements of Regulation 8, Rule 40, Section 400.

R8R40FRM - 1/91 APPROVED BY: Director of Enforcement 

APPENDIX B.2
STATE EXCAVATION NOTIFICATION RECORD

ACTIVITY NOTIFICATION FORM FOR HOLDERS OF ANNUAL PERMITS

Scaffolding Falsework Trenches/Excavations

Faxed 7/13/94
@ 8:20 AM

8 CCR 341.1(f) REQUIRES HOLDERS OF ANNUAL PERMITS TO PROVIDE NOTIFICATION TO THE DOSH OFFICE NEAREST THE PROJECT PRIOR TO COMMENCEMENT OF ANY WORK. THIS FORM IS PROVIDED FOR YOUR CONVENIENCE TO USE FOR SUCH NOTIFICATION.

THIS FORM MAY BE FAXED TO THE NEAREST DOSH OFFICE TO COMPLY WITH THE ABOVE. PLEASE DO NOT MAIL DUPLICATE NOTIFICATION TO FOLLOW-UP FAX NOTIFICATION.

FAX DATA: FAXED TO OAKLAND OFFICE DOSH DISTRICT OFFICE ON 7/13/94

DOSH FAX NO. 1510 1568-7092 BY MATT DWYER of REMEDIAL SOLUTIONS

Company Name: REMEDIAL SOLUTIONS, INC. Field Phone: _____

Annual Permit Number: 556714 Office Phone: (510) 651-7725

Issuing Region: SAN FRANCISCO Issuing District: SAN JOSE

Specific Activity Location: 4000 SAN PABLO AVE. Number of Employees: 2

Nearest Major Cross Street: 41ST STREET Starting Date: 7/15/94

City: EMERYVILLE Anticipated Completion Date: 8/15/94

County: ALAMEDA High Voltage Lines in Proximity? No Yes _____

INSTRUCTIONS: The appropriate item(s) must be completed and signed by a person knowledgeable about the project for each activity covered by a permit. Please fill in or check off the blanks where appropriate.

Scaffolding: Height _____ Metal _____ Wood _____ Wood over 60 Feet _____ Metal over 125 Feet _____
N/A

Metal > 125 Feet or Wood > 60 Feet requires design by California Registered Civil Engineer & Plans at Site. (See 8 CCR 1644(c)(7))

Description: _____

Falsework/Vertical Shoring: Maximum Height _____ Maximum Span _____ Material _____
N/A

Description: _____

(See 8 CCR 1717)

Trenches/Excavations: Depth Range (Min/Max) 10 FEET Width Range (Min/Max) 100 FEET Total Length 100 FEET

Ground Protection Method: Shoring Sloping Trench Shield _____ Professional Engineer _____

Underground Services Alert (USA) Number 221443 (NORTH 1-800-642-2444/SOUTH 1-800-422-4133)

Soil Analysis to be done? Yes _____ No If No, You Must Slope 1.5 to 1.

Competent Person: The holder of an Annual Permit who is notifying the District of the commencement of a Trench and/or Excavation project shall designate a competent person in accordance with the requirements of 8 CCR Section 1504, 1541, and 1541.1.

Description: EXCAVATION OF CONTAMINATED SOIL FROM A FORMER GASOLINE SERVICE STATION.

SIDEWALL ALONG SAN PABLO WILL BE SHORED USING SHEET PILES. ALL OTHERS TO BE

Ground protection methods for excavations deeper than 20 feet must be designed by a Registered Professional Engineer. SCUPED.

I hereby certify that to the best of my knowledge the above information and assertions are true and correct and that I/the applicant have knowledge of and will comply with the foregoing.

Signature: Matt Dwyer

Title: VICE PRESIDENT OF OPERATIONS

Date: 7/13/94

**APPENDIX B.3
GRADING PERMIT**

CITY OF EMERYVILLE
INSPECTION SERVICES DEPT.
2200 POWELL STREET, 12TH FLOOR
EMERYVILLE, CA 94608
(415) 596-4310



VALIDATE HERE

6-2098-794

Permit Number

APPLICATION AND PERMIT

THIS APPLICATION IS YOUR PERMIT WHEN PROPERLY FILLED OUT, SIGNED, VALIDATED & FEES PAID.

DO NOT WRITE IN THIS SPACE

BUILDING ADDRESS: 4000 San Pablo Avenue
TRACT: _____ LOT: _____ AREA: 019-1025-021-01

NAME: City of Emeryville Redevelopment Agency
ADDRESS: 2200 Powell St. 12th floor PHONE: (510) 596-4356

CITY: Emeryville STATE: CA ZIP: 94608
NAME: Woodward-Clyde LICENSE#: _____

ADDRESS: 500 12th St., Suite 100 PHONE: (510) 893-3600
CITY: Oakland STATE: CA ZIP: 94607

I hereby affirm that I am licensed under provisions of Chapter 9 (commencing with Section 7000) of Division 3 of the Business and Professions Code, and my license is in full force and effect.

CLASS: A634555 CITY BUSINESS TAX#: 13471

CONTRACTOR: Remedial Solutions Inc.
ADDRESS: 43353 Dwyer Road, Suite B

CITY: Emeryville STATE: CA ZIP: 94529 PHONE: (916) 251-7725
SIGNATURE: [Signature] DATE: _____

I hereby affirm that I am exempt from the Contractor's License Law for the following reason (Sec. 7031.5, Business and Professions Code): Any city or county which requires a permit to construct, alter, improve, demolish, or repair any structure, prior to its issuance, also requires the applicant for such permit to file a signed statement that he is licensed pursuant to the provisions of the Contractor's License Law Chapter 9 (commencing with Sec. 7000) of Division 3 of the Business and Professions Code, or that he is exempt therefrom and the basis for the alleged exemption. Any violation of Section 7031.5 by any applicant for a permit subjects the applicant to a civil penalty of not more than \$300:

- I am owner of the property, or my employees with wages as their sole compensation, will do the work, and the structure is not intended or offered for sale (Sec. 7044, Business and Professions Code). The Contractor's License Law does not apply to an owner of property who builds or improves thereon, and who does such work himself or through his own employees, provided that such improvements are not intended or offered for sale. If, however, the building or improvement is sold within one year of completion, the owner-builder will have the burden of proving that he did not build or improve for the purpose of sale.
- I am owner of the property, am exempt from the sale requirements of the above due to: (1) I am improving my principal place of residence or appurtenances thereon, (2) the work will be completed prior to sale, (3) I have resided in the residence for the 12 months prior to completion of the work, and (4) I have not claimed exemption in this subdivision on more than two structures from any one during any three-year period. (Sec. 7044, Business and Professions Code).
- I am owner of the property, am exclusively contracting with licensed contractors to construct or improve (Sec. 7044, Business and Professions Code). The Contractor's License Law does not apply to an owner of property who builds or improves thereon, and who contracts for such projects to be completed licensed pursuant to the Contractor's License Law.
- I am exempt under Sec. _____, B&P.C. for this reason: IGNACIO DAY IT DATE: 7/18/94

I hereby affirm that I have a certificate of consent to sell-lease, or a certificate of Workers' Compensation Insurance, as certified copy stated (Sec. 3800, Lab. C.)
Company Name: _____
 Certified copy is hereby furnished.
 Certified copy is filed with the city building inspection department. DATE: _____

(This section need not be completed if the permit is for one hundred dollars (\$100) or less)
I certify that in the performance of the work for which this permit is issued, I shall not employ any person in any manner so as to become subject to the Workers' Compensation Laws of California. DATE: _____

NOTICE TO APPLICANT: If, after making this Certificate of Exemption, you should become subject to the Workers' Compensation provisions of the Labor Code, you must forthwith comply with such provisions or this permit shall be deemed revoked.

I hereby affirm that there is a construction lending agency for the performance of the work for which this permit is issued (Sec. 3097, Civ. C.) (if no lender indicates "None")
Lender Name: _____
Address: _____

I CERTIFY THAT I HAVE READ THIS APPLICATION AND STATE THAT THE INFORMATION GIVEN IS TRUE AND CORRECT. I AGREE TO COMPLY WITH ALL LOCAL ORDINANCES AND STATE LAWS RELATING TO BUILDING CONSTRUCTION AND I MAKE THIS STATEMENT UNDER PENALTY OF LAW HEREBY AUTHORIZING REPRESENTATIVES OF THIS CITY TO ENTER UPON THE ABOVE MENTIONED PROPERTY FOR INSPECTION PURPOSES. NOTICE: THIS PERMIT IS ABANDONED FOR MORE THAN 180 DAYS DO NOT CONCEAL OR COVER ANY CONSTRUCTION UNTIL THE WORK IS INSPECTED AND THE INSPECTION IS RECORDED ON THE FIELD CARD ISSUED FOR THIS PERMIT. ALL INSPECTION REQUESTS ARE REQUIRED 24 HOURS IN ADVANCE OF THIS INSPECTION.

I hereby agree to save, indemnify and keep harmless the City of Emeryville, and its officers, employees and agents against all liabilities, judgments, costs and expenses which may accrue against the City in consequence of the granting of this permit or from the use or occupancy of any sidewalk, street or subsidewalk, or other place by virtue thereof, and will in all things strictly comply with the conditions under which this permit is granted.

Contractor
 Owner X _____ DATE: 7/18/94
Signature of Contractor Owner or Agent
 Agent for Contractor Owner
Address of Agent: _____

ADDRESS: _____ CITY: _____ STATE: _____ ZIP: _____ TELEPHONE: _____

Application Received
Date: 7-18-94 Signed: [Signature]

Permit Issued
Date: _____ Signed: _____

- Describe Briefly All Proposed Construction Work
- | | | |
|---|---------------------------------------|-------------------------------------|
| <input type="checkbox"/> Single Family | <input type="checkbox"/> New Addition | Grading: _____ |
| <input type="checkbox"/> Apartment | <input type="checkbox"/> Alteration | <input type="checkbox"/> Excavation |
| <input type="checkbox"/> Condominium | <input type="checkbox"/> Repair | <input type="checkbox"/> Fill |
| <input type="checkbox"/> Commercial | <input type="checkbox"/> Improve | <input type="checkbox"/> Drainage |
| <input type="checkbox"/> Industrial | <input type="checkbox"/> Other | <input type="checkbox"/> Other |
| <input type="checkbox"/> Public Building | | |
| <input type="checkbox"/> Accessory | | |
| <input checked="" type="checkbox"/> Other | | |

The site is located on the 40th St. Right-of-way extension. Contaminated soil will be excavated from an area of approx. 100' by 100' by 9' deep backfill with the city provided soil to 3' below ground surface.

New Building Floor Area (Sq. Ft.) NA

1st _____ 2nd _____ 3rd _____ Total _____
Garage _____ Carpet _____ # Bedrooms _____ # Bath _____

Building setbacks
Front _____ Rear _____ Left _____ Right _____

Occupancy Group and Division _____ Type _____
(Per USC Table 5A) (Per USC Table 17A)

Valuation of Proposed Work \$ 60,000.00
(Include all labor and materials, all lighting, heating, ventilation, water supply, plumbing, electrical, fire sprinklers, elevator equipment therein and thereon.)

- THIS PERMIT SHALL COVER:
- | | | |
|-----------------------------------|---|-------------------------------------|
| <input type="checkbox"/> Building | <input type="checkbox"/> Plan Check | <input type="checkbox"/> Electrical |
| <input type="checkbox"/> Plumbing | <input type="checkbox"/> Mechanical | <input type="checkbox"/> Insulation |
| <input type="checkbox"/> Solar | <input type="checkbox"/> Sign | <input type="checkbox"/> Pool/Spa |
| <input type="checkbox"/> S.M.I.P. | <input checked="" type="checkbox"/> Grading | <input type="checkbox"/> Other |

DO NOT WRITE BELOW THIS LINE

Planning Approval Date _____ File Dept. Approval Date _____
Health Dept. Approval Date _____ Final Approval Date _____

Special Conditions: _____
Valence Date _____ Use Permit Date _____

PERMIT FEES

| | |
|-----------------------|----------------|
| Building | _____ |
| Plan Check | _____ |
| Filing | _____ |
| Electrical | _____ |
| Plumbing | _____ |
| Mechanical | _____ |
| Insulation | _____ |
| Fire | _____ |
| Traffic | _____ |
| School | _____ |
| S.M.I.P.-SB1374 | _____ |
| Grading | <u>6000.00</u> |
| Annexation | _____ |
| Sewer Connection | _____ |
| Community Development | _____ |
| Growth Impact Fee | _____ |
| | _____ |
| | _____ |
| Total | <u>6000.00</u> |

DISTRIBUTION
1. ADDRESS FILE
2. APPLICANT
3. INSPECTOR
4. FINANCE
5. ASSESSOR

ADDRESS FILE

**BUILDING DEPARTMENT
CITY OF EMERYVILLE**

Date 7-18-94 Lot No. _____

BUILDING PERMIT NO. G-5098-794

Address 4000 San Pablo

Work Grading

Redevelopment Agency Owner

Remedial Solutions Builder or Contractor

By ASZ City Inspector

DO NOT CONCEAL ANY WORK UNTIL INSPECTED AND APPROVED BY THE BUILDING INSPECTOR.

| | DATE | INSP. |
|--------------------|---------------|------------|
| Piers & Setbacks | | |
| Forms | | |
| Foundation | | |
| Slab | | |
| Sub-Floor | | |
| Ground Plumbing | | |
| Ground Electrical | | |
| Sub-Fir Insulation | | |
| Shear Nailing | | |
| Sewer | | |
| Water | | |
| Roof Sheathing | | |
| Rough Electrical | | |
| Rough Plumbing | | |
| Rough Mechanical | | |
| Frame | | |
| Exterior Lath | | |
| Insulation | | |
| Drywall | | |
| Gas Test | | |
| Final Electrical | | |
| Final Plumbing | | |
| Final Mechanical | | |
| Final Building | | |
| Fire Sprinkler | | |
| Fire (Other) | | |
| <u>Grading</u> | <u>9.2.94</u> | <u>ASZ</u> |

**FOR INSPECTIONS CALL 596-4315
24 HRS. PRIOR TO INSPECTION**

APPENDIX B.4
ACHA'S WRITTEN APPROVAL OF WORKPLAN AND
WCC'S MEMORANDUM OF CLARIFICATIONS

ALAMEDA COUNTY
HEALTH CARE SERVICES
AGENCY

DAVID J. KEARS, Agency Director



RAFAT A. SHAHID, ASST. AGENCY DIRECTOR

August 24, 1994
STID# 567

DEPARTMENT OF ENVIRONMENTAL HEALTH
State Water Resources Control Board
Division of Clean Water Programs
UST Local Oversight Program
80 Swan Way, Rm 200
Oakland, CA 94621
(510) 271-4530

Mr. Ignacio Dayrit
City of Emeryville
Redevelopment Agency
2200 Powell Street, Suite 200
Emeryville, California 94608

**Subject: Former Celis Alliance Service Station /
40th Street Right of Way - 4000 San Pablo Avenue
Emeryville, California 94608**

Dear Mr. Dayrit:

This office has completed review of the "Report on Removal of Six Underground Fuel Storage Tanks and Associated Piping" (July 6, 1994) prepared by Levine Fricke and the "Workplan for Additional Site Investigation and Limited Soil Excavation" (June 17, 1994) prepared by Woodward-Clyde for the referenced site.

Soil samples collected following removal of the former tanks showed elevated concentration of petroleum hydrocarbon as high as 640 ppm TPH gasoline, 1300 ppm TPH diesel, 5.3 ppm benzene, 16 ppm toluene, 24 ppm ethyl benzene and 91 ppm xylene. Collection of groundwater from the excavation pit was waived due to the presence of three monitoring wells at the site. One of the wells (LF-1) detected 6 inches of free floating product.

Based on this review and telephone discussion with Xinggang Tong of Woodward-Clyde in July 15, 1994, the workplan was verbally approved for implementation with the following conditions:

- 1) Due to the proposed excavation of contaminated soil at the site, the three monitoring wells located on site will be properly closed. However, replacement wells must be installed to continue the investigation of the groundwater contamination beneath the site. Groundwater flow direction must be established at the site. One of the wells must be installed in the verified downgradient location of the referenced property.
- 2) During borehole advancement, soil samples should be collected at a minimum of every five feet in the unsaturated zone, significant changes in lithology, and where field screening identifies the presence of contaminants. The selection of samples chosen for laboratory analysis should be based primarily on field screening. At least one samples submitted for analysis from each boring must be from the saturated/unsaturated zone interface.

Mr. Ignacio Dayrit
RE: 4000 San Pablo Avenue, Emeryville, CA 94608
August 24, 1994
Page 2 of 3

- 3) Wells should be surveyed to an accuracy of 0.01 foot and referenced to mean sea level (MSL).
- 4) The vertical and lateral extent of soil and groundwater contamination must be delineated. The isoconcentration line of the contaminant plume must be determined.
- 5) Any waste (hazardous or non-hazardous) generated at the site must be characterized and disposed appropriately. Documents of all waste disposal must be provided to this office.
- 6) The summary of analyses for confirmation soil samples from the excavation pit is acceptable.

A report must be submitted within 30 days after completion of this investigation. Until cleanup is complete, you will need to submit reports to this office every three months or at a more frequent interval, if specified at any time. In addition, the following items must be incorporated in your future reports or workplans:

- a cover letter from the responsible party or tank owner stating the accuracy of the report and whether he/she concurs with the conclusions and recommendations in the report or workplan
- site map delineating contamination contours for soil and groundwater based on recent data should be included and the status of the investigation and cleanup must be identified
- proposed continuing or next phase of investigation / cleanup activities must be included to inform this department of the responsible party or tank owner's intention
- any changes in the groundwater flow direction and gradient based on the measured data since the last sampling event must be explained
- historical records of groundwater level in each well must be tabulated to indicate the fluctuation in water levels
- tabulate analytical results from all previous sampling events; provide laboratory reports (including quality control/quality assurance) and chain of custody documentation

Mr. Ignacio Dayrit
RE: 4000 San Pablo Avenue, Emeryville, CA 94608
August 24, 1994
Page 3 of 3

Please contact me at (510) 567-6780 if you have any questions concerning this letter.

Sincerely,

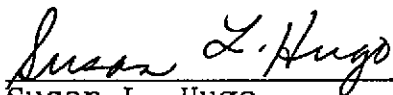

Susan L. Hugo
Senior Hazardous Materials Specialist

cc: Rafat A. Shahid, Asst. Agency Director, Environmental Health
Kevin Graves, San Francisco Bay RWQCB
Edgar B. Howell, Chief, Hazardous Materials Division - files
Xinggang Tong, Woodward Clyde- 500 12th Street, Suite 100
Oakland, CA 94607-4014
Constantino Celis, 2319 Monte Vista Drive, Pinole, CA 94564

MEMORANDUM

To: Ms. Susan Hugo, Senior Hazardous Materials Specialist,
Alameda County Health Agency;

Mr. Ignacio Dayrit, Projects Coordinator,
City of Emeryville Redevelopment Agency.

From: Xinggang Tong, Project Manager,
Woodward-Clyde Consultants - Oakland Office

Date: September 19, 1994

Subject: Clarifications to the monitoring and reporting requirements contained in the 8/24/94 letter from the Alameda County Health Agency for the site of the former Celis Alliance Service Station at 4000 San Pablo Avenue, Emeryville, California.

This memorandum is to confirm the content of discussions in a meeting among Ms. Susan Hugo, Mr. Ignacio Dayrit, and myself held at Susan's office in September 8, 1994, between 10.00 am and 11.30 am. The main purpose of the meeting was to clarify the monitoring and reporting requirements by the Alameda County Health Agency (ACHA) on the former Celis Alliance Service Station located at 4000 San Pablo Avenue, Emeryville, California. The ACHA's requirements were listed in a letter of 8/24/94 addressed to Mr. Ignacio Dayrit of the City of Emeryville Redevelopment Agency. The participants all agreed in the meeting the following clarifications to the ACHA's letter.

A) Clarification to Item 1 of the ACHA's Letter Regarding Replacement Wells

Groundwater monitoring wells LF-1 through LF-3 have been closed due to soil excavation at the site. They will be replaced with two new wells. One will be located in the area near the closed LF-1 well, another will be located immediately outside the eastern boundary of the site near the southeastern corner. A third well, which is included in the original workplan developed by Woodward-Clyde in June 1994 and labeled as WCC-1, will be located approximately 20 feet west of the soil boring EB-1. These three wells will be constructed after the completion of the 40th Street Right-of-Way extension through the site. Woodward-Clyde understands that the road extension will be constructed by the end of October 1994. We thus plan to install the three new wells in November 1994. All the three wells will be 2 inches in diameter and 20 feet in depth.

B) Clarification to Item 4 of the ACHA's Letter Regarding Vertical Distribution of Contaminants:

During well installation, soil samples will be collected and analyzed in accordance with the requirement specified in Item 2 of the ACHA's letter. No other efforts will be made to delineate VERTICAL distribution of soil and groundwater contamination. Lateral extent of groundwater contamination will be monitored through quarterly groundwater sampling and analysis from monitoring wells.

C) Quarterly Groundwater Monitoring:

Quarterly groundwater monitoring will start after the installation of the three new wells as discussed above. If the wells are installed in November 1994 as planned, the first quarterly groundwater monitoring will be the fourth quarter of 1994.

D) Reporting

A report will be submitted to the ACHA by October 21, 1994, documenting soil excavation, disposal and confirmation sampling activities at the site. A separate report will be submitted to the ACHA documenting the construction of the three monitoring wells within 30 days of completion of well construction.

Quarterly groundwater monitoring report will be submitted to the ACHA by the end of the month following each quarter. The following will be included in the report:

- A cover letter from the City of Emeryville Redevelopment Agency stating the accuracy of the report and concurrence with the conclusions and recommendations in the report;
- A site map delineating groundwater contamination contours based on the latest monitoring results;
- A discussion of groundwater flow directions and changes;
- Proposed next quarterly investigation and cleanup activities;
- Tabulated records of all quarterly groundwater level measurement data;
- Tabulated data of all quarterly groundwater chemical analysis results;
- Laboratory analytical reports and chain-of-custody forms for all the analyses performed in the quarter the report is prepared for.

APPENDIX C
WATER AND DRUM DISPOSAL CERTIFICATES

APPENDIX C.1
WATER DISPOSAL CERTIFICATE

Non-Hazardous Waste Data Form

TO BE COMPLETED BY THE GENERATOR

Name CONSTANTINO CELIS / C/O CITY OF EMERYVILLE EPA ID No. CAL000057729
 Mailing Address 2200 POWELL STREET, 12TH FLOOR, EMERYVILLE, CA. 94608 Phone (510) 596-4356
 Generating Site 4000 SAN PABLO AVENUE, EMERYVILLE, CA.
 Waste: Liquid Soil
 Estimated Volume 48 1,200 GALS. BBLS/GALS TONS/YDS
 Waste Description:
 Components of the Waste PPM % Components of the Waste PPM %

 Special Handling Instructions Gloves Goggles Other _____
 Generator certifies that the waste as described is 100% non-hazardous.
 Signature of Authorized Agent Don Smith on behalf of agent D.S. Date JULY 21, 1994

TRANSPORTER

Name H & H SHIP SERVICE COMPANY EPA ID No. CAD004771168
 Address 220 TERRY A. FRANCOIS Phone (415) 543-4835
SAN FRANCISCO, CA. 94017
 Truck Unit ID 428040
 Pick Up Date JULY 21, 1994
 Order No. _____
 Signature Janine Reen Date JULY 21, 1994

GIBSON FACILITY

Facility
 CAD980883177
 Gibson Environmental
 End of Commercial Dr.
 Bakersfield, CA 93308
 (805) 327-0413
 CAD981458466
 Gibson Environmental
 401 Canal Avenue
 Wilmington, CA 90748
 (310) 549-9117
 CADO43260702
 Gibson Environmental
 475 Seaport Blvd.
 Redwood City, CA 94063.
 (415) 368-5511
 Disposal Method: Recycle Release # 17607 Actual Tons/Gals 1400.6
 Signature Carol M...? COL # 5610 Date JULY 21, 1994

Gibson Environmental

475 SEAPORT BOULEVARD
 REDWOOD CITY, CA 94063
 (415) 368-5511

ORIGIN: *Constantino Cells
 City of Emeryville*

DESTINATION: GIBSON ENVIRONMENTAL
 475 SEAPORT BOULEVARD
 REDWOOD CITY, CA 94063

WEIGHT TAG NUMBER

DATE

July 21, 1994

MANIFEST#

1102

INVOICE TO:

PRICE: *20.00*

| CARRIER # | CARRIER | RELEASE# | COMMODITY | TDS | PH | GRAV. | NET GALLONS / BBLs |
|--------------------|------------------|--------------------|-----------|--------------------------------------|------------|------------|-----------------------|
| <i>T131</i> | <i>H's H Sup</i> | <i>17607</i> | <i>WW</i> | <i>200</i> | <i>7.5</i> | <i>10</i> | <i>14006 / 33.336</i> |
| ARRIVED TO UNLOAD | | START TO UNLOAD | | FINISH UNLOADING | | SOLIDS % | |
| <i>1100</i> | | <i>AM</i> | | <i>1150</i> | | <i>190</i> | |
| LOADED FROM | | UNLOADED TO | | WASHOUT GALLONS | | | |
| <i>Vac TRUCK</i> | | <i>30719</i> | | DEDUCT B S & W % | <i>99%</i> | | |
| LOADER'S SIGNATURE | | DRIVER'S SIGNATURE | | NET BARRELS | | | |
| <i>Janya Morje</i> | | <i>Jim Reen</i> | | RECEIPT TICKET | | | |
| REMARKS | | | | R <i>02407</i> <i>5610</i> | | | |

GIBSON LIQUID WASTE PROFILE SHEET

Effective January 1, 1994

Please fill-in completely all areas that apply to your material. This is an application, not an approval!

| | |
|--|--|
| GENERATOR <u>Constantino Celis, c/o City of Emeryville Redevelopment Agency</u> | |
| FACILITY ADDRESS <u>4000 San Pablo Ave., Emeryville, CA 94608</u> | |
| MAILING ADDRESS <u>2200 Powell St., 12th floor</u> | TELEPHONE <u>(510) 596-4356</u> |
| <u>Emeryville, CA 94608</u> | EPA ID# <u>CAL000057725</u> |
| TECHNICAL CONTACT <u>Xinyang Tong @ (510) 874-3060</u> | TITLE <u>Project Manager</u> |
| TRANSPORTER _____ | STATE # _____ |
| CONTACT _____ | TITLE _____ |
| TELEPHONE _____ | EPA I.D.# _____ |
| NAME OF WASTE <u>groundwater at Celis site</u> | |
| ACTIVITY PRODUCING WASTE <u>Well monitoring and construction dewatering</u> | |
| Does this waste contain Petroleum Hydrocarbons? <input checked="" type="checkbox"/> YES <input type="checkbox"/> NO | |
| Approximate Concentrations (Account for 100%) | |
| Petroleum Hydrocarbons <u>< 0.01</u> % Solids <u>< 1</u> % | pH <u>7</u> Flash <u>NA</u> |
| Water <u>> 99</u> % Other <u>0</u> % | Other <u>None</u> |
| Does this waste contain: | |
| Reactive Cyanides or Sulfides of 1ppm or more, <input type="checkbox"/> YES <input checked="" type="checkbox"/> NO | PCB's of 2ppm or more, <input type="checkbox"/> YES <input checked="" type="checkbox"/> NO |
| Total Organic Halogens of 1000 ppm or more? <input type="checkbox"/> YES <input checked="" type="checkbox"/> NO | Reportable Lead, Chromium or other "C.A.M. 17" metals? <input type="checkbox"/> YES <input checked="" type="checkbox"/> NO <u>Not analyzed</u> |
| If yes what substances and at what concentrations (mg/L or mg/kg)? _____ | |
| Is this waste a RCRA F-, K-, P-, or U-Listed Waste? <input type="checkbox"/> YES <input checked="" type="checkbox"/> NO | |
| Is this waste a RCRA TCLP? <input type="checkbox"/> YES <input checked="" type="checkbox"/> NO If this waste is RCRA TCLP Waste, then which D-codes will be used in the EPA box? _____ If so, you must use "R.Q." (reportable quantity) before the description and (DO _____) after description in Box 11a | |
| How will this waste be manifested? | |
| Non-Hazardous on a Bill of Lading or Data Form? <input checked="" type="checkbox"/> YES <input type="checkbox"/> NO | |
| On a Uniform Hazardous Waste Manifest in Box 11a as: | |
| <input type="checkbox"/> Non-RCRA Hazardous Waste, Liquid | State Waste Code _____ |
| <input type="checkbox"/> Waste Combustible Liquid, n.o.s. (oil), NA1993, III | _____ |
| <input type="checkbox"/> Waste Petroleum Oil, 9, UN1270, I or II or III | _____ |
| <input type="checkbox"/> Hazardous Waste, Liquid, n.o.s., 9, NA3082, III | _____ |
| <input type="checkbox"/> Waste Environmentally Hazardous Substances Liquid, n.o.s., 9, UN3082, III | _____ |
| To the best of my knowledge, I certify that the above is true and correct. | |
| Signature <u>Xinyang Tong</u> ^{for Ignacio} _{Bayrite} Title <u>Project Manager</u> Date <u>7/19/94</u> | |
| Facility Decision | |
| Accept _____ | Release# _____ |
| Manager _____ | Facility _____ |

♻️ Recycled Paper

APPENDIX C.2
EMPTY DRUM DISPOSAL CERTIFICATE

CHECK NO. -

*Alliance
metals*

WEIGHMASTER

~~ALLIED~~ METALS

26566

WEIGHED AT: 3426 PERALTA STREET
OAKLAND, CA 94608
RECYCLING # RC 1014
(415) 547-2408

DATE *Sept. 7* 19 *94*

I.D. #

NAME *City of Emeryville Redevelopment Agency*

ADDRESS *2200 Powell St., 12th floor, Emeryville, CA 94608*

TELEPHONE *(510) 893-3600 (Woodward-Clyde)*

| ARTICLE | LBS. GROSS | LBS. TARE | LBS. NET | PRICE | AMOUNT |
|------------------------|------------|-----------------|----------|----------------|----------|
| COPPER | | | | | |
| COPPER | | | | | |
| BRASS | | | | | |
| BRASS | | | | | |
| BRASS | | | | | |
| LEAD | | | | | |
| RADIATORS | | | | | |
| ALUMINUM | | | | | |
| DIE CAST | | | | | |
| ALUMINUM | | | | | |
| ALUMINUM | | | | | |
| ALUMINUM | | | | | |
| ALUMINUM | | | | | |
| STAINLESS STEEL | | | | | |
| MOTORS | | | | | |
| INSULATION | | | | | |
| <i>55 Gallon Drums</i> | | <i>Recycled</i> | | <i>16 each</i> | |
| DEPUTY SIGNATURE | | | | | |
| <i>[Signature]</i> | | | | TOTAL | <i>0</i> |

WEIGHMASTER CERTIFICATE:

THIS IS TO CERTIFY that the following described commodity was weighed, measured, or counted by a weighmaster, whose signature is on this certificate, who is a recognized authority of accuracy, as prescribed by Chapter 7 (commencing with Section 12700) of Division 5 of the California Business and Professions Code, administered by the Division of Measurement Standards of the California Department of Food and Agriculture.

SIGNATURE _____

APPENDIX D
SOIL DISPOSAL RECORDS

**APPENDIX D.1
DISPOSAL RECORD FOR SOIL EXCAVATED
FROM 0 TO 5 FT BELOW GRADE**

July 28, 1994

Tom Fantini
Alta Environmental Services, Inc.
831 Davis Street
Vacaville, California 95687

Subject: Soil Excavation, Stockpiling, Sampling, and Analysis
Celis Fuel Station at 4000 San Pablo Avenue
Emeryville, California

Dear Mr. Fantini:

Per the request by Ms. Amy Dietz of Norcal Waste Systems, Inc. in a memorandum of July 12, 1994 addressed to you, the soil from 0 to 5 feet below surface at the above referenced site was excavated and stockpiled on site by Remedial Solutions Inc. (RSI) in July 20 through 22, 1994. In addition, the hot spots designated by Ms. Dietz were also excavated and stockpiled individually on site at the same time (see attached figure). The height of soil piles varied from approximately 4 to 6 feet.

Each soil pile was staked prior to sample collection. The stake and soil sample designation is as follows:

S-O&G-: Soil samples from the designated hot spot of waste oil tank area;
S-G-: Soil samples from the designated gas hot spots of SB-8, SB-9 and SB-10 areas;
S-D-: Soil samples from the designated diesel hot spot of D1-9 area;
S-0-5ft-: Soil samples from the stockpile excavated from 0 to 5 feet below surface.

Woodward-Clyde Consultants (WCC) collected soil samples in July 22, 1994. Sampling procedures are described below:

- 1) The plastic cover was first removed from each sample location;
- 2) At each designated sampling location (see attached figure), an approximately 8-inch diameter, 24-inch deep hole was dug;
- 3) Soil sample was then quickly collected from the bottom of the hole by using a stainless steel scoop and directly transferred into a 4-oz clear glass jar supplied by Chromolab. Soil was pressed hard into the glass jar to the maximum volume in order to minimize air space in the jar. The jar was then capped tightly with a teflon-sheet lined cap, labeled, and placed in an ice-cooled cooler;
- 4) The hole was backfilled and the area was covered with plastic sheet again;
- 5) Soil samples were picked up on site under chain-of-custody by Coast-to-Coast Analytical Laboratory of San Jose and analyzed there.

Please call me at (510) 874-3060 if you have any questions.

Sincerely,

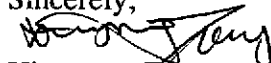

Xinggang Tong, Project Manager

San Pablo Ave.

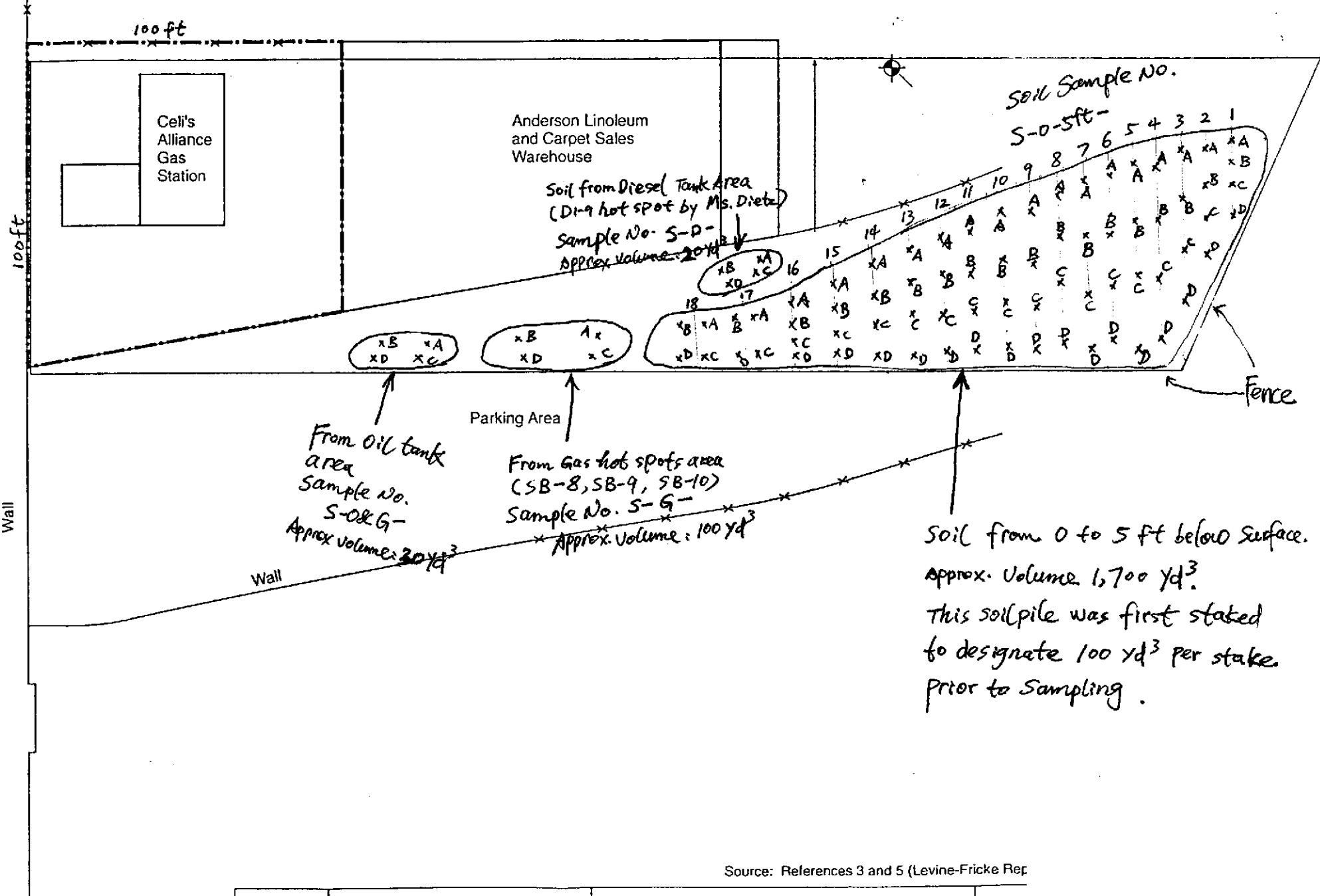

Source: References 3 and 5 (Levine-Fricke Rep)

| | | | |
|----------------------------|-----------------|---|----------|
| Project No. 941114NA | 40th Street UST | SITE PLAN 40TH STREET RIGHT-OF-WAY EMERYVILLE, CALIFORNIA | Fig 2 |
| Woodward-Clyde Consultants | | | |

FIELD SAMPLING NOTES

Woodward-Clyde

| | |
|--|-------------------|
| Project Location: 4000 San Pablo Ave. @ 40th St., Emeryville | Page 1 of 5 |
| Project Number: 94-1114-NA | Date: 7/22/94 |
| Task Number: 4000 | Weather: Cloudy |
| Sampled by: Steve Penman & Ninggang Tong | Temperature: 70°F |
| Summary of Main Activities: Sampling excavated, stockpiled soil for disposal to B&J landfill | Wind: ~0-10 MPH |

| Sample No. | Type | Date | Time | Field PID screening | Analyses requested | Notes |
|-------------|------|---------|---------|---------------------|--------------------|--|
| S-0-5ft-1-A | soil | 7/22/94 | 9:50Am | 10 ppm | TPHg BTX | Soil samples were collected from 18" to 24" below surface of the stockpiled soil. The sampling holes were also monitored by a hand model PI 101. |
| S-0-5ft-1-B | " | " | 9:55Am | 40 ppm | | |
| S-0-5ft-1-C | " | " | 10:00Am | 45 ppm | | |
| S-0-5ft-1-D | " | " | 10:05Am | 10 ppm | | |
| S-0-5ft-2-A | " | " | 10:25Am | 10 ppm | TPHg BTX | Sampling locations were staked out prior to sample collection. See attached map for sampling locations. |
| S-0-5ft-2-B | " | " | 10:30Am | 60 ppm | | |
| S-0-5ft-2-C | " | " | 10:35Am | 30 ppm | | |
| S-0-5ft-2-D | " | " | 10:40Am | 15 ppm | | |
| S-0-5ft-3-A | " | " | 11:00Am | 10 ppm | TPHg BTX | |
| S-0-5ft-3-B | " | " | 10:55Am | 5 ppm | | |
| S-0-5ft-3-C | " | " | 10:50Am | 25 ppm | | |
| S-0-5ft-3-D | " | " | 10:45Am | 20 ppm | | |
| S-0-5ft-4-A | " | " | 11:05Am | 5 ppm | TPHg BTX | |
| S-0-5ft-4-B | " | " | 11:10Am | 7 ppm | | |
| S-0-5ft-4-C | " | " | 11:15Am | 20 ppm | | |
| S-0-5ft-4-D | " | " | 11:20Am | 120 ppm | | |

FIELD SAMPLING NOTES

Woodward-Clyde

| | |
|--|-------------------|
| Project Location: 4000 San Pablo Ave. @ 40th St., Emeryville, CA | Page 2 of 5 |
| Project Number: 941114NA | Date: 7/22/94 |
| Task Number: 4000 | Weather: Cloudy |
| Sampled by: Steve Penman & Xinyang Tong | Temperature: 70°F |
| Summary of Main Activities: Sampling excavated, stockpiled soil for disposal to B&J landfill | Wind: 0-10 MPH |

| Sample No. | Type | Date | Time | Field PID screening | Analyses requested | Notes |
|-------------|------|---------|---------|---------------------|--------------------|------------|
| S-0-5ft-5-A | Soil | 7/22/94 | 11:40am | 3 ppm | } TPHg BTX | See page 1 |
| S-0-5ft-5-B | " | " | 11:35am | 5 ppm | | |
| S-0-5ft-5-C | " | " | 11:30am | 15 ppm | | |
| S-0-5ft-5-D | " | " | 11:25am | 25 ppm | | |
| S-0-5ft-6-A | " | " | 11:45am | 3 ppm | } TPHg BTX | |
| S-0-5ft-6-B | " | " | 11:50am | 10 ppm | | |
| S-0-5ft-6-C | " | " | 11:55am | 20 ppm | | |
| S-0-5ft-6-D | " | " | 12:00pm | 5 ppm | | |
| S-0-5ft-7-A | " | " | 12:15pm | 6 ppm | } TPHg BTX | |
| S-0-5ft-7-B | " | " | 12:20pm | 8 ppm | | |
| S-0-5ft-7-C | " | " | 12:25pm | 10 ppm | | |
| S-0-5ft-7-D | " | " | 12:30pm | 35 ppm | | |
| S-0-5ft-8-A | " | " | 12:50pm | 3 ppm | } TPHg BTX | |
| S-0-5ft-8-B | " | " | 12:45pm | 2 ppm | | |
| S-0-5ft-8-C | " | " | 12:40pm | 35 ppm | | |
| S-0-5ft-8-D | " | " | 12:35pm | 20 ppm | | |

FIELD SAMPLING NOTES

Woodward-Clyde

| | |
|--|-------------------|
| Project Location: 4000 San Pablo Ave. @ 40th St., Emeryville, CA | Page 3 of 5 |
| Project Number: 941114NA | Date: 7/22/94 |
| Task Number: 4000 | Weather: Cloudy |
| Sampled by: Steve Penman & Dingyong Song | Temperature: 70°F |
| Summary of Main Activities: Sampling excavated, stockpiled soil for disposal to B&J landfill | Wind: 0-10 mph |

| Sample No. | Type | Date | Time | Field PID screening | Analyses requested | Notes |
|--------------|------|---------|----------|---------------------|--------------------|------------|
| S-0-5ft-9-A | Soil | 7/22/94 | 12:55 PM | 35 ppm | TPHg BTX | See page 1 |
| S-0-5ft-9-B | " | " | 1:00 PM | 10 ppm | | |
| S-0-5ft-9-C | " | " | 1:05 PM | 5 ppm | | |
| S-0-5ft-9-D | " | " | 1:10 PM | 3 ppm | | |
| S-0-5ft-10-A | " | " | 1:30 PM | 10 ppm | TPHg BTX | |
| S-0-5ft-10-B | " | " | 1:25 PM | 25 ppm | | |
| S-0-5ft-10-C | " | " | 1:20 PM | 2 ppm | | |
| S-0-5ft-10-D | " | " | 1:15 PM | 2 ppm | | |
| S-0-5ft-11-A | " | " | 1:35 PM | 5 ppm | TPHg BTX | |
| S-0-5ft-11-B | " | " | 1:40 PM | 5 ppm | | |
| S-0-5ft-11-C | " | " | 1:45 PM | 20 ppm | | |
| S-0-5ft-11-D | " | " | 1:50 PM | 5 ppm | | |
| S-0-5ft-12-A | " | " | 2:10 PM | 20 ppm | TPHg BTX | |
| S-0-5ft-12-B | " | " | 2:05 PM | 4 ppm | | |
| S-0-5ft-12-C | " | " | 2:00 PM | 10 ppm | | |
| S-0-5ft-12-D | " | " | 1:55 PM | 5 ppm | | |

FIELD SAMPLING NOTES

Woodward-Clyde

| | |
|--|-------------------|
| Project Location: 4000 San Pablo Ave. @ 40th St., Emeryville, CA | Page 4 of |
| Project Number: 941114NA | Date: 7/22/94 |
| Task Number: 4000 | Weather: cloudy |
| Sampled by: Steve Penman & Xyzzying Tony | Temperature: 70°F |
| Summary of Main Activities: Sampling excavated, stockpiled soil for disposal to B&J landfill | Wind: 0-10 MPH |

| Sample No. | Type | Date | Time | Field PID screening | Analyses requested | Notes |
|--------------|------|---------|-------|---------------------|--------------------------------------|------------|
| S-0-5ft-13-A | SOIL | 7/22/94 | 14.15 | 5 ppm | TPH _g BTX _X | See page 1 |
| S-0-5ft-13-B | " | " | 14.17 | 7 ppm | | |
| S-0-5ft-13-C | " | " | 14.19 | 3 ppm | | |
| S-0-5ft-13-D | " | " | 14.21 | 5 ppm | | |
| S-0-5ft-14-A | " | " | 14.28 | 2 ppm | TPH _g BTX _X | |
| S-0-5ft-14-B | " | " | 14.26 | 7 ppm | | |
| S-0-5ft-14-C | " | " | 14.24 | 5 ppm | | |
| S-0-5ft-14-D | " | " | 14.22 | 10 ppm | | |
| S-0-5ft-15-A | " | " | 14.30 | 5 ppm | TPH _g BTX _X | |
| S-0-5ft-15-B | " | " | 14.32 | 10 ppm | | |
| S-0-5ft-15-C | " | " | 14.34 | 8 ppm | | |
| S-0-5ft-15-D | " | " | 14.36 | 15 ppm | | |
| S-0-5ft-16-A | " | " | 14.44 | 20 ppm | TPH _g BTX _X | |
| S-0-5ft-16-B | " | " | 14.42 | 30 ppm | | |
| S-0-5ft-16-C | " | " | 14.40 | 30 ppm | | |
| S-0-5ft-16-D | " | " | 14.38 | 5 ppm | | |

FIELD SAMPLING NOTES

Woodward-Clyde

| | |
|--|------------------|
| Project Location: 4000 San Pablo Ave. @ 40th St., Emeryville | Page 1 of 1 |
| Project Number: 941114NA | Date: 7/22/94 |
| Task Number: 1000 | Weather: cloudy |
| Sampled by: Steve Penman & Gregory Long | Temperature: 70F |
| Summary of Main Activities: | Wind: 0-10 MPH |
| Collected Soil Samples from stockpiled hot spots soil | |

| Sample No. | Type | Date | Time | Field PID screening | Analyses requested | Notes |
|------------|------|---------|-------|---------------------|-----------------------|--------------------------------|
| S-D-A | Soil | 7/22/94 | 15.00 | 70 ppm | TPH: diesel | From the diesel hot spot |
| S-D-B | " | " | 15.05 | 50 ppm | " | |
| S-D-C | " | " | 15.10 | 80 ppm | " | |
| S-D-D | " | " | 15.15 | 90 ppm | " | |
| S-O&G-A | " | " | 15.20 | 20 ppm | OKG, AET CAM 17 metal | from the waste oil tank spot |
| S-O&G-B | " | " | 15.25 | 90 ppm | " | |
| S-O&G-C | " | " | 15.30 | 60 ppm | " | |
| S-O&G-D | " | " | 15.35 | 40 ppm | " | |
| S-G-A | " | " | 15.40 | 70 ppm | TPH, BTEX | from the B-8, 9, 10 hot spots. |
| S-G-B | " | " | 15.45 | 150 ppm | " | |
| S-G-C | " | " | 15.50 | 50 ppm | " | |
| S-G-D | " | " | 14.55 | 120 ppm | " | |

APPENDIX D.2
ANALYTICAL REPORT FOR SOIL EXCAVATED
FROM 0 TO 5 FT BELOW GRADE



EXCELLENCE
IN ANALYSIS

COAST-TO-COAST ANALYTICAL SERVICES, INC.

August 4, 1994

Mr. Xinggang Tong
Woodward-Clyde Consultants
500 12th Street, Suite 100
Oakland, CA 94607-4014

SUBJECT: Case Narrative for Project # 941114NA

Dear Mr. Tong:

The soil samples collected for this project on July 22nd were received at Coast-to-Coast Analytical Services on the same day. There were 84 samples submitted which were composited into 21 samples as instructed. They were assigned laboratory work order number JK-2266 (1 thru 21). All the samples were received intact with a chain of custody. The temperature of the cooler is 69 deg F.

The samples were analyzed for BTEX (EPA 8020), TPH-Gasoline/Diesel (EPA 8015m), Oil & Grease (SM5520), and metals (EPA 6010/7000). All the analyses were performed within the holding time using CADHS approved methods. No problem was encountered.

BTEX/TPH (Gasoline) by EPA 8020/8015M

Nineteen soil composites were extracted in methanol on July 22nd. The extracts were stored in the refrigerator until they were analyzed on July 25th and 26th. The samples showed varying concentrations of BTEX and gasoline, almost all had to be diluted. In some samples, the surrogate was diluted out and not detected. In six samples, the surrogate recovery was high and outside the upper limit due to the surrogate coeluting with a hydrocarbon peak. The method blank was clean. The surrogate recoveries for the rest of the samples were within acceptance limits. The lab control spike recoveries and the RPDs (relative percent difference) for the duplicate analysis were all within the acceptance limits. Matrix spikes were not analyzed since all the samples were high in gasoline and spikes would have been diluted out.

TPH (Diesel) by EPA 8015M

Only one composite sample was analyzed for diesel. The sample was extracted on July 26th by EPA 3550 (sonication method) and the extract

page 1 of 2

analyzed on the same day. The extract was diluted 100-fold. The method blank was clean. The spike recoveries were all within acceptable limits although the RPD was high.

Oil & Grease by SM 5520 D&F

Only one sample was analyzed for oil and grease. The soil was extracted by soxhlet method and the extract was treated with silica gel then analyzed gravimetrically for oil and grease. The sample was clean. The method blank was clean. The spike recoveries and the RPD for the duplicate analysis were all within the acceptance limits.

Soluble Metals by EPA 6010/7000

One sample was extracted for CAM 17 soluble metals. The sample was extracted on July 25th and extract digested on July 28th. The digests were analyzed by ICP and AA on July 28th and 29th. None of the metals detected exceeded their STLC levels. The method blank was clean. The spike recoveries and the RPDs for the duplicate analyses were all within the acceptance limits.

Sincerely,

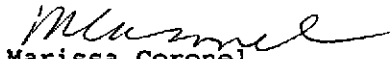
Marissa Coronel
Laboratory Director
Coast-to-Coast Analytical Services
Northern California Division



COAST-TO-COAST ANALYTICAL SERVICES, INC.

EXCELLENCE
IN ANALYSIS

NorCal Division (San Jose Laboratory)
2059 Junction Ave.

San Jose, CA 95131
(408) 955-9077

CLIENT: Xinggang Tong
Woodward-Clyde Consultants
500 12th St. Ste. 100
Oakland, CA 94607-4014

Lab Number : JK-2266-20
Project : 941114NA

REPORT OF ANALYTICAL RESULTS

Page 1 of 1

| SAMPLE DESCRIPTION | MATRIX | SAMPLED BY | | SAMPLED | RECEIVED | | |
|----------------------------|--------|------------|-------|---------------|----------|----|-------|
| Composite of S-O&G-A,B,C,D | Soil | S.P. | | 07/22/94 1535 | 07/22/94 | | |
| CONSTITUENT | *PQL | RESULT | UNITS | METHOD | ANALYZED | BY | NOTES |
| Antimony, Soluble | 0.05 | ND | mg/L | EPA 7041 | 07/28/94 | DO | 1,2 |
| Arsenic, Soluble | 0.05 | 0.08 | mg/L | EPA 7060 | 07/28/94 | DO | 1,2 |
| Barium, Soluble | 0.05 | 8.7 | mg/L | EPA 6010 | 07/29/94 | NT | 1,2 |
| Beryllium, Soluble | 0.05 | ND | mg/L | EPA 6010 | 07/29/94 | NT | 1,2 |
| Cadmium, Soluble | 0.05 | ND | mg/L | EPA 6010 | 07/29/94 | NT | 1,2 |
| Chromium, Soluble | 0.05 | 0.07 | mg/L | EPA 6010 | 07/29/94 | NT | 1,2 |
| Cobalt, Soluble | 0.05 | 0.16 | mg/L | EPA 6010 | 07/29/94 | NT | 1,2 |
| Copper, Soluble | 0.05 | 0.07 | mg/L | EPA 6010 | 07/29/94 | NT | 1,2 |
| Lead, Soluble | 0.1 | ND | mg/L | EPA 7420 | 07/28/94 | DO | 1,2 |
| Mercury, Soluble | 0.0002 | ND | mg/L | EPA 7470 | 07/29/94 | DO | 2 |
| Molybdenum, Soluble | 0.05 | ND | mg/L | EPA 6010 | 07/29/94 | NT | 1,2 |
| Nickel, Soluble | 0.05 | 0.34 | mg/L | EPA 6010 | 07/29/94 | NT | 1,2 |
| Selenium, Soluble | 0.05 | ND | mg/L | EPA 7740 | 07/28/94 | DO | 1,2 |
| Silver, Soluble | 0.01 | ND | mg/L | EPA 7760 | 07/28/94 | DO | 3,2 |
| Thallium, Soluble | 0.5 | ND | mg/L | EPA 7840 | 07/28/94 | DO | 1,2 |
| Vanadium, Soluble | 0.05 | 0.34 | mg/L | EPA 6010 | 07/29/94 | NT | 1,2 |
| Zinc, Soluble | 0.1 | 0.2 | mg/L | EPA 6010 | 07/29/94 | NT | 1,2 |

San Jose Lab Certifications: CAELAP #1204

*RESULTS listed as 'ND' were not detected at or above the listed PQL (Practical Quantitation Limit)

- (1) Sample Preparation on 07/28/94 by TN using EPA 3020
- (3) Sample Preparation on 07/28/94 by TN using EPA 3010
- (2) CA WET Extraction (Citrate Buffer) on 07/25/94 by NT

07/29/94

NG/nfga3(dw)
WET94072801

Respectfully submitted,
COAST-TO-COAST ANALYTICAL SERVICES, INC.

Nick Gaone
Inorganics Manager

Reports shall not be reproduced except in full without the written consent of Coast-to-Coast Analytical Services Inc.



COAST-TO-COAST ANALYTICAL SERVICES, INC.

EXCELLENCE
IN ANALYSIS

NorCal Division (San Jose Laboratory)
2059 Junction Ave.

San Jose, CA 95131
(408) 955-9077

CLIENT: Kinggang Tong
Woodward-Clyde Consultants
500 12th St. Ste. 100
Oakland, CA 94607-4014

QC Batch ID: WET94072801 JK-2266-20
Project : 941114NA

QC DUPLICATE REPORT OF ANALYTICAL RESULTS

Page 1 of 1

| SAMPLE DESCRIPTION | MATRIX | SAMPLED BY | | SAMPLED DATE RECEIVED | | | | |
|----------------------------|--------|------------|-------|-----------------------|----------|----------|----|------|
| Composite of S-O&G-A,B,C,D | Solid | S.P. | | 07/22/94 | 07/22/94 | | | |
| CONSTITUENT | *PQL | RESULT | %DIFF | UNITS | METHOD | ANALYZED | BY | NOTE |
| Antimony, Soluble | 0.05 | ND | | mg/L | EPA 7041 | 07/28/94 | DO | 1,2 |
| Arsenic, Soluble | 0.05 | 0.08 | 0. | mg/L | EPA 7060 | 07/28/94 | DO | 1 |
| Barium, Soluble | 0.05 | 8.4 | 3.5 | mg/L | EPA 6010 | 07/29/94 | NT | 1 |
| Beryllium, Soluble | 0.05 | ND | | mg/L | EPA 6010 | 07/29/94 | NT | 1 |
| Cadmium, Soluble | 0.05 | ND | | mg/L | EPA 6010 | 07/29/94 | NT | 1 |
| Chromium, Soluble | 0.05 | 0.07 | 0. | mg/L | EPA 6010 | 07/29/94 | NT | 1 |
| Cobalt, Soluble | 0.05 | 0.16 | 0. | mg/L | EPA 6010 | 07/29/94 | NT | 1 |
| Copper, Soluble | 0.05 | 0.07 | 0. | mg/L | EPA 6010 | 07/29/94 | NT | 1 |
| Lead, Soluble | 0.1 | ND | | mg/L | EPA 7420 | 07/28/94 | DO | 1 |
| Mercury, Soluble | 0.0002 | ND | | mg/L | EPA 7470 | 07/29/94 | DO | |
| Molybdenum, Soluble | 0.05 | ND | | mg/L | EPA 6010 | 07/29/94 | NT | 1 |
| Nickel, Soluble | 0.05 | 0.34 | 0. | mg/L | EPA 6010 | 07/29/94 | NT | 1 |
| Selenium, Soluble | 0.05 | ND | | mg/L | EPA 7740 | 07/28/94 | DO | 1 |
| Thallium, Soluble | 0.5 | ND | | mg/L | EPA 7840 | 07/28/94 | DO | 1 |
| Vanadium, Soluble | 0.05 | 0.34 | 0. | mg/L | EPA 6010 | 07/29/94 | NT | 1 |
| Zinc, Soluble | 0.1 | 0.2 | 0. | mg/L | EPA 6010 | 07/29/94 | NT | 1 |

San Jose Lab Certifications: CAELAP #1204

*RESULTS listed as 'ND' were not detected at or above the listed PQL (Practical Quantitation Limit)

- (1) Sample Preparation on 07/28/94 by TN using EPA 3020
- (2) CA WET Extraction (Citrate Buffer) on 07/25/94 by NT

07/29/94

NG/nfga3(dw)
JK2266-20

Respectfully submitted,
COAST-TO-COAST ANALYTICAL SERVICES, INC.

Nick Gaone
Inorganics Manager

Reports shall not be reproduced except in full without the written consent of Coast-to-Coast Analytical Services Inc.



COAST-TO-COAST ANALYTICAL SERVICES, INC.

EXCELLENCE
IN ANALYSIS

NorCal Division (San Jose Laboratory)
2059 Junction Ave.

San Jose, CA 95131
(408) 955-9077

QC Batch ID: WET94072801

CLIENT: Coast-to-Coast Analytical Services, Inc.

METHOD BLANK
REPORT OF ANALYTICAL RESULTS

Page 1 of 1

| SAMPLE DESCRIPTION | MATRIX | SAMPLED BY | | SAMPLED DATE RECEIVED | | | |
|---------------------|--------|------------|-------|-----------------------|----------|----|------|
| METHOD BLANK | Solid | | | | | | |
| CONSTITUENT | *PQL | RESULT | UNITS | METHOD | ANALYZED | BY | NOTE |
| Antimony, Soluble | 0.05 | ND | mg/L | EPA 7041 | 07/28/94 | DO | 1,2 |
| Arsenic, Soluble | 0.05 | ND | mg/L | EPA 7060 | 07/28/94 | DO | 1 |
| Barium, Soluble | 0.05 | ND | mg/L | EPA 6010 | 07/29/94 | NT | 1 |
| Beryllium, Soluble | 0.05 | ND | mg/L | EPA 6010 | 07/29/94 | NT | 1 |
| Cadmium, Soluble | 0.05 | ND | mg/L | EPA 6010 | 07/29/94 | NT | 1 |
| Chromium, Soluble | 0.05 | ND | mg/L | EPA 6010 | 07/29/94 | NT | 1 |
| Cobalt, Soluble | 0.05 | ND | mg/L | EPA 6010 | 07/29/94 | NT | 1 |
| Copper, Soluble | 0.05 | ND | mg/L | EPA 6010 | 07/29/94 | NT | 1 |
| Lead, Soluble | 0.1 | ND | mg/L | EPA 7420 | 07/28/94 | DO | 1 |
| Mercury, Soluble | 0.0002 | ND | mg/L | EPA 7470 | 07/29/94 | DO | |
| Molybdenum, Soluble | 0.05 | ND | mg/L | EPA 6010 | 07/29/94 | NT | 1 |
| Nickel, Soluble | 0.05 | ND | mg/L | EPA 6010 | 07/29/94 | NT | 1 |
| Selenium, Soluble | 0.05 | ND | mg/L | EPA 7740 | 07/28/94 | DO | 1 |
| Silver, Soluble | 0.01 | ND | mg/L | EPA 7760 | 07/28/94 | DO | 3 |
| Thallium, Soluble | 0.5 | ND | mg/L | EPA 7840 | 07/28/94 | DO | 1 |
| Vanadium, Soluble | 0.05 | ND | mg/L | EPA 6010 | 07/29/94 | NT | 1 |
| Zinc, Soluble | 0.1 | ND | mg/L | EPA 6010 | 07/29/94 | NT | 1 |

San Jose Lab Certifications: CAELAP #1204

*RESULTS listed as 'ND' were not detected at or above the listed PQL (Practical Quantitation Limit)

- (1) Sample Preparation on 07/28/94 by TN using EPA 3020
- (3) Sample Preparation on 07/28/94 by TN using EPA 3010
- (2) CA WET Extraction (Citrate Buffer) on 07/25/94 by NT

07/29/94

NG/nfga3(dw)
JK2266-20

Respectfully submitted,
COAST-TO-COAST ANALYTICAL SERVICES, INC.

Nick Gaone
Inorganics Manager

Reports shall not be reproduced except in full without the written consent of Coast-to-Coast Analytical Services Inc.



COAST-TO-COAST ANALYTICAL SERVICES, INC.

EXCELLENCE
IN ANALYSIS

NorCal Division (San Jose Laboratory)
2059 Junction Ave.

San Jose, CA 95131
(408) 955-9077

QC Batch ID: WET94072801

CLIENT: Coast-to-Coast Analytical Services, Inc.

QC MATRIX SPIKE REPORT OF ANALYTICAL RESULTS

Page 1 of 1

| SAMPLE DESCRIPTION | MATRIX | SAMPLED BY | | SAMPLED DATE RECEIVED | | | | | |
|---------------------|----------|------------|--------|-----------------------|-------|----------|----------|----|------|
| MATRIX SPIKE | Solid | | | | | | | | |
| CONSTITUENT | ORIGINAL | SPIKE | RESULT | %REC | UNITS | METHOD | ANALYZED | BY | NOTE |
| Antimony, Soluble | ND | 1.0 | 0.85 | 85. | mg/L | EPA 7041 | 07/28/94 | DO | 1,2 |
| Arsenic, Soluble | 0.08 | 1.0 | 1.0 | 92. | mg/L | EPA 7060 | 07/28/94 | DO | 1 |
| Barium, Soluble | 8.7 | 5.0 | 13. | 86. | mg/L | EPA 6010 | 07/29/94 | NT | 1 |
| Beryllium, Soluble | ND | 5.0 | 4.3 | 86. | mg/L | EPA 6010 | 07/29/94 | NT | 1 |
| Cadmium, Soluble | ND | 2.5 | 2.2 | 88. | mg/L | EPA 6010 | 07/29/94 | NT | 1 |
| Chromium, Soluble | 0.07 | 2.5 | 2.3 | 89. | mg/L | EPA 6010 | 07/29/94 | NT | 1 |
| Cobalt, Soluble | 0.16 | 5.0 | 4.4 | 85. | mg/L | EPA 6010 | 07/29/94 | NT | 1 |
| Copper, Soluble | 0.07 | 5.0 | 4.6 | 91. | mg/L | EPA 6010 | 07/29/94 | NT | 1 |
| Lead, Soluble | ND | 2.5 | 2.2 | 88. | mg/L | EPA 7420 | 07/28/94 | DO | 1 |
| Mercury, Soluble | ND | 0.0020 | 0.0019 | 95. | mg/L | EPA 7470 | 07/29/94 | DO | |
| Molybdenum, Soluble | ND | 5.0 | 5.0 | 100. | mg/L | EPA 6010 | 07/29/94 | NT | 1 |
| Nickel, Soluble | 0.34 | 5.0 | 4.7 | 87. | mg/L | EPA 6010 | 07/29/94 | NT | 1 |
| Selenium, Soluble | ND | 1.0 | 1.1 | 110. | mg/L | EPA 7740 | 07/28/94 | DO | 1 |
| Silver, Soluble | ND | 1.0 | 0.91 | 91. | mg/L | EPA 7760 | 07/28/94 | DO | 3 |
| Thallium, Soluble | ND | 5.0 | 4.6 | 92. | mg/L | EPA 7840 | 07/28/94 | DO | 1 |
| Vanadium, Soluble | 0.34 | 2.5 | 2.8 | 98. | mg/L | EPA 6010 | 07/29/94 | NT | 1 |
| Zinc, Soluble | 0.2 | 5.0 | 4.8 | 92. | mg/L | EPA 6010 | 07/29/94 | NT | 1 |

San Jose Lab Certifications: CAELAP #1204

*RESULTS listed as 'ND' were not detected at or above the listed PQL (Practical Quantitation Limit)

- (1) Sample Preparation on 07/28/94 by TN using EPA 3020
- (3) Sample Preparation on 07/28/94 by TN using EPA 3010
- (2) CA WET Extraction (Citrate Buffer) on 07/25/94 by NT

07/29/94

NG/nfga3(dw)
JK2266-20

Respectfully submitted,
COAST-TO-COAST ANALYTICAL SERVICES, INC.

Nick Gaone
Inorganics Manager

Reports shall not be reproduced except in full without the written consent of Coast-to-Coast Analytical Services Inc.



COAST-TO-COAST ANALYTICAL SERVICES, INC.

EXCELLENCE
IN ANALYSIS

NorCal Division (San Jose Laboratory)
2059 Junction Ave.

San Jose, CA 95131
(408) 955-9077

QC Batch ID: WET94072801

CLIENT: Coast-to-Coast Analytical Services, Inc.

QC MATRIX SPIKE REPORT OF ANALYTICAL RESULTS

Page 1 of 1

| SAMPLE DESCRIPTION | MATRIX | SAMPLED BY | SAMPLED DATE RECEIVED | | | | | | |
|------------------------|----------|------------|-----------------------|-------|-------|----------|----------|----|------|
| MATRIX SPIKE DUPLICATE | Solid | | | | | | | | |
| CONSTITUENT | ORIGINAL | SPIKE | RESULT | %DIFF | UNITS | METHOD | ANALYZED | BY | NOTE |
| Antimony, Soluble | ND | 1.0 | 0.81 | 4.8 | mg/L | EPA 7041 | 07/28/94 | DO | 1,2 |
| Arsenic, Soluble | 0.08 | 1.0 | 0.96 | 4.4 | mg/L | EPA 7060 | 07/28/94 | DO | 1 |
| Barium, Soluble | 8.7 | 5.0 | 13. | 0. | mg/L | EPA 6010 | 07/29/94 | NT | 1 |
| Beryllium, Soluble | ND | 5.0 | 4.2 | 2.4 | mg/L | EPA 6010 | 07/29/94 | NT | 1 |
| Cadmium, Soluble | ND | 2.5 | 2.1 | 4.7 | mg/L | EPA 6010 | 07/29/94 | NT | 1 |
| Chromium, Soluble | 0.07 | 2.5 | 2.3 | 0. | mg/L | EPA 6010 | 07/29/94 | NT | 1 |
| Cobalt, Soluble | 0.16 | 5.0 | 4.4 | 0. | mg/L | EPA 6010 | 07/29/94 | NT | 1 |
| Copper, Soluble | 0.07 | 5.0 | 4.6 | 0. | mg/L | EPA 6010 | 07/29/94 | NT | 1 |
| Lead, Soluble | ND | 2.5 | 2.2 | 0. | mg/L | EPA 7420 | 07/28/94 | DO | 1 |
| Mercury, Soluble | ND | 0.0020 | 0.0017 | 11. | mg/L | EPA 7470 | 07/29/94 | DO | |
| Molybdenum, Soluble | ND | 5.0 | 5.1 | 2. | mg/L | EPA 6010 | 07/29/94 | NT | 1 |
| Nickel, Soluble | 0.34 | 5.0 | 4.6 | 2.3 | mg/L | EPA 6010 | 07/29/94 | NT | 1 |
| Selenium, Soluble | ND | 1.0 | 1.1 | 0. | mg/L | EPA 7740 | 07/28/94 | DO | 1 |
| Silver, Soluble | ND | 1.0 | 1.0 | 9.4 | mg/L | EPA 7760 | 07/28/94 | DO | 3 |
| Thallium, Soluble | ND | 5.0 | 4.5 | 2.2 | mg/L | EPA 7840 | 07/28/94 | DO | 1 |
| Vanadium, Soluble | 0.34 | 2.5 | 2.7 | 4.1 | mg/L | EPA 6010 | 07/29/94 | NT | 1 |
| Zinc, Soluble | 0.2 | 5.0 | 4.8 | 0. | mg/L | EPA 6010 | 07/29/94 | NT | 1 |

San Jose Lab Certifications: CAELAP #1204

*RESULTS listed as 'ND' were not detected at or above the listed PQL (Practical Quantitation Limit)

- (1) Sample Preparation on 07/28/94 by TN using EPA 3020
- (3) Sample Preparation on 07/28/94 by TN using EPA 3010
- (2) CA WET Extraction (Citrate Buffer) on 07/25/94 by NT

07/29/94

NG/nfga3(dw)
JK2266-20

Respectfully submitted,
COAST-TO-COAST ANALYTICAL SERVICES, INC.

Nick Gaone
Inorganics Manager

Reports shall not be reproduced except in full without the written consent of Coast-to-Coast Analytical Services Inc.



COAST-TO-COAST ANALYTICAL SERVICES, INC.

EXCELLENCE
IN ANALYSIS

NorCal Division (San Jose Laboratory)
2059 Junction Ave.

San Jose, CA 95131
(408) 955-9077

QC Batch ID: WET94072801

CLIENT: Coast-to-Coast Analytical Services, Inc.

QC SPIKE REPORT OF ANALYTICAL RESULTS

Page 1 of 1

| SAMPLE DESCRIPTION | MATRIX | SAMPLED BY | | SAMPLED DATE RECEIVED | | | | | |
|---------------------|--------|------------|--------|-----------------------|-------|----------|----------|----|------|
| QC SPIKE | Solid | | | | | | | | |
| CONSTITUENT | *PQL | SPIKE | RESULT | %REC | UNITS | METHOD | ANALYZED | BY | NOTE |
| Antimony, Soluble | 0.05 | 1.0 | 0.94 | 94. | mg/L | EPA 7041 | 07/28/94 | DO | 1,2 |
| Arsenic, Soluble | 0.05 | 1.0 | 1.0 | 100. | mg/L | EPA 7060 | 07/28/94 | DO | 1 |
| Barium, Soluble | 0.05 | 5.0 | 4.5 | 90. | mg/L | EPA 6010 | 07/29/94 | NT | 1 |
| Beryllium, Soluble | 0.05 | 5.0 | 4.3 | 86. | mg/L | EPA 6010 | 07/29/94 | NT | 1 |
| Cadmium, Soluble | 0.05 | 2.5 | 2.2 | 88. | mg/L | EPA 6010 | 07/29/94 | NT | 1 |
| Chromium, Soluble | 0.05 | 2.5 | 2.3 | 92. | mg/L | EPA 6010 | 07/29/94 | NT | 1 |
| Cobalt, Soluble | 0.05 | 5.0 | 4.2 | 84. | mg/L | EPA 6010 | 07/29/94 | NT | 1 |
| Copper, Soluble | 0.05 | 5.0 | 4.6 | 92. | mg/L | EPA 6010 | 07/29/94 | NT | 1 |
| Lead, Soluble | 0.1 | 2.5 | 2.3 | 92. | mg/L | EPA 7420 | 07/28/94 | DO | 1 |
| Mercury, Soluble | 0.0002 | 0.0020 | 0.0018 | 90. | mg/L | EPA 7470 | 07/29/94 | DO | |
| Molybdenum, Soluble | 0.05 | 5.0 | 5.2 | 104. | mg/L | EPA 6010 | 07/29/94 | NT | 1 |
| Nickel, Soluble | 0.05 | 5.0 | 4.2 | 84. | mg/L | EPA 6010 | 07/29/94 | NT | 1 |
| Selenium, Soluble | 0.05 | 1.0 | 1.1 | 110. | mg/L | EPA 7740 | 07/28/94 | DO | 1 |
| Silver, Soluble | 0.01 | 1.0 | 1.0 | 100. | mg/L | EPA 7760 | 07/28/94 | DO | 3 |
| Thallium, Soluble | 0.5 | 5.0 | 4.6 | 92. | mg/L | EPA 7840 | 07/28/94 | DO | 1 |
| Vanadium, Soluble | 0.05 | 2.5 | 2.3 | 92. | mg/L | EPA 6010 | 07/29/94 | NT | 1 |
| Zinc, Soluble | 0.1 | 5.0 | 4.5 | 90. | mg/L | EPA 6010 | 07/29/94 | NT | 1 |

San Jose Lab Certifications: CAELAP #1204

*RESULTS listed as 'ND' were not detected at or above the listed PQL (Practical Quantitation Limit)

- (1) Sample Preparation on 07/28/94 by TN using EPA 3020
- (3) Sample Preparation on 07/28/94 by TN using EPA 3010
- (2) CA WET Extraction (Citrate Buffer) on 07/25/94 by NT

07/29/94

NG/nfga3(dw)
JK2266-20

Respectfully submitted,
COAST-TO-COAST ANALYTICAL SERVICES, INC.

Nick J. Gaone

Nick Gaone
Inorganics Manager

Reports shall not be reproduced except in full without the written consent of Coast-to-Coast Analytical Services Inc.



COAST-TO-COAST ANALYTICAL SERVICES, INC.

EXCELLENCE
IN ANALYSIS

NorCal Division (San Jose Laboratory)
2059 Junction Ave.

San Jose, CA 95131
(408) 955-9077

CLIENT: Xinggang Tong
Woodward-Clyde Consultants
500 12th St. Ste. 100
Oakland, CA 94607-4014

Lab Number : JK-2266-1
Project : 941114NA
Analyzed : 07/25/94
Analyzed by: LD
Method : EPA 8020/8015M

REPORT OF ANALYTICAL RESULTS

Page 1 of 1

| SAMPLE DESCRIPTION | MATRIX | SAMPLED BY | SAMPLED | RECEIVED |
|---|----------|---------------|-----------------|----------|
| Composite of S-0-5ft-1-A,B,C,D | Soil | S.P. | 07/22/94 1005 | 07/22/94 |
| CONSTITUENT | (CAS RN) | *PQL mg/Kg | RESULT mg/Kg | NOTE |
| BTEX + TPH (Gasoline) | | | | 1,2,3 |
| Benzene | | 0.1 | 0.15 | |
| Toluene | | 0.1 | 1.1 | |
| Ethylbenzene | | 0.1 | 1.2 | |
| Xylenes | | 0.1 | 9.0 | |
| Total Petroleum Hydrocarbons (Gasoline) | | 20. | 110. | |

San Jose Lab Certifications: CAELAP #1204

*RESULTS listed as 'ND' were not detected at or above the listed PQL (Practical Quantitation Limit)

- (1) Sample Preparation on 07/22/94 by LB
- (2) EXTRACTED by EPA 5030 (purge-and-trap)
- (3) Surrogate diluted out.

07/26/94
GC#4\725B605
DT/eta3(dw)
S-B-072294

Respectfully submitted,
COAST-TO-COAST ANALYTICAL SERVICES, INC.

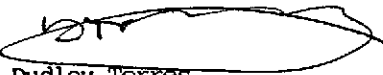
Dudley Torres
Organics Manager

Reports shall not be reproduced except in full without the written consent of Coast-to-Coast Analytical Services Inc.



COAST-TO-COAST ANALYTICAL SERVICES, INC.

EXCELLENCE
IN ANALYSIS

NorCal Division (San Jose Laboratory)
2059 Junction Ave.

San Jose, CA 95131
(408) 955-9077

CLIENT: Xinggang Tong
Woodward-Clyde Consultants
500 12th St. Ste. 100
Oakland, CA 94607-4014

Lab Number : JK-2266-2
Project : 941114NA
Analyzed : 07/25/94
Analyzed by: LD
Method : EPA 8020/8015M

REPORT OF ANALYTICAL RESULTS

Page 1 of 1

| SAMPLE DESCRIPTION | MATRIX | SAMPLED BY | SAMPLED | RECEIVED |
|---|----------|---------------|-----------------|----------|
| Composite of S-0-5ft-2-A,B,C,D | Soil | S.P. | 07/22/94 1040 | 07/22/94 |
| CONSTITUENT | (CAS RN) | *PQL mg/Kg | RESULT mg/Kg | NOTE |
| BTEX + TPH (Gasoline) | | | | 1,2 |
| Benzene | | 0.03 | 0.06 | |
| Toluene | | 0.03 | 0.45 | |
| Ethylbenzene | | 0.03 | 0.57 | |
| Xylenes | | 0.03 | 4.3 | |
| Total Petroleum Hydrocarbons (Gasoline) | | 5. | 59. | |
| Percent Surrogate Recovery | | | 115. | |

San Jose Lab Certifications: CAELAP #1204

*RESULTS listed as 'ND' were not detected at or above the listed PQL (Practical Quantitation Limit)

- (1) Sample Preparation on 07/22/94 by LB
- (2) EXTRACTED by EPA 5030 (purge-and-trap)

08/04/94
GC#4\725B619
DT/eta3(dw)/mcc
S-B-072294

Respectfully submitted,
COAST-TO-COAST ANALYTICAL SERVICES, INC.

Dudley Torres
Organics Manager

Reports shall not be reproduced except in full without the written consent of Coast-to-Coast Analytical Services Inc.



COAST-TO-COAST ANALYTICAL SERVICES, INC.

EXCELLENCE
IN ANALYSIS

NorCal Division (San Jose Laboratory)
2059 Junction Ave.

San Jose, CA 95131
(408) 955-9077

CLIENT: Xinggang Tong
Woodward-Clyde Consultants
500 12th St. Ste. 100
Oakland, CA 94607-4014

Lab Number : JK-2266-3
Project : 941114NA
Analyzed : 07/25/94
Analyzed by: LD
Method : EPA 8020/8015M

REPORT OF ANALYTICAL RESULTS

Page 1 of 1

| SAMPLE DESCRIPTION | MATRIX | SAMPLED BY | SAMPLED | RECEIVED |
|--------------------------------|--------|------------|---------------|----------|
| Composite of S-0-5ft-3-A,B,C,D | Soil | S.P. | 07/22/94 1045 | 07/22/94 |

| CONSTITUENT | (CAS RN) | *PQL mg/Kg | RESULT mg/Kg | NOTE |
|---|----------|---------------|-----------------|-------|
| BTEX + TPH (Gasoline) | | | | 1,2,3 |
| Benzene | | 0.03 | 0.04 | |
| Toluene | | 0.03 | 0.42 | |
| Ethylbenzene | | 0.03 | 0.74 | |
| Xylenes | | 0.03 | 5.9 | |
| Total Petroleum Hydrocarbons (Gasoline) | | 5. | 83. | |

San Jose Lab Certifications: CAELAP #1204

- *RESULTS listed as 'ND' were not detected at or above the listed PQL (Practical Quantitation Limit)
- (1) Sample Preparation on 07/22/94 by LB
 - (2) EXTRACTED by EPA 5030 (purge-and-trap)
 - (3) Surrogate diluted out.

07/26/94
GC#4\725B620
DT/eta3(dw)
S-B-072294

Respectfully submitted,
COAST-TO-COAST ANALYTICAL SERVICES, INC.

Dudley Torres
Organics Manager

Reports shall not be reproduced except in full without the written consent of Coast-to-Coast Analytical Services Inc.



COAST-TO-COAST ANALYTICAL SERVICES, INC.

EXCELLENCE
IN ANALYSIS

NorCal Division (San Jose Laboratory)
2059 Junction Ave.

San Jose, CA 95131
(408) 955-9077

CLIENT: Kinggang Tong
Woodward-Clyde Consultants
500 12th St. Ste. 100
Oakland, CA 94607-4014

Lab Number : JK-2266-4
Project : 941114NA
Analyzed : 07/25/94
Analyzed by: LD
Method : EPA 8020/8015M

REPORT OF ANALYTICAL RESULTS

Page 1 of 1

| SAMPLE DESCRIPTION | MATRIX | SAMPLED BY | SAMPLED | RECEIVED |
|---|----------|---------------|-----------------|----------|
| Composite of S-0-5ft-4-A,B,C,D | Soil | S.P. | 07/22/94 1120 | 07/22/94 |
| CONSTITUENT | (CAS RN) | *PQL mg/Kg | RESULT mg/Kg | NOTE |
| BTEX + TPH (Gasoline) | | | | 1,2,3 |
| Benzene | | 0.1 | 0.14 | |
| Toluene | | 0.1 | 1.1 | |
| Ethylbenzene | | 0.1 | 1.5 | |
| Xylenes | | 0.1 | 10. | |
| Total Petroleum Hydrocarbons (Gasoline) | | 20. | 140. | |

San Jose Lab Certifications: CAELAP #1204

*RESULTS listed as 'ND' were not detected at or above the listed PQL (Practical Quantitation Limit)

- (1) Sample Preparation on 07/22/94 by LB
- (2) EXTRACTED by EPA 5030 (purge-and-trap)
- (3) Surrogate diluted out.

07/26/94
GC#4\725B608
DT/eta3(dw)
S-B-072294

Respectfully submitted,
COAST-TO-COAST ANALYTICAL SERVICES, INC.

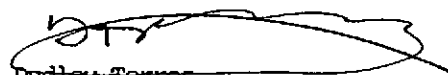
Dudley Torres
Organics Manager

Reports shall not be reproduced except in full without the written consent of Coast-to-Coast Analytical Services Inc.



COAST-TO-COAST ANALYTICAL SERVICES, INC.

EXCELLENCE
IN ANALYSIS

NorCal Division (San Jose Laboratory)
2059 Junction Ave.

San Jose, CA 95131
(408) 955-9077

CLIENT: Xinggang Tong
Woodward-Clyde Consultants
500 12th St. Ste. 100
Oakland, CA 94607-4014

Lab Number : JK-2266-5
Project : 941114NA
Analyzed : 07/22/94
Analyzed by: LD
Method : EPA 8020/8015M

REPORT OF ANALYTICAL RESULTS

Page 1 of 1

| SAMPLE DESCRIPTION | MATRIX | SAMPLED BY | SAMPLED | RECEIVED |
|--------------------------------|--------|------------|---------------|----------|
| Composite of S-0-5ft-5-A,B,C,D | Soil | S.P. | 07/22/94 1125 | 07/22/94 |

| CONSTITUENT | (CAS RN) | *PQL mg/Kg | RESULT mg/Kg | NOTE |
|---|----------|---------------|-----------------|------|
| BTEX + TPH (Gasoline) | | | | 1,2 |
| Benzene | | 0.05 | 0.12 | |
| Toluene | | 0.05 | 0.66 | |
| Ethylbenzene | | 0.05 | 0.83 | |
| Xylenes | | 0.05 | 5.8 | |
| Total Petroleum Hydrocarbons (Gasoline) | | 10. | 77. | |
| Percent Surrogate Recovery | | | 117. | |

San Jose Lab Certifications: CAELAP #1204

*RESULTS listed as 'ND' were not detected at or above the listed PQL (Practical Quantitation Limit)

- (1) Sample Preparation on 07/22/94 by LB
- (2) EXTRACTED by EPA 5030 (purge-and-trap)

07/26/94
GC#4\725B621
DT/eta3(dw)
S-B-072294

Respectfully submitted,
COAST-TO-COAST ANALYTICAL SERVICES, INC.

Dudley Torres
Organics Manager

Reports shall not be reproduced except in full without the written consent of Coast-to-Coast Analytical Services Inc.



COAST-TO-COAST ANALYTICAL SERVICES, INC.

EXCELLENCE
IN ANALYSIS

NorCal Division (San Jose Laboratory)
2059 Junction Ave.

San Jose, CA 95131
(408) 955-9077

CLIENT: Xinggang Tong
Woodward-Clyde Consultants
500 12th St. Ste. 100
Oakland, CA 94607-4014

Lab Number : JK-2266-7
Project : 941114NA
Analyzed : 07/25/94
Analyzed by: LD
Method : EPA 8020/8015M

REPORT OF ANALYTICAL RESULTS

Page 1 of 1

| SAMPLE DESCRIPTION | MATRIX | SAMPLED BY | SAMPLED | RECEIVED |
|---|----------|---------------|-----------------|----------|
| Composite of S-0-5ft-7-A,B,C,D | Soil | S.P. | 07/22/94 1230 | 07/22/94 |
| CONSTITUENT | (CAS RN) | *PQL mg/Kg | RESULT mg/Kg | NOTE |
| BTEX + TPH (Gasoline) | | | | 1,2 |
| Benzene | | 0.03 | 0.13 | |
| Toluene | | 0.03 | 0.40 | |
| Ethylbenzene | | 0.03 | 0.49 | |
| Xylenes | | 0.03 | 4.5 | |
| Total Petroleum Hydrocarbons (Gasoline) | | 5. | 56. | |
| Percent Surrogate Recovery | | | 119. | |

San Jose Lab Certifications: CAELAP #1204

*RESULTS listed as 'ND' were not detected at or above the listed PQL (Practical Quantitation Limit)

- (1) Sample Preparation on 07/22/94 by LB
- (2) EXTRACTED by EPA 5030 (purge-and-trap)

07/26/94
GC#4\725B622
DT/eta3(dw)
S-B-072294

Respectfully submitted,
COAST-TO-COAST ANALYTICAL SERVICES, INC.

Dudley Torres
Organics Manager

Reports shall not be reproduced except in full without the written consent of Coast-to-Coast Analytical Services Inc.

Air, Water & Hazardous Waste Sampling, Analysis & Consultation - Certified Hazardous Waste, Chemistry, Bacteriology & Bioassay Laboratories



COAST-TO-COAST ANALYTICAL SERVICES, INC.

EXCELLENCE
IN ANALYSIS

NorCal Division (San Jose Laboratory)
2059 Junction Ave.

San Jose, CA 95131
(408) 955-9077

CLIENT: Xinggang Tong
Woodward-Clyde Consultants
500 12th St. Ste. 100
Oakland, CA 94607-4014

Lab Number : JK-2266-8
Project : 941114NA
Analyzed : 07/25/94
Analyzed by: LD
Method : EPA 8020/8015M

REPORT OF ANALYTICAL RESULTS

Page 1 of 1

| SAMPLE DESCRIPTION | MATRIX | SAMPLED BY | SAMPLED | RECEIVED |
|---|----------|---------------|-----------------|----------|
| Composite of S-0-5ft-8-A,B,C,D | Soil | S.P. | 07/22/94 1235 | 07/22/94 |
| CONSTITUENT | (CAS RN) | *PQL mg/Kg | RESULT mg/Kg | NOTE |
| BTEX + TPH (Gasoline) | | | | 1,2,3 |
| Benzene | | 0.03 | 0.05 | |
| Toluene | | 0.03 | 0.16 | |
| Ethylbenzene | | 0.03 | 0.18 | |
| Xylenes | | 0.03 | 3.1 | |
| Total Petroleum Hydrocarbons (Gasoline) | | 5. | 48. | |
| Percent Surrogate Recovery | | | 156. | |

San Jose Lab Certifications: CAELAP #1204

*RESULTS listed as 'ND' were not detected at or above the listed PQL (Practical Quantitation Limit)

- (1) Sample Preparation on 07/22/94 by LB
- (2) EXTRACTED by EPA 5030 (purge-and-trap)
- (3) High surrogate recovery due to hydrocarbon interference.

07/26/94
GC#4\725B618
DT/eta3(dw)
S-B-072294

Respectfully submitted,
COAST-TO-COAST ANALYTICAL SERVICES, INC.

Dudley Torres
Organics Manager

Reports shall not be reproduced except in full without the written consent of Coast-to-Coast Analytical Services Inc.



COAST-TO-COAST ANALYTICAL SERVICES, INC.

EXCELLENCE
IN ANALYSIS

NorCal Division (San Jose Laboratory)
2059 Junction Ave.

San Jose, CA 95131
(408) 955-9077

CLIENT: Xinggang Tong
Woodward-Clyde Consultants
500 12th St. Ste. 100
Oakland, CA 94607-4014

Lab Number : JK-2266-9
Project : 941114NA
Analyzed : 07/25/94
Analyzed by: LD
Method : EPA 8020/8015M

REPORT OF ANALYTICAL RESULTS

Page 1 of 1

| SAMPLE DESCRIPTION | MATRIX | SAMPLED BY | SAMPLED | RECEIVED |
|---|----------|---------------|-----------------|----------|
| Composite of S-0-5ft-9-A,B,C,E | Soil | S.P. | 07/22/94 1310 | 07/22/94 |
| CONSTITUENT | (CAS RN) | *PQL mg/Kg | RESULT mg/Kg | NOTE |
| BTEX + TPH (Gasoline) | | | | 1,2,3 |
| Benzene | | 0.1 | 0.2 | |
| Toluene | | 0.1 | 1.0 | |
| Ethylbenzene | | 0.1 | 0.4 | |
| Xylenes | | 0.1 | 3.2 | |
| Total Petroleum Hydrocarbons (Gasoline) | | 20. | 130. | |

San Jose Lab Certifications: CAELAP #1204

*RESULTS listed as 'ND' were not detected at or above the listed PQL (Practical Quantitation Limit)

- (1) Sample Preparation on 07/22/94 by LB
- (2) EXTRACTED by EPA 5030 (purge-and-trap)
- (3) Surrogate diluted out.

07/26/94
GC#4\725B613
DT/eta3(dw)
S-B-072294

Respectfully submitted,
COAST-TO-COAST ANALYTICAL SERVICES, INC.

Budley Torres
Organics Manager

Reports shall not be reproduced except in full without the written consent of Coast-to-Coast Analytical Services Inc.



COAST-TO-COAST ANALYTICAL SERVICES, INC.

EXCELLENCE
IN ANALYSIS

NorCal Division (San Jose Laboratory)
2059 Junction Ave.

San Jose, CA 95131
(408) 955-9077

CLIENT: Xinggang Tong
Woodward-Clyde Consultants
500 12th St. Ste. 100
Oakland, CA 94607-4014

Lab Number : JK-2266-10
Project : 941114NA
Analyzed : 07/25/94
Analyzed by: LD
Method : EPA 8020/8015M

REPORT OF ANALYTICAL RESULTS

Page 1 of 1

| SAMPLE DESCRIPTION | MATRIX | SAMPLED BY | SAMPLED | RECEIVED |
|---|----------|---------------|-----------------|----------|
| Composite of S-0-5ft-10-A,B,C,D | Soil | S.P. | 07/22/94 1315 | 07/22/94 |
| CONSTITUENT | (CAS RN) | *PQL mg/Kg | RESULT mg/Kg | NOTE |
| BTEX + TPH (Gasoline) | | | | 1,2 |
| Benzene | | 0.05 | ND | |
| Toluene | | 0.05 | ND | |
| Ethylbenzene | | 0.05 | ND | |
| Xylenes | | 0.05 | 0.09 | |
| Total Petroleum Hydrocarbons (Gasoline) | | 10. | 48. | |
| Percent Surrogate Recovery | | | 99. | |

San Jose Lab Certifications: CAELAP #1204

*RESULTS listed as 'ND' were not detected at or above the listed PQL (Practical Quantitation Limit)

- (1) Sample Preparation on 07/22/94 by LB
- (2) EXTRACTED by EPA 5030 (purge-and-trap)

07/26/94
GC#4\725B623
DT/eta3(dw)
S-B-072294

Respectfully submitted,
COAST-TO-COAST ANALYTICAL SERVICES, INC.

Dudley Torres
Organics Manager

Reports shall not be reproduced except in full without the written consent of Coast-to-Coast Analytical Services Inc.



COAST-TO-COAST ANALYTICAL SERVICES, INC.

EXCELLENCE
IN ANALYSIS

NorCal Division (San Jose Laboratory)
2059 Junction Ave.

San Jose, CA 95131
(408) 955-9077

CLIENT: Xinggang Tong
Woodward-Clyde Consultants
500 12th St. Ste. 100
Oakland, CA 94607-4014

Lab Number : JK-2266-11
Project : 941114NA
Analyzed : 07/26/94
Analyzed by: LD
Method : EPA 8020/8015M

REPORT OF ANALYTICAL RESULTS

Page 1 of 1

| SAMPLE DESCRIPTION | MATRIX | SAMPLED BY | SAMPLED | RECEIVED |
|---------------------------------|--------|------------|---------------|----------|
| Composite of S-0-5ft-11-A,B,C,D | Soil | S.P. | 07/22/94 1345 | 07/22/94 |

| CONSTITUENT | (CAS RN) | *PQL mg/Kg | RESULT mg/Kg | NOTE |
|---|----------|---------------|-----------------|------|
| BTEX + TPH (Gasoline) | | | | 1,2 |
| Benzene | | 0.01 | 0.03 | |
| Toluene | | 0.01 | 0.03 | |
| Ethylbenzene | | 0.01 | 0.05 | |
| Xylenes | | 0.01 | 0.19 | |
| Total Petroleum Hydrocarbons (Gasoline) | | 3. | 28. | |
| Percent Surrogate Recovery | | | 109. | |

San Jose Lab Certifications: CAELAP #1204

*RESULTS listed as 'ND' were not detected at or above the listed PQL (Practical Quantitation Limit)

- (1) Sample Preparation on 07/22/94 by LB
- (2) EXTRACTED by EPA 5030 (purge-and-trap)

07/26/94
GC#2\725B323
DT/eta3(dw)
S-B-072294

Respectfully submitted,
COAST-TO-COAST ANALYTICAL SERVICES, INC.

Dudley Torres
Organics Manager

Reports shall not be reproduced except in full without the written consent of Coast-to-Coast Analytical Services Inc.



COAST-TO-COAST ANALYTICAL SERVICES, INC.

EXCELLENCE
IN ANALYSIS

NorCal Division (San Jose Laboratory)
2059 Junction Ave.

San Jose, CA 95131
(408) 955-9077

CLIENT: Xinggang Tong
Woodward-Clyde Consultants
500 12th St. Ste. 100
Oakland, CA 94607-4014

Lab Number : JK-2266-12
Project : 941114NA
Analyzed : 07/26/94
Analyzed by: LD
Method : EPA 8020/8015M

REPORT OF ANALYTICAL RESULTS

Page 1 of 1

| SAMPLE DESCRIPTION | MATRIX | SAMPLED BY | SAMPLED | RECEIVED |
|---|----------|---------------|-----------------|----------|
| Composite of S-0-5ft-12-A,B,C,D | Soil | S.P. | 07/22/94 1355 | 07/22/94 |
| CONSTITUENT | (CAS RN) | *PQL mg/Kg | RESULT mg/Kg | NOTE |
| BTEX + TPH (Gasoline) | | | | 1,2,3 |
| Benzene | | 0.03 | 0.12 | |
| Toluene | | 0.03 | 0.13 | |
| Ethylbenzene | | 0.03 | 0.05 | |
| Xylenes | | 0.03 | 0.78 | |
| Total Petroleum Hydrocarbons (Gasoline) | | 5. | 49. | |
| Percent Surrogate Recovery | | | 165. | |

San Jose Lab Certifications: CAELAP #1204

*RESULTS listed as 'ND' were not detected at or above the listed PQL (Practical Quantitation Limit)

- (1) Sample Preparation on 07/22/94 by LB
- (2) EXTRACTED by EPA 5030 (purge-and-trap)
- (3) High surrogate recovery due to hydrocarbon interference.

07/26/94
GC#2\725B322
DT/eta3(dw)
S-B-072294

Respectfully submitted,
COAST-TO-COAST ANALYTICAL SERVICES, INC.

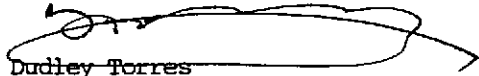
Dudley Torres
Organics Manager

Reports shall not be reproduced except in full without the written consent of Coast-to-Coast Analytical Services Inc.



COAST-TO-COAST ANALYTICAL SERVICES, INC.

EXCELLENCE
IN ANALYSIS

NorCal Division (San Jose Laboratory)
2059 Junction Ave.

San Jose, CA 95131
(408) 955-9077

CLIENT: Xinggang Tong
Woodward-Clyde Consultants
500 12th St. Ste. 100
Oakland, CA 94607-4014

Lab Number : JK-2266-13
Project : 941114NA
Analyzed : 07/26/94
Analyzed by: LD
Method : EPA 8020/8015M

REPORT OF ANALYTICAL RESULTS

Page 1 of 1

| SAMPLE DESCRIPTION | MATRIX | SAMPLED BY | SAMPLED | RECEIVED |
|---|----------|---------------|-----------------|----------|
| Composite of S-0-5ft-13-A,B,C,D | Soil | S.P. | 07/22/94 1421 | 07/22/94 |
| CONSTITUENT | (CAS RN) | *PQL mg/Kg | RESULT mg/Kg | NOTE |
| BTEX + TPH (Gasoline) | | | | 1,2 |
| Benzene | | 0.01 | 0.05 | |
| Toluene | | 0.01 | 0.04 | |
| Ethylbenzene | | 0.01 | 0.02 | |
| Xylenes | | 0.01 | 0.12 | |
| Total Petroleum Hydrocarbons (Gasoline) | | 2. | 27. | |
| Percent Surrogate Recovery | | | 101. | |

San Jose Lab Certifications: CAELAP #1204

*RESULTS listed as 'ND' were not detected at or above the listed PQL (Practical Quantitation Limit)

- (1) Sample Preparation on 07/22/94 by LB
- (2) EXTRACTED by EPA 5030 (purge-and-trap)

07/26/94
GC#2\725B321
DT/eta3(dw)
S-B-072294

Respectfully submitted,
COAST-TO-COAST ANALYTICAL SERVICES, INC.

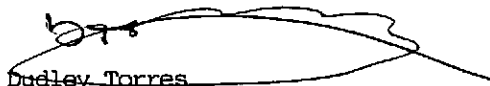
Dudley Torres
Organics Manager

Reports shall not be reproduced except in full without the written consent of Coast-to-Coast Analytical Services Inc.



COAST-TO-COAST ANALYTICAL SERVICES, INC.

EXCELLENCE
IN ANALYSIS

NorCal Division (San Jose Laboratory)
2059 Junction Ave.

San Jose, CA 95131
(408) 955-9077

CLIENT: Xinggang Tong
Woodward-Clyde Consultants
500 12th St. Ste. 100
Oakland, CA 94607-4014

Lab Number : JK-2266-14
Project : 941114NA
Analyzed : 07/26/94
Analyzed by: LD
Method : EPA 8020/8015M

REPORT OF ANALYTICAL RESULTS

Page 1 of 1

| SAMPLE DESCRIPTION | MATRIX | SAMPLED BY | SAMPLED | RECEIVED |
|---------------------------------|--------|------------|---------------|----------|
| Composite of S-0-5ft-14-A,B,C,D | Soil | S.P. | 07/22/94 1422 | 07/22/94 |

| CONSTITUENT | (CAS RN) | *PQL mg/Kg | RESULT mg/Kg | NOTE |
|---|----------|---------------|-----------------|-------|
| BTEX + TPH (Gasoline) | | | | 1,2,3 |
| Benzene | | 0.01 | 0.14 | |
| Toluene | | 0.01 | 0.14 | |
| Ethylbenzene | | 0.01 | 0.10 | |
| Xylenes | | 0.01 | 0.29 | |
| Total Petroleum Hydrocarbons (Gasoline) | | 3. | 42. | |
| Percent Surrogate Recovery | | | 225. | |

San Jose Lab Certifications: CAELAP #1204

*RESULTS listed as 'ND' were not detected at or above the listed PQL (Practical Quantitation Limit)

- (1) Sample Preparation on 07/22/94 by LB
- (2) EXTRACTED by EPA 5030 (purge-and-trap)
- (3) High surrogate recovery due to hydrocarbon interference.

07/26/94
GC#2\725B318
DT/eta3(dw)
S-B-072294

Respectfully submitted,
COAST-TO-COAST ANALYTICAL SERVICES, INC.

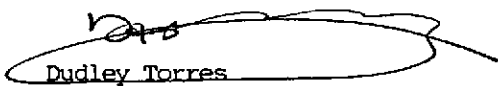
Dudley Torres
Organics Manager

Reports shall not be reproduced except in full without the written consent of Coast-to-Coast Analytical Services Inc.



COAST-TO-COAST ANALYTICAL SERVICES, INC.

EXCELLENCE
IN ANALYSIS

NorCal Division (San Jose Laboratory)
2059 Junction Ave.

San Jose, CA 95131
(408) 955-9077

CLIENT: Xinggang Tong
Woodward-Clyde Consultants
500 12th St. Ste. 100
Oakland, CA 94607-4014

Lab Number : JK-2266-15
Project : 941114NA
Analyzed : 07/26/94
Analyzed by: LD
Method : EPA 8020/8015M

REPORT OF ANALYTICAL RESULTS

Page 1 of 1

| SAMPLE DESCRIPTION | MATRIX | SAMPLED BY | SAMPLED | RECEIVED |
|---|----------|---------------|-----------------|----------|
| Composite of S-0-5ft-15-A,B,C,D | Soil | S.P. | 07/22/94 1436 | 07/22/94 |
| CONSTITUENT | (CAS RN) | *PQL mg/Kg | RESULT mg/Kg | NOTE |
| BTEX + TPH (Gasoline) | | | | 1,2 |
| Benzene | | 0.01 | 0.04 | |
| Toluene | | 0.01 | 0.07 | |
| Ethylbenzene | | 0.01 | 0.10 | |
| Xylenes | | 0.01 | 0.59 | |
| Total Petroleum Hydrocarbons (Gasoline) | | 3. | 24. | |
| Percent Surrogate Recovery | | | 109. | |

San Jose Lab Certifications: CAELAP #1204

*RESULTS listed as 'ND' were not detected at or above the listed PQL (Practical Quantitation Limit)

- (1) Sample Preparation on 07/22/94 by LB
- (2) EXTRACTED by EPA 5030 (purge-and-trap)

07/26/94
GC#2\725B319
DT/eta3(dw)
S-B-072294

Respectfully submitted,
COAST-TO-COAST ANALYTICAL SERVICES, INC.

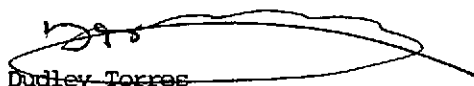
Dudley Torres
Organics Manager

Reports shall not be reproduced except in full without the written consent of Coast-to-Coast Analytical Services Inc.



COAST-TO-COAST ANALYTICAL SERVICES, INC.

EXCELLENCE
IN ANALYSIS

NorCal Division (San Jose Laboratory)
2059 Junction Ave.

San Jose, CA 95131
(408) 955-9077

CLIENT: Xinggang Tong
Woodward-Clyde Consultants
500 12th St. Ste. 100
Oakland, CA 94607-4014

Lab Number : JK-2266-16
Project : 941114NA
Analyzed : 07/26/94
Analyzed by: LD
Method : EPA 8020/8015M

REPORT OF ANALYTICAL RESULTS

Page 1 of 1

| SAMPLE DESCRIPTION | MATRIX | SAMPLED BY | SAMPLED | RECEIVED |
|---------------------------------|--------|------------|---------------|----------|
| Composite of S-0-5ft-16-A,B,C,D | Soil | S.P. | 07/22/94 1438 | 07/22/94 |

| CONSTITUENT | (CAS RN) | *PQL mg/Kg | RESULT mg/Kg | NOTE |
|---|----------|---------------|-----------------|-------|
| BTEX + TPH (Gasoline) | | | | 1,2,3 |
| Benzene | | 0.1 | ND | |
| Toluene | | 0.1 | 0.6 | |
| Ethylbenzene | | 0.1 | 0.8 | |
| Xylenes | | 0.1 | 6.1 | |
| Total Petroleum Hydrocarbons (Gasoline) | | 20. | 73. | |
| Percent Surrogate Recovery | | | 235. | |

San Jose Lab Certifications: CAELAP #1204

*RESULTS listed as 'ND' were not detected at or above the listed PQL (Practical Quantitation Limit)

- (1) Sample Preparation on 07/22/94 by LB
- (2) EXTRACTED by EPA 5030 (purge-and-trap)
- (3) High surrogate recovery due to hydrocarbon interference.

07/26/94
GC#2\725B308
DT/eta3(dw)
S-B-072294

Respectfully submitted,
COAST-TO-COAST ANALYTICAL SERVICES, INC.

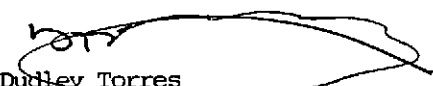
Dudley Torres
Organics Manager

Reports shall not be reproduced except in full without the written consent of Coast-to-Coast Analytical Services Inc.



COAST-TO-COAST ANALYTICAL SERVICES, INC.

EXCELLENCE
IN ANALYSIS

NorCal Division (San Jose Laboratory)
2059 Junction Ave.

San Jose, CA 95131
(408) 955-9077

CLIENT: Xinggang Tong
Woodward-Clyde Consultants
500 12th St. Ste. 100
Oakland, CA 94607-4014

Lab Number : JK-2266-17
Project : 941114NA
Analyzed : 07/26/94
Analyzed by: DT
Method : EPA 8020/8015M

REPORT OF ANALYTICAL RESULTS

Page 1 of 1

| SAMPLE DESCRIPTION | MATRIX | SAMPLED BY | SAMPLED | RECEIVED |
|---|----------|---------------|-----------------|-----------|
| Composite if S-0-5ft-17-A,B,C,D | Soil | S.P. | 07/22/94 1452 | 07/22/94. |
| CONSTITUENT | (CAS RN) | *PQL mg/Kg | RESULT mg/Kg | NOTE |
| BTEX + TPH (Gasoline) | | | | 1,2 |
| Benzene | | 0.01 | 0.05 | |
| Toluene | | 0.01 | 0.22 | |
| Ethylbenzene | | 0.01 | 0.22 | |
| Xylenes | | 0.01 | 1.7 | |
| Total Petroleum Hydrocarbons (Gasoline) | | 3. | 20. | |
| Percent Surrogate Recovery | | | 99. | |

San Jose Lab Certifications: CAELAP #1204

*RESULTS listed as 'ND' were not detected at or above the listed PQL (Practical Quantitation Limit)

- (1) Sample Preparation on 07/22/94 by LB
- (2) EXTRACTED by EPA 5030 (purge-and-trap)

07/26/94
GC#2\725B320
DT/eta3(dw)
S-B-072294

Respectfully submitted,
COAST-TO-COAST ANALYTICAL SERVICES, INC.

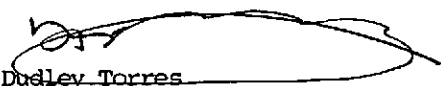
Dudley Torres
Organics Manager

Reports shall not be reproduced except in full without the written consent of Coast-to-Coast Analytical Services Inc.



COAST-TO-COAST ANALYTICAL SERVICES, INC.

EXCELLENCE
IN ANALYSIS

NorCal Division (San Jose Laboratory)
2059 Junction Ave.

San Jose, CA 95131
(408) 955-9077

CLIENT: Xinggang Tong
Woodward-Clyde Consultants
500 12th St. Ste. 100
Oakland, CA 94607-4014

Lab Number : JK-2266-18
Project : 941114NA
Analyzed : 07/25/94
Analyzed by: LD
Method : EPA 8020/8015M

REPORT OF ANALYTICAL RESULTS

Page 1 of 1

| SAMPLE DESCRIPTION | MATRIX | SAMPLED BY | SAMPLED | RECEIVED |
|---|----------|---------------|-----------------|----------|
| Composite of S-0-5ft-18-A,B,C,D | Soil | S.P. | 07/22/94 1454 | 07/22/94 |
| CONSTITUENT | (CAS RN) | *PQL mg/Kg | RESULT mg/Kg | NOTE |
| BTEX + TPH (Gasoline) | | | | 1,2 |
| Benzene | | 0.005 | 0.019 | |
| Toluene | | 0.005 | 0.064 | |
| Ethylbenzene | | 0.005 | 0.096 | |
| Xylenes | | 0.005 | 0.80 | |
| Total Petroleum Hydrocarbons (Gasoline) | | 1. | 12. | |
| Percent Surrogate Recovery | | | 90. | |

San Jose Lab Certifications: CAELAP #1204

*RESULTS listed as 'ND' were not detected at or above the listed PQL (Practical Quantitation Limit)

- (1) Sample Preparation on 07/22/94 by LB
- (2) EXTRACTED by EPA 5030 (purge-and-trap)

07/26/94
GC#2\725B306
DT/eta3(dw)
S-B-072294

Respectfully submitted,
COAST-TO-COAST ANALYTICAL SERVICES, INC.

Dudley Torres
Organics Manager

Reports shall not be reproduced except in full without the written consent of Coast-to-Coast Analytical Services Inc.



EXCELLENCE
IN ANALYSIS

COAST-TO-COAST ANALYTICAL SERVICES, INC.

NorCal Division (San Jose Laboratory)
2059 Junction Ave.

San Jose, CA 95131
(408) 955-9077

CLIENT: Xinggang Tong
Woodward-Clyde Consultants
500 12th St. Ste. 100
Oakland, CA 94607-4014

Lab Number : JK-2266-21
Project : 941114NA
Analyzed : 07/25/94
Analyzed by: LD
Method : EPA 8020/8015M

REPORT OF ANALYTICAL RESULTS

Page 1 of 1

| SAMPLE DESCRIPTION | MATRIX | SAMPLED BY | SAMPLED | RECEIVED |
|---|----------|---------------|-----------------|----------|
| S-G-A, B, C, D | Soil | S.P. | 07/22/94 1555 | 07/22/94 |
| CONSTITUENT | (CAS RN) | *PQL mg/Kg | RESULT mg/Kg | NOTE |
| BTEX + TPH (Gasoline) | | | | 1,2,3 |
| Benzene | | 0.1 | 0.1 | |
| Toluene | | 0.1 | 1.1 | |
| Ethylbenzene | | 0.1 | 1.0 | |
| Xylenes | | 0.1 | 6.0 | |
| Total Petroleum Hydrocarbons (Gasoline) | | 20. | 52. | |
| Percent Surrogate Recovery | | | 240. | |

San Jose Lab Certifications: CAELAP #1204

*RESULTS listed as 'ND' were not detected at or above the listed PQL (Practical Quantitation Limit)

- (1) Sample Preparation on 07/22/94 by LB
- (2) EXTRACTED by EPA 5030 (purge-and-trap)
- (3) High surrogate recovery due to hydrocarbon interference.

07/26/94
GC#2\725B305
DT/eta3(dw)
S-B-072294

Respectfully submitted,
COAST-TO-COAST ANALYTICAL SERVICES, INC.

Dudley Torres
Organics Manager

Reports shall not be reproduced except in full without the written consent of Coast-to-Coast Analytical Services Inc.



COAST-TO-COAST ANALYTICAL SERVICES, INC.

EXCELLENCE
IN ANALYSIS

NorCal Division (San Jose Laboratory)
2059 Junction Ave.

San Jose, CA 95131
(408) 955-9077

QC Batch ID: S-B-072294

CLIENT: Coast-to-Coast Analytical Services, Inc.

Analyzed : 07/22/94
Analyzed by: LD
Method : EPA 8020/8015M

METHOD BLANK
REPORT OF ANALYTICAL RESULTS

Page 1 of 1

| SAMPLE DESCRIPTION | MATRIX | SAMPLED BY | SAMPLED DATE RECEIVED | | |
|---|----------|---------------|-----------------------|------|--|
| METHOD BLANK | Solid | | | | |
| CONSTITUENT | (CAS RN) | *PQL mg/Kg | RESULT mg/Kg | NOTE | |
| BTEX + TPH (Gasoline) | | | | 1,2 | |
| Benzene | | 0.005 | ND | | |
| Toluene | | 0.005 | ND | | |
| Ethylbenzene | | 0.005 | ND | | |
| Xylenes | | 0.005 | ND | | |
| Total Petroleum Hydrocarbons (Gasoline) | | 1. | ND | | |
| Percent Surrogate Recovery | | | 95. | | |

San Jose Lab Certifications: CAELAP #1204

*RESULTS listed as 'ND' were not detected at or above the listed PQL (Practical Quantitation Limit)

- (1) Sample Preparation on 07/22/94 by LB
- (2) EXTRACTED by EPA 5030 (purge-and-trap)

07/26/94
GC#2\722A610
DT/eta3(dw)
JK2266-18

Respectfully submitted,
COAST-TO-COAST ANALYTICAL SERVICES, INC.

Dudley Torres
Organics Manager

Reports shall not be reproduced except in full without the written consent of Coast-to-Coast Analytical Services Inc.



COAST-TO-COAST ANALYTICAL SERVICES, INC.

EXCELLENCE
IN ANALYSIS

NorCal Division (San Jose Laboratory)
2059 Junction Ave.

San Jose, CA 95131
(408) 955-9077

QC Batch ID: S-B-072294

CLIENT: Coast-to-Coast Analytical Services, Inc.

Analyzed : 07/22/94
Analyzed by: LD
Method : EPA 8020/8015M

QC SPIKE REPORT OF ANALYTICAL RESULTS

Page 1 of 1

| SAMPLE DESCRIPTION | MATRIX | SAMPLED BY | SAMPLED DATE RECEIVED | | | |
|---|--------|---------------|-----------------------|-----------------|------|------|
| QC SPIKE | Solid | | | | | |
| CONSTITUENT | | *PQL mg/Kg | SPIKE AMOUNT | RESULT mg/Kg | %REC | NOTE |
| BTEX + TPH (Gasoline) | | | | | | 1,2 |
| Benzene | | 0.005 | 0.10 | 0.11 | 110. | |
| Toluene | | 0.005 | 0.10 | 0.11 | 110. | |
| Ethylbenzene | | 0.005 | 0.10 | 0.11 | 110. | |
| Xylenes | | 0.005 | 0.30 | 0.32 | 107. | |
| Total Petroleum Hydrocarbons (Gasoline) | | 1. | 2.5 | 2.8 | 112. | |

San Jose Lab Certifications: CAELAP #1204

*RESULTS listed as 'ND' were not detected at or above the listed PQL (Practical Quantitation Limit)

- (1) Sample Preparation on 07/22/94 by LB
- (2) EXTRACTED by EPA 5030 (purge-and-trap)

07/26/94
GC#2\722B611
DT/eta3(dw)
JK2266-18

Respectfully submitted,
COAST-TO-COAST ANALYTICAL SERVICES, INC.

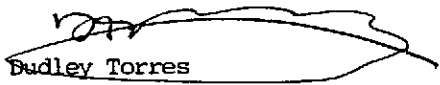
Budley Torres
Organics Manager

Reports shall not be reproduced except in full without the written consent of Coast-to-Coast Analytical Services Inc.



COAST-TO-COAST ANALYTICAL SERVICES, INC.

EXCELLENCE
IN ANALYSIS

NorCal Division (San Jose Laboratory)
2059 Junction Ave.

San Jose, CA 95131
(408) 955-9077

QC Batch ID: S-B-072294

CLIENT: Coast-to-Coast Analytical Services, Inc.

Analyzed : 07/22/94
Analyzed by: LD
Method : EPA 8020/8015M

QC SPIKE
REPORT OF ANALYTICAL RESULTS

Page 1 of 1

| SAMPLE DESCRIPTION | MATRIX | SAMPLED BY | | SAMPLED DATE RECEIVED | | |
|---|---------------|-----------------|-----------------|-----------------------|-------|------|
| QC SPIKE DUPLICATE | Solid | | | | | |
| CONSTITUENT | *PQL mg/Kg | SPIKE AMOUNT | RESULT mg/Kg | %REC | %DIFF | NOTE |
| BTEX + TPH (Gasoline) | | | | | | 1,2 |
| Benzene | 0.005 | 0.10 | 0.11 | 110. | 0. | |
| Toluene | 0.005 | 0.10 | 0.11 | 110. | 0. | |
| Ethylbenzene | 0.005 | 0.10 | 0.10 | 100. | 9.5 | |
| Xylenes | 0.005 | 0.30 | 0.33 | 110. | 3.1 | |
| Total Petroleum Hydrocarbons (Gasoline) | 1. | 2.5 | 2.8 | 112. | 0. | |

San Jose Lab Certifications: CAELAP #1204

*RESULTS listed as 'ND' were not detected at or above the listed PQL (Practical Quantitation Limit)

- (1) Sample Preparation on 07/22/94 by LB
- (2) EXTRACTED by EPA 5030 (purge-and-trap)

07/26/94
GC#2\722B312
DT/eta3(dw)
JK2266-18

Respectfully submitted,
COAST-TO-COAST ANALYTICAL SERVICES, INC.

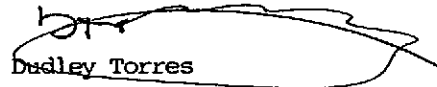
Dudley Torres
Organics Manager

Reports shall not be reproduced except in full without the written consent of Coast-to-Coast Analytical Services Inc.



COAST-TO-COAST ANALYTICAL SERVICES, INC.

EXCELLENCE
IN ANALYSIS

NorCal Division (San Jose Laboratory)
2059 Junction Ave.

San Jose, CA 95131
(408) 955-9077

CLIENT: Xinggang Tong
Woodward-Clyde Consultants
500 12th St. Ste. 100
Oakland, CA 94607-4014

Lab Number : JK-2266-19
Project : 941114NA
Analyzed : 07/26/94
Analyzed by: TN
Method : EPA 8015M

REPORT OF ANALYTICAL RESULTS

Page 1 of 1

| SAMPLE DESCRIPTION | MATRIX | SAMPLED BY | SAMPLED | RECEIVED |
|--------------------------|--------|------------|---------------|----------|
| Composite of S-D-A,B,C,D | Soil | S.P. | 07/22/94 1515 | 07/22/94 |

| CONSTITUENT | (CAS RN) | *PQL mg/Kg | RESULT mg/Kg | NOTE |
|--|----------|---------------|-----------------|------|
| TOTAL EXTRACTABLE PETROLEUM HYDROCARBON | | | | 1 |
| Total Extractable Petroleum Hydrocarbon (Diesel) | | 100. | 3100. | |

San Jose Lab Certifications: CAELAP #1204

*RESULTS listed as 'ND' were not detected at or above the listed PQL (Practical Quantitation Limit)
(1) Sample Preparation on 07/26/94 by LN using EPA 3550

07/26/94
ECD2-726C009
DT/mcca3(dw)/cal
DSL072694

Respectfully submitted,
COAST-TO-COAST ANALYTICAL SERVICES, INC.

Dudley Torres
Organics Manager

Reports shall not be reproduced except in full without the written consent of Coast-to-Coast Analytical Services Inc.



EXCELLENCE
IN ANALYSIS

COAST-TO-COAST ANALYTICAL SERVICES, INC.

NorCal Division (San Jose Laboratory)
2059 Junction Ave.

San Jose, CA 95131
(408) 955-9077

QC Batch ID: DSL072694

CLIENT: Coast-to-Coast Analytical Services, Inc.

Analyzed : 07/26/94
Analyzed by: TN
Method : EPA 8015M

METHOD BLANK
REPORT OF ANALYTICAL RESULTS

Page 1 of 1

| SAMPLE DESCRIPTION | MATRIX | SAMPLED BY | SAMPLED DATE RECEIVED | | |
|--|----------|---------------|-----------------------|------|--|
| METHOD BLANK | Solid | | | | |
| CONSTITUENT | (CAS RN) | *PQL mg/Kg | RESULT mg/Kg | NOTE | |
| TOTAL EXTRACTABLE PETROLEUM HYDROCARBON | | | | 1 | |
| Total Extractable Petroleum Hydrocarbon (Diesel) | | 1. | ND | | |

San Jose Lab Certifications: CAELAP #1204

*RESULTS listed as 'ND' were not detected at or above the listed PQL (Practical Quantitation Limit)

(1) Sample Preparation on 07/26/94 by LN using EPA 3550

07/26/94
ECD2-726C010
DT/eta3(dw)/cal
JK2266-19

Respectfully submitted,
COAST-TO-COAST ANALYTICAL SERVICES, INC.

Dudley Torres
Organics Manager

Reports shall not be reproduced except in full without the written consent of Coast-to-Coast Analytical Services Inc.



COAST-TO-COAST ANALYTICAL SERVICES, INC.

EXCELLENCE
IN ANALYSIS

NorCal Division (San Jose Laboratory)
2059 Junction Ave.

San Jose, CA 95131
(408) 955-9077

QC Batch ID: DSL072694

CLIENT: Coast-to-Coast Analytical Services, Inc.

Analyzed : 07/26/94
Analyzed by: TN
Method : EPA 8015M

QC SPIKE REPORT OF ANALYTICAL RESULTS

Page 1 of 1

| SAMPLE DESCRIPTION | MATRIX | SAMPLED BY | SAMPLED DATE RECEIVED | | |
|--|---------------|-----------------|-----------------------|------|------|
| QC SPIKE | Solid | | | | |
| CONSTITUENT | *PQL mg/Kg | SPIKE AMOUNT | RESULT mg/Kg | %REC | NOTE |
| TOTAL EXTRACTABLE PETROLEUM HYDROCARBON | | | | | 1 |
| Total Extractable Petroleum Hydrocarbon (Diesel) | 1. | 22. | 7. | 32. | |

San Jose Lab Certifications: CAELAP #1204

*RESULTS listed as 'ND' were not detected at or above the listed PQL (Practical Quantitation Limit)

(1) Sample Preparation on 07/26/94 by LN using EPA 3550

07/26/94
ECD2-726C011
DT/eta3(dw)/cal/ttn
JK2266-19

Respectfully submitted,
COAST-TO-COAST ANALYTICAL SERVICES, INC.

Dudley Torres
Organics Manager

Reports shall not be reproduced except in full without the written consent of Coast-to-Coast Analytical Services Inc.



COAST-TO-COAST ANALYTICAL SERVICES, INC.

EXCELLENCE
IN ANALYSIS

NorCal Division (San Jose Laboratory)
2059 Junction Ave.

San Jose, CA 95131
(408) 955-9077

QC Batch ID: DSL072694

CLIENT: Coast-to-Coast Analytical Services, Inc.

Analyzed : 07/26/94
Analyzed by: TN
Method : EPA 8015M

QC SPIKE REPORT OF ANALYTICAL RESULTS

Page 1 of 1

| SAMPLE DESCRIPTION | MATRIX | SAMPLED BY | | SAMPLED DATE RECEIVED | | |
|---|---------------|-----------------|-----------------|-----------------------|-------|------|
| QC SPIKE DUPLICATE | Solid | | | | | |
| CONSTITUENT | *PQL mg/Kg | SPIKE AMOUNT | RESULT mg/Kg | %REC | %DIFF | NOTE |
| TOTAL EXTRACTABLE PETROLEUM HYDROCARBON | | | | | | 1 |
| Total Extractable Petroleum Hydrocarbon (Diesel) | 1. | 22. | 15. | 68. | 73. | |

San Jose Lab Certifications: CAELAP #1204

*RESULTS listed as 'ND' were not detected at or above the listed PQL (Practical Quantitation Limit)

(1) Sample Preparation on 07/26/94 by LN using EPA 3550

07/26/94
ECD2-726C012
DT/eta3(dw)/cal/ttn
JK2266-19

Respectfully submitted,
COAST-TO-COAST ANALYTICAL SERVICES, INC.

Dudley Torres
Organics Manager

Reports shall not be reproduced except in full without the written consent of Coast-to-Coast Analytical Services Inc.



COAST-TO-COAST ANALYTICAL SERVICES, INC.

EXCELLENCE
IN ANALYSIS

NorCal Division (San Jose Laboratory)
2059 Junction Ave.

San Jose, CA 95131
(408) 955-9077

CLIENT: Kinggang Tong
Woodward-Clyde Consultants
500 12th St. Ste. 100
Oakland, CA 94607-4014

Lab Number : JK-2266-20
Project : 941114NA

REPORT OF ANALYTICAL RESULTS

Page 1 of 1

| SAMPLE DESCRIPTION | MATRIX | SAMPLED BY | SAMPLED | RECEIVED | | | |
|----------------------------|--------|------------|---------------|-----------|----------|----|-------|
| Composite of S-O&G-A,B,C,D | Soil | S.P. | 07/22/94 1535 | 07/22/94 | | | |
| CONSTITUENT | *PQL | RESULT | UNITS | METHOD | ANALYZED | BY | NOTES |
| Oil and Grease, Non-Polar | 50. | ND | mg/Kg | SM5520D&F | 07/25/94 | MT | |

San Jose Lab Certifications: CAELAP #1204

*RESULTS listed as 'ND' were not detected at or above the listed PQL (Practical Quantitation Limit)

08/04/94

NG/saba3(dw)/mcc/mt
SOXOG940627A

Respectfully submitted,
COAST-TO-COAST ANALYTICAL SERVICES, INC.

Nick Gaone
Inorganics Manager

Reports shall not be reproduced except in full without the written consent of Coast-to-Coast Analytical Services Inc.



COAST-TO-COAST ANALYTICAL SERVICES, INC.

EXCELLENCE
IN ANALYSIS

NorCal Division (San Jose Laboratory)
2059 Junction Ave.

San Jose, CA 95131
(408) 955-9077

QC Batch ID: SOXOG940627A

CLIENT: Coast-to-Coast Analytical Services, Inc.

METHOD BLANK
REPORT OF ANALYTICAL RESULTS

Page 1 of 1

| SAMPLE DESCRIPTION | MATRIX | SAMPLED BY | SAMPLED DATE RECEIVED |
|---------------------------|--------|------------|-------------------------------|
| METHOD BLANK | Solid | | |
| CONSTITUENT | *PQL | RESULT | UNITS METHOD ANALYZED BY NOTE |
| Oil and Grease, Non-Polar | 50. | ND | mg/Kg SM5520D&F 07/25/94 MT |

San Jose Lab Certifications: CAELAP #1204

*RESULTS listed as 'ND' were not detected at or above the listed PQL (Practical Quantitation Limit)

08/04/94

NG/saba3(dw)/mcc/mt/nfg
JK2266-20

Respectfully submitted,
COAST-TO-COAST ANALYTICAL SERVICES, INC.

Nick Gaone
Inorganics Manager

Reports shall not be reproduced except in full without the written consent of Coast-to-Coast Analytical Services Inc.



COAST-TO-COAST ANALYTICAL SERVICES, INC.

EXCELLENCE
IN ANALYSIS

NorCal Division (San Jose Laboratory)
2059 Junction Ave.

San Jose, CA 95131
(408) 955-9077

QC Batch ID: SOXOG940627A

CLIENT: Coast-to-Coast Analytical Services, Inc.

QC SPIKE REPORT OF ANALYTICAL RESULTS

Page 1 of 1

| SAMPLE DESCRIPTION | MATRIX | SAMPLED BY | SAMPLED DATE RECEIVED | | | | | | |
|---------------------------|--------|------------|-----------------------|------|-------|-----------|----------|----|------|
| QC SPIKE | Solid | | | | | | | | |
| CONSTITUENT | *PQL | SPIKE | RESULT | %REC | UNITS | METHOD | ANALYZED | BY | NOTE |
| Oil and Grease, Non-Polar | 50. | 1100. | 910. | 83. | mg/Kg | SM5520D&F | 06/27/94 | MI | |

San Jose Lab Certifications: CAELAP #1204

*RESULTS listed as 'ND' were not detected at or above the listed PQL (Practical Quantitation Limit)

08/04/94

NG
JK1986-3

Respectfully submitted,
COAST-TO-COAST ANALYTICAL SERVICES, INC.

Nick Gaone
Inorganics Manager

Reports shall not be reproduced except in full without the written consent of Coast-to-Coast Analytical Services Inc.

Air, Water & Hazardous Waste Sampling, Analysis & Consultation • Certified Hazardous Waste, Chemistry, Bacteriology & Bioassay Laboratories



COAST-TO-COAST ANALYTICAL SERVICES, INC.

EXCELLENCE
IN ANALYSIS

NorCal Division (San Jose Laboratory)
2059 Junction Ave.

San Jose, CA 95131
(408) 955-9077

QC Batch ID: SOXOG940627A

CLIENT: Coast-to-Coast Analytical Services, Inc.

QC SPIKE REPORT OF ANALYTICAL RESULTS

Page 1 of 1

| SAMPLE DESCRIPTION | MATRIX | SAMPLED BY | SAMPLED DATE RECEIVED | | | | | | |
|---------------------------|--------|------------|-----------------------|-------|-----------|-----------|----------|----|------|
| QC SPIKE DUPLICATE | Solid | | | | | | | | |
| CONSTITUENT | *PQL | SPIKE | RESULT | %DIFF | UNITS | METHOD | ANALYZED | BY | NOTE |
| Oil and Grease, Non-Polar | 50. | 1000. | 810. | | 2.1 mg/Kg | SM5520D&F | 06/27/94 | MT | |

San Jose Lab Certifications: CAELAP #1204

*RESULTS listed as 'ND' were not detected at or above the listed PQL (Practical Quantitation Limit)

08/04/94

NG
JK1986-3

Respectfully submitted,
COAST-TO-COAST ANALYTICAL SERVICES, INC.

Nick Gaone
Inorganics Manager

Reports shall not be reproduced except in full without the written consent of Coast-to-Coast Analytical Services Inc.

Woodward-Clyde Consultants

500 12th Street, Suite 100, Oakland, CA 94607-4014
(510) 893-3600

Chain of Custody Record

PROJECT NO.

941114NA

SAMPLERS: (Signature)

[Signature]

ANALYSES

Sample Matrix
(Soil, Water, Air)

EPA Method
EPA Method
EPA Method
EPA Method
AK2266
TPHgas, BTEX

Number of Containers

REMARKS

(Sample preservation, handling procedures, etc.)

Page 1 of 4

| DATE | TIME | SAMPLE NUMBER | Sample Matrix (Soil, Water, Air) | EPA Method | EPA Method | EPA Method | EPA Method | Number of Containers | REMARKS |
|---------|------|---------------|----------------------------------|----------------------|------------|------------|------------|----------------------|--|
| 7/27/94 | 0950 | S-0-5ft-1-A | Soil | | | | | 1 | 48 hour Turnaround |
| | 0955 | S-0-5ft-1-B | " | Composite to one - 1 | | | | 1 | |
| | 1000 | S-0-5ft-1-C | " | | | | | 1 | |
| | 1005 | S-0-5ft-1-D | " | | | | | 1 | |
| 7/27/94 | 1025 | S-0-5ft-2-A | " | | | | | 1 | Questions/Results Xinggang Tong @ 510/874-3060 |
| | 1030 | S-0-5ft-2-B | " | Composite to one - 2 | | | | 1 | |
| | 1035 | S-0-5ft-2-C | " | | | | | 1 | |
| | 1040 | S-0-5ft-2-D | " | | | | | 1 | |
| 7/27/94 | 1100 | S-0-5ft-3-A | " | | | | | 1 | |
| | 1055 | S-0-5ft-3-B | " | Composite to one - 3 | | | | 1 | |
| | 1050 | S-0-5ft-3-C | " | | | | | 1 | |
| | 1045 | S-0-5ft-3-D | " | | | | | 1 | |
| 7/27/94 | 1105 | S-0-5ft-4-A | " | | | | | 1 | |
| | 1110 | S-0-5ft-4-B | " | Composite to one - 4 | | | | 1 | |
| | 1115 | S-0-5ft-4-C | " | | | | | 1 | |
| | 1120 | S-0-5ft-4-D | " | | | | | 1 | |
| 7/27/94 | 1140 | S-0-5ft-5-A | " | | | | | 1 | |
| | 1135 | S-0-5ft-5-B | " | Composite to one - 5 | | | | 1 | |
| | 1130 | S-0-5ft-5-C | " | | | | | 1 | |
| | 1125 | S-0-5ft-5-D | " | | | | | 1 | |
| 7/27/94 | 1145 | S-0-5ft-6-A | " | | | | | 1 | |
| | 1150 | S-0-5ft-6-B | " | Composite to one - 6 | | | | 1 | |
| | 1155 | S-0-5ft-6-C | " | | | | | 1 | |
| | 1200 | S-0-5ft-6-D | " | | | | | 1 | |

TOTAL NUMBER OF CONTAINERS

24

RELINQUISHED BY: (Signature)

[Signature]

DATE/TIME

7/27/94/1600

RECEIVED BY: (Signature)

[Signature]

RELINQUISHED BY: (Signature)

DATE/TIME

RECEIVED BY: (Signature)

METHOD OF SHIPMENT:

Lab Courier

SHIPPED BY: (Signature)

COURIER: (Signature)

World Courier

RECEIVED FOR LAB BY: (Signature)

S.A. Sletth

DATE/TIME

07/27/94 5:57 PM

Cover is sealed & intact
Temp. in cooler is 4°C

Woodward-Clyde Consultants

500 12th Street, Suite 100, Oakland, CA 94607-4014
(510) 893-3600

Chain of Custody Record

| PROJECT NO. 941114 NA | | | ANALYSES | | | | | | | | Number of Containers | REMARKS (Sample preservation, handling procedures, etc.) |
|--|------|---------------|-------------------------------------|---------------------|------------|------------|------------|--------|----------------------------|----|--|---|
| SAMPLERS (Signature) <i>Xinggang Tong</i> | | | Sample Matrix (Soil, Water, Air) | EPA Method | EPA Method | EPA Method | EPA Method | 4x2226 | TPH gas, BTEX | | | |
| DATE | TIME | SAMPLE NUMBER | | | | | | | | | | |
| 7/22/94 | 1215 | S-0-5ft-7-A | Soil | | | | | | X | 1 | page 2 of 3 48 hour Turnaround | |
| | 1220 | S-0-5ft-7-B | ✓ | Composite to one 7 | | | | X | 1 | | | |
| | 1225 | S-0-5ft-7-C | ✓ | | | | | X | 1 | | | |
| | 1230 | S-0-5ft-7-D | ✓ | | | | | X | 1 | | | |
| 7/22/94 | 1250 | S-0-5ft-8-A | ✓ | | | | | | X | 1 | Questions/Results Xinggang Tong @ 510/874-3060 | |
| | 1245 | S-0-5ft-8-B | ✓ | Composite to one 8 | | | | X | 1 | | | |
| | 1240 | S-0-5ft-8-C | ✓ | | | | | X | 1 | | | |
| | 1235 | S-0-5ft-8-D | ✓ | | | | | X | 1 | | | |
| 7/22/94 | 1255 | S-0-5ft-9-A | ✓ | | | | | | X | 1 | | |
| | 1300 | S-0-5ft-9-B | ✓ | Composite to one 9 | | | | X | 1 | | | |
| | 1305 | S-0-5ft-9-C | ✓ | | | | | X | 1 | | | |
| | 1310 | S-0-5ft-9-D | ✓ | | | | | X | 1 | | | |
| 7/22/94 | 1330 | S-0-5ft-10-A | ✓ | | | | | | X | 1 | | |
| | 1325 | S-0-5ft-10-B | ✓ | Composite to one 10 | | | | X | 1 | | | |
| | 1320 | S-0-5ft-10-C | ✓ | | | | | X | 1 | | | |
| | 1315 | S-0-5ft-10-D | ✓ | | | | | X | 1 | | | |
| 7/22/94 | 1335 | S-0-5ft-11-A | ✓ | | | | | | X | 1 | | |
| | 1340 | S-0-5ft-11-B | ✓ | Composite to one 11 | | | | X | 1 | | | |
| | 1345 | S-0-5ft-11-C | ✓ | | | | | X | 1 | | | |
| | 1350 | S-0-5ft-11-D | ✓ | | | | | X | 1 | | | |
| 7/22/94 | 1410 | S-0-5ft-12-A | ✓ | | | | | | X | 1 | | |
| | 1405 | S-0-5ft-12-B | ✓ | Composite to one 12 | | | | X | 1 | | | |
| | 1400 | S-0-5ft-12-C | ✓ | | | | | X | 1 | | | |
| | 1355 | S-0-5ft-12-D | ✓ | | | | | X | 1 | | | |
| | | | | | | | | | TOTAL NUMBER OF CONTAINERS | 24 | | |

| | | | | | |
|---|---------------------------|---|---|---|-------------------------------|
| RELINQUISHED BY: (Signature) <i>Xinggang Tong</i> | DATE/TIME 7/22/94/1600 | RECEIVED BY: (Signature) <i>[Signature]</i> | RELINQUISHED BY: (Signature) | DATE/TIME | RECEIVED BY: (Signature) |
| METHOD OF SHIPMENT: Lab Courier | | SHIPPED BY: (Signature) | COURIER: (Signature) Woodward-Clyde | RECEIVED FOR LAB BY: (Signature) S.A. Stark | DATE/TIME 07/22/94 5:15 PM |

Collectors sealed & initialed

Woodward-Clyde Consultants

500 12th Street, Suite 100, Oakland, CA 94607-4014
(510) 893-3600

Chain of Custody Record

| PROJECT NO. 941114NA | | | ANALYSES | | | | | | | | REMARKS (Sample preservation, handling procedures, etc.) | |
|---|-------|---------------|----------------------------------|---------------------------|------------|------------|------------|--|--|----------------------------|---|---|
| DATE | TIME | SAMPLE NUMBER | Sample Matrix (Soil, Water, Air) | EPA Method | EPA Method | EPA Method | EPA Method | | | | | Number of Containers |
| SAMPLERS: (Signature) <i>[Signature]</i> | | | | | | | | | | | | |
| 7/22/84 | 15:00 | S-D-A | SOIL | | | | | | | | | Page 4 of 4 48-hr Turnaround Question / Results to Xinggang Tong 510/874-3060 |
| | 15:05 | S-D-B | " | Composite to one - 19 X | | | | | | | | |
| | 15:10 | S-D-C | " | | | | | | | | | |
| | 15:15 | S-D-D | " | | | | | | | | | |
| | 15:20 | S-O&G-A | SOIL | | | | | | | | | |
| | 15:25 | S-O&G-B | " | Composite to one - 20 X X | | | | | | | | |
| | 15:30 | S-O&G-C | " | | | | | | | | | |
| | 15:35 | S-O&G-D | " | | | | | | | | | |
| | 15:40 | S-G-A | SOIL | | | | | | | | | |
| | 15:45 | S-G-B | " | Composite to one - 21 X | | | | | | | | |
| | 15:50 | S-G-C | " | | | | | | | | | |
| ✓ | 15:55 | S-G-D | " | | | | | | | | | |
| | | | | | | | | | | TOTAL NUMBER OF CONTAINERS | 12 | |

| | | | | | |
|--|---------------------------|--|--------------------------------------|--|---------------------------|
| RELINQUISHED BY: (Signature) <i>[Signature]</i> | DATE/TIME 7/22/84 1600 | RECEIVED BY: (Signature) <i>[Signature]</i> | RELINQUISHED BY: (Signature) | DATE/TIME | RECEIVED BY: (Signature) |
| METHOD OF SHIPMENT: Lab Courier | | SHIPPED BY: (Signature) | COURIER: (Signature) Woodcoursier | RECEIVED FOR LAB BY: (Signature) S.A. Sketh | DATE/TIME 07/22/84 5PM |

cells sealed & intact
Total 12 containers

**APPENDIX D.3
DISPOSAL RECORD FOR SOIL EXCAVATED
FROM 5 TO 9.5 FT BELOW GRADE**

August 16, 1994

Tom Fantini
Alta Environmental Services, Inc.
831 Davis Street
Vacaville, California 95687

Subject: Soil Excavation, Stockpiling, Sampling, and Analysis
Celis Fuel Station at 4000 San Pablo Avenue
Emeryville, California

Dear Mr. Fantini:

Per the request by Ms. Amy Dietz of Norcal Waste Systems, Inc. in a memorandum of July 12, 1994 addressed to you, soil from the site east of the eastern wall of the former gas station building at the above referenced site was excavated from 5 to 9.5 feet below surface and stockpiled on site by Remedial Solutions Inc. (RSI) in August 9 and 10, 1994. The volume of the soil excavated is approximately 600 cubic yards. Soil from surface to 5-foot depth and from designated hot spot areas has been excavated previously according to the plan contained in the memorandum.

The stockpiled soil from 5 to 9.5 feet below surface was first staked to separate it to 7 sub-stockpiles as shown on the attached Figure. Four soil samples were collected per sub-stockpile in four separate locations labeled A through D. The samples were collected by Woodward-Clyde technicians in August 12, 1994. Sampling procedures are described below:

- 1) The plastic cover was first removed from each sample location;
- 2) At each designated sampling location (see attached figure), an approximately 8-inch diameter, 24-inch deep hole was dug;
- 3) Soil sample was then quickly collected from the bottom of the hole by using a stainless steel scoop and directly transferred into a 4-oz clear glass jar supplied by Chromalab. Soil was pressed hard into the glass jar to the maximum volume in order to minimize air space in the jar. The jar was then capped tightly with a teflon-sheet lined cap, labeled, and placed in an ice-cooled cooler;
- 4) The hole was backfilled and the area was covered with plastic sheet again;
- 5) Soil samples were picked up on site under chain-of-custody by Chromalab, Inc. of San Ramon and analyzed there.

Please call me at (510) 874-3060 if you have any questions.

Sincerely,



Xinggang Tong
Project Manager

San Pablo Ave.

100ft

100ft

Celi's Alliance Gas Station

Anderson Linoleum and Carpet Sales Warehouse

From diesel tank area to be disposed of at Forward Landfill

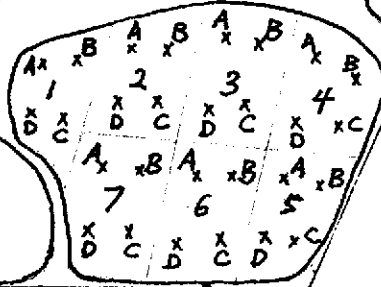

From oil tank area, to be disposed of at Forward Landfill

Parking Area

Soil from 5 to 9.5-foot depth, site east of the eastern wall of the former gas station building. Approx. Volume: 600 Yd³. This soil pile was first staked to separate it into 7 piles as shown here. Four soil samples were collected from each sub-pile at 24 to 30-inch into the soil pile.

Soil from 5 to 9.5-foot depth, site west of the eastern wall of the former gas station building. To be disposed of at B&J Landfill with hru-PID field screening for every truck loads. Approx. Volume: 900 Yd³

Wall

Source: References 3 and 5 (Levine-Fricke Rep)

| | | | |
|----------------------------|-----------------|---|----------|
| Project No. 941114NA | 40th Street UST | SITE PLAN 40TH STREET RIGHT-OF-WAY EMERYVILLE, CALIFORNIA | Fig 2 |
| Woodward-Clyde Consultants | | | |

FIELD SAMPLING NOTES

Woodward-Clyde

| | |
|---|---------------------|
| Project Location: 4000 San Pablo Ave. @ 40th St, Emeryville | Page 1 of 2 |
| Project Number: 941114NA | Date: 8/12/94 |
| Task Number: 4000 | Weather: sunny, hot |
| Sampled by: <i>Michelle Clifford</i> | Temperature: 100°F |
| Summary of Main Activities: Sample stockpiled soil for disposal to B&J Landfill | Wind: Calm |

| Sample No. | Type | Date | Time | Field ^{OVA} PHD screening (ppm) | Analyses requested | Notes |
|---------------|------|---------|------------------------|---|--------------------|----------------------------------|
| S-5-9.5ft-1-A | soil | 8/12/94 | 0955 | 20 | } TPHg BTX | Dug 2' deep hole before sampling |
| S-5-9.5ft-1-B | " | " | 0950 | 2 | | |
| S-5-9.5ft-1-C | " | " | 1002 | 3 | | |
| S-5-9.5ft-1-D | " | " | 10:00 | 2 | | |
| S-5-9.5ft-2-A | " | " | 1006 | 9 | } TPHg BTX | ↓ |
| S-5-9.5ft-2-B | " | " | 1010 | 0.5 | | |
| S-5-9.5ft-2-C | " | " | 1015 | 10 | | |
| S-5-9.5ft-2-D | " | " | 1019 | 9 | | |
| S-5-9.5ft-3-A | " | " | 1038 | 6 | } TPHg BTX | |
| S-5-9.5ft-3-B | " | " | 1034 | 80 | | |
| S-5-9.5ft-3-C | " | " | 1030 | 9 | | |
| S-5-9.5ft-3-D | " | " | 1025 | 24 | | |
| S-5-9.5ft-4-A | " | " | 1053 | 11 | } TPHg BTX | |
| S-5-9.5ft-4-B | " | " | 11:00 11:00 | 9 | | |
| S-5-9.5ft-4-C | " | " | 11:05 | 12 | | |
| S-5-9.5ft-4-D | " | " | 11:07 | 8 | | |

FIELD SAMPLING NOTES

Woodward-Clyde

| | |
|---|---------------------|
| Project Location: 4000 San Pablo Ave. @ 40th St., Emeryville | Page 2 of 2 |
| Project Number: 94 1114NA | Date: 8/12/94 |
| Task Number: 4000 | Weather: sunny hot |
| Sampled by: <i>[Signature]</i> | Temperature: 100 °F |
| Summary of Main Activities: Sample stockpiled soil for disposal to B&J Landfill | Wind: Calm |

| Sample No. | Type | Date | Time | Field PT ^{OVA} screening (PPM) | Analyses requested | Notes |
|---------------|------|---------|-------|--|--------------------|----------------------------------|
| S-5-9.5ft-5-A | soil | 8/12/94 | 1119 | 10 | } TPHg BTEX | Dug 2' deep hole before sampling |
| S-5-9.5ft-5-B | " | " | 1127 | 14 | | |
| S-5-9.5ft-5-C | " | " | 1130 | 7 | | |
| S-5-9.5ft-5-D | " | " | 1124 | 10 | | |
| S-5-9.5ft-6-A | " | " | 12:45 | 24 | } TPHg BTEX | } ↓ |
| S-5-9.5ft-6-B | " | " | 12:50 | 6 | | |
| S-5-9.5ft-6-C | " | " | 12:53 | 13 | | |
| S-5-9.5ft-6-D | " | " | 12:56 | 10 | | |
| S-5-9.5ft-7-A | " | " | 1303 | 12 | } TPHg BTEX | |
| S-5-9.5ft-7-B | " | " | 1306 | 44 | | |
| S-5-9.5ft-7-C | " | " | 1310 | 10 | | |
| S-5-9.5ft-7-D | " | " | 1315 | 9 | | |

APPENDIX D.4
ANALYTICAL REPORT FOR SOIL EXCAVATED
FROM 5 TO 9.5 FT BELOW GRADE

CHROMALAB, INC.

Environmental Services (SDB)

August 19, 1994

Submission #: 9408159

WOODWARD-CLYDE/OAKLAND
500 12th St., Suite 100
Oakland, CA 94607

Attn: Xinggang Tong

RE: Analysis for project 941114NA.

REPORTING INFORMATION

Samples were received cold and in good condition on August 12, 1994. They were refrigerated upon receipt and analyzed as described in the attached report. ChromaLab followed EPA or equivalent methods for all testing reported.

No discrepancies were observed or difficulties encountered with the testing.

SAMPLES TESTED IN THIS REPORT

| <u>Client Sample ID</u> | <u>Matrix</u> | <u>Date collected</u> | <u>Sample #</u> |
|-------------------------|---------------|-----------------------|-----------------|
| S-5-9.5FT-1-A,B,C,D | SOIL | August 12, 1994 | 60170 |
| S-5-9.5FT-2-A,B,C,D | SOIL | August 12, 1994 | 60171 |
| S-5-9.5FT-3-A,B,C,D | SOIL | August 12, 1994 | 60172 |
| S-5-9.5FT-4-A,B,C,D | SOIL | August 12, 1994 | 60173 |
| S-5-9.5FT-5-A,B,C,D | SOIL | August 12, 1994 | 60174 |
| S-5-9.5FT-6-A,B,C,D | SOIL | August 12, 1994 | 60175 |
| S-5-9.5FT-7-A,B,C,D | SOIL | August 12, 1994 | 60176 |



Jill Thomas
Quality Assurance Manager



Eric Tam
Laboratory Director

CHROMALAB, INC.

Environmental Services (SDB)

AUGUST 16, 1994

Submission #: 9408159

WOODWARD CLYDE CONSULTANTS

Attn: XINGGANG TONG

Project: N/A

Project#: 941114NA

Received: August 12, 1994

re: 7 Composite samples for GAS/BTEX analysis.

Matrix: SOIL

Sampled: August 12, 1994

Analyzed: August 12, 1994

Method: 5030/8015/8020

| Sample # | Client Sample ID | Gasoline (mg/Kg) | Benzene (µg/Kg) | Toluene (µg/Kg) | Ethyl Benzene (µg/Kg) | Total Xylenes (µg/Kg) |
|----------------------|---------------------|------------------|------------------|-------------------|-----------------------|-----------------------|
| 60170 | S-5-9.5FT-1-A,B,C,D | 25 | 14 | 64 | 180 | 1400 |
| 60171 | S-5-9.5FT-2-A,B,C,D | 140 ^a | 780 ^a | 1500 ^a | 1500 ^a | 7900 ^a |
| 60172 | S-5-9.5FT-3-A,B,C,D | 2.4 | N.D. | N.D. | N.D. | 40 |
| 60173 | S-5-9.5FT-4-A,B,C,D | 92 ^b | 56 ^b | 440 ^b | 670 ^b | 4200 ^b |
| 60174 | S-5-9.5FT-5-A,B,C,D | 8.4 ^c | 64 ^c | 880 ^c | 820 ^c | 5100 ^c |
| 60175 | S-5-9.5FT-6-A,B,C,D | 22 ^d | 26 ^d | 160 ^d | 140 ^d | 1100 ^d |
| 60176 | S-5-9.5FT-7-A,B,C,D | 23 | 17 | 130 | 170 | 1300 |
| Blank | | N.D. | N.D. | N.D. | N.D. | N.D. |
| Blank Spike Recovery | | 103% | 97% | 104% | 101% | 99% |
| Reporting Limit | | 1.0 | 5.0 | 5.0 | 5.0 | 5.0 |

- a - Reporting limit for BTEX=100 µg/kg & Gas=20 mg/kg due to dilution needed.
- b - Reporting limit for BTEX=25 µg/kg & Gas=5 mg/kg due to dilution needed.
- c - Reporting limit for BTEX=50 µg/kg & Gas=10 mg/kg due to dilution needed.
- d - Reporting limit for BTEX=8 µg/kg & Gas=2 mg/kg due to dilution needed.

ChromaLab, Inc.

Billy Thach
Analytical Chemist

Ali Kharrazi
Organic Manager

CHROMALAB, INC.

Environmental Services (SDB)

GAS/BTEX REPORT-QUALITY CONTROL

August 19, 1994

Submission #: 9408159

WOODWARD-CLYDE/OAKLAND

Attn: XINGGANG TONG

Project: N/A

Project#: 941114NA

Received: August 12, 1994

re: 7 Composite samples for GAS/BTEX

Matrix: Water

Sampled: August 12, 1994

Analyzed: August 12, 1994

Method: EPA 5030/8015/8020

SURROGATE RECOVERIES **

| Sample # | Client Sample ID | TRIFLUOROTOLUENE % |
|-------------|---------------------|-----------------------|
| 60170 | S-5-9.5FT-1-A,B,C,D | 305* |
| 60171 | S-5-9.5FT-2-A,B,C,D | 150* |
| 60172 | S-5-9.5FT-3-A,B,C,D | 107 |
| 60173 | S-5-9.5FT-4-A,B,C,D | 155* |
| 60174 | S-5-9.5FT-5-A,B,C,D | 139* |
| 60175 | S-5-9.5FT-6-A,B,C,D | 119 |
| 60176 | S-5-9.5FT-7-A,B,C,D | 210* |
| Blank | | 106 |
| Blank Spike | | 102 |

* Coelution verified by reanalysis.

** High sample concentrations cause matrix interferences. Therefore, no matrix spike results available.

107100170 - 6

SUBM #: 9408159
CLIENT: W&C-OAK
DUE: 03/16/94
REF #: 17946

Woodward-Clyde Consultants

500 12th Street, Suite 100, Oakland, CA 94607-4014
(510) 893-3600

C

| PROJECT NO. 941114 NA | | | ANALYSES | | | | | | | Number of Containers | REMARKS (Sample preservation, handling procedures, etc.) |
|---|------|---------------|----------------------------------|----------------------|------------|------------|------------|------------|--|----------------------------|---|
| DATE | TIME | SAMPLE NUMBER | Sample Matrix (Soil, Water, Air) | EPA Method | EPA Method | EPA Method | EPA Method | TPHs, BTEX | | | |
| SAMPLERS: (Signature) <i>Clifford Chan</i> | | | | | | | | | | | |
| 8/12/94 | 955 | S-5-9.5ft-1-A | Soil | | | | | | | 1 | 48-hour Turnaround |
| | 956 | S-5-9.5ft-1-B | } Composite to one X | | | | | | | 1 | |
| | 1002 | S-5-9.5ft-1-C | | | | | | | | 1 | |
| | 1000 | S-5-9.5ft-1-D | | | | | | | | 1 | |
| | 1006 | S-5-9.5ft-2-A | | } Composite to one X | | | | | | | 1 |
| | 1010 | S-5-9.5ft-2-B | | | | | | | | 1 | |
| | 1015 | S-5-9.5ft-2-C | | | | | | | | 1 | |
| | 1019 | S-5-9.5ft-2-D | | | | | | | | 1 | |
| | 1038 | S-5-9.5ft-3-A | } Composite to one X | | | | | | | 1 | |
| | 1034 | S-5-9.5ft-3-B | | | | | | | | 1 | |
| | 1030 | S-5-9.5ft-3-C | | | | | | | | 1 | |
| | 1025 | S-5-9.5ft-3-D | | | | | | | | 1 | |
| | 1053 | S-5-9.5ft-4-A | } Composite to one X | | | | | | | 1 | |
| | 1100 | S-5-9.5ft-4-B | | | | | | | | 1 | |
| | 1105 | S-5-9.5ft-4-C | | | | | | | | 1 | |
| ✓ | 1107 | S-5-9.5ft-4-D | | ✓ | | | | | | 1 | |
| RUSH | | | | | | | | | | | |
| | | | | | | | | | | TOTAL NUMBER OF CONTAINERS | 16 |

RELINQUISHED BY: (Signature)
[Signature]

DATE/TIME
8/12/94 1443

RECEIVED BY: (Signature)
[Signature]

RELINQUISHED BY: (Signature)
[Signature]

DATE/TIME
8/12/94 4:00pm

RECEIVED BY: (Signature)
[Signature]

METHOD OF SHIPMENT:
Chromolab Courier

SHIPPED BY: (Signature)
[Signature]

COURIER: (Signature)

RECEIVED FOR LAB BY: (Signature)
[Signature]

DATE/TIME
8/12/94 16:05

Woodward-Clyde Consultants

500 12th Street, Suite 100, Oakland, CA 94607-4014
(510) 893-3600

Chain of Custody Record

17947

| PROJECT NO. 94114NA | | | Sample Matrix (Soil, Water, Air) | ANALYSES | | | | | | Number of Containers | REMARKS (Sample preservation, handling procedures, etc.) | |
|---|------|---------------|-------------------------------------|------------------|------------|------------|------------|------------|----------------------------|----------------------|---|-------------------|
| DATE | TIME | SAMPLER NO. | | EPA Method | EPA Method | EPA Method | EPA Method | TPHs, BTEX | | | | |
| SAMPLERS: (Signature) <i>Clifford Chan</i> | | | | | | | | | | | | |
| 8/12/94 | 1119 | S-5-9.5ft-5-A | SOIL | | | | | | | 1 | 48-hr Turnaround | |
| | 1127 | S-5-9.5ft-5-B | | Composite to one | | | | | | X | | 1 |
| | 1130 | S-5-9.5ft-5-C | | | | | | | | 1 | | |
| | 1124 | S-5-9.5ft-5-D | | | | | | | | 1 | | Questions/Results |
| | 1245 | S-5-9.5ft-6-A | | | | | | | | 1 | Xinggang Tong ② 510/874-3060 | |
| | 1250 | S-5-9.5ft-6-B | | Composite to one | | | | | | X | | 1 |
| | 1253 | S-5-9.5ft-6-C | | | | | | | | 1 | | |
| | 1256 | S-5-9.5ft-6-D | | | | | | | | 1 | | |
| | 1303 | S-5-9.5ft-7-A | | | | | | | | 1 | | |
| | 1306 | S-5-9.5ft-7-B | | Composite to one | | | | | | X | | 1 |
| | 1310 | S-5-9.5ft-7-C | | | | | | | | 1 | | |
| Y | 1315 | S-5-9.5ft-7-D | | | | | | | | 1 | | |
| | | | | | | | | | TOTAL NUMBER OF CONTAINERS | 12 | | |

RUSH

| | | | | | |
|---|---------------------------|---|---|---|--------------------------------------|
| RELINQUISHED BY: (Signature) <i>[Signature]</i> | DATE/TIME 8/12/94 1443 | RECEIVED BY: (Signature) <i>[Signature]</i> | RELINQUISHED BY: (Signature) <i>[Signature]</i> | DATE/TIME 8/12/94 4:00pm | RECEIVED BY: (Signature) |
| METHOD OF SHIPMENT: <i>Chromo Lab Courier</i> | | SHIPPED BY: (Signature) | COURIER: (Signature) | RECEIVED FOR LAB BY: (Signature) <i>B. Bonarion</i> | DATE/TIME 8/12/94 6:00 |

APPENDIX D.5
FORWARD LANDFILL WASTE MANIFESTS

JOB ACCEPTANCE NO. **CMM-1025**

LOAD 1

TO BE COMPLETED BY THE GENERATOR

GENERATOR
CITY OF EMERYVILLE - REDEVELOPMENT AGENCY
MAILING ADDRESS
 2200 POWELL ST., 12TH FLOOR
CITY, STATE, ZIP
 EMERYVILLE, CA 94608
PHONE
 (510) 596-4356
CONTACT PERSON
 MR. IGNACIO DAYRIT
SIGNATURE OF AUTHORIZED AGENT / TITLE **DATE**
 * *[Signature]* 8-23-94

REQUIRED PERSONAL PROTECTIVE EQUIPMENT
 GLOVES GOGGLES RESPIRATOR HARD HAT
 TY-VEK OTHER

SPECIAL HANDLING PROCEDURES:

WASTE TYPE
 TREATMENT SOIL SLUDGE
 DISPOSAL SOIL NON-FRIABLE ASBESTOS
 CONSTRUCTION SOIL WOOD
 ASH
 OTHER

RECEIVING FACILITY
FORWARD INC. LANDFILL
 9999 SOUTH AUSTIN ROAD
 MANTECA, CALIFORNIA 95336
 (209) 982-4298 PHONE
 (209) 982-1009 FAX

GENERATING FACILITY
 40TH STREET UST PROJECT
 4000 SAN PABLO AVE.
 EMERYVILLE, CA

HAULER MUST COMPLETE

NAME
 NORTHERN TRUCK + EQUIPMENT
ADDRESS
 33704 14TH ST.
CITY, STATE, ZIP
 UNION CITY, CA 94587
PHONE
 (510) 429-8920
SIGNATURE OF AUTHORIZED AGENT OR DRIVER **DATE**
 * *[Signature]* 8/24/94

NOTES: **TRUCK NUMBER**
 R-3

END DUMP **BOTTOM DUMP** **TRANSFER**

ROLL-OFF(S) **FLAT-BED** **VAN** **DRUMS**

FACILITY REQUIREMENTS

FORWARD INC. LANDFILL
 Forward shall have no obligation to accept the waste if weather or other conditions impair the safe and effective disposal of the waste or if the waste impairs the safe and effective operation of the Landfill. Forward shall use reasonable efforts to promptly notify Disposer of its inability to accept the waste for any reason. If Forward's refusal to accept the waste is based on weather or other site conditions, Forward shall notify the Disposer when site conditions are expected to change such that Forward will be able to accept the waste.
REMARKS
FACILITY TICKET NUMBER
SIGNATURE OF AUTHORIZED AGENT **DATE**
 * *[Signature]* 8-24-94

CUBIC YARDS
 18

| DISPOSAL METHOD | (TO BE COMPLETED BY FORWARD) | | | | |
|---|------------------------------|-----|--------|-----------|-------|
| | DISPOSE | BIO | AERATE | STOCKPILE | OTHER |
| <input checked="" type="checkbox"/> SOIL | | | | | |
| <input type="checkbox"/> SLUDGE | | | | | |
| <input type="checkbox"/> NON-FRIABLE ASBESTOS | | | | | |
| <input type="checkbox"/> WOOD | | | | | |
| <input type="checkbox"/> ASH | | | | | |
| <input type="checkbox"/> OTHER | | | | | |

SCHEDULING MUST BE MADE PRIOR TO 4:00 P.M. THE DAY PRIOR TO EXPECTED ARRIVAL • ANY UNSCHEDULED LOADS ARE SUBJECT TO REFUSAL UPON ARRIVAL. ONGOING DAILY DELIVERIES MUST BE SCHEDULED WITH THE LANDFILL THE DAY BEFORE. TO SCHEDULE CALL (209) 982-4298

JOB ACCEPTANCE NO. **CMM-1075**

LOAD **Z**

TO BE COMPLETED BY THE GENERATOR

GENERATOR
CITY OF EMERYVILLE - REDEVELOPMENT AGENCY
MAILING ADDRESS
2700 POWELL ST., 12TH FLOOR
CITY, STATE, ZIP
EMERYVILLE, CA 94608
PHONE
(510) 596-4356
CONTACT PERSON
MR. IGNACIO DAYRIT
SIGNATURE OF AUTHORIZED AGENT / TITLE **DATE**
[Signature] **8-23-94**

REQUIRED PERSONAL PROTECTIVE EQUIPMENT
 GLOVES GOGGLES RESPIRATOR HARD HAT
 TY-VEK OTHER

SPECIAL HANDLING PROCEDURES:

WASTE TYPE

| | |
|---|---|
| <input type="checkbox"/> TREATMENT SOIL | <input type="checkbox"/> SLUDGE |
| <input checked="" type="checkbox"/> DISPOSAL SOIL | <input type="checkbox"/> NON-FRIABLE ASBESTOS |
| <input type="checkbox"/> CONSTRUCTION SOIL | <input type="checkbox"/> WOOD |
| | <input type="checkbox"/> ASH |
| | <input type="checkbox"/> OTHER |

RECEIVING FACILITY

FORWARD INC. LANDFILL
9999 SOUTH AUSTIN ROAD
MANTECA, CALIFORNIA 95336
(209) 982-4298 PHONE
(209) 982-1009 FAX

GENERATING FACILITY
40TH STREET UST PROJECT
4000 SAN PABLO AVE.
EMERYVILLE, CA

SPORADIC HAULER MUST COMPLETE

NAME
NORTHEAN TRUCK + EQUIPMENT - Collins Truck
ADDRESS
33704 14TH ST. - 2107 SAN PABLO
CITY, STATE, ZIP
UNION CITY, CA 94587 - Mission Hills
PHONE
(510) 429-8920 - 402-775
SIGNATURE OF AUTHORIZED AGENT OR DRIVER **DATE**
[Signature] **8-24-94**

NOTES:

TRUCK NUMBER
C3

| | | |
|--------------------------------------|--------------------------------------|-----------------------------------|
| <input type="checkbox"/> END DUMP | <input type="checkbox"/> BOTTOM DUMP | <input type="checkbox"/> TRANSFER |
| <input type="checkbox"/> ROLL-OFF(S) | <input type="checkbox"/> FLAT-BED | <input type="checkbox"/> VAN |
| <input type="checkbox"/> | <input type="checkbox"/> | <input type="checkbox"/> |
| <input type="checkbox"/> | <input type="checkbox"/> | <input type="checkbox"/> |

QUALITY REQUIREMENTS

FORWARD INC. LANDFILL

Forward shall have no obligation to accept the waste if weather or other conditions impair the safe and effective disposal of the waste or if the waste impairs the safe and effective operation of the Landfill. Forward shall use reasonable efforts to promptly notify Disposer of its inability to accept the waste for any reason. If Forward's refusal to accept the waste is based on weather or other site conditions, Forward shall notify the Disposer when site conditions are expected to change such that Forward will be able to accept the waste.

REMARKS

FACILITY TICKET NUMBER

SIGNATURE OF AUTHORIZED AGENT **DATE**
[Signature] **8-24-94**

| DISPOSAL METHOD | CUBIC YARDS | | | | |
|---|-------------|-----|--------|-----------|-------|
| | DISPOSE | BIO | AERATE | STOCKPILE | OTHER |
| <input type="checkbox"/> SOIL | | | | | |
| <input type="checkbox"/> SLUDGE | | | | | |
| <input type="checkbox"/> NON-FRIABLE ASBESTOS | | | | | |
| <input type="checkbox"/> WOOD | | | | | |
| <input type="checkbox"/> ASH | | | | | |
| <input type="checkbox"/> OTHER | | | | | |

SCHEDULING MUST BE MADE PRIOR TO 4:00 P.M. THE DAY PRIOR TO EXPECTED ARRIVAL • ANY UNSCHEDULED LOADS ARE SUBJECT TO REFUSAL UPON ARRIVAL. ONGOING DAILY DELIVERIES MUST BE SCHEDULED WITH THE LANDFILL THE DAY BEFORE. ☎ SCHEDULE CALL (209) 982-4298

APPENDIX D.6
B&J/ALTA LANDFILL WASTE MANIFESTS



People • Service • Environment
ALTA ENVIRONMENTAL SERVICES, INC.

October 10, 1994

Matt Dwyer
43353 Osgood Road, Suite B
Fremont, California 94539

Dear Mr. Dwyer;

Kindly accept this letter as confirmation of disposal
at B&J Landfill of 3,204 cubic yards of contaminated
soil generated by the former Celli's Gas Station
located at 4000 San Pablo Avenue, Emeryville, California.

Thank you for the opportunity to service you!

Sincerely,

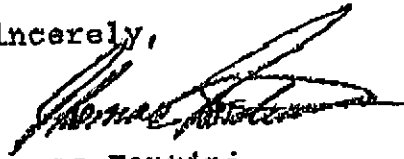
Thomas Fantini
Manager, Marketing and Sales
Alta Environmental Services, Inc.

cc: Woodward Clyde

A NORCAL COMPANY
831 DAVIS STREET • VACAVILLE, CA 95607 • TELEPHONE 800/792-2788 • FAX 707/448-1257

An Employee-Owned Company

| | | | | |
|-------------------------------------|---|-----------------------|--------------|---------------------------|
| NON-HAZARDOUS WASTE MANIFEST | 1. Generator's US EPA ID No. NOT APPLICABLE | Manifest Document No. | 2. Page 1 of | Authorizaton No. 01216 |
|-------------------------------------|---|-----------------------|--------------|---------------------------|

| | |
|---|-----|
| 3. Generator's Name and Mailing Address City of Emeryville Redevelopment Agency 2200 Powell St.; 12th Floor Emeryville, CA 94608 | RSI |
| 4. Generator's Phone (510) 596-4356 Attn: Ignacio Dayrit | |

| | | |
|---|---------------------------------------|-----------|
| 5. Transporter 1 Company Name Northern Truck and Equipment | 6. US EPA ID Number NOT APPLICABLE | 3113 TR # |
| 7. Transporter 2 Company Name | 8. US EPA ID Number NOT APPLICABLE | |

| | | |
|--|--|---|
| 9. Designated Facility Name and Site Address B & J LANDFILL 6426 HAY ROAD VACAVILLE, CA 95687 | 10. US EPA ID Number NOT APPLICABLE | A. Transporter's Phone (510) 429-8920 B. Transporter's Phone C. Facility's Phone (707) 451-3276 |
|--|--|---|

| 11. Waste Shipping Name and Description | 12. Containers | | 13. Total Quantity | 14. Unit Wt/Vol |
|--|----------------|------|--------------------|-----------------|
| | No. | Type | | |
| a. Soil contaminated with petroleum hydrocarbons | 1 | T | 18 | Y |
| b. | . | . | . | . |
| c. | . | . | . | . |
| d. | . | . | . | . |

| | |
|---|---|
| D. Additional Descriptions for Materials Listed Above Soil excavated from 40th Street UST Project 4000 San Pablo Ave., Emeryville, CA | E. Handling Codes for Wastes Listed Above 03 |
|---|---|

15. Special Handling Instructions and Additional Information

16. GENERATOR'S CERTIFICATION: I certify the materials described above on this manifest are not subject to federal regulations for reporting proper disposal of Hazardous Waste.

| | | |
|--|-----------------------------------|----------------------------|
| Printed/Typed Name RONALD GERBER | Signature <i>Ronald Gerber</i> | Month Day Year 08 03 94 |
|--|-----------------------------------|----------------------------|

| | | |
|--|------------------------------------|----------------------------|
| 17. Transporter 1 Acknowledgement of Receipt of Materials Printed/Typed Name ARNOLD PROFFER | Signature <i>Arnold Proffer</i> | Month Day Year 08 10 94 |
|--|------------------------------------|----------------------------|

| | | |
|---|-----------|----------------|
| 18. Transporter 2 Acknowledgement of Receipt of Materials Printed/Typed Name | Signature | Month Day Year |
|---|-----------|----------------|

19. Discrepancy Indication Space

20. Facility Owner or Operator: Certification of receipt of waste materials covered by this manifest except as noted in Item 19.

| | | |
|--|---------------------------------|----------------------------|
| Printed/Typed Name MARY BORDEN | Signature <i>Mary Borden</i> | Month Day Year 08 10 94 |
|--|---------------------------------|----------------------------|

| NON-HAZARDOUS WASTE MANIFEST | | 1. Generator's US EPA ID No. NOT APPLICABLE | Manifest Document No. | 2. Page 1 of | Authorizaton No. 01216 |
|--|--|---|-----------------------|--|---------------------------|
| 3. Generator's Name and Mailing Address City of Emeryville Redevelopment Agency 2200 Powell St.; 12th Floor Emeryville, CA 94608 | | | | R.S.I. | |
| 4. Generator's Phone (510) 596-4356 Attn: Ignacio Dayrit | | | | # 1 | |
| 5. Transporter 1 Company Name Northern Truck and Equipment | | 6. US EPA ID Number NOT APPLICABLE | | | |
| 7. Transporter 2 Company Name | | 8. US EPA ID Number NOT APPLICABLE | | | |
| 9. Designated Facility Name and Site Address B & J LANDFILL 6426 HAY ROAD VACAVILLE, CA 95687 | | 10. US EPA ID Number NOT APPLICABLE | | A. Transporter's Phone (510)429-8920 B. Transporter's Phone C. Facility's Phone (707) 451-3276 | |
| 11. Waste Shipping Name and Description | | 12. Containers | | 13. Total Quantity | |
| a. Soil contaminated with petroleum hydrocarbons | | No. Type | | 14. Unit Wt/Vol | |
| | | 1 1 T | | 18 Y | |
| b. | | | | | |
| c. | | | | | |
| d. | | | | | |
| D. Additional Descriptions for Materials Listed Above Soil excavated from 40th Street UST Project 4000 San Pablo Ave., Emeryville, CA | | E. Handling Codes for Wastes Listed Above 03 | | | |
| 15. Special Handling Instructions and Additional Information | | | | | |
| 16. GENERATOR'S CERTIFICATION: I certify the materials described above on this manifest are not subject to federal regulations for reporting proper disposal of Hazardous Waste. | | | | | |
| Printed/Typed Name RONALD GERBER | | Signature Ronald Gerber | | Month Day Year 08 03 94 | |
| 17. Transporter 1 Acknowledgement of Receipt of Materials | | Printed/Typed Name Rinsy Trucking | | Signature [Signature] | |
| 18. Transporter 2 Acknowledgement of Receipt of Materials | | Printed/Typed Name | | Signature [Signature] | |
| 19. Discrepancy Indication Space | | | | | |
| 20. Facility Owner or Operator: Certification of receipt of waste materials covered by this manifest except as noted in Item 19 | | | | | |
| Printed/Typed Name Jill A Fisher | | Signature Jill A Fisher | | Month Day Year 08 03 94 | |

ORIGINAL RETURN TO GENERATOR

| | | | | | |
|---|--|---|---|----------------------------|---------------------------|
| NON-HAZARDOUS WASTE MANIFEST | | 1. Generator's US EPA ID No. NOT APPLICABLE | Manifest Document No. | 2. Page 1 of | Authorizaton No. 01216 |
| 3. Generator's Name and Mailing Address City of Emeryville Redevelopment Agency 2200 Powell St.; 12th Floor Emeryville, CA 94608 4. Generator's Phone (510) 596-4356 Attn: Ignacio Dayrit | | | PSI- TR# 302. | | |
| 5. Transporter 1 Company Name Northern Truck and Equipment | 6. US EPA ID Number NOT APPLICABLE | | | | |
| 7. Transporter 2 Company Name | 8. US EPA ID Number NOT APPLICABLE | | | | |
| 9. Designated Facility Name and Site Address B & J LANDFILL 6426 HAY ROAD VACAVILLE, CA 95687 | | 10. US EPA ID Number NOT APPLICABLE | A. Transporter's Phone (510)429-8920 B. Transporter's Phone C. Facility's Phone (707) 451-3276 | | |
| 11. Waste Shipping Name and Description | | 12. Containers | 13. Total Quantity | 14. Unit Wt/Vol | |
| a. Soil contaminated with petroleum hydrocarbons | | No. 1 | Type T | 18 | Y |
| b. | | | | | |
| c. | | | | | |
| d. | | | | | |
| D. Additional Descriptions for Materials Listed Above Soil excavated from 40th Street UST Project 4000 San Pablo Ave., Emeryville, CA | | E. Handling Codes for Wastes Listed Above 03 | | | |
| 15. Special Handling Instructions and Additional Information | | | | | |
| 16. GENERATOR'S CERTIFICATION: I certify the materials described above on this manifest are not subject to federal regulations for reporting proper disposal of Hazardous Waste. | | | | | |
| Printed/Typed Name RONALD GERBER | | Signature Ronald Gerber | | Month Day Year 08 10 94 | |
| 17. Transporter 1 Acknowledgement of Receipt of Materials | | Signature | | Month Day Year | |
| Printed/Typed Name | | Signature | | Month Day Year | |
| 18. Transporter 2 Acknowledgement of Receipt of Materials | | Signature | | Month Day Year | |
| Printed/Typed Name | | Signature | | Month Day Year | |
| 19. Discrepancy Indication Space | | | | | |
| 20. Facility Owner or Operator: Certification of receipt of waste materials covered by this manifest except as noted in Item 19. | | | | | |
| Printed/Typed Name Jill A Fisher | | Signature Jill A Fisher | | Month Day Year 08 10 94 | |

GENERATOR

TRANSPORTER

FACILITY

**NON-HAZARDOUS
 WASTE MANIFEST**

1. Generator's US EPA ID No.
 NOT APPLICABLE

Manifest Document No.

2. Page 1 of

Authorizaton No.
 01216

3. Generator's Name and Mailing Address
 City of Emeryville Redevelopment Agency
 2200 Powell St., 12th Floor
 Emeryville, CA 94608

4. Generator's Phone (510) 596-4356 Attn: Ignacio Dayrit

5. Transporter 1 Company Name
 Northern Truck and Equipment

6. US EPA ID Number
 NOT APPLICABLE

7. Transporter 2 Company Name

8. US EPA ID Number
 NOT APPLICABLE

9. Designated Facility Name and Site Address

B & J LANDFILL
 6426 HAY ROAD
 VACAVILLE, CA 95687

10. US EPA ID Number
 NOT APPLICABLE

A. Transporter's Phone (510) 429-8920

B. Transporter's Phone

C. Facility's Phone
 (707) 451-3276

11. Waste Shipping Name and Description

a. Soil contaminated with petroleum hydrocarbons

| 12. Containers | | 13. Total Quantity | 14. Unit Wt/Vol |
|----------------|------|--------------------|-----------------|
| No. | Type | | |
| 1 | T | 18 | Y |
| . | . | . | . |
| . | . | . | . |
| . | . | . | . |
| . | . | . | . |

D. Additional Descriptions for Materials Listed Above

Soil excavated from 40th Street UST Project
 4000 San Pablo Ave., Emeryville, CA

E. Handling Codes for Wastes Listed Above

03

15. Special Handling Instructions and Additional Information

16. GENERATOR'S CERTIFICATION: I certify the materials described above on this manifest are not subject to federal regulations for reporting proper disposal of Hazardous Waste.

Printed/Typed Name

RONALD GERBER

Signature

Ronald Gerber

Month Day Year

8 3 94

17. Transporter 1 Acknowledgement of Receipt of Materials

Printed/Typed Name

Doug Koch

Signature

Doug Koch

Month Day Year

8 8 94

18. Transporter 2 Acknowledgement of Receipt of Materials

Printed/Typed Name

Signature

Month Day Year

19. Discrepancy Indication Space

20. Facility Owner or Operator: Certification of receipt of waste materials covered by this manifest except as noted in Item 19.

Printed/Typed Name

MARY BORDEEN

Signature

Mary Bordeen

Month Day Year

8 10 94

ORIGINAL-RETURN TO GENERATOR

| | | | | | |
|--|--|---|--|---|---------------------------|
| NON-HAZARDOUS WASTE MANIFEST | | 1. Generator's US EPA ID No. NOT APPLICABLE | Manifest Document No. | 2. Page 1 of | Authorizaton No. 01216 |
| 3. Generator's Name and Mailing Address City of Emeryville Redevelopment Agency 2200 Powell St., 12th Floor Emeryville, CA 94608 | | | | RSI | |
| 4. Generator's Phone (510) 596-4356 Attn: Ignacio Dayrit | | | | | |
| 5. Transporter 1 Company Name Northern Truck and Equipment | | 6. US EPA ID Number NOT APPLICABLE | | 3113 TRK# 691 | |
| 7. Transporter 2 Company Name | | 8. US EPA ID Number NOT APPLICABLE | | | |
| 9. Designated Facility Name and Site Address B & J LANDFILL 6426 HAY ROAD VACAVILLE, CA 95687 | | 10. US EPA ID Number NOT APPLICABLE | | A. Transporter's Phone (510) 429-8920 B. Transporter's Phone C. Facility's Phone (707) 451-3276 | |
| 11. Waste Shipping Name and Description | | | | 12. Containers | 13. Total Quantity |
| | | | | No. | 14. Unit Wt/Vol |
| a. Soil contaminated with petroleum hydrocarbons | | | | 1 | T 18 Y |
| b. | | | | | |
| c. | | | | | |
| d. | | | | | |
| D. Additional Descriptions for Materials Listed Above Soil excavated from 40th Street UST Project 4000 San Pablo Ave., Emeryville, CA | | | | E. Handling Codes for Wastes Listed Above 03 | |
| 15. Special Handling Instructions and Additional Information | | | | | |
| 16. GENERATOR'S CERTIFICATION: I certify the materials described above on this manifest are not subject to federal regulations for reporting proper disposal of Hazardous Waste. | | | | | |
| Printed/Typed Name RONALD GERBER | | | Signature <i>Ronald Gerber</i> Month Day Year 08 03 94 | | |
| 17. Transporter 1 Acknowledgement of Receipt of Materials | | | | | |
| Printed/Typed Name EDWARD A ROUSE | | | Signature <i>Edward A Rouse</i> Month Day Year 08 03 94 | | |
| 18. Transporter 2 Acknowledgement of Receipt of Materials | | | | | |
| Printed/Typed Name | | | Signature Month Day Year | | |
| 19. Discrepancy Indication Space | | | | | |
| 20. Facility Owner or Operator: Certification of receipt of waste materials covered by this manifest except as noted in Item 19. | | | | | |
| Printed/Typed Name MARCO BODLEY | | | Signature <i>Marco Bodley</i> Month Day Year 08 03 94 | | |

GENERATOR
TRANSPORTER
FACILITY

ORIGINAL-RETURN TO GENERATOR

| NON-HAZARDOUS WASTE MANIFEST | | 1. Generator's US EPA ID No. NOT APPLICABLE | Manifest Document No. | 2. Page 1 of | Authorizaton No. 01216 |
|--|--|--|---|---|---------------------------|
| 3. Generator's Name and Mailing Address City of Emeryville Redevelopment Agency 2200 Powell St.; 12th Floor Emeryville, CA 94608 | | 4. Generator's Phone (510) 596-4356 Attn: Ignacio Dayrit | | RSI 591 | |
| 5. Transporter 1 Company Name Northern Truck and Equipment | | 6. US EPA ID Number NOT APPLICABLE | | 3113 | |
| 7. Transporter 2 Company Name | | 8. US EPA ID Number NOT APPLICABLE | | | |
| 9. Designated Facility Name and Site Address B & J LANDFILL 6426 HAY ROAD VACAVILLE, CA 95687 | | 10. US EPA ID Number NOT APPLICABLE | | A. Transporter's Phone (510) 429-8920 B. Transporter's Phone C. Facility's Phone (707) 451-3276 | |
| 11. Waste Shipping Name and Description | | | 12. Containers | | 13. Total Quantity |
| a. Soil contaminated with petroleum hydrocarbons | | | No. | Type | 14. Unit Wt/Vol |
| | | | 1 | T | 18 Y |
| b. | | | | | |
| c. | | | | | |
| d. | | | | | |
| D. Additional Descriptions for Materials Listed Above Soil excavated from 40th Street UST Project 4000 San Pablo Ave., Emeryville, CA | | | E. Handling Codes for Wastes Listed Above 03 | | |
| 15. Special Handling Instructions and Additional Information | | | | | |
| 16. GENERATOR'S CERTIFICATION: I certify the materials described above on this manifest are not subject to federal regulations for reporting proper disposal of Hazardous Waste. | | | | | |
| Printed/Typed Name RONALD GERBER | | Signature <i>Ronald Gerber</i> | | Month 8 | Day 3 |
| 17. Transporter 1 Acknowledgement of Receipt of Materials | | Printed/Typed Name John D. ... | | Signature <i>John D. ...</i> | |
| 18. Transporter 2 Acknowledgement of Receipt of Materials | | Printed/Typed Name | | Signature | |
| 19. Discrepancy Indication Space | | | | Month | Day |
| 20. Facility Owner or Operator: Certification of receipt of waste materials covered by this manifest except as noted in Item 19. | | | | | |
| Printed/Typed Name MARY BORDEN | | Signature <i>Mary Borden</i> | | Month 08 | Day 03 |

GENERATOR

TRANSPORTER

FACILITY

| | | | | |
|-------------------------------------|---|-----------------------|--------------|---------------------------|
| NON-HAZARDOUS WASTE MANIFEST | 1. Generator's US EPA ID No. NOT APPLICABLE | Manifest Document No. | 2. Page 1 of | Authorizaton No. 01216 |
|-------------------------------------|---|-----------------------|--------------|---------------------------|

| | | | |
|---|---|---------------------------------------|--|
| 3. Generator's Name and Mailing Address City of Emeryville Redevelopment Agency 2200 Powell St.; 12th Floor Emeryville, CA 94608 | | | |
| 4. Generator's Phone (510) 596-4356 Attn: Ignacio Dayrit | | | |
| 5. Transporter 1 Company Name Northern Truck and Equipment | 6. US EPA ID Number NOT APPLICABLE | 3113 #291 | |
| 7. Transporter 2 Company Name <i>Dilled</i> | 8. US EPA ID Number NOT APPLICABLE | | |
| 9. Designated Facility Name and Site Address B & J LANDFILL 6426 HAY ROAD VACAVILLE, CA 95687 | 10. US EPA ID Number NOT APPLICABLE | A. Transporter's Phone (510) 429-8920 | |
| | | B. Transporter's Phone | |
| | | C. Facility's Phone (707) 451-3276 | |

| 11. Waste Shipping Name and Description | 12. Containers | | 13. Total Quantity | 14. Unit Wt/Vol |
|--|----------------|------|--------------------|--------------------|
| | No. | Type | | |
| a. Soil contaminated with petroleum hydrocarbons | 1 | T | 18 | Y |
| b. | . | . | . | . |
| c. | . | . | . | . |
| d. | . | . | . | . |

| | |
|---|---|
| D. Additional Descriptions for Materials Listed Above Soil excavated from 40th Street UST Project 4000 San Pablo Ave., Emeryville, CA | E. Handling Codes for Wastes Listed Above 03 |
|---|---|

15. Special Handling Instructions and Additional Information

16. GENERATOR'S CERTIFICATION: I certify the materials described above on this manifest are not subject to federal regulations for reporting proper disposal of Hazardous Waste.

| | | |
|--|-----------------------------------|----------------------------|
| Printed/Typed Name RONALD GERBER | Signature <i>Ronald Gerber</i> | Month Day Year 08 03 94 |
|--|-----------------------------------|----------------------------|

| | | |
|--|--------------------------------|----------------------------|
| 17. Transporter 1 Acknowledgement of Receipt of Materials Printed/Typed Name <i>Pet Hurley</i> | Signature <i>Pet Hurley</i> | Month Day Year 08 03 94 |
|--|--------------------------------|----------------------------|

| | | |
|---|-----------|----------------|
| 18. Transporter 2 Acknowledgement of Receipt of Materials Printed/Typed Name | Signature | Month Day Year |
|---|-----------|----------------|

19. Discrepancy Indication Space

20. Facility Owner or Operator: Certification of receipt of waste materials covered by this manifest except as noted in Item 19.

| | | |
|--|-----------------------------------|----------------------------|
| Printed/Typed Name Will A Fisher | Signature <i>Will A Fisher</i> | Month Day Year 08 03 94 |
|--|-----------------------------------|----------------------------|

| | | | | |
|-------------------------------------|---|-----------------------|--------------|---------------------------|
| NON-HAZARDOUS WASTE MANIFEST | 1. Generator's US EPA ID No. NOT APPLICABLE | Manifest Document No. | 2. Page 1 of | Authorizaton No. 01216 |
|-------------------------------------|---|-----------------------|--------------|---------------------------|

3. Generator's Name and Mailing Address
 City of Emeryville Redevelopment Agency
 2200 Powell St.; 12th Floor
 Emeryville, CA 94608
 4. Generator's Phone (510) 596-4356 Attn: Ignacio Dayrit

5. Transporter 1 Company Name
 Northern Truck and Equipment
 6. US EPA ID Number
NOT APPLICABLE

7. Transporter 2 Company Name
 8. US EPA ID Number
NOT APPLICABLE

9. Designated Facility Name and Site Address
 B & J LANDFILL
 6426 HAY ROAD
 VACAVILLE, CA 95687
 10. US EPA ID Number
NOT APPLICABLE

A. Transporter's Phone (510) 429-8920
 B. Transporter's Phone
 C. Facility's Phone (707) 451-3276

| 11. Waste Shipping Name and Description | 12. Containers | | 13. Total Quantity | 14. Unit Wt/Vol |
|--|----------------|------|--------------------|-----------------|
| | No. | Type | | |
| a. Soil contaminated with petroleum hydrocarbons | 1 | T | 18 | Y |
| b. | . | . | . | . |
| c. | . | . | . | . |
| d. | . | . | . | . |

D. Additional Descriptions for Materials Listed Above
 Soil excavated from 40th Street UST Project
 4000 San Pablo Ave., Emeryville, CA

E. Handling Codes for Wastes Listed Above
 03

15. Special Handling Instructions and Additional Information

16. GENERATOR'S CERTIFICATION: I certify the materials described above on this manifest are not subject to federal regulations for reporting proper disposal of Hazardous Waste.

| | | |
|--|-----------------------------------|--------------------------------|
| Printed/Typed Name RONALD GERBER | Signature <i>Ronald Gerber</i> | Month Day Year 08 03 94 |
|--|-----------------------------------|--------------------------------|

17. Transporter 1 Acknowledgement of Receipt of Materials

| | | |
|---|------------------------------------|--------------------------------|
| Printed/Typed Name GLENN O. OLSON | Signature <i>Glenn O. Olson</i> | Month Day Year 08 03 94 |
|---|------------------------------------|--------------------------------|

18. Transporter 2 Acknowledgement of Receipt of Materials

| | | |
|--------------------|-----------|----------------|
| Printed/Typed Name | Signature | Month Day Year |
|--------------------|-----------|----------------|

19. Discrepancy Indication Space

20. Facility Owner or Operator: Certification of receipt of waste materials covered by this manifest except as noted in item 19.

| | | |
|---|----------------------------------|--------------------------------|
| Printed/Typed Name J. A. Fisher | Signature <i>J. A. Fisher</i> | Month Day Year 08 03 94 |
|---|----------------------------------|--------------------------------|

ORIGINAL RETURN TO GENERATOR

| | | | | | |
|--|--|---|-----------------------|---|---------------------------|
| NON-HAZARDOUS WASTE MANIFEST | | 1. Generator's US EPA ID No. NOT APPLICABLE | Manifest Document No. | 2. Page 1 of | Authorizaton No. 01216 |
| 3. Generator's Name and Mailing Address City of Emeryville Redevelopment Agency 2200 Powell St.; 12th Floor Emeryville, CA 94608 | | | | RSI- | |
| 4. Generator's Phone (510) 596-4356 Attn: Ignacio Dayrit | | | | | |
| 5. Transporter 1 Company Name Northern Truck and Equipment | | 6. US EPA ID Number NOT APPLICABLE | | 3113 1891 | |
| 7. Transporter 2 Company Name | | 8. US EPA ID Number NOT APPLICABLE | | | |
| 9. Designated Facility Name and Site Address B & J LANDFILL 6426 HAY ROAD VACAVILLE, CA 95687 | | 10. US EPA ID Number NOT APPLICABLE | | A. Transporter's Phone (510) 429-8920 B. Transporter's Phone C. Facility's Phone (707) 451-3276 | |
| 11. Waste Shipping Name and Description | | | | 12. Containers | 13. Total Quantity |
| a. Soil contaminated with petroleum hydrocarbons | | | | No. 1 | Type T |
| b. | | | | | |
| c. | | | | | |
| d. | | | | | |
| D. Additional Descriptions for Materials Listed Above Soil excavated from 40th Street UST Project 4000 San Pablo Ave., Emeryville, CA | | | | E. Handling Codes for Wastes Listed Above 03 | |
| 15. Special Handling Instructions and Additional Information | | | | | |
| 16. GENERATOR'S CERTIFICATION: I certify the materials described above on this manifest are not subject to federal regulations for reporting proper disposal of Hazardous Waste. | | | | | |
| Printed/Typed Name RONALD GERBER | | Signature <i>Ronald Gerber</i> | | Month Day Year 08 03 94 | |
| 17. Transporter 1 Acknowledgement of Receipt of Materials | | | | | |
| Printed/Typed Name JAMES ARNOLD | | Signature <i>James Arnold</i> | | Month Day Year 08 03 94 | |
| 18. Transporter 2 Acknowledgement of Receipt of Materials | | | | | |
| Printed/Typed Name | | Signature | | Month Day Year | |
| 19. Discrepancy Indication Space | | | | | |
| 20. Facility Owner or Operator: Certification of receipt of waste materials covered by this manifest except as noted in Item 19. | | | | | |
| Printed/Typed Name Jill A Fisher | | Signature <i>Jill A Fisher</i> | | Month Day Year 08 10 31 94 | |

ORIGINAL-RETURN TO GENERATOR

| | | | | | |
|---|--|---|---|---|---------------------------|
| NON-HAZARDOUS WASTE MANIFEST | | 1. Generator's US EPA ID No. NOT APPLICABLE | Manifest Document No. | 2. Page 1 of | Authorizaton No. 01216 |
| 3. Generator's Name and Mailing Address City of Emeryville Redevelopment Agency 2200 Powell St.; 12th Floor Emeryville, CA 94608 | | 4. Generator's Phone (510) 596-4356 | | Attn: Ignacio Dayrit | |
| 5. Transporter 1 Company Name Northern Truck and Equipment | | 6. US EPA ID Number NOT APPLICABLE | | 3113 | |
| 7. Transporter 2 Company Name | | 8. US EPA ID Number NOT APPLICABLE | | | |
| 9: Designated Facility Name and Site Address B & J LANDFILL 6426 HAY ROAD VACAVILLE, CA 95687 | | 10. US EPA ID Number NOT APPLICABLE | | A. Transporter's Phone (510) 429-8920 B. Transporter's Phone C. Facility's Phone (707) 451-3276 | |
| 11. Waste Shipping Name and Description | | | 12. Containers | 13. Total Quantity | 14. Unit Wt/Vol |
| a. Soil contaminated with petroleum hydrocarbons | | | No. 1 | Type T | 18 Y |
| b. | | | | | |
| c. | | | | | |
| d. | | | | | |
| D. Additional Descriptions for Materials Listed Above Soil excavated from 40th Street UST Project 4000 San Pablo Ave., Emeryville, CA | | | E. Handling Codes for Wastes Listed Above 03 | | |
| 15. Special Handling Instructions and Additional Information | | | | | |
| 16. GENERATOR'S CERTIFICATION: I certify the materials described above on this manifest are not subject to federal regulations or reporting proper disposal of Hazardous Waste. | | | | | |
| Printed/Typed Name RONALD GERBER | | Signature <i>Ronald Gerber</i> | | Month Day Year 10.8.94 | |
| 17. Transporter 1 Acknowledgement of Receipt of Materials Printed/Typed Name SIM BROOKS | | Signature <i>Sim Brooks</i> | | Month Day Year 10.8.94 | |
| 18. Transporter 2 Acknowledgement of Receipt of Materials Printed/Typed Name | | Signature | | Month Day Year | |
| 19. Discrepancy Indication Space | | | | | |
| 20. Facility Owner or Operator: Certification of receipt of waste materials covered by this manifest except as noted in Item 19. | | | | | |
| Printed/Typed Name MARY BORDEN | | Signature <i>Mary Borden</i> | | Month Day Year 10.8.94 | |

ORIGINAL-RETURN TO GENERATOR

| | | | | | |
|--|--|---|---|---|---------------------------|
| NON-HAZARDOUS WASTE MANIFEST | | 1. Generator's US EPA ID No. NOT APPLICABLE | Manifest Document No. | 2. Page 1 of | Authorizaton No. 01216 |
| 3. Generator's Name and Mailing Address City of Emeryville Redevelopment Agency 2200 Powell St.; 12th Floor Emeryville CA 94608 | | | | BIS | |
| 4. Generator's Phone (510) 596-4356 Attn: Ignacio Dayrit | | | | | |
| 5. Transporter 1 Company Name Northern Truck and Equipment | | 6. US EPA ID Number NOT APPLICABLE | | 3113 | |
| 7. Transporter 2 Company Name | | 8. US EPA ID Number NOT APPLICABLE | | | |
| 9. Designated Facility Name and Site Address B & J LANDFILL 6426 HAY ROAD VACAVILLE, CA 95687 | | 10. US EPA ID Number NOT APPLICABLE | | A. Transporter's Phone (510) 429-8920 B. Transporter's Phone C. Facility's Phone (707) 451-3276 | |
| 11. Waste Shipping Name and Description | | | 12. Containers | 13. Total Quantity | 14. Unit Wt/Vol |
| a. Soil contaminated with petroleum hydrocarbons | | | No. 1 | Type T | 18 Y |
| b. | | | | | |
| c. | | | | | |
| d. | | | | | |
| D. Additional Descriptions for Materials Listed Above Soil excavated from 40th Street UST Project 4000 San Pablo Ave., Emeryville, CA | | | E. Handling Codes for Wastes Listed Above 03 | | |
| 15. Special Handling Instructions and Additional Information | | | | | |
| 16. GENERATOR'S CERTIFICATION: I certify the materials described above on this manifest are not subject to federal regulations for reporting proper disposal of Hazardous Waste. | | | | | |
| Printed/Typed Name RONALD GERBER | | Signature <i>Ronald Gerber</i> | | Month 8 | Day 3 |
| 17. Transporter 1 Acknowledgement of Receipt of Materials | | Signature <i>Jack Bodin</i> | | Month 8 | Day 3 |
| Printed/Typed Name Jack Bodin | | Signature | | Month | Day |
| 18. Transporter 2 Acknowledgement of Receipt of Materials | | Signature | | Month | Day |
| Printed/Typed Name | | Signature | | Month | Day |
| 19. Discrepancy Indication Space | | | | | |
| 20. Facility Owner or Operator: Certification of receipt of waste materials covered by this manifest except as noted in Item 19. | | | | | |
| Printed/Typed Name MARY BODIN | | Signature <i>Mary Bodin</i> | | Month 8 | Day 3 |

ORIGINAL-RETURN TO GENERATOR

| | | | | | |
|--|--|---|---|---------------------------------------|---------------------------|
| NON-HAZARDOUS WASTE MANIFEST | | 1. Generator's US EPA ID No. NOT APPLICABLE | Manifest Document No. | 2. Page 1 of | Authorizaton No. 01216 |
| 3. Generator's Name and Mailing Address City of Emeryville Redevelopment Agency 2200 Powell St.; 12th Floor Emeryville, CA 94608 | | | | | |
| 4. Generator's Phone (510) 596-4356 Attn: Ignacio Dayrit | | | | | |
| 5. Transporter 1 Company Name Northern Truck and Equipment | | 6. US EPA ID Number NOT APPLICABLE | | 3118 B-11 | |
| 7. Transporter 2 Company Name | | 8. US EPA ID Number NOT APPLICABLE | | | |
| 9. Designated Facility Name and Site Address B & J LANDFILL 6426 HAY ROAD VACAVILLE, CA 95687 | | 10. US EPA ID Number NOT APPLICABLE | | A. Transporter's Phone (510) 429-8920 | |
| | | | | B. Transporter's Phone | |
| | | | | C. Facility's Phone (707) 451-3276 | |
| 11. Waste Shipping Name and Description | | | 12. Containers | 13. Total Quantity | 14. Unit Wtr/Vol |
| a. Soil contaminated with petroleum hydrocarbons | | | No. 1 | Type T | 18 |
| b. | | | | | |
| c. | | | | | |
| d. | | | | | |
| D. Additional Descriptions for Materials Listed Above Soil excavated from 40th Street UST Project 4000 San Pablo Ave., Emeryville, CA | | | E. Handling Codes for Wastes Listed Above 03 | | |
| 15. Special Handling Instructions and Additional Information | | | | | |
| 16. GENERATOR'S CERTIFICATION: I certify the materials described above on this manifest are not subject to federal regulations for reporting proper disposal of Hazardous Waste. | | | | | |
| Printed/Typed Name RONALD GERBER | | Signature <i>Ronald Gerber</i> | | Month Day Year 8 3 94 | |
| 17. Transporter 1 Acknowledgement of Receipt of Materials | | | | | |
| Printed/Typed Name DAN PARKS | | Signature <i>Dan Parks</i> | | Month Day Year 8 3 94 | |
| 18. Transporter 2 Acknowledgement of Receipt of Materials | | | | | |
| Printed/Typed Name | | Signature | | Month Day Year | |
| 19. Discrepancy Indication Space | | | | | |
| 20. Facility Owner or Operator: Certification of receipt of waste materials covered by this manifest except as noted in Item 19. | | | | | |
| Printed/Typed Name Will A Fisher | | Signature <i>Will A Fisher</i> | | Month Day Year 8 3 94 | |

ORIGINAL-RETURN TO GENERATOR

| | | | | | |
|--|--|---|---|---------------------------------------|---------------------------|
| NON-HAZARDOUS WASTE MANIFEST | | 1. Generator's US EPA ID No. NOT APPLICABLE | Manifest Document No. | 2. Page 1 of 1 | Authorizaton No. 01216 |
| 3. Generator's Name and Mailing Address City of Emeryville Redevelopment Agency 2200 Powell St.; 12th Floor Emeryville, CA 94608 | | | RSI | | |
| 4. Generator's Phone (510) 596-4356 Attn: Ignacio Dayrit | | | | | |
| 5. Transporter 1 Company Name Northern Truck and Equipment | 6. US EPA ID Number NOT APPLICABLE | | 511 TR# B-17 | | |
| 7. Transporter 2 Company Name | 8. US EPA ID Number NOT APPLICABLE | | | | |
| 9. Designated Facility Name and Site Address B & J LANDFILL 6426 HAY ROAD VACAVILLE, CA 95687 | | 10. US EPA ID Number NOT APPLICABLE | | A. Transporter's Phone (510) 429-8920 | |
| | | | | B. Transporter's Phone | |
| | | | | C. Facility's Phone (707) 451-3276 | |
| 11. Waste Shipping Name and Description | | | 12. Containers | 13. Total Quantity | 14. Unit Wt/Vol |
| a. Soil contaminated with petroleum hydrocarbons | | | No. 1 | Type T | 18 Y |
| b. | | | . | . | . |
| c. | | | . | . | . |
| d. | | | . | . | . |
| D. Additional Descriptions for Materials Listed Above Soil excavated from 40th Street UST Project 4000 San Pablo Ave., Emeryville, CA | | | E. Handling Codes for Wastes Listed Above 03 | | |
| 15. Special Handling Instructions and Additional Information | | | | | |
| 16. GENERATOR'S CERTIFICATION: I certify the materials described above on this manifest are not subject to federal regulations for reporting proper disposal of Hazardous Waste. | | | | | |
| Printed/Typed Name Ronald Gerber | | Signature <i>Ronald Gerber</i> | | Month Day Year 8 3 94 | |
| 17. Transporter 1 Acknowledgement of Receipt of Materials | | | | | |
| Printed/Typed Name Michael Taylor | | Signature <i>Michael Taylor</i> | | Month Day Year 8 3 94 | |
| 18. Transporter 2 Acknowledgement of Receipt of Materials | | | | | |
| Printed/Typed Name | | Signature | | Month Day Year | |
| 19. Discrepancy Indication Space | | | | | |
| 20. Facility Owner or Operator: Certification of receipt of waste materials covered by this manifest except as noted in Item 19. | | | | | |
| Printed/Typed Name Mary Borders | | Signature <i>Mary Borders</i> | | Month Day Year 8 3 94 | |

ORIGINAL-RETURN TO GENERATOR

| | | | | | |
|--|--|---|-----------------------|---|---------------------------|
| NON-HAZARDOUS WASTE MANIFEST | | 1. Generator's US EPA ID No. NOT APPLICABLE | Manifest Document No. | 2. Page 1 of | Authorizaton No. 01216 |
| 3. Generator's Name and Mailing Address City of Emeryville Redevelopment Agency 2200 Powell St.; 12th Floor Emeryville CA 94608 | | | | RSI | |
| 4. Generator's Phone (510) 596-4356 Attn: Ignacio Dayrit | | | | | |
| 5. Transporter 1 Company Name Northern Truck and Equipment | | 6. US EPA ID Number NOT APPLICABLE | | 3113 | |
| 7. Transporter 2 Company Name | | 8. US EPA ID Number NOT APPLICABLE | | | |
| 9. Designated Facility Name and Site Address B & J LANDFILL 6426 HAY ROAD VACAVILLE, CA 95687 | | 10. US EPA ID Number NOT APPLICABLE | | A. Transporter's Phone (510) 429-8920 B. Transporter's Phone C. Facility's Phone (707) 451-3276 | |
| 11. Waste Shipping Name and Description | | | | 12. Containers | 13. Total Quantity |
| a. Soil contaminated with petroleum hydrocarbons | | | | No. Type | 14. Unit Wt/Vol |
| | | | | 1 1 T | 18 Y |
| b. | | | | | |
| c. | | | | | |
| d. | | | | | |
| D. Additional Descriptions for Materials Listed Above Soil excavated from 40th Street UST Project 4000 San Pablo Ave., Emeryville, CA | | | | E. Handling Codes for Wastes Listed Above 03 | |
| 15. Special Handling Instructions and Additional Information | | | | | |
| 16. GENERATOR'S CERTIFICATION: I certify the materials described above on this manifest are not subject to federal regulations for reporting proper disposal of Hazardous Waste. | | | | | |
| Printed/Typed Name Ronald Gerber | | Signature <i>Ronald Gerber</i> | | Month Day Year 8 3 94 | |
| 17. Transporter 1 Acknowledgement of Receipt of Materials | | Printed/Typed Name Tom King | | Signature <i>Tom King</i> | |
| 18. Transporter 2 Acknowledgement of Receipt of Materials | | Printed/Typed Name Kevin Trucking | | Signature <i>Kevin Trucking</i> | |
| 19. Discrepancy Indication Space | | | | | |
| 20. Facility Owner or Operator: Certification of receipt of waste materials covered by this manifest except as noted in Item 19. | | | | | |
| Printed/Typed Name MARY BORDER | | Signature <i>Mary Border</i> | | Month Day Year 10 10 94 | |

ORIGINAL-RETURN TO GENERATOR

| | | | | | |
|--|--|--|---|---|---------------------------|
| NON-HAZARDOUS WASTE MANIFEST | | 1. Generator's US EPA ID No. NOT APPLICABLE | Manifest Document No. | 2. Page 1 of | Authorizaton No. 01216 |
| 3. Generator's Name and Mailing Address City of Emeryville Redevelopment Agency 2200 Powell St.; 12th Floor Emeryville, CA 94608 | | 4. Generator's Phone (510) 596-4356 Attn: Ignacio Dayrit | | | |
| 5. Transporter 1 Company Name Northern Truck and Equipment | 6. US EPA ID Number NOT APPLICABLE | 7. Transporter 2 Company Name | | 8. US EPA ID Number NOT APPLICABLE | 3113 |
| 9. Designated Facility Name and Site Address B & J LANDFILL 6426 HAY ROAD VACAVILLE, CA 95687 | | 10. US EPA ID Number NOT APPLICABLE | | A. Transporter's Phone (510) 429-8920 B. Transporter's Phone C. Facility's Phone (707) 451-3276 | |
| 11. Waste Shipping Name and Description | | | 12. Containers | 13. Total Quantity | 14. Unit Wt/Vol |
| a. Soil contaminated with petroleum hydrocarbons | | | No. 1 | Type T | 18 Y |
| b. | | | | | |
| c. | | | | | |
| d. | | | | | |
| D. Additional Descriptions for Materials Listed Above Soil excavated from 40th Street UST Project 4000 San Pablo Ave., Emeryville, CA | | | E. Handling Codes for Wastes Listed Above 03 | | |
| 15. Special Handling Instructions and Additional Information | | | | | |
| 16. GENERATOR'S CERTIFICATION: I certify the materials described above on this manifest are not subject to federal regulations for reporting proper disposal of Hazardous Waste. | | | | | |
| Printed/Typed Name RONALD GERBER | | Signature <i>Ronald Gerber</i> | | Month Day Year 8 3 94 | |
| 17. Transporter 1 Acknowledgement of Receipt of Materials Printed/Typed Name ARNOLD PADIJA | | Signature <i>Arnold Padja</i> | | Month Day Year 10 03 94 | |
| 18. Transporter 2 Acknowledgement of Receipt of Materials Printed/Typed Name | | Signature | | Month Day Year | |
| 19. Discrepancy Indication Space | | | | | |
| 20. Facility Owner or Operator: Certification of receipt of waste materials covered by this manifest except as noted in Item 19. | | | | | |
| Printed/Typed Name MARY BORDEN | | Signature <i>Mary Borden</i> | | Month Day Year 10 03 94 | |

ORIGINAL-RETURN TO GENERATOR

**NON-HAZARDOUS
 WASTE MANIFEST**

1. Generator's US EPA ID No.
 NOT APPLICABLE

Manifest Document No.

2. Page 1 of

Authorizaton No.
 01216

3. Generator's Name and Mailing Address
 City of Emeryville Redevelopment Agency
 2200 Powell St.; 12th Floor
 Emeryville CA 94608
 4. Generator's Phone (510) 596-4356 Attn: Ignacio Dayrit

RSI

5. Transporter 1 Company Name
 Northern Truck and Equipment
 6. US EPA ID Number
 NOT APPLICABLE

3113

7. Transporter 2 Company Name
 8. US EPA ID Number
 NOT APPLICABLE

9. Designated Facility Name and Site Address
 B & J LANDFILL
 6426 HAY ROAD
 VACAVILLE, CA 95687
 10. US EPA ID Number
 NOT APPLICABLE

A. Transporter's Phone (510) 429-8920
 B. Transporter's Phone
 C. Facility's Phone (707) 451-3276

11. Waste Shipping Name and Description

a. Soil contaminated with petroleum hydrocarbons

| 12. Containers | | 13. Total Quantity | 14. Unit Wt/Val |
|----------------|------|--------------------|-----------------|
| No. | Type | | |
| 1 | T | 18 | Y |
| | | | |
| | | | |
| | | | |
| | | | |

D. Additional Descriptions for Materials Listed Above
 Soil excavated from 40th Street UST Project
 4000 San Pablo Ave., Emeryville, CA

E. Handling Codes for Wastes Listed Above
 03

15. Special Handling Instructions and Additional Information

16. GENERATOR'S CERTIFICATION: I certify the materials described above on this manifest are not subject to federal regulation for reporting proper disposal of Hazardous Waste.

Printed/Typed Name: RONALD GERBER
 Signature: *Ronald Gerber*
 Month: 8 Day: 3 Year: 94

17. Transporter 1 Acknowledgement of Receipt of Materials
 Printed/Typed Name: _____
 Signature: _____
 Month: _____ Day: _____ Year: _____

18. Transporter 2 Acknowledgement of Receipt of Materials
 Printed/Typed Name: _____
 Signature: _____
 Month: _____ Day: _____ Year: _____

19. Discrepancy Indication Space
 Printed/Typed Name: _____
 Signature: _____
 Month: 8 Day: 3 Year: 94

20. Facility Owner or Operator: Certification of receipt of waste materials covered by this manifest except as noted in Item 19.

Printed/Typed Name: MARY BORDEL
 Signature: *Mary Bordel*
 Month: 08 Day: 03 Year: 94

GENERATOR

TRANSPORTER

FACILITY

| | | | | | |
|--|--|---|---|----------------------------|---------------------------|
| NON-HAZARDOUS WASTE MANIFEST | | 1. Generator's US EPA ID No. NOT APPLICABLE | Manifest Document No. | 2. Page 1 of | Authorizaton No. 01216 |
| 3. Generator's Name and Mailing Address City of Emeryville Redevelopment Agency 2200 Powell St.; 12th Floor Emeryville, CA 94608 | | | | | |
| 4. Generator's Phone (510) 596-4356 Attn: Ignacio Dayrit | | | | | |
| 5. Transporter 1 Company Name Northern Truck and Equipment | 6. US EPA ID Number NOT APPLICABLE | 3113 | 385 | | |
| 7. Transporter 2 Company Name | 8. US EPA ID Number NOT APPLICABLE | | | | |
| 9. Designated Facility Name and Site Address B & J LANDFILL 6426 HAY ROAD VACAVILLE, CA 95687 | | 10. US EPA ID Number NOT APPLICABLE | A. Transporter's Phone (510) 429-8920 B. Transporter's Phone C. Facility's Phone (707) 451-3276 | | |
| 11. Waste Shipping Name and Description | | 12. Containers | | 13. Total Quantity | 14. Unit Wt/Vol |
| a. Soil contaminated with petroleum hydrocarbons | | No. 1 | Type T | 18 | Y |
| b. | | | | | |
| c. | | | | | |
| d. | | | | | |
| D. Additional Descriptions for Materials Listed Above Soil excavated from 40th Street UST Project 4000 San Pablo Ave., Emeryville, CA | | E. Handling Codes for Wastes Listed Above 03 | | | |
| 15. Special Handling Instructions and Additional Information | | | | | |
| 16. GENERATOR'S CERTIFICATION: I certify the materials described above on this manifest are not subject to federal regulations for reporting proper disposal of Hazardous Waste. | | | | | |
| Printed/Typed Name RONALD GERBER | | Signature <i>Ronald Gerber</i> | | Month Day Year 8 3 96 | |
| 17. Transporter 1 Acknowledgement of Receipt of Materials Printed/Typed Name Dore Koc | | Signature <i>Dore Koc</i> | | Month Day Year 08 03 96 | |
| 18. Transporter 2 Acknowledgement of Receipt of Materials Printed/Typed Name | | Signature | | Month Day Year | |
| 19. Discrepancy Indication Space | | | | | |
| 20. Facility Owner or Operator: Certification of receipt of waste materials covered by this manifest except as noted in Item 19. | | | | | |
| Printed/Typed Name MARY BORDEN | | Signature <i>Mary Borden</i> | | Month Day Year | |

GENERATOR

TRANSPORTER

FACILITY

**NON-HAZARDOUS
 WASTE MANIFEST**

1. Generator's US EPA ID No.
 NOT APPLICABLE

Manifest Document No.

2. Page 1 of

Authorizaton No.
 01216

3. Generator's Name and Mailing Address
 City of Emeryville Redevelopment Agency
 2200 Powell St.; 12th Floor
 Emeryville, CA 94608

4. Generator's Phone (510) 596-4356 Attn: Ignacio Dayrit

5. Transporter 1 Company Name
 Northern Truck and Equipment

6. US EPA ID Number
 NOT APPLICABLE

7. Transporter 2 Company Name

8. US EPA ID Number
 NOT APPLICABLE

9. Designated Facility Name and Site Address

B & J LANDFILL
 6426 HAY ROAD
 VACAVILLE, CA 95687

10. US EPA ID Number
 NOT APPLICABLE

A. Transporter's Phone (510) 429-8920

B. Transporter's Phone

C. Facility's Phone
 (707) 451-3276

11. Waste Shipping Name and Description

a. Soil contaminated with petroleum hydrocarbons

| 12. Containers | | 13. Total Quantity | 14. Unit Wt/Vol |
|----------------|------|--------------------|-----------------|
| No. | Type | | |
| 1 | T | 18 | Y |
| | | | |
| | | | |
| | | | |
| | | | |

D. Additional Descriptions for Materials Listed Above

Soil excavated from 40th Street UST Project
 4000 San Pablo Ave., Emeryville, CA

E. Handling Codes for Wastes Listed Above

03

15. Special Handling Instructions and Additional Information

16. GENERATOR'S CERTIFICATION: I certify the materials described above on this manifest are not subject to federal regulations for reporting proper disposal of Hazardous Waste.

Printed/Typed Name
 RONALD GERBER

Signature
 Ronald Gerber
 Month Day Year
 8 3 94

17. Transporter 1 Acknowledgement of Receipt of Materials

Printed/Typed Name
 EDWARD A. ROUSE

Signature
 Edward A. Rouse
 Month Day Year
 08 03 94

18. Transporter 2 Acknowledgement of Receipt of Materials

Printed/Typed Name

Signature
 Month Day Year

19. Discrepancy Indication Space

20. Facility Owner or Operator: Certification of receipt of waste materials covered by this manifest except as noted in Item 19.

Printed/Typed Name
 MARY BORDEN

Signature
 Mary Borden
 Month Day Year
 10 10 94

ORIGINAL-RETURN TO GENERATOR

**NON-HAZARDOUS
 WASTE MANIFEST**

1. Generator's US EPA ID No. **NOT APPLICABLE** Manifest Document No. 2. Page 1 of 1 Authorizaton No. 01216

3. Generator's Name and Mailing Address
 City of Emeryville Redevelopment Agency
 2200 Powell St.; 12th Floor
 Emeryville, CA 94608
 4. Generator's Phone (510) 596-4356 Attn: Ignacio Dayrit

5. Transporter 1 Company Name
 Northern Truck and Equipment
 6. US EPA ID Number **NOT APPLICABLE** 3113

7. Transporter 2 Company Name
 8. US EPA ID Number **NOT APPLICABLE**

9. Designated Facility Name and Site Address
 B & J LANDFILL
 6426 HAY ROAD
 VACAVILLE, CA 95687
 10. US EPA ID Number **NOT APPLICABLE**

A. Transporter's Phone (510) 429-8920
 B. Transporter's Phone
 C. Facility's Phone (707) 451-3276

| 11. Waste Shipping Name and Description | 12. Containers | | 13. Total Quantity | 14. Unit Wt/Vol |
|--|----------------|------|--------------------|-----------------|
| | No. | Type | | |
| a. Soil contaminated with petroleum hydrocarbons | 1 | T | 13 | Y |
| b. | | | | |
| c. | | | | |
| d. | | | | |

D. Additional Descriptions for Materials Listed Above
 Soil excavated from 40th Street UST Project
 4000 San Pablo Ave., Emeryville, CA

E. Handling Codes for Wastes Listed Above
 03

15. Special Handling Instructions and Additional Information

16. GENERATOR'S CERTIFICATION: I certify the materials described above on this manifest are not subject to federal regulations for reporting proper disposal of Hazardous Waste.

Printed/Typed Name: Ronald Gerson Signature: Ronald Gerson Month: 8 Day: 3 Year: 94

17. Transporter 1 Acknowledgement of Receipt of Materials
 Printed/Typed Name: John Dulla Signature: John Dulla Month: 08 Day: 03 Year: 94

18. Transporter 2 Acknowledgement of Receipt of Materials
 Printed/Typed Name: _____ Signature: _____ Month: _____ Day: _____ Year: _____

19. Discrepancy Indication Space

20. Facility Owner or Operator: Certification of receipt of waste materials covered by this manifest except as noted in Item 19.

Printed/Typed Name: MARY BORDER Signature: Mary Border Month: 08 Day: 03 Year: 94

**NON-HAZARDOUS
 WASTE MANIFEST**

1. Generator's US EPA ID No.
 NOT APPLICABLE

Manifest Document No.

2. Page 1 of

Authorizaton No.
 01216

3. Generator's Name and Mailing Address
 City of Emeryville Redevelopment Agency
 2200 Powell St.; 12th Floor
 Emeryville CA 94608
 4. Generator's Phone (510) 596-4356 Attn: Ignacio Dayrit

RSI

5. Transporter 1 Company Name
 Northern Truck and Equipment
 6. US EPA ID Number
 NOT APPLICABLE

3113 - 291

7. Transporter 2 Company Name
 8. US EPA ID Number
 NOT APPLICABLE

9. Designated Facility Name and Site Address
 B & J LANDFILL
 6426 HAY ROAD
 VACAVILLE, CA 95687
 10. US EPA ID Number
 NOT APPLICABLE

A. Transporter's Phone (510) 429-8920

B. Transporter's Phone

C. Facility's Phone
 (707) 451-3276

11. Waste Shipping Name and Description

| 12. Containers | | 13. Total Quantity | 14. Unit Wt/Vol |
|----------------|------|--------------------|-----------------|
| No. | Type | | |
| 1 | T | 18 | Y |
| . | . | . | . |
| . | . | . | . |
| . | . | . | . |

a. Soil contaminated with petroleum hydrocarbons

b.

c.

d.

D. Additional Descriptions for Materials Listed Above
 Soil excavated from 40th Street UST Project
 4000 San Pablo Ave., Emeryville, CA

E. Handling Codes for Wastes Listed Above

03

15. Special Handling Instructions and Additional Information

16. GENERATOR'S CERTIFICATION: I certify the materials described above on this manifest are not subject to federal regulations for reporting proper disposal of Hazardous Waste.

Printed/Typed Name
 RONALD GERBER

Signature
Ronald Gerber

Month Day Year
 8 3 94

17. Transporter 1 Acknowledgement of Receipt of Materials

Printed/Typed Name
 Pat Hurley

Signature
Pat Hurley

Month Day Year
 8 23 94

18. Transporter 2 Acknowledgement of Receipt of Materials

Printed/Typed Name

Signature

Month Day Year

19. Discrepancy Indication Space

20. Facility Owner or Operator: Certification of receipt of waste materials covered by this manifest except as noted in item 19.

Printed/Typed Name
 MARY BORDEN

Signature
Mary Borden

Month Day Year
 8 03 94

GENERATOR

TRANSPORTER

FACILITY

| | | | | | |
|--|--|---|---------------------------------------|------------------------------------|---------------------------|
| NON-HAZARDOUS WASTE MANIFEST | | 1. Generator's US EPA ID No. NOT APPLICABLE | Manifest Document No. | 2. Page 1 of | Authorizaton No. 01216 |
| 3. Generator's Name and Mailing Address City of Emeryville Redevelopment Agency 2200 Powell St.; 12th Floor Emeryville, CA 94608 | | | | RSI | |
| 4. Generator's Phone (510) 596-4356 Attn: Ignacio Dayrit | | | | | |
| 5. Transporter 1 Company Name Northern Truck and Equipment | 6. US EPA ID Number NOT APPLICABLE | | | 3143 589 | |
| 7. Transporter 2 Company Name | 8. US EPA ID Number NOT APPLICABLE | | | | |
| 9. Designated Facility Name and Site Address B & J LANDFILL 6426 HAY ROAD VACAVILLE, CA 95687 | | 10. US EPA ID Number NOT APPLICABLE | A. Transporter's Phone (510) 429-8920 | | B. Transporter's Phone |
| | | | | C. Facility's Phone (707) 451-3276 | |
| 11. Waste Shipping Name and Description | | 12. Containers | 13. Total Quantity | 14. Unit Wt/Vol | |
| a. Soil contaminated with petroleum hydrocarbons | | No. 1 | Type T | 18 | Y |
| b. | | | | | |
| c. | | | | | |
| d. | | | | | |
| D. Additional Descriptions for Materials Listed Above Soil excavated from 40th Street UST Project 4000 San Pablo Ave., Emeryville, CA | | E. Handling Codes for Wastes Listed Above 03 | | | |
| 15. Special Handling Instructions and Additional Information | | | | | |
| 16. GENERATOR'S CERTIFICATION: I certify the materials described above on this manifest are not subject to federal regulations for reporting proper disposal of Hazardous Waste. | | | | | |
| Printed/Typed Name RONALD GERBER | | Signature <i>Ronald Gerber</i> | | Month 08 | Day 03 |
| 17. Transporter 1 Acknowledgement of Receipt of Materials | | Signature <i>Ignacio Dayrit</i> | | Year 94 | |
| Printed/Typed Name Ignacio Dayrit | | Signature | | Month 08 | Day 03 |
| 18. Transporter 2 Acknowledgement of Receipt of Materials | | Signature | | Year 94 | |
| Printed/Typed Name | | Signature | | Month | Day |
| 19. Discrepancy Indication Space | | | | | |
| 20. Facility Owner or Operator: Certification of receipt of waste materials covered by this manifest except as noted in Item 19. | | | | | |
| Printed/Typed Name Jill A. Fisher | | Signature <i>Jill A. Fisher</i> | | Month 08 | Day 03 |
| | | | | Year 94 | |

ORIGINAL-RETURN TO GENERATOR

GENERATOR
TRANSPORTER
FACILITY

**NON-HAZARDOUS
 WASTE MANIFEST**

1. Generator's US EPA ID No.
 NOT APPLICABLE

Manifest Document No.

2. Page 1 of

Authorizaton No.
 01216

3. Generator's Name and Mailing Address
 City of Emeryville Redevelopment Agency
 2200 Powell St., 12th Floor
 Emeryville CA 94608

4. Generator's Phone (510) 596-4356 Attn: Ignacio Dayrit

5. Transporter 1 Company Name
 Northern Truck and Equipment

6. US EPA ID Number
 NOT APPLICABLE

7. Transporter 2 Company Name

8. US EPA ID Number
 NOT APPLICABLE

9. Designated Facility Name and Site Address

B & J LANDFILL
 6426 HAY ROAD
 VACAVILLE, CA 95687

10. US EPA ID Number
 NOT APPLICABLE

A. Transporter's Phone (510)429-8920

B. Transporter's Phone

C. Facility's Phone
 (707) 451-3276

11. Waste Shipping Name and Description

a. Soil contaminated with petroleum hydrocarbons

| 12. Containers | | 13. Total Quantity | 14. Unit Wt/Vol |
|----------------|------|--------------------|-----------------|
| No. | Type | | |
| 1 | T | 18 | Y |
| .. | . | .. | .. |
| .. | . | .. | .. |
| .. | . | .. | .. |
| .. | . | .. | .. |

D. Additional Descriptions for Materials Listed Above
 Soil excavated from 40th Street UST Project
 4000 San Pablo Ave., Emeryville, CA

E. Handling Codes for Wastes Listed Above

03

15. Special Handling Instructions and Additional Information

16. GENERATOR'S CERTIFICATION: I certify the materials described above on this manifest are not subject to federal regulations for reporting proper disposal of Hazardous Waste.

Printed/Typed Name

RONALD GERBER

Signature

Ronald Gerber

Month Day Year

08 | 03 | 94

17. Transporter 1 Acknowledgement of Receipt of Materials

Printed/Typed Name

JACK BOLENA

Signature

Jack Boleno

Month Day Year

08 | 03 | 94

18. Transporter 2 Acknowledgement of Receipt of Materials

Printed/Typed Name

Signature

Month Day Year

19. Discrepancy Indication Space

20. Facility Owner or Operator: Certification of receipt of waste materials covered by this manifest except as noted in Item 19.

Printed/Typed Name

W. W. Fisher

Signature

W. W. Fisher

Month Day Year

08 | 03 | 94

ORIGINAL-RETURN TO GENERATOR

| | | | | | |
|--|--|---|---------------------------------------|--------------------------------|---------------------------|
| NON-HAZARDOUS WASTE MANIFEST | | 1. Generator's US EPA ID No. NOT APPLICABLE | Manifest Document No. | 2. Page 1 of | Authorizaton No. 01216 |
| 3. Generator's Name and Mailing Address City of Emeryville Redevelopment Agency 2200 Powell St., 12th Floor Emeryville CA 94608 | | | | | |
| 4. Generator's Phone (510) 596-4356 Attn: Ignacio Dayrit | | | | | |
| 5. Transporter 1 Company Name Northern Truck and Equipment | 6. US EPA ID Number NOT APPLICABLE | 3113 | B-11 | | |
| 7. Transporter 2 Company Name | 8. US EPA ID Number NOT APPLICABLE | | | | |
| 9. Designated Facility Name and Site Address B & J LANDFILL 6426 HAY ROAD VACAVILLE, CA 95687 | | 10. US EPA ID Number NOT APPLICABLE | A. Transporter's Phone (510) 429-8920 | | |
| | | | B. Transporter's Phone | | |
| | | | C. Facility's Phone (707) 451-3276 | | |
| 11. Waste Shipping Name and Description | | 12. Containers | 13. Total Quantity | 14. Unit Wt/Vol | |
| a. Soil contaminated with petroleum hydrocarbons | | No. Type | | Y | |
| | | 1 1 T | 18 | | |
| b. | | | | | |
| c. | | | | | |
| d. | | | | | |
| D. Additional Descriptions for Materials Listed Above Soil excavated from 40th Street UST Project 4000 San Pablo Ave., Emeryville, CA | | E. Handling Codes for Wastes Listed Above 03 | | | |
| 15. Special Handling Instructions and Additional Information | | | | | |
| 16. GENERATOR'S CERTIFICATION: I certify the materials described above on this manifest are not subject to federal regulations for reporting proper disposal of Hazardous Waste. | | | | | |
| Printed/Typed Name RONALD GERBER | | Signature <i>Ronald Gerber</i> | | Month Day Year 08 03 94 | |
| 17. Transporter 1 Acknowledgement of Receipt of Materials | | Printed/Typed Name DAN PARKS | | Signature <i>Dan Parks</i> | |
| 18. Transporter 2 Acknowledgement of Receipt of Materials | | Printed/Typed Name | | Signature | |
| 19. Discrepancy Indication Space | | | | | |
| 20. Facility Owner or Operator: Certification of receipt of waste materials covered by this manifest except as noted in Item 19. | | | | | |
| Printed/Typed Name Bill A Fisher | | Signature <i>Bill A Fisher</i> | | Month Day Year 08 03 94 | |

GENERATOR
TRANSPORTER
FACILITY

**NON-HAZARDOUS
WASTE MANIFEST**

1. Generator's US EPA ID No.
NOT APPLICABLE

Manifest Document No.

2. Page 1 of

Authorizaton No.
01216

3. Generator's Name and Mailing Address
City of Emeryville Redevelopment Agency
2200 Powell St.; 12th Floor
Emeryville CA 94608
4. Generator's Phone (510) 596-4356 Attn: Ignacio Dayrit

191

5. Transporter 1 Company Name
Northern Truck and Equipment
6. US EPA ID Number
NOT APPLICABLE

~~3118~~

7. Transporter 2 Company Name
8. US EPA ID Number
NOT APPLICABLE

9. Designated Facility Name and Site Address
B & J LANDFILL
6426 HAY ROAD
VACAVILLE, CA 95687
10. US EPA ID Number
NOT APPLICABLE

A. Transporter's Phone (510)429-8920

B. Transporter's Phone

C. Facility's Phone
(707) 451-3276

11. Waste Shipping Name and Description

| 12. Containers | | 13. Total Quantity | 14. Unit Wt/Vol |
|----------------|------|--------------------|-----------------|
| No. | Type | | |
| 1 | T | 18 | Y |
| . | . | . | . |
| . | . | . | . |
| . | . | . | . |
| . | . | . | . |

a. Soil contaminated with petroleum hydrocarbons

b.

c.

d.

D. Additional Descriptions for Materials Listed Above
Soil excavated from 40th Street UST Project
4000 San Pablo Ave., Emeryville, CA

E. Handling Codes for Wastes Listed Above
03

15. Special Handling Instructions and Additional Information

16. GENERATOR'S CERTIFICATION: I certify the materials described above on this manifest are not subject to federal regulations for reporting proper disposal of Hazardous Waste.

Printed/Typed Name
RONALD GERBER

Signature
Ronald Gerber
Month Day Year
08 03 94

17. Transporter 1 Acknowledgement of Receipt of Materials
Printed/Typed Name
JAMES ARNOLD

Signature
James Arnold
Month Day Year
08 03 94

18. Transporter 2 Acknowledgement of Receipt of Materials
Printed/Typed Name

Signature
Month Day Year

19. Discrepancy Indication Space

20. Facility Owner or Operator: Certification of receipt of waste materials covered by this manifest except as noted in item 19.

Printed/Typed Name
M.A. Fisher

Signature
M.A. Fisher
Month Day Year
08 03 94

GENERATOR

TRANSPORTER

FACILITY

**NON-HAZARDOUS
 WASTE MANIFEST**

1. Generator's US EPA ID No.
 NOT APPLICABLE

Manifest Document No.

2. Page 1 of

Authorizaton No.
 01216

3. Generator's Name and Mailing Address
 City of Emeryville Redevelopment Agency
 2200 Powell St.; 12th Floor
 Emeryville, CA 94608
 4. Generator's Phone (510) 596-4356 Attn: Ignacio Dayrit

RSI

5. Transporter 1 Company Name
 Northern Truck and Equipment
 6. US EPA ID Number
 NOT APPLICABLE

3113

7. Transporter 2 Company Name
 8. US EPA ID Number
 NOT APPLICABLE

9. Designated Facility Name and Site Address
 B & J LANDFILL
 6426 HAY ROAD
 VACAVILLE, CA 95687
 10. US EPA ID Number
 NOT APPLICABLE

A. Transporter's Phone (510)429-8920

B. Transporter's Phone

C. Facility's Phone
 (707) 451-3276

11. Waste Shipping Name and Description

| 12. Containers | | 13. Total Quantity | 14. Unit Wt/Vol | | |
|----------------|---|--------------------|-----------------|----|---|
| No. | Type | | | | |
| a. | Soil contaminated with petroleum hydrocarbons | 1 | T | 18 | Y |
| b. | | | | | |
| c. | | | | | |
| d. | | | | | |

D. Additional Descriptions for Materials Listed Above
 Soil excavated from 40th Street UST Project
 4000 San Pablo Ave., Emeryville, CA

E. Handling Codes for Wastes Listed Above

03

15. Special Handling Instructions and Additional Information

16. GENERATOR'S CERTIFICATION: I certify the materials described above on this manifest are not subject to federal regulations for reporting proper disposal of Hazardous Waste.

Printed/Typed Name: RONALD GERBER
 Signature: Ronald Gerber
 Month Day Year: 08 03 94

17. Transporter 1 Acknowledgement of Receipt of Materials
 Printed/Typed Name: Jim Brooks
 Signature: Jim Brooks
 Month Day Year: 08 03 94

18. Transporter 2 Acknowledgement of Receipt of Materials
 Printed/Typed Name:
 Signature:
 Month Day Year:

19. Discrepancy Indication Space

20. Facility Owner or Operator: Certification of receipt of waste materials covered by this manifest except as noted in Item 19.

Printed/Typed Name: MARY BODLEY
 Signature: Mary Bodley
 Month Day Year: 08 03 94

GENERATOR

TRANSPORTER

FACILITY

| | | | | | |
|--|--|--|---|--|---------------------------|
| NON-HAZARDOUS WASTE MANIFEST | | 1. Generator's US EPA ID No. NOT APPLICABLE | Manifest Document No. | 2. Page 1 of | Authorizaton No. 01216 |
| 3. Generator's Name and Mailing Address City of Emeryville Redevelopment Agency 2200 Powell St.; 12th Floor Emeryville, CA 94608 | | 4. Generator's Phone (510) 596-4356 Attn: Ignacio Dayrit | | RSI B-17 | |
| 5. Transporter 1 Company Name Northern Truck and Equipment | | 6. US EPA ID Number NOT APPLICABLE | | | |
| 7. Transporter 2 Company Name | | 8. US EPA ID Number NOT APPLICABLE | | | |
| 9. Designated Facility Name and Site Address B & J LANDFILL 6426 HAY ROAD VACAVILLE, CA 95687 | | 10. US EPA ID Number NOT APPLICABLE | | A. Transporter's Phone (510)429-8920 B. Transporter's Phone C. Facility's Phone (707) 451-3276 | |
| 11. Waste Shipping Name and Description | | | 12. Containers | 13. Total Quantity | 14. Unit Wt/Vol |
| a. Soil contaminated with petroleum hydrocarbons | | | No. 1 | Type T | 18 Y |
| b. | | | | | |
| c. | | | | | |
| d. | | | | | |
| D. Additional Descriptions for Materials Listed Above Soil excavated from 40th Street UST Project 4000 San Pablo Ave., Emeryville, CA | | | E. Handling Codes for Wastes Listed Above 03 | | |
| 15. Special Handling Instructions and Additional Information | | | | | |
| 16. GENERATOR'S CERTIFICATION: I certify the materials described above on this manifest are not subject to federal regulations for reporting proper disposal of Hazardous Waste. | | | | | |
| Printed/Typed Name RONALD GERBER | | Signature <i>Ronald Gerber</i> | | Month Day Year 08 03 94 | |
| 17. Transporter 1 Acknowledgement of Receipt of Materials | | Printed/Typed Name Michael Taylor | | Signature <i>Michael Taylor</i> | |
| 18. Transporter 2 Acknowledgement of Receipt of Materials | | Printed/Typed Name | | Signature | |
| 19. Discrepancy Indication Space | | | | | |
| 20. Facility Owner or Operator: Certification of receipt of waste materials covered by this manifest except as noted in Item 19. | | | | | |
| Printed/Typed Name Mary Borden | | Signature <i>Mary Borden</i> | | Month Day Year 10 23 94 | |

ORIGINAL-RETURN TO GENERATOR

| NON-HAZARDOUS WASTE MANIFEST | | 1. Generator's US EPA ID No. NOT APPLICABLE | Manifest Document No. | 2. Page 1 of | Authorizaton No. 01216 |
|--|--|--|-----------------------|---|---------------------------|
| 3. Generator's Name and Mailing Address City of Emeryville Redevelopment Agency 2200 Powell St.; 12th Floor Emeryville, CA 94608 | | 4. Generator's Phone (510) 596-4356 Attn: Ignacio Dayrit | | RS / BY | |
| 5. Transporter 1 Company Name Northern Truck and Equipment | | 6. US EPA ID Number NOT APPLICABLE | | | |
| 7. Transporter 2 Company Name | | 8. US EPA ID Number NOT APPLICABLE | | A. Transporter's Phone (510) 429-8920 B. Transporter's Phone C. Facility's Phone (707) 451-3276 | |
| 9. Designated Facility Name and Site Address B & J LANDFILL 6426 HAY ROAD VACAVILLE, CA 95687 | | 10. US EPA ID Number NOT APPLICABLE | | | |
| 11. Waste Shipping Name and Description | | 12. Containers | | 13. Total Quantity | 14. Unit Wt/Vol |
| a. Soil contaminated with petroleum hydrocarbons | | No. | Type | 18 | Y |
| b. | | | | | |
| c. | | | | | |
| d. | | | | | |
| D. Additional Descriptions for Materials Listed Above Soil excavated from 40th Street UST Project 4000 San Pablo Ave., Emeryville, CA | | E. Handling Codes for Wastes Listed Above 03 | | | |
| 15. Special Handling Instructions and Additional Information | | | | | |
| 16. GENERATOR'S CERTIFICATION: I certify the materials described above on this manifest are not subject to federal regulations for reporting proper disposal of Hazardous Waste. | | | | | |
| Printed/Typed Name RONALD GERBER | | Signature Ronald Gerber | | Month Day Year 08 31 94 | |
| 17. Transporter 1 Acknowledgement of Receipt of Materials | | Signature Arnold Patton | | Month Day Year 08 31 94 | |
| 18. Transporter 2 Acknowledgement of Receipt of Materials | | Signature | | Month Day Year | |
| 19. Discrepancy Indication Space | | | | | |
| 20. Facility Owner or Operator: Certification of receipt of waste materials covered by this manifest except as noted in Item 19. | | | | | |
| Printed/Typed Name Jill A Fisher | | Signature Jill A Fisher | | Month Day Year 08 31 94 | |

**NON-HAZARDOUS
 WASTE MANIFEST**

1. Generator's US EPA ID No.
 NOT APPLICABLE

Manifest Document No.

2. Page 1 of

Authorizaton No.
 01216

3. Generator's Name and Mailing Address
 City of Emeryville Redevelopment Agency
 2200 Powell St.; 12th Floor
 Emeryville, CA 94608
 4. Generator's Phone (510) 596-4356 Attn: Ignacio Dayrit

5. Transporter 1 Company Name
 Northern Truck and Equipment
 6. US EPA ID Number
 NOT APPLICABLE

7. Transporter 2 Company Name
 8. US EPA ID Number
 NOT APPLICABLE

9. Designated Facility Name and Site Address
 B & J LANDFILL
 6426 HAY ROAD
 VACAVILLE, CA 95687
 10. US EPA ID Number
 NOT APPLICABLE

A. Transporter's Phone (510) 429-8920
 B. Transporter's Phone
 C. Facility's Phone
 (707) 451-3276

11. Waste Shipping Name and Description

a. Soil contaminated with petroleum hydrocarbons

| 12. Containers | | 13. Total Quantity | 14. Unit Wt/Vol |
|----------------|------|--------------------|-----------------|
| No. | Type | | |
| 1 | T | 18 | Y |
| .. | . | .. | .. |
| .. | . | .. | .. |
| .. | . | .. | .. |

b.

c.

d.

D. Additional Descriptions for Materials Listed Above
 Soil excavated from 40th Street UST Project
 4000 San Pablo Ave., Emeryville, CA

E. Handling Codes for Wastes Listed Above
 03

15. Special Handling Instructions and Additional Information

16. GENERATOR'S CERTIFICATION: I certify the materials described above on this manifest are not subject to federal regulations for reporting proper disposal of Hazardous Waste.

Printed/Typed Name: RONALD GERBER
 Signature: Ronald Gerber
 Month Day Year: 08 | 03 | 94

17. Transporter 1 Acknowledgement of Receipt of Materials
 Printed/Typed Name: [Signature]
 Signature: [Signature]
 Month Day Year: 08 | 03 | 94

18. Transporter 2 Acknowledgement of Receipt of Materials
 Printed/Typed Name: [Signature]
 Signature: [Signature]
 Month Day Year: [Signature]

19. Discrepancy Indication Space

20. Facility Owner or Operator: Certification of receipt of waste materials covered by this manifest except as noted in Item 19.

Printed/Typed Name: [Signature]
 Signature: [Signature]
 Month Day Year: 08 | 03 | 94

| NON-HAZARDOUS WASTE MANIFEST | | 1. Generator's US EPA ID No. NOT APPLICABLE | Manifest Document No. | 2. Page 1 of | Authorizaton No. 01216 |
|--|--|--|-----------------------|---|---------------------------|
| 3. Generator's Name and Mailing Address City of Emeryville Redevelopment Agency 2200 Powell St.; 12th Floor Emeryville, CA 94608 | | 4. Generator's Phone (510) 596-4356 Attn: Ignacio Davrit | | | |
| 5. Transporter 1 Company Name Northern Truck and Equipment | | 6. US EPA ID Number NOT APPLICABLE | | 373 at 621 | |
| 7. Transporter 2 Company Name | | 8. US EPA ID Number NOT APPLICABLE | | | |
| 9. Designated Facility Name and Site Address B & J LANDFILL 6426 HAY ROAD VACAVILLE, CA 95687 | | 10. US EPA ID Number NOT APPLICABLE | | A. Transporter's Phone (510) 429-8920 B. Transporter's Phone C. Facility's Phone (707) 451-3276 | |
| 11. Waste Shipping Name and Description | | 12. Containers | | 13. Total Quantity | |
| a. Soil contaminated with petroleum hydrocarbons | | No. Type | | 14. Unit Wt/Vol | |
| | | 1 T | | 18 Y | |
| b. | | | | | |
| c. | | | | | |
| d. | | | | | |
| D. Additional Descriptions for Materials Listed Above Soil excavated from 40th Street UST Project 4000 San Pablo Ave., Emeryville, CA | | E. Handling Codes for Wastes Listed Above 03 | | | |
| 15. Special Handling Instructions and Additional Information | | | | | |
| 16. GENERATOR'S CERTIFICATION: I certify the materials described above on this manifest are not subject to federal regulations for reporting proper disposal of Hazardous Waste. | | | | | |
| Printed/Typed Name RONALD GERBER | | Signature <i>Ronald Gerber</i> | | Month Day Year 08 03 94 | |
| 17. Transporter 1 Acknowledgement of Receipt of Materials | | | | | |
| Printed/Typed Name EDWARD A. ROUSE | | Signature <i>Edward A. Rouse</i> | | Month Day Year 08 03 94 | |
| 18. Transporter 2 Acknowledgement of Receipt of Materials | | | | | |
| Printed/Typed Name | | Signature | | Month Day Year | |
| 19. Discrepancy Indication Space | | | | | |
| 20. Facility Owner or Operator: Certification of receipt of waste materials covered by this manifest except as noted in Item 19. | | | | | |
| Printed/Typed Name Jill A. Fisher | | Signature <i>Jill A. Fisher</i> | | Month Day Year 08 03 94 | |

GENERATOR
TRANSPORTER
FACILITY

| | | | | | |
|--|--|---|-----------------------|---|---------------------------|
| NON-HAZARDOUS WASTE MANIFEST | | 1. Generator's US EPA ID No. NOT APPLICABLE | Manifest Document No. | 2. Page 1 of | Authorizaton No. 01216 |
| 3. Generator's Name and Mailing Address City of Emeryville Redevelopment Agency 2200 Powell St.; 12th Floor Emeryville CA 94608 | | 4. Generator's Phone (510) 596-4356 | | Attn: Ignacio Dayrit | |
| 5. Transporter 1 Company Name Northern Truck and Equipment | | 6. US EPA ID Number NOT APPLICABLE | | 3113 | |
| 7. Transporter 2 Company Name | | 8. US EPA ID Number NOT APPLICABLE | | | |
| 9. Designated Facility Name and Site Address B & J LANDFILL 6426 HAY ROAD VACAVILLE, CA 95687 | | 10. US EPA ID Number NOT APPLICABLE | | A. Transporter's Phone (510) 429-8920 B. Transporter's Phone C. Facility's Phone (707) 451-3276 | |
| 11. Waste Shipping Name and Description | | 12. Containers | 13. Total Quantity | 14. Unit Wt/Vol | |
| a. Soil contaminated with petroleum hydrocarbons | | No. 1 | Type T | 18 | Y |
| b. | | | | | |
| c. | | | | | |
| d. | | | | | |
| D. Additional Descriptions for Materials Listed Above Soil excavated from 40th Street UST Project 4000 San Pablo Ave., Emeryville, CA | | E. Handling Codes for Wastes Listed Above 03 | | | |
| 15. Special Handling Instructions and Additional Information | | | | | |
| 16. GENERATOR'S CERTIFICATION: I certify the materials described above on this manifest are not subject to federal regulations for reporting proper disposal of Hazardous Waste. | | | | | |
| Printed/Typed Name RONALD GERBER | | Signature <i>Ronald Gerber</i> | | Month Day Year 08 03 94 | |
| 17. Transporter 1 Acknowledgement of Receipt of Materials Printed/Typed Name Bud Lawrence | | Signature <i>Bud Lawrence</i> | | Month Day Year 08 10 94 | |
| 18. Transporter 2 Acknowledgement of Receipt of Materials Printed/Typed Name | | Signature | | Month Day Year | |
| 19. Discrepancy Indication Space | | | | | |
| 20. Facility Owner or Operator: Certification of receipt of waste materials covered by this manifest except as noted in item 19. | | | | | |
| Printed/Typed Name MARY BORDEN | | Signature <i>Mary Borden</i> | | Month Day Year 08 10 94 | |

GENERATOR

TRANSPORTER

FACILITY

| NON-HAZARDOUS WASTE MANIFEST | | 1. Generator's US EPA ID No. NOT APPLICABLE | Manifest Document No. | 2. Page 1 of | Authorizaton No. 01216 |
|--|--|--|-----------------------|--|---------------------------|
| 3. Generator's Name and Mailing Address City of Emeryville Redevelopment Agency 2200 Powell St.; 12th Floor Emeryville, CA 94608 | | 6. US EPA ID Number NOT APPLICABLE | | 3113 | |
| 4. Generator's Phone (510) 596-4356 Attn: Ignacio Dayrit | | 8. US EPA ID Number NOT APPLICABLE | | | |
| 5. Transporter 1 Company Name Northern Truck and Equipment | | 10. US EPA ID Number NOT APPLICABLE | | A. Transporter's Phone (510)429-8920 B. Transporter's Phone C. Facility's Phone (707) 451-3276 | |
| 7. Transporter 2 Company Name | | 9. Designated Facility Name and Site Address B & J LANDFILL 6426 HAY ROAD VACAVILLE, CA 95687 | | | |
| 11. Waste Shipping Name and Description | | 12. Containers | | 13. Total Quantity | 14. Unit Wt/Vol |
| a. Soil contaminated with petroleum hydrocarbons | | No. | Type | 18 | Y |
| b. | | | | | |
| c. | | | | | |
| d. | | | | | |
| D. Additional Descriptions for Materials Listed Above Soil excavated from 40th Street UST Project 4000 San Pablo Ave., Emeryville, CA | | E. Handling Codes for Wastes Listed Above 03 | | | |
| 15. Special Handling Instructions and Additional Information | | | | | |
| 16. GENERATOR'S CERTIFICATION: I certify the materials described above on this manifest are not subject to federal regulations for reporting proper disposal of Hazardous Waste. | | | | | |
| Printed/Typed Name RONALD GERBER | | Signature Ronald Gerber | | Month | Day Year |
| 17. Transporter 1 Acknowledgement of Receipt of Materials | | Signature Donald S. Sargent | | 8 | 3 1994 |
| Printed/Typed Name DONALD S. SARGENT | | Signature Donald S. Sargent | | 8 | 10 4 1994 |
| 18. Transporter 2 Acknowledgement of Receipt of Materials | | Signature | | Month | Day Year |
| Printed/Typed Name | | Signature | | | |
| 19. Discrepancy Indication Space | | | | | |
| 20. Facility Owner or Operator: Certification of receipt of waste materials covered by this manifest except as noted in Item 19. | | | | | |
| Printed/Typed Name Sandra Hall | | Signature Sandra Hall | | Month | Day Year |
| | | | | 10 | 8 1994 |

| | | | | | |
|--|--|--|-----------------------|---|---------------------------|
| NON-HAZARDOUS WASTE MANIFEST | | 1. Generator's US EPA ID No. NOT APPLICABLE | Manifest Document No. | 2. Page 1 of | Authorizaton No. 01216 |
| 3. Generator's Name and Mailing Address City of Emeryville Redevelopment Agency 2200 Powell St.; 12th Floor Emeryville CA 94608 | | 4. Generator's Phone (510) 596-4356 Attn: Ignacio Dayrit | | 5. Transporter 1 Company Name Northern Truck and Equipment | |
| 6. US EPA ID Number NOT APPLICABLE | | 7. Transporter 2 Company Name | | 8. US EPA ID Number NOT APPLICABLE | |
| 9. Designated Facility Name and Site Address B & J LANDFILL 6426 HAY ROAD VACAVILLE, CA 95687 | | 10. US EPA ID Number NOT APPLICABLE | | A. Transporter's Phone (510) 429-8920 B. Transporter's Phone C. Facility's Phone (707) 451-3276 | |
| 11. Waste Shipping Name and Description | | 12. Containers | | 13. Total Quantity | |
| a. Soil contaminated with petroleum hydrocarbons | | No. Type | | 14. Unit Wt/Vol | |
| | | 1 1 T | | 18 Y | |
| b. | | | | | |
| c. | | | | | |
| d. | | | | | |
| D. Additional Descriptions for Materials Listed Above Soil excavated from 40th Street UST Project 4000 San Pablo Ave., Emeryville, CA | | E. Handling Codes for Wastes Listed Above 03 | | | |
| 15. Special Handling Instructions and Additional Information | | | | | |
| 16. GENERATOR'S CERTIFICATION: I certify the materials described above on this manifest are not subject to federal regulations for reporting proper disposal of Hazardous Waste. | | | | | |
| Printed/Typed Name RONALD GERBER | | Signature Ronald Gerber | | Month Day Year 8 3 94 | |
| 17. Transporter 1 Acknowledgement of Receipt of Materials | | | | | |
| Printed/Typed Name CJ BLUNDELL | | Signature CJ Blundell | | Month Day Year 10 8 10 4 94 | |
| 18. Transporter 2 Acknowledgement of Receipt of Materials | | | | | |
| Printed/Typed Name | | Signature | | Month Day Year | |
| 19. Discrepancy Indication Space | | | | | |
| 20. Facility Owner or Operator: Certification of receipt of waste materials covered by this manifest except as noted in Item 19. | | | | | |
| Printed/Typed Name Sandra Hall | | Signature Sandra Hall | | Month Day Year 10 24 94 | |

GENERATOR

TRANSPORTER

FACILITY

**NON-HAZARDOUS
 WASTE MANIFEST**

1. Generator's US EPA ID No.
 NOT APPLICABLE

Manifest Document No.

2. Page 1 of

Authorizaton No.
 01216

3. Generator's Name and Mailing Address
 City of Emeryville Redevelopment Agency
 2200 Powell St.; 12th Floor
 Emeryville, CA 94608
 4. Generator's Phone (510) 596-4356 Attn: Ignacio Davrit

291

5. Transporter 1 Company Name
 Northern Truck and Equipment
 6. US EPA ID Number
 NOT APPLICABLE

3113

7. Transporter 2 Company Name
 8. US EPA ID Number
 NOT APPLICABLE

9. Designated Facility Name and Site Address
 B & J LANDFILL
 6426 HAY ROAD
 VACAVILLE, CA 95687
 10. US EPA ID Number
 NOT APPLICABLE

A. Transporter's Phone (510) 429-8920
 B. Transporter's Phone
 C. Facility's Phone (707) 451-3276

11. Waste Shipping Name and Description

| 12. Containers | 13. Total Quantity | 14. Unit Wt/Vol | | |
|--|--------------------|-----------------|-----|------|
| | | | No. | Type |
| a. Soil contaminated with petroleum hydrocarbons | 1 | T | 18 | Y. |
| b. | | | | |
| c. | | | | |
| d. | | | | |

D. Additional Descriptions for Materials Listed Above
 Soil excavated from 40th Street UST Project
 4000 San Pablo Ave., Emeryville, CA

E. Handling Codes for Wastes Listed Above
 03

15. Special Handling Instructions and Additional Information

16. GENERATOR'S CERTIFICATION: I certify the materials described above on this manifest are not subject to federal regulations for reporting proper disposal of Hazardous Waste.

Printed/Typed Name: RONALD GERBER
 Signature: Ronald Gerber
 Month Day Year: 8 3 94

17. Transporter 1 Acknowledgement of Receipt of Materials
 Printed/Typed Name: Pat Husley
 Signature: Pat Husley
 Month Day Year: 08 04 94

18. Transporter 2 Acknowledgement of Receipt of Materials
 Printed/Typed Name:
 Signature:
 Month Day Year:

19. Discrepancy Indication Space

20. Facility Owner or Operator: Certification of receipt of waste materials covered by this manifest except as noted in Item 19.

Printed/Typed Name: MARY BORDEN
 Signature: Mary Borden
 Month Day Year: 10 30 94

GENERATOR

TRANSPORTER

FACILITY

| | | | | | |
|--|--|--|---|---|----------------------------|
| NON-HAZARDOUS WASTE MANIFEST | | 1. Generator's US EPA ID No. NOT APPLICABLE | Manifest Document No. | 2. Page 1 of | Authorization No. 01216 |
| 3. Generator's Name and Mailing Address City of Emeryville Redevelopment Agency 2200 Powell St.; 12th Floor Emeryville, CA 94608 | | 4. Generator's Phone (510) 596-4356 Attn: Ignacio Dayrit | | RSI 91298 | |
| 5. Transporter 1 Company Name Northern Truck and Equipment | 6. US EPA ID Number NOT APPLICABLE | 7. Transporter 2 Company Name | | | |
| 9. Designated Facility Name and Site Address B & J LANDFILL 6426 HAY ROAD VACAVILLE, CA 95687 | | 10. US EPA ID Number NOT APPLICABLE | | A. Transporter's Phone (510) 429-8920 B. Transporter's Phone C. Facility's Phone (707) 451-3276 | |
| 11. Waste Shipping Name and Description | | | 12. Containers | 13. Total Quantity | 14. Unit Wt/Val |
| a. Soil contaminated with petroleum hydrocarbons | | | No. 1 | Type T | 18 Y |
| b. | | | | | |
| c. | | | | | |
| d. | | | | | |
| D. Additional Descriptions for Materials Listed Above Soil excavated from 40th Street UST Project 4000 San Pablo Ave., Emeryville, CA | | | E. Handling Codes for Wastes Listed Above 03 | | |
| 15. Special Handling Instructions and Additional Information | | | | | |
| 16. GENERATOR'S CERTIFICATION: I certify the materials described above on this manifest are not subject to federal regulations for reporting proper disposal of Hazardous Waste. | | | | | |
| Printed/Typed Name RONALD GERBER | | Signature Ronald Gerber | | Month Day Year 8 3 94 | |
| 17. Transporter 1 Acknowledgement of Receipt of Materials Printed/Typed Name SIM BROOKS | | Signature Sim Brooks | | Month Day Year 10 04 94 | |
| 18. Transporter 2 Acknowledgement of Receipt of Materials Printed/Typed Name | | Signature | | Month Day Year | |
| 19. Discrepancy Indication Space | | | | | |
| 20. Facility Owner or Operator: Certification of receipt of waste materials covered by this manifest except as noted in Item 19. | | | | | |
| Printed/Typed Name Sandra Hall | | Signature Sandra Hall | | Month Day Year 10 04 94 | |

GENERATOR

TRANSPORTER

FACILITY

| | | | | | | | | | | | |
|--|--|---|-----------------------|---|---------------------------|--------------------|----------------------------|-----------------|--|---|--|
| NON-HAZARDOUS WASTE MANIFEST | | 1. Generator's US EPA ID No. NOT APPLICABLE | Manifest Document No. | 2. Page 1 of | Authorizaton No. 01216 | | | | | | |
| 3. Generator's Name and Mailing Address City of Emeryville Redevelopment Agency 2200 Powell St.; 12th Floor Emeryville CA 94608 | | | | 91294 | | | | | | | |
| 4. Generator's Phone (510) 596-4356 Attn: Ignacio Dayrit | | | | | | | | | | | |
| 5. Transporter 1 Company Name Northern Truck and Equipment | | 6. US EPA ID Number NOT APPLICABLE | | 3113 | | | | | | | |
| 7. Transporter 2 Company Name | | 8. US EPA ID Number NOT APPLICABLE | | | | | | | | | |
| 9. Designated Facility Name and Site Address B & J LANDFILL 6426 HAY ROAD VACAVILLE, CA 95687 | | 10. US EPA ID Number NOT APPLICABLE | | A. Transporter's Phone (510) 429-8920 B. Transporter's Phone C. Facility's Phone (707) 451-3276 | | | | | | | |
| 11. Waste Shipping Name and Description a. Soil contaminated with petroleum hydrocarbons b. c. d. | | | | 12. Containers | | 13. Total Quantity | | 14. Unit Wt/Vol | | | |
| | | | | No. | | Type | | | | | |
| | | | | 1 | | T | | 18 | | Y | |
| | | | | . | | . | | . | | . | |
| | | | | . | | . | | . | | . | |
| D. Additional Descriptions for Materials Listed Above Soil excavated from 40th Street UST Project 4000 San Pablo Ave., Emeryville, CA | | | | E. Handling Codes for Wastes Listed Above 03 | | | | | | | |
| 15. Special Handling Instructions and Additional Information | | | | | | | | | | | |
| 16. GENERATOR'S CERTIFICATION: I certify the materials described above on this manifest are not subject to federal regulations for reporting proper disposal of Hazardous Waste. | | | | | | | | | | | |
| Printed/Typed Name Ronald Gerber | | | | Signature Ronald Gerber | | | Month Day Year 8 3 94 | | | | |
| 17. Transporter 1 Acknowledgement of Receipt of Materials Printed/Typed Name John Duca | | | | Signature John Duca | | | Month Day Year 8 3 94 | | | | |
| 18. Transporter 2 Acknowledgement of Receipt of Materials Printed/Typed Name | | | | Signature | | | Month Day Year | | | | |
| 19. Discrepancy Indication Space | | | | | | | | | | | |
| 20. Facility Owner or Operator: Certification of receipt of waste materials covered by this manifest except as noted in Item 19. | | | | | | | | | | | |
| Printed/Typed Name Sandra Hall | | | | Signature Sandra Hall | | | Month Day Year 08 04 94 | | | | |

| | | | | | |
|--|--|--|-----------------------|---|---------------------------|
| NON-HAZARDOUS WASTE MANIFEST | | 1. Generator's US EPA ID No. NOT APPLICABLE | Manifest Document No. | 2. Page 1 of 1 | Authorizaton No. 01216 |
| 3. Generator's Name and Mailing Address City of Emeryville Redevelopment Agency 2200 Powell St.; 12th Floor Emeryville CA 94608 | | 4. Generator's Phone (510) 596-4356 Attn: Ignacio Dayrit | | | |
| 5. Transporter 1 Company Name Northern Truck and Equipment | | 6. US EPA ID Number NOT APPLICABLE | | 3113 | |
| 7. Transporter 2 Company Name | | 8. US EPA ID Number NOT APPLICABLE | | | |
| 9. Designated Facility Name and Site Address B & J LANDFILL 6426 HAY ROAD VACAVILLE, CA 95687 | | 10. US EPA ID Number NOT APPLICABLE | | A. Transporter's Phone (510) 429-8920 B. Transporter's Phone C. Facility's Phone (707) 451-3276 | |
| 11. Waste Shipping Name and Description | | 12. Containers | | 13. Total Quantity | 14. Unit Wt/Vol |
| a. Soil contaminated with petroleum hydrocarbons | | No. | Type | 18 | Y |
| b. | | | | | |
| c. | | | | | |
| d. | | | | | |
| D. Additional Descriptions for Materials Listed Above Soil excavated from 40th Street UST Project 4000 San Pablo Ave., Emeryville, CA | | E. Handling Codes for Wastes Listed Above 03 | | | |
| 15. Special Handling Instructions and Additional Information | | | | | |
| 16. GENERATOR'S CERTIFICATION: I certify the materials described above on this manifest are not subject to federal regulations for reporting proper disposal of Hazardous Waste. | | | | | |
| Printed/Typed Name RONALD GERBER | | Signature <i>Ronald Gerber</i> | | Month | Day Year |
| | | | | 8 | 3 1994 |
| 17. Transporter 1 Acknowledgement of Receipt of Materials | | Printed/Typed Name LARRY CONNOR | | Signature <i>Larry Connor</i> | |
| | | | | Month | Day Year |
| | | | | 8 | 7 1994 |
| 18. Transporter 2 Acknowledgement of Receipt of Materials | | Printed/Typed Name | | Signature | |
| | | | | Month | Day Year |
| | | | | | |
| 19. Discrepancy Indication Space | | | | | |
| 20. Facility Owner or Operator: Certification of receipt of waste materials covered by this manifest except as noted in Item 9. | | | | | |
| Printed/Typed Name Sandra Hall | | Signature <i>Sandra Hall</i> | | Month | Day Year |
| | | | | 8 | 04 1994 |

ORIGINAL-RETURN TO GENERATOR

**NON-HAZARDOUS
 WASTE MANIFEST**

1. Generator's US EPA ID No.
 NOT APPLICABLE

Manifest Document No.

2. Page 1 of

Authorizaton No.
 01216

3. Generator's Name and Mailing Address
 City of Emeryville Redevelopment Agency
 2200 Powell St.; 12th Floor
 Emeryville, CA 94608

4. Generator's Phone (510) 596-4356 Attn: Ignacio Dayrit

5. Transporter 1 Company Name
 Northern Truck and Equipment

6. US EPA ID Number
 NOT APPLICABLE

3113

7. Transporter 2 Company Name

8. US EPA ID Number
 NOT APPLICABLE

9. Designated Facility Name and Site Address

B & J LANDFILL
 6426 HAY ROAD
 VACAVILLE, CA 95687

10. US EPA ID Number
 NOT APPLICABLE

A. Transporter's Phone (510) 429-8920

B. Transporter's Phone

C. Facility's Phone

(707) 451-3276

11. Waste Shipping Name and Description

a. Soil contaminated with petroleum hydrocarbons

| 12. Containers | | 13. Total Quantity | 14. Unit Wt/Vol |
|----------------|------|--------------------|-----------------|
| No. | Type | | |
| 1 | T | 18 | Y |
| . | . | . | . |
| . | . | . | . |
| . | . | . | . |

GENERATOR

D. Additional Descriptions for Materials Listed Above

Soil excavated from 40th Street UST Project
 4000 San Pablo Ave., Emeryville, CA

E. Handling Codes for Wastes Listed Above

03

15. Special Handling Instructions and Additional Information

16. GENERATOR'S CERTIFICATION: I certify the materials described above on this manifest are not subject to federal regulation for reporting proper disposal of Hazardous Waste.

Printed/Typed Name

Ronald Gerber

Signature

Ronald Gerber

Month Day Year

8 | 3 | 99

17. Transporter 1 Acknowledgement of Receipt of Materials

Printed/Typed Name

Phil Rouse

Signature

Phil Rouse

Month Day Year

8 | 4 | 99

18. Transporter 2 Acknowledgement of Receipt of Materials

Printed/Typed Name

Signature

Month Day Year

19. Discrepancy Indication Space

20. Facility Owner or Operator: Certification of receipt of waste materials covered by this manifest except as noted in Item 19.

Printed/Typed Name

Sandra Hall

Signature

Sandra Hall

Month Day Year

8 | 0 | 99

**NON-HAZARDOUS
WASTE MANIFEST**

1. Generator's US EPA ID No.
NOT APPLICABLE

Manifest Document No.

2. Page 1 of

Authorizaton No.
01216

3. Generator's Name and Mailing Address
City of Emeryville Redevelopment Agency
2200 Powell St.; 12th Floor
Emeryville, CA 94608
4. Generator's Phone (510) 596-4356 Attn: Ignacio Dayrit

RSI 491
RPAS

5. Transporter 1 Company Name
Northern Truck and Equipment

6. US EPA ID Number
NOT APPLICABLE

3113

7. Transporter 2 Company Name

8. US EPA ID Number
NOT APPLICABLE

9. Designated Facility Name and Site Address
B & J LANDFILL
6426 HAY ROAD
VACAVILLE, CA 95687

10. US EPA ID Number
NOT APPLICABLE

A. Transporter's Phone (510) 429-8920
B. Transporter's Phone
C. Facility's Phone
(707) 451-3276

11. Waste Shipping Name and Description

| 12. Containers | | 13. Total Quantity | 14. Unit Wt/Vol |
|----------------|------|--------------------|-----------------|
| No. | Type | | |
| 1 | T | 18 | Y |
| | | | |
| | | | |
| | | | |

a. Soil contaminated with petroleum hydrocarbons

b.

c.

d.

D. Additional Descriptions for Materials Listed Above
Soil excavated from 40th Street UST Project
4000 San Pablo Ave., Emeryville, CA

E. Handling Codes for Wastes Listed Above
03

15. Special Handling Instructions and Additional Information

16. GENERATOR'S CERTIFICATION: I certify the materials described above on this manifest are not subject to federal regulations for reporting proper disposal of Hazardous Waste.

Printed/Typed Name: **RONALD GERBER** Signature: *Ronald Gerber* Month: **18** Day: **3** Year: **99**

17. Transporter 1 Acknowledgement of Receipt of Materials

Printed/Typed Name: **DAVID STEVENS** Signature: *David Stevens* Month: **10** Day: **4** Year: **94**

18. Transporter 2 Acknowledgement of Receipt of Materials

Printed/Typed Name: Signature: Month: Day: Year:

19. Discrepancy Indication Space

20. Facility Owner or Operator: Certification of receipt of waste materials covered by this manifest except as noted in Item 19.

Printed/Typed Name: **MARY BORDEN** Signature: *Mary Borden* Month: **8** Day: **4** Year: **94**

ORIGINAL-RETURN TO GENERATOR

GENERATOR

TRANSPORTER

FACILITY

| | | | | | |
|--|--|---|----------------------------|---|---------------------------|
| NON-HAZARDOUS WASTE MANIFEST | | 1. Generator's US EPA ID No. NOT APPLICABLE | Manifest Document No. 1 | 2. Page 1 of | Authorizaton No. 01216 |
| 3. Generator's Name and Mailing Address City of Emeryville Redevelopment Agency 2200 Powell St.; 12th Floor Emeryville, CA 94608 | | | | 11973 | |
| 4. Generator's Phone (510) 596-4356 Attn: Ignacio Dayrit | | | | | |
| 5. Transporter 1 Company Name Northern Truck and Equipment | | 6. US EPA ID Number NOT APPLICABLE | | 3113 | R.B 4 |
| 7. Transporter 2 Company Name | | 8. US EPA ID Number NOT APPLICABLE | | | |
| 9. Designated Facility Name and Site Address B & J LANDFILL 6426 HAY ROAD VACAVILLE, CA 95687 | | 10. US EPA ID Number NOT APPLICABLE | | A. Transporter's Phone (510) 429-8920 B. Transporter's Phone C. Facility's Phone (707) 451-3276 | |
| 11. Waste Shipping Name and Description | | | | 12. Containers | |
| a. Soil contaminated with petroleum hydrocarbons | | | | No. | Type |
| | | | | 1 | T |
| b. | | | | | |
| c. | | | | | |
| d. | | | | | |
| 13. Total Quantity | | | | 14. Unit | |
| | | | | Wt/Vol | |
| | | | | 18 Y | |
| D. Additional Descriptions for Materials Listed Above Soil excavated from 40th Street UST Project 4000 San Pablo Ave., Emeryville, CA | | | | E. Handling Codes for Wastes Listed Above 03 | |
| 15. Special Handling Instructions and Additional Information | | | | | |
| 16. GENERATOR'S CERTIFICATION: I certify the materials described above on this manifest are not subject to federal regulations for reporting proper disposal of Hazardous Waste. | | | | | |
| Printed/Typed Name RONALD GERBER | | Signature Ronald Gerber | | Month Day Year 8 13 94 | |
| 17. Transporter 1 Acknowledgement of Receipt of Materials | | Printed/Typed Name DAVID CLARK D. Clark | | Signature D. Clark | |
| | | | | Month Day Year 8 14 94 | |
| 18. Transporter 2 Acknowledgement of Receipt of Materials | | Printed/Typed Name | | Signature | |
| | | | | Month Day Year | |
| 19. Discrepancy Indication Space | | | | | |
| 20. Facility Owner or Operator: Certification of receipt of waste materials covered by this manifest except as noted in Item 19. | | | | | |
| Printed/Typed Name Mary Borde | | Signature Mary Borde | | Month Day Year 8 14 94 | |

GENERATOR

| | | | | | |
|--|--|--|---------------------------------------|--------------------------|---------------------------|
| NON-HAZARDOUS WASTE MANIFEST | | 1. Generator's US EPA ID No. NOT APPLICABLE | Manifest Document No. | 2. Page 1 of | Authorizaton No. 01216 |
| 3. Generator's Name and Mailing Address City of Emeryville Redevelopment Agency 2200 Powell St.; 12th Floor Emeryville CA 94608 | | 4. Generator's Phone (510) 596-4356 Attn: Ignacio Dayrit | | RST 6 | |
| 5. Transporter 1 Company Name Northern Truck and Equipment | 6. US EPA ID Number NOT APPLICABLE | 7. Transporter 2 Company Name | | 3113 | 11909 |
| 9. Designated Facility Name and Site Address B & J LANDFILL 6426 HAY ROAD VACAVILLE, CA 95687 | | 10. US EPA ID Number NOT APPLICABLE | A. Transporter's Phone (510) 429-8920 | | |
| | | B. Transporter's Phone | | | |
| | | C. Facility's Phone (707) 451-3276 | | | |
| 11. Waste Shipping Name and Description | | 12. Containers | 13. Total Quantity | 14. Unit Wt/Vol | |
| a. Soil contaminated with petroleum hydrocarbons | | No. 1 | Type T | 18 | Y |
| b. | | | | | |
| c. | | | | | |
| d. | | | | | |
| D. Additional Descriptions for Materials Listed Above Soil excavated from 40th Street UST Project 4000 San Pablo Ave., Emeryville, CA | | E. Handling Codes for Wastes Listed Above 03 | | | |
| 15. Special Handling Instructions and Additional Information | | | | | |
| 16. GENERATOR'S CERTIFICATION: I certify the materials described above on this manifest are not subject to federal regulations for reporting proper disposal of Hazardous Waste. | | | | | |
| Printed/Typed Name RONALD GERBER | | Signature Ronald Gerber | | Month Day Year 8 3 94 | |
| 17. Transporter 1 Acknowledgement of Receipt of Materials | | Signature | | Month Day Year | |
| Printed/Typed Name | | Signature | | Month Day Year | |
| 18. Transporter 2 Acknowledgement of Receipt of Materials | | Signature | | Month Day Year | |
| Printed/Typed Name | | Signature | | Month Day Year | |
| 19. Discrepancy Indication Space | | | | | |
| 20. Facility Owner or Operator: Certification of receipt of waste materials covered by this manifest except as noted in item 19. | | | | | |
| Printed/Typed Name MARY BORDEN | | Signature Mary Borden | | Month Day Year 8 4 90 | |

ORIGINAL-RETURN TO GENERATOR

| | | | | | |
|--|--|---|---|---------------------------------------|---------------------------|
| NON-HAZARDOUS WASTE MANIFEST | | 1. Generator's US EPA ID No. NOT APPLICABLE | Manifest Document No. | 2. Page 1 of | Authorizaton No. 01216 |
| 3. Generator's Name and Mailing Address City of Emeryville Redevelopment Agency 2200 Powell St.; 12th Floor Emeryville CA 94608 | | | | <i>RSI 8</i> | |
| 4. Generator's Phone (510) 596-4356 Attn: Ignacio Dayrit | | | | | |
| 5. Transporter 1 Company Name Northern Truck and Equipment | | 6. US EPA ID Number NOT APPLICABLE | | 3113 | |
| 7. Transporter 2 Company Name <i>Collins Trucking</i> | | 8. US EPA ID Number NOT APPLICABLE | | | |
| 9. Designated Facility Name and Site Address B & J LANDFILL 6426 HAY ROAD VACAVILLE, CA 95687 | | 10. US EPA ID Number NOT APPLICABLE | | A. Transporter's Phone (510) 429-8920 | |
| | | | | B. Transporter's Phone | |
| | | | | C. Facility's Phone (707) 451-3276 | |
| 11. Waste Shipping Name and Description | | | 12. Containers | 13. Total Quantity | 14. Unit Wt/Vol |
| a. Soil contaminated with petroleum hydrocarbons | | | No. 1 | Type T | 18 |
| b. | | | | | |
| c. | | | | | |
| d. | | | | | |
| D. Additional Descriptions for Materials Listed Above Soil excavated from 40th Street UST Project 4000 San Pablo Ave., Emeryville, CA | | | E. Handling Codes for Wastes Listed Above 03 | | |
| 15. Special Handling Instructions and Additional Information | | | | | |
| 16. GENERATOR'S CERTIFICATION: I certify the materials described above on this manifest are not subject to federal regulations for reporting proper disposal of Hazardous Waste. | | | | | |
| Printed/Typed Name <i>RONALD GERBER</i> | | Signature <i>Ronald Gerber</i> | | Month 8 | Day 3 |
| 17. Transporter 1 Acknowledgement of Receipt of Materials | | Printed/Typed Name <i>Charlie Collins</i> | | Signature <i>Charlie Collins</i> | |
| | | | | Month 12 | Day 31 |
| 18. Transporter 2 Acknowledgement of Receipt of Materials | | Printed/Typed Name | | Signature | |
| | | | | Month | Day |
| 19. Discrepancy Indication Space | | | | | |
| 20. Facility Owner or Operator: Certification of receipt of waste materials covered by this manifest except as noted in Item 19. | | | | | |
| Printed/Typed Name <i>MARY BORDEN</i> | | Signature <i>Mary Borden</i> | | Month 11 | Day 4 |

GENERATOR

TRANSPORTER

FACILITY

| | | | | | |
|--|--|---|---|---------------------------------------|---------------------------|
| NON-HAZARDOUS WASTE MANIFEST | | 1. Generator's US EPA ID No. NOT APPLICABLE | Manifest Document No. 1 | 2. Page 1 of | Authorizaton No. 01216 |
| 3. Generator's Name and Mailing Address. City of Emeryville Redevelopment Agency 2200 Powell St.; 12th Floor Emeryville, CA 94608 | | | | <i>R64</i> | |
| 4. Generator's Phone (510) 596-4356 Attn: Ignacio Dayrit | | | | | |
| 5. Transporter 1 Company Name Northern Truck and Equipment | | 6. US EPA ID Number NOT APPLICABLE | | 3113 | |
| 7. Transporter 2 Company Name | | 8. US EPA ID Number NOT APPLICABLE | | | |
| 9. Designated Facility Name and Site Address B & J LANDFILL 6426 HAY ROAD VACAVILLE, CA 95687 | | 10. US EPA ID Number NOT APPLICABLE | | A. Transporter's Phone (510) 429-8920 | |
| | | | | B. Transporter's Phone | |
| | | | | C. Facility's Phone (707) 451-3276 | |
| 11. Waste Shipping Name and Description | | | 12. Containers | | 13. Total Quantity |
| | | | No. | Type | 14. Unit Wt/Vol |
| a. Soil contaminated with petroleum hydrocarbons | | | 1 | T | 18 Y |
| b. | | | . | . | . |
| c. | | | . | . | . |
| d. | | | . | . | . |
| D. Additional Descriptions for Materials Listed Above Soil excavated from 40th Street UST Project 4000 San Pablo Ave., Emeryville, CA | | | E. Handling Codes for Wastes Listed Above 03 | | |
| 15. Special Handling Instructions and Additional Information | | | | | |
| 16. GENERATOR'S CERTIFICATION: I certify the materials described above on this manifest are not subject to federal regulations for reporting proper disposal of Hazardous Waste. | | | | | |
| Printed/Typed Name <i>Ronald Gerber</i> | | Signature <i>Ronald Gerber</i> | | Month 8 | Day 3 |
| 17. Transporter 1 Acknowledgement of Receipt of Materials | | Printed/Typed Name <i>Craig Rice</i> | | Month 8 | Day 4 |
| 18. Transporter 2 Acknowledgement of Receipt of Materials | | Signature <i>Craig Rice</i> | | Year 94 | |
| Printed/Typed Name | | Signature | | Month | Day |
| 19. Discrepancy Indication Space | | | | | |
| 20. Facility Owner or Operator: Certification of receipt of waste materials covered by this manifest except as noted in Item 19. | | | | | |
| Printed/Typed Name <i>Sandra Hall</i> | | Signature <i>Sandra Hall</i> | | Month 10 | Day 04 |
| | | | | Year 94 | |

GENERATOR

TRANSPORTER

FACILITY

| NON-HAZARDOUS WASTE MANIFEST | | 1. Generator's US EPA ID No. NOT APPLICABLE | Manifest Document No. | 2. Page 1 of | Authorizaton No. 01216 |
|--|--|---|-----------------------|---------------------------------------|---------------------------|
| 3. Generator's Name and Mailing Address City of Emeryville Redevelopment Agency 2200 Powell St.; 12th Floor Emeryville CA 94608 | | 6. US EPA ID Number NOT APPLICABLE | | 3113 | RSI 85 |
| 4. Generator's Phone (510) 596-4356 Attn: Ignacio Dayrit | | 8. US EPA ID Number NOT APPLICABLE | | | 11979 |
| 5. Transporter 1 Company Name Northern Truck and Equipment | | 10. US EPA ID Number NOT APPLICABLE | | A. Transporter's Phone (510) 429-8920 | |
| 7. Transporter 2 Company Name | | | | B. Transporter's Phone | |
| 9. Designated Facility Name and Site Address B & J LANDFILL 6426 HAY ROAD VACAVILLE, CA 95687 | | | | C. Facility's Phone (707) 451-3276 | |
| 11. Waste Shipping Name and Description | | 12. Containers | | 13. Total Quantity | 14. Unit Wt/Vol |
| a. Soil contaminated with petroleum hydrocarbons | | No. | Type | 18 | Y |
| b. | | | | | |
| c. | | | | | |
| d. | | | | | |
| D. Additional Descriptions for Materials Listed Above Soil excavated from 40th Street UST Project 4000 San Pablo Ave., Emeryville, CA | | E. Handling Codes for Wastes Listed Above 03 | | | |
| 15. Special Handling Instructions and Additional Information | | | | | |
| 16. GENERATOR'S CERTIFICATION: I certify the materials described above on this manifest are not subject to federal regulations for reporting proper disposal of Hazardous Waste. | | | | | |
| Printed/Typed Name Ronald Gerber | | Signature <i>Ronald Gerber</i> | | Month 8 | Day 3 |
| 17. Transporter 1 Acknowledgement of Receipt of Materials | | Signature <i>Roy Vincent</i> | | Month 8 | Day 15 |
| Printed/Typed Name Roy Vincent | | Signature <i>Roy Vincent</i> | | Month 8 | Day 15 |
| 18. Transporter 2 Acknowledgement of Receipt of Materials | | Signature | | Month | Day |
| Printed/Typed Name | | Signature | | Month | Day |
| 19. Discrepancy Indication Space | | | | | |
| 20. Facility Owner or Operator: Certification of receipt of waste materials covered by this manifest except as noted in Item 19. | | | | | |
| Printed/Typed Name Mary Borden | | Signature <i>Mary Borden</i> | | Month 8 | Day 14 |

GENERATOR
TRANSPORTER
FACILITY

| NON-HAZARDOUS WASTE MANIFEST | | 1. Generator's US EPA ID No. NOT APPLICABLE | Manifest Document No. | 2. Page 1 of | Authorizaton No. 01216 |
|--|--|--|-----------------------|--|---------------------------|
| 3. Generator's Name and Mailing Address City of Emeryville Redevelopment Agency 2200 Powell St.; 12th Floor Emeryville, CA 94608 | | 6. US EPA ID Number NOT APPLICABLE | | RSI | |
| 4. Generator's Phone (510) 596-4356 Attn: Ignacio Dayrit | | 7. Transporter 1 Company Name Northern Truck and Equipment | | | |
| 5. Transporter 1 Company Name | | 8. US EPA ID Number NOT APPLICABLE | | 3113 | |
| 7. Transporter 2 Company Name | | 9. Designated Facility Name and Site Address B & J LANDFILL 6426 HAY ROAD VACAVILLE, CA 95687 | | 10. US EPA ID Number NOT APPLICABLE | |
| 9. Designated Facility Name and Site Address | | A. Transporter's Phone (510) 429-8920 | | B. Transporter's Phone | |
| 11. Waste Shipping Name and Description | | C. Facility's Phone (707) 451-3276 | | | |
| a. Soil contaminated with petroleum hydrocarbons | | 12. Containers No. | Type | 13. Total Quantity | 14. Unit Wt/Vol |
| b. | | 1 | T | 18 | Y |
| c. | | | | | |
| d. | | | | | |
| D. Additional Descriptions for Materials Listed Above Soil excavated from 40th Street UST Project 4000 San Pablo Ave., Emeryville, CA | | E. Handling Codes for Wastes Listed Above 03 | | | |
| 15. Special Handling Instructions and Additional Information | | | | | |
| 16. GENERATOR'S CERTIFICATION: I certify the materials described above on this manifest are not subject to federal regulations for reporting proper disposal of Hazardous Waste. | | | | | |
| Printed/Typed Name Ronald Gerber | | Signature Ronald Gerber | | Month Day Year DEC 03 94 | |
| 17. Transporter 1 Acknowledgement of Receipt of Materials | | | | | |
| Printed/Typed Name JAMES ARNOLD | | Signature James Arnold | | Month Day Year 10 30 94 | |
| 18. Transporter 2 Acknowledgement of Receipt of Materials | | | | | |
| Printed/Typed Name | | Signature | | Month Day Year | |
| 19. Discrepancy Indication Space | | | | | |
| 20. Facility Owner or Operator: Certification of receipt of waste materials covered by this manifest except as noted in Item 19. | | | | | |
| Printed/Typed Name William Fisher | | Signature William Fisher | | Month Day Year 10 30 94 | |

GENERATOR

TRANSPORTER

FACILITY

**NON-HAZARDOUS
 WASTE MANIFEST**

1. Generator's US EPA ID No.
 NOT APPLICABLE

Manifest Document No.

2. Page 1 of

Authorizaton No.
 01216

3. Generator's Name and Mailing Address
 City of Emeryville Redevelopment Agency
 2200 Powell St.; 12th Floor
 Emeryville CA 94608
 4. Generator's Phone (510) 596-4356 Attn: Ignacio Dayrit

JK5

5. Transporter 1 Company Name
 Northern Truck and Equipment

6. US EPA ID Number
 NOT APPLICABLE

3113

7. Transporter 2 Company Name

8. US EPA ID Number
 NOT APPLICABLE

9. Designated Facility Name and Site Address
 B & J LANDFILL
 6426 HAY ROAD
 VACAVILLE, CA 95687

10. US EPA ID Number
 NOT APPLICABLE

A. Transporter's Phone (510) 429-8920

B. Transporter's Phone

C. Facility's Phone
 (707) 451-3276

11. Waste Shipping Name and Description

a. Soil contaminated with petroleum hydrocarbons

| 12. Containers | | 13. Total Quantity | 14. Unit Wt/Vol |
|----------------|------|--------------------|-----------------|
| No. | Type | | |
| 1 | T | 18 | Y |
| . | . | . | . |
| . | . | . | . |
| . | . | . | . |
| . | . | . | . |

D. Additional Descriptions for Materials Listed Above
 Soil excavated from 40th Street UST Project
 4000 San Pablo Ave., Emeryville, CA

E. Handling Codes for Wastes Listed Above
 03

15. Special Handling Instructions and Additional Information

16. GENERATOR'S CERTIFICATION: I certify the materials described above on this manifest are not subject to federal regulations for reporting proper disposal of Hazardous Waste.

Printed/Typed Name
 RONALD GERBER

Signature *Ronald Gerber* Month Day Year
 8 3 94

17. Transporter 1 Acknowledgement of Receipt of Materials
 Printed/Typed Name
 Lewis Rose

Signature *Lewis Rose* Month Day Year

18. Transporter 2 Acknowledgement of Receipt of Materials
 Printed/Typed Name

Signature Month Day Year

19. Discrepancy Indication Space

20. Facility Owner or Operator: Certification of receipt of waste materials covered by this manifest except as noted in Item 19.

Printed/Typed Name
 Sandra Hall

Signature *Sandra Hall* Month Day Year
 12 24 94

**NON-HAZARDOUS
 WASTE MANIFEST**

1. Generator's US EPA ID No.
 NOT APPLICABLE

Manifest Document No.

2. Page 1 of

Authorizaton No.
 01216

3. Generator's Name and Mailing Address
 City of Emeryville Redevelopment Agency
 2200 Powell St.; 12th Floor
 Emeryville CA 94608
 4. Generator's Phone (510) 596-4356 Attn: Ignacio Dayrit

5. Transporter 1 Company Name
 Northern Truck and Equipment
 6. US EPA ID Number
 NOT APPLICABLE

3113

7. Transporter 2 Company Name
 8. US EPA ID Number
 NOT APPLICABLE

9. Designated Facility Name and Site Address
 B & J LANDFILL
 6426 HAY ROAD
 VACAVILLE, CA 95687
 10. US EPA ID Number
 NOT APPLICABLE

A. Transporter's Phone (510) 429-8920
 B. Transporter's Phone
 C. Facility's Phone (707) 451-3276

| 11. Waste Shipping Name and Description | 12. Containers | | 13. Total Quantity | 14. Unit Wt/Vol |
|--|----------------|------|--------------------|-----------------|
| | No. | Type | | |
| a. Soil contaminated with petroleum hydrocarbons | 1 | T | 18 | Y |
| b. | | | | |
| c. | | | | |
| d. | | | | |

D. Additional Descriptions for Materials Listed Above
 Soil excavated from 40th Street UST Project
 4000 San Pablo Ave., Emeryville, CA

E. Handling Codes for Wastes Listed Above
 03

15. Special Handling Instructions and Additional Information

16. GENERATOR'S CERTIFICATION: I certify the materials described above on this manifest are not subject to federal regulations for reporting proper disposal of Hazardous Waste.

Printed/Typed Name: RONALD GERBER
 Signature: Ronald Gerber
 Month: 8, Day: 3, Year: 99

17. Transporter 1 Acknowledgement of Receipt of Materials
 Printed/Typed Name: SCOTT A SILVER
 Signature: Scott A Silver
 Month: 8, Day: 5, Year: 99

18. Transporter 2 Acknowledgement of Receipt of Materials
 Printed/Typed Name:
 Signature:
 Month: , Day: , Year:

19. Discrepancy Indication Space

20. Facility Owner or Operator: Certification of receipt of waste materials covered by this manifest except as noted in Item 19.

Printed/Typed Name: Sandra Hall
 Signature: Sandra Hall
 Month: 08, Day: 04, Year: 99

**NON-HAZARDOUS
 WASTE MANIFEST**

1. Generator's US EPA ID No.
 NOT APPLICABLE

Manifest Document No.

2. Page 1 of

Authorizaton No.
 01216

3. Generator's Name and Mailing Address
 City of Emeryville Redevelopment Agency
 2200 Powell St.; 12th Floor
 Emeryville CA 94608
 4. Generator's Phone (510) 596-4356 Attn: Ignacio Dayrit

5. Transporter 1 Company Name
 Northern Truck and Equipment
 6. US EPA ID Number
 NOT APPLICABLE

3113

#59

7. Transporter 2 Company Name
 8. US EPA ID Number
 NOT APPLICABLE

9. Designated Facility Name and Site Address
 B & J LANDFILL
 6426 HAY ROAD
 VACAVILLE, CA 95687
 10. US EPA ID Number
 NOT APPLICABLE

A. Transporter's Phone (510)429-8920

B. Transporter's Phone

C. Facility's Phone

(707) 451-3276

11. Waste Shipping Name and Description

12. Containers

13. Total Quantity

14. Unit Wt/Vol

a. Soil contaminated with petroleum hydrocarbons

No. 1

Type T

18

Y

b.

c.

d.

D. Additional Descriptions for Materials Listed Above
 Soil excavated from 40th Street UST Project
 4000 San Pablo Ave., Emeryville, CA

E. Handling Codes for Wastes Listed Above

03

15. Special Handling Instructions and Additional Information

16. GENERATOR'S CERTIFICATION: I certify the materials described above on this manifest are not subject to federal regulation for reporting proper disposal of Hazardous Waste.

Printed/Typed Name
 RONALD GERBER

Signature
 Ronald Gerber

Month Day Year
 8 3 94

17. Transporter 1 Acknowledgement of Receipt of Materials

Printed/Typed Name
 JIM W. SHAW

Signature
 Jim W. Shaw

Month Day Year
 8 3 94

18. Transporter 2 Acknowledgement of Receipt of Materials

Printed/Typed Name

Signature

Month Day Year

19. Discrepancy Indication Space

20. Facility Owner or Operator: Certification of receipt of waste materials covered by this manifest except as noted in Item 19.

Printed/Typed Name
 MARY BOEHL

Signature
 Mary Boehl

Month Day Year
 8 3 94

**NON-HAZARDOUS
 WASTE MANIFEST**

1. Generator's US EPA ID No.
 NOT APPLICABLE

Manifest Document No.

2. Page 1 of

Authorizaton No.
 01216

3. Generator's Name and Mailing Address
 City of Emeryville Redevelopment Agency
 2200 Powell St.; 12th Floor
 Emeryville CA 94608
 4. Generator's Phone (510) 596-4356 Attn: Ignacio Davrit

RSI B4

5. Transporter 1 Company Name
 Northern Truck and Equipment
 6. US EPA ID Number
 NOT APPLICABLE

3113

7. Transporter 2 Company Name
 8. US EPA ID Number
 NOT APPLICABLE

9. Designated Facility Name and Site Address
 B & J LANDFILL
 6426 HAY ROAD
 VACAVILLE, CA 95687
 10. US EPA ID Number
 NOT APPLICABLE

A. Transporter's Phone (510) 429-8920

B. Transporter's Phone

C. Facility's Phone

(707) 451-3276

11. Waste Shipping Name and Description

| 12. Containers | | 13. Total Quantity | 14. Unit Wt/Vol |
|----------------|-----------|--------------------|-----------------|
| No. | Type | | |
| a. 1 | T | 18 | Y |
| b. | | | |
| c. | | | |
| d. | | | |

a. Soil contaminated with petroleum hydrocarbons

D. Additional Descriptions for Materials Listed Above
 Soil excavated from 40th Street UST Project
 4000 San Pablo Ave., Emeryville, CA

E. Handling Codes for Wastes Listed Above

03

15. Special Handling Instructions and Additional Information

16. GENERATOR'S CERTIFICATION: I certify the materials described above on this manifest are not subject to federal regulations for reporting proper disposal of Hazardous Waste.

Printed/Typed Name
 RONALD GERSEN

Signature
 Ronald Gersen
 Month Day Year
 8 | 3 | 94

17. Transporter 1 Acknowledgement of Receipt of Materials
 Printed/Typed Name
 ARNOLD PAOILLA

Signature
 Arnold Paoilla
 Month Day Year
 08 | 04 | 89

18. Transporter 2 Acknowledgement of Receipt of Materials
 Printed/Typed Name

Signature
 Month Day Year

19. Discrepancy Indication Space

20. Facility Owner or Operator: Certification of receipt of waste materials covered by this manifest except as noted in Item 19.

Printed/Typed Name
 MARK BORDEN

Signature
 Mark Borden
 Month Day Year
 8 | 1 | 94

| | | | | | |
|--|--|---|---|---|---------------------------|
| NON-HAZARDOUS WASTE MANIFEST | | 1. Generator's US EPA ID No. NOT APPLICABLE | Manifest Document No. | 2. Page 1 of | Authorizaton No. 01216 |
| 3. Generator's Name and Mailing Address City of Emeryville Redevelopment Agency 2200 Powell St.; 12th Floor Emeryville CA 94608 | | | | RSI 3 | |
| 4. Generator's Phone (510) 596-4356 Attn: Ignacio Dayrit | | | | | |
| 5. Transporter 1 Company Name Northern Truck and Equipment | | 6. US EPA ID Number NOT APPLICABLE | | 3113 | |
| 7. Transporter 2 Company Name | | 8. US EPA ID Number NOT APPLICABLE | | | |
| 9. Designated Facility Name and Site Address B & J LANDFILL 6426 HAY ROAD VACAVILLE, CA 95687 | | 10. US EPA ID Number NOT APPLICABLE | | A. Transporter's Phone (510) 429-8920 B. Transporter's Phone C. Facility's Phone (707) 451-3276 | |
| 11. Waste Shipping Name and Description | | | 12. Containers | | 13. Total Quantity |
| a. Soil contaminated with petroleum hydrocarbons | | | No. | Type | 14. Unit Wt/Vol |
| | | | 1 | T | 18 Y |
| b. | | | | | |
| c. | | | | | |
| d. | | | | | |
| D. Additional Descriptions for Materials Listed Above Soil excavated from 40th Street UST Project 4000 San Pablo Ave., Emeryville, CA | | | E. Handling Codes for Wastes Listed Above 03 | | |
| 15. Special Handling Instructions and Additional Information | | | | | |
| 16. GENERATOR'S CERTIFICATION: I certify the materials described above on this manifest are not subject to federal regulations for reporting proper disposal of Hazardous Waste. | | | | | |
| Printed/Typed Name RONALD GERBER | | Signature Ronald Gerber | | Month | Day Year |
| | | | | 8 | 3 94 |
| 17. Transporter 1 Acknowledgement of Receipt of Materials | | | | | |
| Printed/Typed Name JAN SMITH | | Signature Jan Smith | | Month | Day Year |
| | | | | 08 | 04 94 |
| 18. Transporter 2 Acknowledgement of Receipt of Materials | | | | | |
| Printed/Typed Name | | Signature | | Month | Day Year |
| | | | | | |
| 19. Discreponcy Indication Space | | | | | |
| 20. Facility Owner or Operator: Certification of receipt of waste materials covered by this manifest except as noted in Item 19. | | | | | |
| Printed/Typed Name MARY BORDEN | | Signature Mary Borden | | Month | Day Year |
| | | | | 8 | 4 94 |

GENERATOR

TRANSPORTER

FACILITY

**NON-HAZARDOUS
 WASTE MANIFEST**

1. Generator's US EPA ID No.
 NOT APPLICABLE

Manifest Document No.

2. Page 1 of

Authorizaton No.
 01216

3. Generator's Name and Mailing Address
 City of Emeryville Redevelopment Agency
 2200 Powell St.; 12th Floor
 Emeryville CA 94608

4. Generator's Phone (510) 596-4356 Attn: Ignacio Dayrit

5. Transporter 1 Company Name
 Northern Truck and Equipment

6. US EPA ID Number
 NOT APPLICABLE

3113

7. Transporter 2 Company Name

8. US EPA ID Number
 NOT APPLICABLE

9. Designated Facility Name and Site Address

B & J LANDFILL
 6426 HAY ROAD
 VACAVILLE, CA 95687

10. US EPA ID Number
 NOT APPLICABLE

A. Transporter's Phone (510) 429-8920

B. Transporter's Phone

C. Facility's Phone
 (707) 451-3276

11. Waste Shipping Name and Description

a. Soil contaminated with petroleum hydrocarbons

| 12. Containers | | 13. Total Quantity | 14. Unit Wt/Vol |
|----------------|------|--------------------|-----------------|
| No. | Type | | |
| 1 | T | 18 | Y |
| . | . | . | . |
| . | . | . | . |
| . | . | . | . |
| . | . | . | . |

D. Additional Descriptions for Materials Listed Above

Soil excavated from 40th Street UST Project
 4000 San Pablo Ave., Emeryville, CA

E. Handling Codes for Wastes Listed Above

03

15. Special Handling Instructions and Additional Information

16. GENERATOR'S CERTIFICATION: I certify the materials described above on this manifest are not subject to federal regulations for reporting proper disposal of Hazardous Waste.

Printed/Typed Name
 RONALD GERBER

Signature
 Ronald Gerber
 Month Day Year
 8 3 94

17. Transporter 1 Acknowledgement of Receipt of Materials

Printed/Typed Name
 Bud Lawrence

Signature
 Bud Lawrence
 Month Day Year
 08 04 94

18. Transporter 2 Acknowledgement of Receipt of Materials

Printed/Typed Name

Signature
 Month Day Year

19. Discrepancy Indication Space

20. Facility Owner or Operator: Certification of receipt of waste materials covered by this manifest except as noted in Item 19.

Printed/Typed Name
 MARY BORDEN

Signature
 Mary Borden
 Month Day Year
 1 10 94

| | | | | | |
|--|---------------------------------------|---|---|--------------------|---------------------------|
| NON-HAZARDOUS WASTE MANIFEST | | 1. Generator's US EPA ID No. NOT APPLICABLE | Manifest Document No. | 2. Page 1 of | Authorizaton No. 01216 |
| 3. Generator's Name and Mailing Address City of Emeryville Redevelopment Agency 2200 Powell St.; 12th Floor Emeryville, CA 94608 | | | <i>RSI 295</i> | | |
| 4. Generator's Phone (510) 596-4356 Attn: Ignacio Dayrit | | | | | |
| 5. Transporter 1 Company Name Northern Truck and Equipment | 6. US EPA ID Number NOT APPLICABLE | 3113 | | | |
| 7. Transporter 2 Company Name | 8. US EPA ID Number NOT APPLICABLE | | | | |
| 9. Designated Facility Name and Site Address B & J LANDFILL 6426 HAY ROAD VACAVILLE, CA 95687 | | 10. US EPA ID Number NOT APPLICABLE | A. Transporter's Phone (510) 429-8920 | | |
| | | | B. Transporter's Phone | | |
| | | | C. Facility's Phone (707) 451-3276 | | |
| 11. Waste Shipping Name and Description | | 12. Containers | | 13. Total Quantity | 14. Unit Wt/Vol |
| a. Soil contaminated with petroleum hydrocarbons | | No. | Type | | |
| | | 1 | T | 18 | Y |
| b. | | | | | |
| c. | | | | | |
| d. | | | | | |
| D. Additional Descriptions for Materials Listed Above Soil excavated from 40th Street UST Project 4000 San Pablo Ave., Emeryville, CA | | | E. Handling Codes for Wastes Listed Above 03 | | |
| 15. Special Handling Instructions and Additional Information | | | | | |
| 16. GENERATOR'S CERTIFICATION: I certify the materials described above on this manifest are not subject to federal regulations for reporting proper disposal of Hazardous Waste. | | | | | |
| Printed/Typed Name RONALD GERBER | | Signature <i>Ronald Gerber</i> | | Month | Day Year |
| | | | | 8 | 4 94 |
| 17. Transporter 1 Acknowledgement of Receipt of Materials | | | | | |
| Printed/Typed Name <i>Pat Hurley</i> | | Signature <i>Pat Hurley</i> | | Month | Day Year |
| | | | | 8 | 4 94 |
| 18. Transporter 2 Acknowledgement of Receipt of Materials | | | | | |
| Printed/Typed Name | | Signature | | Month | Day Year |
| | | | | | |
| 19. Discrepancy Indication Space | | | | | |
| 20. Facility Owner or Operator: Certification of receipt of waste materials covered by this manifest except as noted in Item 19. | | | | | |
| Printed/Typed Name MARY BORDEN | | Signature <i>Mary Borden</i> | | Month | Day Year |
| | | | | 8 | 4 94 |

ORIGINAL-RETURN TO GENERATOR

| | | | | | | |
|--|--|---|---|----------------|---------------------------|-----------------|
| NON-HAZARDOUS WASTE MANIFEST | | 1. Generator's US EPA ID No. NOT APPLICABLE | Manifest Document No. | 2. Page 1 of 1 | Authorizaton No. 01216 | |
| 3. Generator's Name and Mailing Address City of Emeryville Redevelopment Agency 2200 Powell St.; 12th Floor Emeryville CA 94608 | | | RSI. | | | |
| 4. Generator's Phone (510) 596-4356 Attn: Ignacio Dayrit | | | | | | |
| 5. Transporter 1 Company Name Northern Truck and Equipment | 6. US EPA ID Number NOT APPLICABLE | 091 | | | | |
| 7. Transporter 2 Company Name | 8. US EPA ID Number NOT APPLICABLE | | | | | |
| 9. Designated Facility Name and Site Address B & J LANDFILL 6426 HAY ROAD VACAVILLE, CA 95687 | | 10. US EPA ID Number NOT APPLICABLE | A. Transporter's Phone (510) 429-8920 | | | |
| | | | B. Transporter's Phone | | | |
| | | | C. Facility's Phone (707) 451-3276 | | | |
| 11. Waste Shipping Name and Description a. Soil contaminated with petroleum hydrocarbons b. c. d. | | | 12. Containers | | 13. Total Quantity | 14. Unit Wt/Vol |
| | | | No. | Type | | |
| | | | 1 | T | 18 | Y |
| | | | . | . | . | . |
| | | | . | . | . | . |
| D. Additional Descriptions for Materials Listed Above Soil excavated from 40th Street UST Project 4000 San Pablo Ave., Emeryville, CA | | | E. Handling Codes for Wastes Listed Above 03 | | | |
| 15. Special Handling Instructions and Additional Information | | | | | | |
| 16. GENERATOR'S CERTIFICATION: I certify the materials described above on this manifest are not subject to federal regulations for reporting proper disposal of Hazardous Waste. | | | | | | |
| Printed/Typed Name RONALD GERBER | | Signature <i>Ronald Gerber</i> | | Month 8 | Day 4 | Year 94 |
| 17. Transporter 1 Acknowledgement of Receipt of Materials | | | | | | |
| Printed/Typed Name CJ BLUNDELL | | Signature <i>CJ Blundell</i> | | Month 10 | Day 9 | Year 94 |
| 18. Transporter 2 Acknowledgement of Receipt of Materials | | | | | | |
| Printed/Typed Name | | Signature | | Month | Day | Year |
| 19. Discrepancy Indication Space | | | | | | |
| 20. Facility Owner or Operator: Certification of receipt of waste materials covered by this manifest except as noted in Item 19. | | | | | | |
| Printed/Typed Name SILVA FISHER | | Signature <i>Silva Fisher</i> | | Month 08 | Day 04 | Year 94 |

ORIGINAL-RETURN TO GENERATOR

| | | | | | | |
|--|--|---|---|---------------------------------------|---------------------------|--------------------|
| NON-HAZARDOUS WASTE MANIFEST | | 1. Generator's US EPA ID No. NOT APPLICABLE | Manifest Document No. | 2. Page 1 of | Authorizaton No. 01216 | |
| 3. Generator's Name and Mailing Address City of Emeryville Redevelopment Agency 2200 Powell St.; 12th Floor Emeryville CA 94608 | | | | 491 | | |
| 4. Generator's Phone (510) 596-4356 Attn: Ignacio Dayrit | | | | | | |
| 5. Transporter 1 Company Name Northern Truck and Equipment | | 6. US EPA ID Number NOT APPLICABLE | | 3113 | | |
| 7. Transporter 2 Company Name | | 8. US EPA ID Number NOT APPLICABLE | | | | |
| 9. Designated Facility Name and Site Address B & J LANDFILL 6426 HAY ROAD VACAVILLE, CA 95687 | | 10. US EPA ID Number NOT APPLICABLE | | A. Transporter's Phone (510)429-8920 | | |
| | | | | B. Transporter's Phone | | |
| | | | | C. Facility's Phone (707) 451-3276 | | |
| 11. Waste Shipping Name and Description a. Soil contaminated with petroleum hydrocarbons b. c. d. | | | 12. Containers | | 14. Unit Wt/Vol | |
| | | | No. | Type | | 13. Total Quantity |
| | | | 1 | T | | 18 |
| | | | . | . | | . |
| | | | . | . | | . |
| D. Additional Descriptions for Materials Listed Above Soil excavated from 40th Street UST Project 4000 San Pablo Ave., Emeryville, CA | | | E. Handling Codes for Wastes Listed Above 03 | | | |
| 15. Special Handling Instructions and Additional Information | | | | | | |
| 16. GENERATOR'S CERTIFICATION: I certify the materials described above on this manifest are not subject to federal regulations for reporting proper disposal of Hazardous Waste. | | | | | | |
| Printed/Typed Name RONALD GERBER | | Signature <i>Ronald Gerber</i> | | Month | Day Year | |
| | | | | 8 | 1 1994 | |
| 17. Transporter 1 Acknowledgement of Receipt of Materials | | Printed/Typed Name DAVID STEVENS | | Signature <i>David Stevens</i> | | |
| | | | | Month | Day Year | |
| | | | | 08 | 04 1994 | |
| 18. Transporter 2 Acknowledgement of Receipt of Materials | | Printed/Typed Name | | Signature | | |
| | | | | Month | Day Year | |
| | | | | . | . | |
| 19. Discrepancy Indication Space | | | | | | |
| 20. Facility Owner or Operator: Certification of receipt of waste materials covered by this manifest except as noted in Item 19. | | | | | | |
| Printed/Typed Name MARY BORDEN | | Signature <i>Mary Borden</i> | | Month | Day Year | |
| | | | | 08 | 04 1994 | |

ORIGINAL-RETURN TO GENERATOR

| | | | | | |
|--|--|---|---|-----------------|---------------------------|
| NON-HAZARDOUS WASTE MANIFEST | | 1. Generator's US EPA ID No. NOT APPLICABLE | Manifest Document No. | 2. Page 1 of | Authorizaton No. 01216 |
| 3. Generator's Name and Mailing Address City of Emeryville Redevelopment Agency 2200 Powell St.; 12th Floor Emeryville, CA 94608 | | | | RSI 391 | |
| 4. Generator's Phone (510) 596-4356 Attn: Ignacio Dayrit | | | | | |
| 5. Transporter 1 Company Name Northern Truck and Equipment | 6. US EPA ID Number NOT APPLICABLE | 3113 | | | |
| 7. Transporter 2 Company Name | 8. US EPA ID Number NOT APPLICABLE | | | | |
| 9. Designated Facility Name and Site Address B & J LANDFILL 6426 HAY ROAD VACAVILLE, CA 95687 | | 10. US EPA ID Number NOT APPLICABLE | A. Transporter's Phone (510) 429-8920 | | |
| | | | B. Transporter's Phone | | |
| | | | C. Facility's Phone (707) 451-3276 | | |
| 11. Waste Shipping Name and Description | | 12. Containers | 13. Total Quantity | 14. Unit Wt/Vol | |
| a. Soil contaminated with petroleum hydrocarbons | | No. Type | | Y | |
| | | 1 T | 18 | | |
| b. | | | | | |
| c. | | | | | |
| d. | | | | | |
| D. Additional Descriptions for Materials Listed Above Soil excavated from 40th Street UST Project 4000 San Pablo Ave., Emeryville, CA | | | E. Handling Codes for Wastes Listed Above 03 | | |
| 15. Special Handling Instructions and Additional Information | | | | | |
| 16. GENERATOR'S CERTIFICATION: I certify the materials described above on this manifest are not subject to federal regulations for reporting proper disposal of Hazardous Waste. | | | | | |
| Printed/Typed Name RONALD GERBER | | Signature <i>Ronald Gerber</i> | | Month | Day Year |
| | | | | 8 | 4 94 |
| 17. Transporter 1 Acknowledgement of Receipt of Materials | | | | | |
| Printed/Typed Name PHIL TRUST | | Signature <i>Phil Trust</i> | | Month | Day Year |
| | | | | 8 | 4 94 |
| 18. Transporter 2 Acknowledgement of Receipt of Materials | | | | | |
| Printed/Typed Name | | Signature | | Month | Day Year |
| | | | | | |
| 19. Discrepancy Indication Space | | | | | |
| 20. Facility Owner or Operator: Certification of receipt of waste materials covered by this manifest except as noted in Item 19. | | | | | |
| Printed/Typed Name MAY BORDEN | | Signature <i>May Borden</i> | | Month | Day Year |
| | | | | 1 | 8 94 |

ORIGINAL-RETURN TO GENERATOR

| | | | | | |
|--|--|---|-----------------------|---------------------------------------|---------------------------|
| NON-HAZARDOUS WASTE MANIFEST | | 1. Generator's US EPA ID No. NOT APPLICABLE | Manifest Document No. | 2. Page 1 of | Authorizaton No. 01216 |
| 3. Generator's Name and Mailing Address City of Emeryville Redevelopment Agency 2200 Powell St.; 12th Floor Emeryville, CA 94608 | | | | RSI | |
| 4. Generator's Phone (510) 596-4356 Attn: Ignacio Dayrit | | | | | |
| 5. Transporter 1 Company Name Northern Truck and Equipment | | 6. US EPA ID Number NOT APPLICABLE | | 289 | |
| 7. Transporter 2 Company Name | | 8. US EPA ID Number NOT APPLICABLE | | | |
| 9. Designated Facility Name and Site Address B & J LANDFILL 6426 HAY ROAD VACAVILLE, CA 95687 | | 10. US EPA ID Number NOT APPLICABLE | | A. Transporter's Phone (510) 429-8920 | |
| 11. Waste Shipping Name and Description | | | | B. Transporter's Phone | |
| | | | | C. Facility's Phone (707) 451-3276 | |
| a. Soil contaminated with petroleum hydrocarbons | | 12. Containers | | 13. Total Quantity | |
| | | | | 14. Unit Wt/Vol | |
| | | | | 1 | |
| | | | | T | |
| | | | | 18 | |
| Y | | | | | |
| D. Additional Descriptions for Materials Listed Above Soil excavated from 40th Street UST Project 4000 San Pablo Ave., Emeryville, CA | | E. Handling Codes for Wastes Listed Above 03 | | | |
| 15. Special Handling Instructions and Additional Information | | | | | |
| 16. GENERATOR'S CERTIFICATION: I certify the materials described above on this manifest are not subject to federal regulations for reporting proper disposal of Hazardous Waste. | | | | | |
| Printed/Typed Name Ronald Gerber | | Signature Ronald Gerber | | Month Day Year 8/1/94 | |
| 17. Transporter 1 Acknowledgement of Receipt of Materials | | Printed/Typed Name Jim Brooks | | Signature Jim Brooks | |
| 18. Transporter 2 Acknowledgement of Receipt of Materials | | Printed/Typed Name | | Signature | |
| 19. Discrepancy Indication Space | | | | | |
| 20. Facility Owner or Operator: Certification of receipt of waste materials covered by this manifest except as noted in Item 19. | | | | | |
| Printed/Typed Name Mary Borden | | Signature Mary Borden | | Month Day Year 1-81-415-4 | |

ORIGINAL-RETURN TO GENERATOR

| | | | | | |
|--|--|--|---|----------------------------|---------------------------|
| NON-HAZARDOUS WASTE MANIFEST | | 1. Generator's US EPA ID No. NOT APPLICABLE | Manifest Document No. | 2. Page 1 of | Authorizaton No. 01216 |
| 3. Generator's Name and Mailing Address City of Emeryville Redevelopment Agency 2200 Powell St.; 12th Floor Emeryville, CA 94608 | | 4. Generator's Phone (510) 596-4356 Attn: Ignacio Dayrit | | | |
| 5. Transporter 1 Company Name Northern Truck and Equipment | 6. US EPA ID Number NOT APPLICABLE | 3113 | | | |
| 7. Transporter 2 Company Name | 8. US EPA ID Number NOT APPLICABLE | | | | |
| 9. Designated Facility Name and Site Address B & J LANDFILL 6426 HAY ROAD VACAVILLE, CA 95687 | | 10. US EPA ID Number NOT APPLICABLE | A. Transporter's Phone (510) 429-8920 B. Transporter's Phone C. Facility's Phone (707) 451-3276 | | |
| 11. Waste Shipping Name and Description | | 12. Containers | 13. Total Quantity | 14. Unit Wt/Val | |
| a. Soil contaminated with petroleum hydrocarbons | | No. 1 | Type T | 18 | Y |
| b. | | | | | |
| c. | | | | | |
| d. | | | | | |
| D. Additional Descriptions for Materials Listed Above Soil excavated from 40th Street UST Project 4000 San Pablo Ave., Emeryville, CA | | E. Handling Codes for Wastes Listed Above 03 | | | |
| 15. Special Handling Instructions and Additional Information | | | | | |
| 16. GENERATOR'S CERTIFICATION: I certify the materials described above on this manifest are not subject to federal regulations for reporting proper disposal of Hazardous Waste. | | | | | |
| Printed/Typed Name RONALD GERBER | | Signature <i>Ronald Gerber</i> | | Month Day Year 8 4 94 | |
| 17. Transporter 1 Acknowledgement of Receipt of Materials | | | | | |
| Printed/Typed Name Charlie Collins | | Signature <i>Charlie Collins</i> | | Month Day Year 08 05 94 | |
| 18. Transporter 2 Acknowledgement of Receipt of Materials | | | | | |
| Printed/Typed Name | | Signature | | Month Day Year | |
| 19. Discrepancy Indication Space | | | | | |
| 20. Facility Owner or Operator: Certification of receipt of waste materials covered by this manifest except as noted in Item 19. | | | | | |
| Printed/Typed Name Will A Fisher | | Signature <i>Will A Fisher</i> | | Month Day Year 08 10 94 | |

ORIGINAL-RETURN TO GENERATOR

| | | | | |
|-------------------------------------|---|-----------------------|--------------|---------------------------|
| NON-HAZARDOUS WASTE MANIFEST | 1. Generator's US EPA ID No. NOT APPLICABLE | Manifest Document No. | 2. Page 1 of | Authorizaton No. 01216 |
|-------------------------------------|---|-----------------------|--------------|---------------------------|

| | | |
|---|---|---|
| 3. Generator's Name and Mailing Address City of Emeryville Redevelopment Agency 2200 Powell St.; 12th Floor Emeryville, CA 94608 | | RSI. |
| 4. Generator's Phone (510) 596-4356 Attn: Ignacio Dayrit | | |
| 5. Transporter 1 Company Name Northern Truck and Equipment | 6. US EPA ID Number NOT APPLICABLE | 3113 591 |
| 7. Transporter 2 Company Name | 8. US EPA ID Number NOT APPLICABLE | |
| 9. Designated Facility Name and Site Address B & J LANDFILL 6426 HAY ROAD VACAVILLE, CA 95687 | 10. US EPA ID Number NOT APPLICABLE | A. Transporter's Phone (510) 429-8920 B. Transporter's Phone C. Facility's Phone (707) 451-3276 |

| 11. Waste Shipping Name and Description | 12. Containers | | 13. Total Quantity | 14. Unit Wt/Vol |
|--|----------------|------|--------------------|-----------------|
| | No. | Type | | |
| a. Soil contaminated with petroleum hydrocarbons | 1 | T | 18 | Y |
| b. | | | | |
| c. | | | | |
| d. | | | | |

| | |
|---|---|
| D. Additional Descriptions for Materials Listed Above Soil excavated from 40th Street UST Project 4000 San Pablo Ave., Emeryville, CA | E. Handling Codes for Wastes Listed Above 03 |
|---|---|

15. Special Handling Instructions and Additional Information

16. GENERATOR'S CERTIFICATION: I certify the materials described above on this manifest are not subject to federal regulations for reporting proper disposal of Hazardous Waste.

| | | | | |
|-------------------------------------|-----------------------------------|------------|----------|------------|
| Printed/Typed Name RONALD GERBER | Signature <i>Ronald Gerber</i> | Month 8 | Day 7 | Year 97 |
|-------------------------------------|-----------------------------------|------------|----------|------------|

| | | | | |
|---|--------------------------------|------------|----------|------------|
| 17. Transporter 1 Acknowledgement of Receipt of Materials Printed/Typed Name John Decca | Signature <i>John Decca</i> | Month 8 | Day 4 | Year 97 |
|---|--------------------------------|------------|----------|------------|

| | | | | |
|---|-----------|-------|-----|------|
| 18. Transporter 2 Acknowledgement of Receipt of Materials Printed/Typed Name | Signature | Month | Day | Year |
|---|-----------|-------|-----|------|

19. Discrepancy Indication Space

| | | | | |
|--|------------------------------------|-------------|-----------|------------|
| 20. Facility Owner or Operator: Certification of receipt of waste materials covered by this manifest except as noted in Item 19. | | | | |
| Printed/Typed Name Will D. Fisher | Signature <i>Will D. Fisher</i> | Month 10 | Day 14 | Year 97 |

ORIGINAL-RETURN TO GENERATOR

| | | | | | |
|---|--|---|---|---|---------------------------|
| NON-HAZARDOUS WASTE MANIFEST | | 1. Generator's US EPA ID No. NOT APPLICABLE | Manifest Document No. | 2. Page 1 of | Authorizaton No. 01216 |
| 3. Generator's Name and Mailing Address City of Emeryville Redevelopment Agency 2200 Powell St.; 12th Floor Emeryville, CA 94608 4. Generator's Phone (510) 596-4356 Attn: Ignacio Dayrit | | | | COLLINS # 6 | |
| 5. Transporter 1 Company Name Northern Truck and Equipment | | 6. US EPA ID Number NOT APPLICABLE | | 3113 | |
| 7. Transporter 2 Company Name | | 8. US EPA ID Number NOT APPLICABLE | | | |
| 9. Designated Facility Name and Site Address B & J LANDFILL 6426 HAY ROAD VACAVILLE, CA 95687 | | 10. US EPA ID Number NOT APPLICABLE | | A. Transporter's Phone (510) 429-8920 B. Transporter's Phone C. Facility's Phone (707) 451-3276 | |
| 11. Waste Shipping Name and Description | | | 12. Containers | 13. Total Quantity | 14. Unit Wt/Vol |
| a. Soil contaminated with petroleum hydrocarbons | | | No. 1 | Type T | 18 Y |
| b. | | | . | . | . |
| c. | | | . | . | . |
| d. | | | . | . | . |
| D. Additional Descriptions for Materials Listed Above Soil excavated from 40th Street UST Project 4000 San Pablo Ave., Emeryville, CA | | | E. Handling Codes for Wastes Listed Above 03 | | |
| 15. Special Handling Instructions and Additional Information | | | | | |
| 16. GENERATOR'S CERTIFICATION: I certify the materials described above on this manifest are not subject to federal regulations for reporting proper disposal of Hazardous Waste. | | | | | |
| Printed/Typed Name RONALD GERBER | | | Signature <i>Ronald Gerber</i> | | Month Day Year 8 4 94 |
| 17. Transporter 1 Acknowledgement of Receipt of Materials | | | Signature | | Month Day Year |
| Printed/Typed Name | | | Signature | | Month Day Year |
| 18. Transporter 2 Acknowledgement of Receipt of Materials | | | Signature | | Month Day Year |
| Printed/Typed Name | | | Signature | | Month Day Year |
| 19. Discrepancy Indication Space | | | | | |
| 20. Facility Owner or Operator: Certification of receipt of waste materials covered by this manifest except as noted in Item 19. | | | | | |
| Printed/Typed Name MAY BODEN | | | Signature <i>May Boden</i> | | Month Day Year 8 4 94 |

ORIGINAL-RETURN TO GENERATOR

| NON-HAZARDOUS WASTE MANIFEST | | 1. Generator's US EPA ID No. NOT APPLICABLE | Manifest Document No. | 2. Page 1 of | Authorizaton No. 01216 |
|--|---------------------------------------|--|---|------------------------------------|---------------------------|
| 3. Generator's Name and Mailing Address City of Emeryville Redevelopment Agency 2200 Powell St.; 12th Floor Emeryville, CA 94608 | | | | | |
| 4. Generator's Phone (510) 596-4356 Attn: Ignacio Dayrit | | | | | |
| 5. Transporter 1 Company Name Northern Truck and Equipment | 6. US EPA ID Number NOT APPLICABLE | | | R64 | |
| 7. Transporter 2 Company Name | 8. US EPA ID Number NOT APPLICABLE | | | | |
| 9. Designated Facility Name and Site Address B & J LANDFILL 6426 HAY ROAD VACAVILLE, CA 95687 | | 10. US EPA ID Number NOT APPLICABLE | A. Transporter's Phone (510) 429-8920 | | B. Transporter's Phone |
| | | | | C. Facility's Phone (707) 451-3276 | |
| 11. Waste Shipping Name and Description | | 12. Containers | | 13. Total Quantity | 14. Unit Wt/Vol |
| a. Soil contaminated with petroleum hydrocarbons | | No. | Type | 18 | Y |
| b. | | | | | |
| c. | | | | | |
| d. | | | | | |
| D. Additional Descriptions for Materials Listed Above Soil excavated from 40th Street UST Project 4000 San Pablo Ave., Emeryville, CA | | | E. Handling Codes for Wastes Listed Above 03 | | |
| 15. Special Handling Instructions and Additional Information | | | | | |
| 16. GENERATOR'S CERTIFICATION: I certify the materials described above on this manifest are not subject to federal regulations for reporting proper disposal of Hazardous Waste. | | | | | |
| Printed/Typed Name RONALD GERSEN | | Signature Ronald Gersen | | Month 8 | Day 4 |
| 17. Transporter 1 Acknowledgement of Receipt of Materials | | Signature Craig Rice | | Month 8 | Day 4 |
| 18. Transporter 2 Acknowledgement of Receipt of Materials | | Signature | | Month | Day |
| 19. Discrepancy Indication Space | | | | | |
| 20. Facility Owner or Operator: Certification of receipt of waste materials covered by this manifest except as noted in Item 19. | | | | | |
| Printed/Typed Name Bill A Fisher | | Signature Bill A Fisher | | Month 10 | Day 14 |

GENERATOR

TRANSPORTER

FACILITY

| | | | | | |
|--|--|--|---|---|---------------------------|
| NON-HAZARDOUS WASTE MANIFEST | | 1. Generator's US EPA ID No. NOT APPLICABLE | Manifest Document No. | 2. Page 1 of | Authorizaton No. 01216 |
| 3. Generator's Name and Mailing Address City of Emeryville Redevelopment Agency 2200 Powell St.; 12th Floor Emeryville CA 94608 | | 4. Generator's Phone (510) 596-4356 Attn: Ignacio Dayrit | | | |
| 5. Transporter 1 Company Name Northern Truck and Equipment | 6. US EPA ID Number NOT APPLICABLE | 7. Transporter 2 Company Name | | 8. US EPA ID Number NOT APPLICABLE | 3113 RB4 |
| 9. Designated Facility Name and Site Address B & J LANDFILL 6426 HAY ROAD VACAVILLE, CA 95687 | | 10. US EPA ID Number NOT APPLICABLE | | A. Transporter's Phone (510) 429-8920 B. Transporter's Phone C. Facility's Phone (707) 451-3276 | |
| 11. Waste Shipping Name and Description | | | 12. Containers | 13. Total Quantity | 14. Unit Wt/Vol |
| a. Soil contaminated with petroleum hydrocarbons | | | No. Type 1 T | 18 | Y |
| b. | | | . | . | . |
| c. | | | . | . | . |
| d. | | | . | . | . |
| D. Additional Descriptions for Materials Listed Above Soil excavated from 40th Street UST Project 4000 San Pablo Ave., Emeryville, CA | | | E. Handling Codes for Wastes Listed Above 03 | | |
| 15. Special Handling Instructions and Additional Information | | | | | |
| 16. GENERATOR'S CERTIFICATION: I certify the materials described above on this manifest are not subject to federal regulations for reporting proper disposal of Hazardous Waste. | | | | | |
| Printed/Typed Name RONALD GERBER | | Signature <i>Ronald Gerber</i> | | Month 8 | Day Year 4 94 |
| 17. Transporter 1 Acknowledgement of Receipt of Materials Printed/Typed Name DAVID CLARK | | Signature <i>D Clark</i> | | Month 8 | Day Year 4 94 |
| 18. Transporter 2 Acknowledgement of Receipt of Materials Printed/Typed Name | | Signature | | Month | Day Year |
| 19. Discrepancy Indication Space | | | | | |
| 20. Facility Owner or Operator: Certification of receipt of waste materials covered by this manifest except as noted in Item 19. | | | | | |
| Printed/Typed Name MARY BORDEN | | Signature <i>Mary Borden</i> | | Month 8 | Day Year 4 94 |

GENERAL INFORMATION TRANSPORTER FACILITY

ORIGINAL-RETURN TO GENERATOR

| NON-HAZARDOUS WASTE MANIFEST | | 1. Generator's US EPA ID No. NOT APPLICABLE | Manifest Document No. | 2. Page 1 of | Authorizaton No. 01216 |
|--|---------------------------------------|---|---------------------------------------|------------------------------------|---------------------------|
| 3. Generator's Name and Mailing Address City of Emeryville Redevelopment Agency 2200 Powell St.; 12th Floor Emeryville, CA 94608 | | | | | |
| 4. Generator's Phone (510) 596-4356 Attn: Ignacio Dayrit | | | | | |
| 5. Transporter 1 Company Name Northern Truck and Equipment | 6. US EPA ID Number NOT APPLICABLE | | | 3113 <i>Rege</i> | |
| 7. Transporter 2 Company Name | 8. US EPA ID Number NOT APPLICABLE | | | | |
| 9. Designated Facility Name and Site Address B & J LANDFILL 6426 HAY ROAD VACAVILLE, CA 95687 | | 10. US EPA ID Number NOT APPLICABLE | A. Transporter's Phone (510) 429-8920 | | B. Transporter's Phone |
| | | | | C. Facility's Phone (707) 451-3276 | |
| 11. Waste Shipping Name and Description | | 12. Containers No. | Type | 13. Total Quantity | 14. Unit Wt/Vol |
| a. Soil contaminated with petroleum hydrocarbons | | 1 | T | 18 | Y |
| b. | | | | | |
| c. | | | | | |
| d. | | | | | |
| D. Additional Descriptions for Materials Listed Above Soil excavated from 40th Street UST Project 4000 San Pablo Ave., Emeryville, CA | | E. Handling Codes for Wastes Listed Above 03 | | | |
| 15. Special Handling Instructions and Additional Information | | | | | |
| 16. GENERATOR'S CERTIFICATION: I certify the materials described above on this manifest are not subject to federal regulations for reporting proper disposal of Hazardous Waste. | | | | | |
| Printed/Typed Name RONALD GERBER | | Signature <i>Ronald Gerber</i> | | Month Day Year 08 04 94 | |
| 17. Transporter 1 Acknowledgement of Receipt of Materials Printed/Typed Name <i>Rege</i> | | Signature <i>[Signature]</i> | | Month Day Year 08 04 94 | |
| 18. Transporter 2 Acknowledgement of Receipt of Materials Printed/Typed Name | | Signature | | Month Day Year | |
| 19. Discrepancy Indication Space | | | | | |
| 20. Facility Owner or Operator: Certification of receipt of waste materials covered by this manifest except as noted in Item 19. | | | | | |
| Printed/Typed Name Will H. Fisher | | Signature <i>Will H. Fisher</i> | | Month Day Year 08 04 94 | |

ORIGINAL-RETURN TO GENERATOR

| | | | | |
|-------------------------------------|---|-----------------------|--------------|---------------------------|
| NON-HAZARDOUS WASTE MANIFEST | 1. Generator's US EPA ID No. NOT APPLICABLE | Manifest Document No. | 2. Page 1 of | Authorizaton No. 01216 |
|-------------------------------------|---|-----------------------|--------------|---------------------------|

| | |
|--|--|
| 3. Generator's Name and Mailing Address City of Emeryville Redevelopment Agency 2200 Powell St.; 12th Floor Emeryville CA 94608 | |
| 4. Generator's Phone (510) 596-4356 Attn: Ignacio Dayrit | |

| | | | |
|---|--|------|--|
| 5. Transporter 1 Company Name Northern Truck and Equipment | 6. US EPA ID Number NOT APPLICABLE | 3113 | |
| 7. Transporter 2 Company Name | 8. US EPA ID Number NOT APPLICABLE | | |

| | | |
|--|---|--|
| 9. Designated Facility Name and Site Address B & J LANDFILL 6426 HAY ROAD VACAVILLE, CA 95687 | 10. US EPA ID Number NOT APPLICABLE | A. Transporter's Phone (510)429-8920 B. Transporter's Phone C. Facility's Phone (707) 451-3276 |
|--|---|--|

| 11. Waste Shipping Name and Description | 12. Containers | | 13. Total Quantity | 14. Unit Wt/Vol |
|--|----------------|------|--------------------|-----------------|
| | No. | Type | | |
| a. Soil contaminated with petroleum hydrocarbons | 1 | T | 18 | Y |
| b. | . | . | . | . |
| c. | . | . | . | . |
| d. | . | . | . | . |

| | |
|---|---|
| D. Additional Descriptions for Materials Listed Above Soil excavated from 40th Street UST Project 4000 San Pablo Ave., Emeryville, CA | E. Handling Codes for Wastes Listed Above 03 |
|---|---|

15. Special Handling Instructions and Additional Information

16. GENERATOR'S CERTIFICATION: I certify the materials described above on this manifest are not subject to federal regulations for reporting proper disposal of Hazardous Waste.

| | | |
|--|-----------------------------------|----------------------------|
| Printed/Typed Name RONALD GERBER | Signature <i>Ronald Gerber</i> | Month Day Year 08 04 99 |
|--|-----------------------------------|----------------------------|

| | | |
|---|-----------|----------------|
| 17. Transporter 1 Acknowledgement of Receipt of Materials Printed/Typed Name | Signature | Month Day Year |
|---|-----------|----------------|

| | | |
|--|----------------------------------|----------------------------|
| 18. Transporter 2 Acknowledgement of Receipt of Materials Printed/Typed Name LARRY CONRAD | Signature <i>Larry Conrad</i> | Month Day Year 08 04 99 |
|--|----------------------------------|----------------------------|

19. Discrepancy Indication Space

20. Facility Owner or Operator: Certification of receipt of waste materials covered by this manifest except as noted in item 19.

| | | |
|---|--------------------------------|----------------------------|
| Printed/Typed Name MARY BOEHL | Signature <i>Mary Boehl</i> | Month Day Year 08 04 99 |
|---|--------------------------------|----------------------------|

| | | | | | |
|--|--|---|-----------------------|--|---------------------------|
| NON-HAZARDOUS WASTE MANIFEST | | 1. Generator's US EPA ID No. NOT APPLICABLE | Manifest Document No. | 2. Page 1 of | Authorizaton No. 01216 |
| 3. Generator's Name and Mailing Address City of Emeryville Redevelopment Agency 2200 Powell St.; 12th Floor Emeryville CA 94608 | | 4. Generator's Phone (510) 596-4356 | | Attn: Ignacio Dayrit | |
| 5. Transporter 1 Company Name Northern Truck and Equipment | | 6. US EPA ID Number NOT APPLICABLE | | 3113 | #73 |
| 7. Transporter 2 Company Name | | 8. US EPA ID Number NOT APPLICABLE | | | |
| 9. Designated Facility Name and Site Address B & J LANDFILL 6426 HAY ROAD VACAVILLE, CA 95687 | | 10. US EPA ID Number NOT APPLICABLE | | A. Transporter's Phone (510)429-8920 B. Transporter's Phone C. Facility's Phone (707) 451-3276 | |
| 11. Waste Shipping Name and Description | | 12. Containers | 13. Total Quantity | 14. Unit Wt/Vol | |
| a. Soil contaminated with petroleum hydrocarbons | | No. 1 | Type T | 18 | Y |
| b. | | . | . | . | . |
| c. | | . | . | . | . |
| d. | | . | . | . | . |
| D. Additional Descriptions for Materials Listed Above Soil excavated from 40th Street UST Project 4000 San Pablo Ave., Emeryville, CA | | E. Handling Codes for Wastes Listed Above 03 | | | |
| 15. Special Handling Instructions and Additional Information | | | | | |
| 16. GENERATOR'S CERTIFICATION: I certify the materials described above on this manifest are not subject to federal regulations for reporting proper disposal of Hazardous Waste. | | | | | |
| Printed/Typed Name RONALD GERBER | | Signature <i>Ronald Gerber</i> | | Month Day Year 08 04 94 | |
| 17. Transporter 1 Acknowledgement of Receipt of Materials Printed/Typed Name <i>Scott A Silva</i> | | Signature <i>Scott A Silva</i> | | Month Day Year 08 04 94 | |
| 18. Transporter 2 Acknowledgement of Receipt of Materials Printed/Typed Name | | Signature | | Month Day Year | |
| 19. Discrepancy Indication Space | | | | | |
| 20. Facility Owner or Operator: Certification of receipt of waste materials covered by this manifest except as noted in Item 19. | | | | | |
| Printed/Typed Name <i>Bill A Fisher</i> | | Signature <i>Bill A Fisher</i> | | Month Day Year 08 04 94 | |

ORIGINAL-RETURN TO GENERATOR

| | | | | | |
|--|--|--|---|----------------------------|---------------------------|
| NON-HAZARDOUS WASTE MANIFEST | | 1. Generator's US EPA ID No. NOT APPLICABLE | Manifest Document No. | 2. Page 1 of | Authorizaton No. 01216 |
| 3. Generator's Name and Mailing Address City of Emeryville Redevelopment Agency 2200 Powell St.; 12th Floor Emeryville, CA 94608 | | 4. Generator's Phone (510) 596-4356 Attn: Ignacio Dayrit | | | |
| 5. Transporter 1 Company Name Northern Truck and Equipment | 6. US EPA ID Number NOT APPLICABLE | 3113 | | 59# | |
| 7. Transporter 2 Company Name | 8. US EPA ID Number NOT APPLICABLE | | | | |
| 9. Designated Facility Name and Site Address B & J LANDFILL 6426 HAY ROAD VACAVILLE, CA 95687 | | 10. US EPA ID Number NOT APPLICABLE | A. Transporter's Phone (510) 429-8920 B. Transporter's Phone C. Facility's Phone (707) 451-3276 | | |
| 11. Waste Shipping Name and Description | | 12. Containers | | 13. Total Quantity | 14. Unit Wt/Vol |
| a. Soil contaminated with petroleum hydrocarbons | | No. | Type | | |
| | | 1 | T | 18 | Y |
| b. | | | | | |
| c. | | | | | |
| d. | | | | | |
| D. Additional Descriptions for Materials Listed Above Soil excavated from 40th Street UST Project 4000 San Pablo Ave., Emeryville, CA | | E. Handling Codes for Wastes Listed Above 03 | | | |
| 15. Special Handling Instructions and Additional Information | | | | | |
| 16. GENERATOR'S CERTIFICATION: I certify the materials described above on this manifest are not subject to federal regulations for reporting proper disposal of Hazardous Waste. | | | | | |
| Printed/Typed Name RONALD GERBER | | Signature <i>Ronald Gerber</i> | | Month Day Year 08 04 94 | |
| 17. Transporter 1 Acknowledgement of Receipt of Materials | | Signature <i>Jim Shaw</i> | | Month Day Year 08 04 94 | |
| Printed/Typed Name Jim Shaw | | Signature <i>Jim Shaw</i> | | Month Day Year 08 04 94 | |
| 18. Transporter 2 Acknowledgement of Receipt of Materials | | Signature | | Month Day Year | |
| Printed/Typed Name | | Signature | | Month Day Year | |
| 19. Discrepancy Indication Space | | | | | |
| 20. Facility Owner or Operator: Certification of receipt of waste materials covered by this manifest except as noted in item 19. | | | | | |
| Printed/Typed Name MAY BORDEN | | Signature <i>May Borden</i> | | Month Day Year 08 04 94 | |

ORIGINAL-RETURN TO GENERATOR

**NON-HAZARDOUS
 WASTE MANIFEST**

1. Generator's US EPA ID No.
 NOT APPLICABLE

Manifest Document No.

2. Page 1 of

Authorizaton No.
 01216

3. Generator's Name and Mailing Address
 City of Emeryville Redevelopment Agency
 2200 Powell St.; 12th Floor
 Emeryville CA 94608
 4. Generator's Phone (510) 596-4356 Attn: Ignacio Dayrit

RSI

5. Transporter 1 Company Name
 Northern Truck and Equipment
 6. US EPA ID Number
 NOT APPLICABLE

3118 JS

7. Transporter 2 Company Name
 8. US EPA ID Number
 NOT APPLICABLE

9. Designated Facility Name and Site Address
 B & J LANDFILL
 6426 HAY ROAD
 VACAVILLE, CA 95687
 10. US EPA ID Number
 NOT APPLICABLE

A. Transporter's Phone (510)429-8920
 B. Transporter's Phone
 C. Facility's Phone
 (707) 451-3276

11. Waste Shipping Name and Description

| 12. Containers | 13. Total Quantity | 14. Unit Wt/Vol | | |
|--|--------------------|-----------------|-----|------|
| | | | No. | Type |
| a. Soil contaminated with petroleum hydrocarbons | 1 | T | 18 | Y |
| b. | . | . | . | . |
| c. | . | . | . | . |
| d. | . | . | . | . |

D. Additional Descriptions for Materials Listed Above
 Soil excavated from 40th Street UST Project
 4000 San Pablo Ave., Emeryville, CA

E. Handling Codes for Wastes Listed Above
 03

15. Special Handling Instructions and Additional Information

16. GENERATOR'S CERTIFICATION: I certify the materials described above on this manifest are not subject to federal regulations for reporting proper disposal of Hazardous Waste.

Printed/Typed Name: RONALD GERBER
 Signature: Ronald Gerber
 Month Day Year: 08 04 94

17. Transporter 1 Acknowledgement of Receipt of Materials
 Printed/Typed Name: Roy Vincent
 Signature: Roy Vincent
 Month Day Year: . . .

18. Transporter 2 Acknowledgement of Receipt of Materials
 Printed/Typed Name: . . .
 Signature: . . .
 Month Day Year: . . .

19. Discrepancy Indication Space

20. Facility Owner or Operator: Certification of receipt of waste materials covered by this manifest except as noted in Item 19.

Printed/Typed Name: Bill A Fisher
 Signature: Bill A Fisher
 Month Day Year: 10 27 94

GENERATOR

TRANSPORTER

FACILITY

| NON-HAZARDOUS WASTE MANIFEST | | 1. Generator's US EPA ID No. NOT APPLICABLE | Manifest Document No. | 2. Page 1 of | Authorizaton No. 01216 |
|---|---------------------------------------|--|---|---------------------------------------|---------------------------|
| 3. Generator's Name and Mailing Address City of Emeryville Redevelopment Agency 2200 Powell St.; 12th Floor Emeryville, CA 94608 | | | | B4 | |
| 4. Generator's Phone (510) 596-4356 Attn: Ignacio Dayrit | | | | | |
| 5. Transporter 1 Company Name Northern Truck and Equipment | 6. US EPA ID Number NOT APPLICABLE | | | 3113 | |
| 7. Transporter 2 Company Name | 8. US EPA ID Number NOT APPLICABLE | | | | |
| 9. Designated Facility Name and Site Address B & J LANDFILL 6426 HAY ROAD VACAVILLE, CA 95687 | | 10. US EPA ID Number NOT APPLICABLE | A. Transporter's Phone (510) 429-8920 | | B. Transporter's Phone |
| | | | | C. Facility's Phone (707) 451-3276 | |
| 11. Waste Shipping Name and Description | | 12. Containers | | 13. Total Quantity | 14. Unit Wt/Vol |
| a. Soil contaminated with petroleum hydrocarbons | | No. | Type | | |
| | | 1 | T | 18 | Y |
| b. | | | | | |
| c. | | | | | |
| d. | | | | | |
| D. Additional Descriptions for Materials Listed Above Soil excavated from 40th Street UST Project 4000 San Pablo Ave., Emeryville, CA | | | E. Handling Codes for Wastes Listed Above 03 | | |
| 15. Special Handling Instructions and Additional Information | | | | | |
| 16. GENERATOR'S CERTIFICATION: I certify the materials described above on this manifest are not subject to federal regulation for reporting proper disposal of Hazardous Waste. | | | | | |
| Printed/Typed Name RONALD GERBER | | Signature <i>Ronald Gerber</i> | | Month Day Year 08 04 94 | |
| 17. Transporter 1 Acknowledgement of Receipt of Materials | | Printed/Typed Name ARNOLD BADLER | | Signature <i>Arnold Badler</i> | |
| 18. Transporter 2 Acknowledgement of Receipt of Materials | | Printed/Typed Name | | Signature | |
| 19. Discrepancy Indication Space | | | | | |
| 20. Facility Owner or Operator: Certification of receipt of waste materials covered by this manifest except as noted in Item 19. | | | | | |
| Printed/Typed Name MARY BODLER | | Signature <i>Mary Bodler</i> | | Month Day Year 08 04 94 | |

GENERATOR
TRANSPORTER
FACILITY

| NON-HAZARDOUS WASTE MANIFEST | | 1. Generator's US EPA ID No. NOT APPLICABLE | Manifest Document No. | 2. Page 1 of | Authorizaton No. 01216 |
|--|---------------------------------------|---|---------------------------------------|----------------------------|---------------------------|
| 3. Generator's Name and Mailing Address City of Emeryville Redevelopment Agency 2200 Powell St.; 12th Floor Emeryville, CA 94608 | | | | | |
| 4. Generator's Phone (510) 596-4356 Attn: Ignacio Dayrit | | | | | |
| 5. Transporter 1 Company Name Northern Truck and Equipment | 6. US EPA ID Number NOT APPLICABLE | | | 3113 | |
| 7. Transporter 2 Company Name | 8. US EPA ID Number NOT APPLICABLE | | | | |
| 9. Designated Facility Name and Site Address B & J LANDFILL 6426 HAY ROAD VACAVILLE, CA 95687 | | 10. US EPA ID Number NOT APPLICABLE | A. Transporter's Phone (510) 429-8920 | | B. Transporter's Phone |
| | | | C. Facility's Phone (707) 451-3276 | | |
| 11. Waste Shipping Name and Description | | 12. Containers | | 13. Total Quantity | 14. Unit Wt/Vol |
| a. Soil contaminated with petroleum hydrocarbons | | No. | Type | 18 | Y |
| b. | | | | | |
| c. | | | | | |
| d. | | | | | |
| D. Additional Descriptions for Materials Listed Above Soil excavated from 40th Street UST Project 4000 San Pablo Ave., Emeryville, CA | | E. Handling Codes for Wastes Listed Above 03 | | | |
| 15. Special Handling Instructions and Additional Information | | | | | |
| 16. GENERATOR'S CERTIFICATION: I certify the materials described above on this manifest are not subject to federal regulations for reporting proper disposal of Hazardous Waste. | | | | | |
| Printed/Typed Name RONALD GERBER | | Signature <i>Ronald Gerber</i> | | Month Day Year 08 04 94 | |
| 17. Transporter 1 Acknowledgement of Receipt of Materials | | Signature <i>Donald S. Sargent</i> | | Month Day Year 08 04 94 | |
| Printed/Typed Name Donald S. Sargent | | Signature | | Month Day Year | |
| 18. Transporter 2 Acknowledgement of Receipt of Materials | | Signature | | Month Day Year | |
| Printed/Typed Name | | Signature | | Month Day Year | |
| 19. Discrepancy Indication Space | | | | | |
| 20. Facility Owner or Operator: Certification of receipt of waste materials covered by this manifest except as noted in Item 19. | | | | | |
| Printed/Typed Name Mary Borden | | Signature <i>Mary Borden</i> | | Month Day Year 08 04 94 | |

| | | | | | |
|--|--|--|-----------------------|---|---------------------------|
| NON-HAZARDOUS WASTE MANIFEST | | 1. Generator's US EPA ID No. NOT APPLICABLE | Manifest Document No. | 2. Page 1 of 1 | Authorizaton No. 01216 |
| 3. Generator's Name and Mailing Address City of Emeryville Redevelopment Agency 2200 Powell St.; 12th Floor Emeryville CA 94608 | | 6. US EPA ID Number NOT APPLICABLE | | RSI 3 | |
| 4. Generator's Phone (510) 596-4356 Attn: Ignacio Dayrit | | 7. Transporter 1 Company Name Northern Truck and Equipment | | | |
| 5. Transporter 1 Company Name Northern Truck and Equipment | | 8. US EPA ID Number NOT APPLICABLE | | 3113 | |
| 7. Transporter 2 Company Name | | 9. Designated Facility Name and Site Address B & J LANDFILL 6426 HAY ROAD VACAVILLE, CA 95687 | | 10. US EPA ID Number NOT APPLICABLE | |
| 11. Waste Shipping Name and Description a. Soil contaminated with petroleum hydrocarbons | | A. Transporter's Phone (510) 429-8920 | | 12. Containers | |
| | | B. Transporter's Phone | | 13. Total Quantity | |
| | | C. Facility's Phone (707) 451-3276 | | 14. Unit Wt/Vol | |
| D. Additional Descriptions for Materials Listed Above Soil excavated from 40th Street UST Project 4000 San Pablo Ave., Emeryville, CA | | E. Handling Codes for Wastes Listed Above 03 | | | |
| 15. Special Handling Instructions and Additional Information | | | | | |
| 16. GENERATOR'S CERTIFICATION: I certify the materials described above on this manifest are not subject to federal regulations for reporting proper disposal of Hazardous Waste. | | | | | |
| Printed/Typed Name RONALD GERBER | | Signature <i>Ronald Gerber</i> | | Month Day Year 08/04/94 | |
| 17. Transporter 1 Acknowledgement of Receipt of Materials Printed/Typed Name JAY SMITA | | Signature <i>Jay Smita</i> | | Month Day Year 10/8/94 | |
| 18. Transporter 2 Acknowledgement of Receipt of Materials Printed/Typed Name | | Signature | | Month Day Year | |
| 19. Discrepancy Indication Space | | | | | |
| 20. Facility Owner or Operator: Certification of receipt of waste materials covered by this manifest except as noted in Item 19. | | | | | |
| Printed/Typed Name MARY BORDER | | Signature <i>Mary Border</i> | | Month Day Year 10/04/94 | |

ORIGINAL-RETURN TO GENERATOR

| NON-HAZARDOUS WASTE MANIFEST | | 1. Generator's US EPA ID No. NOT APPLICABLE | Manifest Document No. | 2. Page 1 of | Authorizaton No. 01216 |
|--|--|--|---|---------------------------------------|---------------------------|
| 3. Generator's Name and Mailing Address City of Emeryville Redevelopment Agency 2200 Powell St.; 12th Floor Emeryville CA 94608 | | 6. US EPA ID Number NOT APPLICABLE | | 3113 | |
| 4. Generator's Phone (510) 596-4356 Attn: Ignacio Dayrit | | 8. US EPA ID Number NOT APPLICABLE | | | |
| 5. Transporter 1 Company Name Northern Truck and Equipment | | 10. US EPA ID Number NOT APPLICABLE | | A. Transporter's Phone (510) 429-8920 | |
| 7. Transporter 2 Company Name | | | | B. Transporter's Phone | |
| 9. Designated Facility Name and Site Address B & J LANDFILL 6426 HAY ROAD VACAVILLE, CA 95687 | | | | C. Facility's Phone (707) 451-3276 | |
| 11. Waste Shipping Name and Description | | | 12. Containers | 13. Total Quantity | 14. Unit Wt./Vol |
| a. Soil contaminated with petroleum hydrocarbons | | | No. 1 | Type T | 18 Y |
| b. | | | | | |
| c. | | | | | |
| d. | | | | | |
| D. Additional Descriptions for Materials Listed Above Soil excavated from 40th Street UST Project 4000 San Pablo Ave., Emeryville, CA | | | E. Handling Codes for Wastes Listed Above 03 | | |
| 15. Special Handling Instructions and Additional Information | | | | | |
| 16. GENERATOR'S CERTIFICATION: I certify the materials described above on this manifest are not subject to federal regulations for reporting proper disposal of Hazardous Waste. | | | | | |
| Printed/Typed Name RONALD GERBER | | Signature Ronald Gerber | | Month Day Year 8 04 94 | |
| 17. Transporter 1 Acknowledgement of Receipt of Materials | | | | | |
| Printed/Typed Name DAVID STEVENS | | Signature David Stevens | | Month Day Year 10 8 1994 | |
| 18. Transporter 2 Acknowledgement of Receipt of Materials | | | | | |
| Printed/Typed Name | | Signature | | Month Day Year | |
| 19. Discrepancy Indication Space | | | | | |
| 20. Facility Owner or Operator: Certification of receipt of waste materials covered by this manifest except as noted in Item 19. | | | | | |
| Printed/Typed Name Jill A Fisher | | Signature Jill A Fisher | | Month Day Year 10 8 1994 | |

| | | | | | |
|--|--|--|-----------------------|---|---------------------------|
| NON-HAZARDOUS WASTE MANIFEST | | 1. Generator's US EPA ID No. NOT APPLICABLE | Manifest Document No. | 2. Page 1 of 1 | Authorizaton No. 01216 |
| 3. Generator's Name and Mailing Address City of Emeryville Redevelopment Agency 2200 Powell St.; 12th Floor Emeryville CA 94608 | | 4. Generator's Phone (510) 596-4356 Attn: Ignacio Dayrit | | | |
| 5. Transporter 1 Company Name Northern Truck and Equipment | 6. US EPA ID Number NOT APPLICABLE | 7. Transporter 2 Company Name | | 3113 | |
| 8. US EPA ID Number NOT APPLICABLE | | 9. Designated Facility Name and Site Address B & J LANDFILL 6426 HAY ROAD VACAVILLE, CA 95687 | | 10. US EPA ID Number NOT APPLICABLE | |
| | | A. Transporter's Phone (510) 429-8920 | | B. Transporter's Phone | |
| | | C. Facility's Phone (707) 451-3276 | | | |
| 11. Waste Shipping Name and Description a. Soil contaminated with petroleum hydrocarbons | | 12. Containers No. Type | 13. Total Quantity | 14. Unit Wt/Vol | |
| | | 1 T | 18 | Y | |
| b. | | | | | |
| c. | | | | | |
| d. | | | | | |
| D. Additional Descriptions for Materials Listed Above Soil excavated from 40th Street UST Project 4000 San Pablo Ave., Emeryville, CA | | E. Handling Codes for Wastes Listed Above 03 | | | |
| 15. Special Handling Instructions and Additional Information | | | | | |
| 16. GENERATOR'S CERTIFICATION: I certify the materials described above on this manifest are not subject to federal regulations for reporting proper disposal of Hazardous Waste. | | | | | |
| Printed/Typed Name RONALD GERBER | | Signature <i>Ronald Gerber</i> | | Month Day Year 08 04 94 | |
| 17. Transporter 1 Acknowledgement of Receipt of Materials Printed/Typed Name C J BLUMPEL | | Signature <i>C J Blumpele</i> | | Month Day Year 08 04 94 | |
| 18. Transporter 2 Acknowledgement of Receipt of Materials Printed/Typed Name | | Signature | | Month Day Year | |
| 19. Discrepancy Indication Space | | | | | |
| 20. Facility Owner or Operator: Certification of receipt of waste materials covered by this manifest except as noted in Item 19. | | | | | |
| Printed/Typed Name Jill A Fisher | | Signature <i>Jill A Fisher</i> | | Month Day Year 08 07 94 | |

ORIGINAL-RETURN TO GENERATOR

**NON-HAZARDOUS
 WASTE MANIFEST**

1. Generator's US EPA ID No.
 NOT APPLICABLE

Manifest Document No.

2. Page 1 of

Authorizaton No.
 01216

3. Generator's Name and Mailing Address
 City of Emeryville Redevelopment Agency
 2200 Powell St.; 12th Floor
 Emeryville, CA 94608
 4. Generator's Phone (510) 596-4356 Attn: Ignacio Dayrit

COLLINS #6

5. Transporter 1 Company Name
 Northern Truck and Equipment
 6. US EPA ID Number
 NOT APPLICABLE

3113

7. Transporter 2 Company Name
 8. US EPA ID Number
 NOT APPLICABLE

9. Designated Facility Name and Site Address
 B & J LANDFILL
 6426 HAY ROAD
 VACAVILLE, CA 95687
 10. US EPA ID Number
 NOT APPLICABLE

A. Transporter's Phone (510) 429-8920
 B. Transporter's Phone
 C. Facility's Phone (707) 451-3276

11. Waste Shipping Name and Description

| a. | 12. Containers | | 13. Total Quantity | 14. Unit Wt/Vol |
|---|----------------|------|--------------------|-----------------|
| | No. | Type | | |
| Soil contaminated with petroleum hydrocarbons | 1 | T | 18 | Y |
| b. | | | | |
| c. | | | | |
| d. | | | | |

D. Additional Descriptions for Materials Listed Above
 Soil excavated from 40th Street UST Project
 4000 San Pablo Ave., Emeryville, CA

E. Handling Codes for Wastes Listed Above
 03

15. Special Handling Instructions and Additional Information

16. GENERATOR'S CERTIFICATION: I certify the materials described above on this manifest are not subject to federal regulations for reporting proper disposal of Hazardous Wastes.

Printed/Typed Name: *Ronald GERSON*
 Signature: *Ronald Gerson* Month: 8 Day: 4 Year: 94

17. Transporter 1 Acknowledgement of Receipt of Materials
 Printed/Typed Name: _____
 Signature: _____ Month: _____ Day: _____ Year: _____

18. Transporter 2 Acknowledgement of Receipt of Materials
 Printed/Typed Name: *Leon MORRIS*
 Signature: *Leon Morris* Month: 8 Day: 4 Year: 94

19. Discrepancy Indication Space

20. Facility Owner or Operator: Certification of receipt of waste materials covered by this manifest except as noted in Item 19.

Printed/Typed Name: *Will A Fisher*
 Signature: *Will A Fisher* Month: 8 Day: 4 Year: 94

| | | | | | |
|--|---|--|-----------------------|---|---------------------------|
| NON-HAZARDOUS WASTE MANIFEST | | 1. Generator's US EPA ID No. NOT APPLICABLE | Manifest Document No. | 2. Page 1 of | Authorizaton No. 01216 |
| 3. Generator's Name and Mailing Address City of Emeryville Redevelopment Agency 2200 Powell St.; 12th Floor Emeryville, CA 94608 | | 4. Generator's Phone (510) 596-4356 Attn: Ignacio Dayrit | | RSI | |
| 5. Transporter 1 Company Name Northern Truck and Equipment | 6. US EPA ID Number NOT APPLICABLE | | | | |
| 7. Transporter 2 Company Name | 8. US EPA ID Number NOT APPLICABLE | | | A. Transporter's Phone (510) 429-8920 B. Transporter's Phone C. Facility's Phone (707) 451-3276 | |
| 9. Designated Facility Name and Site Address B & J LANDFILL 6426 HAY ROAD VACAVILLE, CA 95687 | 10. US EPA ID Number NOT APPLICABLE | | | | |
| 11. Waste Shipping Name and Description | | 12. Containers | 13. Total Quantity | 14. Unit Wt/Vol | |
| a. Soil contaminated with petroleum hydrocarbons | | No. 1 | Type T | 18 | Y |
| b. | | | | | |
| c. | | | | | |
| d. | | | | | |
| D. Additional Descriptions for Materials Listed Above Soil excavated from 40th Street UST Project 4000 San Pablo Ave., Emeryville, CA | | E. Handling Codes for Wastes Listed Above 03 | | | |
| 15. Special Handling Instructions and Additional Information | | | | | |
| 16. GENERATOR'S CERTIFICATION: I certify the materials described above on this manifest are not subject to federal regulations for reporting proper disposal of Hazardous Waste. | | | | | |
| Printed/Typed Name Ronald GERBER | | Signature Ronald Gerber | | Month Day Year 8/4/94 | |
| 17. Transporter 1 Acknowledgement of Receipt of Materials | | | | | |
| Printed/Typed Name Charlie Collins | | Signature Charlie Collins | | Month Day Year 8/10/94 | |
| 18. Transporter 2 Acknowledgement of Receipt of Materials | | | | | |
| Printed/Typed Name | | Signature | | Month Day Year | |
| 19. Discrepancy Indication Space | | | | | |
| 20. Facility Owner or Operator: Certification of receipt of waste materials covered by this manifest except as noted in Item 19 | | | | | |
| Printed/Typed Name Jill A Lisher | | Signature Jill A Lisher | | Month Day Year 08/14/94 | |

GENERATOR
TRANSPORTER
FACILITY

| NON-HAZARDOUS WASTE MANIFEST | | 1. Generator's US EPA ID No. NOT APPLICABLE | Manifest Document No. | 2. Page 1 of | Authorizaton No. 01216 |
|--|---------------------------------------|---|-----------------------|---|---------------------------|
| 3. Generator's Name and Mailing Address City of Emeryville Redevelopment Agency 2200 Powell St.; 12th Floor Emeryville, CA 94608 | | | | RS/ 313 391 | |
| 4. Generator's Phone (510) 596-4356 Attn: Ignacio Dayrit | | | | | |
| 5. Transporter 1 Company Name Northern Truck and Equipment | 6. US EPA ID Number NOT APPLICABLE | | | | |
| 7. Transporter 2 Company Name | 8. US EPA ID Number NOT APPLICABLE | | | | |
| 9. Designated Facility Name and Site Address B & J LANDFILL 6426 HAY ROAD VACAVILLE, CA 95687 | | 10. US EPA ID Number NOT APPLICABLE | | A. Transporter's Phone (510) 429-8920 B. Transporter's Phone C. Facility's Phone (707) 451-3276 | |
| 11. Waste Shipping Name and Description | | 12. Containers | | 13. Total Quantity | 14. Unit Wt/Vol |
| a. Soil contaminated with petroleum hydrocarbons | | No. | Type | 18 | Y |
| b. | | . | . | . | . |
| c. | | . | . | . | . |
| d. | | . | . | . | . |
| D. Additional Descriptions for Materials Listed Above Soil excavated from 40th Street UST Project 4000 San Pablo Ave., Emeryville, CA | | E. Handling Codes for Wastes listed Above 03 | | | |
| 15. Special Handling Instructions and Additional Information | | | | | |
| 16. GENERATOR'S CERTIFICATION: I certify the materials described above on this manifest are not subject to federal regulations for reporting proper disposal of Hazardous Waste. | | | | | |
| Printed/Typed Name RONALD GERBER | | Signature <i>Ronald Gerber</i> | | Month | Day Year |
| | | | | 8 | 4 94 |
| 17. Transporter 1 Acknowledgement of Receipt of Materials | | | | | |
| Printed/Typed Name PHIL ROUSE | | Signature <i>Phil Rouse</i> | | Month | Day Year |
| | | | | 8 | 4 94 |
| 18. Transporter 2 Acknowledgement of Receipt of Materials | | | | | |
| Printed/Typed Name | | Signature | | Month | Day Year |
| | | | | . | . |
| 19. Discrepancy Indication Space | | | | | |
| 20. Facility Owner or Operator: Certification of receipt of waste materials covered by this manifest except as noted in item 19. | | | | | |
| Printed/Typed Name Bill A. Fisher | | Signature <i>Bill A. Fisher</i> | | Month | Day Year |
| | | | | 8 | 4 94 |

ORIGINAL-RETURN TO GENERATOR

| | | | | | |
|--|--|--|---|--|---------------------------|
| NON-HAZARDOUS WASTE MANIFEST | | 1. Generator's US EPA ID No. NOT APPLICABLE | Manifest Document No. | 2. Page 1 of | Authorizaton No. 01216 |
| 3. Generator's Name and Mailing Address City of Emeryville Redevelopment Agency 2200 Powell St.; 12th Floor Emeryville, CA 94608 | | 4. Generator's Phone (510) 596-4356 Attn: Ignacio Dayrit | | RS1 | |
| 5. Transporter 1 Company Name Northern Truck and Equipment | 6. US EPA ID Number NOT APPLICABLE | 7. Transporter 2 Company Name | 8. US EPA ID Number NOT APPLICABLE | | |
| 9. Designated Facility Name and Site Address B & J LANDFILL 6426 HAY ROAD VACAVILLE, CA 95687 | | 10. US EPA ID Number NOT APPLICABLE | | A. Transporter's Phone (510)429-8920 B. Transporter's Phone C. Facility's Phone (707) 451-3276 | |
| 11. Waste Shipping Name and Description | | | 12. Containers | 13. Total Quantity | 14. Unit Wt/Vol |
| a. Soil contaminated with petroleum hydrocarbons | | | No. 1 | Type T | 18 Y |
| b. | | | | | |
| c. | | | | | |
| d. | | | | | |
| D. Additional Descriptions for Materials Listed Above Soil excavated from 40th Street UST Project 4000 San Pablo Ave., Emeryville, CA | | | E. Handling Codes for Wastes Listed Above 03 | | |
| 15. Special Handling Instructions and Additional Information | | | | | |
| 16. GENERATOR'S CERTIFICATION: I certify the materials described above on this manifest are not subject to federal regulations for reporting proper disposal of Hazardous Waste. | | | | | |
| Printed/Typed Name RONALD GERSON | | Signature <i>Ronald Gerson</i> | | Month Day Year 8 4 99 | |
| 17. Transporter 1 Acknowledgement of Receipt of Materials | | Printed/Typed Name <i>Regina</i> | | Signature <i>Regina</i> | |
| 18. Transporter 2 Acknowledgement of Receipt of Materials | | Printed/Typed Name | | Signature | |
| 19. Discrepancy Indication Space | | | | Month Day Year | |
| 20. Facility Owner or Operator: Certification of receipt of waste materials covered by this manifest except as noted in Item 19. | | | | | |
| Printed/Typed Name MARY BODEN | | Signature <i>Mary Boden</i> | | Month Day Year 8 4 99 | |

ORIGINAL-RETURN TO GENERATOR

| | | | | | |
|--|--|--|---------------------------------------|--------------------|---------------------------|
| NON-HAZARDOUS WASTE MANIFEST | | 1. Generator's US EPA ID No. NOT APPLICABLE | Manifest Document No. | 2. Page 1 of | Authorizaton No. 01216 |
| 3. Generator's Name and Mailing Address City of Emeryville Redevelopment Agency 2200 Powell St.; 12th Floor Emeryville, CA 94608 | | 4. Generator's Phone (510) 596-4356 Attn: Ignacio Dayrit | | | |
| 5. Transporter 1 Company Name Northern Truck and Equipment | 6. US EPA ID Number NOT APPLICABLE | 3113 | RBA | | |
| 7. Transporter 2 Company Name | 8. US EPA ID Number NOT APPLICABLE | | | | |
| 9. Designated Facility Name and Site Address B & J LANDFILL 6426 HAY ROAD VACAVILLE, CA 95687 | | 10. US EPA ID Number NOT APPLICABLE | A. Transporter's Phone (510)429-8920 | | |
| | | | B. Transporter's Phone | | |
| | | | C. Facility's Phone (707) 451-3276 | | |
| 11. Waste Shipping Name and Description | | 12. Containers | | 13. Total Quantity | 14. Unit Wt/Vol |
| a. Soil contaminated with petroleum hydrocarbons | | No. | Type | | |
| | | 1 | T | 18 | Y |
| b. | | | | | |
| c. | | | | | |
| d. | | | | | |
| D. Additional Descriptions for Materials Listed Above Soil excavated from 40th Street UST Project 4000 San Pablo Ave., Emeryville, CA | | E. Handling Codes for Wastes Listed Above 03 | | | |
| 15. Special Handling Instructions and Additional Information | | | | | |
| 16. GENERATOR'S CERTIFICATION: I certify the materials described above on this manifest are not subject to federal regulations for reporting proper disposal of Hazardous Waste. | | | | | |
| Printed/Typed Name RONALD GERBER | | Signature <i>Ronald Gerber</i> | | Month | Day Year |
| | | | | 8 | 4 94 |
| 17. Transporter 1 Acknowledgement of Receipt of Materials | | | | | |
| Printed/Typed Name DAVID CLARK | | Signature <i>D. Clark</i> | | Month | Day Year |
| | | | | 8 | 4 94 |
| 18. Transporter 2 Acknowledgement of Receipt of Materials | | | | | |
| Printed/Typed Name | | Signature | | Month | Day Year |
| | | | | | |
| 19. Discrepancy Indication Space | | | | | |
| 20. Facility Owner or Operator: Certification of receipt of waste materials covered by this manifest except as noted in Item 19. | | | | | |
| Printed/Typed Name MARY BOEDEN | | Signature <i>Mary Boeden</i> | | Month | Day Year |
| | | | | 8 | 4 94 |

ORIGINAL-RETURN TO GENERATOR

| | | | | | | |
|--|--|--|-----------------------|---|---------------------------|--------------------------|
| NON-HAZARDOUS WASTE MANIFEST | | 1. Generator's US EPA ID No NOT APPLICABLE | Manifest Document No. | 2. Page 1 of | Authorizaton No. 01216 | |
| 3. Generator's Name and Mailing Address City of Emeryville Redevelopment Agency 2200 Powell St.; 12th Floor Emeryville CA 94608 | | | | RSI | | |
| 4. Generator's Phone (510) 596-4356 Attn: Ignacio Dayrit | | | | | | |
| 5. Transporter 1 Company Name Northern Truck and Equipment | | 6. US EPA ID Number NOT APPLICABLE | | 3113 | 85 | |
| 7. Transporter 2 Company Name | | 8. US EPA ID Number NOT APPLICABLE | | | | |
| 9. Designated Facility Name and Site Address B & J LANDFILL 6426 HAY ROAD VACAVILLE, CA 95687 | | 10. US EPA ID Number NOT APPLICABLE | | A. Transporter's Phone (510) 429-8920 | | |
| | | | | B. Transporter's Phone | | |
| | | | | C. Facility's Phone (707) 451-3276 | | |
| 11. Waste Shipping Name and Description | | | | 12. Containers | 13. Total Quantity | 14. Unit Wt/Vol |
| a. Soil contaminated with petroleum hydrocarbons | | | | No. 1 | Type T | 18 Y |
| b. | | | | | | |
| c. | | | | | | |
| d. | | | | | | |
| D. Additional Descriptions for Materials Listed Above Soil excavated from 40th Street UST Project 4000 San Pablo Ave., Emeryville, CA | | | | E. Handling Codes for Wastes Listed Above 03 | | |
| 15. Special Handling Instructions and Additional Information | | | | | | |
| 16. GENERATOR'S CERTIFICATION: I certify the materials described above on this manifest are not subject to federal regulations for reporting proper disposal of Hazardous Waste. | | | | | | |
| Printed/Typed Name RONALD GERBER | | | | Signature <i>Ronald Gerber</i> | | Month Day Year 8 4 94 |
| 17. Transporter 1 Acknowledgement of Receipt of Materials | | | | Signature <i>Roy Vincent</i> | | Month Day Year 8 5 94 |
| Printed/Typed Name | | | | Signature | | Month Day Year |
| 18. Transporter 2 Acknowledgement of Receipt of Materials | | | | | | |
| 19. Discrepancy Indication Space | | | | | | |
| 20. Facility Owner or Operator: Certification of receipt of waste materials covered by this manifest except as noted in Item 19. | | | | | | |
| Printed/Typed Name MARY BORDER | | | | Signature <i>Mary Border</i> | | Month Day Year 8 8 94 |

ORIGINAL-RETURN TO GENERATOR

Truck # R-64

ALTA ENVIRONMENTAL SERVICES, INC.
6426 HAY ROAD • VACAVILLE, CA 95687
(800) 794-2768

LOAD No 077

| NON-HAZARDOUS WASTE MANIFEST | | 1. Generator's US EPA ID No. NOT APPLICABLE | Manifest Document No. | 2. Page 1 of | Authorizaton No. 01216 |
|--|--|---|-----------------------|-------------------------------|---------------------------|
| 3. Generator's Name and Mailing Address City of Emeryville Redevelopment Agency 2200 Powell St.; 12th Floor Emeryville, CA 94608 | | RSI R-64 | | | |
| 4. Generator's Phone (510) 596-4356 Attn: Ignacio Dayrit | | | | | |
| 5. Transporter 1 Company Name Northern Truck and Equipment | 6. US EPA ID Number NOT APPLICABLE | 3113 | | | |
| 7. Transporter 2 Company Name | 8. US EPA ID Number NOT APPLICABLE | | | | |
| 9. Designated Facility Name and Site Address B & J LANDFILL 6426 HAY ROAD VACAVILLE, CA 95687 | 10. US EPA ID Number NOT APPLICABLE | A. Transporter's Phone (510) 429-8920 | | | |
| | | B. Transporter's Phone | | | |
| | | C. Facility's Phone (707) 451-3276 | | | |
| 11. Waste Shipping Name and Description | | 12. Containers | 13. Total Quantity | 14. Unit | |
| a. Soil contaminated with petroleum hydrocarbons | | No. 1 | Type T | 18 | Unit Wt/Vol Y |
| b. | | | | | |
| c. | | | | | |
| d. | | | | | |
| D. Additional Descriptions for Materials Listed Above Soil excavated from 40th Street UST Project 4000 San Pablo Ave., Emeryville, CA | | E. Handling Codes for Wastes Listed Above 03 | | | |
| 15. Special Handling Instructions and Additional Information | | | | | |
| 16. GENERATOR'S CERTIFICATION: I certify the materials described above on this manifest are not subject to federal regulations for reporting proper disposal of Hazardous Waste. | | | | | |
| Printed/Typed Name RONALD GERSON | | Signature <i>Ronald Gerson</i> | | Month Day Year 8 4 94 | |
| 17. Transporter 1 Acknowledgement of Receipt of Materials | | | | | |
| Printed/Typed Name Craig Rice | | Signature <i>Craig Rice</i> | | Month Day Year 8 5 94 | |
| 18. Transporter 2 Acknowledgement of Receipt of Materials | | | | | |
| Printed/Typed Name | | Signature | | Month Day Year | |
| 19. Discrepancy Indication Space | | | | | |
| 20. Facility Owner or Operator: Certification of receipt of waste materials covered by this manifest except as noted in item 19. | | | | | |
| Printed/Typed Name MARY BODER | | Signature <i>Mary Boder</i> | | Month Day Year 10 5 94 | |

ORIGINAL-RETURN TO GENERATOR

| NON-HAZARDOUS WASTE MANIFEST | | 1. Generator's US EPA ID No. NOT APPLICABLE | Manifest Document No. | 2. Page 1 of | Authorizaton No. 01216 |
|--|---------------------------------------|---|--------------------------------------|------------------------------------|---------------------------|
| 3. Generator's Name and Mailing Address City of Emeryville Redevelopment Agency 2200 Powell St.; 12th Floor Emeryville, CA 94608 | | | | | |
| 4. Generator's Phone (510) 596-4356 Attn: Ignacio Dayrit | | | | | |
| 5. Transporter 1 Company Name Northern Truck and Equipment | 6. US EPA ID Number NOT APPLICABLE | | | 3113 | 59# |
| 7. Transporter 2 Company Name | 8. US EPA ID Number NOT APPLICABLE | | | | |
| 9. Designated Facility Name and Site Address B & J LANDFILL 6426 HAY ROAD VACAVILLE, CA 95687 | | 10. US EPA ID Number NOT APPLICABLE | A. Transporter's Phone (510)429-8920 | | B. Transporter's Phone |
| | | | | C. Facility's Phone (707) 451-3276 | |
| 11. Waste Shipping Name and Description | | 12. Containers | | 13. Total Quantity | 14. Unit Wt/Vol |
| a. Soil contaminated with petroleum hydrocarbons | | No. | Type | 18 | Y |
| b. | | | | | |
| c. | | | | | |
| d. | | | | | |
| D. Additional Descriptions for Materials Listed Above Soil excavated from 40th Street UST Project 4000 San Pablo Ave., Emeryville, CA | | E. Handling Codes for Wastes Listed Above 03 | | | |
| 15. Special Handling Instructions and Additional Information | | | | | |
| 16. GENERATOR'S CERTIFICATION: I certify the materials described above on this manifest are not subject to federal regulations for reporting proper disposal of Hazardous Waste. | | | | | |
| Printed/Typed Name RONALD GERBER | | Signature <i>Ronald Gerber</i> | | Month Day Year 8 4 94 | |
| 17. Transporter 1 Acknowledgement of Receipt of Materials Printed/Typed Name Jimmie W Shaw | | Signature <i>Jimmie W Shaw</i> | | Month Day Year 8 5 94 | |
| 18. Transporter 2 Acknowledgement of Receipt of Materials Printed/Typed Name | | Signature | | Month Day Year | |
| 19. Discrepancy Indication Space | | | | | |
| 20. Facility Owner or Operator: Certification of receipt of waste materials covered by this manifest except as noted in item 19. | | | | | |
| Printed/Typed Name MAY BODNER | | Signature <i>May Bodner</i> | | Month Day Year 8 05 94 | |

ORIGINAL-RETURN TO GENERATOR

| NON-HAZARDOUS WASTE MANIFEST | | 1. Generator's US EPA ID No. NOT APPLICABLE | Manifest Document No. | 2. Page 1 of | Authorizaton No. 01216 |
|--|---------------------------------------|--|---|--------------------|---------------------------|
| 3. Generator's Name and Mailing Address City of Emeryville Redevelopment Agency 2200 Powell St.; 12th Floor Emeryville, CA 94608 | | | | | |
| 4. Generator's Phone (510) 596-4356 Attn: Ignacio Dayrit | | | | Northern 91-30 | |
| 5. Transporter 1 Company Name Northern Truck and Equipment | 6. US EPA ID Number NOT APPLICABLE | | | 3113 | |
| 7. Transporter 2 Company Name | 8. US EPA ID Number NOT APPLICABLE | | | | |
| 9. Designated Facility Name and Site Address B & J LANDFILL 6426 HAY ROAD VACAVILLE, CA 95687 | | 10. US EPA ID Number NOT APPLICABLE | A. Transporter's Phone (510) 429-8920 | | B. Transporter's Phone |
| | | | C. Facility's Phone (707) 451-3276 | | |
| 11. Waste Shipping Name and Description | | 12. Containers | | 13. Total Quantity | 14. Unit Wt/Vol |
| a. Soil contaminated with petroleum hydrocarbons | | No. | Type | 18 | Y |
| b. | | | | | |
| c. | | | | | |
| d. | | | | | |
| D. Additional Descriptions for Materials Listed Above Soil excavated from 40th Street UST Project 4000 San Pablo Ave., Emeryville, CA | | | E. Handling Codes for Wastes Listed Above 03 | | |
| 15. Special Handling Instructions and Additional Information | | | | | |
| 16. GENERATOR'S CERTIFICATION: I certify the materials described above on this manifest are not subject to federal regulations for reporting proper disposal of Hazardous Waste. | | | | | |
| Printed/Typed Name RONALD GERBER | | Signature Ronald Gerber | | Month 8 | Day 4 |
| 17. Transporter 1 Acknowledgement of Receipt of Materials | | Signature Paul Hirt | | Month 8 | Day 5 |
| Printed/Typed Name Northern Truck Co | | Signature | | Month | Day |
| 18. Transporter 2 Acknowledgement of Receipt of Materials | | Signature | | Month | Day |
| Printed/Typed Name | | Signature | | Month | Day |
| 19. Discrepancy Indication Space | | | | | |
| 20. Facility Owner or Operator: Certification of receipt of waste materials covered by this manifest except as noted in Item 19. | | | | | |
| Printed/Typed Name W.A. Fisher | | Signature W.A. Fisher | | Month 8 | Day 5 |

ORIGINAL-RETURN TO GENERATOR

| | | | | | |
|--|---|---|---|------------------------------|---------------------------|
| NON-HAZARDOUS WASTE MANIFEST | | 1. Generator's US EPA ID No. NOT APPLICABLE | Manifest Document No. | 2. Page 1 of | Authorizaton No. 01216 |
| 3. Generator's Name and Mailing Address City of Emeryville Redevelopment Agency 2200 Powell St.; 12th Floor Emeryville, CA 94608 | | | | COLLINS ILG | |
| 4. Generator's Phone (510) 596-4356 Attn: Ignacio Dayrit | | | | | |
| 5. Transporter 1 Company Name Northern Truck and Equipment | 6. US EPA ID Number NOT APPLICABLE | 3113 | | | |
| 7. Transporter 2 Company Name | 8. US EPA ID Number NOT APPLICABLE | | | | |
| 9. Designated Facility Name and Site Address B & J LANDFILL 6426 HAY ROAD VACAVILLE, CA 95687 | 10. US EPA ID Number NOT APPLICABLE | A. Transporter's Phone (510) 429-8920 | | | |
| | | B. Transporter's Phone | | | |
| | | C. Facility's Phone (707) 451-3276 | | | |
| 11. Waste Shipping Name and Description | | 12. Containers | 13. Total Quantity | 14. Unit Wt/Vol | |
| a. Soil contaminated with petroleum hydrocarbons | | No. 1 | Type T | 18 | Y |
| b. | | | | | |
| c. | | | | | |
| d. | | | | | |
| D. Additional Descriptions for Materials Listed Above Soil excavated from 40th Street UST Project 4000 San Pablo Ave., Emeryville, CA | | | E. Handling Codes for Wastes Listed Above 03 | | |
| 15. Special Handling Instructions and Additional Information | | | | | |
| 16. GENERATOR'S CERTIFICATION: I certify the materials described above on this manifest are not subject to federal regulations for reporting proper disposal of Hazardous Waste. | | | | | |
| Printed/Typed Name RONALD GERBER | | Signature <i>Ronald Gerber</i> | | Month 8 | Day 4 |
| 17. Transporter 1 Acknowledgement of Receipt of Materials | | | | | |
| Printed/Typed Name | | Signature | | Month | Day |
| 18. Transporter 2 Acknowledgement of Receipt of Materials | | | | | |
| Printed/Typed Name LEON MORRIS | | Signature <i>Leon Morris</i> | | Month 8 | Day 5 |
| 19. Discrepancy Indication Space | | | | | |
| 20. Facility Owner or Operator: Certification of receipt of waste materials covered by this manifest except as noted in Item 19. | | | | | |
| Printed/Typed Name MARY BORDEN | | Signature <i>Mary Borden</i> | | Month 8 | Day 5 |

ORIGINAL-RETURN TO GENERATOR

| | | | | | |
|--|-------------------------------|---|--|---|---------------------------|
| NON-HAZARDOUS WASTE MANIFEST | | 1. Generator's US EPA ID No. NOT APPLICABLE | Manifest Document No. | 2. Page 1 of | Authorizaton No. 01216 |
| 3. Generator's Name and Mailing Address City of Emeryville Redevelopment Agency 2200 Powell St.; 12th Floor Emeryville, CA 94608 Generator's Phone (510) 596-4356 Attn: Ignacio Dayrit | | 6. US EPA ID Number NOT APPLICABLE | | RS1 | |
| 5. Transporter 1 Company Name Northern Truck and Equipment | 7. Transporter 2 Company Name | | 8. US EPA ID Number NOT APPLICABLE | | 3 |
| 9. Designated Facility Name and Site Address B & J LANDFILL 6426 HAY ROAD VACAVILLE, CA 95687 | | 10. US EPA ID Number NOT APPLICABLE | | A. Transporter's Phone (510) 429-8920 B. Transporter's Phone C. Facility's Phone (707) 451-3276 | |
| 11. Waste Shipping Name and Description | | 12. Containers | | 13. Total Quantity | 14. Unit Wt/Vol |
| a. Soil contaminated with petroleum hydrocarbons | | No. Type | | 18 | Y |
| b. | | | | | |
| c. | | | | | |
| d. | | | | | |
| D. Additional Descriptions for Materials Listed Above Soil excavated from 40th Street UST Project 4000 San Pablo Ave., Emeryville, CA | | E. Handling Codes for Wastes Listed Above 03 | | | |
| 15. Special Handling Instructions and Additional Information | | | | | |
| 16. GENERATOR'S CERTIFICATION: I certify the materials described above on this manifest are not subject to federal regulations for reporting proper disposal of Hazardous Waste. | | | | | |
| Printed/Typed Name RONALD GERBER | | Signature <i>Ronald Gerber</i> | | Month 8 | Day Year 1 94 |
| 17. Transporter 1 Acknowledgement of Receipt of Materials Printed/Typed Name JAN SMITH | | Signature <i>Jan Smith</i> | | Month 8 | Day Year 1 94 |
| 18. Transporter 2 Acknowledgement of Receipt of Materials Printed/Typed Name | | Signature | | Month | Day Year |
| 19. Discrepancy Indication Space | | | | | |
| 20. Facility Owner or Operator: Certification of receipt of waste materials covered by this manifest except as noted in Item 19. | | | | | |
| Printed/Typed Name MARY BOULE | | Signature <i>Mary Boule</i> | | Month 1 | Day Year 5 94 |

ORIGINAL-RETURN TO GENERATOR

| | | | | | |
|--|--|--|---|---|---------------------------|
| NON-HAZARDOUS WASTE MANIFEST | | 1. Generator's US EPA ID No. NOT APPLICABLE | Manifest Document No. | 2. Page 1 of | Authorizaton No. 01216 |
| 3. Generator's Name and Mailing Address City of Emeryville Redevelopment Agency 2200 Powell St.; 12th Floor Emeryville, CA 94608 | | 4. Generator's Phone (510) 596-4356 Attn: Ignacio Dayrit | | RS1 3413 58 | |
| 5. Transporter 1 Company Name Northern Truck and Equipment | 6. US EPA ID Number NOT APPLICABLE | 7. Transporter 2 Company Name | | | |
| 9. Designated Facility Name and Site Address B & J LANDFILL 6426 HAY ROAD VACAVILLE, CA 95687 | | 10. US EPA ID Number NOT APPLICABLE | | A. Transporter's Phone (510) 429-8920 B. Transporter's Phone C. Facility's Phone (707) 451-3276 | |
| 11. Waste Shipping Name and Description | | | 12. Containers | 13. Total Quantity | 14. Unit Wt/Vol |
| a. Soil contaminated with petroleum hydrocarbons | | | No. 1 | Type T | 18 Y |
| b. | | | | | |
| c. | | | | | |
| d. | | | | | |
| D. Additional Descriptions for Materials Listed Above Soil excavated from 40th Street UST Project 4000 San Pablo Ave., Emeryville, CA | | | E. Handling Codes for Wastes Listed Above 03 | | |
| 15. Special Handling Instructions and Additional Information | | | | | |
| 16. GENERATOR'S CERTIFICATION: I certify the materials described above on this manifest are not subject to federal regulations for reporting proper disposal of Hazardous Waste. | | | | | |
| Printed/Typed Name Ronald GERBER | | Signature <i>Ronald Gerber</i> | | Month 8 | Day 4 |
| 17. Transporter 1 Acknowledgement of Receipt of Materials | | Printed/Typed Name DAN ROSE | | Signature <i>Dan Rose</i> | |
| 18. Transporter 2 Acknowledgement of Receipt of Materials | | Printed/Typed Name | | Signature | |
| 19. Discrepancy Indication Space | | | | | |
| 20. Facility Owner or Operator: Certification of receipt of waste materials covered by this manifest except as noted in Item 19. | | | | | |
| Printed/Typed Name MARC BORDEA | | Signature <i>Marc Borda</i> | | Month 1 | Day 15 |

ORIGINAL-RETURN TO GENERATOR

| NON-HAZARDOUS WASTE MANIFEST | | 1. Generator's US EPA ID No. NOT APPLICABLE | Manifest Document No. | 2. Page 1 of | Authorizaton No. 01216 |
|--|---------------------------------------|---|---------------------------------------|---------------------------------------|---------------------------|
| 3. Generator's Name and Mailing Address City of Emeryville Redevelopment Agency 2200 Powell St.; 12th Floor Emeryville, CA 94608 | | | | RSI | |
| 4. Generator's Phone (510) 596-4356 Attn: Ignacio Dayrit | | | | | |
| 5. Transporter 1 Company Name Northern Truck and Equipment | 6. US EPA ID Number NOT APPLICABLE | | | 3113 | 371 |
| 7. Transporter 2 Company Name | 8. US EPA ID Number NOT APPLICABLE | | | | |
| 9. Designated Facility Name and Site Address B & J LANDFILL 6426 HAY ROAD VACAVILLE, CA 95687 | | 10. US EPA ID Number NOT APPLICABLE | A. Transporter's Phone (510) 429-8920 | | B. Transporter's Phone |
| | | | | C. Facility's Phone (707) 451-3276 | |
| 11. Waste Shipping Name and Description | | 12. Containers | | 13. Total Quantity | 14. Unit Wt/Vol |
| a. Soil contaminated with petroleum hydrocarbons | | No. | Type | 18 | Y |
| b. | | | | | |
| c. | | | | | |
| d. | | | | | |
| D. Additional Descriptions for Materials Listed Above Soil excavated from 40th Street UST Project 4000 San Pablo Ave., Emeryville, CA | | E. Handling Codes for Wastes Listed Above 03 | | | |
| 15. Special Handling Instructions and Additional Information | | | | | |
| 16. GENERATOR'S CERTIFICATION: I certify the materials described above on this manifest are not subject to federal regulations for reporting proper disposal of Hazardous Waste. | | | | | |
| Printed/Typed Name RONALD GERBER | | Signature <i>Ronald Gerber</i> | | Month 8 | Day 4 |
| 17. Transporter 1 Acknowledgement of Receipt of Materials | | Signature <i>Phil Truse</i> | | Month 8 | Day 5 |
| Printed/Typed Name PHIL TRUSE | | Signature | | Year 94 | |
| 18. Transporter 2 Acknowledgement of Receipt of Materials | | Signature | | Month | Day |
| Printed/Typed Name | | Signature | | Year | |
| 19. Discrepancy Indication Space | | | | | |
| 20. Facility Owner or Operator: Certification of receipt of waste materials covered by this manifest except as noted in Item 19. | | | | | |
| Printed/Typed Name MARY BORDER | | Signature <i>Mary Border</i> | | Month 8 | Day 5 |
| | | | | Year 94 | |

ORIGINAL-RETURN TO GENERATOR

| | | | | | |
|---|--|---|---------------------------------------|--------------------|---------------------------|
| NON-HAZARDOUS WASTE MANIFEST | | 1. Generator's US EPA ID No. NOT APPLICABLE | Manifest Document No. | 2. Page 1 of | Authorizaton No. 01216 |
| 3. Generator's Name and Mailing Address City of Emeryville Redevelopment Agency 2200 Powell St.; 12th Floor Emeryville, CA 94608 | | | | RSI | |
| 4. Generator's Phone (510) 596-4356 Attn: Ignacio Dayrit | | | | | |
| 5. Transporter 1 Company Name Northern Truck and Equipment | 6. US EPA ID Number NOT APPLICABLE | 3113 | | 191 | |
| 7. Transporter 2 Company Name | 8. US EPA ID Number NOT APPLICABLE | | | | |
| 9. Designated Facility Name and Site Address B & J LANDFILL 6426 HAY ROAD VACAVILLE, CA 95687 | | 10. US EPA ID Number NOT APPLICABLE | A. Transporter's Phone (510) 429-8920 | | |
| | | B. Transporter's Phone | | | |
| | | C. Facility's Phone (707) 451-3276 | | | |
| 11. Waste Shipping Name and Description | | 12. Containers | | 13. Total Quantity | 14. Unit Wt/Vol |
| c. Soil contaminated with petroleum hydrocarbons | | No. | Type | | |
| | | 1 | T | 18 | Y |
| | | | | | |
| | | | | | |
| | | | | | |
| D. Additional Descriptions for Materials Listed Above Soil excavated from 40th Street UST Project 4000 San Pablo Ave., Emeryville, CA | | E. Handling Codes for Wastes Listed Above 03 | | | |
| 15. Special Handling Instructions and Additional Information | | | | | |
| 16. GENERATOR'S CERTIFICATION: I certify the materials described above on this manifest are not subject to federal regulations of reporting proper disposal of Hazardous Waste. | | | | | |
| Printed/Typed Name RONALD GERBER | | Signature <i>Ronald Gerber</i> | | Month | Day |
| | | | | 08 | 14 |
| 17. Transporter 1 Acknowledgement of Receipt of Materials | | Signature <i>James Arnold</i> | | Month | Day |
| | | | | 10 | 08 |
| 18. Transporter 2 Acknowledgement of Receipt of Materials | | Signature | | Month | Day |
| | | | | | |
| 19. Discrepancy Indication Space | | | | | |
| 20. Facility Owner or Operator: Certification of receipt of waste materials covered by this manifest except as noted in Item 19. | | | | | |
| Printed/Typed Name MARY BODER | | Signature <i>Mary Boder</i> | | Month | Day |
| | | | | 8 | 5 |

ORIGINAL-RETURN TO GENERATOR

| NON-HAZARDOUS WASTE MANIFEST | | 1. Generator's US EPA ID No. NOT APPLICABLE | Manifest Document No. | 2. Page 1 of | Authorizaton No. 01216 |
|--|--|--|---|-----------------|---------------------------|
| 3. Generator's Name and Mailing Address City of Emeryville Redevelopment Agency 2200 Powell St.; 12th Floor Emeryville, CA 94608 | | RS1 | | | |
| 4. Generator's Phone (510) 596-4356 Attn: Ignacio Dayrit | | | | | |
| 5. Transporter 1 Company Name Northern Truck and Equipment | 6. US EPA ID Number NOT APPLICABLE | 91 | | | |
| 7. Transporter 2 Company Name | 8. US EPA ID Number NOT APPLICABLE | | | | |
| 9. Designated Facility Name and Site Address B & J LANDFILL 6426 HAY ROAD VACAVILLE, CA 95687 | 10. US EPA ID Number NOT APPLICABLE | A. Transporter's Phone (510) 429-8920 | | | |
| | | B. Transporter's Phone | | | |
| | | C. Facility's Phone (707) 451-3276 | | | |
| 11. Waste Shipping Name and Description a. Soil contaminated with petroleum hydrocarbons | 12. Containers | | 13. Total Quantity | 14. Unit Wt/Vol | |
| | No. | Type | | | |
| | 1 | T | 18 | Y | |
| | . | . | . | | |
| | . | . | . | | |
| D. Additional Descriptions for Materials Listed Above Soil excavated from 40th Street UST Project 4000 San Pablo Ave., Emeryville, CA | | | E. Handling Codes for Wastes Listed Above 03 | | |
| 15. Special Handling Instructions and Additional Information | | | | | |
| 16. GENERATOR'S CERTIFICATION: I certify the materials described above on this manifest are not subject to federal regulations for reporting proper disposal of Hazardous Waste. | | | | | |
| Printed/Typed Name RONALD GERBER | | Signature <i>Ronald Gerber</i> | | Month 8 | Day 4 |
| 17. Transporter 1 Acknowledgement of Receipt of Materials | | Signature <i>P. J. Hurley</i> | | Month 8 | Day 5 |
| Printed/Typed Name P. J. Hurley | | Signature | | Month | Day |
| 18. Transporter 2 Acknowledgement of Receipt of Materials | | Signature | | Month | Day |
| Printed/Typed Name | | Signature | | Month | Day |
| 19. Discrepancy Indication Space | | | | | |
| 20. Facility Owner or Operator: Certification of receipt of waste materials covered by this manifest except as noted in Item 19. | | | | | |
| Printed/Typed Name MAY BARDEN | | Signature <i>May Barden</i> | | Month 8 | Day 5 |

ORIGINAL-RETURN TO GENERATOR

| | | | | | |
|--|--|--|---|--------------------|---------------------------|
| NON-HAZARDOUS WASTE MANIFEST | | 1. Generator's US EPA ID No. NOT APPLICABLE | Manifest Document No. | 2. Page 1 of | Authorizaton No. 01216 |
| 3. Generator's Name and Mailing Address City of Emeryville Redevelopment Agency 2200 Powell St.; 12th Floor Emeryville, CA 94608 | | 4. Generator's Phone (510) 596-4356 Attn: Ignacio Dayrit | | RBI 3113 289 | |
| 5. Transporter 1 Company Name Northern Truck and Equipment | 6. US EPA ID Number NOT APPLICABLE | | | | |
| 7. Transporter 2 Company Name | 8. US EPA ID Number NOT APPLICABLE | | | | |
| 9. Designated Facility Name and Site Address B & J LANDFILL 6426 HAY ROAD VACAVILLE, CA 95687 | | 10. US EPA ID Number NOT APPLICABLE | A. Transporter's Phone (510) 429-8920 B. Transporter's Phone C. Facility's Phone (707) 451-3276 | | |
| 11. Waste Shipping Name and Description | | 12. Containers | | 13. Total Quantity | 14. Unit Wt/Vol |
| a. Soil contaminated with petroleum hydrocarbons | | No. | Type | 18 | Y |
| b. | | | | | |
| c. | | | | | |
| d. | | | | | |
| D. Additional Descriptions for Materials Listed Above Soil excavated from 40th Street UST Project 4000 San Pablo Ave., Emeryville, CA | | E. Handling Codes for Wastes Listed Above 03 | | | |
| 15. Special Handling Instructions and Additional Information | | | | | |
| 16. GENERATOR'S CERTIFICATION: I certify the materials described above on this manifest are not subject to federal regulations for reporting proper disposal of Hazardous Waste. | | | | | |
| Printed/Typed Name RONALD GERBER | | Signature <i>Ronald Gerber</i> | | Month | Day |
| | | | | 8 | 4 |
| 17. Transporter 1 Acknowledgement of Receipt of Materials | | Signature <i>Jim Brooks</i> | | Month | Day |
| | | | | 8 | 5 |
| 18. Transporter 2 Acknowledgement of Receipt of Materials | | Signature | | Month | Day |
| | | | | | |
| 19. Discrepancy Indication Space | | | | | |
| 20. Facility Owner or Operator: Certification of receipt of waste materials covered by this manifest except as noted in Item 19. | | | | | |
| Printed/Typed Name MARK BOODER | | Signature <i>Mark Booder</i> | | Month | Day |
| | | | | 8 | 5 |

ORIGINAL-RETURN TO GENERATOR

| | | | | | |
|--|--|---|---|---------------------------------------|---------------------------|
| NON-HAZARDOUS WASTE MANIFEST | | 1. Generator's US EPA ID No. NOT APPLICABLE | Manifest Document No. | 2. Page 1 of | Authorizaton No. 01216 |
| 3. Generator's Name and Mailing Address City of Emeryville Redevelopment Agency 2200 Powell St.; 12th Floor Emeryville, CA 94608 | | | | RSI | |
| 4. Generator's Phone (510) 596-4356 Attn: Ignacio Dayrit | | | | | |
| 5. Transporter 1 Company Name Northern Truck and Equipment | | 6. US EPA ID Number NOT APPLICABLE | | 2113 591 | |
| 7. Transporter 2 Company Name | | 8. US EPA ID Number NOT APPLICABLE | | | |
| 9. Designated Facility Name and Site Address B & J LANDFILL 6426 HAY ROAD VACAVILLE, CA 95687 | | 10. US EPA ID Number NOT APPLICABLE | | A. Transporter's Phone (510) 429-8920 | |
| | | | | B. Transporter's Phone | |
| | | | | C. Facility's Phone (707) 451-3276 | |
| 11. Waste Shipping Name and Description | | | 12. Containers | 13. Total Quantity | 14. Unit Wt/Vol |
| a. Soil contaminated with petroleum hydrocarbons | | | No. 1 | Type T | 18 Y |
| b. | | | | | |
| c. | | | | | |
| d. | | | | | |
| D. Additional Descriptions for Materials Listed Above Soil excavated from 40th Street UST Project 4000 San Pablo Ave., Emeryville, CA | | | E. Handling Codes for Wastes Listed Above 03 | | |
| 15. Special Handling Instructions and Additional Information | | | | | |
| 16. GENERATOR'S CERTIFICATION: I certify the materials described above on this manifest are not subject to federal regulations for reporting proper disposal of Hazardous Waste. | | | | | |
| Printed/Typed Name RONALD GERBER | | Signature <i>Ronald Gerber</i> | | Month Day Year 8 4 99 | |
| 17. Transporter 1 Acknowledgement of Receipt of Materials | | | | | |
| Printed/Typed Name JOHN DUCCA | | Signature <i>John Ducca</i> | | Month Day Year 8 3 99 | |
| 18. Transporter 2 Acknowledgement of Receipt of Materials | | | | | |
| Printed/Typed Name | | Signature | | Month Day Year | |
| 19. Discrepancy Indication Space | | | | | |
| 20. Facility Owner or Operator: Certification of receipt of waste materials covered by this manifest except as noted in Item 19. | | | | | |
| Printed/Typed Name MAY BORDEN | | Signature <i>May Borden</i> | | Month Day Year 8 3 99 | |

| NON-HAZARDOUS WASTE MANIFEST | | 1. Generator's US EPA ID No. NOT APPLICABLE | Manifest Document No. | 2. Page 1 of | Authorizaton No. 01216 |
|--|--|---|-----------------------|---------------------------------------|---------------------------|
| 3. Generator's Name and Mailing Address City of Emeryville Redevelopment Agency 2200 Powell St.; 12th Floor Emeryville, CA 94608 | | 6. US EPA ID Number NOT APPLICABLE | | 2113 | RST 091 |
| 4. Generator's Phone (510) 596-4356 Attn: Ignacio Dayrit | | 8. US EPA ID Number NOT APPLICABLE | | | |
| 5. Transporter 1 Company Name Northern Truck and Equipment | | 10. US EPA ID Number NOT APPLICABLE | | A. Transporter's Phone (510) 429-8920 | |
| 7. Transporter 2 Company Name | | | | B. Transporter's Phone | |
| 9. Designated Facility Name and Site Address B & J LANDFILL 6426 HAY ROAD VACAVILLE, CA 95687 | | | | C. Facility's Phone (707) 451-3276 | |
| 11. Waste Shipping Name and Description | | 12. Containers | | 13. Total Quantity | 14. Unit Wt/Vol |
| a. Soil contaminated with petroleum hydrocarbons | | No. | Type | 18 | Y |
| b. | | | | | |
| c. | | | | | |
| d. | | | | | |
| D. Additional Descriptions for Materials Listed Above Soil excavated from 40th Street UST Project 4000 San Pablo Ave., Emeryville, CA | | E. Handling Codes for Wastes Listed Above 03 | | | |
| 15. Special Handling Instructions and Additional Information | | | | | |
| 16. GENERATOR'S CERTIFICATION: I certify the materials described above on this manifest are not subject to federal regulations for reporting proper disposal of Hazardous Waste. | | | | | |
| Printed/Typed Name RONALD GERBER | | Signature <i>Ronald Gerber</i> | | Month Day Year 8 4 94 | |
| 17. Transporter 1 Acknowledgement of Receipt of Materials Printed/Typed Name CJ BLANDELL | | Signature <i>CJ Blundell</i> | | Month Day Year 10 8 05 94 | |
| 18. Transporter 2 Acknowledgement of Receipt of Materials Printed/Typed Name | | Signature | | Month Day Year | |
| 19. Discrepancy Indication Space | | | | | |
| 20. Facility Owner or Operator: Certification of receipt of waste materials covered by this manifest except as noted in Item 19. | | | | | |
| Printed/Typed Name MARY BORDEN | | Signature <i>Mary Borden</i> | | Month Day Year 1 8 5 94 | |

GENERATOR

TRANSPORTER

FACILITY

| NON-HAZARDOUS WASTE MANIFEST | | 1. Generator's US EPA ID No. NOT APPLICABLE | Manifest Document No. | 2. Page 1 of | Authorizaton No. 01216 |
|---|---------------------------------------|--|---|--------------------|---------------------------|
| 3. Generator's Name and Mailing Address City of Emeryville Redevelopment Agency 2200 Powell St.; 12th Floor Emeryville, CA 94608 | | | | RSI B14 | |
| 4. Generator's Phone (510) 596-4356 Attn: Ignacio Dayrit | | | | | |
| 5. Transporter 1 Company Name Northern Truck and Equipment | 6. US EPA ID Number NOT APPLICABLE | | | 313 | |
| 7. Transporter 2 Company Name | 8. US EPA ID Number NOT APPLICABLE | | | | |
| 9. Designated Facility Name and Site Address B & J LANDFILL 6426 HAY ROAD VACAVILLE, CA 95687 | | 10. US EPA ID Number NOT APPLICABLE | A. Transporter's Phone (510) 429-8920 | | B. Transporter's Phone |
| | | | C. Facility's Phone (707) 451-3276 | | |
| 11. Waste Shipping Name and Description | | | 12. Containers | 13. Total Quantity | 14. Unit Wt/Vol |
| a. Soil contaminated with petroleum hydrocarbons | | | No. 1 | Type T | 18 Y |
| b. | | | | | |
| c. | | | | | |
| d. | | | | | |
| D. Additional Descriptions for Materials Listed Above Soil excavated from 40th Street UST Project 4000 San Pablo Ave., Emeryville, CA | | | E. Handling Codes for Wastes Listed Above 03 | | |
| 15. Special Handling Instructions and Additional Information | | | | | |
| 16. GENERATOR'S CERTIFICATION: I certify the materials described above on this manifest are not subject to federal regulation for reporting proper disposal of Hazardous Waste. | | | | | |
| Printed/Typed Name RONALD GUBER | | Signature <i>Ronald Guber</i> | | Month 8 | Day 4 |
| 17. Transporter 1 Acknowledgement of Receipt of Materials | | | | Year 94 | |
| Printed/Typed Name BRADY HOIT | | Signature <i>Brady Hoit</i> | | Month 8 | Day 4 |
| 18. Transporter 2 Acknowledgement of Receipt of Materials | | | | Year 94 | |
| Printed/Typed Name | | Signature | | Month | Day |
| 19. Discrepancy Indication Space | | | | | |
| 20. Facility Owner or Operator: Certification of receipt of waste materials covered by this manifest except as noted in Item 19. | | | | | |
| Printed/Typed Name MARY BOREN | | Signature <i>Mary Boren</i> | | Month 8 | Day 15 |
| | | | | Year 94 | |

| NON-HAZARDOUS WASTE MANIFEST | | 1. Generator's US EPA ID No. NOT APPLICABLE | Manifest Document No. | 2. Page 1 of | Authorizaton No. 01216 | |
|--|--|--|-----------------------|---|---------------------------|-----------------|
| 3. Generator's Name and Mailing Address City of Emeryville Redevelopment Agency 2200 Powell St.; 12th Floor Emeryville, CA 94608 | | | | R S I | | |
| 4. Generator's Phone (510) 596-4356 Attn: Ignacio Dayrit | | | | | | |
| 5. Transporter 1 Company Name Northern Truck and Equipment | | 6. US EPA ID Number NOT APPLICABLE | | 3113 B4 | | |
| 7. Transporter 2 Company Name | | 8. US EPA ID Number NOT APPLICABLE | | | | |
| 9. Designated Facility Name and Site Address B & J LANDFILL 6426 HAY ROAD VACAVILLE, CA 95687 | | 10. US EPA ID Number NOT APPLICABLE | | A. Transporter's Phone (510) 429-8920 B. Transporter's Phone C. Facility's Phone (707) 451-3276 | | |
| 11. Waste Shipping Name and Description | | | | 12. Containers | 13. Total Quantity | 14. Unit Wt/Vol |
| a. Soil contaminated with petroleum hydrocarbons | | | | No. 1 | Type T | 18 Y |
| b. | | | | | | |
| c. | | | | | | |
| d. | | | | | | |
| D. Additional Descriptions for Materials Listed Above Soil excavated from 40th Street UST Project 4000 San Pablo Ave., Emeryville, CA | | | | E. Handling Codes for Wastes Listed Above 03 | | |
| 15. Special Handling Instructions and Additional Information | | | | | | |
| 16. GENERATOR'S CERTIFICATION: I certify the materials described above on this manifest are not subject to federal regulations for reporting proper disposal of Hazardous Waste. | | | | | | |
| Printed/Typed Name RONALD GERBER | | Signature <i>Ronald Gerber</i> | | Month Day Year 8 4 94 | | |
| 17. Transporter 1 Acknowledgement of Receipt of Materials | | Printed/Typed Name ARNOLD PAOLICA | | Signature <i>Arnold Paolica</i> | | |
| 18. Transporter 2 Acknowledgement of Receipt of Materials | | Printed/Typed Name | | Signature | | |
| 19. Discrepancy Indication Space | | | | Month Day Year | | |
| 20. Facility Owner or Operator: Certification of receipt of waste materials covered by this manifest except as noted in item 19. | | | | | | |
| Printed/Typed Name MARY BORDEN | | Signature <i>Mary Borden</i> | | Month Day Year 8 15 94 | | |

ORIGINAL-RETURN TO GENERATOR

| | | | | | |
|--|--|---|---------------------------------------|----------------------------|---------------------------|
| NON-HAZARDOUS WASTE MANIFEST | | 1. Generator's US EPA ID No. NOT APPLICABLE | Manifest Document No. | 2. Page 1 of 1 | Authorizaton No. 01216 |
| 3. Generator's Name and Mailing Address City of Emeryville Redevelopment Agency 2200 Powell St.; 12th Floor Emeryville, CA 94608 | | | | | |
| 4. Generator's Phone (510) 596-4356 Attn: Ignacio Davrit | | | | | |
| 5. Transporter 1 Company Name Northern Truck and Equipment | 6. US EPA ID Number NOT APPLICABLE | 3113 | | 594 | |
| 7. Transporter 2 Company Name | 8. US EPA ID Number NOT APPLICABLE | | | | |
| 9. Designated Facility Name and Site Address B & J LANDFILL 6426 HAY ROAD VACAVILLE, CA 95687 | | 10. US EPA ID Number NOT APPLICABLE | A. Transporter's Phone (510) 429-8920 | | |
| | | | B. Transporter's Phone | | |
| | | | C. Facility's Phone (707) 451-3276 | | |
| 11. Waste Shipping Name and Description | | 12. Containers | | 13. Total Quantity | 14. Unit Wt/Vol |
| a. Soil contaminated with petroleum hydrocarbons | | No. | Type | | |
| | | 1 | T | 18 | Y |
| b. | | | | | |
| c. | | | | | |
| d. | | | | | |
| D. Additional Descriptions for Materials Listed Above Soil excavated from 40th Street UST Project 4000 San Pablo Ave., Emeryville, CA | | E. Handling Codes for Wastes Listed Above 03 | | | |
| 15. Special Handling Instructions and Additional Information | | | | | |
| 16. GENERATOR'S CERTIFICATION: I certify the materials described above on this manifest are not subject to federal regulations for reporting proper disposal of Hazardous Waste. | | | | | |
| Printed/Typed Name RONALD GERBER | | Signature <i>Ronald Gerber</i> | | Month Day Year 08 04 94 | |
| 17. Transporter 1 Acknowledgement of Receipt of Materials Printed/Typed Name JIMMIE W SHAW | | Signature <i>Jimmie W Shaw</i> | | Month Day Year 08 05 94 | |
| 18. Transporter 2 Acknowledgement of Receipt of Materials Printed/Typed Name | | Signature | | Month Day Year | |
| 19. Discrepancy Indication Space | | | | | |
| 20. Facility Owner or Operator: Certification of receipt of waste materials covered by this manifest except as noted in Item 19. | | | | | |
| Printed/Typed Name W A Fisher | | Signature <i>W A Fisher</i> | | Month Day Year 08 05 94 | |

GENERATOR

TRANSPORTER

FACILITY

| | | | | | |
|--|--|--|-----------------------|---|---------------------------|
| NON-HAZARDOUS WASTE MANIFEST | | 1. Generator's US EPA ID No. NOT APPLICABLE | Manifest Document No. | 2. Page 1 of | Authorizaton No. 01216 |
| 3. Generator's Name and Mailing Address City of Emeryville Redevelopment Agency 2200 Powell St.; 12th Floor Emeryville, CA 94608 | | 4. Generator's Phone (510) 596-4356 Attn: Ignacio Dayrit | | | |
| 5. Transporter 1 Company Name Northern Truck and Equipment | 6. US EPA ID Number NOT APPLICABLE | 7. Transporter 2 Company Name | | 8. US EPA ID Number NOT APPLICABLE | |
| 9. Designated Facility Name and Site Address B & J LANDFILL 6426 HAY ROAD VACAVILLE, CA 95687 | | 10. US EPA ID Number NOT APPLICABLE | | A. Transporter's Phone (510) 429-8920 B. Transporter's Phone C. Facility's Phone (707) 451-3276 | |
| 11. Waste Shipping Name and Description | | 12. Containers | | 13. Total Quantity | 14. Unit Wt/Vol |
| a. Soil contaminated with petroleum hydrocarbons | | No. | Type | 18 | Y |
| b. | | | | | |
| c. | | | | | |
| d. | | | | | |
| D. Additional Descriptions for Materials Listed Above Soil excavated from 40th Street UST Project 4000 San Pablo Ave., Emeryville, CA | | E. Handling Codes for Wastes Listed Above 03 | | | |
| 15. Special Handling Instructions and Additional Information | | | | | |
| 16. GENERATOR'S CERTIFICATION: I certify the materials described above on this manifest are not subject to federal regulations for reporting proper disposal of Hazardous Waste. | | | | | |
| Printed/Typed Name RONALD GERBER | | Signature <i>Ronald Gerber</i> | | Month Day Year 10 20 04 | |
| 17. Transporter 1 Acknowledgement of Receipt of Materials Printed/Typed Name <i>Rose Lewis</i> | | Signature <i>Rose Lewis</i> | | Month Day Year 1 8 04 | |
| 18. Transporter 2 Acknowledgement of Receipt of Materials Printed/Typed Name | | Signature | | Month Day Year | |
| 19. Discrepancy Indication Space | | | | | |
| 20. Facility Owner or Operator: Certification of receipt of waste materials covered by this manifest except as noted in Item 19. | | | | | |
| Printed/Typed Name MARY BORDEN | | Signature <i>Mary Borden</i> | | Month Day Year 1 8 04 | |

ORIGINAL-RETURN TO GENERATOR

| NON-HAZARDOUS WASTE MANIFEST | | 1. Generator's US EPA ID No. NOT APPLICABLE | Manifest Document No. | 2. Page 1 of | Authorizaton No. 01216 |
|--|---------------------------------------|---|---------------------------------------|----------------------------|---------------------------|
| 3. Generator's Name and Mailing Address City of Emeryville Redevelopment Agency 2200 Powell St.; 12th Floor Emeryville, CA 94608 | | | | | |
| 4. Generator's Phone (510) 596-4356 Attn: Ignacio Dayrit | | | | R-64 | |
| 5. Transporter 1 Company Name Northern Truck and Equipment | 6. US EPA ID Number NOT APPLICABLE | | | | |
| 7. Transporter 2 Company Name | 8. US EPA ID Number NOT APPLICABLE | | | | |
| 9. Designated Facility Name and Site Address B & J LANDFILL 6426 HAY ROAD VACAVILLE, CA 95687 | | 10. US EPA ID Number NOT APPLICABLE | A. Transporter's Phone (510)429-8920 | | B. Transporter's Phone |
| | | | C. Facility's Phone (707) 451-3276 | | |
| 11. Waste Shipping Name and Description | | 12. Containers | | 13. Total Quantity | 14. Unit Wt/Vol |
| a. Soil contaminated with petroleum hydrocarbons | | No. | Type | | |
| | | 1 | T | 18 | Y |
| b. | | | | | |
| c. | | | | | |
| d. | | | | | |
| D. Additional Descriptions for Materials Listed Above Soil excavated from 40th Street UST Project 4000 San Pablo Ave., Emeryville, CA | | E. Handling Codes for Wastes Listed Above 03 | | | |
| 15. Special Handling Instructions and Additional Information | | | | | |
| 16. GENERATOR'S CERTIFICATION: I certify the materials described above on this manifest are not subject to federal regulations for reporting proper disposal of Hazardous Waste. | | | | | |
| Printed/Typed Name RONALD GERBER | | Signature Ronald Gerber | | Month Day Year 08 04 94 | |
| 17. Transporter 1 Acknowledgement of Receipt of Materials | | Printed/Typed Name Craig Rice | | Signature Craig Rice | |
| 18. Transporter 2 Acknowledgement of Receipt of Materials | | Printed/Typed Name | | Signature | |
| 19. Discrepancy Indication Space | | | | | |
| 20. Facility Owner or Operator: Certification of receipt of waste materials covered by this manifest except as noted in Item 19. | | | | | |
| Printed/Typed Name William Fisher | | Signature William Fisher | | Month Day Year 08 04 94 | |

GENERATOR
TRANSPORTER
FACILITY

**NON-HAZARDOUS
 WASTE MANIFEST**

1. Generator's US EPA ID No.
 NOT APPLICABLE

Manifest Document No.

2. Page 1 of

Authorizaton No.
 01216

3. Generator's Name and Mailing Address
 City of Emeryville Redevelopment Agency
 2200 Powell St.; 12th Floor
 Emeryville, CA 94608
 4. Generator's Phone (510) 596-4356 Attn: Ignacio Dayrit

5. Transporter 1 Company Name
 Northern Truck and Equipment
 6. US EPA ID Number
 NOT APPLICABLE

7. Transporter 2 Company Name
 8. US EPA ID Number
 NOT APPLICABLE

9. Designated Facility Name and Site Address
 B & J LANDFILL
 6426 HAY ROAD
 VACAVILLE, CA 95687
 10. US EPA ID Number
 NOT APPLICABLE

A. Transporter's Phone (510)429-8920
 B. Transporter's Phone
 C. Facility's Phone
 (707) 451-3276

11. Waste Shipping Name and Description

a. Soil contaminated with petroleum hydrocarbons

| 12. Containers | | 13. Total Quantity | 14. Unit Wt/Vol |
|----------------|------|--------------------|-----------------|
| No. | Type | | |
| 1 | T | 18 | Y |
| .. | . | .. | .. |
| .. | . | .. | .. |
| .. | . | .. | .. |

D. Additional Descriptions for Materials Listed Above
 Soil excavated from 40th Street UST Project
 4000 San Pablo Ave., Emeryville, CA

E. Handling Codes for Wastes Listed Above
 03

15. Special Handling Instructions and Additional Information

16. GENERATOR'S CERTIFICATION: I certify the materials described above on this manifest are not subject to federal regulations for reporting proper disposal of Hazardous Waste.

Printed/Typed Name RONALD GERBER Signature Ronald Gerber Month 08 Day 04 Year 94

17. Transporter 1 Acknowledgement of Receipt of Materials
 Printed/Typed Name Roy Vincent Signature [Signature] Month 8 Day 5 Year 94

18. Transporter 2 Acknowledgement of Receipt of Materials
 Printed/Typed Name _____ Signature _____ Month _____ Day _____ Year _____

19. Discrepancy Indication Space

20. Facility Owner or Operator: Certification of receipt of waste materials covered by this manifest except as noted in Item 19
 Printed/Typed Name Will Fisher Signature [Signature] Month 8 Day 5 Year 94

GENERATOR
TRANSPORTER
FACILITY

**NON-HAZARDOUS
WASTE MANIFEST**

1. Generator's US EPA ID No. **NOT APPLICABLE** Manifest Document No. 2. Page 1 of 1 Authorizaton No. 01216

3. Generator's Name and Mailing Address
City of Emeryville Redevelopment Agency
2200 Powell St.; 12th Floor
Emeryville, CA 94608
4. Generator's Phone (510) 596-4356 Attn: Ignacio Dayrit

COLLINS
#6

5. Transporter 1 Company Name
Northern Truck and Equipment
6. US EPA ID Number
NOT APPLICABLE

3113

7. Transporter 2 Company Name
8. US EPA ID Number
NOT APPLICABLE

9. Designated Facility Name and Site Address
B & J LANDFILL
6426 HAY ROAD
VACAVILLE, CA 95687
10. US EPA ID Number
NOT APPLICABLE

A. Transporter's Phone (510)429-8920

B. Transporter's Phone

C. Facility's Phone
(707) 451-3276

11. Waste Shipping Name and Description

| 12. Containers | 13. Total Quantity | 14. Unit Wt/Vol |
|----------------|--------------------|-----------------|
| | | |
| 1 | 18 | Y |
| | | |
| | | |
| | | |

a. Soil contaminated with petroleum hydrocarbons

D. Additional Descriptions for Materials Listed Above
Soil excavated from 40th Street UST Project
4000 San Pablo Ave., Emeryville, CA

E. Handling Codes for Wastes Listed Above
03

15. Special Handling Instructions and Additional Information

16. GENERATOR'S CERTIFICATION: I certify the materials described above on this manifest are not subject to federal regulations for reporting proper disposal of Hazardous Waste.

Printed/Typed Name **RONALD GERBER** Signature *Ronald Gerber* Month Day Year 08 04 94

17. Transporter 1 Acknowledgement of Receipt of Materials
Printed/Typed Name Signature Month Day Year

18. Transporter 2 Acknowledgement of Receipt of Materials
Printed/Typed Name **Leon MORRIS** Signature *Leon Morris* Month Day Year 08 05 94

19. Discrepancy Indication Space

20. Facility Owner or Operator: Certification of receipt of waste materials covered by this manifest except as noted in Item 19.

Printed/Typed Name **MARY BORDEN** Signature *Mary Borden* Month Day Year 08 05 94

| | | | | | |
|--|--|---|--------------------------------------|----------------------------|---------------------------|
| NON-HAZARDOUS WASTE MANIFEST | | 1. Generator's US EPA ID No. NOT APPLICABLE | Manifest Document No. | 2. Page 1 of | Authorizaton No. 01216 |
| 3. Generator's Name and Mailing Address City of Emeryville Redevelopment Agency 2200 Powell St.; 12th Floor Emeryville, CA 94608 | | | | | |
| 4. Generator's Phone (510) 596-4356 Attn: Ignacio Dayrit | | | | | |
| 5. Transporter 1 Company Name Northern Truck and Equipment | 6. US EPA ID Number NOT APPLICABLE | | | 3113 | |
| 7. Transporter 2 Company Name | 8. US EPA ID Number NOT APPLICABLE | | | | |
| 9. Designated Facility Name and Site Address B & J LANDFILL 6426 HAY ROAD VACAVILLE, CA 95687 | | 10. US EPA ID Number NOT APPLICABLE | A. Transporter's Phone (510)429-8920 | | |
| | | B. Transporter's Phone | | | |
| | | C. Facility's Phone (707) 451-3276 | | | |
| 11. Waste Shipping Name and Description | | 12. Containers | | 13. Total Quantity | 14. Unit Wt/Vol |
| a. Soil contaminated with petroleum hydrocarbons | | No. | Type | | |
| | | 1 | T | 18 | Y |
| b. | | | | | |
| c. | | | | | |
| d. | | | | | |
| D. Additional Descriptions for Materials Listed Above Soil excavated from 40th Street UST Project 4000 San Pablo Ave., Emeryville, CA | | E. Handling Codes for Wastes Listed Above 03 | | | |
| 15. Special Handling Instructions and Additional Information | | | | | |
| 16. GENERATOR'S CERTIFICATION: I certify the materials described above on this manifest are not subject to federal regulations for reporting proper disposal of Hazardous Waste. | | | | | |
| Printed/Typed Name RONALD GERBER | | Signature <i>Ronald Gerber</i> | | Month Day Year 08 04 94 | |
| 17. Transporter 1 Acknowledgement of Receipt of Materials Printed/Typed Name JAY SMITH | | Signature <i>Jay Smith</i> | | Month Day Year 08 04 94 | |
| 18. Transporter 2 Acknowledgement of Receipt of Materials Printed/Typed Name | | Signature | | Month Day Year | |
| 19. Discrepancy Indication Space | | | | | |
| 20. Facility Owner or Operator: Certification of receipt of waste materials covered by this manifest except as noted in Item 19. | | | | | |
| Printed/Typed Name MARY BORDEN | | Signature <i>Mary Borden</i> | | Month Day Year 08 05 94 | |

ORIGINAL-RETURN TO GENERATOR

| | | | | | |
|--|--|--|---|-----------------------------------|---------------------------|
| NON-HAZARDOUS WASTE MANIFEST | | 1. Generator's US EPA ID No. NOT APPLICABLE | Manifest Document No. | 2. Page 1 of | Authorizaton No. 01216 |
| 3. Generator's Name and Mailing Address City of Emeryville Redevelopment Agency 2200 Powell St.; 12th Floor Emeryville, CA 94608 | | 4. Generator's Phone (510) 596-4356 Attn: Ignacio Dayrit | | | |
| 5. Transporter 1 Company Name Northern Truck and Equipment | 6. US EPA ID Number NOT APPLICABLE | 3113 #88 | | | |
| 7. Transporter 2 Company Name | 8. US EPA ID Number NOT APPLICABLE | | | | |
| 9. Designated Facility Name and Site Address B & J LANDFILL 6426 HAY ROAD VACAVILLE, CA 95687 | | 10. US EPA ID Number NOT APPLICABLE | A. Transporter's Phone (510) 429-8920 B. Transporter's Phone C. Facility's Phone (707) 451-3276 | | |
| 11. Waste Shipping Name and Description | | 12. Containers | 13. Total Quantity | 14. Unit Wt/Vol | |
| a. Soil contaminated with petroleum hydrocarbons | | No. 1 | Type T | Quantity 18 | Unit Y |
| b. | | | | | |
| c. | | | | | |
| d. | | | | | |
| D. Additional Descriptions for Materials Listed Above Soil excavated from 40th Street UST Project 4000 San Pablo Ave., Emeryville, CA | | E. Handling Codes for Wastes Listed Above 03 | | | |
| 15. Special Handling Instructions and Additional Information | | | | | |
| 16. GENERATOR'S CERTIFICATION: I certify the materials described above on this manifest are not subject to federal regulations for reporting proper disposal of Hazardous Waste. | | | | | |
| Printed/Typed Name RONALD GERBER | | Signature <i>Ronald Gerber</i> | | Month Day Year 08 04 94 | |
| 17. Transporter 1 Acknowledgement of Receipt of Materials Printed/Typed Name DAN ROSE | | Signature <i>Dan Rose</i> | | Month Day Year 08 04 94 | |
| 18. Transporter 2 Acknowledgement of Receipt of Materials Printed/Typed Name | | Signature | | Month Day Year | |
| 19. Discrepancy Indication Space | | | | | |
| 20. Facility Owner or Operator: Certification of receipt of waste materials covered by this manifest except as noted in Item 19. | | | | | |
| Printed/Typed Name MARY BORDEN | | Signature <i>Mary Borden</i> | | Month Day Year 1 8 51 94 | |

ORIGINAL-RETURN TO GENERATOR

**NON-HAZARDOUS
 WASTE MANIFEST**

1. Generator's US EPA ID No.
 NOT APPLICABLE

Manifest Document No.

2. Page 1 of

Authorizaton No.
 01216

3. Generator's Name and Mailing Address
 City of Emeryville Redevelopment Agency
 2200 Powell St.; 12th Floor
 Emeryville, CA 94608

4. Generator's Phone (510) 596-4356 Attn: Ignacio Dayrit

5. Transporter 1 Company Name
 Northern Truck and Equipment

6. US EPA ID Number
 NOT APPLICABLE

7. Transporter 2 Company Name

8. US EPA ID Number
 NOT APPLICABLE

9. Designated Facility Name and Site Address
 B & J LANDFILL
 6426 HAY ROAD
 VACAVILLE, CA 95687

10. US EPA ID Number
 NOT APPLICABLE

A. Transporter's Phone (510) 429-8920

B. Transporter's Phone

C. Facility's Phone
 (707) 451-3276

11. Waste Shipping Name and Description

a. Soil contaminated with petroleum hydrocarbons

| 12. Containers | | 13. Total Quantity | 14. Unit Wt/Vol |
|----------------|------|--------------------|-----------------|
| No. | Type | | |
| 1 | T | 18 | Y |
| | | | |
| | | | |
| | | | |
| | | | |

D. Additional Descriptions for Materials Listed Above
 Soil excavated from 40th Street UST Project
 4000 San Pablo Ave., Emeryville, CA

E. Handling Codes for Wastes Listed Above
 03

15. Special Handling Instructions and Additional Information

16. GENERATOR'S CERTIFICATION: I certify the materials described above on this manifest are not subject to federal regulations for reporting proper disposal of Hazardous Waste.

Printed/Typed Name
 RONALD BERBSA

Signature
 Ronald Berbsa
 Month Day Year
 08 04 94

17. Transporter 1 Acknowledgement of Receipt of Materials

Printed/Typed Name
 PHIL ROUSS

Signature
 Phil Rouss
 Month Day Year
 8 5 94

18. Transporter 2 Acknowledgement of Receipt of Materials

Printed/Typed Name

Signature
 Month Day Year

19. Discrepancy Indication Space

20. Facility Owner or Operator: Certification of receipt of waste materials covered by this manifest except as noted in Item 19.

Printed/Typed Name
 MARY BORDER

Signature
 Mary Border
 Month Day Year
 8 3 94

| | | | | | |
|--|--|---|---------------------------------------|----------------------------------|---------------------------|
| NON HAZARDOUS WASTE MANIFEST | | 1. Generator's US EPA ID No. NOT APPLICABLE | Manifest Document No. | 2. Page 1 of | Authorizaton No. 01216 |
| 3. Generator's Name and Mailing Address City of Emeryville Redevelopment Agency 2200 Powell St.; 12th Floor Emeryville, CA 94608 | | | | | |
| 4. Generator's Phone (510) 596-4356 Attn: Ignacio Davrit | | | | | |
| 5. Transporter 1 Company Name Northern Truck and Equipment | 6. US EPA ID Number NOT APPLICABLE | | | 3113 | 191 |
| 7. Transporter 2 Company Name | 8. US EPA ID Number NOT APPLICABLE | | | | |
| 9. Designated Facility Name and Site Address B & J LANDFILL 6426 HAY ROAD VACAVILLE, CA 95687 | | 10. US EPA ID Number NOT APPLICABLE | A. Transporter's Phone (510) 429-8920 | | |
| | | B. Transporter's Phone | | | |
| | | C. Facility's Phone (707) 451-3276 | | | |
| 11. Waste Shipping Name and Description | | 12. Containers | | 13. Total Quantity | 14. Unit Wt/Vol |
| a. Soil contaminated with petroleum hydrocarbons | | No. | Type | | |
| | | 1 | T | 18 | Y |
| b. | | | | | |
| c. | | | | | |
| d. | | | | | |
| D. Additional Descriptions for Materials Listed Above Soil excavated from 40th Street UST Project 4000 San Pablo Ave., Emeryville, CA | | E. Handling Codes for Wastes Listed Above 03 | | | |
| 15. Special Handling Instructions and Additional Information | | | | | |
| 16. GENERATOR'S CERTIFICATION: I certify the materials described above on this manifest are not subject to federal regulations for reporting proper disposal of Hazardous Waste. | | | | | |
| Printed/Typed Name RONALD GERBER | | Signature <i>Ronald Gerber</i> | | Month Day Year 10.8.94 | |
| 17. Transporter 1 Acknowledgement of Receipt of Materials | | Printed/Typed Name JAMES ARNOLD | | Signature <i>James Arnold</i> | |
| | | | | Month Day Year 10.8.94 | |
| 18. Transporter 2 Acknowledgement of Receipt of Materials | | Printed/Typed Name | | Signature | |
| | | | | Month Day Year | |
| 19. Discrepancy Indication Space | | | | | |
| 20. Facility Owner or Operator: Certification of receipt of waste materials covered by this manifest except as noted in Item 19. | | | | | |
| Printed/Typed Name Jill A. Fisher | | Signature <i>Jill A. Fisher</i> | | Month Day Year 10.15.94 | |

ORIGINAL-RETURN TO GENERATOR

| NON-HAZARDOUS WASTE MANIFEST | | 1. Generator's US EPA ID No. NOT APPLICABLE | Manifest Document No. | 2. Page 1 of | Authorizaton No. 01216 |
|--|---------------------------------------|--|---|---|---------------------------|
| 3. Generator's Name and Mailing Address City of Emeryville Redevelopment Agency 2200 Powell St.; 12th Floor Emeryville, CA 94608 | | | | | |
| 4. Generator's Phone (510) 596-4356 Attn: Ignacio Dayrit | | | | | |
| 5. Transporter 1 Company Name Northern Truck and Equipment | 6. US EPA ID Number NOT APPLICABLE | | | 3113 | |
| 7. Transporter 2 Company Name | 8. US EPA ID Number NOT APPLICABLE | | | | |
| 9. Designated Facility Name and Site Address B & J LANDFILL 6426 HAY ROAD VACAVILLE, CA 95687 | | 10. US EPA ID Number NOT APPLICABLE | | A. Transporter's Phone (510) 429-8920 B. Transporter's Phone C. Facility's Phone (707) 451-3276 | |
| 11. Waste Shipping Name and Description | | 12. Containers | | 13. Total Quantity | 14. Unit Wt/Vol |
| a. Soil contaminated with petroleum hydrocarbons | | No. | Type | 18 | Y |
| b. | | | | | |
| c. | | | | | |
| d. | | | | | |
| D. Additional Descriptions for Materials Listed Above Soil excavated from 40th Street UST Project 4000 San Pablo Ave., Emeryville, CA | | | E. Handling Codes for Wastes Listed Above 03 | | |
| 15. Special Handling Instructions and Additional Information | | | | | |
| 16. GENERATOR'S CERTIFICATION: I certify the materials described above on this manifest are not subject to federal regulations for reporting proper disposal of Hazardous Waste. | | | | | |
| Printed/Typed Name RONALD GERBER | | Signature <i>Ronald Gerber</i> | | Month Day Year 08 04 94 | |
| 17. Transporter 1 Acknowledgement of Receipt of Materials | | | | | |
| Printed/Typed Name John Ducca | | Signature <i>John Ducca</i> | | Month Day Year 08 05 94 | |
| 18. Transporter 2 Acknowledgement of Receipt of Materials | | | | | |
| Printed/Typed Name | | Signature | | Month Day Year | |
| 19. Discrepancy Indication Space | | | | | |
| 20. Facility Owner or Operator: Certification of receipt of waste materials covered by this manifest except as noted in Item 19. | | | | | |
| Printed/Typed Name MARY BORDEN | | Signature <i>Mary Borden</i> | | Month Day Year 08 05 94 | |

ORIGINAL-RETURN TO GENERATOR

| | | | | | |
|--|--|--|---|--|---------------------------|
| NON-HAZARDOUS WASTE MANIFEST | | 1. Generator's US EPA ID No. NOT APPLICABLE | Manifest Document No. | 2. Page 1 of | Authorizaton No. 01216 |
| 3. Generator's Name and Mailing Address City of Emeryville Redevelopment Agency 2200 Powell St.; 12th Floor Emeryville, CA 94608 | | 4. Generator's Phone (510) 596-4356 Attn: Ignacio Dayrit | | <i>B14</i> | |
| 5. Transporter 1 Company Name Northern Truck and Equipment | 6. US EPA ID Number NOT APPLICABLE | 7. Transporter 2 Company Name | 8. US EPA ID Number NOT APPLICABLE | | |
| 9. Designated Facility Name and Site Address B & J LANDFILL 6426 HAY ROAD VACAVILLE, CA 95687 | | 10. US EPA ID Number NOT APPLICABLE | | A. Transporter's Phone (510)429-8920 B. Transporter's Phone C. Facility's Phone (707) 451-3276 | |
| 11. Waste Shipping Name and Description | | | 12. Containers | 13. Total Quantity | 14. Unit Wt/Vol |
| a. Soil contaminated with petroleum hydrocarbons | | | No. 1 | Type T | 18 Y |
| b. | | | | | |
| c. | | | | | |
| d. | | | | | |
| D. Additional Descriptions for Materials Listed Above Soil excavated from 40th Street UST Project 4000 San Pablo Ave., Emeryville, CA | | | E. Handling Codes for Wastes Listed Above 03 | | |
| 15. Special Handling Instructions and Additional Information | | | | | |
| 16. GENERATOR'S CERTIFICATION: I certify the materials described above on this manifest are not subject to federal regulations for reporting proper disposal of Hazardous Waste. | | | | | |
| Printed/Typed Name <i>RONALD GERBER</i> | | Signature <i>Ronald Gerber</i> | | Month Day Year 8 5 94 | |
| 17. Transporter 1 Acknowledgement of Receipt of Materials | | | | | |
| Printed/Typed Name <i>BRADY HOLT</i> | | Signature <i>BRADY HOLT</i> | | Month Day Year 8 17 94 | |
| 18. Transporter 2 Acknowledgement of Receipt of Materials | | | | | |
| Printed/Typed Name | | Signature | | Month Day Year | |
| 19. Discrepancy Indication Space | | | | | |
| 20. Facility Owner or Operator: Certification of receipt of waste materials covered by this manifest except as noted in Item 19. | | | | | |
| Printed/Typed Name <i>MARY BORDEN</i> | | Signature <i>Mary Borden</i> | | Month Day Year 8 17 94 | |

| NON-HAZARDOUS WASTE MANIFEST | | 1. Generator's US EPA ID No. NOT APPLICABLE | Manifest Document No. | 2. Page 1 of | Authorizaton No. 01216 |
|--|---------------------------------------|--|---|---|---------------------------|
| 3. Generator's Name and Mailing Address City of Emeryville Redevelopment Agency: 2200 Powell St.; 12th Floor Emeryville, CA 94608 | | | | | |
| 4. Generator's Phone (510) 596-4356 Attn: Ignacio Dayrit | | | | | |
| 5. Transporter 1 Company Name Northern Truck and Equipment | 6. US EPA ID Number NOT APPLICABLE | | | 3113 | |
| 7. Transporter 2 Company Name | 8. US EPA ID Number NOT APPLICABLE | | | | |
| 9. Designated Facility Name and Site Address B & J LANDFILL 6426 HAY ROAD VACAVILLE, CA 95687 | | 10. US EPA ID Number NOT APPLICABLE | | A. Transporter's Phone (510) 429-8920 B. Transporter's Phone C. Facility's Phone (707) 451-3276 | |
| 11. Waste Shipping Name and Description | | | 12. Containers | 13. Total Quantity | 14. Unit |
| a. Soil contaminated with petroleum hydrocarbons | | | No. 1 | Type T | Quantity 18 |
| b. | | | | | Unit Y |
| c. | | | | | |
| d. | | | | | |
| D. Additional Descriptions for Materials Listed Above Soil excavated from 40th Street UST Project 4000 San Pablo Ave., Emeryville, CA | | | E. Handling Codes for Wastes Listed Above 289 03 | | |
| 13. Special Handling Instructions and Additional Information | | | | | |
| 16. GENERATOR'S CERTIFICATION: I certify the materials described above on this manifest are not subject to federal regulations for reporting proper disposal of Hazardous Waste. | | | | | |
| Printed/Typed Name RONALD GERBER | | Signature <i>Ronald Gerber</i> | | Month Day Year 8 4 99 | |
| 17. Transporter 1 Acknowledgement of Receipt of Materials | | | | | |
| Printed/Typed Name JIM BROOKS | | Signature <i>Jim Brooks</i> | | Month Day Year 10 8 05 19 94 | |
| 18. Transporter 2 Acknowledgement of Receipt of Materials | | | | | |
| Printed/Typed Name | | Signature | | Month Day Year | |
| 19. Discrepancy Indication Space | | | | | |
| 20. Facility Owner or Operator: Certification of receipt of waste materials covered by this manifest except as noted in Item 19. | | | | | |
| Printed/Typed Name MARY BORDEN | | Signature <i>Mary Borden</i> | | Month Day Year 1 8 1 5 9 4 | |

| | | | | | |
|---|--|---|---------------------------------------|--------------------|---------------------------|
| NON-HAZARDOUS WASTE MANIFEST | | 1. Generator's US EPA ID No. NOT APPLICABLE | Manifest Document No. | 2. Page 1 of | Authorizaton No. 01216 |
| 3. Generator's Name and Mailing Address City of Emeryville Redevelopment Agency 2200 Powell St.; 12th Floor Emeryville CA 94608 | | R S | | | |
| 4. Generator's Phone (510) 596-4356 Attn: Ignacio Dayrit | | | | | |
| 5. Transporter 1 Company Name Northern Truck and Equipment | 6. US EPA ID Number NOT APPLICABLE | B 4 | | | |
| 7. Transporter 2 Company Name | 8. US EPA ID Number NOT APPLICABLE | | | | |
| 9. Designated Facility Name and Site Address B & J LANDFILL 6426 HAY ROAD VACAVILLE, CA 95687 | | 10. US EPA ID Number NOT APPLICABLE | A. Transporter's Phone (510) 429-8920 | | |
| | | | B. Transporter's Phone | | |
| | | | C. Facility's Phone (707) 451-3276 | | |
| 11. Waste Shipping Name and Description | | 12. Containers | | 13. Total Quantity | 14. Unit Wt/Vol |
| a. Soil contaminated with petroleum hydrocarbons | | No. | Type | | |
| | | 1 | T | 18 | Y |
| b. | | | | | |
| c. | | | | | |
| d. | | | | | |
| D. Additional Descriptions for Materials Listed Above Soil excavated from 40th Street UST Project 4000 San Pablo Ave., Emeryville, CA | | E. Handling Codes for Wastes Listed Above 03 | | | |
| 15. Special Handling Instructions and Additional Information | | | | | |
| 16. GENERATOR'S CERTIFICATION: I certify the materials described above on this manifest are not subject to federal regulation for reporting proper disposal of Hazardous Waste. | | | | | |
| Printed/Typed Name RONALD GERBER | | Signature <i>Ronald Gerber</i> | | Month 03 | Day 1 |
| 17. Transporter 1 Acknowledgement of Receipt of Materials | | Signature <i>[Signature]</i> | | Month 03 | Day 1 |
| Printed/Typed Name ARNOLD PADILLA | | Signature <i>[Signature]</i> | | Month 03 | Day 1 |
| 18. Transporter 2 Acknowledgement of Receipt of Materials | | Signature <i>[Signature]</i> | | Month 03 | Day 1 |
| Printed/Typed Name | | Signature | | Month | Day |
| 19. Discrepancy Indication Space | | | | | |
| 20. Facility Owner or Operator: Certification of receipt of waste materials covered by this manifest except as noted in Item 19. | | | | | |
| Printed/Typed Name MARY BORDEN | | Signature <i>Mary Borden</i> | | Month 03 | Day 1 |

**NON-HAZARDOUS
 WASTE MANIFEST**

1. Generator's US EPA ID No.
 NOT APPLICABLE

Manifest Document No.

2. Page 1 of

Authorizaton No.
 01216

3. Generator's Name and Mailing Address:
 City of Emeryville Redevelopment Agency
 2200 Powell St.; 12th Floor
 Emeryville, CA 94608

4. Generator's Phone (510) 596-4356 Attn: Ignacio Dayrit

5. Transporter 1 Company Name
 Northern Truck and Equipment

6. US EPA ID Number
 NOT APPLICABLE

7. Transporter 2 Company Name

8. US EPA ID Number
 NOT APPLICABLE

9. Designated Facility Name and Site Address

B & J LANDFILL
 6426 HAY ROAD
 VACAVILLE, CA 95687

10. US EPA ID Number
 NOT APPLICABLE

A. Transporter's Phone (510) 429-8920

B. Transporter's Phone

C. Facility's Phone
 (707) 451-3276

11. Waste Shipping Name and Description

a. Soil contaminated with petroleum hydrocarbons

| 12. Containers | | 13. Total Quantity | 14. Unit Wt/Vol |
|----------------|------|--------------------|-----------------|
| No. | Type | | |
| 1 | T | 18 | Y |
| | | | |
| | | | |
| | | | |
| | | | |

D. Additional Descriptions for Materials Listed Above

Soil excavated from 40th Street UST Project
 4000 San Pablo Ave., Emeryville, CA

E. Handling Codes for Wastes Listed Above

03

15. Special Handling Instructions and Additional Information

16. GENERATOR'S CERTIFICATION: I certify the materials described above on this manifest are not subject to federal regulations for reporting proper disposal of Hazardous Waste.

Printed/Typed Name
 Ignacio Dayrit

Signature

17. Transporter 1 Acknowledgement of Receipt of Materials

Printed/Typed Name
 MIKE DANIEL

Signature

Month Day Year
 10/8/15/94

18. Transporter 2 Acknowledgement of Receipt of Materials

Printed/Typed Name

Signature

Month Day Year
 10/8/15/94

19. Discrepancy Indication Space

(C) 100% HNU OVA reading

20. Facility Owner or Operator: Certification of receipt of waste materials covered by this manifest except as noted in Item 19.

Printed/Typed Name
 MARY BORDEN

Signature

Month Day Year
 10/8/15/94

NON-HAZARDOUS WASTE MANIFEST

1. Generator's US EPA ID No.
 NOT APPLICABLE

Manifest Document No.

2. Page 1 of

Authorizaton No.
 01216

3. Generator's Name and Mailing Address
 City of Emeryville Redevelopment Agency
 2200 Powell St.; 12th Floor
 Emeryville CA 94608

4. Generator's Phone (510) 596-4356 Attn: Ignacio Dayrit

5. Transporter 1 Company Name
 Northern Truck and Equipment

6. US EPA ID Number
 NOT APPLICABLE

3113 DH-1

7. Transporter 2 Company Name

8. US EPA ID Number
 NOT APPLICABLE

9. Designated Facility Name and Site Address

B & J LANDFILL
 6426 HAY ROAD
 VACAVILLE, CA 95687

10. US EPA ID Number

A. Transporter's Phone (510) 429-8920

B. Transporter's Phone

C. Facility's Phone
 (707) 451-3276

11. Waste Shipping Name and Description

a. Soil contaminated with petroleum hydrocarbons

| 12. Containers | | 13. Total Quantity | 14. Unit Wt/Vol |
|----------------|------|--------------------|-----------------|
| No. | Type | | |
| 1 | T | 18 | Y |
| | | | |
| | | | |
| | | | |
| | | | |

D. Additional Descriptions for Materials Listed Above

Soil excavated from 40th Street UST Project
 4000 San Pablo Ave., Emeryville, CA

E. Handling Codes for Wastes Listed Above

03

15. Special Handling Instructions and Additional Information

16. GENERATOR'S CERTIFICATION: I certify the materials described above on this manifest are not subject to federal regulations for reporting proper disposal of Hazardous Waste.

Printed/Typed Name
 Ignacio Dayrit

Signature

17. Transporter 1 Acknowledgement of Receipt of Materials

Printed/Typed Name
 Don Nickerson

Signature

Month Day Year
 8 15 94

18. Transporter 2 Acknowledgement of Receipt of Materials

Printed/Typed Name

Signature

Month Day Year
 8 15 94

19. Discrepancy Indication Space

C - PIV (0) OVA reading

Month Day Year

20. Facility Owner or Operator: Certification of receipt of waste materials covered by this manifest except as noted in item 19.

Printed/Typed Name
 Mary Borden

Signature
 Mary Borden

Month Day Year
 8 15 94

**NON-HAZARDOUS
 WASTE MANIFEST**

1. Generator's US EPA ID No.
 NOT APPLICABLE

Manifest Document No.

2. Page 1 of

Authorizaton No.
 01216

3. Generator's Name and Mailing Address
 City of Emeryville Redevelopment Agency
 2200 Powell St., 12th Floor
 Emeryville, CA 94608
 4. Generator's Phone (510) 596-4356 Attn: Ignacio Dayrit

RSI

5. Transporter 1 Company Name
 Northern Truck and Equipment

6. US EPA ID Number
 NOT APPLICABLE

3113 #6

7. Transporter 2 Company Name

8. US EPA ID Number
 NOT APPLICABLE

9. Designated Facility Name and Site Address
 B & J LANDFILL
 6426 HAY ROAD
 VACAVILLE, CA 95687

10. US EPA ID Number
 NOT APPLICABLE

A. Transporter's Phone (510) 429-8920

B. Transporter's Phone

C. Facility's Phone
 (707) 451-3276

11. Waste Shipping Name and Description

NOT APPLICABLE

a. Soil contaminated with petroleum hydrocarbons

| 12. Containers | | 13. Total Quantity | 14. Unit Wt./Vol |
|----------------|------|--------------------|------------------|
| No. | Type | | |
| 1 | T | 18 | Y |
| | | | |
| | | | |
| | | | |
| | | | |

D. Additional Descriptions for Materials Listed Above

Soil excavated from 40th Street UST Project
 4000 San Pablo Ave., Emeryville, CA

E. Handling Codes for Wastes Listed Above

03

15. Special Handling Instructions and Additional Information

C PID (a)

16. GENERATOR'S CERTIFICATION: I certify the materials described above on this manifest are not subject to federal regulations for reporting proper disposal of Hazardous Waste.

Printed/Typed Name
 Ignacio Dayrit

Signature

Month Day Year

1/15/94

17. Transporter 1 Acknowledgement of Receipt of Materials

Printed/Typed Name
 Leon Morris

Signature

Month Day Year

10/21/94

18. Transporter 2 Acknowledgement of Receipt of Materials

Printed/Typed Name

Signature

Month Day Year

19. Discrepancy Indication Space

20. Facility Owner or Operator: Certification of receipt of waste materials covered by this manifest except as noted in item 19.

Printed/Typed Name
 MARY BORDER

Signature

Month Day Year

1/15/94

**NON-HAZARDOUS
WASTE MANIFEST**

1. Generator's US EPA ID No.
NOT APPLICABLE

Manifest Document No.

2. Page 1 of

Authorizaton No.
01216

3. Generator's Name and Mailing Address:
City of Emeryville Redevelopment Agency
2200 Powell St., 12th Floor
Emeryville, CA 94608

4. Generator's Phone: (510) 596-4356 Attn: Ignacio Dayrit

5. Transporter 1 Company Name:
Northern Truck and Equipment

6. US EPA ID Number
NOT APPLICABLE

3113 24 1

7. Transporter 2 Company Name

8. US EPA ID Number
NOT APPLICABLE

9. Designated Facility Name and Site Address:

B & J LANDFILL
6426 HAY ROAD
VACAVILLE, CA 95687

10. US EPA ID Number
NOT APPLICABLE

A. Transporter's Phone (510) 429-8920

B. Transporter's Phone

C. Facility's Phone

(707) 451-3276

11. Waste Shipping Name and Description

a. Soil contaminated with petroleum hydrocarbons

| 12. Containers | | 13. Total Quantity | 14. Unit Wt/Vol |
|----------------|------|--------------------|-----------------|
| No. | Type | | |
| 1 | T | 18 | |
| | | | |
| | | | |
| | | | |
| | | | |

D. Additional Descriptions for Materials Listed Above

Soil excavated from 40th Street UST Project
4000 San Pablo Ave., Emeryville, CA

E. Handling Codes for Wastes Listed Above

03

15. Special Handling Instructions and Additional Information

C RID = (0)

16. GENERATOR'S CERTIFICATION: I certify the materials described above on this manifest are not subject to federal regulations for reporting proper disposal of Hazardous Waste.

Printed/Typed Name: Ignacio Dayrit

Signature:

Month Day Year: 1 8 1999

17. Transporter 1 Acknowledgement of Receipt of Materials

Printed/Typed Name:

Ronald J. Borden

Signature:

Month Day Year: 08 15 1999

18. Transporter 2 Acknowledgement of Receipt of Materials

Printed/Typed Name:

Signature:

Month Day Year:

19. Discrepancy Indication Space

20. Facility Owner or Operator: Certification of receipt of waste materials covered by this manifest except as noted in item 19.

Printed/Typed Name:

MARK BORDEN

Signature:

Month Day Year: 08 15 1999

**NON-HAZARDOUS
WASTE MANIFEST**

1. Generator's US EPA ID No.
NOT APPLICABLE

Manifest Document No.

2. Page 1 of

Authorizaton No.
01216 - C

3. Generator's Name and Mailing Address:
City of Emeryville Redevelopment Agency
2200 Powell St.; 12th Floor
Emeryville, CA 94608

4. Generator's Phone (510) 596-4356 Attn: Ignacio Dayrit

5. Transporter 1 Company Name
Northern Truck and Equipment

6. US EPA ID Number
NOT APPLICABLE

3113

DD 22

7. Transporter 2 Company Name

8. US EPA ID Number
NOT APPLICABLE

9. Designated Facility Name and Site Address

B & J LANDFILL
6426 HAY ROAD
VACAVILLE, CA 95687

10. US EPA ID Number

NOT APPLICABLE

A. Transporter's Phone (510) 429-8920

B. Transporter's Phone

C. Facility's Phone
(707) 451-3276

11. Waste Shipping Name and Description

a. Soil contaminated with petroleum hydrocarbons

| 12. Containers | | 13. Total Quantity | 14. Unit Wt/Vol |
|----------------|------|--------------------|-----------------|
| No. | Type | | |
| 1 | T | 18 | Y |
| . | . | . | . |
| . | . | . | . |
| . | . | . | . |
| . | . | . | . |

D. Additional Descriptions for Materials Listed Above

Soil excavated from 40th Street UST Project
4000 San Pablo Ave., Emeryville, CA

E. Handling Codes for Wastes Listed Above

03

15. Special Handling Instructions and Additional Information

PID = 100 ppm

16. GENERATOR'S CERTIFICATION: I certify the materials described above on this manifest are not subject to Federal regulations for reporting proper disposal of Hazardous Waste.

Printed/Typed Name
Ignacio Dayrit

Signature

Month Day Year

12 15 94

17. Transporter 1 Acknowledgement of Receipt of Materials

Printed/Typed Name
Jim F. Guler

Signature

Month Day Year

0 8 15 94

18. Transporter 2 Acknowledgement of Receipt of Materials

Printed/Typed Name

Signature

Month Day Year

19. Discrepancy Indication Space

20. Facility Owner or Operator: Certification of receipt of waste materials covered by this manifest except as noted in item 19.

Printed/Typed Name

MARY BORDER

Signature

Mary Border

Month Day Year

10/15/94

**NON-HAZARDOUS
 WASTE MANIFEST**

1. Generator's US EPA ID No.
 NOT APPLICABLE

Manifest Document No.

2. Page 1 of

Authorizaton No.
 01216 - C

3. Generator's Name and Mailing Address:
 City of Emeryville Redevelopment Agency
 2200 Powell St.; 12th Floor
 Emeryville, CA 94608
 4. Generator's Phone (510) 596-4356 Attn: Ignacio Dayrit

5. Transporter 1 Company Name
 Northern Truck and Equipment
 6. US EPA ID Number
 NOT APPLICABLE

3113

7. Transporter 2 Company Name
 8. US EPA ID Number
 NOT APPLICABLE

9. Designated Facility Name and Site Address:
 B & J LANDFILL
 6426 HAY ROAD
 VACAVILLE, CA 95687
 10. US EPA ID Number
 NOT APPLICABLE

A. Transporter's Phone (510) 429-8920

B. Transporter's Phone

C. Facility's Phone
 (707) 451-3276

11. Waste Shipping Name and Description

a. Soil contaminated with petroleum hydrocarbons

| 12. Containers | | 13. Total Quantity | 14. Unit Wt/Vol |
|----------------|------|--------------------|-----------------|
| No. | Type | | |
| 1 | T | 18 | Y |
| . | . | . | . |
| . | . | . | . |
| . | . | . | . |
| . | . | . | . |

D. Additional Descriptions for Materials Listed Above
 Soil excavated from 40th Street UST Project
 4000 San Pablo Ave., Emeryville, CA

E. Handling Codes for Wastes Listed Above
 03

15. Special Handling Instructions and Additional Information
 P (D) = 100 ppm

16. GENERATOR'S CERTIFICATION: I certify the materials described above on this manifest are not subject to Federal regulations for reporting proper disposal of Hazardous Waste.

Printed/Typed Name
 Ignacio Dayrit

Signature

Month Day Year
 18 15 94

17. Transporter 1 Acknowledgement of Receipt of Materials
 Printed/Typed Name
 Michael Taylor

Signature

Month Day Year
 08 15 94

18. Transporter 2 Acknowledgement of Receipt of Materials
 Printed/Typed Name

Signature

Month Day Year

19. Discrepancy Indication Space

20. Facility Owner or Operator: Certification of receipt of waste materials covered by this manifest except as noted in item 19.

Printed/Typed Name
 Jill A Fisher

Signature

Month Day Year
 10 21 94

**NON-HAZARDOUS
 WASTE MANIFEST**

1. Generator's US EPA ID No.
 NOT APPLICABLE

Manifest Document No. 1

2. Page 1 of

Authorizaton No.
 01216 - C

3. Generator's Name and Mailing Address:
 City of Emeryville Redevelopment Agency
 2200 Powell St.; 12th Floor
 Emeryville, CA 94608

4. Generator's Phone (510) 596-4356 Attn: Ignacio Dayrit

5. Transporter 1 Company Name
 Northern Truck and Equipment

6. US EPA ID Number
 NOT APPLICABLE

7. Transporter 2 Company Name

8. US EPA ID Number
 NOT APPLICABLE

9. Designated Facility Name and Site Address

B & J LANDFILL
 6426 HAY ROAD
 VACAVILLE, CA 95687

10. US EPA ID Number
 NOT APPLICABLE

A. Transporter's Phone (510) 429-8920

B. Transporter's Phone

C. Facility's Phone
 (707) 451-3276

11. Waste Shipping Name and Description

a. Soil contaminated with petroleum hydrocarbons

| 12. Containers | 13. Total Quantity | 14. Unit Wt/Vol |
|----------------|--------------------|-----------------|
| | | |
| 1 | 18 | Y |
| | | |
| | | |
| | | |
| | | |

D. Additional Descriptions for Materials Listed Above

Soil excavated from 40th Street UST Project
 4000 San Pablo Ave., Emeryville, CA

E. Handling Codes for Wastes Listed Above

03

15. Special Handling Instructions and Additional Information

P ID = 50 ppm

16. GENERATOR'S CERTIFICATION: I certify the materials described above on this manifest are not listed in federal regulations for reporting proper disposal of Hazardous Waste.

Printed/Typed Name
 Ignacio Dayrit

Signature

17. Transporter 1 Acknowledgement of Receipt of Materials

Printed/Typed Name

Signature

Month Day Year
 8 15 94

18. Transporter 2 Acknowledgement of Receipt of Materials

Printed/Typed Name

Signature

Month Day Year
 8 18 94

19. Discrepancy Indication Space

Month Day Year

20. Facility Owner or Operator: Certification of receipt of waste materials covered by this manifest except as noted in Item 19.

Printed/Typed Name

Signature

Month Day Year
 10 15 94

**NON-HAZARDOUS
WASTE MANIFEST**

1. Generator's US EPA ID No.
NOT APPLICABLE

Manifest Document No. 1

2. Page 1 of

Authorizaton No.
01216 - C

3. Generator's Name and Mailing Address:
City of Emeryville Redevelopment Agency
2200 Powell St.; 12th Floor
Emeryville, CA 94608

4. Generator's Phone: (510) 596-4356 Attn: Ignacio Dayrit

5. Transporter 1 Company Name
Northern Truck and Equipment

6. US EPA ID Number
NOT APPLICABLE

3113

430

7. Transporter 2 Company Name

8. US EPA ID Number
NOT APPLICABLE

9. Designated Facility Name and Site Address:

B & J LANDFILL
6426 HAY ROAD
VACAVILLE, CA 95687

10. US EPA ID Number
NOT APPLICABLE

A. Transporter's Phone (510) 429-8920

B. Transporter's Phone

C. Facility's Phone
(707) 451-3276

11. Waste Shipping Name and Description

a. Soil contaminated with petroleum hydrocarbons

12. Containers

| No. | Type |
|-----|------|
| 1 | T |

13. Total Quantity
18

14. Unit
Y

E. Handling Codes for Wastes Listed Above
03

D. Additional Descriptions for Materials Listed Above

Soil excavated from 40th Street UST Project
4000 San Pablo Ave., Emeryville, CA

15. Special Handling Instructions and Additional Information

P.D = 100 ppm

16. GENERATOR'S CERTIFICATION: I certify the materials described above on this manifest are not subject to federal regulations for reporting proper disposal of Hazardous Waste.

Printed/Typed Name
Ignacio Dayrit

Signature

Month Day Year
12 15 04

17. Transporter 1 Acknowledgement of Receipt of Materials

Printed/Typed Name

LEE NECKER

Signature

Month Day Year
12 25 04

18. Transporter 2 Acknowledgement of Receipt of Materials

Printed/Typed Name

Signature

Month Day Year

19. Discrepancy Indication Space

20. Facility Owner or Operator: Certification of receipt of waste materials covered by this manifest except as noted in Item 19.

Printed/Typed Name

MARY BORDEN

Signature

Mary Borden

Month Day Year
12 15 04

NON-HAZARDOUS WASTE MANIFEST

1. Generator's US EPA ID No.
NOT APPLICABLE

Manifest Document No.

2. Page 1 of

Authorization No.
01216 - C

3. Generator's Name and Mailing Address:
City of Emeryville Redevelopment Agency
2200 Powell St., 12th Floor
Emeryville, CA 94608

4. Generator's Phone (510) 596-4356 Attn: Ignacio Dayrit

5. Transporter 1 Company Name
Northern Truck and Equipment

6. US EPA ID Number
NOT APPLICABLE

3113

B15

7. Transporter 2 Company Name

8. US EPA ID Number
NOT APPLICABLE

9. Designated Facility Name and Site Address:
B & J LANDFILL
6426 HAY ROAD
VACAVILLE, CA 95687

10. US EPA ID Number

A. Transporter's Phone (510) 429-8920

B. Transporter's Phone

C. Facility's Phone
(707) 451-3276

11. Waste Shipping Name and Description
NOT APPLICABLE

| a. | 12. Containers | | 13. Total Quantity | 14. Unit Wt/Vol |
|---|----------------|------|--------------------|-----------------|
| | No. | Type | | |
| Soil contaminated with petroleum hydrocarbons | 1 | T | 18 | Y |
| b. | | | | |
| c. | | | | |
| d. | | | | |

D. Additional Descriptions for Materials Listed Above
Soil excavated from 40th Street UST Project
4000 San Pablo Ave., Emeryville, CA

E. Handling Codes for Wastes Listed Above
03

15. Special Handling Instructions and Additional Information
PID = 100 ppm

16. GENERATOR'S CERTIFICATION: I certify the materials described above on this manifest are not subject to Federal regulations for reporting proper disposal of Hazardous Waste.

Printed/Typed Name
Ignacio Dayrit

Signature

Month Day Year
8 15 94

17. Transporter 1 Acknowledgement of Receipt of Materials
Printed/Typed Name

Signature

Month Day Year
8 15 94

18. Transporter 2 Acknowledgement of Receipt of Materials
Printed/Typed Name

Signature

Month Day Year

19. Discrepancy Indication Space

20. Facility Owner or Operator: Certification of receipt of waste materials covered by this manifest except as noted in Item 19.

Printed/Typed Name
Mary Borden

Signature

Month Day Year
10 5 94

**NON-HAZARDOUS
 WASTE MANIFEST**

1. Generator's US EPA ID No. **NOT APPLICABLE** Manifest Document No. **1** 2. Page 1 of **1** Authorizaton No. **01216 - C**

3. Generator's Name and Mailing Address:
 City of Emeryville Redevelopment Agency
 2200 Powell St.; 12th Floor
 Emeryville CA 94608

4. Generator's Phone (510) 596-4356 Attn: Ignacio Dayrit

5. Transporter 1 Company Name
 Northern Truck and Equipment

6. US EPA ID Number
 NOT APPLICABLE.

7. Transporter 2 Company Name

8. US EPA ID Number
 NOT APPLICABLE.

9. Designated Facility Name and Site Address:
 B & J LANDFILL
 6426 HAY ROAD
 VACAVILLE, CA 95687

10. US EPA ID Number
 NOT APPLICABLE.

A. Transporter's Phone (510) 429-8920

B. Transporter's Phone

C. Facility's Phone
 (707) 451-3276

11. Waste Shipping Name and Description

NOT APPLICABLE.

a. Soil contaminated with petroleum hydrocarbons

| 12. Containers | | 13. Total Quantity | 14. Unit Wt/Vol |
|----------------|------|--------------------|-----------------|
| No. | Type | | |
| 1 | T | 18 | Y |
| | | | |
| | | | |
| | | | |
| | | | |

GENERATOR

b.
 c.
 d.

D. Additional Descriptions for Materials Listed Above
 Soil excavated from 40th Street UST Project
 4000 San Pablo Ave., Emeryville, CA

E. Handling Codes for Wastes Listed Above
 03

15. Special Handling Instructions and Additional Information

PID = 100 ppm

16. GENERATOR'S CERTIFICATION: I certify the materials described above on this manifest are not subject to federal regulations for reporting proper disposal of Hazardous Waste.
 Printed/Typed Name: Ignacio Dayrit Signature: *[Signature]*

17. Transporter 1 Acknowledgement of Receipt of Materials
 Printed/Typed Name: RALPH BRAKUS Signature: *[Signature]* Month Day Year: 18 | 15 | 94

18. Transporter 2 Acknowledgement of Receipt of Materials
 Printed/Typed Name: Signature: *[Signature]* Month Day Year: 18 | 15 | 94

19. Discrepancy Indication Space
 Month Day Year: . . .

20. Facility Owner or Operator: Certification of receipt of waste materials covered by this manifest except as noted in Item 19.
 Printed/Typed Name: MARY BORDEN Signature: *[Signature]* Month Day Year: 08 | 15 | 94

NON-HAZARDOUS WASTE MANIFEST

1. Generator's US EPA ID No.
 NOT APPLICABLE

Manifest Document No.

2. Page 1 of

Authorizaton No.
 01216 - C

3. Generator's Name and Mailing Address
 City of Emeryville Redevelopment Agency
 2200 Powell St., 12th Floor
 Emeryville, CA 94608

4. Generator's Phone (510) 596-4356 Attn: Ignacio Dayrit

5. Transporter 1 Company Name
 Northern Truck and Equipment

6. US EPA ID Number
 NOT APPLICABLE

3113

302

7. Transporter 2 Company Name

8. US EPA ID Number
 NOT APPLICABLE

9. Designated Facility Name and Site Address

B & J LANDFILL
 6426 HAY ROAD
 VACAVILLE, CA 95687

10. US EPA ID Number
 NOT APPLICABLE

A. Transporter's Phone (510) 429-8920

B. Transporter's Phone

C. Facility's Phone
 (707) 451-3276

11. Waste Shipping Name and Description

a. Soil contaminated with petroleum hydrocarbons

| 12. Containers | | 13. Total Quantity | 14. Unit Wt/Vol |
|----------------|------|--------------------|-----------------|
| No. | Type | | |
| 1 | T | 18 | Y |
| | | | |
| | | | |
| | | | |

D. Additional Descriptions for Materials Listed Above

Soil excavated from 40th Street UST Project
 4000 San Pablo Ave., Emeryville, CA

E. Handling Codes for Wastes Listed Above

03

15. Special Handling Instructions and Additional Information

PID = 100 ppm

16. GENERATOR'S CERTIFICATION: I certify the materials described above on this manifest are not subject to federal regulations for reporting proper disposal of Hazardous Waste.

Printed/Typed Name
 Ignacio Dayrit

Signature

17. Transporter 1 Acknowledgement of Receipt of Materials

Printed/Typed Name

Signature

Month Day Year
 18 15 94

18. Transporter 2 Acknowledgement of Receipt of Materials

Printed/Typed Name

Signature

Month Day Year
 18 15 94

19. Discrepancy Indication Space

Month Day Year

20. Facility Owner or Operator: Certification of receipt of waste materials covered by this manifest except as noted in Item 19.

Printed/Typed Name

MARY BORDEN

Signature

Mary Borden

Month Day Year
 08/15/94

ENVIRONMENTAL SERVICES, INC.
 6426 HAY ROAD • VACAVILLE, CA 95687
 (800) 794-2768

LOAD NO 120

**NON-HAZARDOUS
 WASTE MANIFEST**

1. Generator's US EPA ID No.
 NOT APPLICABLE

Manifest Document No.

2. Page 1 of

Authorizaton No.
 01216 - C

3. Generator's Name and Mailing Address:
 City of Emeryville Redevelopment Agency
 2200 Powell St.; 12th Floor
 Emeryville CA 94608

4. Generator's Phone (510) 596-4356 Attn: Ignacio Dayrit

5. Transporter 1 Company Name
 Northern Truck and Equipment

6. US EPA ID Number
 NOT APPLICABLE

3113

B14

7. Transporter 2 Company Name

8. US EPA ID Number
 NOT APPLICABLE

9. Designated Facility Name and Site Address

B & J LANDFILL
 6426 HAY ROAD
 VACAVILLE, CA 95687

10. US EPA ID Number

NOT APPLICABLE

A. Transporter's Phone (510) 429-8920

B. Transporter's Phone

C. Facility's Phone
 (707) 451-3276

11. Waste Shipping Name and Description

a. Soil contaminated with petroleum hydrocarbons

| 12. Containers | | 13. Total Quantity | 14. Unit Wt/Vol |
|----------------|------|--------------------|-----------------|
| No. | Type | | |
| 1 | T | 18 | Y |
| | | | |
| | | | |
| | | | |
| | | | |

D. Additional Descriptions for Materials Listed Above

Soil excavated from 40th Street UST Project
 4000 San Pablo Ave., Emeryville, CA

E. Handling Codes for Wastes Listed Above

03

15. Special Handling Instructions and Additional Information

PID = 106 ppm

16. GENERATOR'S CERTIFICATION: I certify the materials described above on this manifest are not subject to federal regulations for reporting proper disposal of Hazardous Waste.

Printed/Typed Name
 Ignacio Dayrit

Signature

17. Transporter 1 Acknowledgement of Receipt of Materials

Printed/Typed Name
 WRADY Hoit

Signature

Month Day Year
 8 | 15 | 94

18. Transporter 2 Acknowledgement of Receipt of Materials

Printed/Typed Name

Signature

Month Day Year
 8 | 15 | 94

19. Discrepancy Indication Space

Month Day Year

20. Facility Owner or Operator: Certification of receipt of waste materials covered by this manifest except as noted in item 19.

Printed/Typed Name
 MARY BORDEN

Signature

Month Day Year
 10 | 8 | 1994

ORIGINAL RETURN TO GENERATOR

| | | | | | |
|--|--|---|---|-------------------------------|-------------------------------|
| NON-HAZARDOUS WASTE MANIFEST | | 1. Generator's US EPA ID No. NOT APPLICABLE | Manifest Document No. | 2. Page 1 of | Authorizaton No. 01216 - C |
| 3. Generator's Name and Mailing Address City of Emeryville Redevelopment Agency 2200 Powell St.; 12th Floor Emeryville, CA 94608 | | 4. Generator's Phone (510) 596-4356 | Attn: Ignacio Dayrit | | |
| 5. Transporter 1 Company Name Northern Truck and Equipment | | 6. US EPA ID Number NOT APPLICABLE | 3113 12 | | |
| 7. Transporter 2 Company Name | | 8. US EPA ID Number NOT APPLICABLE | | | |
| 9. Designated Facility Name and Site Address B & J LANDFILL 6426 HAY ROAD VACAVILLE, CA 95687 | | 10. US EPA ID Number NOT APPLICABLE | A. Transporter's Phone (510) 429-8920 B. Transporter's Phone C. Facility's Phone (707) 451-3276 | | |
| 11. Waste Shipping Name and Description | | 12. Containers | | 13. Total Quantity | 14. Unit Wt/Vol |
| a. Soil contaminated with petroleum hydrocarbons | | No. | Type | 18 | Y |
| b. | | | | | |
| c. | | | | | |
| d. | | | | | |
| D. Additional Descriptions for Materials Listed Above Soil excavated from 40th Street UST Project 4000 San Pablo Ave., Emeryville, CA | | E. Handling Codes for Wastes Listed Above 03 | | | |
| 15. Special Handling Instructions and Additional Information P 10 = 100 ppm | | | | | |
| 16. GENERATOR'S CERTIFICATION: I certify the materials described above on this manifest are not subject to federal regulations for reporting proper disposal of Hazardous Waste. | | | | | |
| Printed/Typed Name Ignacio Dayrit | | Signature | | Month Day Year 8 15 94 | |
| 17. Transporter 1 Acknowledgement of Receipt of Materials Printed/Typed Name DEN JENSEN | | Signature | | Month Day Year 8 15 94 | |
| 18. Transporter 2 Acknowledgement of Receipt of Materials Printed/Typed Name | | Signature | | Month Day Year | |
| 19. Discrepancy Indication Space | | | | | |
| 20. Facility Owner or Operator: Certification of receipt of waste materials covered by this manifest except as noted in item 19. | | | | | |
| Printed/Typed Name Jill A. Fisher | | Signature | | Month Day Year 8 15 94 | |

**NON-HAZARDOUS
 WASTE MANIFEST**

1. Generator's US EPA ID No. **NOT APPLICABLE**

2. Page 1 of 1

Manifest Document No. 1

Authorization No. 01216 - C

3. Generator's Name and Mailing Address:
 City of Emeryville Redevelopment Agency
 2200 Powell St., 12th Floor
 Emeryville, CA 94608

4. Generator's Phone (510) 596-4356 Attn: Ignacio Dayrit

5. Transporter 1 Company Name
 Northern Truck and Equipment

6. US EPA ID Number
 NOT APPLICABLE

7. Transporter 2 Company Name

8. US EPA ID Number
 NOT APPLICABLE

9. Designated Facility Name and Site Address:
 B & J LANDFILL
 6426 HAY ROAD
 VACAVILLE, CA 95687

10. US EPA ID Number
 NOT APPLICABLE

RB-6

3113

A. Transporter's Phone (510) 429-8920

B. Transporter's Phone

C. Facility's Phone (707) 451-3276

11. Waste Shipping Name and Description
 a. Soil contaminated with petroleum hydrocarbons

| | 12. Containers | | 13. Total Quantity | 14. Unit Wt/Vol |
|----|----------------|------|--------------------|-----------------|
| | No. | Type | | |
| a. | 1 | T | 18 | Y |
| b. | | | | |
| c. | | | | |
| d. | | | | |

D. Additional Descriptions for Materials Listed Above
 Soil excavated from 40th Street UST Project
 4000 San Pablo Ave., Emeryville, CA

E. Handling Codes for Wastes Listed Above
 03

15. Special Handling Instructions and Additional Information
 PID = 50 ppm

16. GENERATOR'S CERTIFICATION: I certify the materials described above on this manifest are not subject to federal regulations for reporting proper disposal of Hazardous Waste.

Printed/Typed Name: Ignacio Dayrit

Signature: *[Signature]*

17. Transporter 1 Acknowledgement of Receipt of Materials

Printed/Typed Name: Mike Daulton

Signature: *[Signature]*

Month Day Year: 8/15/94

18. Transporter 2 Acknowledgement of Receipt of Materials

Printed/Typed Name:

Signature: *[Signature]*

Month Day Year: 8/15/94

19. Discrepancy Indication Space

Month Day Year:

20. Facility Owner or Operator: Certification of receipt of waste materials covered by this manifest except as noted in Item 19.

Printed/Typed Name: MARY BORDER

Signature: *[Signature]*

Month Day Year: 10/15/94

| NON-HAZARDOUS WASTE MANIFEST | | 1. Generator's US EPA ID No. NOT APPLICABLE | Manifest Document No. | 2. Page 1 of | Authorizaton No. 01216 - C |
|--|--|--|-----------------------|---|-------------------------------|
| 3. Generator's Name and Mailing Address: City of Emeryville Redevelopment Agency 2200 Powell St., 12th Floor Emeryville, CA 94608 | | 4. Generator's Phone (510) 596-4356 Attn: Ignacio Dayrit | | | |
| 5. Transporter 1 Company Name Northern Truck and Equipment | | 6. US EPA ID Number NOT APPLICABLE | | 3113 | |
| 7. Transporter 2 Company Name | | 8. US EPA ID Number NOT APPLICABLE | | | |
| 9. Designated Facility Name and Site Address: B & J LANDFILL 6426 HAY ROAD VACAVILLE, CA 95687 | | 10. US EPA ID Number NOT APPLICABLE | | A. Transporter's Phone (510) 429-8920 B. Transporter's Phone C. Facility's Phone (707) 451-3276 | |
| 11. Waste Shipping Name and Description | | | | | |
| a. Soil contaminated with petroleum hydrocarbons | | 12. Containers No. Type | | 13. Total Quantity | |
| | | 1 1 T | | 18 Y | |
| b. | | | | | |
| c. | | | | | |
| d. | | | | | |
| D. Additional Descriptions for Materials Listed Above Soil excavated from 40th Street UST Project 4000 San Pablo Ave., Emeryville, CA | | E. Handling Codes for Wastes Listed Above 03 | | | |
| 15. Special Handling Instructions and Additional Information PID = 100 ppm | | | | | |
| 16. GENERATOR'S CERTIFICATION: I certify the materials described above on this manifest are not subject to federal regulations for reporting proper disposal of Hazardous Waste. | | | | | |
| Printed/Typed Name Ignacio Dayrit | | Signature | | Month Day Year 8 15 94 | |
| 17. Transporter 1 Acknowledgement of Receipt of Materials Printed/Typed Name Don M. Rounds | | Signature | | Month Day Year 8 15 94 | |
| 18. Transporter 2 Acknowledgement of Receipt of Materials Printed/Typed Name | | Signature | | Month Day Year | |
| 19. Discrepancy Indication Space | | | | | |
| 20. Facility Owner or Operator: Certification of receipt of waste materials covered by this manifest except as noted in Item 19. | | | | | |
| Printed/Typed Name MARY BORDER | | Signature | | Month Day Year 08 15 94 | |

**NON-HAZARDOUS
 WASTE MANIFEST**

1. Generator's US EPA ID No.
 NOT APPLICABLE

Manifest Document No.

2. Page 1 of

Authorization No.
 01216 - C

3. Generator's Name and Mailing Address
 City of Emeryville Redevelopment Agency
 2200 Powell St., 12th Floor
 Emeryville, CA 94608

4. Generator's Phone (510) 596-4356 Attn: Ignacio Dayrit

5. Transporter 1 Company Name
 Northern Truck and Equipment

6. US EPA ID Number
 NOT APPLICABLE

7. Transporter 2 Company Name

8. US EPA ID Number
 NOT APPLICABLE

9. Designated Facility Name and Site Address

B & J LANDFILL
 6426 HAY ROAD
 VACAVILLE, CA 95687

10. US EPA ID Number
 NOT APPLICABLE

A. Transporter's Phone (510) 429-8920

B. Transporter's Phone

C. Facility's Phone
 (707) 451-3276

11. Waste Shipping Name and Description

| 12. Containers | 13. Total Quantity | 14. Unit Wt/Vol | | |
|--|--------------------|-----------------|-----|------|
| | | | No. | Type |
| a. Soil contaminated with petroleum hydrocarbons | 1 | T | 18 | T |
| b. | | | | |
| c. | | | | |
| d. | | | | |

D. Additional Descriptions for Materials Listed Above

Soil excavated from 40th Street UST Project
 4000 San Pablo Ave., Emeryville, CA

E. Handling Codes for Wastes Listed Above

03

15. Special Handling Instructions and Additional Information

PID = 135 ppm

16. GENERATOR'S CERTIFICATION: I certify the materials described above on this manifest are not subject to federal regulations for reporting proper disposal of Hazardous Waste.

Printed/Typed Name Ignacio Dayrit

Signature

Month Day Year
 8 15 94

17. Transporter 1 Acknowledgement of Receipt of Materials

Printed/Typed Name Leon MORRIS

Signature

Month Day Year
 8 15 94

18. Transporter 2 Acknowledgement of Receipt of Materials

Printed/Typed Name

Signature

Month Day Year

19. Discrepancy Indication Space

20. Facility Owner or Operator: Certification of receipt of waste materials covered by this manifest except as noted in Item 19.

Printed/Typed Name

Jill A Fisher

Signature

Jill A Fisher

Month Day Year
 8 15 94

NON-HAZARDOUS WASTE MANIFEST

1. Generator's US EPA ID No.
 NOT APPLICABLE

Manifest Document No.

2. Page 1 of

Authorizaton No.
 01216 - C

3. Generator's Name and Mailing Address:
 City of Emeryville Redevelopment Agency
 2200 Powell St., 12th Floor
 Emeryville, CA 94608

4. Generator's Phone (510) 596-4356 Attn: Ignacio Dayrit

5. Transporter 1 Company Name
 Northern Truck and Equipment

6. US EPA ID Number
 NOT APPLICABLE

7. Transporter 2 Company Name

8. US EPA ID Number
 NOT APPLICABLE

3113 D41

9. Designated Facility Name and Site Address:
 B & J LANDFILL
 6426 HAY ROAD
 VACAVILLE, CA 95687

10. US EPA ID Number
 NOT APPLICABLE

A. Transporter's Phone (510) 429-8920

B. Transporter's Phone

C. Facility's Phone
 (707) 451-3276

11. Waste Shipping Name and Description
 NOT APPLICABLE

| a. | 12. Containers | | 13. Total Quantity | 14. Unit Wt/Vol |
|---|----------------|------|--------------------|-----------------|
| | No. | Type | | |
| Soil contaminated with petroleum hydrocarbons | 1 | T | 18 | Y |
| b. | | | | |
| c. | | | | |
| d. | | | | |

D. Additional Descriptions for Materials Listed Above
 Soil excavated from 40th Street UST Project
 4000 San Pablo Ave., Emeryville, CA

E. Handling Codes for Wastes Listed Above
 03

15. Special Handling Instructions and Additional Information
 P.D. = 150 PPM

16. GENERATOR'S CERTIFICATION: I certify the materials described above on this manifest are in compliance with federal regulations for reporting proper disposal of Hazardous Waste.
 Printed/Typed Name: Ignacio Dayrit
 Signature: *[Signature]*

17. Transporter 1 Acknowledgement of Receipt of Materials
 Printed/Typed Name: *[Signature]*
 Signature: *[Signature]* Month Day Year: 8 15 94

18. Transporter 2 Acknowledgement of Receipt of Materials
 Printed/Typed Name: *[Signature]*
 Signature: *[Signature]* Month Day Year: 8 15 94

19. Discrepancy Indication Space
 Month Day Year

20. Facility Owner or Operator: Certification of receipt of waste materials covered by this manifest except as noted in item 19.
 Printed/Typed Name: MARY BORDEN
 Signature: *[Signature]* Month Day Year: 10 25 94

NON-HAZARDOUS WASTE MANIFEST

1. Generator's US EPA ID No.
NOT APPLICABLE

Manifest Document No

2. Page 1 of

Authorizaton No.
01216 - 2

3. Generator's Name and Mailing Address
City of Emeryville Redevelopment Agency
2200 Powell St., 12th Floor
Emeryville, CA 94608
4. Generator's Phone (510) 596-4356 Attn: Ignacio Dayrit

5. Transporter 1 Company Name
Northern Truck and Equipment
6. US EPA ID Number
NOT APPLICABLE

3113 26

7. Transporter 2 Company Name
8. US EPA ID Number
NOT APPLICABLE

9. Designated Facility Name and Site Address
B & J LANDFILL
6426 HAY ROAD
VACAVILLE, CA 95687
10. US EPA ID Number
NOT APPLICABLE

A. Transporter's Phone (510) 429-8920

B. Transporter's Phone

C. Facility's Phone
(707) 451-3276

11. Waste Shipping Name and Description
NOT APPLICABLE

| | 12. Containers | | 13. Total Quantity | 14. Unit Wt/Vol |
|--|----------------|------|--------------------|-----------------|
| | No. | Type | | |
| a. Soil contaminated with petroleum hydrocarbons | I | T | 18 | Y |
| b. | | | | |
| c. | | | | |
| d. | | | | |

D. Additional Descriptions for Materials Listed Above
Soil excavated from 40th Street UST Project
4000 San Pablo Ave., Emeryville, CA

E. Handling Codes for Wastes Listed Above
03

15. Special Handling Instructions and Additional Information
PID = 100 ppm

16. GENERATOR'S CERTIFICATION: I certify the materials described above on this manifest are not subject to federal regulations for reporting proper disposal of Hazardous Waste.
Printed/Typed Name: Ignacio Dayrit
Signature: *[Signature]*

17. Transporter 1 Acknowledgement of Receipt of Materials
Printed/Typed Name: *Kenneth P. Braddock*
Signature: *[Signature]*
Month Day Year: 8 | 15 | 94

18. Transporter 2 Acknowledgement of Receipt of Materials
Printed/Typed Name:
Signature:
Month Day Year: 8 | 15 | 94

19. Discrepancy Indication Space
Month Day Year:

20. Facility Owner or Operator: Certification of receipt of waste materials covered by this manifest except as noted in Item 19.

Printed/Typed Name: *MARIE BOBBER*
Signature: *[Signature]*
Month Day Year: 08 | 15 | 94

**NON-HAZARDOUS
 WASTE MANIFEST**

1. Generator's US EPA ID No.
 NOT APPLICABLE

Manifest Document No.

2. Page 1 of

Authorizaton No.
 01216-C

3. Generator's Name and Mailing Address:
 City of Emeryville Redevelopment Agency
 2200 Powell St.; 12th Floor
 Emeryville CA 94608

4. Generator's Phone (510) 596-4356 Attn: Ignacio Dayrit

5. Transporter 1 Company Name
 Northern Truck and Equipment

6. US EPA ID Number
 NOT APPLICABLE

7. Transporter 2 Company Name

8. US EPA ID Number
 NOT APPLICABLE

9. Designated Facility Name and Site Address:
 B & J LANDFILL
 6426 HAY ROAD
 VACAVILLE, CA 95687

10. US EPA ID Number

A. Transporter's Phone (510) 429-8920

B. Transporter's Phone

C. Facility's Phone
 (707) 451-3276

11. Waste Shipping Name and Description
 NOT APPLICABLE

| a. | 12. Containers | | 13. Total Quantity | 14. Unit Wt/Vol |
|---|----------------|------|--------------------|-----------------|
| | No. | Type | | |
| Soil contaminated with petroleum hydrocarbons | 1 | T | 18 | Y |
| b. | | | | |
| c. | | | | |
| d. | | | | |

D. Additional Descriptions for Materials Listed Above
 Soil excavated from 40th Street UST Project
 4000 San Pablo Ave., Emeryville, CA

E. Handling Codes for Wastes Listed Above

03

15. Special Handling Instructions and Additional Information
 P ID = 100 ppm

16. GENERATOR'S CERTIFICATION: I certify the materials described above on this manifest are not subject to federal regulations for reporting proper disposal of Hazardous Waste.
 Printed/Typed Name: Ignacio Dayrit
 Signature: *[Signature]*

17. Transporter 1 Acknowledgement of Receipt of Materials
 Printed/Typed Name: DANIEL S. PARKS
 Signature: *[Signature]* Month: 8 Day: 15 Year: 94

18. Transporter 2 Acknowledgement of Receipt of Materials
 Printed/Typed Name:
 Signature: *[Signature]* Month: 8 Day: 15 Year: 94

19. Discrepancy Indication Space
 Month: Day: Year:

20. Facility Owner or Operator: Certification of receipt of waste materials covered by this manifest except as noted in item 19.
 Printed/Typed Name: Jill A Fisher
 Signature: *[Signature]* Month: 8 Day: 15 Year: 94

**NON-HAZARDOUS
 WASTE MANIFEST**

1. Generator's US EPA ID No.
 NOT APPLICABLE

Manifest Document No.

2. Page 1 of

Authorizaton No.
 01216 - C

3. Generator's Name and Mailing Address:
 City of Emeryville Redevelopment Agency
 2200 Powell St., 12th Floor
 Emeryville, CA 94608

4. Generator's Phone (510) 596-4356 Attn: Ignacio Dayrit

5. Transporter 1 Company Name
 Northern Truck and Equipment

6. US EPA ID Number
 NOT APPLICABLE

7. Transporter 2 Company Name

8. US EPA ID Number
 NOT APPLICABLE

9. Designated Facility Name and Site Address

B & J LANDFILL
 6426 HAY ROAD
 VACAVILLE, CA 95687

10. US EPA ID Number

A. Transporter's Phone (510) 429-8920

B. Transporter's Phone

C. Facility's Phone
 (707) 451-3276

11. Waste Shipping Name and Description

NOT APPLICABLE

a. Soil contaminated with petroleum hydrocarbons

12. Containers

No. Type

13. Total Quantity

14. Unit Wt/Vol

1 1 T

18

Y

GENERATOR

D. Additional Descriptions for Materials Listed Above

Soil excavated from 40th Street UST Project
 4000 San Pablo Ave., Emeryville, CA

E. Handling Codes for Wastes Listed Above

03

15. Special Handling Instructions and Additional Information

PID = 100 ppm

16. GENERATOR'S CERTIFICATION: I certify the materials described above on this manifest are not subject to Federal regulations for reporting proper disposal of Hazardous Waste.

Printed/Typed Name Ignacio Dayrit

Signature

Month Day Year

8 15 94

17. Transporter 1 Acknowledgement of Receipt of Materials

Printed/Typed Name HUNTER PAUL D.

Signature

Month Day Year

8 15 94

18. Transporter 2 Acknowledgement of Receipt of Materials

Printed/Typed Name

Signature

Month Day Year

19. Discrepancy Indication Space

20. Facility Owner or Operator: Certification of receipt of waste materials covered by this manifest except as noted in Item 19.

Printed/Typed Name J. H. Fisher

Signature

Month Day Year

8 15 94

**NON-HAZARDOUS
 WASTE MANIFEST**

1. Generator's US EPA ID No.
 NOT APPLICABLE

Manifest Document No.

2. Page 1 of

Authorizaton No.
 01216-C

3. Generator's Name and Mailing Address:
 City of Emeryville Redevelopment Agency
 2200 Powell St., 12th Floor
 Emeryville, CA 94608

4. Generator's Phone (510) 596-4356 Attn: Ignacio Dayrit

5. Transporter 1 Company Name
 Northern Truck and Equipment

6. US EPA ID Number
 NOT APPLICABLE

~~3112~~ B-17

7. Transporter 2 Company Name

8. US EPA ID Number
 NOT APPLICABLE

9. Designated Facility Name and Site Address:
 B & J LANDFILL
 6426 HAY ROAD
 VACAVILLE, CA 95687

10. US EPA ID Number
 NOT APPLICABLE

A. Transporter's Phone (510) 429-8920

B. Transporter's Phone

C. Facility's Phone
 (707) 451-3276

11. Waste Shipping Name and Description

a. Soil contaminated with petroleum hydrocarbons

| 12. Containers | | 13. Total Quantity | 14. Unit Wt/Vol |
|----------------|------|--------------------|-----------------|
| No. | Type | | |
| 1 | T | 18 | Y |
| . | . | . | . |
| . | . | . | . |
| . | . | . | . |

b.

c.

d.

D. Additional Descriptions for Materials Listed Above
 Soil excavated from 40th Street UST Project
 4000 San Pablo Ave., Emeryville, CA

E. Handling Codes for Wastes Listed Above
 03

15. Special Handling Instructions and Additional Information
 PID = 150 ppm

16. GENERATOR'S CERTIFICATION: I certify the materials described above on this manifest are not subject to federal regulations for reporting proper disposal of Hazardous Waste.
 Printed/Typed Name: Ignacio Dayrit
 Signature:

17. Transporter 1 Acknowledgement of Receipt of Materials
 Printed/Typed Name: Michael Taylor
 Signature:
 Month Day Year: 8 | 15 | 94

18. Transporter 2 Acknowledgement of Receipt of Materials
 Printed/Typed Name:
 Signature:
 Month Day Year: 8 | 15 | 94

19. Discrepancy Indication Space

20. Facility Owner or Operator: Certification of receipt of waste materials covered by this manifest except as noted in item 19.
 Printed/Typed Name: Bill A. Fisher
 Signature:
 Month Day Year: 08 | 15 | 94

| NON-HAZARDOUS WASTE MANIFEST | | 1. Generator's US EPA ID No. NOT APPLICABLE | Manifest Document No. | 2. Page 1 of | Authorizaton No. 01216 - C |
|--|--|--|-----------------------|---|-------------------------------|
| 3. Generator's Name and Mailing Address: City of Emeryville Redevelopment Agency 2200 Powell St., 12th Floor Emeryville, CA 94608 | | 4. Generator's Phone (510) 596-4356 Attn: Ignacio Dayrit | | | |
| 5. Transporter 1 Company Name Northern Truck and Equipment | | 6. US EPA ID Number NOT APPLICABLE | | 3113 RB4 | |
| 7. Transporter 2 Company Name | | 8. US EPA ID Number NOT APPLICABLE | | | |
| 9. Designated Facility Name and Site Address B & J LANDFILL 6426 HAY ROAD VACAVILLE, CA 95687 | | 10. US EPA ID Number NOT APPLICABLE | | A. Transporter's Phone (510) 429-8920 B. Transporter's Phone C. Facility's Phone (707) 451-3276 | |
| 11. Waste Shipping Name and Description Soil contaminated with petroleum hydrocarbons | | 12. Containers | | 13. Total Quantity | |
| | | No. Type | | Unit Wt/Vol | |
| | | 1 1 T | | 18 Y | |
| b. | | | | | |
| c. | | | | | |
| d. | | | | | |
| D. Additional Descriptions for Materials Listed Above Soil excavated from 40th Street UST Project 4000 San Pablo Ave., Emeryville, CA | | E. Handling Codes for Wastes Listed Above 03 | | | |
| 15. Special Handling Instructions and Additional Information PID = 100 ppm | | | | | |
| 16. GENERATOR'S CERTIFICATION: I certify the materials described above on this manifest are not subject to federal regulations for reporting proper disposal of Hazardous Waste. | | | | | |
| Printed/Typed Name Ignacio Dayrit | | Signature | | Month Day Year 8 15 94 | |
| 17. Transporter 1 Acknowledgement of Receipt of Materials Printed/Typed Name D. CLARK | | Signature | | Month Day Year 8 15 94 | |
| 18. Transporter 2 Acknowledgement of Receipt of Materials Printed/Typed Name | | Signature | | Month Day Year | |
| 19. Discrepancy Indication Space | | | | | |
| 20. Facility Owner or Operator: Certification of receipt of waste materials covered by this manifest except as noted in Item 19. | | | | | |
| Printed/Typed Name MARTY BORDER | | Signature Marty Border | | Month Day Year 10 8 94 | |

| NON-HAZARDOUS WASTE MANIFEST | | 1. Generator's US EPA ID No. NOT APPLICABLE | Manifest Document No. | 2. Page 1 of | Authorizaton No. 01216- < |
|--|--|---|-----------------------|---------------------------------------|------------------------------|
| 3. Generator's Name and Mailing Address: City of Emeryville Redevelopment Agency 2200 Powell St., 12th Floor Emeryville CA 94608 | | | | | |
| 4. Generator's Phone (510) 596-4356 Attn: Ignacio Dayrit | | | | | |
| 5. Transporter 1 Company Name Northern Truck and Equipment | | 6. US EPA ID Number NOT APPLICABLE | | DD24 | |
| 7. Transporter 2 Company Name | | 8. US EPA ID Number NOT APPLICABLE | | | |
| 9. Designated Facility Name and Site Address B & J LANDFILL 6426 HAY ROAD VACAVILLE, CA 95687 | | 10. US EPA ID Number NOT APPLICABLE | | A. Transporter's Phone (510) 429-8920 | |
| | | | | B. Transporter's Phone | |
| | | | | C. Facility's Phone (707) 451-3276 | |
| 11. Waste Shipping Name and Description | | | | 12. Containers | |
| a. Soil contaminated with petroleum hydrocarbons | | | | No. | Type |
| | | | | 1 | T |
| | | | | | |
| | | | | | |
| | | | | | |
| | | | | | |
| 13. Total Quantity | | | | 14. Unit Wt/Vol | |
| 18 | | | | V | |
| b. | | | | | |
| c. | | | | | |
| d. | | | | | |
| D. Additional Descriptions for Materials Listed Above Soil excavated from 40th Street UST Project 4000 San Pablo Ave., Emeryville, CA | | E. Handling Codes for Wastes Listed Above 03 | | | |
| 15. Special Handling Instructions and Additional Information PID = 100 APM | | | | | |
| 16. GENERATOR'S CERTIFICATION: I certify the materials described above on this manifest are not subject to Federal regulations for reporting proper disposal of Hazardous Waste. | | | | | |
| Printed/Typed Name Ignacio Dayrit | | Signature | | Month Day Year 8 15 94 | |
| 17. Transporter 1 Acknowledgement of Receipt of Materials | | Signature | | Month Day Year 8 15 94 | |
| Printed/Typed Name ANDY CHRISTENSEN | | Signature | | Month Day Year | |
| 18. Transporter 2 Acknowledgement of Receipt of Materials | | Signature | | Month Day Year | |
| Printed/Typed Name | | Signature | | Month Day Year | |
| 19. Discrepancy Indication Space | | | | | |
| 20. Facility Owner or Operator: Certification of receipt of waste materials covered by this manifest except as noted in Item 19. | | | | | |
| Printed/Typed Name Will A. Fisher | | Signature | | Month Day Year 8 15 94 | |

| | | | | |
|-------------------------------------|---|-----------------------|--------------|-------------------------------|
| NON-HAZARDOUS WASTE MANIFEST | 1. Generator's US EPA ID No. NOT APPLICABLE | Manifest Document No. | 2. Page 1 of | Authorizaton No. 01216 - C |
|-------------------------------------|---|-----------------------|--------------|-------------------------------|

| | |
|--|--|
| 3. Generator's Name and Mailing Address City of Emeryville Redevelopment Agency 2200 Powell St.; 12th Floor Emeryville CA 94608 | 4. Generator's Phone (510) 596-4356 Attn: Ignacio Dayrit |
| 5. Transporter 1 Company Name Northern Truck and Equipment | 6. US EPA ID Number NOT APPLICABLE |
| 7. Transporter 2 Company Name | 8. US EPA ID Number NOT APPLICABLE |

| | |
|--|---|
| 9. Designated Facility Name and Site Address B & J LANDFILL 6426 HAY ROAD VACAVILLE, CA 95687 | 10. US EPA ID Number NOT APPLICABLE |
|--|---|

| | | | | |
|---|----------------|------|--------------------|-----------------|
| 11. Waste Shipping Name and Description a. Soil contaminated with petroleum hydrocarbons | 12. Containers | | 13. Total Quantity | 14. Unit Wt/Vol |
| | No. | Type | | |
| | 1 | T | 18 | Y |
| b. | | | | |
| c. | | | | |
| d. | | | | |

| | |
|---|---|
| D. Additional Descriptions for Materials Listed Above Soil excavated from 40th Street UST Project 4000 San Pablo Ave., Emeryville, CA | E. Handling Codes for Wastes Listed Above 03 |
|---|---|

15. Special Handling Instructions and Additional Information

PID = 100 ppm

16. GENERATOR'S CERTIFICATION: I certify the materials described above on this manifest are not/were not in Federal regulations for reporting proper disposal of Hazardous Wastes.

| | | |
|--------------------------------------|---------------|---------------------------|
| Printed/Typed Name Ignacio Dayrit | Signature | Month Day Year 8 15 94 |
|--------------------------------------|---------------|---------------------------|

| | | |
|---|---------------|---------------------------|
| 17. Transporter 1 Acknowledgement of Receipt of Materials Printed/Typed Name Northern Truck and Equipment | Signature | Month Day Year 8 15 94 |
|---|---------------|---------------------------|

| | | |
|---|-----------|----------------|
| 18. Transporter 2 Acknowledgement of Receipt of Materials Printed/Typed Name | Signature | Month Day Year |
|---|-----------|----------------|

19. Discrepancy Indication Space

20. Facility Owner or Operator: Certification of receipt of waste materials covered by this manifest except as noted in Item 19.

| | | |
|--------------------------------------|---------------|---------------------------|
| Printed/Typed Name Bill A. Fisher | Signature | Month Day Year 8 15 94 |
|--------------------------------------|---------------|---------------------------|

NON-HAZARDOUS WASTE MANIFEST

1. Generator's US EPA ID No.
NOT APPLICABLE

Manifest Document No.

2. Page 1 of

Authorizaton No.
01216-C

3. Generator's Name and Mailing Address:
City of Emeryville Redevelopment Agency
2200 Powell St., 12th Floor
Emeryville, CA 94608

4. Generator's Phone (510) 596-4356 Attn: Ignacio Dayrit

5. Transporter 1 Company Name
Northern Truck and Equipment

6. US EPA ID Number
NOT APPLICABLE

7. Transporter 2 Company Name

8. US EPA ID Number
NOT APPLICABLE

9. Designated Facility Name and Site Address

B & J LANDFILL
6426 HAY ROAD
VACAVILLE, CA 95687

10. US EPA ID Number

A. Transporter's Phone (510) 429-8920

B. Transporter's Phone

C. Facility's Phone
(707) 451-3276

11. Waste Shipping Name and Description

NOT APPLICABLE

a. Soil contaminated with petroleum hydrocarbons

| 12. Containers | | 13. Total Quantity | 14. Unit Wt/Vol |
|----------------|------|--------------------|-----------------|
| No. | Type | | |
| 1 | T | 18 | Y |
| | | | |
| | | | |
| | | | |
| | | | |

D. Additional Descriptions for Materials Listed Above

Soil excavated from 40th Street UST Project
4000 San Pablo Ave., Emeryville, CA

E. Handling Codes for Wastes Listed Above

03

15. Special Handling Instructions and Additional Information

PID = 100 ppm

16. GENERATOR'S CERTIFICATION: I certify the materials described above on this manifest are not subject to federal regulations for reporting proper disposal of Hazardous Waste.

Printed/Typed Name
Ignacio Dayrit

Signature

Month Day Year
8 15 94

17. Transporter 1 Acknowledgement of Receipt of Materials

Printed/Typed Name
Jim F. Green

Signature

Month Day Year
8 15 94

18. Transporter 2 Acknowledgement of Receipt of Materials

Printed/Typed Name

Signature

Month Day Year

19. Discrepancy Indication Space

20. Facility Owner or Operator: Certification of receipt of waste materials covered by this manifest except as noted in Item 19.

Printed/Typed Name

Will A. Fisher

Signature

Month Day Year
8 15 94

**NON-HAZARDOUS
 WASTE MANIFEST**

1. Generator's US EPA ID No.
 NOT APPLICABLE

Manifest Document No.

2. Page 1 of

Authorizaton No.
 01216-C

3. Generator's Name and Mailing Address:
 City of Emeryville Redevelopment Agency
 2200 Powell St.; 12th Floor
 Emeryville, CA 94608

4. Generator's Phone (510) 596-4356 Attn: Ignacio Dayrit

5. Transporter 1 Company Name
 Northern Truck and Equipment

6. US EPA ID Number
 NOT APPLICABLE

3113-1515

7. Transporter 2 Company Name

8. US EPA ID Number
 NOT APPLICABLE

9. Designated Facility Name and Site Address

B & J LANDFILL
 6426 HAY ROAD
 VACAVILLE, CA 95687

10. US EPA ID Number

A. Transporter's Phone (510) 429-8920

B. Transporter's Phone

C. Facility's Phone
 (707) 451-3276

11. Waste Shipping Name and Description

NOT APPLICABLE

a. Soil contaminated with petroleum hydrocarbons

| 12. Containers | | 13. Total Quantity | 14. Unit Wt/Vol |
|----------------|------|--------------------|-----------------|
| No. | Type | | |
| 1 | T | 18 | Y |
| . | . | . | . |
| . | . | . | . |
| . | . | . | . |
| . | . | . | . |

D. Additional Descriptions for Materials Listed Above

Soil excavated from 40th Street UST Project
 4000 San Pablo Ave., Emeryville, CA

E. Handling Codes for Wastes Listed Above

03

15. Special Handling Instructions and Additional Information

PID = 100 ppm

16. GENERATOR'S CERTIFICATION: I certify the materials described above on this manifest are not subject to federal regulations for reporting proper disposal of Hazardous Waste.

Printed/Typed Name
 Ignacio Dayrit

Signature

Month Day Year
 8 15 94

17. Transporter 1 Acknowledgement of Receipt of Materials

Printed/Typed Name
 Paul Punzav

Signature

Month Day Year
 8 15 94

18. Transporter 2 Acknowledgement of Receipt of Materials

Printed/Typed Name

Signature

Month Day Year

19. Discrepancy Indication Space

20. Facility Owner or Operator: Certification of receipt of waste materials covered by this manifest except as noted in Item 19.

Printed/Typed Name
 Jill A. Fisher

Signature

Month Day Year
 8 15 94

NON-HAZARDOUS WASTE MANIFEST

1. Generator's US EPA ID No. **NOT APPLICABLE**
 Manifest Document No. _____
 2. Page 1 of _____
 Authorizaton No. 01216 - C

3. Generator's Name and Mailing Address
 City of Emeryville Redevelopment Agency
 2200 Powell St.; 12th Floor
 Emeryville, CA 94608
 4. Generator's Phone (510) 596-4356 Attn: Ignacio Dayrit

5. Transporter 1 Company Name
 Northern Truck and Equipment
 6. US EPA ID Number **NOT APPLICABLE**

7. Transporter 2 Company Name
 8. US EPA ID Number **NOT APPLICABLE**

9. Designated Facility Name and Site Address
 B & J LANDFILL
 6426 HAY ROAD
 VACAVILLE, CA 95687
 10. US EPA ID Number **NOT APPLICABLE**

A. Transporter's Phone (510) 429-8920
 B. Transporter's Phone _____
 C. Facility's Phone (707) 451-3276

11. Waste Shipping Name and Description
NOT APPLICABLE

| a. | 12. Containers | | 13. Total Quantity | 14. Unit Wt/Vol |
|---|----------------|------|--------------------|-----------------|
| | No. | Type | | |
| Soil contaminated with petroleum hydrocarbons | 1 | T | 15 | Y |
| b. | | | | |
| c. | | | | |
| d. | | | | |

D. Additional Descriptions for Materials Listed Above
 Soil excavated from 40th Street UST Project
 4000 San Pablo Ave., Emeryville, CA

E. Handling Codes for Wastes Listed Above
 03

15. Special Handling Instructions and Additional Information
 P ID = 100ppm

16. GENERATOR'S CERTIFICATION: I certify the materials described above on this manifest are not subject to federal regulations for reporting proper disposal of Hazardous Waste.
 Printed/Typed Name: Ignacio Dayrit
 Signature: *[Signature]*

17. Transporter 1 Acknowledgement of Receipt of Materials
 Printed/Typed Name: BRADY Holt
 Signature: *[Signature]*
 Month Day Year: 8 15 94

18. Transporter 2 Acknowledgement of Receipt of Materials
 Printed/Typed Name: _____
 Signature: _____
 Month Day Year: 8 15 94

19. Discrepancy Indication Space
~~_____~~

20. Facility Owner or Operator: Certification of receipt of waste materials covered by this manifest except as noted in Item 19.
 Printed/Typed Name: JILL H. FISHER
 Signature: *[Signature]*
 Month Day Year: 8 15 94

NON-HAZARDOUS WASTE MANIFEST

1. Generator's US EPA ID No.
NOT APPLICABLE

Manifest Document No.

2. Page 1 of

Authorizaton No.
01216 - C

3. Generator's Name and Mailing Address:
City of Emeryville Redevelopment Agency
2200 Powell St., 12th Floor
Emeryville CA 94608

4. Generator's Phone (510) 596-4356 Attn: Ignacio Dayrit

5. Transporter 1 Company Name
Northern Truck and Equipment

6. US EPA ID Number
NOT APPLICABLE

302

7. Transporter 2 Company Name

8. US EPA ID Number
NOT APPLICABLE

9. Designated Facility Name and Site Address

B & J LANDFILL
6426 HAY ROAD
VACAVILLE, CA 95687

10. US EPA ID Number
NOT APPLICABLE

A. Transporter's Phone (510) 429-8920

B. Transporter's Phone

C. Facility's Phone
(707) 451-3276

11. Waste Shipping Name and Description

a. Soil contaminated with petroleum hydrocarbons

| 12. Containers | | 13. Total Quantity | 14. Unit Wt/Vol |
|----------------|------|--------------------|-----------------|
| No. | Type | | |
| 1 | T | 18 | Y |
| . | . | . | . |
| . | . | . | . |
| . | . | . | . |
| . | . | . | . |

D. Additional Descriptions for Materials Listed Above
Soil excavated from 40th Street UST Project
4000 San Pablo Ave., Emeryville, CA

E. Handling Codes for Wastes Listed Above

03

15. Special Handling Instructions and Additional Information

PID = 150 ppm

16. GENERATOR'S CERTIFICATION: I certify the materials described above on this manifest are not subject to federal regulations for reporting proper disposal of Hazardous Waste.

Printed/Typed Name
Ignacio Dayrit

Signature

Month Day Year
6/15/94

17. Transporter 1 Acknowledgement of Receipt of Materials

Printed/Typed Name
R. J. Seifert

Signature

Month Day Year
6/15/94

18. Transporter 2 Acknowledgement of Receipt of Materials

Printed/Typed Name

Signature

Month Day Year

19. Discrepancy Indication Space

20. Facility Owner or Operator: Certification of receipt of waste materials covered by this manifest except as noted in item 19

Printed/Typed Name

W. R. Fisher

Signature

Month Day Year
6/15/94

**NON-HAZARDOUS
 WASTE MANIFEST**

1. Generator's US EPA ID No.
 NOT APPLICABLE

Manifest Document No.

2. Page 1 of

Authorizaton No.
 01216 - C

3. Generator's Name and Mailing Address:
 City of Emeryville Redevelopment Agency
 2200 Powell St., 12th Floor
 Emeryville, CA 94608
 4. Generator's Phone (510) 596-4356 Attn: Ignacio Dayrit

5. Transporter 1 Company Name
 Northern Truck and Equipment

6. US EPA ID Number
 NOT APPLICABLE

3113

12

7. Transporter 2 Company Name

8. US EPA ID Number
 NOT APPLICABLE

9. Designated Facility Name and Site Address:
 B & J LANDFILL
 6426 HAY ROAD
 VACAVILLE, CA 95687

10. US EPA ID Number
 NOT APPLICABLE

A. Transporter's Phone (510) 429-8920

B. Transporter's Phone

C. Facility's Phone
 (707) 451-3276

11. Waste Shipping Name and Description

| a. | Soil contaminated with petroleum hydrocarbons | 12. Containers | | 13. Total Quantity | 14. Unit Wt/Vol |
|----|---|----------------|------|--------------------|-----------------|
| | | No. | Type | | |
| | | 1 | T | 18 | Y |
| b. | | | | | |
| c. | | | | | |
| d. | | | | | |

b. Additional Descriptions for Materials Listed Above
 Soil excavated from 40th Street UST Project
 4000 San Pablo Ave., Emeryville, CA

E. Handling Codes for Wastes Listed Above
 03

15. Special Handling Instructions and Additional Information
 PID = 100 ppm

16. GENERATOR'S CERTIFICATION: I certify the materials described above on this manifest are not subject to federal regulations for reporting proper disposal of Hazardous Waste.

Printed/Typed Name
 Ignacio Dayrit

Signature

Month Day Year
 8 15 94

17. Transporter 1 Acknowledgement of Receipt of Materials
 Printed/Typed Name
 DON JEPSEN

Signature

Month Day Year
 8 15 94

18. Transporter 2 Acknowledgement of Receipt of Materials
 Printed/Typed Name

Signature

Month Day Year

19. Discrepancy Indication Space

20. Facility Owner or Operator: Certification of receipt of waste materials covered by this manifest except as noted in Item 19.

Printed/Typed Name
 Mary Borden

Signature

Month Day Year
 10 8 94

NON-HAZARDOUS WASTE MANIFEST

1. Generator's US EPA ID No.
 NOT APPLICABLE

Manifest Document No.

2. Page 1 of

Authorizaton No.
 01216 - C

3. Generator's Name and Mailing Address:
 City of Emeryville Redevelopment Agency
 2200 Powell St., 12th Floor
 Emeryville, CA 94608

4. Generator's Phone (510) 596-4356 Attn: Ignacio Dayrit

5. Transporter 1 Company Name
 Northern Truck and Equipment

6. US EPA ID Number
 NOT APPLICABLE

7. Transporter 2 Company Name

8. US EPA ID Number
 NOT APPLICABLE

9. Designated Facility Name and Site Address:
 B & J LANDFILL
 6426 HAY ROAD
 VACAVILLE, CA 95687

10. US EPA ID Number
 NOT APPLICABLE

A. Transporter's Phone (510) 429-8920

B. Transporter's Phone

C. Facility's Phone
 (707) 451-3276

11. Waste Shipping Name and Description

a. Soil contaminated with petroleum hydrocarbons

| 12. Containers | | 13. Total Quantity | 14. Unit Wt/Vol |
|----------------|------|--------------------|-----------------|
| No. | Type | | |
| 1 | T | 18 | Y |
| | | | |
| | | | |
| | | | |
| | | | |

D. Additional Descriptions for Materials Listed Above
 Soil excavated from 40th Street UST Project
 4000 San Pablo Ave., Emeryville, CA

E. Handling Codes for Wastes Listed Above
 03

15. Special Handling Instructions and Additional Information

PID (100)

16. GENERATOR'S CERTIFICATION: I certify the materials described above on this manifest are not subject to federal regulations for reporting proper disposal of Hazardous Waste.

Printed/Typed Name Ignacio Dayrit

Signature

Month Day Year
 8 15 94

17. Transporter 1 Acknowledgement of Receipt of Materials

Printed/Typed Name

Signature

Month Day Year
 8 15 94

18. Transporter 2 Acknowledgement of Receipt of Materials

Printed/Typed Name

Signature

Month Day Year

19. Discrepancy Indication Space

20. Facility Owner or Operator: Certification of receipt of waste materials covered by this manifest except as noted in Item 19.

Printed/Typed Name Jill A Fisher

Signature

Month Day Year
 08 15 94

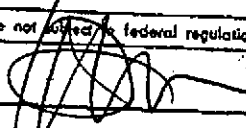
| NON-HAZARDOUS WASTE MANIFEST | | 1. Generator's US EPA ID No. NOT APPLICABLE | Manifest Document No. | 2. Page 1 of | Authorizaton No. 01216 - C |
|--|--|---|-----------------------|---------------------------------------|-------------------------------|
| 3. Generator's Name and Mailing Address City of Emeryville Redevelopment Agency 2200 Powell St., 12th Floor Emeryville, CA 94608 | | 6. US EPA ID Number NOT APPLICABLE | | 3113 | |
| 4. Generator's Phone (510) 596-4356 Attn: Ignacio Dayrit | | 8. US EPA ID Number NOT APPLICABLE | | | |
| 5. Transporter 1 Company Name Northern Truck and Equipment | | 10. US EPA ID Number NOT APPLICABLE | | A. Transporter's Phone (510) 429-8920 | |
| 7. Transporter 2 Company Name | | | | B. Transporter's Phone | |
| 9. Designated Facility Name and Site Address B & J LANDFILL 6426 HAY ROAD VACAVILLE, CA 95687 | | | | C. Facility's Phone (707) 451-3276 | |
| 11. Waste Shipping Name and Description | | | | | |
| a. Soil contaminated with petroleum hydrocarbons | | 12. Containers No. | Type | 13. Total Quantity | 14. Unit Wt/Vol |
| | | 1 | T | 18 | Y |
| b. | | | | | |
| c. | | | | | |
| d. | | | | | |
| D. Additional Descriptions for Materials Listed Above Soil excavated from 40th Street UST Project 4000 San Pablo Ave., Emeryville, CA | | E. Handling Codes for Wastes Listed Above 03 | | | |
| 15. Special Handling Instructions and Additional Information P.D. = (-150) | | | | | |
| 16. GENERATOR'S CERTIFICATION: I certify the materials described above on this manifest are not subject to federal regulations for reporting proper disposal of Hazardous Waste. | | | | | |
| Printed/Typed Name Ignacio Dayrit | | Signature  | | | |
| 17. Transporter 1 Acknowledgement of Receipt of Materials | | Month Day Year 8 15 94 | | | |
| Printed/Typed Name | | Signature | | | |
| 18. Transporter 2 Acknowledgement of Receipt of Materials | | Month Day Year 9 15 94 | | | |
| Printed/Typed Name | | Signature | | | |
| 19. Discrepancy Indication Space | | Month Day Year | | | |
| 20. Facility Owner or Operator: Certification of receipt of waste materials covered by this manifest except as noted in item 19. | | | | | |
| Printed/Typed Name MARY BORDEN | | Signature Mary Borden | | | |
| | | Month Day Year 8 15 94 | | | |

NON-HAZARDOUS WASTE MANIFEST

1. Generator's US EPA ID No.
NOT APPLICABLE

Manifest Document No.

2. Page 1 of

Authorizaton No.
01216

3. Generator's Name and Mailing Address
City of Emeryville Redevelopment Agency
2200 Powell St., 12th Floor
Emeryville CA 94608

4. Generator's Phone (510) 596-4356

Attn: Ignacio Dayrit

RB-6

5. Transporter 1 Company Name
Northern Truck and Equipment

6. US EPA ID Number
NOT APPLICABLE

3113

7. Transporter 2 Company Name

8. US EPA ID Number
NOT APPLICABLE

9. Designated Facility Name and Site Address

B & J LANDFILL
6426 HAY ROAD
VACAVILLE, CA 95687

10. US EPA ID Number

A. Transporter's Phone (510) 429-8920

B. Transporter's Phone

C. Facility's Phone
(707) 451-3276

11. Waste Shipping Name and Description

NOT APPLICABLE

a. Soil contaminated with petroleum hydrocarbons

| 12. Containers | | 13. Total Quantity | 14. Unit Wt/Vol |
|----------------|------|--------------------|-----------------|
| No. | Type | | |
| 1 | T | 18 | Y |
| | | | |
| | | | |
| | | | |

| | | | | |
|----|--|--|--|--|
| b. | | | | |
| c. | | | | |
| d. | | | | |

D. Additional Descriptions for Materials Listed Above

Soil excavated from 40th Street UST Project
4000 San Pablo Ave., Emeryville, CA

E. Handling Codes for Wastes Listed Above

03

15. Special Handling Instructions and Additional Information

P.D. = (.150)

16. GENERATOR'S CERTIFICATION: I certify the materials described above on this manifest are not subject to federal regulations for reporting proper disposal of Hazardous Waste.

Printed/Typed Name
Ignacio Dayrit

Signature

17. Transporter 1 Acknowledgement of Receipt of Materials

Printed/Typed Name

Signature

Month Day Year
8 | 15 | 94

18. Transporter 2 Acknowledgement of Receipt of Materials

Printed/Typed Name

Signature

Month Day Year
8 | 15 | 94

19. Discrepancy Indication Space

Month Day Year

20. Facility Owner or Operator: Certification of receipt of waste materials covered by this manifest except as noted in Item 19.

Printed/Typed Name

Signature

Month Day Year
10 | 15 | 94

NON-HAZARDOUS WASTE MANIFEST

1. Generator's US EPA ID No.
NOT APPLICABLE

Manifest Document No.

2. Page 1 of

Authorizaton No.
01216 - C

3. Generator's Name and Mailing Address:
City of Emeryville Redevelopment Agency
2200 Powell St., 12th Floor
Emeryville, CA 94608

4. Generator's Phone (510) 596-4356 Attn: Ignacio Dayrit

5. Transporter 1 Company Name
Northern Truck and Equipment

6. US EPA ID Number
NOT APPLICABLE

7. Transporter 2 Company Name

8. US EPA ID Number
NOT APPLICABLE

9. Designated Facility Name and Site Address

B & J LANDFILL
6426 HAY ROAD
VACAVILLE, CA 95687

10. US EPA ID Number
NOT APPLICABLE

A. Transporter's Phone (510) 429-8920

B. Transporter's Phone

C. Facility's Phone
(707) 451-3276

11. Waste Shipping Name and Description

a. Soil contaminated with petroleum hydrocarbons

| 12. Containers | | 13. Total Quantity | 14. Unit Wt/Vol |
|----------------|------|--------------------|-----------------|
| No. | Type | | |
| 1 | T | 18 | Y |
| . | . | . | . |
| . | . | . | . |
| . | . | . | . |
| . | . | . | . |

D. Additional Descriptions for Materials Listed Above

Soil excavated from 40th Street UST Project
4000 San Pablo Ave., Emeryville, CA

E. Handling Codes for Wastes Listed Above

03

15. Special Handling Instructions and Additional Information

PID # (100)

16. GENERATOR'S CERTIFICATION: I certify the materials described above on this manifest are not subject to federal regulations for reporting proper disposal of Hazardous Waste.

Printed/Typed Name
Ignacio Dayrit

Signature
[Signature]

Month Day Year
1 8 15 94

17. Transporter 1 Acknowledgement of Receipt of Materials

Printed/Typed Name
DON M. ROUNDS

Signature
[Signature]

Month Day Year
1 8 15 94

18. Transporter 2 Acknowledgement of Receipt of Materials

Printed/Typed Name
DON M. ROUNDS

Signature

Month Day Year

19. Discrepancy Indication Space

20. Facility Owner or Operator: Certification of receipt of waste materials covered by this manifest except as noted in Item 19.

Printed/Typed Name
Bill A. Fisher

Signature
[Signature]

Month Day Year
1 0 8 15 94

NON-HAZARDOUS WASTE MANIFEST

1. Generator's US EPA ID No.
NOT APPLICABLE

Manifest Document No.

2. Page 1 of

Authorizaton No.
01216 - C

3. Generator's Name and Mailing Address:
City of Emeryville Redevelopment Agency
2200 Powell St.; 12th Floor
Emeryville, CA 94608
4. Generator's Phone (510) 596-4356 Attn: Ignacio Dayrit

CHARLIE COLLINS #6

5. Transporter 1 Company Name
Northern Truck and Equipment

6. US EPA ID Number
NOT APPLICABLE

3113

7. Transporter 2 Company Name

8. US EPA ID Number
NOT APPLICABLE

9. Designated Facility Name and Site Address

B & J LANDFILL
6426 HAY ROAD
VACAVILLE, CA 95687

10. US EPA ID Number

A. Transporter's Phone (510) 429-8920

B. Transporter's Phone

C. Facility's Phone
(707) 451-3276

11. Waste Shipping Name and Description

NOT APPLICABLE

a. Soil contaminated with petroleum hydrocarbons

| 12. Containers | | 13. Total Quantity | 14. Unit Wt/Vol |
|----------------|------|--------------------|-----------------|
| No. | Type | | |
| 1 | T | 18 | Y |
| . | . | . | . |
| . | . | . | . |
| . | . | . | . |
| . | . | . | . |

b.
c.
d.

D. Additional Descriptions for Materials Listed Above

Soil excavated from 40th Street UST Project
4000 San Pablo Ave., Emeryville, CA

E. Handling Codes for Wastes Listed Above

03

15. Special Handling Instructions and Additional Information

P 10 (1000)

16. GENERATOR'S CERTIFICATION: I certify the materials described above on this manifest are not listed in federal regulations for reporting proper disposal of Hazardous Waste.

Printed/Typed Name
Ignacio Dayrit

Signature

17. Transporter 1 Acknowledgement of Receipt of Materials

Printed/Typed Name
Leon MORRIS

Signature

Month Day Year
8 15 94

18. Transporter 2 Acknowledgement of Receipt of Materials

Printed/Typed Name

Signature

Month Day Year
8 15 94

19. Discrepancy Indication Space

Month Day Year

20. Facility Owner or Operator: Certification of receipt of waste materials covered by this manifest except as noted in item 19

Printed/Typed Name

Signature

Month Day Year
8 15 94

ORIGINAL RETURN TO GENERATOR

**NON-HAZARDOUS
 WASTE MANIFEST**

1. Generator's US EPA ID No.
 NOT APPLICABLE

Manifest Document No.

2. Page 1 of

Authorizaton No.
 01216

3. Generator's Name and Mailing Address:
 City of Emeryville Redevelopment Agency
 2200 Powell St., 12th Floor
 Emeryville CA 94608

4. Generator's Phone (510) 596-4356 Attn: Ignacio Dayrit

5. Transporter 1 Company Name
 Northern Truck and Equipment

6. US EPA ID Number
 NOT APPLICABLE

3113

DA-1

7. Transporter 2 Company Name

8. US EPA ID Number
 NOT APPLICABLE

9. Designated Facility Name and Site Address

B & J LANDFILL
 6426 HAY ROAD
 VACAVILLE, CA 95687

10. US EPA ID Number

NOT APPLICABLE

A. Transporter's Phone (510) 429-8920

B. Transporter's Phone

C. Facility's Phone
 (707) 451-3276

11. Waste Shipping Name and Description

a. Soil contaminated with petroleum hydrocarbons

12. Containers
 No. Type

13. Total Quantity

14. Unit Wt/Vol

1

T

18

Y

D. Additional Descriptions for Materials Listed Above

Soil excavated from 40th Street UST Project
 4000 San Pablo Ave., Emeryville, CA

E. Handling Codes for Wastes Listed Above

03

15. Special Handling Instructions and Additional Information

PID = (100)

16. GENERATOR'S CERTIFICATION: I certify the materials described above on this manifest are not subject to federal regulations for reporting proper disposal of Hazardous Waste.

Printed/Typed Name
 Ignacio Dayrit

Signature

17. Transporter 1 Acknowledgement of Receipt of Materials

Printed/Typed Name
 DON HYCKMA

Signature

Month Day Year
 8 15 94

18. Transporter 2 Acknowledgement of Receipt of Materials

Printed/Typed Name

Signature

Month Day Year
 8 15 94

19. Discrepancy Indication Space

Month Day Year

20. Facility Owner or Operator: Certification of receipt of waste materials covered by this manifest except as noted in item 19.

Printed/Typed Name

Signature

Month Day Year
 8 15 94

**NON-HAZARDOUS
 WASTE MANIFEST**

1. Generator's US EPA ID No.
 NOT APPLICABLE

Manifest Document No.

2. Page 1 of

Authorizaton No.
 01216 - C

3. Generator's Name and Mailing Address:
 City of Emeryville Redevelopment Agency
 2200 Powell St., 12th Floor
 Emeryville, CA 94608

4. Generator's Phone (510) 596-4356 Attn: Ignacio Dayrit

5. Transporter 1 Company Name
 Northern Truck and Equipment

6. US EPA ID Number
 NOT APPLICABLE

3113

7. Transporter 2 Company Name

8. US EPA ID Number
 NOT APPLICABLE

9. Designated Facility Name and Site Address

B & J LANDFILL
 6426 HAY ROAD
 VACAVILLE, CA 95687

10. US EPA ID Number

NOT APPLICABLE

A. Transporter's Phone (510) 429-8920

B. Transporter's Phone

C. Facility's Phone
 (707) 451-3276

11. Waste Shipping Name and Description

a. Soil contaminated with petroleum hydrocarbons

| 12. Containers | | 13. Total Quantity | 14. Unit Wt/Vol |
|----------------|------|--------------------|-----------------|
| No. | Type | | |
| 1 | T | 18 | Y |
| . | . | . | . |
| . | . | . | . |
| . | . | . | . |
| . | . | . | . |

D. Additional Descriptions for Materials Listed Above

Soil excavated from 40th Street UST Project
 4000 San Pablo Ave., Emeryville, CA

E. Handling Codes for Wastes Listed Above

03

15. Special Handling Instructions and Additional Information

PID = (100)

16. GENERATOR'S CERTIFICATION: I certify the materials described above on this manifest are not listed in Federal regulations for reporting proper disposal of Hazardous Waste.

Printed/Typed Name Ignacio Dayrit

Signature

Month Day Year
 18 15 94

17. Transporter 1 Acknowledgement of Receipt of Materials

Printed/Typed Name DANIEL J PARKS

Signature

Month Day Year
 9 15 94

18. Transporter 2 Acknowledgement of Receipt of Materials

Printed/Typed Name

Signature

Month Day Year

19. Discrepancy Indication Space

20. Facility Owner or Operator: Certification of receipt of waste materials covered by this manifest except as noted in Item 19.

Printed/Typed Name Jill H Fisher

Signature

Month Day Year
 8 15 94

**NON-HAZARDOUS
 WASTE MANIFEST**

1. Generator's US EPA ID No.
 NOT APPLICABLE

Manifest Document No.

2. Page 1 of

Authorizaton No.
 01216 - DD

3. Generator's Name and Mailing Address:
 City of Emeryville Redevelopment Agency
 2200 Powell St.; 12th Floor
 Emeryville, CA 94608

4. Generator's Phone (510) 596-4356 Attn: Ignacio Dayrit

5. Transporter 1 Company Name
 Northern Truck and Equipment

6. US EPA ID Number
 NOT APPLICABLE

7. Transporter 2 Company Name

8. US EPA ID Number
 NOT APPLICABLE

9. Designated Facility Name and Site Address

B & J LANDFILL
 6426 HAY ROAD
 VACAVILLE, CA 95687

10. US EPA ID Number
 NOT APPLICABLE

A. Transporter's Phone (510) 429-8920

B. Transporter's Phone

C. Facility's Phone
 (707) 451-3276

11. Waste Shipping Name and Description

a. Soil contaminated with petroleum hydrocarbons

| 12. Containers | | 13. Total Quantity | 14. Unit Wt/Vol |
|----------------|------|--------------------|-----------------|
| No. | Type | | |
| 1 | T | 18 | Y |
| | | | |
| | | | |
| | | | |
| | | | |

D. Additional Descriptions for Materials Listed Above

Soil excavated from 40th Street UST Project
 4000 San Pablo Ave., Emeryville, CA

E. Handling Codes for Wastes Listed Above

03

15. Special Handling Instructions and Additional Information

PID =

16. GENERATOR'S CERTIFICATION: I certify the materials described above on this manifest are not subject to federal regulations for reporting proper disposal of Hazardous Waste.

Printed/Typed Name Ignacio Dayrit

Signature

17. Transporter 1 Acknowledgement of Receipt of Materials

Printed/Typed Name ARNOLD BAONIA

Signature

Month Day Year
 8 15 94

18. Transporter 2 Acknowledgement of Receipt of Materials

Printed/Typed Name

Signature

Month Day Year
 8 25 94

19. Discrepancy Indication Space

Month Day Year

20. Facility Owner or Operator: Certification of receipt of waste materials covered by this manifest except as noted in Item 19.

Printed/Typed Name

Jill A Fisher

Signature

Jill A Fisher

Month Day Year
 8 23 94

**NON-HAZARDOUS
 WASTE MANIFEST**

1. Generator's US EPA ID No.
 NOT APPLICABLE

Manifest Document No.

2. Page 1 of

Authorizaton No.
 01216 - D

3. Generator's Name and Mailing Address:
 City of Emeryville Redevelopment Agency
 2200 Powell St.; 12th Floor
 Emeryville, CA 94608

4. Generator's Phone (510) 596-4356 Attn: Ignacio Dayrit

5. Transporter 1 Company Name
 Northern Truck and Equipment

6. US EPA ID Number
 NOT APPLICABLE

3113

7. Transporter 2 Company Name

8. US EPA ID Number
 NOT APPLICABLE

9. Designated Facility Name and Site Address:

B & J LANDFILL
 6426 HAY ROAD
 VACAVILLE, CA 95687

10. US EPA ID Number

A. Transporter's Phone (510) 429-8920

B. Transporter's Phone

C. Facility's Phone
 (707) 451-3276

11. Waste Shipping Name and Description

NOT APPLICABLE

a. Soil contaminated with petroleum hydrocarbons

| 12. Containers | | 13. Total Quantity | 14. Unit Wt/Vol |
|----------------|------|--------------------|-----------------|
| No. | Type | | |
| 1 | T | 18 | Y |
| | | | |
| | | | |
| | | | |
| | | | |

D. Additional Descriptions for Materials Listed Above

Soil excavated from 40th Street UST Project
 4000 San Pablo Ave., Emeryville, CA

E. Handling Codes for Wastes Listed Above

03

15. Special Handling Instructions and Additional Information

PID =

16. GENERATOR'S CERTIFICATION: I certify the materials described above on this manifest are not subject to federal regulations for reporting proper disposal of Hazardous Waste.

Printed/Typed Name
 Ignacio Dayrit

Signature

Month Day Year
 8 15 94

17. Transporter 1 Acknowledgement of Receipt of Materials

Printed/Typed Name
 Chuck Oliver

Signature

Month Day Year
 8 15 94

18. Transporter 2 Acknowledgement of Receipt of Materials

Printed/Typed Name

Signature

Month Day Year

19. Discrepancy Indication Space

20. Facility Owner or Operator: Certification of receipt of waste materials covered by this manifest except as noted in Item 19.

Printed/Typed Name
 Sandra Hall

Signature

Month Day Year
 8 15 94

NON-HAZARDOUS WASTE MANIFEST

1. Generator's US EPA ID No.
 NOT APPLICABLE

Manifest Document No. 1

2. Page 1 of 1

Authorization No. 01216 - **AD**

3. Generator's Name and Mailing Address:
 City of Emeryville Redevelopment Agency
 2200 Powell St., 12th Floor
 Emeryville, CA 94608

4. Generator's Phone: 510 596-4356 Attn: Ignacio Dayrit

5. Transporter 1 Company Name:
 Northern Truck and Equipment

6. US EPA ID Number
 NOT APPLICABLE

7. Transporter 2 Company Name

8. US EPA ID Number
 NOT APPLICABLE

9. Designated Facility Name and Site Address

B & J LANDFILL
 6426 HAY ROAD
 VACAVILLE, CA 95687

10. US EPA ID Number
 NOT APPLICABLE

A. Transporter's Phone (510) 429-8920

B. Transporter's Phone

C. Facility's Phone
 (707) 451-3276

11. Waste Shipping Name and Description

a. Soil contaminated with petroleum hydrocarbons

| 12. Containers | | 13. Total Quantity | 14. Unit Wt/Vol |
|----------------|------|--------------------|-----------------|
| No. | Type | | |
| 1 | T | 18 | Y |
| | | | |
| | | | |
| | | | |
| | | | |

D. Additional Descriptions for Materials Listed Above

Soil excavated from 40th Street UST Project
 4000 San Pablo Ave., Emeryville, CA

E. Handling Codes for Wastes Listed Above

03

15. Special Handling Instructions and Additional Information

PID =

16. GENERATOR'S CERTIFICATION: I certify the materials described above on this manifest are not subject to federal regulations for reporting proper disposal of Hazardous Waste.

Printed/Typed Name: Ignacio Dayrit

Signature: *[Signature]*

Month Day Year: 8 15 94

17. Transporter 1 Acknowledgement of Receipt of Materials

Printed/Typed Name: STEVE ANDERSEN

Signature: *[Signature]*

Month Day Year: 8 25 94

18. Transporter 2 Acknowledgement of Receipt of Materials

Printed/Typed Name:

Signature:

Month Day Year:

19. Discrepancy Indication Space

20. Facility Owner or Operator: Certification of receipt of waste materials covered by this manifest except as noted in Item 19.



Printed/Typed Name: W.A. Fisher

Signature: *[Signature]*

Month Day Year: 8 15 94

ENVIRONMENTAL SERVICES, INC.
 8426 HAY ROAD VACAVILLE, CA 95687
 (800) 784-9768

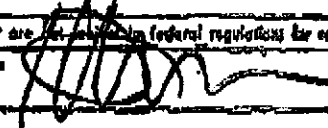
LOAD NO 148

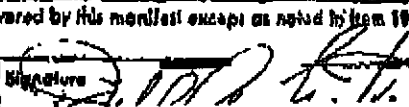
| | | | | | |
|---|--|---|---|----------------------------------|---|
| NON-HAZARDOUS WASTE MANIFEST | | 1. Generator's US EPA ID No. NOT APPLICABLE | Manifest Document No. | 2. Page 1 of | Authorization No. 01215 - 2 D |
| 3. Generator's Name and Mailing Address City of Emeryville Redevelopment Agency 2200 Powell St., 12th Floor Emeryville, CA 94508 | | 4. Generator's Phone (510) 596-4356 Attn: Ignacio Davrit | | | |
| 5. Transporter 1 Company Name Northern Truck and Equipment | | 6. US EPA ID Number NOT APPLICABLE | 3113 | | |
| 7. Transporter 2 Company Name | | 8. US EPA ID Number NOT APPLICABLE | | | |
| 9. Designated Facility Name and Site Address B & J LANDFILL 8426 HAY ROAD VACAVILLE, CA 95687 | | 10. US EPA ID Number NOT APPLICABLE | A. Transporter's Phone (510) 429-8980 B. Transporter's Phone C. Facility's Phone (707) 451-9276 | | |
| 11. Waste Shipping Name and Description a. Soil contaminated with petroleum hydrocarbons | | 12. Container No. | 13. Total Quantity | 14. Unit Vol | |
| | | 1 | 10 | Y | |
| D. Additional Descriptions for Materials Listed Above Soil excavated from 40th Street USF Project 4000 San Pablo Ave., Emeryville, CA | | E. Handling Codes for Wastes Listed Above 03 | | | |
| 15. Special Handling Instructions and Additional Information PID = | | | | | |
| 16. GENERATOR'S CERTIFICATION: I certify the material described above on this manifest are not subject to federal regulations for reporting proper disposal of Hazardous Waste. | | | | | |
| Printed/Typed Name Ignacio Davrit | | Signature  | | Month Day Year 8 15 94 | |
| 17. Transporter 1 Acknowledgement of Receipt of Materials Printed/Typed Name WALTER PAUL D. | | Signature  | | Month Day Year 8 15 94 | |
| 18. Transporter 2 Acknowledgement of Receipt of Materials Printed/Typed Name | | Signature | | Month Day Year | |
| 19. Discrepancy Indication Space | | | | | |
| 20. Facility Owner or Operator Certification of receipt of waste materials covered by this manifest except as noted by item 19. | | | | | |
| Printed/Typed Name Will A Fisher | | Signature  | | Month Day Year | |

NON-HAZARDOUS WASTE MANIFEST

1. Generator's US EPA ID No.
NOT APPLICABLE

Manifest Document No.

2. Page 1 of

Authorizaton No.
01216 - *80*

3. Generator's Name and Mailing Address
City of Emeryville Redevelopment Agency
2200 Powell St.; 12th Floor
Emeryville CA 94608

4. Generator's Phone (510) 596-4356 Attn: Ignacio Dayrit

5. Transporter 1 Company Name
Northern Truck and Equipment

6. US EPA ID Number
NOT APPLICABLE

23 *23*

7. Transporter 2 Company Name

8. US EPA ID Number
NOT APPLICABLE

9. Designated Facility Name and Site Address

B & J LANDFILL
6426 HAY ROAD
VACAVILLE, CA 95687

10. US EPA ID Number

A. Transporter's Phone (510) 429-8920

B. Transporter's Phone

C. Facility's Phone
(707) 451-3276

11. Waste Shipping Name and Description

NOT APPLICABLE

a. Soil contaminated with petroleum hydrocarbons

| 12. Containers | | 13. Total Quantity | 14. Unit Wt/Vol |
|----------------|------|--------------------|-----------------|
| No. | Type | | |
| 1 | T | 18 | Y |
| | | | |
| | | | |
| | | | |

b.
c.
d.

D. Additional Descriptions for Materials Listed Above
Soil excavated from 40th Street UST Project
4000 San Pablo Ave., Emeryville, CA

E. Handling Codes for Wastes Listed Above
03

15. Special Handling Instructions and Additional Information

PID =

16. GENERATOR'S CERTIFICATION: I certify the materials described above on this manifest are not subject to federal regulations for reporting proper disposal of Hazardous Waste.

Printed/Typed Name
Ignacio Dayrit

Signature
[Signature]

17. Transporter 1 Acknowledgement of Receipt of Materials

Printed/Typed Name
Donna Rounds

Signature
[Signature]

Month Day Year
8 15 94

18. Transporter 2 Acknowledgement of Receipt of Materials

Printed/Typed Name

Signature

Month Day Year
8 15 94

19. Discrepancy Indication Space

Month Day Year

20. Facility Owner or Operator: Certification of receipt of waste materials covered by this manifest except as noted in item 19

Printed/Typed Name
W.A. Fisher

Signature
[Signature]

Month Day Year
8 15 94

NON-HAZARDOUS WASTE MANIFEST

1. Generator's US EPA ID No.
NOT APPLICABLE

Manifest Document No.

2. Page 1 of

Authorizaton No.
01216 - *11*

3. Generator's Name and Mailing Address:
City of Emeryville Redevelopment Agency
2200 Powell St.; 12th Floor
Emeryville, CA 94608

4. Generator's Phone (510) 596-4356 Attn: Ignacio Dayrit

5. Transporter 1 Company Name
Northern Truck and Equipment

6. US EPA ID Number
NOT APPLICABLE

7. Transporter 2 Company Name

8. US EPA ID Number
NOT APPLICABLE

~~3118~~ 20

9. Designated Facility Name and Site Address

B & J LANDFILL
6426 HAY ROAD
VACAVILLE, CA 95687

10. US EPA ID Number

A. Transporter's Phone (510) 429-8920

B. Transporter's Phone

C. Facility's Phone
(707) 451-3276

11. Waste Shipping Name and Description

NOT APPLICABLE

a. Soil contaminated with petroleum hydrocarbons

| 12. Containers | | 13. Total Quantity | 14. Unit Wt/Vol |
|----------------|------|--------------------|-----------------|
| No. | Type | | |
| 1 | T | 18 | Y |
| | | | |
| | | | |
| | | | |
| | | | |

b.

c.

d.

D. Additional Descriptions for Materials Listed Above

Soil excavated from 40th Street UST Project
4000 San Pablo Ave., Emeryville, CA

E. Handling Codes for Wastes Listed Above

03

15. Special Handling Instructions and Additional Information

P 11 =

16. GENERATOR'S CERTIFICATION: I certify the materials described above on this manifest are not subject to federal regulations for reporting proper disposal of Hazardous Waste.

Printed/Typed Name
Ignacio Dayrit

Signature

Month Day Year
0 15 99

17. Transporter 1 Acknowledgement of Receipt of Materials

Printed/Typed Name
David H. Marcus

Signature

Month Day Year
8 25 99

18. Transporter 2 Acknowledgement of Receipt of Materials

Printed/Typed Name

Signature

Month Day Year

19. Discrepancy Indication Space

20. Facility Owner or Operator: Certification of receipt of waste materials covered by this manifest except as noted in item 19.

Printed/Typed Name

Signature

Month Day Year
08 31 99

**NON-HAZARDOUS
WASTE MANIFEST**

1. Generator's US EPA ID No.
NOT APPLICABLE

Manifest Document No.

2. Page 1 of

Authorizaton No.
01216 - RD

3. Generator's Name and Mailing Address
City of Emeryville Redevelopment Agency
2200 Powell St.; 12th Floor
Emeryville, CA 94608

4. Generator's Phone (510) 596-4356 Attn: Ignacio Dayrit

5. Transporter 1 Company Name
Northern Truck and Equipment

6. US EPA ID Number
NOT APPLICABLE

3113

7. Transporter 2 Company Name

8. US EPA ID Number
NOT APPLICABLE

9. Designated Facility Name and Site Address

B & J LANDFILL
6426 HAY ROAD
VACAVILLE, CA 95687

10. US EPA ID Number
NOT APPLICABLE

A. Transporter's Phone (510) 429-8920

B. Transporter's Phone

C. Facility's Phone
(707) 451-3276

11. Waste Shipping Name and Description

a. Soil contaminated with petroleum hydrocarbons

12. Containers

No.

Type

13. Total Quantity

14. Unit Wt/Vol

1

T

18

Y

D. Additional Descriptions for Materials Listed Above

Soil excavated from 40th Street UST Project
4000 San Pablo Ave., Emeryville, CA

E. Handling Codes for Wastes Listed Above

03

15. Special Handling Instructions and Additional Information

PID =

16. GENERATOR'S CERTIFICATION: I certify the materials described above on this manifest are in compliance with federal regulations for reporting proper disposal of Hazardous Waste.

Printed/Typed Name
Ignacio Dayrit

Signature

Month Day Year
8 15 99

17. Transporter 1 Acknowledgement of Receipt of Materials

Printed/Typed Name

Bob Cross

Signature

Month Day Year
8 15 99

18. Transporter 2 Acknowledgement of Receipt of Materials

Printed/Typed Name

Signature

Month Day Year

19. Discrepancy Indication Space

20. Facility Owner or Operator: Certification of receipt of waste materials covered by this manifest except as noted in item 19.

Printed/Typed Name

Sandra Hall

Signature

Sandra Hall

Month Day Year
08 15 99

NON-HAZARDOUS WASTE MANIFEST

1. Generator's US EPA ID No.
NOT APPLICABLE

Manifest Document No.

2. Page 1 of

Authorizaton No.
01216 *K P*

3. Generator's Name and Mailing Address:
City of Emeryville Redevelopment Agency
2200 Powell St.; 12th Floor
Emeryville, CA 94608

4. Generator's Phone (510) 596-4356 Attn: Ignacio Dayrit

5. Transporter 1 Company Name
Northern Truck and Equipment

6. US EPA ID Number
NOT APPLICABLE

3113 77

7. Transporter 2 Company Name

8. US EPA ID Number
NOT APPLICABLE

9. Designated Facility Name and Site Address

B & J LANDFILL
6426 HAY ROAD
VACAVILLE, CA 95687

10. US EPA ID Number

A. Transporter's Phone (510) 429-8920

B. Transporter's Phone

C. Facility's Phone
(707) 451-3276

11. Waste Shipping Name and Description

a. Soil contaminated with petroleum hydrocarbons

| 12. Containers | | 13. Total Quantity | 14. Unit Wt/Vol |
|----------------|------|--------------------|-----------------|
| No. | Type | | |
| 1 | T | 18 | Y |
| | | | |
| | | | |
| | | | |
| | | | |
| | | | |
| | | | |

D. Additional Descriptions for Materials Listed Above

Soil excavated from 40th Street UST Project
4000 San Pablo Ave., Emeryville, CA

E. Handling Codes for Wastes Listed Above

03

15. Special Handling Instructions and Additional Information

PID =

16. GENERATOR'S CERTIFICATION: I certify the materials described above on this manifest are not subject to Federal regulations for reporting proper disposal of Hazardous Waste.

Printed/Typed Name
Ignacio Dayrit

Signature *[Signature]*

17. Transporter 1 Acknowledgement of Receipt of Materials

Printed/Typed Name
[Signature]

Signature

Month Day Year
8 23 94

18. Transporter 2 Acknowledgement of Receipt of Materials

Printed/Typed Name
[Signature]

Signature

Month Day Year
8 23 94

19. Discrepancy Indication Space

Month Day Year
8 23 94

20. Facility Owner or Operator: Certification of receipt of waste materials covered by this manifest except as noted in Item 19.

Printed/Typed Name
V. A. Fisher

Signature

[Signature]

Month Day Year
8 23 94

NON-HAZARDOUS WASTE MANIFEST

1. Generator's US EPA ID No.
NOT APPLICABLE

Manifest Document No. 1

2. Page 1 of

Authorization No.
01216 - *RD*

3. Generator's Name and Mailing Address:
City of Emeryville Redevelopment Agency
2200 Powell St.; 12th Floor
Emeryville, CA 94608

4. Generator's Phone: 510 596-4356 Attn: Ignacio Dayrit

5. Transporter 1 Company Name:
Northern Truck and Equipment

6. US EPA ID Number
NOT APPLICABLE

7. Transporter 2 Company Name

8. US EPA ID Number
NOT APPLICABLE

9. Designated Facility Name and Site Address:
B & J LANDFILL
6426 HAY ROAD
VACAVILLE, CA 95687

10. US EPA ID Number
NOT APPLICABLE

A. Transporter's Phone (510) 429-8920

B. Transporter's Phone

C. Facility's Phone
(707) 451-3276

11. Waste Shipping Name and Description
NOT APPLICABLE

a. Soil contaminated with petroleum hydrocarbons

| 12. Containers | | 13. Total Quantity | 14. Unit Wt./Vol |
|----------------|------|--------------------|------------------|
| No. | Type | | |
| 1 | T | 18 | Y |
| | | | |
| | | | |
| | | | |
| | | | |

b.

c.

d.

D. Additional Descriptions for Materials Listed Above
Soil excavated from 40th Street UST Project
4000 San Pablo Ave., Emeryville, CA

E. Handling Codes for Wastes Listed Above
03

15. Special handling instructions and Additional Information

PID =

16. GENERATOR'S CERTIFICATION: I certify the materials described above on this manifest are not subject to Federal regulations for reporting proper disposal of Hazardous Waste.

Printed/Typed Name: Ignacio Dayrit

Signature: *[Signature]*

Month Day Year: 8/15/94

17. Transporter 1 Acknowledgement of Receipt of Materials

Printed/Typed Name: Ruben Magana

Signature: *[Signature]*

Month Day Year: 8/28/94

18. Transporter 2 Acknowledgement of Receipt of Materials

Printed/Typed Name:

Signature:

Month Day Year:

19. Discrepancy Indication Space

20. Facility Owner or Operator: Certification of receipt of waste materials covered by this manifest except as noted in Item 19.

Printed/Typed Name: Will H Fisher

Signature: *[Signature]*

Month Day Year: 8/25/94

**NON-HAZARDOUS
WASTE MANIFEST**

1. Generator's US EPA ID No.
NOT APPLICABLE

Manifest Document No.

2. Page 1 of

Authorization No.
01216 - 20

3. Generator's Name and Mailing Address
City of Emeryville Redevelopment Agency
2200 Powell St., 12th Floor
Emeryville, CA 94608

4. Generator's Phone (510) 596-4356 Attn: Ignacio Dayrit

5. Transporter 1 Company Name
Northern Truck and Equipment

6. US EPA ID Number
NOT APPLICABLE

7. Transporter 2 Company Name

8. US EPA ID Number
NOT APPLICABLE

9. Designated Facility Name and Site Address

B & J LANDFILL
6426 HAY ROAD
VACAVILLE, CA 95687

10. US EPA ID Number
NOT APPLICABLE

A. Transporter's Phone (510) 429-8920

B. Transporter's Phone

C. Facility's Phone
(707) 451-3276

11. Waste Shipping Name and Description

NOT APPLICABLE

a. Soil contaminated with petroleum hydrocarbons

| 12. Containers | | 13. Total Quantity | 14. Unit Wt/Vol |
|----------------|------|--------------------|-----------------|
| No. | Type | | |
| 1 | T | 18 | Y |
| | | | |
| | | | |
| | | | |
| | | | |
| | | | |

D. Additional Descriptions for Materials Listed Above

Soil excavated from 40th Street UST Project
4000 San Pablo Ave., Emeryville, CA

E. Handling Codes for Wastes Listed Above

03

15. Special Handling Instructions and Additional Information

PID =

16. GENERATOR'S CERTIFICATION: I certify the materials described above on this manifest are not subject to federal regulations for reporting proper disposal of Hazardous Waste.

Printed/Typed Name
Ignacio Dayrit

Signature

17. Transporter 1 Acknowledgement of Receipt of Materials

Printed/Typed Name
DAN ROSE

Signature
Dan Rose

Month Day Year
8 15 94

18. Transporter 2 Acknowledgement of Receipt of Materials

Printed/Typed Name

Signature

Month Day Year
8 23 94

19. Discrepancy Indication Space

Month Day Year

20. Facility Owner or Operator: Certification of receipt of waste materials covered by this manifest except as noted in Item 19

Printed/Typed Name

Pill A Fisher

Signature

Month Day Year
8 23 94

**NON-HAZARDOUS
 WASTE MANIFEST**

1. Generator's US EPA ID No.
 NOT APPLICABLE

Manifest Document No.

2. Page 1 of

Authorizator No.
 01216 - *KD*

3. Generator's Name and Mailing Address
 City of Emeryville Redevelopment Agency
 2200 Powell St.; 12th Floor
 Emeryville, CA 94608

4. Generator's Phone (510) 596-4356 Attn: Ignacio Dayrit

5. Transporter 1 Company Name
 Northern Truck and Equipment

6. US EPA ID Number
 NOT APPLICABLE

7. Transporter 2 Company Name

8. US EPA ID Number
 NOT APPLICABLE

9. Designated Facility Name and Site Address

B & J LANDFILL
 6426 HAY ROAD
 VACAVILLE, CA 95687

10. US EPA ID Number

A. Transporter's Phone (510) 429-8920

B. Transporter's Phone

C. Facility's Phone
 (707) 451-3276

11. Waste Shipping Name and Description

a. Soil contaminated with petroleum hydrocarbons

| 12. Containers | 13. Total Quantity | 14. Unit Wt/Vol |
|----------------|--------------------|-----------------|
| | | |
| 1 | 18 | Y |
| | | |
| | | |
| | | |
| | | |

D. Additional Descriptions for Materials Listed Above

Soil excavated from 40th Street UST Project
 4000 San Pablo Ave., Emeryville, CA

E. Handling Codes for Wastes Listed Above

03

15. Special Handling Instructions and Additional Information

01D =

16. GENERATOR'S CERTIFICATION: I certify the materials described above on this manifest are not subject to Federal regulations for reporting proper disposal of Hazardous Waste.

Printed/Typed Name Ignacio Dayrit

Signature *[Signature]*

Month Day Year
 8 15 94

17. Transporter 1 Acknowledgement of Receipt of Materials

Printed/Typed Name ARNOLD PADILLA

Signature *[Signature]*

Month Day Year
 8 20 94

18. Transporter 2 Acknowledgement of Receipt of Materials

Printed/Typed Name

Signature

Month Day Year

19. Discrepancy Indication Space

20. Facility Owner or Operator: Certification of receipt of waste materials covered by this manifest except as noted in Item 19.

Printed/Typed Name

William Fisher

Signature *[Signature]*

Month Day Year
 8 22 94

NON-HAZARDOUS WASTE MANIFEST

1. Generator's US EPA ID No.
 NOT APPLICABLE

Manifest Document No.

2. Page 1 of

Authorizaton No.
 01216 - R D

TR # 464

Generator's Name and Mailing Address:
 City of Emeryville Redevelopment Agency
 2200 Powell St., 12th Floor
 Emeryville, CA 94608

4. Generator's Phone (510) 596-4356 Attn: Ignacio Dayrit

5. Transporter 1 Company Name
 Northern Truck and Equipment

6. US EPA ID Number
 NOT APPLICABLE

7. Transporter 2 Company Name

8. US EPA ID Number
 NOT APPLICABLE

9. Designated Facility Name and Site Address
 B & J LANDFILL
 6426 HAY ROAD
 VACAVILLE, CA 95687

10. US EPA ID Number

A. Transporter's Phone (510) 429-8920

B. Transporter's Phone

C. Facility's Phone
 (707) 451-3276

11. Waste Shipping Name and Description
 NOT APPLICABLE

| | 12. Containers | | 13. Total Quantity | 14. Unit Wt/Vol |
|--|----------------|------|--------------------|-----------------|
| | No. | Type | | |
| a. Soil contaminated with petroleum hydrocarbons | 1 | T | 18 | Y |
| b. | | | | |
| c. | | | | |
| d. | | | | |

D. Additional Descriptions for Materials Listed Above
 Soil excavated from 40th Street UST Project
 4000 San Pablo Ave., Emeryville, CA

E. Handling Codes for Wastes Listed Above
 03

15. Special Handling Instructions and Additional Information
 PID =

16. GENERATOR'S CERTIFICATION: I certify the materials described above on this manifest are not subject to federal regulations for reporting proper disposal of Hazardous Waste.
 Printed/Typed Name: Ignacio Dayrit
 Signature: *[Signature]*

17. Transporter 1 Acknowledgement of Receipt of Materials
 Printed/Typed Name: *Chuck Chivon*
 Signature: *[Signature]*
 Month: 8 Day: 15 Year: 94

18. Transporter 2 Acknowledgement of Receipt of Materials
 Printed/Typed Name:
 Signature:
 Month: 8 Day: 28 Year: 94

Discrepancy Indication Space
 Month: Day: Year:

20. Facility Owner or Operator: Certification of receipt of waste materials covered by this manifest except as noted in Item 19.
 Printed/Typed Name: *William Fisher*
 Signature: *[Signature]*
 Month: 8 Day: 31 Year: 94

NON-HAZARDOUS WASTE MANIFEST

1. Generator's US EPA ID No.
 NOT APPLICABLE

Manifest Document No.

2. Page 1 of

Authorizaton No.
 01216 - ~~A~~ D

TR 41 29

3. Generator's Name and Mailing Address:
 City of Emeryville Redevelopment Agency
 2200 Powell St.; 12th Floor
 Emeryville, CA 94608

4. Generator's Phone (510) 596-4356 Attn: Ignacio Dayrit

5. Transporter 1 Company Name
 Northern Truck and Equipment

6. US EPA ID Number
 NOT APPLICABLE

7. Transporter 2 Company Name

8. US EPA ID Number
 NOT APPLICABLE

9. Designated Facility Name and Site Address

B & J LANDFILL
 6426 HAY ROAD
 VACAVILLE, CA 95687

10. US EPA ID Number
 NOT APPLICABLE

A. Transporter's Phone (510) 429-8920

B. Transporter's Phone

C. Facility's Phone
 (707) 451-3276

11. Waste Shipping Name and Description

NOT APPLICABLE

a. Soil contaminated with petroleum hydrocarbons

| 12. Containers | | 13. Total Quantity | 14. Unit Wt/Vol |
|----------------|------|--------------------|-----------------|
| No. | Type | | |
| 1 | T | 18 | Y |
| | | | |
| | | | |
| | | | |
| | | | |

D. Additional Descriptions for Materials Listed Above

Soil excavated from 40th Street UST Project
 4000 San Pablo Ave., Emeryville, CA

E. Handling Codes for Wastes Listed Above

03

15. Special Handling Instructions and Additional Information

PID =

16. GENERATOR'S CERTIFICATION: I certify the materials described above on this manifest are not subject to federal regulations for reporting proper disposal of Hazardous Waste.

Printed/Typed Name Ignacio Dayrit

Signature

17. Transporter 1 Acknowledgement of Receipt of Materials

Printed/Typed Name Steve Anderson

Signature

Month Day Year
 8 15 94

18. Transporter 2 Acknowledgement of Receipt of Materials

Printed/Typed Name

Signature

Month Day Year
 8 15 94

19. Discrepancy Indication Space

Month Day Year

20. Facility Owner or Operator: Certification of receipt of waste materials covered by this manifest except as noted in item 19.

Printed/Typed Name

Bill A Fisher

Signature

Bill A Fisher

Month Day Year
 8 15 94

**NON-HAZARDOUS
 WASTE MANIFEST**

1. Generator's US EPA ID No.
 NOT APPLICABLE

Manifest Document No.

2. Page 1 of

Authorizaton No.
 01216 - 0

3. Generator's Name and Mailing Address:
 City of Emeryville Redevelopment Agency
 2200 Powell St.; 12th Floor
 Emeryville, CA 94608

4. Generator's Phone (510) 596-4356 Attn: Ignacio Dayrit

5. Transporter 1 Company Name
 Northern Truck and Equipment

6. US EPA ID Number
 NOT APPLICABLE

7. Transporter 2 Company Name

8. US EPA ID Number
 NOT APPLICABLE

9. Designated Facility Name and Site Address

B & J LANDFILL
 6426 HAY ROAD
 VACAVILLE, CA 95687

10. US EPA ID Number

A. Transporter's Phone (510) 429-8920

B. Transporter's Phone

C. Facility's Phone
 (707) 451-3276

11. Waste Shipping Name and Description

a. Soil contaminated with petroleum hydrocarbons

| 12. Containers | | 13. Total Quantity | 14. Unit Wt/Vol |
|----------------|------|--------------------|-----------------|
| No. | Type | | |
| 1 | T | 18 | Y |
| | | | |
| | | | |
| | | | |
| | | | |
| | | | |

D. Additional Descriptions for Materials Listed Above
 Soil excavated from 40th Street UST Project
 4000 San Pablo Ave., Emeryville, CA

E. Handling Codes for Wastes Listed Above

03

15. Special Handling Instructions and Additional Information

16. GENERATOR'S CERTIFICATION: I certify the materials described above on this manifest are in accordance with federal regulations for reporting proper disposal of Hazardous Waste.
 Printed/Typed Name: Ignacio Dayrit
 Signature: *[Signature]*

17. Transporter 1 Acknowledgement of Receipt of Materials
 Printed/Typed Name: Barb Cross
 Signature: *[Signature]*
 Month Day Year: 10/8/23/94

18. Transporter 2 Acknowledgement of Receipt of Materials
 Printed/Typed Name:
 Signature: *[Signature]*
 Month Day Year: 10/8/23/94

19. Discrepancy Indication Space
 Month Day Year:

20. Facility Owner or Operator: Certification of receipt of waste materials covered by this manifest except as noted in Item 19.
 Printed/Typed Name: Bill A Fisher
 Signature: *[Signature]*
 Month Day Year: 10/12/94

**NON-HAZARDOUS
 WASTE MANIFEST**

1. Generator's US EPA ID No.
 NOT APPLICABLE

Manifest Document No.

2. Page 1 of

Authorizaton No.
 01216 - 0

3. Generator's Name and Mailing Address:
 City of Emeryville Redevelopment Agency
 2200 Powell St.; 12th Floor
 Emeryville, CA 94608
 4. Generator's phone (510) 596-4356 Attn: Ignacio Dayrit

5. Transporter 1 Company Name
 Northern Truck and Equipment
 6. US EPA ID Number
 NOT APPLICABLE

3113

7. Transporter 2 Company Name
 8. US EPA ID Number
 NOT APPLICABLE

9. Designated Facility Name and Site Address
 B & J LANDFILL
 6426 HAY ROAD
 VACAVILLE, CA 95687
 10. US EPA ID Number
 NOT APPLICABLE

A. Transporter's Phone (510) 429-8920
 B. Transporter's Phone
 C. Facility's Phone (707) 451-3276

11. Waste Shipping Name and Description

| a. | 12. Containers | | 13. Total Quantity | 14. Unit Wt/Vol |
|---|----------------|------|--------------------|-----------------|
| | No. | Type | | |
| Soil contaminated with petroleum hydrocarbons | 1 | T | 18 | Y |
| b. | | | | |
| c. | | | | |
| d. | | | | |

D. Additional Descriptions for Materials Listed Above
 Soil excavated from 40th Street UST Project
 4000 San Pablo Ave., Emeryville, CA

E. Handling Codes for Wastes Listed Above
 03

15. Special Handling Instructions and Additional Information

16. GENERATOR'S CERTIFICATION: I certify the materials described above on this manifest are not listed in federal regulations for reporting proper disposal of Hazardous Waste.
 Printed/Typed Name: Ignacio Dayrit
 Signature: *[Signature]*

17. Transporter 1 Acknowledgement of Receipt of Materials
 Printed/Typed Name: Dan M. Rounds
 Signature: *[Signature]*
 Month Day Year: 8 23 94

18. Transporter 2 Acknowledgement of Receipt of Materials
 Printed/Typed Name:
 Signature:
 Month Day Year:

19. Discrepancy Indication Space
 Month Day Year:

20. Facility Owner or Operator Certification of receipt of waste materials covered by this manifest except as noted in Item 19
 Printed/Typed Name: *[Signature]*
 Signature: *[Signature]*
 Month Day Year: 8 23 94

**NON-HAZARDOUS
 WASTE MANIFEST**

1. Generator's US EPA ID No.
 NOT APPLICABLE

Manifest Document No.

2. Page 1 of

Authorizaton No.
 01216 - D

3. Generator's Name and Mailing Address
 City of Emeryville Redevelopment Agency
 2200 Powell St., 12th Floor
 Emeryville, CA 94608

4. Generator's Phone (510) 596-4356 Attn: Ignacio Dayrit

5. Transporter 1 Company Name
 Northern Truck and Equipment

6. US EPA ID Number
 NOT APPLICABLE

7. Transporter 2 Company Name

8. US EPA ID Number
 NOT APPLICABLE

9. Designated Facility Name and Site Address

B & J LANDFILL
 6426 HAY ROAD
 VACAVILLE, CA 95687

10. US EPA ID Number
 NOT APPLICABLE

A. Transporter's Phone (510) 429-8920

B. Transporter's Phone

C. Facility's Phone
 (707) 451-3276

11. Waste Shipping Name and Description

a. Soil contaminated with petroleum hydrocarbons

12. Containers

No. Type

13. Total Quantity

14. Unit Wt/Vol

1

T

18

Y

GENERATOR

D. Additional Descriptions for Materials Listed Above

Soil excavated from 40th Street UST Project
 4000 San Pablo Ave., Emeryville, CA

E. Handling Codes for Wastes Listed Above

03

15. Special Handling Instructions and Additional Information

16. GENERATOR'S CERTIFICATION: I certify the materials described above on this manifest are not subject to federal regulations for reporting proper disposal of Hazardous Waste.

Printed/Typed Name Ignacio Dayrit

Signature 

17. Transporter 1 Acknowledgement of Receipt of Materials

Printed/Typed Name David L. Marcus

Signature 

Month Day Year
 08 23 94

18. Transporter 2 Acknowledgement of Receipt of Materials

Printed/Typed Name

Signature

Month Day Year
 08 23 94

19. Discrepancy Indication Space

Month Day Year

20. Facility Owner or Operator: Certification of receipt of waste materials covered by this manifest except as noted in item 19.

Printed/Typed Name Bill Fisher

Signature 

Month Day Year
 08 23 94

**NON-HAZARDOUS
WASTE MANIFEST**

1. Generator's US EPA ID No.
NOT APPLICABLE

Manifest Document No.

2. Page 1 of

Authorization No.
01216-0

3. Generator's Name and Mailing Address:
City of Emeryville Redevelopment Agency
2200 Powell St.; 12th Floor
Emeryville, CA 94608

4. Generator's Phone (510) 596-4356 Attn: Ignacio Dayrit

5. Transporter 1 Company Name
Northern Truck and Equipment

6. US EPA ID Number
NOT APPLICABLE

3113

7. Transporter 2 Company Name

8. US EPA ID Number
NOT APPLICABLE

9. Designated Facility Name and Site Address

B & J LANDFILL
6426 HAY ROAD
VACAVILLE, CA 95687

10. US EPA ID Number

NOT APPLICABLE

A. Transporter's Phone (510) 429-8920

B. Transporter's Phone

C. Facility's Phone
(707) 451-3276

11. Waste Shipping Name and Description

a. Soil contaminated with petroleum hydrocarbons

12. Containers
No. Type

1

T

13. Total Quantity

18

14. Unit Wt/Vol

Y

D. Additional Descriptions for Materials Listed Above

Soil excavated from 40th Street UST Project
4000 San Pablo Ave., Emeryville, CA

E. Handling Codes for Wastes Listed Above

03

15. Special Handling Instructions and Additional Information

16. GENERATOR'S CERTIFICATION: I certify the materials described above on this manifest are not listed in federal regulations for reporting proper disposal of Hazardous Waste.

Printed/Typed Name
Ignacio Dayrit

Signature

Month Day Year

0.8 | 2.4 | 9.4

17. Transporter 1 Acknowledgement of Receipt of Materials

Printed/Typed Name

Bob Cross

Signature

Month Day Year

0.8 | 2.4 | 9.4

18. Transporter 2 Acknowledgement of Receipt of Materials

Printed/Typed Name

Signature

Month Day Year

19. Discrepancy Indication Space

20. Facility Owner or Operator: Certification of receipt of waste materials covered by this manifest except as noted in Item 19.

Printed/Typed Name

Sandra Hall

Signature

Sandra Hall

Month Day Year

10 | 8 | 04

**NON-HAZARDOUS
 WASTE MANIFEST**

1. Generator's US EPA ID No.
 NOT APPLICABLE

Manifest Document No.

2. Page 1 of

Authorizaton No.
 01216-0

3. Generator's Name and Mailing Address:
 City of Emeryville Redevelopment Agency
 2200 Powell St.; 12th Floor
 Emeryville, CA 94608

4. Generator's Phone (510) 596-4356

Attn: Ignacio Dayrit

B-1

RSI

5. Transporter 1 Company Name
 Northern Truck and Equipment

6. US EPA ID Number
 NOT APPLICABLE

3113

7. Transporter 2 Company Name

8. US EPA ID Number
 NOT APPLICABLE

9. Designated Facility Name and Site Address

B & J LANDFILL
 6426 HAY ROAD
 VACAVILLE, CA 95687

10. US EPA ID Number
 NOT APPLICABLE

A. Transporter's Phone (510) 429-8920

B. Transporter's Phone

C. Facility's Phone
 (707) 451-3276

11. Waste Shipping Name and Description

a. Soil contaminated with petroleum hydrocarbons

| 12. Containers | 13. Total Quantity | 14. Unit Wt./Vol |
|----------------|--------------------|------------------|
| | | |
| 1 | 18 | Y |
| . | . | . |
| . | . | . |
| . | . | . |
| . | . | . |

D. Additional Descriptions for Materials Listed Above

Soil excavated from 40th Street UST Project
 4000 San Pablo Ave., Emeryville, CA

E. Handling Codes for Wastes Listed Above

03

15. Special Handling Instructions and Additional Information

16. GENERATOR'S CERTIFICATION: I certify the materials described above on this manifest are not subject to federal regulations for reporting proper disposal of Hazardous Waste.

Printed/Typed Name
 Ignacio Dayrit

Signature

17. Transporter 1 Acknowledgement of Receipt of Materials

Printed/Typed Name
 ARNOLD PADILLA

Signature

Month Day Year
 08 29 94

18. Transporter 2 Acknowledgement of Receipt of Materials

Printed/Typed Name

Signature

Month Day Year
 08 29 94

19. Discrepancy Indication Space

Month Day Year

20. Facility Owner or Operator: Certification of receipt of waste materials covered by this manifest except as noted in item 19.

Printed/Typed Name

Signature

Month Day Year
 08 29 94

NON-HAZARDOUS WASTE MANIFEST

1. Generator's US EPA ID No.
 NOT APPLICABLE

Manifest Document No.

2. Page 1 of

Authorizaton No.
 01216-0

3. Generator's Name and Mailing Address:
 City of Emeryville Redevelopment Agency
 2200 Powell St., 12th Floor
 Emeryville, CA 94608
 4. Generator's Phone (510) 596-4356 Attn: Ignacio Dayrit

5. Transporter 1 Company Name
 Northern Truck and Equipment
 6. US EPA ID Number
 NOT APPLICABLE

7. Transporter 2 Company Name
 8. US EPA ID Number
 NOT APPLICABLE

9. Designated Facility Name and Site Address:
 B & J LANDFILL
 6426 HAY ROAD
 VACAVILLE, CA 95687
 10. US EPA ID Number
 NOT APPLICABLE

A. Transporter's Phone (510) 429-8920
 B. Transporter's Phone
 C. Facility's Phone (707) 451-3276

11. Waste Shipping Name and Description

a. Soil contaminated with petroleum hydrocarbons
 b.
 c.
 d.

| 12. Containers | | 13. Total Quantity | 14. Unit Wt/Vol |
|----------------|------|--------------------|-----------------|
| No. | Type | | |
| 1 | T | 18 | |
| | | | |
| | | | |
| | | | |

D. Additional Descriptions for Materials Listed Above
 Soil excavated from 40th Street UST Project
 4000 San Pablo Ave., Emeryville, CA

E. Handling Codes for Wastes Listed Above
 03

15. Special Handling Instructions and Additional Information

16. GENERATOR'S CERTIFICATION: I certify the materials described above on this manifest are not subject to federal regulations for reporting proper disposal of Hazardous Waste.

Printed/Typed Name
 Ignacio Dayrit

Signature

Month Day Year

17. Transporter 1 Acknowledgement of Receipt of Materials
 Printed/Typed Name
 KERRY TRUCKING

Signature

Month Day Year
 08 20 1997

18. Transporter 2 Acknowledgement of Receipt of Materials
 Printed/Typed Name

Signature

Month Day Year

19. Discrepancy Indication Space

20. Facility Owner or Operator: Certification of receipt of waste materials covered by this manifest except as noted in item 19.

Printed/Typed Name
 Sandra Hall

Signature

Month Day Year
 08 20 1997

**NON-HAZARDOUS
WASTE MANIFEST**

1. Generator's US EPA ID No.
NOT APPLICABLE

Manifest Document No.

2. Page 1 of

Authorizaton No.
01216-0

3. Generator's Name and Mailing Address
City of Emeryville Redevelopment Agency
2200 Powell St.; 12th Floor
Emeryville, CA 94608

4. Generator's Phone (510) 596-4356 Attn: Ignacio Dayrit

5. Transporter 1 Company Name
Northern Truck and Equipment

6. US EPA ID Number
NOT APPLICABLE

3113

7. Transporter 2 Company Name

8. US EPA ID Number
NOT APPLICABLE

9. Designated Facility Name and Site Address

B & J LANDFILL
6426 HAY ROAD
VACAVILLE, CA 95687

10. US EPA ID Number

NOT APPLICABLE

A. Transporter's Phone (510) 429-8920

B. Transporter's Phone

C. Facility's Phone
(707) 451-3276

11. Waste Shipping Name and Description

a. Soil contaminated with petroleum hydrocarbons

| 12. Containers | No. | Type | 13. Total Quantity | 14. Unit Wt/Vol |
|----------------|-----|------|--------------------|-----------------|
| | | | | |
| | 1 | T | 18 | Y |
| | | | | |
| | | | | |
| | | | | |
| | | | | |

D. Additional Descriptions for Materials Listed Above
Soil excavated from 40th Street UST Project
4000 San Pablo Ave., Emeryville, CA

E. Handling Codes for Wastes Listed Above

03

15. Special Handling Instructions and Additional Information

16. GENERATOR'S CERTIFICATION: I certify the materials described above on this manifest are not subject to federal regulations for reporting proper disposal of Hazardous Waste.

Printed/Typed Name Ignacio Dayrit

Signature

Month Day Year
1 8 1994

17. Transporter 1 Acknowledgement of Receipt of Materials

Printed/Typed Name DON FERSEN

Signature

Month Day Year
1 8 1994

18. Transporter 2 Acknowledgement of Receipt of Materials

Printed/Typed Name

Signature

Month Day Year

19. Discrepancy Indication Space

20. Facility Owner or Operator: Certification of receipt of waste materials covered by this manifest except as noted in item 19.

Printed/Typed Name Sandra Hall

Signature

Month Day Year
1 8 1994

NON-HAZARDOUS WASTE MANIFEST

1. Generator's US EPA ID No.
NOT APPLICABLE

Manifest Document No.

2. Page 1 of

Authorizaton No.
01216 - D

3. Generator's Name and Mailing Address
City of Emeryville Redevelopment Agency
2200 Powell St.; 12th Floor
Emeryville CA 94608

4. Generator's Phone (510) 596-4356 Attn: Ignacio Dayrit

5. Transporter 1 Company Name
Northern Truck and Equipment

6. US EPA ID Number
NOT APPLICABLE

3113

7. Transporter 2 Company Name

8. US EPA ID Number
NOT APPLICABLE

9. Designated Facility Name and Site Address

B & J LANDFILL
6426 HAY ROAD
VACAVILLE, CA 95687

10. US EPA ID Number

NOT APPLICABLE

A. Transporter's Phone (510) 429-8920

B. Transporter's Phone

C. Facility's Phone
(707) 451-3276

11. Waste Shipping Name and Description

a. Soil contaminated with petroleum hydrocarbons

12. Containers

| No. | Type | 13. Total Quantity | 14. Unit Wt/Vol |
|-----|------|--------------------|-----------------|
| 1 | T | 18 | Y |
| . | . | . | . |
| . | . | . | . |
| . | . | . | . |
| . | . | . | . |

D. Additional Descriptions for Materials Listed Above
Soil excavated from 40th Street UST Project
4000 San Pablo Ave., Emeryville, CA

E. Handling Codes for Wastes Listed Above

03

15. Special Handling Instructions and Additional Information

16. GENERATOR'S CERTIFICATION: I certify the materials described above on this manifest are not subject to Federal regulations for reporting proper disposal of Hazardous Waste.
Printed/Typed Name: Ignacio Dayrit
Signature: *[Signature]*

17. Transporter 1 Acknowledgement of Receipt of Materials
Printed/Typed Name: *MICHAEL DANERLE*
Signature: *[Signature]* Month Day Year: 12/24/99

18. Transporter 2 Acknowledgement of Receipt of Materials
Printed/Typed Name: *[Signature]*
Signature: *[Signature]* Month Day Year: 12/24/99

19. Discrepancy Indication Space
Month Day Year

20. Facility Owner or Operator: Certification of receipt of waste materials covered by this manifest except as noted in item 19.

Printed/Typed Name: Sandra Hall
Signature: *[Signature]* Month Day Year: 05/24/99

**NON-HAZARDOUS
WASTE MANIFEST**

1. Generator's US EPA ID No.
NOT APPLICABLE

Manifest Document No.

2. Page 1 of

Authorizaton No.
01216 - D

3. Generator's Name and Mailing Address:
City of Emeryville Redevelopment Agency
2200 Powell St.; 12th Floor
Emeryville, CA 94608

4. Generator's Phone (510) 596-4356 Attn: Ignacio Dayrit

5. Transporter 1 Company Name
Northern Truck and Equipment

6. US EPA ID Number
NOT APPLICABLE

3113

7. Transporter 2 Company Name

8. US EPA ID Number
NOT APPLICABLE

9. Designated Facility Name and Site Address

B & J LANDFILL
6426 HAY ROAD
VACAVILLE, CA 95687

10. US EPA ID Number

NOT APPLICABLE

A. Transporter's Phone (510) 429-8920

B. Transporter's Phone

C. Facility's Phone
(707) 451-3276

11. Waste Shipping Name and Description

a. Soil contaminated with petroleum hydrocarbons

| 12. Containers | | 13. Total Quantity | 14. Unit Wt/Vol |
|----------------|------|--------------------|-----------------|
| No. | Type | | |
| 1 | T | 18 | Y |
| | | | |
| | | | |
| | | | |
| | | | |

D. Additional Descriptions for Materials Listed Above

Soil excavated from 40th Street UST Project
4000 San Pablo Ave., Emeryville, CA

E. Handling Codes for Wastes Listed Above

03

15. Special Handling Instructions and Additional Information

16. GENERATOR'S CERTIFICATION: I certify the materials described above on this manifest are not subject to federal regulations for reporting proper disposal of Hazardous Waste.

Printed/Typed Name Ignacio Dayrit

Signature 

Month Day Year

17. Transporter 1 Acknowledgement of Receipt of Materials

Printed/Typed Name Arturo Olvera

Signature 

Month Day Year

10/8/94

18. Transporter 2 Acknowledgement of Receipt of Materials

Printed/Typed Name

Signature

Month Day Year

19. Discrepancy Indication Space

20. Facility Owner or Operator: Certification of receipt of waste materials covered by this manifest except as noted in Item 19.

Printed/Typed Name Sandra Hall

Signature 

Month Day Year

10/8/94

NON-HAZARDOUS WASTE MANIFEST

1. Generator's US EPA ID No.
 NOT APPLICABLE

Manifest Document No.

2. Page 1 of

Authorizaton No.
 01216 - 0

3. Generator's Name and Mailing Address:
 City of Emeryville Redevelopment Agency
 2200 Powell St.; 12th Floor
 Emeryville, CA 94608

4. Generator's Phone (510) 596-4356 Attn: Ignacio Dayrit

5. Transporter 1 Company Name
 Northern Truck and Equipment

6. US EPA ID Number
 NOT APPLICABLE

7. Transporter 2 Company Name

8. US EPA ID Number
 NOT APPLICABLE

9. Designated Facility Name and Site Address

B & J LANDFILL
 6426 HAY ROAD
 VACAVILLE, CA 95687

10. US EPA ID Number

11. Waste Shipping Name and Description
 NOT APPLICABLE

A. Transporter's Phone (510) 429-8920

B. Transporter's Phone

C. Facility's Phone
 (707) 451-3276

RSJ
 TR # 33

| | 12. Containers | | 13. Total Quantity | 14. Unit Wt/Vol |
|--|----------------|------|--------------------|-----------------|
| | No. | Type | | |
| a. Soil contaminated with petroleum hydrocarbons | 1 | T | 18 | Y |
| b. | | | | |
| c. | | | | |
| d. | | | | |

D. Additional Descriptions for Materials Listed Above
 Soil excavated from 40th Street UST Project
 4000 San Pablo Ave., Emeryville, CA

E. Handling Codes for Wastes Listed Above
 03

15. Special Handling Instructions and Additional Information

16. GENERATOR'S CERTIFICATION: I certify the materials described above on this manifest are not subject to federal regulations for reporting proper disposal of Hazardous Waste.

Printed/Typed Name
 Ignacio Dayrit

Signature

Month Day Year
 8 24 94

17. Transporter 1 Acknowledgement of Receipt of Materials

Printed/Typed Name
 PATRICK O'BRIEN

Signature

Month Day Year
 8 24 94

18. Transporter 2 Acknowledgement of Receipt of Materials

Printed/Typed Name

Signature

Month Day Year

19. Discrepancy Indication Space

20. Facility Owner or Operator: Certification of receipt of waste materials covered by this manifest except as noted in Item 19.

Printed/Typed Name
 Sandra Hall

Signature

Month Day Year
 8 24 94

**NON-HAZARDOUS
 WASTE MANIFEST**

1. Generator's US EPA ID No.
 NOT APPLICABLE

Manifest Document No.

2. Page 1 of

Authorizaton No.
 01216 - D

3. Generator's Name and Mailing Address
 City of Emeryville Redevelopment Agency
 2200 Powell St.; 12th Floor
 Emeryville CA 94608

4. Generator's Phone (510) 596-4356 Attn: Ignacio Dayrit

5. Transporter 1 Company Name
 Northern Truck and Equipment

6. US EPA ID Number
 NOT APPLICABLE

3113

7. Transporter 2 Company Name

8. US EPA ID Number
 NOT APPLICABLE

9. Designated Facility Name and Site Address

B & J LANDFILL
 6426 HAY ROAD
 VACAVILLE, CA 95687

10. US EPA ID Number

NOT APPLICABLE

A. Transporter's Phone (510) 429-8920

B. Transporter's Phone

C. Facility's Phone
 (707) 451-3276

11. Waste Shipping Name and Description

a. Soil contaminated with petroleum hydrocarbons

| 12. Containers | | 13. Total Quantity | 14. Unit Wt/Vol |
|----------------|------|--------------------|-----------------|
| No. | Type | | |
| 1 | T | 18 | Y |
| | | | |
| | | | |
| | | | |
| | | | |

b.

c.

d.

D. Additional Descriptions for Materials Listed Above

Soil excavated from 40th Street UST Project
 4000 San Pablo Ave., Emeryville, CA

E. Handling Codes for Wastes Listed Above

03

15. Special Handling Instructions and Additional Information

16. GENERATOR'S CERTIFICATION: I certify the materials described above on this manifest are not subject to federal regulations for reporting proper disposal of Hazardous Waste.

Printed/Typed Name
 Ignacio Dayrit

Signature

17. Transporter 1 Acknowledgement of Receipt of Materials

Printed/Typed Name

Calvinaga & Son, MM#

Signature

Month Day Year
 10 24 94

18. Transporter 2 Acknowledgement of Receipt of Materials

Printed/Typed Name

Signature

Month Day Year
 10 24 94

19. Discrepancy Indication Space

20. Facility Owner or Operator: Certification of receipt of waste materials covered by this manifest except as noted in Item 19.

Printed/Typed Name

Sandra Hall

Signature

Sandra Hall

Month Day Year
 10 24 94

NON-HAZARDOUS WASTE MANIFEST

1. Generator's US EPA ID No. **NOT APPLICABLE**

Manifest Document No.

2. Page 1 of

Authorizaton No. 01216 - 0

3. Generator's Name and Mailing Address
City of Emeryville Redevelopment Agency
2200 Powell St.; 12th Floor
Emeryville CA 94608

4. Generator's Phone (510) 596-4356 Attn: Ignacio Dayrit

5. Transporter 1 Company Name
Northern Truck and Equipment

6. US EPA ID Number
NOT APPLICABLE

3113

7. Transporter 2 Company Name

8. US EPA ID Number
NOT APPLICABLE

9. Designated Facility Name and Site Address

B & J LANDFILL
6426 HAY ROAD
VACAVILLE, CA 95687

10. US EPA ID Number

NOT APPLICABLE

A. Transporter's Phone (510) 429-8920

B. Transporter's Phone

C. Facility's Phone (707) 451-3276

11. Waste Shipping Name and Description

Soil contaminated with petroleum hydrocarbons

12. Containers

No.

Type

13. Total Quantity

14. Unit Wt/Vol

1

T

18

Y

D. Additional Descriptions for Materials Listed Above

Soil excavated from 40th Street UST Project
4000 San Pablo Ave., Emeryville, CA

E. Handling Codes for Wastes Listed Above

03

15. Special Handling Instructions and Additional Information

16. GENERATOR'S CERTIFICATION: I certify the materials described above on this manifest are not subject to federal regulations for reporting proper disposal of Hazardous Waste.

Printed/Typed Name Ignacio Dayrit

Signature

17. Transporter 1 Acknowledgement of Receipt of Materials

Printed/Typed Name Bob Cross

Signature

Month Day Year
10 8 12 4 9 4

18. Transporter 2 Acknowledgement of Receipt of Materials

Printed/Typed Name

Signature

Month Day Year
10 8 2 4 9 4

19. Discrepancy Indication Space

Month Day Year

20. Facility Owner or Operator: Certification of receipt of waste materials covered by this manifest except as noted in Item 19.

Printed/Typed Name

Signature

Month Day Year
10 8 2 4 9 4

**NON-HAZARDOUS
 WASTE MANIFEST**

1. Generator's US EPA ID No.
 NOT APPLICABLE

Manifest Document No.

2. Page 1 of

Authorization No.
 01216 - 0

3. Generator's Name and Mailing Address:
 City of Emeryville Redevelopment Agency
 2200 Powell St., 12th Floor
 Emeryville, CA 94608

4. Generator's Phone (510) 596-4356 Attn: Ignacio Dayrit

B4

5. Transporter 1 Company Name
 Northern Truck and Equipment

6. US EPA ID Number
 NOT APPLICABLE

7. Transporter 2 Company Name

8. US EPA ID Number
 NOT APPLICABLE

9. Designated Facility Name and Site Address
 B & J LANDFILL
 6426 HAY ROAD
 VACAVILLE, CA 95687

10. US EPA ID Number
 NOT APPLICABLE

A. Transporter's Phone (510) 429-8920
 B. Transporter's Phone
 C. Facility's Phone (707) 451-3276

11. Waste Shipping Name and Description
 NOT APPLICABLE

a. Soil contaminated with petroleum hydrocarbons

| 12. Containers | 13. Total Quantity | 14. Unit Wt/Vol |
|----------------|--------------------|-----------------|
| | | |
| 1 | 18 | Y |
| | | |
| | | |
| | | |
| | | |

b.
 c.
 d.

D. Additional Descriptions for Materials Listed Above
 Soil excavated from 40th Street UST Project
 4000 San Pablo Ave., Emeryville, CA

E. Handling Codes for Wastes Listed Above
 03

15. Special Handling Instructions and Additional Information

16. GENERATOR'S CERTIFICATION: I certify the materials described above on this manifest are not subject to federal regulations for reporting proper disposal of Hazardous Waste.

Printed/Typed Name Ignacio Dayrit

Signature

Month Day Year

17. Transporter 1 Acknowledgement of Receipt of Materials

Printed/Typed Name ARNOLD PAVULA

Signature

Month Day Year

18. Transporter 2 Acknowledgement of Receipt of Materials

Printed/Typed Name

Signature

Month Day Year

19. Discrepancy Indication Space

20. Facility Owner or Operator: Certification of receipt of waste materials covered by this manifest except as noted in Item 19.

Printed/Typed Name

Jill A Fisher

Signature

Month Day Year 08/24/97

**NON-HAZARDOUS
 WASTE MANIFEST**

1. Generator's US EPA ID No.
 NOT APPLICABLE

Manifest Document No.

2. Page 1 of

Authorizaton No.
 01216 - 0

R-3 751

3. Generator's Name and Mailing Address
 City of Emeryville Redevelopment Agency
 2200 Powell St.; 12th Floor
 Emeryville, CA 94608

4. Generator's Phone (510) 596-4356 Attn: Ignacio Dayrit

5. Transporter 1 Company Name
 Northern Truck and Equipment

7. Transporter 2 Company Name

9. Designated Facility Name and Site Address
 B & J LANDFILL
 6426 HAY ROAD
 VACAVILLE, CA 95687

11. Waste Shipping Name and Description
 NOT APPLICABLE

A. Transporter's Phone (510) 429-8920
 B. Transporter's Phone
 C. Facility's Phone (707) 451-3276

| | 12. Containers | | 13. Total Quantity | 14. Unit Wt/Vol |
|--|----------------|------|--------------------|-----------------|
| | No. | Type | | |
| a. Soil contaminated with petroleum hydrocarbons | 1 | T | 18 | Y |
| b. | | | | |
| c. | | | | |
| d. | | | | |

D. Additional Descriptions for Materials Listed Above
 Soil excavated from 40th Street UST Project
 4000 San Pablo Ave., Emeryville, CA

E. Handling Codes for Wastes Listed Above
 03

15. Special Handling Instructions and Additional Information

16. GENERATOR'S CERTIFICATION: I certify the materials described above on this manifest are not subject to federal regulations for reporting proper disposal of Hazardous Waste.

Printed/Typed Name
 Ignacio Dayrit

Signature

Month Day Year

17. Transporter 1 Acknowledgement of Receipt of Materials
 Printed/Typed Name
 Don M. Rounds

Signature

Month Day Year
 18 24 84

18. Transporter 2 Acknowledgement of Receipt of Materials
 Printed/Typed Name

Signature

Month Day Year

19. Discrepancy Indication Space

20. Facility Owner or Operator: Certification of receipt of waste materials covered by this manifest except as noted in Item 19.

Printed/Typed Name
 Sandra Hall

Signature

Month Day Year
 08 24 84

**NON-HAZARDOUS
 WASTE MANIFEST**

1. Generator's US EPA ID No.
 NOT APPLICABLE

Manifest Document No.

2. Page 1 of

Authorizaton No.
 01216 - D

3. Generator's Name and Mailing Address:
 City of Emeryville Redevelopment Agency
 2200 Powell St., 12th Floor
 Emeryville, CA 94608

4. Generator's Phone (510) 596-4356 Attn: Ignacio Dayrit

5. Transporter 1 Company Name
 Northern Truck and Equipment

6. US EPA ID Number
 NOT APPLICABLE

3113

7. Transporter 2 Company Name

8. US EPA ID Number
 NOT APPLICABLE

9. Designated Facility Name and Site Address

B & J LANDFILL
 6426 HAY ROAD
 VACAVILLE, CA 95687

10. US EPA ID Number

A. Transporter's Phone (510) 429-8920

B. Transporter's Phone

C. Facility's Phone
 (707) 451-3276

11. Waste Shipping Name and Description

NOT APPLICABLE

a. Soil contaminated with petroleum hydrocarbons

| 12. Containers | | 13. Total Quantity | 14. Unit Wt/Vol |
|----------------|------|--------------------|-----------------|
| No. | Type | | |
| 1 | T | 18 | Y |
| . | . | . | . |
| . | . | . | . |
| . | . | . | . |
| . | . | . | . |

b.
 c.
 d.

D. Additional Descriptions for Materials Listed Above
 Soil excavated from 40th Street UST Project
 4000 San Pablo Ave., Emeryville, CA

E. Handling Codes for Wastes Listed Above

03

15. Special Handling Instructions and Additional Information

16. GENERATOR'S CERTIFICATION: I certify the materials described above on this manifest are not subject to federal regulations for reporting proper disposal of Hazardous Waste.

Printed/Typed Name Ignacio Dayrit

Signature

17. Transporter 1 Acknowledgement of Receipt of Materials

Printed/Typed Name Tom Kinner

Signature

Month Day Year
 08 24 97

18. Transporter 2 Acknowledgement of Receipt of Materials

Printed/Typed Name

Signature

Month Day Year
 08 24 97

19. Discrepancy Indication Space

Month Day Year

20. Facility Owner or Operator: Certification of receipt of waste materials covered by this manifest except as noted in Item 19.

Printed/Typed Name

Sandra Hall

Signature

Sandra Hall

Month Day Year
 08 24 97

**NON-HAZARDOUS
 WASTE MANIFEST**

1. Generator's US EPA ID No.
 NOT APPLICABLE

Manifest Document No.

2. Page 1 of

Authorizaton No.
 01216 - 0

3. Generator's Name and Mailing Address
 City of Emeryville Redevelopment Agency
 2200 Powell St.; 12th Floor
 Emeryville, CA 94608
 4. Generator's Phone (510) 596-4356 Attn: Ignacio Dayrit

TR # 12 RSI

5. Transporter 1 Company Name
 Northern Truck and Equipment
 6. US EPA ID Number
 NOT APPLICABLE

7. Transporter 2 Company Name
 8. US EPA ID Number
 NOT APPLICABLE

9. Designated Facility Name and Site Address
 B & J LANDFILL
 6426 HAY ROAD
 VACAVILLE, CA 95687
 10. US EPA ID Number
 NOT APPLICABLE

A. Transporter's Phone (510) 429-8920
 B. Transporter's Phone
 C. Facility's Phone
 (707) 451-3276

11. Waste Shipping Name and Description
 NOT APPLICABLE

| | 12. Containers | | 13. Total Quantity | 14. Unit Wt/Vol |
|--|----------------|------|--------------------|--------------------|
| | No. | Type | | |
| a. Soil contaminated with petroleum hydrocarbons | 1 | T | 18 | Y |
| b. | | | | |
| c. | | | | |
| d. | | | | |

D. Additional Descriptions for Materials Listed Above
 Soil excavated from 40th Street UST Project
 4000 San Pablo Ave., Emeryville, CA

E. Handling Codes for Wastes Listed Above
 03

15. Special Handling Instructions and Additional Information

16. GENERATOR'S CERTIFICATION: I certify the materials described above on this manifest are not subject to federal regulations for reporting proper disposal of Hazardous Waste.
 Printed/Typed Name Ignacio Dayrit Signature

17. Transporter 1 Acknowledgement of Receipt of Materials
 Printed/Typed Name DRU JENSEN Signature Month Day Year 8/24/94

18. Transporter 2 Acknowledgement of Receipt of Materials
 Printed/Typed Name Signature Month Day Year 8/24/94

19. Discrepancy Indication Space

20. Facility Owner or Operator: Certification of receipt of waste materials covered by this manifest except as noted in item 19.
 Printed/Typed Name Sandra Hall Signature Month Day Year 8/24/94

**NON-HAZARDOUS
 WASTE MANIFEST**

1. Generator's US EPA ID No.
 NOT APPLICABLE

Manifest Document No.

2. Page 1 of

Authorizaton No.
 01216 - 0

3. Generator's Name and Mailing Address
 City of Emeryville Redevelopment Agency
 2200 Powell St., 12th Floor
 Emeryville, CA 94608

4. Generator's Phone (510) 596-4356 Attn: Ignacio Dayrit

TR RB 6

5. Transporter 1 Company Name
 Northern Truck and Equipment

6. US EPA ID Number
 NOT APPLICABLE

3113

7. Transporter 2 Company Name

8. US EPA ID Number
 NOT APPLICABLE

9. Designated Facility Name and Site Address

B & J LANDFILL
 6426 HAY ROAD
 VACAVILLE, CA 95687

10. US EPA ID Number

A. Transporter's Phone (510) 429-8920

B. Transporter's Phone

C. Facility's Phone
 (707) 451-3276

11. Waste Shipping Name and Description

NOT APPLICABLE

| 12. Containers | | 13. Total Quantity | 14. Unit Wt/Vol |
|----------------|------|--------------------|-----------------|
| No. | Type | | |
| 1 | T | 18 | Y |
| | | | |
| | | | |
| | | | |

a. Soil contaminated with petroleum hydrocarbons

D. Additional Descriptions for Materials Listed Above
 Soil excavated from 40th Street UST Project
 4000 San Pablo Ave., Emeryville, CA

E. Handling Codes for Wastes Listed Above

03

15. Special Handling Instructions and Additional Information

16. GENERATOR'S CERTIFICATION: I certify the materials described above on this manifest are ~~not~~ subject to federal regulations for reporting proper disposal of Hazardous Waste.

Printed/Typed Name
 Ignacio Dayrit

Signature

17. Transporter 1 Acknowledgement of Receipt of Materials

Printed/Typed Name
 MIKE DAUERLE

Signature

Month Day Year
 08 27 99

18. Transporter 2 Acknowledgement of Receipt of Materials

Printed/Typed Name

Signature

Month Day Year
 08 27 99

19. Discrepancy Indication Space

Month Day Year

20. Facility Owner or Operator: Certification of receipt of waste materials covered by this manifest except as noted in item 19.

Printed/Typed Name
 Sandra Hall

Signature

Month Day Year
 08 27 99

NON-HAZARDOUS WASTE MANIFEST

1. Generator's US EPA ID No.
 NOT APPLICABLE

Manifest Document No.

2. Page 1 of

Authorizaton No.
 01216 - D

3. Generator's Name and Mailing Address:
 City of Emeryville Redevelopment Agency
 2200 Powell St.; 12th Floor
 Emeryville, CA 94608

4. Generator's Phone (510) 596-4356 Attn: Ignacio Dayrit

5. Transporter 1 Company Name
 Northern Truck and Equipment

6. US EPA ID Number
 NOT APPLICABLE

7. Transporter 2 Company Name

8. US EPA ID Number
 NOT APPLICABLE

9. Designated Facility Name and Site Address

B & J LANDFILL
 6426 HAY ROAD
 VACAVILLE, CA 95687

10. US EPA ID Number

A. Transporter's Phone (510) 429-8920

B. Transporter's Phone

C. Facility's Phone
 (707) 451-3276

11. Waste Shipping Name and Description
 NOT APPLICABLE

a. Soil contaminated with petroleum hydrocarbons

| 12. Containers | 13. Total Quantity | 14. Unit Wt/Vol | |
|----------------|--------------------|-----------------|-----|
| | | | No. |
| 1 | T | 18 | Y |
| | | | |
| | | | |
| | | | |
| | | | |

GENERATOR

D. Additional Descriptions for Materials Listed Above
 Soil excavated from 40th Street UST Project
 4000 San Pablo Ave., Emeryville, CA

E. Handling Codes for Wastes Listed Above
 03

15. Special Handling Instructions and Additional Information

16. GENERATOR'S CERTIFICATION: I certify the materials described above on this manifest are not subject to federal regulations for reporting proper disposal of Hazardous Waste.
 Printed/Typed Name: Ignacio Dayrit
 Signature:

17. Transporter 1 Acknowledgement of Receipt of Materials
 Printed/Typed Name:
 Signature:
 Month Day Year: 12/18/94

18. Transporter 2 Acknowledgement of Receipt of Materials
 Printed/Typed Name:
 Signature:
 Month Day Year: 12/21/94

19. Discrepancy Indication Space
 Month Day Year

20. Facility Owner or Operator: Certification of receipt of waste materials covered by this manifest except as noted in Item 19.

Printed/Typed Name:
 Signature:
 Month Day Year: 12/21/94

| | | | | | |
|--|--|--|-----------------------|---|-----------------------------|
| NON-HAZARDOUS WASTE MANIFEST | | 1. Generator's US EPA ID No. NOT APPLICABLE | Manifest Document No. | 2. Page 1 of | Authorizaton No. 01216-D |
| 3. Generator's Name and Mailing Address City of Emeryville Redevelopment Agency 2200 Powell St., 12th Floor Emeryville, CA 94608 | | 4. Generator's Phone (510) 596-4356 Attn: Ignacio Dayrit | | 251. | |
| 5. Transporter 1 Company Name Northern Truck and Equipment | | 6. US EPA ID Number NOT APPLICABLE | | 3112 C.C.W. | |
| 7. Transporter 2 Company Name | | 8. US EPA ID Number NOT APPLICABLE | | | |
| 9. Designated Facility Name and Site Address B & J LANDFILL 6426 HAY ROAD VACAVILLE, CA 95687 | | 10. US EPA ID Number NOT APPLICABLE | | A. Transporter's Phone (510) 429-8920 B. Transporter's Phone C. Facility's Phone (707) 451-3276 | |
| 11. Waste Shipping Name and Description | | 12. Containers | | 13. Total Quantity | 14. Unit Wt/Vol |
| a. Soil contaminated with petroleum hydrocarbons | | No. | Type | 18 | Y |
| b. | | | | | |
| c. | | | | | |
| d. | | | | | |
| D. Additional Descriptions for Materials Listed Above Soil excavated from 40th Street UST Project 4000 San Pablo Ave., Emeryville, CA | | E. Handling Codes for Wastes Listed Above 03 | | | |
| 15. Special Handling Instructions and Additional Information | | | | | |
| 16. GENERATOR'S CERTIFICATION: I certify the materials described above on this manifest are not subject to federal regulations for reporting proper disposal of Hazardous Waste. | | | | | |
| Printed/Typed Name Ignacio Dayrit | | Signature | | Month Day Year 12 21 14 | |
| 17. Transporter 1 Acknowledgement of Receipt of Materials Printed/Typed Name CHRY SMITH | | Signature | | Month Day Year 12 21 14 | |
| 18. Transporter 2 Acknowledgement of Receipt of Materials Printed/Typed Name | | Signature | | Month Day Year | |
| 19. Discrepancy Indication Space | | | | | |
| 20. Facility Owner or Operator: Certification of receipt of waste materials covered by this manifest except as noted in Item 19. | | | | | |
| Printed/Typed Name Bill A. Fisher | | Signature | | Month Day Year 12 21 14 | |

ORIGINAL RETURN TO GENERATOR

**NON-HAZARDOUS
 WASTE MANIFEST**

1. Generator's US EPA ID No.
 NOT APPLICABLE

Manifest Document No.

2. Page 1 of

Authorizaton No.
 01216-0

3. Generator's Name and Mailing Address
 City of Emeryville Redevelopment Agency
 2200 Powell St., 12th Floor
 Emeryville, CA 94608

4. Generator's Phone (510) 596-4356 Attn: Ignacio Dayrit

5. Transporter 1 Company Name
 Northern Truck and Equipment

6. US EPA ID Number
 NOT APPLICABLE

~~2004~~ 2004

7. Transporter 2 Company Name

8. US EPA ID Number
 NOT APPLICABLE

9. Designated Facility Name and Site Address

B & J LANDFILL
 6426 HAY ROAD
 VACAVILLE, CA 95687

10. US EPA ID Number

A. Transporter's Phone (510) 429-8920

B. Transporter's Phone

C. Facility's Phone
 (707) 451-3276

11. Waste Shipping Name and Description

a. Soil contaminated with petroleum hydrocarbons

| 12. Containers | | 13. Total Quantity | 14. Unit Wt/Vol |
|----------------|------|--------------------|-----------------|
| No. | Type | | |
| 1 | T | 18 | Y |
| | | | |
| | | | |
| | | | |
| | | | |

D. Additional Descriptions for Materials Listed Above
 Soil excavated from 40th Street UST Project
 4000 San Pablo Ave., Emeryville, CA

E. Handling Codes for Wastes Listed Above

03

15. Special Handling Instructions and Additional Information

16. GENERATOR'S CERTIFICATION: I certify the materials described above on this manifest are not subject to federal regulations for reporting proper disposal of Hazardous Waste.

Printed/Typed Name Ignacio Dayrit

Signature 

Month Day Year
 08 24 94

17. Transporter 1 Acknowledgement of Receipt of Materials

Printed/Typed Name Bob Cross

Signature 

Month Day Year
 08 24 94

18. Transporter 2 Acknowledgement of Receipt of Materials

Printed/Typed Name

Signature

Month Day Year

19. Discrepancy Indication Space

20. Facility Owner or Operator: Certification of receipt of waste materials covered by this manifest except as noted in Item 19.

Printed/Typed Name

Will A. Fisher

Signature 

Month Day Year
 08 24 94

NON-HAZARDOUS WASTE MANIFEST

1. Generator's US EPA ID No.
NOT APPLICABLE

Manifest Document No.

2. Page 1 of

Authorization No.
01216 - 0

3. Generator's Name and Mailing Address:
City of Emeryville Redevelopment Agency
2200 Powell St., 12th Floor
Emeryville, CA 94608

4. Generator's Phone (510) 596-4356 Attn: Ignacio Dayrit

5. Transporter 1 Company Name
Northern Truck and Equipment

6. US EPA ID Number
NOT APPLICABLE

7. Transporter 2 Company Name

8. US EPA ID Number
NOT APPLICABLE

9. Designated Facility Name and Site Address

B & J LANDFILL
6426 HAY ROAD
VACAVILLE, CA 95687

10. US EPA ID Number
NOT APPLICABLE

A. Transporter's Phone (510) 429-8920

B. Transporter's Phone

C. Facility's Phone
(707) 451-3276

11. Waste Shipping Name and Description

a. Soil contaminated with petroleum hydrocarbons

| 12. Containers | | 13. Total Quantity | 14. Unit Wt/Vol |
|----------------|------|--------------------|-----------------|
| No. | Type | | |
| 1 | T | 18 | Y |
| | | | |
| | | | |
| | | | |
| | | | |

D. Additional Descriptions for Materials Listed Above
Soil excavated from 40th Street UST Project
4000 San Pablo Ave., Emeryville, CA

E. Handling Codes for Wastes Listed Above

03

15. Special Handling Instructions and Additional Information

16. GENERATOR'S CERTIFICATION: I certify the materials described above on this manifest are not subject to federal regulations for reporting proper disposal of hazardous waste.

Printed/Typed Name
Ignacio Dayrit

Signature

Month Day Year

10/2/80

17. Transporter 1 Acknowledgement of Receipt of Materials

Printed/Typed Name
ARNOLDO PADILLA

Signature

Month Day Year

10/8/80

18. Transporter 2 Acknowledgement of Receipt of Materials

Printed/Typed Name

Signature

Month Day Year

19. Discrepancy Indication Space

20. Facility Owner or Operator: Certification of receipt of waste materials covered by this manifest except as noted in item 19.

Printed/Typed Name

Will Fisher

Signature

Will Fisher

Month Day Year

10/2/80

APPENDIX D.7
EXCAVATION AND BACKFILL VOLUME CALCULATIONS

Project Notes

Woodward-Clyde



Subject: Volume Calculation

Project Name: 40th St. UST

By: Xinggang Tong Date: 8/16/94

Project No.: 94114NA

Task No.: 4000 File No.: _____

Checked By: _____ Date: _____

Sheet 1 of 2

See the attached drawing for dimensions.

$$\frac{1}{2} * (95' * 9' + 83' * 9') * 96'$$

(Average end method,
Volume without accounting
the slopes)

$$- 96' * 9' * 9' * \frac{1}{2} * 2$$

(Subtract slope volume
of two sides)

$$- 83' * 9' * 9' * \frac{1}{2}$$

(Subtract slope volume of
the side next to the building)

$$= 76,896 - 7,776 - 3,362$$

$$= 65,758 \text{ ft}^3$$

$$= 2,435 \text{ yd}^3$$

Total volume of SIX (6) underground tanks : 117 yd³

Actual bank volume of soil excavated and disposed of :

$$2,435 - 117 = 2,318 \text{ yd}^3$$

Actual loose cubic yards of soil disposed at

B&J and Forward Landfills : 3,239 Loose yd³

$$\text{Bulking factor} = \frac{3,239}{2,318} \approx 1.4$$

Project Notes

Woodward-Clyde



Subject: Backfill Volume Calculation

Project Name: 40th St UST

By: Xinggang Tong Date: 8/16/94

Project No.: 941114NA

Task No.: 4000 File No.: _____

Checked By: _____ Date: _____

Sheet 2 of 2

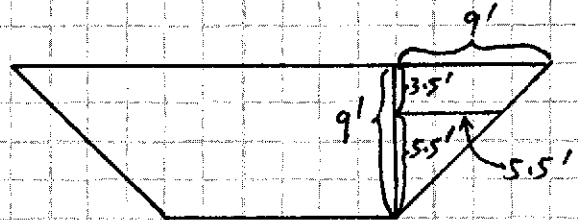
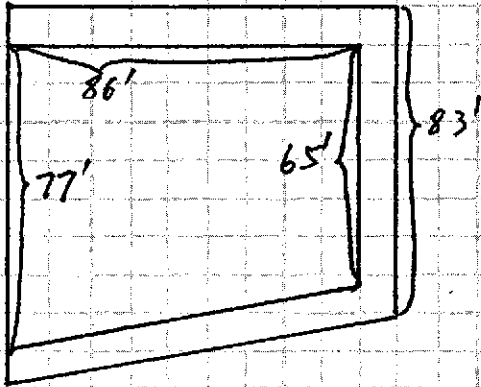

$$\begin{aligned} & (77' * 5.5' + 65' * 5.5') * \frac{1}{2} * 86' && \text{(base cube volume)} \\ & + 5.5' * 5.5' * 86' * \frac{1}{2} * 2 && \text{(side slope volume)} \\ & + 5.5' * 5.5' * 83' * \frac{1}{2} && \text{(side slope volume)} \\ & = 33,583 + 2,602 + 1,255 \\ & = 37,440 \text{ ft}^3 \\ & = 1,387 \text{ yd}^3 \leftarrow \text{Backfill Volume.} \end{aligned}$$

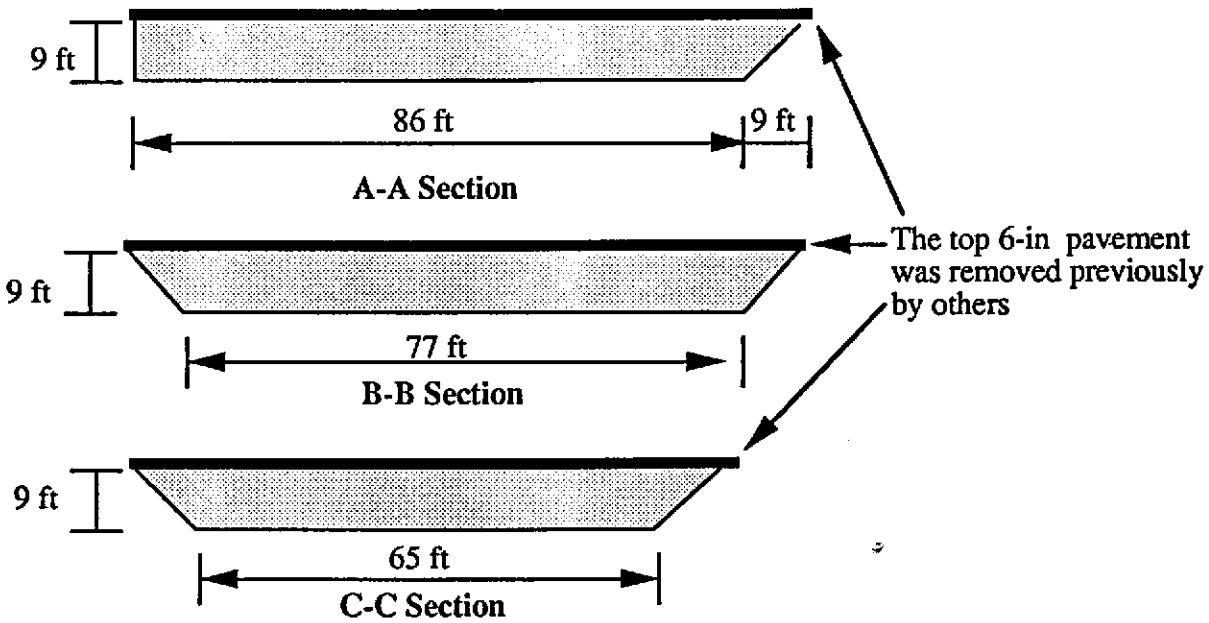
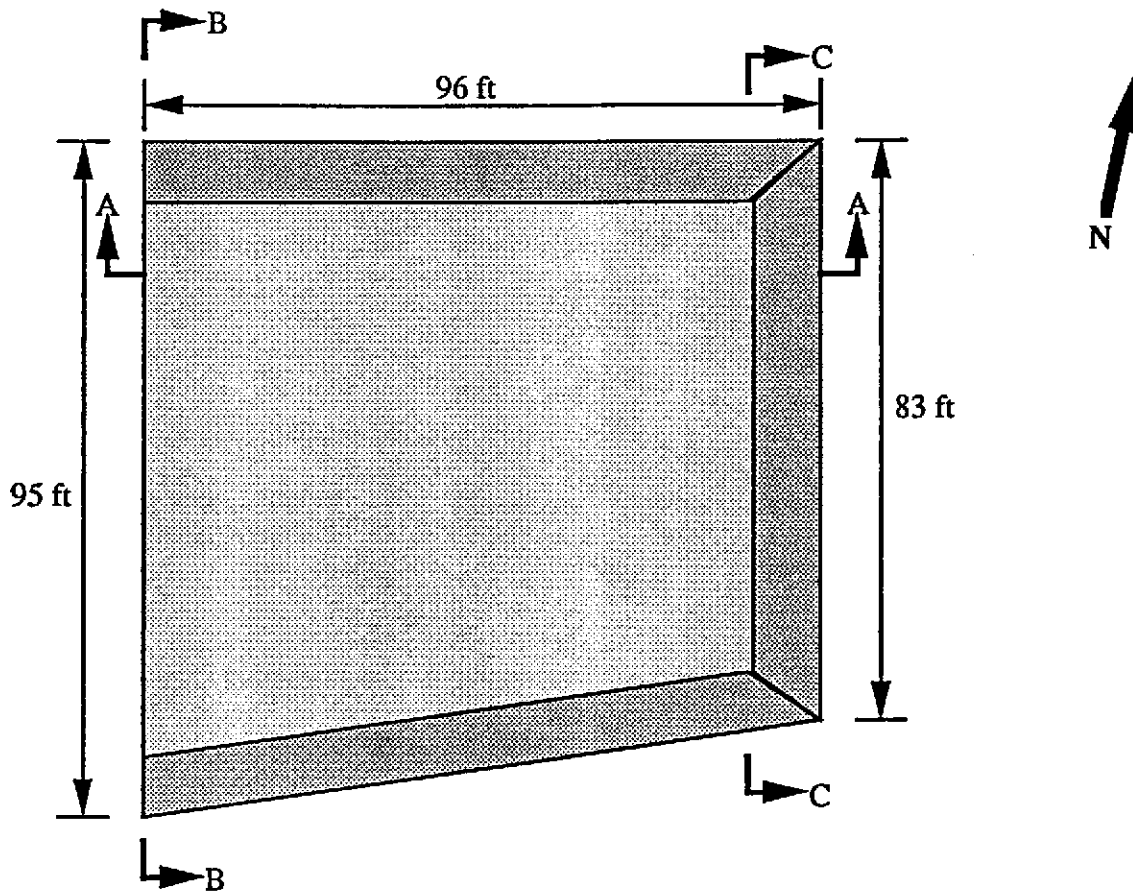

| | | | |
|-----------------------------------|--|---|--|
| Project No. 941114NA | CITY OF EMERYVILLE REDEVELOPMENT AGENCY | RECORDED DIMENSIONS AFTER EXCAVATION 40th Street UST at 4000 San Pablo Avenue | |
| Woodward-Clyde Consultants | | | |

APPENDIX E
CONFIRMATION SOIL SAMPLING IN EXCAVATION AREA

APPENDIX E.1
ACHA'S INSPECTION REPORT

white -env.health
 yellow -facility
 pink -files

ALAMEDA COUNTY, DEPARTMENT OF ENVIRONMENTAL HEALTH

80 Swan Way, #200
 Oakland, CA 94621
 (415) 271-4320

Hazardous Materials Inspection Form

II, III

Site ID # 567 Site Name Farmer Celis Station Today's Date 8/15/94

II.A BUSINESS PLANS (Title 19)

- 1. Immediate Reporting 2703
- 2. Bus. Plan Stds. 25503(b)
- 3. RR Cars > 30 days 25803.7
- 4. Inventory Information 25504(a)
- 5. Inventory Complete 2730
- 6. Emergency Response 25504(b)
- 7. Training 25504(c)
- 8. Deficiency 25505(a)
- 9. Modification 25505(b)

II.B ACUTELY HAZ. MATLS

- 10. Registration Form Filed 25533(a)
- 11. Form Complete 25533(b)
- 12. RMPP Contents 25534(c)
- 13. Implement Sch. Req'd? (Y/N)
- 14. OffSite Conseq. Assess. 25524(c)
- 15. Probable Risk Assessment 25534(d)
- 16. Persons Responsible 25534(e)
- 17. Certification 25534(f)
- 18. Exemption Request? (Y/N) 25536(b)
- 19. Trade Secret Requested? 25538

III. UNDERGROUND TANKS (Title 23)

- 1. Permit Application 25284 (H&S)
- 2. Pipeline Leak Detection 25292 (H&S)
- 3. Records Maintenance 2712
- 4. Release Report 2651
- 5. Closure Plans 2670
- 6. Method
 - 1) Monthly Test
 - 2) Daily Vadose Semi-annual groundwater One time sols
 - 3) Daily Vadose One time sols Annual tank test
 - 4) Monthly Groundwater One time sols
 - 5) Daily Inventory Annual tank testing Cont pipe leak det Vadose/gndwater mon.
 - 6) Daily Inventory Annual tank testing Cont pipe leak det
 - 7) Weekly Tank Gauge Annual tank testing
 - 8) Annual Tank Testing Daily Inventory
 - 9) Other
- 7. Precis Tank Test Date: 2643
- 8. Inventory Rec. 2644
- 9. Sol Testing 2646
- 10. Ground Water. 2647
- 11. Monitor Plan 2632
- 12. Access. Secure 2634
- 13. Plans Submit Date: 2711
- 14. As Built Date: 2635

General

Monitoring for Existing Tanks

New Tanks

Rev 8/88

Site Address 4000 San Pablo Avenue
 City Emeryville Zip 94608 Phone _____

MAX AMT stored > 500 lbs. 55 gal., 200 cft.?

Inspection Categories:

- I. Haz. Mat/Waste GENERATOR/TRANSPORTER
- II. Business Plans, Acute Hazardous Materials
- III. Underground Tanks

* Calif. Administration Code (CAC) or the Health & Safety Code (HS&C)

Comments:

On site - met King Lung Tong (WC)
 Overexcavated entire site to almost
 groundwater (approx 1ft above groundwater)

Total of 22 soil samples collected
 for verification - 6 bottom samples
 (selected hot areas) & 16 sidewall
 samples.

Free product observed in area with
 groundwater - appears that most of
 the remaining contamination at
 soil/water interface.

Because of the extent of soil groundwater
 contamination - the site requires
 remediation of the remaining
 contamination left in place.

No hydraulic lift found during
 overexcavation - only the foundation
 (concrete) was present & removed.

Backfill with clean fill over

II, III

Contact: IGNACIO DAYRIT

Title: _____

Signature: 

Inspector: _____

Signature: 

APPENDIX E.2
FIELD SAMPLING NOTES

FIELD SAMPLING NOTES

Woodward-Clyde

Project Location: 4000 San Pablo Ave. @ 40th St. Emeryville Page 1 of 1
 Project Number: 941114NA Date: 8/15/94
 Task Number: 6000 Weather: hot, clear
 Sampled by: [Signature] Temperature: 100 °F
 Summary of Main Activities: collect soil samples on sidewalk, dig 1ft deep hole first, then hand auger collecting sample
 and bottom of excavation pit. Wind: calm

| Sample No. | Type | Date | Time | Field PID screening | Analyses requested | Notes |
|------------|------|---------|-------|----------------------|--------------------|---|
| E-1 | Soil | 8/15/94 | 11.20 | none, of not working | see | First one-ft soil was removed prior to sampling 6" above bottom, parallel to bottom & straight into side wall |
| E-2 | ↓ | ↓ | 11.35 | | chain of- | |
| E-3 | ↓ | ↓ | 11.50 | | custody | |
| E-4 | ↓ | ↓ | 12.05 | | forms | |
| S-1 | Soil | 8/15/94 | 12.20 | | | |
| S-2 | ↓ | ↓ | 12.40 | | | |
| S-3 | ↓ | ↓ | 13.00 | | | |
| S-4 | ↓ | ↓ | 13.45 | | | |
| W-1 | Soil | 8/15/94 | 14.50 | | | |
| W-2 | ↓ | ↓ | 15.25 | | | |
| W-3 | ↓ | ↓ | 15.50 | | | |
| W-4 | ↓ | ↓ | 16.10 | | | |
| N-1 | Soil | 8/15/94 | 13.55 | | | |
| N-2 | ↓ | ↓ | 14.10 | | | |
| N-3 | ↓ | ↓ | 14.25 | | | |
| N-4 | ↓ | ↓ | 14.40 | | | |
| B-C-1 | Soil | 8/15/94 | 16.30 | | removed | Water saturated |
| B-C-2 | ↓ | ↓ | 16.40 | | top 3-1/2 soil | Water saturated |
| B-C-3 | ↓ | ↓ | 16.50 | | | very moisture |
| B-D&G-1 | ↓ | ↓ | 17.00 | | | Water saturated |
| B-D-1 | ↓ | ↓ | 17.10 | | | Water saturated |
| B-G-1 | ↓ | ↓ | 17.15 | | | Water saturated |

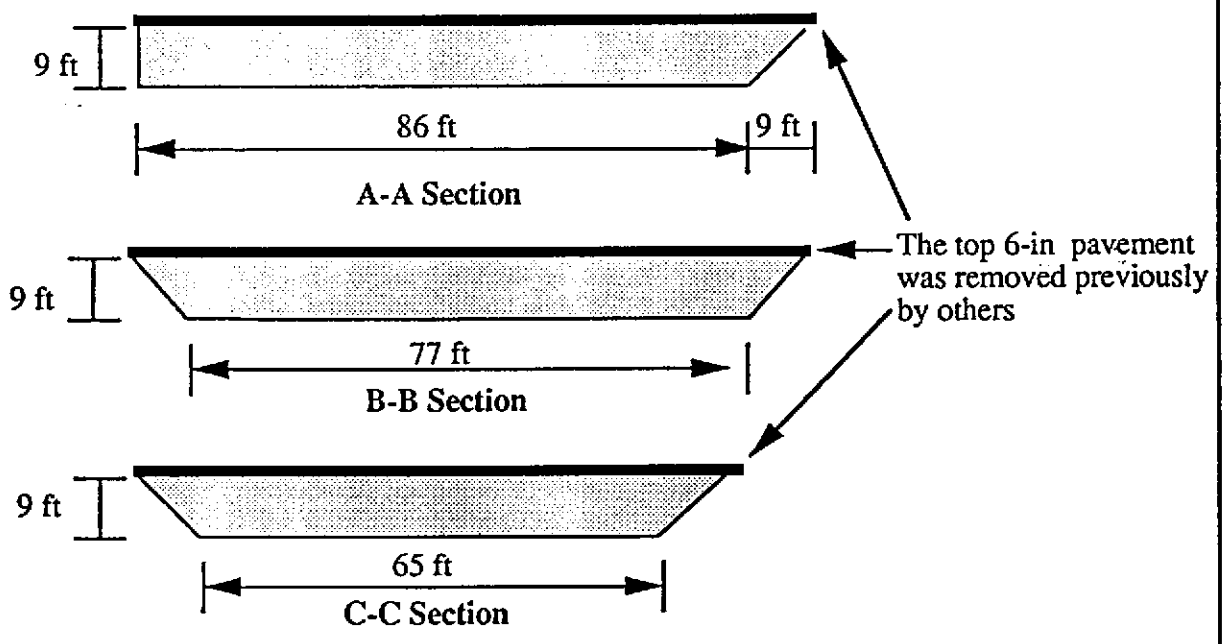
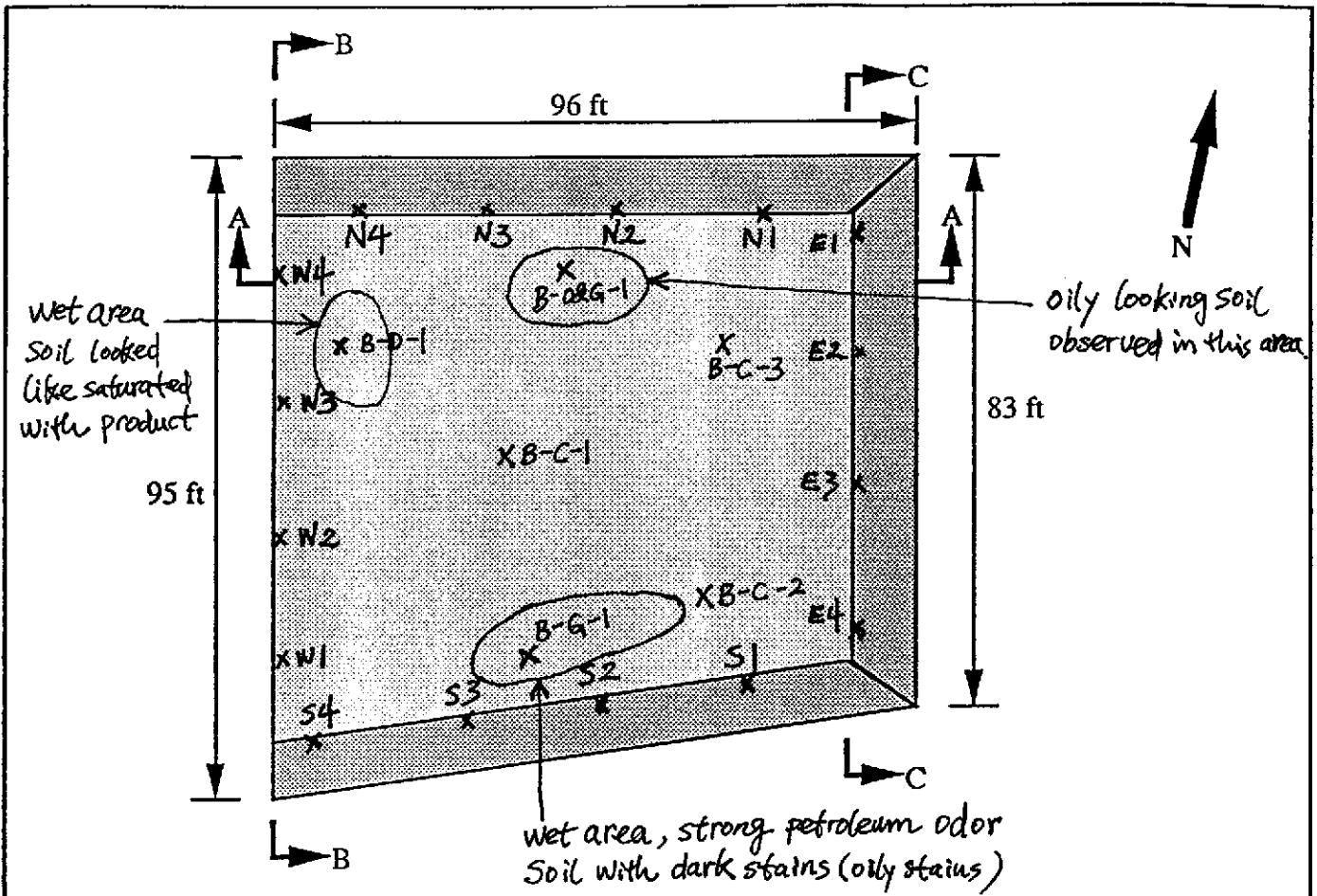

| | | | |
|----------------------------|--|---|--|
| Project No. 941114NA | CITY OF EMERYVILLE REDEVELOPMENT AGENCY | RECORDED DIMENSIONS AFTER EXCAVATION | |
| Woodward-Clyde Consultants | | | |

APPENDIX E.3
LABORATORY ANALYTICAL REPORT

QA/QC REVIEW OF ANALYTICAL DATA

The analytical results for this project were subjected to a thorough QA/QC review. This review included the following:

- Holding Time Review - Check for exceedences of prescribed holding times.
- Blank Review - Review blank analyses for evidence of potential contaminants.
- Blank, Matrix and Surrogate Spike Review - Review blank, matrix and surrogate spike recovery ranges and spike duplicate relative percent differences as a check for analytical accuracy and for extraction precision and accuracy.
- Elevated Detection Limits - Identify samples with elevated detection limits as a result of sample dilution or small sample volume.
- Hydrocarbon Identification - Identify samples for which the laboratory notes that the reported hydrocarbon concentration is the result of the presence of hydrocarbon fraction(s) not analyzed.

Each of the above QA/QC checks is discussed in detail in this section.

Holding Time Review The holding times for all samples for all analyses were reviewed. No samples exceeded prescribed holding times in this study.

Blank Review The results of the method blank analyses showed no target analytes detected.

Matrix Spikes, Blank Spikes, Surrogate Spikes and Spike Duplicates With the exceptions discussed below, the matrix, blank and surrogate spike recovery ranges for samples for this project were within laboratory-established control ranges, indicating acceptable analytical accuracy. Organic recoveries ranged from 81% to 117%. Inorganic recoveries ranged from 96% to 108%. The matrix spike duplicate recovery RPDs ranged from 0% to 8% and were within control ranges. The RPDs indicate acceptable analytical precision.

Surrogate spike recoveries for diesel analyses of three samples (W-1, W-4, and B-O&G-1) were reported slightly above control limit (131% to 157% relative to an upper control limit of 120%). Results reported as diesel for these samples may be slightly biased high and should be used as estimates.

Surrogate spike recoveries for gasoline/BTEX analyses were consistently high, ranging from 98% to 420%. The laboratory reported that an unknown compound was co-eluting with the surrogate, elevating the observed concentrations. However, the laboratory also reported that internal standard recoveries were within control limits and the reported MS/MSD recoveries were also in control. The internal standard and MS/MSD data indicate that the co-elution affected the observed surrogate concentrations but likely did not impact the observed results for gasoline and BTEX. Therefore, the data should be used as reported, with no qualification.

Elevated Detection Limits Analytical results for analyses were reported as not detected (ND) with an elevated detection limit. Elevated detection limits were the result of dilutions necessary to eliminate matrix interference or due to high target analyte concentrations. Specific samples and dilution factors include:

| Sample | Analysis | Dilution Factor |
|--------|----------|-----------------|
| B-G-1 | diesel | 10:1 |
| S-4 | BTEX | 100:1 |
| N-4 | BTEX | 20:1 |
| W-3 | BTEX | 2:1 |
| W-4 | BTEX | 10:1 |
| S-3 | BTEX | 26:1 |
| B-G-1 | BTEX | 100:1 |

No other results were reported as not detected with an elevated detection limit.

Analyte Identification The laboratory reported that the results reported as diesel for samples E-2, E-4, S-2, N-1, N-2, B-C-2, and B-C-3 were not representative of diesel, did not display a hydrocarbon-type fingerprint, but were present in the diesel range and so were quantified as diesel. These results should not be used as diesel concentrations as they are likely false positives.

In summary, the QA/QC review indicated that the analytical results were of acceptable quality.

CHROMALAB, INC.

Environmental Services (SDB)

August 24, 1994

WOODWARD-CLYDE/OAKLAND
500 12th St., Suite 100
Oakland, CA 94607

Submission #: 9408175

Attn: Xinggang Tong

RE: Analysis for project # 941114NA-6000.

REPORTING INFORMATION

Samples were received cold and in good condition on August 15, 1994. They were refrigerated upon receipt, and analyzed as described in the attached report. ChromaLab followed EPA or equivalent methods for all analyses reported.

No discrepancies were observed or difficulties encountered with the analysis.

SAMPLES TESTED IN THIS REPORT

| Client | Sample ID | Matrix | Date Collected | Sample # |
|--------|-----------|--------|-----------------|----------|
| | E-1 | SOIL | August 15, 1994 | 60239 |
| | S-1 | SOIL | August 15, 1994 | 60240 |
| | S-3 | SOIL | August 15, 1994 | 60241 |
| | E-3 | SOIL | August 15, 1994 | 60242 |
| | E-2 | SOIL | August 15, 1994 | 60243 |
| | E-4 | SOIL | August 15, 1994 | 60244 |
| | S-2 | SOIL | August 15, 1994 | 60245 |
| | S-4 | SOIL | August 15, 1994 | 60246 |
| | N-1 | SOIL | August 15, 1994 | 60247 |
| | N-2 | SOIL | August 15, 1994 | 60248 |
| | N-3 | SOIL | August 15, 1994 | 60249 |
| | N-4 | SOIL | August 15, 1994 | 60250 |
| | W-1 | SOIL | August 15, 1994 | 60251 |
| | W-2 | SOIL | August 15, 1994 | 60252 |
| | W-3 | SOIL | August 15, 1994 | 60253 |
| | W-4 | SOIL | August 15, 1994 | 60254 |
| | B-C-1 | SOIL | August 15, 1994 | 60255 |
| | B-C-2 | SOIL | August 15, 1994 | 60256 |
| | B-C-3 | SOIL | August 15, 1994 | 60258 |
| | B-O&G-1 | SOIL | August 15, 1994 | 60260 |
| | B-D-1 | SOIL | August 15, 1994 | 60261 |
| | B-G-1 | SOIL | August 15, 1994 | 60262 |

Jill Thomas
Quality Assurance Officer

Eric Tam
Laboratory Director

CHROMALAB, INC.

Environmental Services (SDB)

August 19, 1994

Submission #: 9408175

WOODWARD-CLYDE/OAKLAND

Atten: Xinggang Tong

Project: Not Provided
Received: August 15, 1994

Project#: 941114NA-6000

re: 18 samples for Oil & Grease analysis

Matrix: SOIL
Sampled: August 15, 1994
Method: STD Method 5520 E & F

Analyzed: August 18, 1994

| Sample # | Client Sample I.D. | Oil & Grease (mg/Kg) |
|--------------------|-----------------------|-------------------------|
| 60243 | E-2 | N.D. |
| 60244 | E-4 | N.D. |
| 60245 | S-2 | N.D. |
| 60246 | S-4 | N.D. |
| 60247 | N-1 | N.D. |
| 60248 | N-2 | N.D. |
| 60249 | N-3 | N.D. |
| 60250 | N-4 | 160 |
| 60251 | W-1 | N.D. |
| 60252 | W-2 | N.D. |
| 60253 | W-3 | N.D. |
| 60254 | W-4 | 150 |
| 60255 | B-C-1 | N.D. |
| 60256 | B-C-2 | N.D. |
| 60258 | B-C-3 | N.D. |
| 60260 | B-O&G-1 | N.D. |
| 60261 | B-D-1 | 15000 |
| 60262 | B-G-1 | 120 |
| Blank | | N.D. |
| Spike Recovery | | 92% |
| Dup Spike Recovery | | 88% |
| Reporting Limit | | 50 |

ChromaLab, Inc.

Carolyn M. House
Analyst

Ali Kharrazi
Organic Manager

gg

OIL & GREASE-QUALITY CONTROL

August 23, 1994

Submission #: 9408175

Client: WOODWARD-CLYDE/OAKLAND

Attn: Xinggang Tong

Project: N/A
Method: EPA 5520 E&F

Project #: 941114NA-6000
Matrix: SOIL

MS/MSD

Client Sample ID Spiked: W-4

| PARAMETER | UNITS | SAMPLE RESULT | SPIKE CONC | SPIKED SAMPLE RESULT | % REC | DUP SPIKE RESULT | DUP SPIKE %REC | % RPD | RPD LIMIT |
|--------------|-------|---------------|------------|----------------------|-------|------------------|----------------|-------|-----------|
| OIL & GREASE | mg/Kg | 152 | 400 | 521 | 92 | 505 | 88 | 4.4 | 20 |

BLANK RESULT:

| PARAMETER | UNITS | BLANK RESULT |
|--------------|-------|--------------|
| OIL & GREASE | mg/Kg | N.D. |

% Recovery = (Spike Sample Result-Sample Result)*100/Spike Concentration
RPD (Relative % Difference) = (Spike Result-Duplicate Result)*100/Average Result

CHROMALAB, INC.

Environmental Services (SDB)

August 22, 1994

Submission #: 9408175

WOODWARD-CLYDE/OAKLAND

Revised August 29, 1994

Atten: Xinggang Tong

Project: Not Provided
Received: August 15, 1994

Project#: 941114NA-6000

re: 18 samples for Diesel analysis

Matrix: SOIL
Sampled: August 15, 1994
Method: EPA 3550/8015

Analyzed: August 16-22, 1994

| Sample # | Client Sample ID | Diesel (mg/Kg) |
|----------|---------------------|--------------------|
| 60243 | E-2 | 2.0 ^a |
| 60244 | E-4 | 5.2 ^a |
| 60245 | S-2 | 60 ^a |
| 60246 | S-4 | 25 |
| 60247 | N-1 | 21 ^a |
| 60248 | N-2 | 10 ^a |
| 60249 | N-3 | 96 |
| 60250 | N-4 | 310 |
| 60251 | W-1 | N.D. |
| 60252 | W-2 | 34 |
| 60253 | W-3 | 180 |
| 60254 | W-4 | 500 |
| 60255 | B-C-1 | 68 |
| 60256 | B-C-2 | 75 ^a |
| 60258 | B-C-3 | 29 ^a |
| 60260 | B-O&G-1 | 160 |
| 60261 | B-D-1 | 18000 ^b |
| 60262 | B-G-1 | N.D. ^c |

a - Hydrocarbon found in diesel range quantified as diesel.

b - Detection limit equals 200 mg/Kg due to dilution.

c - Detection limit equals 10 mg/Kg due to dilution.

| | |
|----------------------|------|
| Blank | N.D. |
| Blank Spike Recovery | 101% |
| Reporting Limit | 1.0 |

ChromaLab, Inc.

Sirirat Chullakorn

Sirirat Chullakorn
Analytical Chemist

Ali Kharrazi
Ali Kharrazi
Organic Manager

CHROMALAB, INC.

Environmental Services (SDB)

DIESEL-QUALITY CONTROL page 2

August 23, 1994

Submission #: 9408175

WOODWARD-CLYDE/OAKLAND

Attn: Xinggang Tong

Project #: 94114NA-6000

Method: EPA 3550/8015

SURROGATE RECOVERIES **

| Client | | o-Terphenyl |
|-------------|---------|-------------|
| Sample ID | | % |
| 60243 | E-2 | 91 |
| 60244 | E-4 | 103 |
| 60245 | S-2 | 100 |
| 60246 | S-4 | 94 |
| 60247 | N-1 | 92 |
| 60248 | N-2 | 92 |
| 60249 | N-3 | 98 |
| 60250 | N-4 | 101 |
| 60251 | W-1 | 131* |
| 60252 | W-2 | 99 |
| 60253 | W-3 | 117 |
| 60254 | W-4 | 157* |
| 60255 | B-C-1 | 110 |
| 60256 | B-C-2 | 95 |
| 60258 | B-C-3 | 82 |
| 60260 | B-O&G-1 | 136* |
| 60261 | B-D-1 | N/A |
| 60262 | B-G-1 | 84 |
| Blank | | 101 |
| Blank Spike | | 101 |

* High surrogate recovery possibly due to matrix interferences.

** MS/MSD not reported due to matrix interferences.

CHROMALAB, INC.

Environmental Services (SDB)

August 22, 1994

Submission #: 9408175

WOODWARD-CLYDE/OAKLAND

Atten: Xinggang Tong

Project #: 941114NA-6000

Received: August 15, 1994

re: 22 soil samples for Gasoline and BTEX analysis

Matrix: SOIL

Sampled: August 15, 1994

Analyzed: August 17, 1994

Method : EPA 5030/8015/8020

RESULTS:

| Client Sample I.D. | Sample # | Gasoline (mg/Kg) | Benzene (µg/Kg) | Toluene (µg/Kg) | Ethyl Benzene (µg/Kg) | Total Xylenes (µg/Kg) |
|--------------------------|-------------|---------------------|--------------------|--------------------|-----------------------------|-----------------------------|
| E-1 | 60239 | 240 ^c | 330 ^c | 3500 ^c | 3400 ^c | 16000 ^c |
| S-1 | 60240 | 800 ^a | 1700 ^a | 6000 ^a | 9900 ^a | 41000 ^a |
| S-3 | 60241 | 730 ^f | 1400 ^f | N.D. ^f | 11000 ^f | 1700 ^f |
| E-3 | 60242 | 660 ^b | 2900 ^b | 18000 ^b | 9200 ^b | 46000 ^b |
| E-2 | 60243 | 170 ^c | 810 ^c | 3400 ^c | 1800 ^c | 8900 ^c |
| E-4 | 60244 | 380 ^a | 2600 ^a | 12000 ^a | 4900 ^a | 24000 ^a |
| S-2 | 60245 | 430 ^a | 400 ^a | 200 ^a | 4000 ^a | 12000 ^a |
| S-4 | 60246 | 560 ^b | N.D. ^b | N.D. ^b | 5600 ^b | 13000 ^b |
| N-1 | 60247 | 920 ^b | 2600 ^b | 21000 ^b | 11000 ^b | 57000 ^b |
| N-2 | 60248 | 250 ^d | 97 ^d | 830 ^d | 2500 ^d | 11000 ^d |
| N-3 | 60249 | 390 ^c | 380 ^c | 3000 ^c | 3600 ^c | 17000 ^c |
| N-4 | 60250 | 85 ^c | 160 ^c | N.D. ^c | 1000 ^c | 1300 ^c |
| W-1 | 60251 | N.D. | N.D. | N.D. | N.D. | N.D. |
| W-2 | 60252 | 230 ^c | 340 ^c | 610 ^c | 2300 ^c | 6900 ^c |
| W-3 | 60253 | 20 ^g | 12 ^g | N.D. ^g | 29 ^g | 43 ^g |
| W-4 | 60254 | 80 ^d | N.D. ^d | 73 ^d | 260 ^d | 990 ^d |

- a Reporting limit for BTEX=250 ug/kg & Gas=50 mg/kg due to dilution needed
b Reporting limit for BTEX=500 ug/kg & Gas=100 mg/kg due to dilution needed
c Reporting limit for BTEX=100 ug/kg & Gas=20 mg/kg due to dilution needed
d Reporting limit for BTEX=50 ug/kg & Gas=10 mg/kg due to dilution needed
e Reporting limit for BTEX=1000 ug/kg & Gas=200 mg/kg due to dilution needed
f Reporting limit for BTEX=130 ug/kg & Gas=25 mg/kg due to dilution needed
g Reporting limit for BTEX=10 ug/kg & Gas=2 mg/kg due to dilution needed
h Reporting limit for BTEX=80 ug/kg & Gas=16 mg/kg due to dilution needed

(Continued on next page)

CHROMALAB, INC.

Environmental Services (SDB)

Page 2 of 2
Submission #: 9408175

August 22, 1994

WOODWARD-CLYDE/OAKLAND

Atten: Xinggang Tong

Project #: 941114NA-6000
Received: August 15, 1994

re: 22 soil samples for Gasoline and BTEX analysis

Matrix: SOIL
Sampled: August 15, 1994 Analyzed: August 17, 1994
Method : EPA 5030/8015/8020

RESULTS:

| Client Sample I.D. | Sample # | Gasoline (mg/Kg) | Benzene (µg/Kg) | Toluene (µg/Kg) | Ethyl Benzene (µg/Kg) | Total Xylenes (µg/Kg) |
|----------------------|----------|-------------------|-------------------|--------------------|-----------------------|-----------------------|
| B-C-1 | 60255 | 260 ^h | 81 ^h | 110 ^h | 2000 ^h | 8400 ^h |
| B-C-2 | 60256 | 1000 ^a | 2400 ^a | 10000 ^a | 11000 ^a | 49000 ^a |
| B-C-3 | 60258 | 690 ^e | 2200 ^e | 15000 ^e | 7300 ^e | 39000 ^e |
| B-0&G-1 | 60260 | 490 ^c | 2400 ^c | 9900 ^c | 6300 ^c | 27000 ^c |
| B-D-1 | 60261 | 650 ^c | 3800 ^c | 1700 ^c | 8100 ^c | 17000 ^c |
| B-G-1 | 60262 | 540 ^b | 640 ^b | N.D. ^b | 6500 ^b | 12000 ^b |
| Blank | | N.D. | N.D. | N.D. | N.D. | N.D. |
| Blank Spike Recovery | | 116% | 86% | 100% | 95% | 96% |
| Reporting Limit | | 1.0 | 5.0 | 5.0 | 5.0 | 5.0 |

- a Reporting limit for BTEX=250 ug/kg & Gas=50 mg/kg due to dilution needed
- b Reporting limit for BTEX=500 ug/kg & Gas=100 mg/kg due to dilution needed
- c Reporting limit for BTEX=100 ug/kg & Gas=20 mg/kg due to dilution needed
- d Reporting limit for BTEX=50 ug/kg & Gas=10 mg/kg due to dilution needed
- e Reporting limit for BTEX=1000 ug/kg & Gas=200 mg/kg due to dilution needed
- f Reporting limit for BTEX=130 ug/kg & Gas=25 mg/kg due to dilution needed
- g Reporting limit for BTEX=10 ug/kg & Gas=2 mg/kg due to dilution needed
- h Reporting limit for BTEX=80 ug/kg & Gas=16 mg/kg due to dilution needed

ChromaLab, Inc

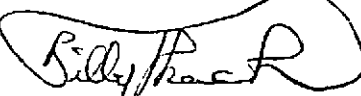
Billy Thach
Analytical Chemist

Ali Kharrazi
Organic Manager

jm

GAS/BTEX REPORT-QUALITY CONTROL

page 2

August 23, 1994

Submission #: 9408175

WOODWARD-CLYDE/OAKLAND

Project #: 94114NA-6000

Method: EPA 8015/8020

Matrix: SOIL

MS/MSD

Sample Spiked: W-1

| PARAMETER | UNITS | SAMPLE RESULT | SPIKE CONC | SPIKED SAMPLE RESULT | % REC | DUP SPIKE RESULT | DUP % REC | CONTROL LIMITS | RPD % | RPD LIMIT % |
|---------------|-------|---------------|------------|----------------------|-------|------------------|-----------|----------------|-------|-------------|
| Gasoline | mg/Kg | N.D. | ---- | ---- | --- | ---- | --- | 80/118 | ---- | ---- |
| Benzene | µg/Kg | N.D. | 25 | 22.1 | 88 | 20.4 | 82 | 80/127 | 8.0 | 20 |
| Toluene | µg/Kg | N.D. | 25 | 23.2 | 93 | 21.4 | 86 | 81/122 | 8.1 | 20 |
| Ethyl benzene | µg/Kg | N.D. | 25 | 22.6 | 90 | 21.4 | 86 | 81/119 | 5.5 | 20 |
| Total xylenes | µg/Kg | N.D. | 75 | 62.9 | 84 | 60.8 | 81 | 83/118 | 3.3 | 20 |

Blank Spike

| PARAMETER | UNITS | BLANK RESULT | SPIKE CONC | SPIKED SAMPLE RESULT | % REC |
|---------------|-------|--------------|------------|----------------------|-------|
| Gasoline | mg/Kg | ND | 5.056 | 5.849 | 116 |
| Benzene | µg/Kg | ND | 25 | 21.6 | 86 |
| Toluene | µg/Kg | ND | 25 | 25.1 | 100 |
| Ethyl benzene | µg/Kg | ND | 25 | 23.6 | 94 |
| Total xylenes | µg/Kg | ND | 75 | 71.6 | 95 |

% Recovery = (Spike Sample Result - Sample Result) * 100 / Spike Concentration
 RPD (Relative % Difference) = (Spike Result - Duplicate Result) * 100 / Average Result

CHROMALAB, INC.

Environmental Services (SDB)

GAS/BTEX REPORT-QUALITY CONTROL

page 3

August 23, 1994

Submission #: 9408175

WOODWARD-CLYDE/OAKLAND

Project #: 94114NA-6000

Method: EPA 8015/8020
Matrix: SOIL

Surrogate Recoveries

TRIFLUOROBENZENE

Sample ID

%

| | | |
|-------------|---------|------|
| 60239 | E-1 | 166* |
| 60240 | S-1 | 224* |
| 60241 | S-3 | 350* |
| 60242 | E-3 | 132* |
| 60243 | E-2 | 148* |
| 60244 | E-4 | 133* |
| 60245 | S-2 | 140* |
| 60246 | S-4 | 118 |
| 60247 | N-1 | 134* |
| 60248 | N-2 | 264* |
| 60249 | N-3 | 193* |
| 60250 | N-4 | 136* |
| 60251 | W-1 | 98 |
| 60252 | W-2 | 123* |
| 60253 | W-3 | 126* |
| 60254 | W-4 | 150* |
| 60255 | B-C-1 | 131* |
| 60256 | B-C-2 | 256* |
| 60258 | B-C-3 | 114 |
| 60260 | B-O&G-1 | 325* |
| 60261 | B-D-1 | 420* |
| 60262 | B-G-1 | 133* |
| W-1/MS | | 104 |
| W-1/MSD | | 107 |
| Blank | | 89 |
| Blank Spike | | 94 |

* Unknown compound co-eluted with trifluorobenzene.

CHROMALAB, INC.

Environmental Services (SDB)

August 29, 1994

Submission #: 9408175

WOODWARD-CLYDE/OAKLAND

Atten: Xinggang Tong

Project: 941114NA-6000

Received: August 15, 1994

re: 18 samples for Cadmium, Chromium, Lead, Nickel, and Zinc analysis.

Matrix: SOIL

Extracted: August 18, 1994

Sampled: August 15, 1994

Lab Run#: 3711

Analyzed: August 19, 1994

Method: EPA 3050/6010

| Spl # | CLIENT | SMPL ID | Cadmium (mg/Kg) | Chromium (mg/Kg) | Lead (mg/Kg) | Nickel (mg/Kg) | Zinc (mg/Kg) |
|-------|---------|---------|--------------------|---------------------|-----------------|-------------------|-----------------|
| 60227 | E-2 | | 1.4 | 18 | 4.3 | 34 | 26 |
| 60228 | E-4 | | 1.4 | 16 | 5.6 | 17 | 30 |
| 60229 | S-2 | | 2.3 | 28 | 7.0 | 39 | 43 |
| 60230 | S-4 | | 1.9 | 26 | 8.3 | 23 | 30 |
| 60231 | N-1 | | 2.1 | 26 | 6.1 | 37 | 40 |
| 60232 | N-2 | | 1.4 | 16 | 2.8 | 26 | 23 |
| 60233 | N-3 | | 2.6 | 20 | 7.3 | 25 | 40 |
| 60234 | N-4 | | 2.1 | 28 | 5.0 | 25 | 29 |
| 60235 | W-1 | | 2.2 | 27 | 8.0 | 34 | 45 |
| 60236 | W-2 | | 2.3 | 29 | 5.5 | 26 | 42 |
| 60237 | W-3 | | 1.4 | 19 | 5.6 | 21 | 27 |
| 60238 | W-4 | | 2.0 | 28 | 6.2 | 36 | 38 |
| 60239 | B-C-1 | | 2.3 | 31 | 6.7 | 29 | 37 |
| 60240 | B-C-2 | | 1.3 | 18 | 4.0 | 19 | 25 |
| 60241 | B-C-3 | | 1.8 | 27 | 5.2 | 25 | 33 |
| 60242 | B-O&G-1 | | 2.7 | 35 | 8.3 | 41 | 39 |
| 60243 | B-D-1 | | 1.9 | 27 | 7.0 | 25 | 27 |
| 60244 | B-G-1 | | 2.9 | 25 | 54 | 21 | 200 |

| | | | | | |
|------------------------|------|------|------|------|------|
| Reporting Limits | 0.05 | 0.5 | 0.5 | 0.5 | 0.25 |
| Blank Result | N.D. | N.D. | N.D. | N.D. | N.D. |
| Blank Spike Result (%) | 106 | 104 | 100 | 102 | 100 |

ChromaLab, Inc.

Doina Danet
Chemist

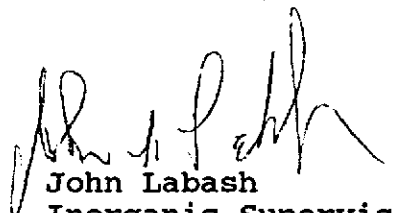
John Labash
Inorganic Supervisor

LUFT METALS-QUALITY CONTROL

Date: August 23, 1994

File number: 9408175

Client: WOODWARD-CLYDE/OAKLAND

Method: LUFT METALS

Project Name:

Method number: EPA 3050/6010

Matrix: Soil

MS/MSD

Sample Spiked: E-4

| PARAMETER | UNITS | SAMPLE RESULT | SPIKE CONC | SPIKED SAMPLE RESULT | % REC | DUP SPIKE RESULT | DUP % REC | CONTROL LIMITS | RPD | RPD LIMIT % |
|-----------|-------|---------------|------------|----------------------|-------|------------------|-----------|----------------|-----|-------------|
| Cadmium | mg/Kg | 1.4 | 0.05 | 0.0485 | 97 | 0.0495 | 99 | 70/110 | 4.1 | 20 |
| Chromium | mg/Kg | 15 | 0.2 | 0.218 | 109 | 0.216 | 108 | 70/123 | 0.9 | 20 |
| Lead | mg/Kg | 5.6 | 0.5 | 0.485 | 97 | 0.495 | 99 | 70/130 | 2.0 | 20 |
| Nickel | mg/Kg | 17 | 0.5 | 0.480 | 96 | 0.5 | 100 | 70/109 | 4.1 | 20 |
| Zinc | mg/Kg | 30 | 0.5 | 0.530 | 106 | 0.530 | 106 | 70/130 | 0 | 20 |

% Recovery = (Spike Sample Result-Sample Result)*100/Spike Concentration

RPD (Relative % Difference) = (Spike Result-Duplicate Result)*100/Average Result

CHROMALAB, INC.

Environmental Services (SDB)

LUFT METALS-QUALITY CONTROL

August 23, 1994

Submission #: 9408175

WOODWARD-CLYDE/OAKLAND

Attn: Xinngang Tong

Project: N/A

Project #: 94114NA-6000

Method: EPA 3050/6010

Matrix: Soil

METHOD BLANK:

| METALS | SPIKE % REC | Result mg/Kg | Reporting Limits mg/Kg |
|---------------|----------------|-----------------|---------------------------|
| Cadmium (Cd) | 105 | N.D. | 0.05 |
| Chromium (Cr) | 104 | N.D. | 0.50 |
| Lead (Pb) | 100 | N.D. | 0.50 |
| Nickel (Ni) | 102 | N.D. | 0.50 |
| Zinc (Zn) | 100 | N.D. | 0.25 |

REF 17011

SUBM #: 9408175
 CLIENT: W&C-OAK
 DUE: 08/22/94
 REF #: 17961

62

Woodward-Clyde Consultants

500 12th Street, Suite 100, Oakland, CA 94607-4014
 (510) 893-3600

| PROJECT NO. 941114NA-6000 | | | Sample Matrix (Soil, Water, Air) | ANALYSES | | | | | | | Number of Containers | REMARKS (Sample preservation, handling procedures, etc.) |
|--|-------|---------------------------|--|------------|--|------------|--|--|------------------------|----------------------------|----------------------|---|
| SAMPLERS (Signature) <i>[Signature]</i> | | | | EPA Method | EPA Method | EPA Method | EPA Method | TPH gas, BTEX | TPH diesel * | Oil & Grease ** | | |
| DATE | TIME | SAMPLE NUMBER | | | | | | | | | | |
| 8/15/94 | 11.20 | E-1 | Soil | | | | | X | | | | Regular Turnaround Questions/Results Xinggang Tong @510/874-3060 |
| | 11.35 | E-2 | ↓ | | | | | X | X | X | X | |
| | 11.50 | E-3 | ↓ | | | | | X | | | | |
| | 12.05 | E-4 | ↓ | | | | | X | X | X | X | |
| 8/15/94 | 12.20 | S-1 | Soil | | | | | X | | | | * : method 5520 DRF ** : Cd, Total Cr, Pb, Zn, Ni, five metals by ICP |
| | 12.40 | S-2 | ↓ | | | | | X | X | X | X | |
| | 13.00 | S-3 | ↓ | | | | | X | | | | |
| | 13.45 | S-4 | ↓ | | | | | X | X | X | X | |
| 8/15/94 | 13.55 | N-1 | Soil | | | | | X | X | X | X | |
| | 14.10 | N-2 | ↓ | | | | | X | X | X | X | |
| | 14.25 | N-3 | ↓ | | | | | X | X | X | X | |
| | 14.40 | N-4 | ↓ | | | | | X | X | X | X | |
| 8/15/94 | 14.50 | W-1 | Soil | | | | | X | X | X | X | |
| | 14.25 | W-2 | ↓ | | | | | X | X | X | X | |
| | 15.50 | W-3 | ↓ | | | | | X | X | X | X | |
| | 16.10 | W-4 | ↓ | | | | | X | X | X | X | |
| 8/15/94 | 16.50 | B-C-1 | Soil | | | | | X | X | X | X | |
| | 16.40 | B-C-2 | ↓ | | | | | X | X | X | X | |
| | 16.30 | B-C-3 | ↓ | | | | | X | X | X | X | |
| | 17.00 | B-C&G-1 | ↓ | | | | | X | X | X | X | |
| | 17.10 | B-D-1 | ↓ | | | | | X | X | X | X | |
| | 17.15 | B-G-1 | ↓ | | | | | X | X | X | X | |
| | | | | | | | | | | TOTAL NUMBER OF CONTAINERS | 22 | 2" by 6" brass Liners |
| RELINQUISHED BY : (Signature) <i>[Signature]</i> | | DATE/TIME 8/16/94 1750 | RECEIVED BY : (Signature) <i>[Signature]</i> | | RELINQUISHED BY : (Signature) <i>[Signature]</i> | | DATE/TIME 8/15/94 610 pm | RECEIVED BY : (Signature) <i>[Signature]</i> | | | | |
| METHOD OF SHIPMENT : Chromolab Courier | | | SHIPPED BY : (Signature) | | COURIER : (Signature) | | RECEIVED FOR LAB BY : (Signature) <i>[Signature]</i> | | DATE/TIME 8/15/1994 | | | |

APPENDIX F
SOIL COMPACTION REPORT

September 15, 1994
Project 941114NA

Mr. Ignacio Dayrit
Project Coordinator
City of Emeryville Redevelopment Agency
2200 Powell Street, 12th Floor
Emeryville, California 94608-1806

Subject: Soil Compaction Report
Celis Alliance Fuel Station at 4000 San Pablo Avenue
Emeryville, California

Dear Ignacio:

Woodward-Clyde is pleased to inform you that soil excavation, disposal and backfilling at the above referenced site were completed by September 1, 1994. This letter is to summarize the results of the on-site soil compaction testing performed by a Woodward-Clyde soil engineer.

The site occupies an area of approximately 100 feet by 100 feet. Soil was excavated from the entire area from surface down to groundwater elevation (approximately 9 feet below grade). Shoring was installed along the San Pablo Avenue side and a 1:1 (horizontal:vertical) slope was provided along the other three sides of the site. Excavated soil was disposed of at either Alta/B&J Landfill of Vacaville or Forward Landfill of Stockton, depending on the analytical results of various chemical constituents. Details of the soil excavation and disposal will be presented later in a separate report.

Material for backfilling was imported from the soil stockpiled near the south terminus of Shellmound Street, Emeryville, California, and owned by the City of Emeryville. Mr. Juan Arreguin from the City of Emeryville Public Works Department designated the soil for backfilling of this site. Mr. Arreguin also supplied the soil moisture-density data which was used for on-site compaction testing by Woodward-Clyde. The soil has the maximum dry density of 131.7 lb per cubic feet and the optimum moisture content of 11.8%. Woodward-Clyde did not perform laboratory compaction tests (ASTM D1557) on the soil, nor any other chemical analyses to certify the cleanness of the soil, for which the City of Emeryville is responsible.

Soil hauling and backfilling operations were subcontracted to Remedial Solutions Inc. (RSI) of Fremont, California. Mr. Phil Respass, a Woodward-Clyde soil engineer, was on site full-time to supervise field operations and to conduct compaction testing by nuclear probe method (ASTM D2922). Soil placement and compaction were conducted generally following the "Soil Excavation and Backfilling Plan" developed by Woodward-Clyde in June 1994 and approved by the City of Emeryville Redevelopment Agency. Soil was first transported to the site, adjusted for moisture content, spread uniformly across the site in a 8-inch lift, and then compacted with

941117NA.Soil Compaction Report
Page 2

a self-propelled sheepfoot roller (model CAT CP-558). Compaction tests were performed before the placement of next lift. Any lift that did not meet the minimum 90% relative compaction requirement was re-compacted and retested until the minimum compaction requirement was met. As requested by the City of Emeryville, the site was backfilled from the bottom of excavation to approximately 3 feet below the original grade. We understand that the City will grade the top 3 feet for the 40th Street construction. Daily field compaction records are attached to this letter report.

There were several wet areas on the bottom of the excavation due to groundwater intrusion, but most of the bottom appeared relatively dry. Based on the site conditions, a geotextile fabric liner on the bottom was deemed unnecessary. Soil was placed directly on the bottom and was successfully compacted to the above specifications.

It is our pleasure to be of service to the City of Emeryville Redevelopment Agency. Please do not hesitate to call me at (510)874-3060 for questions and comments.

Sincerely,



Xinggang Tong, Ph.D.
Project Manager

c: Xtong\Emeryvil.Prj\Compact.rpt

enclosures

+5104845638

KLEINFELDER-PLEAS.

F-400 T-040 P-007

MAY 09 '94 18:41

KLEINFELDER

RELATIVE COMPACTION TEST - NUCLEAR

Job Stamp

40th Street Overcrossing
EMERYVILLE, CA

Contract 10-2303-57

Test No. 3

Type of Material *Ben Clayey Silt & sand*

Material From

Impact by *Darcy*

Nuclear by *Dammann*

Date *4-18-94*

Date *4-15-94*

Show test location and area limits

Non Biased Plan No. 4

Gaug No. *10592*

Test Site elevation *± 14.2*

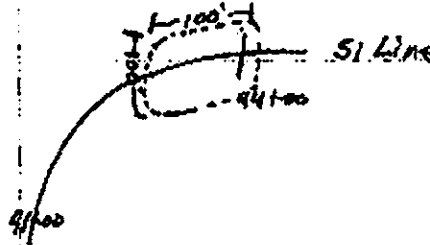

IN-PLACE TEST BY NUCLEAR

IMPACT TEST DATA #4636

| Site | Den. Ct. | "D.T. Std. Count Density | J | Initial Wet Weight of Test Specimen (Grams) | | | |
|------|----------|--------------------------|---|---|-----------------------------------|----------|------|
| 1 | 11181 | | | Specimen | 1 | 2 | 3 |
| 2 | 11180 | | | Water Adjustment | 0 | +2 | +4 |
| 3 | 11123 | | | Tamper Reading | 11.3 | 11.1 | 11.5 |
| 4 | | | | K Wet Density (gm/cc) | 2.14 | 2.02 | 2.14 |
| 5 | | | | K From Table 1 Test Method 216. Highest Density is Total Max. | | | |
| 6 | | | | L + 3/4" Agg. Adj. | SAMPLE FOR ROCK CORRECTION | | |
| 7 | | | | % + 3/4" (Q) Adj. | M Total Sample Wt. (gm) | | |
| 8 | | | | 20 or less 1.00 | N + 3/4" Wt. in Air (gm) | | |
| 9 | | | | 21-25 0.99 | O + 3/4" Wt. in Water (gm) | | |
| 10 | | | | 26-30 0.98 | P + 3/4" Vol. (cc) | (N-O) | |
| 11 | | | | 31-35 0.97 | Q % + 3/4" | 100(N/M) | |
| 12 | | | | 36-40 0.96 | R % - 3/4" | (100-Q) | |
| 13 | | | | 41-45 0.95 | S Density of + 3/4" | (N/P) | |
| 14 | | | | 46-50 0.94 | T % + 3/4" / Den. of + 3/4" (Q/S) | | |
| 15 | | | | Std. Count Moist. | U % - 3/4" Den. of - 3/4" (R/K) | | |
| 16 | | | | | V Sum of T and U | (T+U) | |
| 17 | | | | | W Adjusted Density gm/cc | (100/V) | |

| | | | |
|------------------------------|-------|-------------------------|--------|
| B Σ | 3484 | Σ | 480 |
| C X̄ | 1161 | C X̄ | 160 |
| CR(C.F) | 0.466 | CR(O/I) | 0.273 |
| D X̄ Den. gm/cc | 2.11 | H X̄ H ₂ O % | 0.25 |
| E X̄ Den. Corr. for Moist. ± | | I X̄ | 15.816 |

**E = D ± Diff. Bot. X̄ Moist. Fr. Common TM & H

| | | | | |
|-----------------------------|----|------------|------------|----|
| Percent Relative Compaction | 95 | Spec. | Individual | 95 |
| | | Moving Av. | | |

*E/K for 10% ≤ + 3/4"; E/W for > 10% + 3/4"

If Common Test Maximum is used (X) (R) or W *2.02* X H₂O =

From Tests Dated

Remarks:

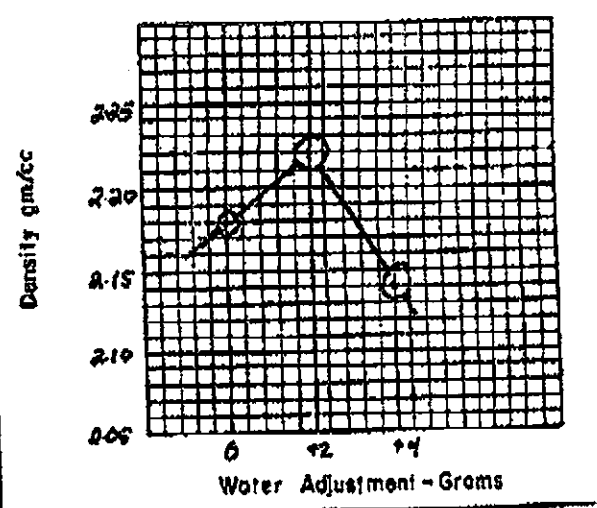

PROJECT NO. 94114NA/6000 PROJECT NAME 40th Street U.S.T.
 PROJECT LOCATION Emeryville, CA

DATE 8/17/94
 TIME ON JOB 7 AM TO 5 PM
 FIELD REPRESENTATIVE P. Respass

COMMENTS Sunny, warm
Arrived @ site @ 7AM. (2) end dumps bringing import soil on-site. 950B mixing as water added with firehose, then placing/spreading lift in excavation. Self-propelled sheepfoot roller (CAT CP-558) used to compact backfill (at least half dozen passes) Initial density testing indicated that relative compaction was slightly below 90%. Additional compaction done (at least 8-12 passes) and backfill retested. Results of retests indicated at least 90% rel. comp achieved. Random spot density testing indicated that at least 90% relative compaction was being achieved. Measurements of elevation are relative to FG which will be based on 3 ft below sidewalk grade next to San Pablo Ave.

| FIELD DENSITY TEST NO. | 1 | 2 | 3 | 4 | 5 | 6 | 7 | 8 | 9 |
|-------------------------------|-----------------------|-----------------------|-----------------------|-----------------------|----------------------|-----------------------|-----------------------|-----------------------|-----------------------|
| LOCATION | 20'N x 40'W of SE cor | 20'N x 25'E of SW cor | 20'N x 40'W of SE cor | 20'N x 25'E of SW cor | 40'N x 5'E of SW cor | 50'S x 20'E of NW cor | 20'S x 10'E of NW cor | 20'S x 40'E of NW cor | 40'S x 50'E of NW cor |
| ELEVATION, FEET | -3.5 | -3.5 | -3.5 | -3.5 | -4.0 | -4.0 | -4.0 | -4.5 | -4.0 |
| MOISTURE | | | | | | | | | |
| MOISTURE COUNT | 167 | 153 | 165 | 154 | 161 | 132 | 132 | 161 | 134 |
| MOISTURE RATIO | 0.344 | 0.315 | 0.340 | 0.317 | 0.332 | 0.272 | 0.272 | 0.332 | 0.276 |
| MOISTURE, PCF | 16.7 | 15.2 | 16.5 | 15.2 | 16.1 | 12.8 | 12.8 | 16.1 | 13.0 |
| DIRECT TRANSMISSION | | | | | | | | | |
| PROBE DEPTH, INCHES | 8" | → | → | → | → | → | → | → | → |
| DENSITY COUNT | 958 | 1005 | 912 | 895 | 926 | 956 | 890 | 939 | 1015 |
| DENSITY RATIO | 0.429 | 0.450 | 0.408 | 0.400 | 0.415 | 0.428 | 0.399 | 0.421 | 0.454 |
| NET DENSITY, PCF | 133.8 | 132.0 | 135.8 | 136.6 | 135.1 | 133.9 | 136.6 | 134.6 | 131.2 |
| DRY DENSITY, PCF | 117.1 | 116.8 | 119.3 | 121.4 | 119.0 | 121.1 | 123.8 | 118.5 | 118.7 |
| PERCENT MOISTURE | 14.3 | 13.0 | 13.8 | 12.5 | 13.5 | 10.6 | 10.3 | 13.6 | 10.9 |
| LABORATORY CURVE NO. | City of E. Import | → | → | → | → | → | → | → | → |
| MAX. DRY DENSITY, PCF | 131.7 | → | → | → | → | → | → | → | → |
| DEGREE OF COMPACTION, PERCENT | 89% | 89% | 91% | 92% | 90% | 92% | 94% | 90% | 90% |
| MIN COMPACTION REQUIRED | 90% | → | → | → | → | → | → | → | → |
| RETEST NO. | | | 1 | 2 | | | | | |
| STANDARD COUNT | Froter Model # 3401-B | | | MOISTURE 485 | | | DENSITY 2232 | | |
| SERIAL NO. | 6407 | | | | | | | SHEET NO. 2 | |

PROJECT NO. 941114NA/6000 PROJECT NAME 40th Street U.S.T.
 PROJECT LOCATION Emeryville, CA
 COMMENTS Foggy, cool AM / Sunny, warm PM

DATE 8/17/94
 TIME ON JOB 8:20 AM TO 11:50 AM
 2:20 PM 4:50 PM
 FIELD REPRESENTATIVE P. Respass

R.S.I. following the same procedure for backfilling the excavation as described in the 8/17 (sheet 2) report. Random spot density testing indicated relative compaction of at least 90% achieved. One test indicated NE corner area slightly below 90% rel. comp. Additional compaction applied & retest conducted. Result indicated rel. comp. of at least 90% achieved.

| | 8/17 | | | 8/18 | | | | | |
|-------------------------------|-----------------------|-----------------------|-----------------------|-----------------------|-----------------------|-----------------------|-----------------------|-----------------------|-----------------------|
| FIELD DENSITY TEST NO. | 10 | 11 | 12 | 13 | 14 | 15 | 16 | 17 | 18 |
| LOCATION | 30'S x 35'W of NE cor | 15'S x 15'W of NE cor | 20'N x 10'E of SW cor | 50'N x 20'E of SW cor | 30'S x 15'E of NW cor | 35'N x 50'W of SE cor | 25'S x 50'W of NE cor | 25'S x 25'W of NE cor | 20'S x 20'W of NE cor |
| ELEVATION, FEET | -4.5 | -5.0 | -2.5 | -2.5 | -3.0 | -3.0 | -3.0 | -3.5 | -3.5 |
| MOISTURE | | | | | | | | | |
| MOISTURE COUNT | 140 | 146 | 141 | 164 | 147 | 153 | 148 | 161 | 143 |
| MOISTURE RATIO | 0.288 | 0.301 | 0.292 | 0.340 | 0.305 | 0.317 | 0.307 | 0.334 | 0.297 |
| MOISTURE, PCF | 13.6 | 14.3 | 13.8 | 16.5 | 14.6 | 15.2 | 14.6 | 16.1 | 14.1 |
| DIRECT TRANSMISSION | | | | | | | | | |
| PROBE DEPTH, INCHES | 8" | → | → | → | → | → | → | → | → |
| DENSITY COUNT | 962 | 991 | 810 | 832 | 781 | 900 | 947 | 964 | 931 |
| DENSITY RATIO | 0.431 | 0.444 | 0.363 | 0.372 | 0.350 | 0.403 | 0.424 | 0.432 | 0.417 |
| WET DENSITY, PCF | 133.6 | 132.5 | 140.4 | 139.4 | 141.9 | 136.3 | 134.3 | 133.6 | 134.9 |
| DRY DENSITY, PCF | 120.0 | 118.2 | 126.6 | 122.9 | 127.3 | 121.1 | 119.7 | 117.5 | 120.8 |
| PERCENT MOISTURE | 11.3% | 12.1% | 10.9% | 13.4% | 11.5% | 12.6% | 12.2% | 13.7% | 11.7% |
| LABORATORY CURVE NO. | City of E Import | → | → | → | → | → | → | → | → |
| MAX. DRY DENSITY, PCF | 131.7 | → | → | → | → | → | → | → | → |
| DEGREE OF COMPACTION, PERCENT | 91% | 90% | 96% | 93% | 97% | 92% | 91% | 89% | 92% |
| MIN COMPACTION REQUIRED | 90% | → | → | → | → | → | → | → | → |
| RETEST NO. | | | | | | | | 4 | 17 |
| STANDARD COUNT | Troxler Model #3401-B | | | MOISTURE 485/482 | | | DENSITY 2232/2233 | | |
| SERIAL NO. | 6407 | | | 8/17 | 8/18 | | 8/17 | | SHEET NO. 3 |

PROJECT NO. 941114NA PROJECT NAME 40th St. U.S.T.
 PROJECT LOCATION Emeryville, CA

DATE 8/19/94
 TIME ON JOB
 7 AM 9 AM
 10:30 AM 4:30 PM
 FIELD REPRESENTATIVE
 P. Respess

COMMENTS Foggy, cool AM/Sunny, warm PM

R.S.I following same backfill procedure described previously. Random spot density testing indicated relative compaction of at least 90% achieved.

| FIELD DENSITY TEST | | | | | | | | | |
|-----------------------|-------------------------------|-----------------------|----------------------|--------------------------|-----------------------|-----------------------|-------------|--|--|
| TEST NO. | 19 | 20 | 21 | 22 | 23 | 24 | | | |
| LOCATION | 45'N x 35'W of SE cor | 25'N x 40'E of SW cor | 50'S x 7'E of NW cor | 15'S x 30'E of NW cor | 15'S x 35'W of NE cor | 25'S x 10'E of NW cor | | | |
| ELEVATION | -25 | -20 | -15 | -15 | -20 | -10 | | | |
| MOISTURE COUNT | 136 | 148 | 140 | 153 | 163 | 154 | | | |
| MOISTURE RATIO | 0.281 | 0.306 | 0.289 | 0.316 | 0.337 | 0.318 | | | |
| MOISTURE, PCF | 13.3 | 14.6 | 13.7 | 15.2 | 16.3 | 15.3 | | | |
| PROBE DEPTH | 8" | → | → | → | → | → | | | |
| DENSITY COUNT | 961 | 926 | 903 | 866 | 861 | 824 | | | |
| DENSITY RATIO | 0.431 | 0.415 | 0.405 | 0.388 | 0.386 | 0.370 | | | |
| WET DENSITY, PCF | 133.7 | 135.1 | 136.1 | 137.7 | 138.0 | 139.6 | | | |
| DRY DENSITY, PCF | 120.4 | 120.5 | 122.4 | 122.5 | 121.7 | 124.3 | | | |
| MOISTURE, % | 11.0% | 12.1% | 11.2 | 12.4% | 13.4% | 12.3% | | | |
| LAB. CURVE NO. | City of E Import | → | → | → | → | → | | | |
| MAX. DRY DENSITY, PCF | 131.7 | → | → | → | → | → | | | |
| OPTIMUM MOISTURE, % | | | | | | | | | |
| % COMPACTION | 91% | 91% | 93% | 93% | 92% | 94% | | | |
| % REQUIRED | 90% | → | → | → | → | → | | | |
| RETEST OF NO. | | | | | | | | | |
| STANDARD GAUGE COUNTS | MOISTURE COUNT 484 | | | DENSITY COUNT 2228 | | | | | |
| GAUGE SERIAL NO. | 6407 (Trolox Model) (#3401-B) | | | MOISTURE CORRECTION, PCF | | | SHEET NO. 4 | | |

PROJECT NO. 941114NA PROJECT NAME 40th St U.S.T.
 PROJECT LOCATION Emeryville, CA
 COMMENTS Cool, foggy

DATE 8/22/94
 TIME ON JOB 8:30 AM TO 9:30 AM
 _____ PM _____ PM
 FIELD REPRESENTATIVE
P. Respass

R.S.I placed & compacted the last lift on Sat 8/20. I arrived this AM to conduct density tests. Results indicate that relative compaction of at least 90% achieved. Finished grade is ± 3 ft below sidewalk grade next to San Pablo Ave.

| | | | | | | | | | |
|-------------------------------|--------------------|---------------------|-----------------|---------------------|---------------------|--|--|--|--|
| FIELD DENSITY TEST NO. | 25 | 26 | 27 | 28 | 29 | | | | |
| LOCATION | 15'x18'E of SW cor | 20'Sx15'E of NW cor | 36'Sx45'W of NE | 18'Sx15'W of NE cor | 30'Nx25'W of SE cor | | | | |
| ELEVATION, FEET | FG | FG | FG | FG | FG | | | | |
| MOISTURE | | | | | | | | | |
| MOISTURE COUNT | 149 | 143 | 146 | 137 | 142 | | | | |
| MOISTURE RATIO | 0.304 | 0.292 | 0.298 | 0.277 | 0.290 | | | | |
| MOISTURE, PCF | 14.6 | 13.8 | 14.2 | 13.2 | 13.8 | | | | |
| DIRECT TRANSMISSION | | | | | | | | | |
| PROBE DEPTH, INCHES | 8" | | | | | | | | |
| DENSITY COUNT | 966 | 982 | 910 | 1013 | 991 | | | | |
| DENSITY RATIO | 0.435 | 0.442 | 0.410 | 0.456 | 0.446 | | | | |
| WET DENSITY, PCF | 133.4 | 132.8 | 135.6 | 131.5 | 132.4 | | | | |
| DRY DENSITY, PCF | 118.8 | 119.0 | 121.4 | 118.3 | 118.6 | | | | |
| PERCENT MOISTURE | 12.3% | 11.6% | 11.7% | 11.1% | 11.6% | | | | |
| LABORATORY CURVE NO. | C14 of E Impact | | | | | | | | |
| MAX. DRY DENSITY, PCF | 131.7 | | | | | | | | |
| DEGREE OF COMPACTION, PERCENT | 90% | 90% | 92% | 90% | 90% | | | | |
| MIN COMPACTION REQUIRED | 90% | | | | | | | | |
| RETEST NO. | | | | | | | | | |

STANDARD COUNT Troxler Model #3401-B MOISTURE 490 DENSITY 2219

SERIAL NO. 6407 SHEET NO. 5