

RECEIVED

10:08 am, Jun 30, 2009

Alameda County
Environmental Health



June 25, 2009

VIA ALAMEDA COUNTY FTP SITE

Mr. Jerry Wickham
Hazardous Materials Specialist
Alameda County Environmental Health
1131 Harbor Bay Parkway, Suite 250
Alameda, CA 94502-6577

Re: **Groundwater Monitoring and Remediation Report – Second Quarter 2009**
Former Shell Service Station
1230 14th Street
Oakland, California
Fuel Leak Case No. RO0000433

Dear Mr. Wickham:

On behalf of property owner Andy Saberi, Pangea Environmental Services, Inc has prepared this *Groundwater Monitoring and Remediation Report – Second Quarter 2009*. The report describes groundwater monitoring, sampling, remediation progress and other site activities.

To help control project cost per Cleanup Fund request on October 23, 2008 and State Water Resources Control Board (RWQCB) Resolution No. 2009-0042, Pangea proposes to reduce the groundwater monitoring frequency on several site wells. Pangea's proposed groundwater monitoring program includes *semi-annual* monitoring of seven (7) key groundwater monitoring wells (second and fourth quarter of each year), plus annual monitoring of three (3) site wells (second quarter of each year). The proposed monitoring reductions and rationale are discussed below and shown in Table B in Appendix A. However, Pangea proposes to resume quarterly monitoring (as shown in Table A in Appendix A) upon startup of the approved remediation system to help evaluate remedial effectiveness and control remediation costs.

If you have any questions or comments, please call me at (510) 435-8664 or email briddell@pangeaenv.com.

Sincerely,
Pangea Environmental Services, Inc.

A handwritten signature in blue ink that reads "Bob Clark-Riddell".

Bob Clark-Riddell, P.E.
Principal Engineer

Attachment: *Groundwater Monitoring and Remediation Report – Second Quarter 2009*

cc: Andy Saberi, 1045 Airport Blvd., South San Francisco, California 94080
Denis Brown, Shell Oil Products US, 20945 S. Wilmington Avenue, Carson, CA 90810-1039
Ana Friel, Conestoga-Rovers & Assoc, 19449 Riverside Dr #230, Sonoma, CA (electronic copy to pcaldwell@croworld.com)
SWRCB Geotracker (electronic copy)

PANGEA Environmental Services, Inc.



**GROUNDWATER MONITORING AND REMEDIATION REPORT –
SECOND QUARTER 2009**

**Former Shell Service Station
1230 14th Street
Oakland, California
Fuel Leak Case No. RO0000433**

June 25, 2009

Prepared for:

Andy Saberi
1045 Airport Boulevard
South San Francisco, California 94080

Prepared by:

Pangea Environmental Services, Inc.
1710 Franklin Street, Suite 200
Oakland, California 94612

Written by:



Morgan Gillies
Project Manager

Bob Clark-Riddell, P.E.
Principal Engineer

PANGEA Environmental Services, Inc.

INTRODUCTION

On behalf of Andy Saberi, Pangea Environmental Services, Inc. (Pangea) performed groundwater monitoring and sampling during the current quarter at the subject site. The purpose of the monitoring and sampling is to evaluate dissolved contaminant concentrations and groundwater flow direction. The purpose of the remediation is to remove residual petroleum hydrocarbon from site soil and groundwater. The site location is shown on Figure 1. Current groundwater analytical results and elevation data are shown on Figure 2. Current and historical data are summarized on Table 1. Well construction details are summarized on Table 2.

SITE BACKGROUND

The former Shell-branded service station is located at the northeast corner of 14th Street and Union Street in Oakland, California (Figure 1). Currently, an abandoned one-story station building and a pump-island canopy occupy the site, and much of the property is paved except for the former UST excavation. Land use in the surrounding area is currently residential to the north, south, and east, and is commercial/industrial to the west and southwest. The site topography is essentially flat.

Site History

According to prior reports, the current site building was constructed in 1958 and gas station operations at the site reportedly began in 1958 and ceased in 1993. Petroleum hydrocarbons were first discovered in site soil near the underground storage tanks (USTs) during the completion of three borings at the site in February 1991. Four gasoline USTs and one waste oil storage tank were removed from the site on August 24, 1993. The current property owner, Mr. Andy Saberi, purchased the property in the mid 1980s.

Previous Environmental Work

Previous environmental work has included site assessment, a sensitive receptor evaluation/well survey, risk evaluation, two rounds of feasibility testing (in 2000 and 2006), and several remedial actions, including injection of oxygen releasing compound (ORC) into site wells in 1997, groundwater extraction (GWE) and dual-phase extraction (DPE) from 2002 to 2004, and hydrogen peroxide injection into site wells in 2003. Quarterly groundwater monitoring activities have been performed at the site since 1996.

In January 2008, Pangea submitted a *Draft Corrective Action Plan and Pilot Test Work Plan* (Draft CAP/Test Workplan) as required by Alameda County Environmental Health (ACEH). Following completion of the public-participation comment period, Pangea began implementation of the approved *Draft CAP/Test Workplan* in June 2008 by installing new remediation test wells, repairing damaged remediation wells, and destroying one remediation well. The *Well Installation and Destruction Report* dated October 6, 2008 details this remediation well work. In early July 2008, Pangea conducted the approved pilot testing using the newly installed remediation test wells to determine whether SVE or DPE would most effectively remove contaminants and capture hydrocarbon vapors resulting from air sparging. In the *SVE/DPE Pilot Test Report* dated October 7, 2008, Pangea recommended DPE/AS as the most effective remedial approach for the site. In a letter dated October 29, 2008, Alameda County Environmental Health (ACEH) approved implementation of DPE/AS remediation at the site. On June 15, 2009, the California UST Cleanup Fund completed a 5-year review of the claim and recommended implementation of site remediation.

GROUNDWATER MONITORING AND SAMPLING

On May 26, 2009, site monitoring wells were gauged for depth-to-water and inspected for separate-phase hydrocarbons (SPH) prior to collection of groundwater samples. Site wells were sampled according to the approved groundwater monitoring program shown in Appendix A. Well caps were removed from all monitoring wells and technicians allowed at least 15 minutes for water level equilibration before measuring depth to water.

Before well purging, the dissolved oxygen (DO) concentration was measured in each well. DO was measured by lowering a downwell sensor to the approximate middle of the water column (except well AS-1, where DO was measured above ground due to the 1-inch diameter casing preventing the DO probe from fitting down the well), and allowing the reading to stabilize during gentle height adjustment. Prior to sample collection, approximately three casing volumes of water were purged using disposable bailers, an electric submersible pump, check valve with tubing, or a peristaltic pump. During well purging, field technicians measured pH, temperature and conductivity. A groundwater sample was collected from each well with a disposable bailer, and decanted into the appropriate containers supplied by the analytical laboratory. Groundwater samples were labeled, placed in protective plastic bags, and stored on crushed ice at or below 4°C. All samples were transported under chain-of-custody to the State-certified analytical laboratory. Purge water was stored onsite in DOT-approved 55-gallon drums. Groundwater monitoring field data sheets, including purge volumes and field parameter measurements, are presented in Appendix B.

MONITORING RESULTS

Current and historical groundwater elevation data and analytical results are described below and summarized on Table 1. Groundwater samples were analyzed for total petroleum hydrocarbons as gasoline (TPHg), benzene, toluene, ethylbenzene, and xylenes (BTEX) and methyl tertiary butyl ether (MTBE) by EPA Method 8015Cm/8021B. Samples were analyzed by McCampbell Analytical, Inc., of Pittsburg, California, a State-certified laboratory. The laboratory analytical report is included in Appendix C.

Groundwater Flow Direction

Based on depth-to-water data collected on May 26, 2009, the groundwater flow direction at the site is approximately *northeastwards*, as shown on Figure 2. The inferred groundwater flow direction is generally consistent with previous monitoring results. The apparent groundwater mounding observed during the February 2009 monitoring event has subsided. Depth-to-water and groundwater elevation data are presented in Table 1.

Hydrocarbon Distribution in Groundwater

No SPH were observed in any of the site wells. Hydrocarbons were not detected in wells MW-2 through MW-4 or MW-6. The maximum TPHg and benzene concentrations detected this quarter were in source area well MW-5R (15,000 µg/L and 3,500 µg/L, respectively), the replacement well for damaged well MW-5. Hydrocarbon concentrations detected in wells MW-1, VW/MW-2, VW/MW-4, AS-1 and MW-5R decreased or were similar to last quarter's results. In general, hydrocarbon concentrations are within historic ranges and exhibit a stable to decreasing trend. Groundwater analytical data are included in Table 1 and on Figure 2.

Former remediation well VW/AS-1, which contained the highest TPHg concentration detected onsite to date (180,000 µg/L on December 6, 2007), was replaced with air sparge well AS-1 in the overdrilled borehole in June 2008. TPHg concentrations in well AS-1 this quarter were significantly lower (250 µg/L) than those previously detected in VW/AS-1. This difference in concentrations is likely due to the fact that well VW/AS-1 was screened from 6 to 15 ft and 17.5 to 19.5 ft bgs, while well AS-1 is screened deeper (22 to 25 ft bgs). Other newly installed remediation wells were not sampled this quarter.

Fuel Oxygenate Distribution in Groundwater

MTBE was not detected in any site wells this quarter. Historically, MTBE has been detected only sporadically in site wells. Since 2003, detected MTBE concentrations have been below the Maximum Contaminant Level (MCL) for drinking water of 13 µg/L, except for a concentration of 20 µg/L detected in well MW-5 in February 2008. This MTBE result could be a false positive result, but was not confirmed using EPA Method 8260. MTBE is not a primary constituent of concern at this site due to limited and sporadic (and potentially false) MTBE detections. MTBE concentrations are shown in Table 1 and on Figure 2.

REMEDIATION SUMMARY

Remediation Well Installation

Pangea submitted a *Draft Corrective Action Plan and Pilot Test Work Plan* (Draft CAP) on January 18, 2008, which was approved by ACEH following a public comment period in a letter dated June 5, 2008. On June 26 and 27, 2008, Pangea installed five new remediation wells, replaced one remediation well and one monitoring well, and destroyed one remediation well. Pangea also installed a soil vapor monitoring well between the existing site building and the northern property boundary. The *Well Installation and Destruction Report* dated October 6, 2008 details well installation and destruction activities. The locations of the remediation wells are shown on Figure 2.

Pilot Testing

On July 8 through July 11, 2008, Pangea conducted onsite pilot testing using a 300-cfm liquid ring blower assembly with a oxidizer and conducted the pilot test as proposed in the *Draft CAP/Test Workplan*. The objective of pilot testing was to determine whether SVE or DPE would be the more appropriate technique for removing hydrocarbons and capturing hydrocarbon vapors created by air sparging. Vacuum influence and water level measurements were collected during testing to confirm the appropriateness of the remediation well network. The *SVE/DPE Pilot Test Report* dated October 7, 2008 describes pilot testing procedures and results and recommended installation of a DPE/AS system.

DPE/AS System Installation

In a letter dated October 29, 2008, ACEH approved implementation of DPE/AS remediation at the site and requested system design drawings. The system design drawings were provided to ACEH on January 21, 2009 and approved in a letter dated February 6, 2009. On June 15, 2009, the California UST Cleanup Fund completed a 5-year review of the claim and recommended implementation of site remediation. Pangea has commenced system permitting and installation coordination.

OTHER SITE ACTIVITIES

Proposed Groundwater Monitoring Program Reductions

To help control project cost per Cleanup Fund request of October 23, 2008 and State Water Resources Control Board (RWQCB) Resolution No. 2009-0042, Pangea proposes to reduce the groundwater monitoring frequency to *semi-annual* and to reduce monitoring frequency for select upgradient wells to *annual*. These recommendations are based on our review of many years of monitoring data, which indicates that contaminant concentrations appear to be stable to decreasing in most groundwater wells despite the elevated concentrations in select wells. Pangea's proposed groundwater monitoring program is presented in Table B in Appendix A. However, Pangea proposes to resume *quarterly* monitoring (as shown in Table A in Appendix A) upon startup of the approved remediation system to help evaluate remedial effectiveness and control remediation costs.

The proposed *semi-annual* monitoring program in Table B includes the following:

- Semi-annual monitoring of seven (7) key groundwater monitoring wells (MW-1, MW-5R, MW-6, MW-7, AS-1, VW/MW-2 and VW/MW-4). These wells are source area and key downgradient wells. During each monitoring event Pangea will gauge depth to water in all groundwater monitoring wells (non-remediation wells) to evaluate groundwater flow conditions. Monitoring will be conducted in the second and fourth quarter of each year.
- Annual monitoring (second quarter of each year) of ten (10) site wells, including the 7 semi-annual wells and 3 additional wells (MW-2, MW-3 and MW-4). The additional wells for annual sampling have been consistently 'non detect' and are upgradient of the source area.
- All groundwater samples will be analyzed for TPHg/BTEX/MTBE by EPA Method 8015Cm/8021B.

Pangea will summarize groundwater monitoring activities and results in a groundwater monitoring report following completion of each future groundwater monitoring event.

ATTACHMENTS

Figure 1 – Vicinity Map

Figure 2 – Groundwater Elevation and Hydrocarbon Concentration Map

Table 1 – Groundwater Elevation and Analytical Data

Table 2 – Well Construction Details

Appendix A – Groundwater Monitoring Program

Appendix B – Groundwater Monitoring Field Data Sheets

Appendix C – Laboratory Analytical Report

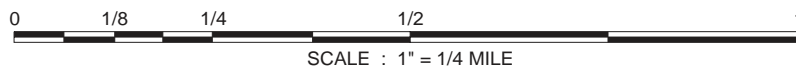
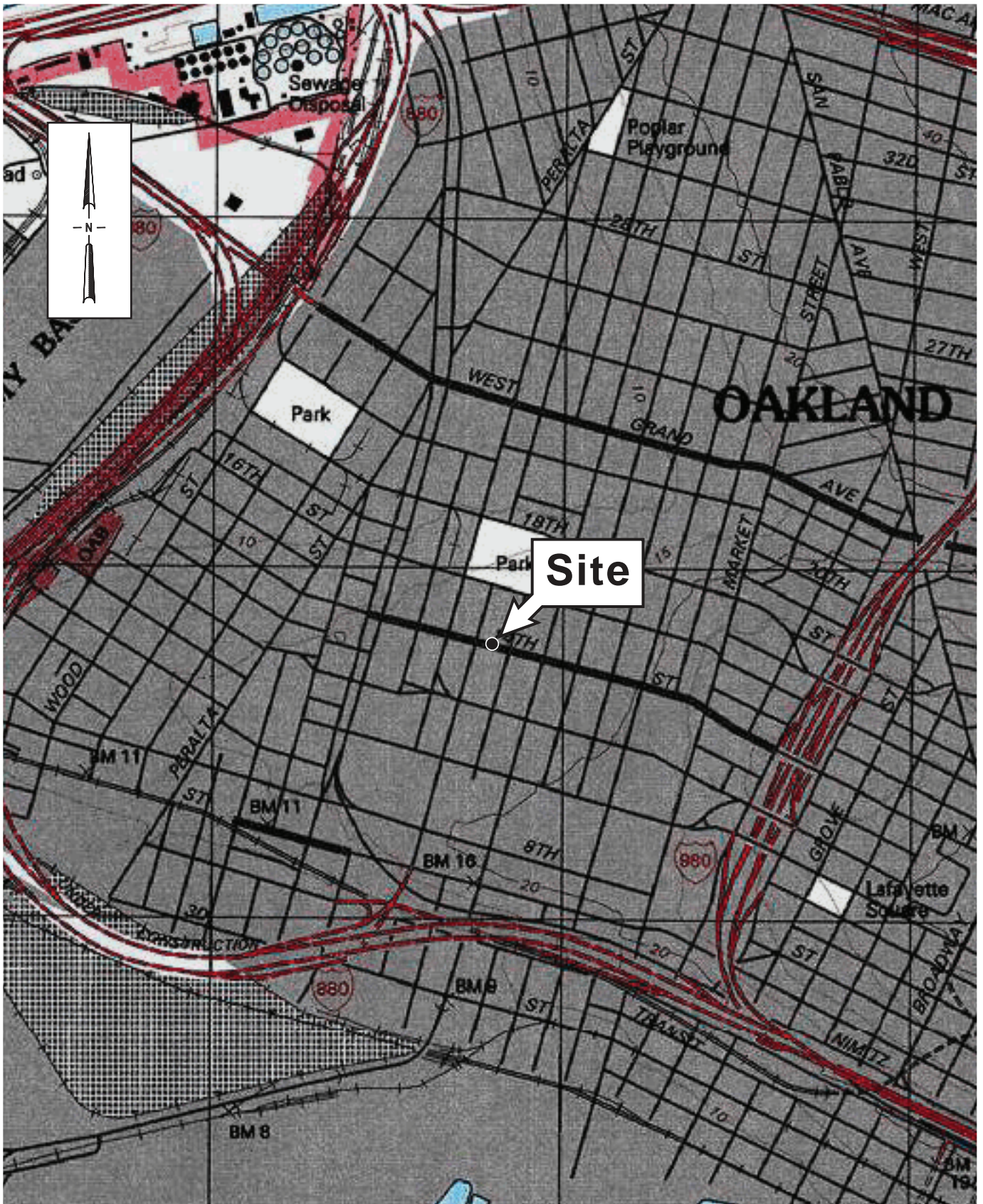

Figure

1

Former Shell Service Station

1230 14th Street
Oakland, California



Vicinity Map

UNION STREET

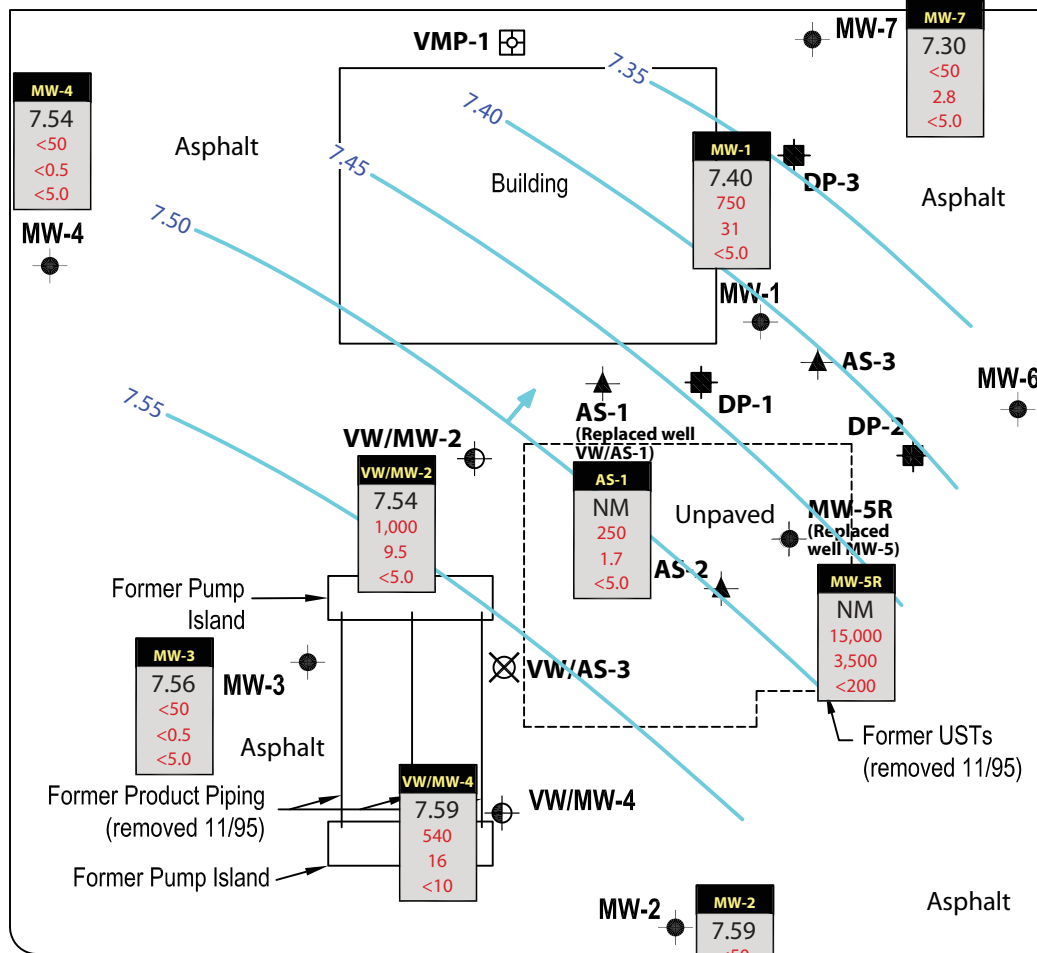

EXPLANATION

- Groundwater monitoring well
- Combination soil vapor extraction well/monitoring well
- Air sparge well
- Dual-phase-extraction well
- Vapor monitoring well
- Well destroyed
- Well ID** — Well designation
- ELEV** — Groundwater elevation
- TPHg** — Hydrocarbon concentrations in groundwater in micrograms per liter (ug/L)
- Benzene**
- MTBE**
- NM — Not measured
- Groundwater elevation contour, in feet
- Approximate groundwater flow direction

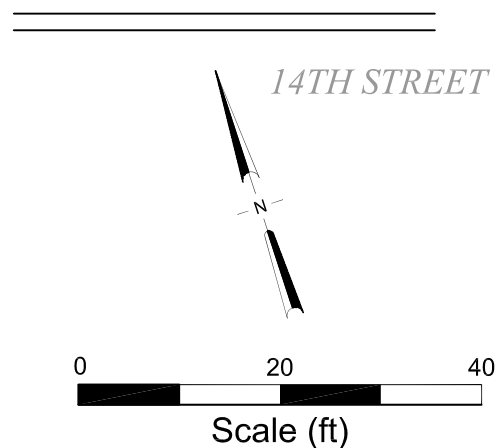

Figure 2

Pangea

Table 1. Groundwater Elevation and Analytical Data - Saberi, 1230 14th Street, Oakland, CA

Well ID	Date Measured	DTW (feet)	GWE (feet) (MSL)	TPHg (ug/L)	Benzene (ug/L)	Toluene (ug/L)	Ethylbenzene (ug/L)	Xylenes (ug/L)	MTBE (ug/L)	Dissolved Oxygen (mg/L)
MW-1 <i>18.58</i>	03/25/96	9.53	9.05	37,000	7,400	1,500	720	3,300	<500	--
	06/21/96	10.72	7.86	35,000	9,900	460	340	3,500	890	--
	09/26/96	12.88	5.70	19,000	8,200	510	780	790	<250	--
	12/19/96	12.59	5.99	27,000	120	1,200	1,400	2,800	<100	--
	12/19/96	12.59	5.99	32,000	12,000	1,300	1,600	3,100	830	--
	03/25/97	11.10	7.48	39,000	13,000	1,600	840	3,100	730	1.2
	06/26/97	12.42	6.16	--	--	--	--	--	--	--
	09/26/97	13.31	5.27	--	--	--	--	--	--	0.8
	12/05/97	12.65	5.93	--	--	--	--	--	--	0.3
	02/19/98	6.46	12.12	16,000	5,500	450	500	800	<500	2.4
	06/08/98	6.62	11.96	--	--	--	--	--	--	1.2
	08/25/98	11.83	6.75	--	--	--	--	--	--	2.8
	12/28/98	12.01	6.57	--	--	--	--	--	--	2.6
	03/26/99	9.15	9.43	--	--	--	--	--	--	2.2
	06/30/99	11.22	7.36	--	--	--	--	--	--	3.8
	09/30/99	11.89	6.69	--	--	--	--	--	--	3.0
	12/27/99	13.55	5.03	34,800	8,660	953	956	2,770	<1,000	2.4/2.1
	01/21/00	13.42	5.16	40,600	14,700	1,850	1,210	3,670	<500	2.8
	03/07/00	8.11	10.47	--	--	--	--	--	--	0.4
	04/17/00	9.78	8.80	--	--	--	--	--	--	3.0/3.4
	04/18/00	--	--	18,300	8,060	543	528	872	<50.0	--
	09/21/00	13.11	5.47	--	--	--	--	--	--	5.2
	10/17/00	12.61	5.97	15,800	6,720	435	587	887	351(<66.7)	1.2/0.8
	01/09/01	12.94	5.64	--	--	--	--	--	--	0.3
	04/27/01	10.73	7.85	1,400	650	28	58	48	(<10)	1.8/2.1
	07/03/01	12.00	6.58	--	--	--	--	--	--	1.8
	12/06/01	10.53	8.05	4,500	1,500	85	160	210	(<50)	2.5/2.9
	01/23/02	9.33	9.25	--	--	--	--	--	--	0.1
	04/17/02	10.49	8.09	230	12	<0.50	4.6	2.5	(<5.0)	6.3/5.3
	07/18/02	11.98	6.60	--	--	--	--	--	--	1.2
	11/11/02	13.00	5.58	12,000	2,600	240	470	640	(-8.5)	0.2/0.2
	01/16/03	9.68	8.90	--	--	--	--	--	--	4.4
	03/13/03	10.45	8.13	820	340	2.7	<2.0	3.2	(<20)	2.8/0.9
	04/23/03	10.32	8.26	900	550	19	49	49	(<50)	0.9/0.1
	05/13/03	10.28	8.30	740	510	18	43	46	(<50)	0.1/0.2
	06/13/03	11.16	7.42	<5,000	1,500	82	180	250	(<500)	0.3/0.8
	07/14/03	11.66	6.92	5,300	3,400	160	340	420	(<20)	0.6/0.3
	09/29/03	12.44	6.14	10,000	5,700	400	670	1,000	(<50)	0.6/0.7
	10/29/03	12.63	5.95	19,000	6,600	560	820	1,300	(26)	0.6/0.4
	01/05/04	10.17	8.41	380	140	7.1	6.2	16	(<1.0)	5.0/0.8
	04/01/04	9.57	9.01	79	0.59	<0.50	<0.50	<1.0	(<0.50)	4.6/1.2
07/02/04	11.81	6.77	4,100	2,100	33	110	81	(<10)	0.6/0.5	
11/03/04	12.53	6.05	8,000	3,800	150	480	460	(<25)	1.45/2.1	
01/04/05	9.39	9.19	120	23	1.6	2.0	3.5	(<0.50)	4.21/2.82	
04/13/05	7.63	10.95	<50	<0.50	<0.50	<0.50	<0.50	(<0.50)	2.44/2.77	
07/13/05	10.85	7.73	930 e	400	6.1	<5.0	10	(<5.0)	0.84/0.66	
10/28/05	12.44	6.14	8,300	5,500	190	590	470	(<25)	0.2/0.2	
01/17/06	8.61	9.97	<50	2.2	1.1	1.4	4.8	(<0.50)	5.8/5.3	
02/23/06	9.60	8.98	--	18.1	2.22	1.89	4.50	--	--	
03/09/06	7.65	10.93	--	1.80	<0.500	<0.500	1.82	--	--	
04/21/06	6.35	12.23	<50.0	1.54	1.03	4.20	5.82	(<0.500)	--	
05/01/06	7.38	11.20	268	41.3	4.62	3.83	26.1	(<0.500)	0.27/0.36	
06/23/06	10.09	8.49	3,990	362	13.1	12.4	71.5	(<0.500)	--	
07/11/06	10.09	8.49	6,190	3,740	52.0	67.8	982	(<0.500)	--	
08/30/06	11.55	7.03	29,200	7,380	596	443	1,680	(4.45)	0.39/0.52	
09/29/06	11.97	6.61	76,100	9,300	859 i	1,290	2,820 i	(<5.00)	--	
10/13/06	12.08	6.50	49,500	7,580	770	1,030	2,860	(2.75)	--	
11/03/06	12.47	6.11	42,600	8,450	592	869	1,970	(2.69)	2.60/1.15	
12/26/06	11.80	6.78	19,000	4,600	360	640	1,300	(<5.0)	--	
01/11/07	11.84	6.74	23,000	6,000	320	780	1,100	(<25)	--	
01/30/07	12.18	6.40	3,700	890	74	170	220	(<25)	1.18/0.76	
03/01/07	10.74	7.84	2,600	670	32	41	180	(<10)	--	
04/26/07	10.90	7.68	12,000 k,l	2,800	220	400	560	(<20)	--	
06/01/07	11.49	7.09	15,000 k	3,900	380	670	1,010	(1.8)	0.31/0.43	
06/21/07	12.07	6.51	13,000 k	3,800	400	620	1,060	(<50)	--	
07/03/07	12.00	6.58	21,000 k	6,100	510	960	1,760	(<50)	--	
08/16/07	12.55	6.03	20,000 k	5,800	460	1,100	1,730	(<50)	0.3/0.2	
12/06/07	13.00	5.58	53,000	9,400	560	1,400	3,000	(<25)	--	
02/25/08	9.91	8.67	<50	<0.5	<0.5	<0.5	<0.5	<5.0	3.74	
05/26/08	11.90	6.68	9,300	2,200	67	140	130	<250	1.96/1.13	
08/18/08	12.82	5.76	15,000	3,300	110	380	430	<250	0.97/0.77	
11/20/08	13.46	5.12	18,000	4,700	190	770	910	<100	1.04/1.27	
02/18/09	11.77	6.81	2,200	54	8.7	45	76	<10	1.21/1.40	
05/26/09	11.18	7.40	750	31	7.1	3.5	23	<5.0	0.90/1.21	

Pangea

Table 1. Groundwater Elevation and Analytical Data - Saberi, 1230 14th Street, Oakland, CA

Well ID	Date Measured	DTW (feet)	GWE (feet) (MSL)	TPHg (ug/L)	Benzene (ug/L)	Toluene (ug/L)	Ethylbenzene (ug/L)	Xylenes (ug/L)	MTBE (ug/L)	Dissolved Oxygen (mg/L)
MW-2 <i>17.90</i>	03/25/96	8.19	9.71	<50	<0.50	<0.50	<0.50	<0.50	<2.5	--
	06/21/96	9.94	7.96	<50	<0.50	<0.50	<0.50	<0.50	<2.5	--
	09/26/96	12.15	5.75	<50	<0.50	<0.50	<0.50	<0.50	<2.5	--
	12/19/96	11.70	6.20	<50	<0.5	<0.5	<0.5	<0.5	<2.5	--
	03/25/97	9.25	8.65	<50	<0.50	<0.50	<0.50	<0.50	<2.5	1.8
	06/26/97	11.36	6.54	<50	<0.50	<0.50	<0.50	<0.50	<2.5	2.4
	09/26/97	12.56	5.34	<50	<0.50	<0.50	<0.50	<0.50	<2.5	1.1
	09/26/97	12.56	5.34	<50	<0.50	<0.50	<0.50	<0.50	<2.5	1.1
	12/05/97	11.15	6.75	<50	<0.50	<0.50	<0.50	<0.50	<2.5	0.7
	02/19/98	5.61	12.29	<50	<0.50	<0.50	<0.50	<0.50	<2.5	2.7
	06/08/98	5.58	12.32	<50	<0.30	<0.30	<0.30	<0.60	<10	3.2
	08/25/98	10.67	7.23	--	--	--	--	--	--	1.7
	12/28/98	11.65	6.25	<50.0	<0.500	<0.500	<0.500	<0.500	<2.00	0.4/0.8
	03/26/99	8.60	9.30	--	--	--	--	--	--	0.7
	06/30/99	10.30	7.60	<50.0	<0.500	<0.500	<0.500	<0.500	<5.00	2.3
	09/30/99	10.77	7.13	--	--	--	--	--	--	1.9
	12/27/99	12.21	5.69	<50.0	<0.500	<0.500	<0.500	<0.500	<5.00	0.7/0.7
	03/07/00	7.13	10.77	--	--	--	--	--	--	1.1
	04/17/00	8.35	9.55	<50.0	<0.500	<0.500	<0.500	<0.500	<2.50	1.8/1.8
	09/21/00	11.76	6.14	--	--	--	--	--	--	2.1
	10/17/00	11.80	6.10	<50.0	<0.500	<0.500	<0.500	<0.500	<2.50	0.9/0.6
	01/09/01	12.14	5.76	--	--	--	--	--	--	0.7
	04/27/01	9.85	8.05	<50	<0.50	<0.50	<0.50	<0.50	(<0.50)	1.1/0.9
	07/03/01	11.20	6.70	--	--	--	--	--	--	1.2
	12/06/01	10.77	7.13	<50	<0.50	<0.50	<0.50	<0.50	(<5.0)	3.9/2.1
	01/23/02	8.64	9.26	--	--	--	--	--	--	2.5
	04/17/02	9.61	8.29	<50	<0.50	<0.50	<0.50	<0.50	(<5.0)	3.5/5.2
	07/18/02	11.09	6.81	--	--	--	--	--	--	1.4
	11/11/02	12.16	5.74	<50	<0.50	<0.50	<0.50	<0.50	(<5.0)	0.2/0.3
	01/16/03	8.92	8.98	--	--	--	--	--	--	1.7
	03/13/03	9.60	8.30	--	--	--	--	--	--	1.1
	04/23/03	9.48	8.42	<50	<0.50	<0.50	<0.50	<1.0	(<5.0)	0.4/0.2
	05/13/03	9.45	8.45	<50	<0.50	<0.50	<0.50	<1.0	(<5.0)	0.5/0.3
	06/13/03	10.28	7.62	<50	<0.50	<0.50	<0.50	<1.0	(<5.0)	0.6/0.9
	07/14/03	10.67	7.23	<50	<0.50	<0.50	<0.50	<1.0	(<0.50)	0.5/0.9
	09/29/03	11.58	6.32	<50	<0.50	<0.50	<0.50	<1.0	(<0.50)	1.9/1.3
10/29/03	11.76	6.14	<50	<0.50	<0.50	<0.50	<1.0	(<0.50)	4.3/0.5	
01/05/04	9.36	8.54	<50	<0.50	<0.50	<0.50	<1.0	(<0.50)	1.2/0.8	
04/01/04	8.77	9.13	<50	<0.50	<0.50	<0.50	<1.0	(<0.50)	4.0/0.3	
07/02/04	11.04	6.86	<50	<0.50	<0.50	<0.50	<1.0	(<0.50)	0.4/0.3	
11/03/04	11.71	6.19	<50	<0.50	<0.50	<0.50	<1.0	(0.54)	6.4/1.40	
01/04/05	8.68	9.22	<50	<0.50	<0.50	<0.50	<1.0	(0.62)	4.41/2.88	
04/13/05	7.13	10.77	<50	<0.50	<0.50	<0.50	<0.50	(1.7)	0.71/0.23	
07/13/05	10.30	7.60	<50	<0.50	<0.50	<0.50	<1.0	(2.3)	0.90/0.33	
10/28/05	11.61	6.29	<50	<0.50	<0.50	<0.50	<1.0	(4.2)	0.4/0.1	
01/17/06	8.21	9.69	<50	<0.50	<0.50	<0.50	<0.50	(5.0)	0.8/0.2	
03/09/06	7.70	10.20	--	--	--	--	--	--	--	
04/21/06	5.83	12.07	--	--	--	--	--	--	--	
05/01/06	6.34	11.56	<50.0	<0.500	<0.500	<0.500	<0.500	(4.33)	0.52/0.18	
08/30/06	10.71	7.19	<50.0	<0.500	<0.500	<0.500	<0.500	(1.98)	0.51/1.04	
09/29/06	11.03	6.87	--	--	--	--	--	--	--	
11/03/06	11.62	6.28	<50.0	<0.500	<0.500	<0.500	<0.500	(3.08)	0.44/0.40	
01/30/07	11.30	6.60	<50	<0.50	<0.50	<0.50	<1.0	(2.9)	0.92/0.63	
06/01/07	10.52	7.38	<50 k	0.71	<1.0	0.20 m	0.39 m	(1.7)	0.71/0.56	
08/16/07	11.60	6.30	<50 k	<0.50	<1.0	<1.0	<1.0	(1.3)	0.5/0.2	
12/06/07	12.39	5.51	<50	0.97	<0.5	0.56	1.5	(0.99)	--	
02/25/08	9.15	8.75	<50	<0.5	<0.5	<0.5	<0.5	<5.0	2.82	
05/26/08	11.02	6.88	<50	<0.5	<0.5	<0.5	<0.5	<5.0	1.86/1.32	
08/18/08	11.97	5.93	<50	<0.5	<0.5	<0.5	<0.5	<5.0	1.45/1.12	
11/20/08	12.64	5.26	<50	<0.5	<0.5	<0.5	<0.5	<5.0	1.10/1.16	
02/18/09	11.14	6.76	<50	<0.5	<0.5	<0.5	<0.5	<5.0	0.98/1.11	
05/26/09	10.31	7.59	<50	<0.5	<0.5	<0.5	<0.5	<5.0	1.03/1.49	

Pangea

Table 1. Groundwater Elevation and Analytical Data - Saberi, 1230 14th Street, Oakland, CA

Well ID	Date Measured	DTW (feet)	GWE (feet) (MSL)	TPHg (ug/L)	Benzene (ug/L)	Toluene (ug/L)	Ethylbenzene (ug/L)	Xylenes (ug/L)	MTBE (ug/L)	Dissolved Oxygen (mg/L)
MW-3 <i>18.18</i>	03/25/96	8.47	9.71	<50	<0.50	<0.50	<0.50	<0.50	<2.5	--
	06/21/96	10.40	7.78	<50	<0.50	<0.50	<0.50	<0.50	<2.5	--
	09/26/96	12.45	5.73	<50	<0.50	<0.50	<0.50	<0.50	<2.5	--
	12/19/96	12.14	6.04	<50	<0.5	<0.5	<0.5	<0.5	<2.5	--
	03/25/97	9.54	8.64	<50	<0.50	<0.50	<0.50	<0.50	<2.5	2.2
	06/26/97	11.66	6.52	<50	<0.50	<0.50	<0.50	<0.50	<2.5	3.6
	09/26/97	12.85	5.33	<50	<0.50	<0.50	<0.50	<0.50	<2.5	1.1
	12/05/97	11.44	6.74	<50	<0.50	<0.50	<0.50	<0.50	<2.5	0.6
	02/19/98	6.78	11.40	<50	<0.50	<0.50	<0.50	<0.50	<2.5	3.6
	06/08/98	6.82	11.36	<50	<0.30	<0.30	<0.30	<0.60	<10	3.8
	06/08/98	6.82	11.36	<50	<0.30	<0.30	<0.30	<0.60	<10	3.8
	08/25/98	11.09	7.09	--	--	--	--	--	--	1.2
	12/28/98	11.84	6.34	<50.0	<0.500	<0.500	<0.500	<0.500	<2.00	0.9/0.6
	03/26/99	8.57	9.61	--	--	--	--	--	--	0.8
	06/30/99	10.61	7.57	<50.0	<0.500	<0.500	<0.500	<0.500	<5.00	4.8
	09/30/99	11.53	6.65	--	--	--	--	--	--	1.4
	12/27/99	12.35	5.83	<50.0	<0.500	<0.500	<0.500	<0.500	<5.00	1.4/2.5
	03/07/00	7.36	10.82	--	--	--	--	--	--	5.8
	04/17/00	8.39	9.79	<50.0	<0.500	<0.500	<0.500	<0.500	19.3	6.5/5.1
	09/21/00	12.01	6.17	--	--	--	--	--	--	3.0
	10/17/00	12.10	6.08	<50.0	<0.500	<0.500	<0.500	<0.500	<2.50	2.0/1.0
	01/09/01	12.43	5.75	--	--	--	--	--	--	1.9
	04/27/01	10.10	8.08	<50	<0.50	<0.50	<0.50	<0.50	(<0.50)	2.3/2.4
	07/03/01	11.45	6.73	--	--	--	--	--	--	1.4
	12/06/01	11.07	7.11	<50	<0.50	<0.50	<0.50	<0.50	(<5.0)	2.8/3.9
	01/23/02	8.89	9.29	--	--	--	--	--	--	3.1
	04/17/02	9.92	8.26	<50	<0.50	<0.50	<0.50	<0.50	(<5.0)	3.7/3.2
	07/18/02	11.42	6.76	--	--	--	--	--	--	1.6
	11/11/02	12.44	5.74	<50	<0.50	<0.50	<0.50	<0.50	(<5.0)	0.3/0.4
	01/16/03	9.25	8.93	--	--	--	--	--	--	2.1
	03/13/03	9.84	8.34	--	--	--	--	--	--	1.2
	04/23/03	9.71	8.47	<50	<0.50	<0.50	<0.50	<1.0	(<5.0)	0.7/0.2
	05/13/03	9.70	8.48	<50	<0.50	<0.50	<0.50	<1.0	(<5.0)	0.6/0.2
	06/13/03	10.58	7.60	<50	<0.50	<0.50	<0.50	<1.0	(<5.0)	0.4/1.3
	07/14/03	10.98	7.20	<50	<0.50	<0.50	<0.50	<1.0	(<0.50)	0.4/0.3
	09/29/03	11.84	6.34	<50	<0.50	<0.50	<0.50	<1.0	(<0.50)	1.4/1.1
	10/29/03	12.05	6.13	58 b	<0.50	<0.50	<0.50	<1.0	(<0.50)	0.8/0.4
	01/05/04	9.70	8.48	<50	<0.50	<0.50	<0.50	<1.0	(<0.50)	1.3/0.7
	04/01/04	9.03	9.15	<50	<0.50	<0.50	<0.50	<1.0	(<0.50)	1.2/0.6
	07/02/04	11.15	7.03	<50	<0.50	<0.50	<0.50	<1.0	(<0.50)	0.7/0.5
11/03/04	11.98	6.20	<50	<0.50	<0.50	<0.50	<1.0	(<0.50)	1.65/2.75	
01/04/05	8.98	9.20	<50	<0.50	<0.50	<0.50	<1.0	(<0.50)	3.21/1.87	
04/13/05	7.22	10.96	<50	<0.50	<0.50	<0.50	<0.50	(<0.50)	4.92/5.28	
07/13/05	10.30	7.88	<50	<0.50	<0.50	<0.50	<1.0	(<0.50)	0.30/0.40	
10/28/05	11.81	6.37	<50 f	<0.50	<0.50	<0.50	<1.0	(<0.50)	0.8/0.2	
01/17/06	8.17	10.01	<50	<0.50	<0.50	<0.50	<0.50	(<0.50)	3.1/2.0	
03/09/06	6.45	11.73	--	--	--	--	--	--	--	
04/21/06	5.96	12.22	--	--	--	--	--	--	--	
05/01/06	6.40	11.78	<50.0	<0.500	<0.500	<0.500	<0.500	<0.500(<0.500)	0.68/0.42	
08/30/06	10.95	7.23	<50.0	<0.500	<0.500	<0.500	<0.500	<0.500(<0.500)	3.53/3.14	
09/29/06	11.40	6.78	--	--	--	--	--	--	--	
11/03/06	11.91	6.27	<50.0	<0.500	<0.500	<0.500	<0.500	<0.500(<0.500)	7.0/6.8	
01/30/07	11.55	6.63	<50	<0.50	<0.50	<0.50	<1.0	<0.50(<0.50)	1.45/1.10	
06/01/07	10.86	7.32	<50 k	0.34 m	<1.0	<1.0	<1.0	<1.0(<1.0)	0.62/0.56	
08/16/07	11.87	6.31	<50 k	<0.50	<1.0	<1.0	<1.0	<1.0(<1.0)	0.2/0.2	
12/06/07	14.43	3.75	<50	1.8	1.0	0.90	4.4	(<0.5)	--	
02/25/08	9.37	8.81	<50	<0.5	<0.5	<0.5	<0.5	<5.0	4.91	
05/26/08	11.31	6.87	<50	<0.5	<0.5	<0.5	<0.5	<5.0	1.79/2.01	
08/18/08	12.28	5.90	<50	<0.5	<0.5	<0.5	<0.5	<5.0	1.57/1.52	
11/20/08	12.84	5.34	<50	<0.5	<0.5	<0.5	<0.5	<5.0	1.24/1.68	
02/18/09	11.45	6.73	<50	<0.5	<0.5	<0.5	<0.5	<5.0	1.16/1.38	
05/26/09	10.62	7.56	<50	<0.5	<0.5	<0.5	<0.5	<5.0	1.21/1.40	

Pangea

Table 1. Groundwater Elevation and Analytical Data - Saberi, 1230 14th Street, Oakland, CA

Well ID	Date Measured	DTW (feet)	GWE (feet) (MSL)	TPHg (ug/L)	Benzene (ug/L)	Toluene (ug/L)	Ethylbenzene (ug/L)	Xylenes (ug/L)	MTBE (ug/L)	Dissolved Oxygen (mg/L)
MW-4 <i>18.01</i>	03/25/96	9.20	8.81	<50	<0.50	<0.50	<0.50	<0.50	<2.5	--
	06/21/96	10.25	7.76	<50	<0.50	<0.50	<0.50	<0.50	<2.5	--
	09/26/96	12.29	5.72	<50	<0.50	<0.50	<0.50	<0.50	<2.5	--
	12/19/96	12.47	5.54	<50	<0.5	<0.5	<0.5	<0.5	<2.5	--
	03/25/97	9.44	8.57	<50	<0.50	<0.50	<0.50	<0.50	<2.5	1.8
	06/26/97	11.57	6.44	<50	<0.50	<0.50	<0.50	<0.50	<2.5	6.2
	06/26/97	11.57	6.44	<50	<0.50	<0.50	<0.50	<0.50	<2.5	6.2
	09/26/97	12.75	5.26	<50	<0.50	<0.50	<0.50	<0.50	<2.5	2.1
	12/05/97	11.37	6.64	<50	<0.50	<0.50	<0.50	<0.50	<2.5	1.0
	12/05/97	11.37	6.64	<50	<0.50	<0.50	<0.50	<0.50	<2.5	1.0
	02/19/98	5.59	12.42	<50	<0.50	<0.50	<0.50	<0.50	<2.5	6.5
	06/08/98	5.65	12.36	<50	<0.30	<0.30	<0.30	<0.60	<10	2.6
	08/25/98	10.98	7.03	--	--	--	--	--	--	2.4
	12/28/98	11.83	6.18	<50.0	<0.500	<0.500	<0.500	<0.500	<2.00	1.3/1.2
	03/26/99	8.40	9.61	--	--	--	--	--	--	1.9
	06/30/99	10.53	7.48	<50.0	<0.500	<0.500	<0.500	<0.500	<5.00	7.6
	09/30/99	11.03	6.98	--	--	--	--	--	--	2.6
	12/27/99	12.53	5.48	<50.0	<0.500	<0.500	<0.500	<0.500	<5.00	1.9/0.8
	03/07/00	7.00	11.01	--	--	--	--	--	--	6.5
	04/17/00	8.57	9.44	<50.0	<0.500	<0.500	<0.500	<0.500	<2.50	5.1/5.1
	09/21/00	12.05	5.96	--	--	--	--	--	--	3.0
	10/17/00	11.96	6.05	<50.0	<0.500	<0.500	<0.500	<0.500	<2.50	5.5/1.2
	01/09/01	12.33	5.68	--	--	--	--	--	--	2.1
	04/27/01	9.96	8.05	<50	<0.50	<0.50	<0.50	<0.50	(<0.50)	5.3/3.8
	07/03/01	11.35	6.66	--	--	--	--	--	--	4.5
	12/06/01	10.99	7.02	<50	<0.50	<0.50	<0.50	<0.50	(<5.0)	10.23/6.5
	01/23/02	8.80	9.21	--	--	--	--	--	--	8.8
	04/17/02	9.75	8.26	<50	<0.50	<0.50	<0.50	<0.50	(<5.0)	7.0/5.1
	07/18/02	11.32	6.69	--	--	--	--	--	--	5.3
	11/11/02	12.36	5.65	<50	<0.50	<0.50	<0.50	<0.50	(<5.0)	3.6/2.0
	01/16/03	10.33	7.68	--	--	--	--	--	--	6.5
	03/13/03	10.06	7.95	--	--	--	--	--	--	6.5
	04/23/03	9.57	8.44	<50	<0.50	<0.50	<0.50	<1.0	(<5.0)	5.1/5.7
05/13/03	9.55	8.46	<50	<0.50	<0.50	<0.50	<1.0	(<5.0)	2.0/2.5	
06/13/03	10.50	7.51	<50	<0.50	<0.50	<0.50	<1.0	(<5.0)	5.0/5.6	
07/14/03	10.86	7.15	<50	<0.50	<0.50	<0.50	<1.0	(<0.50)	3.9/4.2	
09/29/03	11.74	6.27	<50	<0.50	<0.50	<0.50	<1.0	(<0.50)	1.6/1.4	
10/29/03	11.95	6.06	58 b	<0.50	<0.50	<0.50	<1.0	(<0.50)	2.4/1.0	
01/05/04	10.35	7.66	<50	<0.50	<0.50	<0.50	<1.0	(<0.50)	7.4/7.5	
04/01/04	8.81	9.20	<50	<0.50	<0.50	<0.50	<1.0	(<0.50)	6.0/6.4	
07/02/04	11.10	6.91	<50	<0.50	<0.50	<0.50	<1.0	(<0.50)	0.8/0.6	
11/03/04	11.85	6.16	<50	<0.50	<0.50	<0.50	<1.0	(<0.50)	1.3/2.84	
01/04/05	9.06	8.95	<50	<0.50	<0.50	<0.50	<1.0	(<0.50)	7.12/6.37	
04/13/05	6.84	11.17	<50	<0.50	<0.50	<0.50	<0.50	(<0.50)	5.81/5.66	
07/13/05	10.20	7.81	<50	<0.50	<0.50	<0.50	<1.0	(<0.50)	1.87/3.75	
10/28/05	11.75	6.26	<50	<0.50	<0.50	<0.50	<1.0	(<0.50)	1.4/0.8	
01/17/06	8.00	10.01	<50	<0.50	<0.50	<0.50	<0.50	(<0.50)	6.4/6.2	
03/09/06	6.55	11.46	--	--	--	--	--	--	--	
04/21/06	5.45	12.56	--	--	--	--	--	--	--	
05/01/06	6.14	11.87	<50.0	<0.500	<0.500	<0.500	<0.500	(<0.50)	1.09/0.72	
08/30/06	10.82	7.19	<50.0	<0.500	<0.500	<0.500	<0.500	(<0.50)	4.31/4.35	
09/29/06	11.29	6.72	--	--	--	--	--	--	--	
11/03/06	11.81	6.20	<50.0	<0.500	<0.500	<0.500	<0.500	(<0.50)	3.30/2.40	
01/30/07	11.45	6.56	<50	<0.50	<0.50	<0.50	<1.0	(<0.50)	1.67/0.94	
06/01/07	10.72	7.29	67 k	<0.50	<1.0	<1.0	<1.0	(<1.0)	0.93/0.81	
08/16/07	11.81	6.20	<50 k	<0.50	<1.0	<1.0	<1.0	(<1.0)	0.5/1.3	
12/06/07	12.34	5.67	<50	<0.5	<0.5	<0.5	<0.5	(<0.5)	--	
02/25/08	9.03	8.98	<50	<0.5	<0.5	<0.5	<0.5	<5.0	6.84	
05/26/08	11.23	6.78	<50	<0.5	<0.5	<0.5	<0.5	<5.0	6.59/5.22	
08/18/08	12.20	5.81	<50	<0.5	<0.5	<0.5	<0.5	<5.0	7.99/2.89	
11/20/08	12.83	5.18	<50	<0.5	<0.5	<0.5	<0.5	<5.0	3.51/3.18	
02/18/09	11.23	6.78	<50	<0.5	<0.5	<0.5	<0.5	<5.0	2.90/3.15	
05/26/09	10.47	7.54	<50	<0.5	<0.5	<0.5	<0.5	<0.5	<5.0	1.78/2.85

Pangea

Table 1. Groundwater Elevation and Analytical Data - Saberi, 1230 14th Street, Oakland, CA

Well ID	Date Measured	DTW (feet)	GWE (feet) (MSL)	TPHg (ug/L)	Benzene (ug/L)	Toluene (ug/L)	Ethylbenzene (ug/L)	Xylenes (ug/L)	MTBE (ug/L)	Dissolved Oxygen (mg/L)
MW-5 <i>18.47</i>	12/03/01	11.86	6.61	--	--	--	--	--	--	--
	12/06/01	11.40	7.07	31,000	3,000	2,000	1,100	3,000	(<50)	3.1/3.2
	01/23/02	9.24	9.23	--	--	--	--	--	--	0.9
	04/17/02	10.35	8.12	33,000	3,800	2,400	1,300	4,400	(<200)	5.3/3.8
	07/18/02	11.82	6.65	--	--	--	--	--	--	0.8
	11/11/02	12.86	5.61	100,000	7,100	12,000	3,000	17,000	(5.10)	1.2/1.4
	01/16/03	9.57	8.90	--	--	--	--	--	--	0.0
	03/13/03	10.30	8.17	33,000	2,800	2,200	980	4,600	(<100)	0.5/0.3
	04/07/03	10.29	8.18	--	--	--	--	--	--	--
	04/23/03	10.15	8.32	33,000	2,900	3,100	960	5,800	(<250)	0.1/0.1
	05/13/03	10.12	8.35	30,000	2,600	1,500	850	4,500	(<250)	0.4/0.3
	06/13/03	11.00	7.47	33,000	3,400	2,300	1,000	4,400	(<500)	0.3/0.3
	07/14/03	11.39	7.08	41,000	5,100	3,500	1,400	5,100	(<50)	0.5/0.5
	09/29/03	12.24	6.23	59,000	6,600	4,200	1,500	6,500	(<50)	0.6/0.5
	10/29/03	12.45	6.02	45,000	6,800	3,500	1,500	6,400	(21)	0.5/0.3
	01/05/04	9.97	8.50	26,000	4,900	1,700	1,100	3,300	(<50)	0.9/1.2
	04/01/04	9.43	9.04	29,000	5,300	2,700	880	2,900	(<50)	0.3/1.0
	07/02/04	11.62	6.85	19,000	5,300	740	1,100	1,400	(<50)	0.4/0.5
	11/03/04	12.26	6.21	31,000	7,500	2,300	1,400	4,400	(<50)	2.5/1.9
	01/04/05	9.13	9.34	18,000	3,500	1,200	730	2,300	(<25)	0.44/1.64
	04/13/05	7.60	10.87	7,000	100	460	180	880	(<1.0)	0.17/0.45
	07/13/05	10.63	7.84	9,400	2,400	840	440	1,100	(<13)	0.13/0.27
	10/28/05	12.14	6.33	28,000	16,000	2,900	1,400	3,100	(<50)	0.3/1.3
	01/17/06	8.52	9.95	6,700	1,200	720	400	1,500	(1.3)	0.6/2.6
	02/23/06	9.22	9.25	--	4,630	1,470	709	2,310	--	--
	03/09/06	7.15	11.32	--	474	90.3	63.3	169	--	--
	04/21/06	5.82	12.65	<0.500	<0.500	<0.500	<0.500	<0.500	(<0.500)	--
	05/01/06	7.23	11.24	779	6.77	41.1	20.0	130	(<0.500)	0.39/1.52
	06/23/06	10.06	8.41	22,600	2,830	557	469	1,210	(<0.500)	--
	07/11/06	10.06	8.41	31,100	3,880	2,080	857	3,700	(<0.500)	--
	08/30/06	11.32	7.15	28,200	4,840	1,320	705	2,430	(5.35)	0.47/3.64
	09/29/06	11.81	6.66	94,900	10,100	2,960	1,810	5,310 i	(7.20)	--
	10/13/06	12.01	6.46	48,200	7,710	1,360	1,250	3,460	(5.64)	--
	11/03/06	12.31	6.16	50,600	11,300	1,730	1,250	3,840	(<0.500)	0.60/4.10
12/26/06	11.58	6.89	32,000	11,000	780	1,200	2,800	(<10)	--	
01/11/07	11.61	6.86	35,000	11,000	1,100	1,200	3,100	(<50)	--	
01/30/07	11.95	6.52	27,000	9,800	610	860	2,400	(<50)	0.87/0.62	
03/01/07	10.95	7.52	23,000	9,400	640	1,200	3,100	(<50)	--	
04/26/07	10.69	7.78	48,000 k,l	14,000	1,300	1,600	3,600	(<100)	--	
06/01/07	11.25	7.22	54,000 k	15,000	2,800	2,200	6,100	(<100)	0.44/0.87	
06/21/07	11.96	6.51	32,000 k	12,000	1,200	1,400	2,780	(<100)	--	
07/03/07	11.81	6.66	41,000 k	15,000	1,800	1,900	4,050	(<100)	--	
08/16/07	12.36	6.11	43,000 k,l	13,000	2,000	2,000	4,150	(<100)	0.6/0.1	
12/06/07	12.81	5.66	37,000	7,900	640	1,100	1,500	(<17)	--	
02/25/08	9.75	8.72	3,000	640	9.7	52	77	20	2.19	
05/26/08	11.69	6.78	39,000	9,600	1,100	1,400	2,400	<250	1.10/1.52	
06/27/08				MW-5 drilled out and replaced with MW-5R						
MW-6 <i>18.84</i>	12/03/01	12.19	6.65	--	--	--	--	--	--	--
	12/06/01	11.70	7.14	76	5.7	3.8	1.4	7.0	(<5.0)	6.3/6.1
	01/23/02	9.57	9.27	--	--	--	--	--	--	8.7
	04/17/02	10.73	8.11	<50	<0.50	<0.50	<0.50	<0.50	(<5.0)	9.8/9.1
	07/18/02	12.27	6.57	--	--	--	--	--	--	1.7
	11/11/02	13.24	5.60	580	55	<0.50	<0.50	2.8	(<5.0)	0.3/0.6
	01/16/03	9.89	8.95	--	--	--	--	--	--	6.4
	03/13/03	10.66	8.18	--	--	--	--	--	--	5.5
	04/23/03	10.57	8.27	<50	<0.50	<0.50	<0.50	<1.0	(<5.0)	3.7/4.4
	05/13/03	10.56	8.28	<50	<0.50	<0.50	<0.50	<1.0	(<5.0)	3.5/3.0
	06/13/03	11.48	7.36	<50	<0.50	<0.50	<0.50	<1.0	(<5.0)	2.7/3.1
	07/14/03	11.83	7.01	230 b	3.4	<0.50	<0.50	<1.0	(<0.50)	1.8/1.3
	09/29/03	12.70	6.14	910 b	46	<2.5	<2.5	<5.0	(<2.5)	1.1/1.0
	10/29/03	12.91	5.93	830	38	0.53	<0.50	3.3	(0.60)	1.2/0.9
	01/05/04	10.35	8.49	93	0.92	<0.50	<0.50	<1.0	(<0.50)	6.2/4.3
	04/01/04	9.80	9.04	<50	<0.50	<0.50	<0.50	<1.0	(<0.50)	3.5/3.4
	07/02/04	12.09	6.75	370	3.0	<0.50	<0.50	<1.0	(<0.50)	0.6/1.0
	11/03/04	12.84	6.00	540	22	0.73	<0.50	1.5	(0.82)	2.28/0.84
	01/04/05	9.55	9.29	<50	<0.50	<0.50	<0.50	<1.0	(<0.50)	6.71/5.16
	04/13/05	7.89	10.95	<50	<0.50	<0.50	<0.50	<0.50	(<0.50)	2.99/2.87
	07/13/05	11.13	7.71	170	6.2	1.1	<0.50	<1.0	(0.71)	0.10/1.32
10/28/05	12.74	6.10	490	22	<0.50	<0.50	<1.0	(<0.50)	0.6/0.3	
01/17/06	8.80	10.04	<50	<0.50	<0.50	<0.50	<0.50	(<0.50)	5.3/4.9	
02/23/06	9.54	9.30	--	<0.500	<0.500	<0.500	<0.500	--	--	
03/09/06	7.25	11.59	--	<0.500	<0.500	<0.500	<0.500	--	--	

Pangea

Table 1. Groundwater Elevation and Analytical Data - Saberi, 1230 14th Street, Oakland, CA

Well ID	Date Measured	DTW (feet)	GWE (feet) (MSL)	TPHg (ug/L)	Benzene (ug/L)	Toluene (ug/L)	Ethylbenzene (ug/L)	Xylenes (ug/L)	MTBE (ug/L)	Dissolved Oxygen (mg/L)
<i>(MW-6 cont'd)</i>	04/21/06	6.34	12.50	<50.0	<0.500	<0.500	<0.500	<0.500	<0.500	--
	05/01/06	7.32	11.52	<50.0	<0.500	<0.500	<0.500	<0.500	<0.500	0.72/0.63
	06/23/06	10.12	8.72	<50.0	<0.500	<0.500	<0.500	<0.500	<0.500	--
	07/11/06	10.12	8.72	<50.0	<0.500	<0.500	<0.500	<0.500	<0.500	--
	08/30/06	11.79	7.05	<50.0	3.32	<0.500	<0.500	<0.500	<0.500	0.80/0.86
	09/29/06	12.32	6.52	<50.0	1.59	<0.500	<0.500	<0.500	<0.500	--
	10/13/06	12.38	6.46	934	3.14	<0.500	<0.500	<0.500	<0.500	--
	11/03/06	12.77	6.07	112	10.6	<0.500	<0.500	<0.500	<0.500	3.80/1.10
	12/26/06	12.05	6.79	690	62	<0.50	<0.50	4.5	<0.50	--
	01/11/07	12.12	6.72	660	11	<0.50	<0.50	2.3	<0.50	--
	01/30/07	12.44	6.40	310	1.5	<0.50	<0.50	<1.0	<0.50	1.47/0.81
	03/01/07	10.97	7.87	360	3.6	<0.50	<0.50	0.87	<0.50	--
	04/26/07	11.18	7.66	210 k	0.72	<1.0	<1.0	<1.0	<1.0	--
	06/01/07	11.72	7.12	640 k	3.1	<1.0	<1.0	0.27 m	<1.0	0.69/0.50
	06/21/07	12.22	6.62	390 k	3.0	<1.0	<1.0	0.17 m	<1.0	--
	07/03/07	12.22	6.62	360 k	3.0	<1.0	0.36 m	1.2	<1.0	--
	08/16/07	12.74	6.10	400 k,l	2.8	<1.0	<1.0	<1.0	<1.0	0.4/0.1
	12/06/07	13.24	5.60	130	<0.5	1.6	<0.5	<0.5	<0.5	--
	02/25/08	10.26	8.58	<50	<0.5	<0.5	<0.5	<0.5	<5.0	1.81
	05/26/08	12.20	6.64	<50	1.1	0.88	<0.5	<0.5	<5.0	6.77/6.59
	08/18/08	13.10	5.74	160	11	2.4	<0.5	0.57	<5.0	1.13/3.35
	11/20/08	13.73	5.11	120	1.1	1.7	<0.5	0.68	<5.0	0.98/2.11
	02/18/09	11.95	6.89	<50	<0.5	<0.5	<0.5	<0.5	<5.0	0.70/1.92
05/26/09	11.46	7.38	<50	<0.5	<0.5	<0.5	<0.5	<5.0	0.72/1.65	
MW-7 <i>19.20</i>	12/03/01	12.66	6.54	--	--	--	--	--	--	--
	12/06/01	12.20	7.00	1,800	390	<2.0	6.2	<2.0	<20	3.9/3.8
	01/23/02	10.00	9.20	--	--	--	--	--	--	9.4
	04/17/02	11.21	7.99	<50	<0.50	<0.50	<0.50	<0.50	<5.0	8.8/7.3
	07/18/02	12.69	6.51	--	--	--	--	--	--	0.8
	11/11/02	13.69	5.51	3,000	190	<0.50	<0.50	4.3	(5.2)	0.4/0.8
	01/16/03	10.36	8.84	--	--	--	--	--	--	7.9
	03/13/03	11.16	8.04	--	--	--	--	--	--	5.2
	04/23/03	11.02	8.18	250	48	<0.50	<0.50	<1.0	<5.0	3.2/1.3
	05/13/03	11.00	8.20	1,700	550	<2.5	<2.5	<5.0	<25	2.0/1.5
	06/13/03	11.90	7.30	1,500 b	470	<2.5	<2.5	<5.0	<25	1.8/1.6
	07/14/03	12.29	6.91	1,300 b	1,200	<10	<10	<20	<10	0.4/0.2
	09/29/03	13.12	6.08	5,200	1,200	<10	<10	<20	<10	0.9/0.9
	10/29/03	13.34	5.86	4,800	1,100	<5.0	<5.0	<10	(8.9)	0.4/0.3
	01/05/04	10.85	8.35	53	6.7	<0.50	<0.50	<1.0	<0.50	1.4/2.3
	04/01/04	10.28	8.92	<50	<0.50	<0.50	<0.50	<1.0	<0.50	5.5/6.2
	07/02/04	12.48	6.72	8,100 d	3,400	<25	<25	<50	<25	0.8/0.8
	11/03/04	13.25	5.95	3,700	1,200	<5.0	<5.0	<10	<5.0	1.9/0.8
	01/04/05	10.02	9.18	<50	2.0	<0.50	<0.50	<1.0	<0.50	6.31/5.71
	04/13/05	8.46	10.74	<50	<0.50	<0.50	<0.50	<0.50	<0.50	5.87/5.89
	07/13/05	11.57	7.63	1,100	380	9.2	<2.5	37	<2.5	0.30/0.33
	10/28/05	13.15	6.05	5,100	2,900	<13	<13	<25	<13	0.6/0.9
	01/17/06	9.30	9.90	<50	<0.50	<0.50	<0.50	<0.50	<0.50	6.4/7.4
	02/23/06	10.03	9.17	--	<0.500	<0.500	<0.500	<0.500	--	--
	03/09/06	7.70	11.50	--	<0.500	<0.500	<0.500	<0.500	--	--
	04/21/06	6.66	12.54	<50.0	<0.500	<0.500	<0.500	<0.500	<0.500	--
	05/01/06	7.72	11.48	<50.0	<0.500	<0.500	<0.500	<0.500	<0.500	0.67/0.98
	06/23/06	10.55	8.65	<50.0	<0.500	<0.500	<0.500	<0.500	<0.500	--
	07/11/06	10.55	8.65	<50.0	<0.500	<0.500	<0.500	<0.500	<0.500	--
	08/30/06	12.35	6.85	1,520	150	13.3	5.78	53.0	(0.640)	0.52/0.79
	09/29/06	12.66	6.54	2,420	384	1.80	<0.500	5.44	(0.850)	--
	10/13/06	12.85	6.35	5,980	549	0.540	0.680	11.7	(0.930)	--
	11/03/06	13.73	5.47	3,190	501	<0.500	<0.500	5.38	(0.560)	2.2/1.4
12/26/06	12.51	6.69	4,600	570	<0.50	44	2.1	<0.50	--	
01/11/07	12.55	6.65	3,900	490	<2.5	46	<5.0	<2.5	--	
01/30/07	12.89	6.31	2,500	380	<2.5	40	<5.0	<2.5	1.37/0.90	
03/01/07	11.45	7.75	2,600	350	<2.5	35	3.5	<2.5	--	
04/26/07	11.62	7.58	2,300 k	290	<5.0	31	1.3 m	<5.0	--	
06/01/07	12.23	6.97	4,400 k	350	<2.0	19	<2.0	(1.1 m)	0.04/0.71	
06/21/07	12.67	6.53	2,600 k	260	<2.0	12	<2.0	(1.4 m)	--	
07/03/07	12.76	6.44	1,700 k	170	<1.0	7.7	0.86 m	<1.0	--	
08/16/07	13.20	6.00	1,900 k	44	<1.0	<1.0	<1.0	<1.0	0.5/1.1	
12/06/07	13.73	5.47	510	21	3.1	5.8	14	(1.2)	--	
02/25/08	10.65	8.55	<50	<0.5	<0.5	<0.5	<0.5	<5.0	1.11	
05/26/08	12.62	6.58	600	190	2.3	<0.5	<0.5	<35	1.31/3.52	
08/18/08	13.52	5.68	540	71	2.7	<0.5	0.85	<25	1.12/4.75	
11/20/08	14.14	5.06	160	2.2	1.3	<0.5	<0.5	<10	1.46/2.90	
02/18/09	12.48	6.72	<50	<0.5	<0.5	<0.5	<0.5	<5.0	1.08/2.70	
05/26/09	11.90	7.30	<50	2.8	0.60	<0.5	<0.5	<5.0	1.02/1.77	

Pangea

Table 1. Groundwater Elevation and Analytical Data - Saberi, 1230 14th Street, Oakland, CA

Well ID	Date Measured	DTW (feet)	GWE (feet) (MSL)	TPHg (ug/L)	Benzene (ug/L)	Toluene (ug/L)	Ethylbenzene (ug/L)	Xylenes (ug/L)	MTBE (ug/L)	Dissolved Oxygen (mg/L)
VW/MW-2 18.30	03/25/96	9.04	9.26	13,000	900	920	180	1,500	<250	--
	06/21/96	10.48	7.82	27,000	4,100	1,100	1,400	3,200	700	--
	09/26/96	12.52	5.78	27,000	5,300	1,900	980	2,200	<500	--
	09/26/96	12.52	5.78	29,000	5,800	2,200	1,100	2,500	<250	--
	12/19/96	12.42	5.88	50,000	6,200	5,100	1,700	5,600	590	--
	03/25/97	9.83	8.47	210	5.6	<0.50	0.52	<0.50	14	2.0
	03/25/97	9.83	8.47	250	1.7	0.58	0.51	<0.50	4.7	2.0
	06/26/97	12.43	5.87	--	--	--	--	--	--	--
	09/26/97	12.98	5.32	--	--	--	--	--	--	0.9
	12/05/97	12.20	6.10	--	--	--	--	--	--	0.4
	02/19/98	5.83	12.47	<50	1.5	<0.50	<0.50	0.71	<2.5	3.6
	06/08/98	5.80	12.50	--	--	--	--	--	--	1.0
	08/25/98	11.72	6.58	--	--	--	--	--	--	4.8
	12/28/98	11.69	6.61	--	--	--	--	--	--	2.7
	03/26/99	8.75	9.55	--	--	--	--	--	--	2.8
	06/30/99	10.72	7.58	--	--	--	--	--	--	4.7
	09/30/99	12.24	6.06	--	--	--	--	--	--	4.9
	12/27/99	13.92	4.38	13,500	1,330	1,310	490	1,400	<250	2.1/1.9
	01/21/00	13.26	5.04	12,100	2,200	1,080	429	1,120	<250	2.8
	03/07/00	7.87	10.43	--	--	--	--	--	--	3.7
	04/17/00	9.65	8.65	--	--	--	--	--	--	3.7/4.1
	04/18/00	--	--	<50.0	<0.500	<0.500	<0.500	<0.500	<2.50	--
	09/21/00	12.75	5.55	--	--	--	--	--	--	6.2
	10/17/00	12.21	6.09	4,070	763	589	214	501	<50.0	0.8/0.7
	01/09/01	12.51	5.79	--	--	--	--	--	--	0.7
	04/27/01	10.21	8.09	80	5.7	<0.50	2.7	4.9	(<0.50)	2.3/2.8
	07/03/01	11.60	6.70	--	--	--	--	--	--	0.6
	12/06/01	11.15	7.15	160	1.7	1.0	1.8	4.6	(<5.0)	3.7/2.3
	01/23/02	9.07	9.23	--	--	--	--	--	--	0.5
	04/17/02	10.11	8.19	<50	2.1	<0.50	<0.50	<0.50	(<5.0)	4.9/4.4
	07/18/02	11.61	6.69	--	--	--	--	--	--	0.9
	11/11/02	12.63	5.67	15,000	1,300	1,300	680	1,800	(<5.0)	0.2/0.2
	01/16/03	9.35	8.95	--	--	--	--	--	--	0.4
	03/13/03	10.09	8.21	--	--	--	--	--	--	0.8
	04/07/03	10.09	8.21	--	--	--	--	--	--	--
	04/23/03	9.95	8.35	1,100	76	29	45	66	(<5.0)	0.8/0.3
	05/13/03	9.90	8.40	1,200	38	16	16	24	(<5.0)	0.2/0.2
	06/13/03	10.80	7.50	9,600	1,300	1,100	440	890	(<250)	0.2/0.5
	07/14/03	11.20	7.10	11,000	1,300	1,800	430	1,500	(<5.0)	0.5/0.5
	09/29/03	12.05	6.25	12,000	860	980	410	1,100	(<10)	0.4/0.4
	10/29/03	12.29	6.01	12,000	1,100	940	530	1,200	(<10)	0.7/0.3
	01/05/04	9.82	8.48	190 b	<0.50	<0.50	<0.50	<1.0	(<0.50)	2.8/1.8
04/01/04	9.24	9.06	410	1.4	0.54	1.6	1.0	(<0.50)	1.7/0.1	
07/02/04	11.33	6.97	5,500	440	370	170	410	(<2.5)	0.5/0.4	
11/03/04	12.14	6.16	3,800	260	210	150	600	(<2.5)	0.9/1.4	
01/04/05	9.03	9.27	280	5.8	20	7.8	26	(<0.50)	1.66/2.66	
04/13/05	7.38	10.92	<50	<0.50	<0.50	<0.50	<0.50	(<0.50)	0.79/0.58	
07/13/05	10.45	7.85	350	19	9.3	9.8	14	(<0.50)	0.10/0.08	
10/28/05	11.98	6.32	3,400	440	350	150	320	(<2.5)	0.4/0.1	
01/17/06	8.34	9.96	700	3.1	5.1	7.7	66	(<0.50)	2.7/1.6	
02/23/06	9.42	8.88	--	97.9	17.2	40.0	80.6	--	--	
03/09/06	7.35	10.95	--	<0.500	29.2	57.8	486	--	--	
04/21/06	5.99	12.31	<50.0	<0.500	0.960	<0.500	2.71	(<0.500)	--	
05/01/06	7.25	11.05	<50.0	<0.500	<0.500	<0.500	<0.500	(<0.500)	0.43/0.10	
06/23/06	10.05	8.25	3,150	35.6	9.24	20.7	113	(<0.500)	--	
07/11/06	10.05	8.25	9,270	413	78.2	91.5	341	(2.40)	--	
08/30/06	11.12	7.18	4,900	135	45.5	73.3	180	(2.40)	0.37/0.62	
09/29/06	11.61	6.69	12,300	243	142	290	634	(2.50)	--	
10/13/06	12.01	6.29	19,300	292	169	384	1,080	(1.84)	--	
11/03/06	12.12	6.18	9,300	655	233	366	729	(4.15)	2.0/1.05	
12/26/06	11.41	6.89	2,600	61	50	74	250	(<0.50)	--	
01/11/07	11.45	6.85	5,200	160	190	170	570	(<0.50)	--	
01/30/07	12.21	6.09	2,200	160	20	84	200	(<2.5)	1.37/0.79	
03/01/07	10.40	7.90	520	0.50	0.53	3.3	15	(<0.50)	--	
04/26/07	10.51	7.79	5,700 k	220	140	170	420	(<2.0)	--	
06/01/07	11.00	7.30	4,300 k	150	150	140	380	(<2.0)	0.36/0.23	
06/21/07	11.78	6.52	9,000 k	540	500	350	870	(1.8 m)	--	
07/03/07	11.64	6.66	4,500 k	230	160	160	440	(<5.0)	--	
08/16/07	12.12	6.18	8,800 k	550	520	430	1,020	(<5.0)	0.3/0.1	
12/06/07	12.43	5.87	2,600	110	84	64	180	(2.4)	--	
02/25/08	9.55	8.75	620	100	4.1	4.9	2.0	<5.0	2.48	
05/26/08	11.53	6.77	7,200	350	200	220	510	<100	1.52/0.99	
08/18/08	12.45	5.85	7,000	420	160	180	460	<100	0.70/0.67	

Pangea

Table 1. Groundwater Elevation and Analytical Data - Saberi, 1230 14th Street, Oakland, CA

Well ID	Date Measured	DTW (feet)	GWE (feet) (MSL)	TPHg (ug/L)	Benzene (ug/L)	Toluene (ug/L)	Ethylbenzene (ug/L)	Xylenes (ug/L)	MTBE (ug/L)	Dissolved Oxygen (mg/L)
<i>(VW/MW-2 cont'd)</i>	11/20/08	13.09	5.21	3,400	86	84	75	230	<50	0.93/1.47
	02/18/09	11.35	6.95	1,400	3.5	16	7.2	28	<15	0.77/1.18
	05/26/09	10.76	7.54	1,000	9.5	26	17	56	<5.0	0.84/1.19
VW/MW-4 <i>18.14</i>	03/25/96	8.45	9.69	83,000	6,500	7,000	2,000	11,000	<250	--
	03/25/96	8.45	9.69	84,000	6,400	7,000	2,100	12,000	<250	--
	06/21/96	10.38	7.76	110,000	14,000	15,000	3,700	17,000	1,700	--
	06/21/96	10.38	7.76	100,000	12,000	12,000	2,900	13,000	<1,000	--
	09/26/96	12.43	5.71	52,000	13,000	2,700	2,100	3,200	<500	--
	12/19/96	11.87	6.27	75,000	15,000	6,600	3,000	7,600	<1,250	--
	03/25/97	9.60	8.54	56,000	4,700	1,500	2,500	6,300	580	2.4
	06/26/97	12.36	5.78	--	--	--	--	--	--	--
	09/26/97	12.82	5.32	--	--	--	--	--	--	0.4
	12/05/97	12.15	5.99	--	--	--	--	--	--	0.3
	02/19/98	5.85	12.29	4,100	320	40	44	520	<50	1.8
	02/19/98	5.85	12.29	4,300	340	44	47	540	<50	1.8
	06/08/98	5.87	12.27	--	--	--	--	--	--	1.8
	08/25/98	10.96	7.18	--	--	--	--	--	--	2.5
	12/28/98	11.28	6.86	--	--	--	--	--	--	0.9
	03/26/99	8.45	9.69	--	--	--	--	--	--	1.9
	06/30/99	9.70	8.44	--	--	--	--	--	--	3.6
	09/30/99	11.78	6.36	--	--	--	--	--	--	2.6
	12/27/99	12.63	5.51	33,900	3,740	2,000	1,130	5,090	587	0.4/0.2
	01/21/00	13.07	5.07	13,900	1,560	568	227	1,990	<500(21.0a)	1.0
	03/07/00	7.82	10.32	--	--	--	--	--	--	0.9
	04/17/00	9.18	8.96	--	--	--	--	--	--	1.4/1.9
	04/18/00	--	--	757	103	8.59	30.8	84.2	<25.0	--
	09/21/00	12.18	5.96	--	--	--	--	--	--	5.0
	10/17/00	12.03	6.11	8,360	2,060	391	468	1,170	147	0.7/0.8
	01/09/01	12.42	5.72	--	--	--	--	--	--	0.9
	04/27/01	10.13	8.01	7,100	2,300	50	460	250	(<10)	1.0/1.4
	07/03/01	11.42	6.72	--	--	--	--	--	--	1.2
	12/06/01	11.02	7.12	7,700	750	90	300	350	(<25)	2.5/1.9
	01/23/02	8.89	9.25	--	--	--	--	--	--	0.4
	04/17/02	9.89	8.25	4,800	760	27	240	150	(<25)	4.7/5.1
	07/18/02	11.37	6.77	--	--	--	--	--	--	0.6
	11/11/02	12.41	5.73	14,000	2,800	480	700	1,300	(<100)	0.3/0.3
	01/16/03	9.17	8.97	--	--	--	--	--	--	0.8
	03/13/03	9.85	8.29	--	--	--	--	--	--	1.1
	04/23/03	9.74	8.40	2,400	710	28	160	100	(<50)	0.2/0.05
	05/13/03	9.70	8.44	3,300	720	35	170	160	(<50)	0.2/0.2
	06/13/03	10.55	7.59	8,200	1,700	220	460	790	(<250)	0.3/0.3
	07/14/03	10.90	7.24	3,700	900	190	220	540	(<10)	0.5/0.4
	09/29/03	11.83	6.31	7,500	1,800	300	390	860	(<20)	0.5/0.6
	10/29/03	12.03	6.11	10,000	2,600	400	510	1,200	(<13)	0.5/0.4
	01/05/04	9.60	8.54	1,000	70	12	30	56	(<1.0)	1.7/1.2
04/01/04	9.00	9.14	1,000	64	7.0	22	18	(<1.0)	0.6/0.1	
07/02/04	11.00	7.14	5,600	1,500	57	380	180	(<10)	0.4/0.4	
11/03/04	11.85	6.29	9,400	2,400	210	560	890	(<10)	1.5/2.1	
01/04/05	8.89	9.25	110	12	<0.50	2.3	<1.0	(<0.50)	2.40/1.05	
04/13/05	7.25	10.89	<50	<0.50	<0.50	<0.50	<0.50	(<0.50)	1.55/0.52	
07/13/05	10.20	7.94	1,300	520	5.1	100	17	(<2.5)	0.08/0.08	
10/28/05	11.84	6.30	2,500	830	44	170	140	(5.4)	0.6/0.2	
01/17/06	8.05	10.09	<50	<0.50	<0.50	0.56	<0.50	(<0.50)	2.7/0.6	
02/23/06	8.77	9.37	--	1.42	0.930	0.580	<0.500	--	--	
03/09/06	6.75	11.39	--	<0.500	<0.500	<0.500	0.680	--	--	
04/21/06	5.69	12.45	<50.0	<0.500	<0.500	<0.500	<0.500	(<0.500)	--	
05/01/06	6.65	11.49	<50.0	<0.500	<0.500	<0.500	<0.500	(<0.500)	0.51/0.37	
06/23/06	9.22	8.92	920	8.69	1.32	5.63	9.68	(<0.500)	--	
07/11/06	9.22	8.92	<50.0	109	<0.500	3.91	<0.500	(<0.500)	--	
08/30/06	10.87	7.27	2,360	331	12.8	65.4	29.3	(2.64)	0.24/0.56	
09/29/06	11.40	6.74	5,920	327	23.2 i	146	112 i	(2.63)	--	
10/13/06	11.53	6.61	6,560	299	16.6	134	90.4	(3.58)	--	
11/03/06	11.87	6.27	3,530	212	9.14	87.8	52.8	(5.11)	2.60/4.0	
12/26/06	11.17	6.97	960	43	1.0	17	2.7	(<0.50)	--	
01/11/07	11.18	6.96	830	86	1.8	41	3.9	(1.40)	--	
01/30/07	11.53	6.61	2,100	450	15	99	46	(3.0)	1.13/0.91	
03/01/07	10.00	8.14	700	4.8	<0.50	1.8	0.77	(<0.50)	--	
04/26/07	10.26	7.88	930 k	84	5.2	21	9.5	(<1.0)	--	
06/01/07	10.80	7.34	2,000 k	340	7.6	58	17.6	(1.7 m)	0.46/0.42	
06/21/07	11.32	6.82	1,400 k	360	9.7	46	26.1	(2.2)	--	
07/03/07	11.39	6.75	2,700 k	650	24	91	65	(<2.0)	--	
08/16/07	11.87	6.27	1,400 k	240	8.8	32	42.3	(<5.0)	0.3/0.1	
12/06/07	12.40	5.74	3,600	480	16	39	29	(3.5)	--	

Pangea

Table 1. Groundwater Elevation and Analytical Data - Saberi, 1230 14th Street, Oakland, CA

Well ID	Date Measured	DTW (feet)	GWE (feet) (MSL)	TPHg (ug/L)	Benzene (ug/L)	Toluene (ug/L)	Ethylbenzene (ug/L)	Xylenes (ug/L)	MTBE (ug/L)	Dissolved Oxygen (mg/L)
<i>(VW/MW-4 cont'd)</i>	02/25/08	9.39	8.75	56	22	<0.5	<0.5	0.50	<5.0	4.61
	05/26/08	11.27	6.87	650	76	7.9	4.9	<0.5	<5.0	0.95/0.96
	08/18/08	12.23	5.91	2,700	540	28	28	71	<25	0.78/0.79
	11/20/08	12.87	5.27	2,000	390	19	13	49	<50	1.17/0.95
	02/18/09	11.29	6.85	850	17	11	3.6	25	<15	0.82/1.02
	05/26/09	10.55	7.59	540	16	11	1.3	1.1	<10	0.81/1.06
VW/AS-1 <i>18.60</i>	03/25/96	8.98	9.62	--	--	--	--	--	--	--
	06/21/96	10.95	7.65	--	--	--	--	--	--	--
	09/26/96	12.98	5.62	--	--	--	--	--	--	--
	12/19/96	12.67	5.93	--	--	--	--	--	--	--
	03/25/97	10.12	8.48	--	--	--	--	--	--	--
	06/26/97	12.34	6.26	--	--	--	--	--	--	--
	09/26/97	13.40	5.20	--	--	--	--	--	--	--
	12/05/97	11.96	6.64	--	--	--	--	--	--	5.2
	02/19/98	6.22	12.38	--	--	--	--	--	--	1.3
	06/08/98	6.20	12.40	--	--	--	--	--	--	1.0
	08/25/98	11.59	7.01	--	--	--	--	--	--	1.6
	12/28/98	11.74	6.86	--	--	--	--	--	--	1.3
	03/26/99	9.20	9.40	--	--	--	--	--	--	1.3
	06/30/99	11.08	7.52	--	--	--	--	--	--	2.1
	09/30/99	11.94	6.66	--	--	--	--	--	--	1.9
	12/27/99	11.01	7.59	8,940	2,000	95.7	1,200	570	606	1.6/1.8
	03/07/00	7.35	11.25	--	--	--	--	--	--	--
	04/17/00	9.08	9.52	--	--	--	--	--	--	1.9/2.0
	04/18/00	--	--	20,800	6,550	1,220	2,270	1,720	<250	--
	09/21/00	11.98	6.62	--	--	--	--	--	--	2.1
	10/17/00	12.62	5.98	38,400	7,240	5,980	1,960	5,730	534(72.4)	2.5/1.0
	01/09/01	13.03	5.57	--	--	--	--	--	--	1.9
	04/27/01	10.71	7.89	34,000	8,000	2,100	2,500	2,000	(<25)	2.9/2.1
	07/03/01	12.03	6.57	--	--	--	--	--	--	2.0
	12/06/01	11.63	6.97	6,000	990	35	820	59	(<25)	1.2/0.8
	01/23/02	9.34	9.26	--	--	--	--	--	--	0.9
	04/17/02	10.41	8.19	12,000	2,900	57	1,400	98	(<200)	3.3/2.9
	07/18/02	12.13	6.47	--	--	--	--	--	--	0.3
	11/11/02	13.15	5.45	2,200	340	7.3	250	24	(<20)	1.2/1.3
	01/16/03	9.73	8.87	--	--	--	--	--	--	2.3
	03/13/03	10.45	8.15	11,000	2,500	55	1,800	170	(<100)	2.1/1.9
	04/07/03	10.40	8.20	--	--	--	--	--	--	--
04/23/03	10.28	8.32	9,500	4,100	200	1,400	200	(<250)	1.2/0.4	
05/13/03	10.26	8.34	9,700	2,300	110	1,100	140	(<250)	0.5/2.0	
06/13/03	11.15	7.45	9,300	2,300	77	820	<100	(<500)	1.0/0.5	
07/15/03	11.62	6.98	5,500	2,000	230	620	360	(20)	1.8/1.9	
09/29/03	12.48	6.12	9,600	2,300	100	1,200	670	(<20)	2.3/3.6	
10/29/03	12.73	5.87	10,000	2,000	39	1,000	370	(16)	3.3/3.6	
01/05/04	10.25	8.35	2,000	710	18	410	18	(13)	3.0/2.8	
04/01/04	9.60	9.00	27,000	9,100	1,200	2,200	1,400	(<50)	1.0/1.4	
07/02/04	11.80	6.80	18,000	6,500	170	1,200	1,200	(<50)	3.2/0.8	
11/03/04	12.56	6.04	4,500	1,700	23	280	55	(9.8)	1.7/1.9	
01/04/05	9.50	9.10	7,500	2,500	74	540	110	(<13)	1.19/0.53	
04/13/05	7.84	10.76	34,000	6,600	290	930	2,100	(<15)	1.60/1.88	
07/13/05	10.90	7.70	--	--	--	--	--	--	--	
07/22/05	10.96	7.64	8,200	5,900	86	340	320	(<25)	1.7/1.0	
10/28/05	12.30	6.30	2,100	1,300	18	63	21	(<5.0)	0.5/1.6	
01/17/06	8.65	9.95	6,200 g	2,900	190	400	600	(4.70)	1.4/1.0	
02/23/06	9.33	9.27	--	3,080	222	414	778	--	--	
03/09/06	7.40	11.20	--	1,350	88.5	128	164	--	--	
04/21/06	6.44	12.16	18,200	4,460	167	419	717	(2.79)	--	
05/01/06	7.22	11.38	19,700	5,300	261	664	1,050	(<0.500)	0.71/1.23	
06/23/06	9.73	8.87	20,600	3,820	305	259	435	(3.31 h)	--	
07/11/06	9.73	8.87	9,130	6,200	108	232	254	(<0.500)	--	
08/30/06	11.60	7.00	164,000	3,190	6,240	3,780	17,900	(<10.0)	0.4	
09/29/06	11.97	6.63	130,000	6,160	6,370 i	2,910	11,600 i	(<25.0)	--	
10/13/06	12.18	6.42	144,000	6,320	5,710	2,930	13,100	(1.03)	--	
11/03/06	12.21	6.39	112,000	8,290	5,670	2,760	12,100	(<0.500)	0.80	
12/26/06	11.74	6.86	94,000	6,900	5,100	3,100	13,000	(<50)	--	
01/11/07	11.83	6.77	73,000	6,600	5,500	3,000	12,000	(<50)	--	
01/30/07	12.12	6.48	54,000	6,800	4,500	2,200	8,800	(<50)	1.16/1.16	
03/01/07	10.71	7.89	52,000	6,300	3,700	3,400	12,000	(<50)	--	
04/26/07	10.84	7.76	72,000 k	7,200	4,500	3,000	10,900	(<50)	--	
06/01/07	11.40	7.20	70,000 k	7,600	4,900	3,200	12,100	(<50)	0.60/1.09	

Pangea

Table 1. Groundwater Elevation and Analytical Data - Saberi, 1230 14th Street, Oakland, CA

Well ID	Date Measured	DTW (feet)	GWE (feet) (MSL)	TPHg (ug/L)	Benzene (ug/L)	Toluene (ug/L)	Ethylbenzene (ug/L)	Xylenes (ug/L)	MTBE (ug/L)	Dissolved Oxygen (mg/L)
<i>(VW/AS-1 cont'd)</i>	06/21/07	11.92	6.68	59,000 k	7,300	3,700	3,200	12,100	<50	--
	07/03/07	11.98	6.62	70,000 k	8,800	4,700	3,500	13,500	<50	--
	08/16/07	12.53	6.07	67,000 k	9,000	5,500	3,900	14,200	<50	0.2/0.1
	12/06/07	12.97	5.63	180,000	9,500	5,000	4,100	16,000	<17	--
	02/25/08	9.84	8.76	47,000	3,500	1,200	1,500	4,400	<350	2.39
	05/26/08	11.88	6.72	82,000	8,100	3,000	3,100	12,000	<500	1.65/1.05
	06/27/08				VW/AS-1 drilled out and replaced with AS-1					
VW/AS-2	03/09/06	6.95	--	--	--	--	--	--	--	--
VW/AS-3	03/25/96	8.50	9.67	--	--	--	--	--	--	--
<i>18.17</i>	06/21/96	10.42	7.75	--	--	--	--	--	--	--
	09/26/96	12.49	5.68	--	--	--	--	--	--	--
	12/19/96	12.28	5.89	--	--	--	--	--	--	--
	03/25/97	9.61	8.56	--	--	--	--	--	--	--
	06/26/97	11.80	6.37	--	--	--	--	--	--	--
	09/26/97	12.89	5.28	--	--	--	--	--	--	--
	12/05/97	11.38	6.79	--	--	--	--	--	--	1.8
	02/19/98	6.24	11.93	--	--	--	--	--	--	1.3
	06/08/98	6.25	11.92	--	--	--	--	--	--	1.2
	08/25/98	11.43	6.74	--	--	--	--	--	--	1.3
	12/28/98	11.63	6.54	--	--	--	--	--	--	1.7
	03/26/99	8.92	9.25	--	--	--	--	--	--	1.5
	06/30/99	10.71	7.46	--	--	--	--	--	--	2.5
	09/30/99	11.78	6.39	--	--	--	--	--	--	1.5
	12/27/99	12.57	5.60	488	47.9	2.60	16.9	8.50	35.4	1.5/2.1
	03/07/00	4.82	13.35	--	--	--	--	--	--	--
	04/17/00	8.69	9.48	--	--	--	--	--	--	2.0/2.4
	04/18/00	--	--	3,110	871	<5.00	141	56.8	78.2	--
	09/21/00	11.65	6.52	--	--	--	--	--	--	2.5
	10/17/00	12.13	6.04	7,730	2,700	<50.0	542	344	<250(42.1)	1.6/1.0
	01/09/01	12.51	5.66	--	--	--	--	--	--	2.2
	04/27/01	10.20	7.97	14,000	3,900	62	690	560	(46)	2.8/1.6
	07/03/01	11.55	6.62	--	--	--	--	--	--	2.6
	12/06/01	11.10	7.07	5,000	1,200	19	380	320	<50	0.9/1.1
	01/23/02	8.93	9.24	--	--	--	--	--	--	1.1
	04/17/02	10.00	8.17	17,000	5,000	<25	1,100	390	<250	3.2/3.2
	07/18/02	11.49	6.68	--	--	--	--	--	--	0.4
	11/11/02	12.43	5.74	1,700	290	1.5	150	2.8	<10	1.0/1.1
	01/16/03	9.32	8.85	--	--	--	--	--	--	4.7
	03/13/03	9.88	8.29	--	--	--	--	--	--	2.7
	04/23/03	9.85	8.32	150	47	0.67	8.5	3.2	<5.0	2.1/0.7
	05/13/03	9.81	8.36	440	35	<0.50	1.7	<1.0	<5.0	1.4/1.8
	06/13/03	10.77	7.40	580	71	<2.5	40	<5.0	<25	1.1/0.6
	07/14/03	11.12	7.05	1,100	120	4.9	63	9.3	(16)	2.0/2.2
	09/29/03	12.02	6.15	160	54	2.2	6.9	8.7	(1.1)	4.1/1.6
	10/29/03	12.25	5.92	350	16	<0.50	1.1	<1.0	(6.3)	3.2/1.6
	01/05/04	9.74	8.43	2,700	870	39	130	250	(5.5)	3.6/2.8
	04/01/04	9.06	9.11	1,300	240	4.1	36	45	(12.0)	1.1/1.0
	07/02/04	11.29	6.88	610	59	<1.0	3.6	<2.0	(10.0)	2.0/2.2
	11/03/04	12.02	6.15	200	<0.50	<0.50	<0.50	<1.0	(10.0)	2.1/2.3
	01/04/05	8.99	9.18	2,500	730	42	36	190	<10	1.72/1.36
	04/13/05	7.25	10.92	<50	1.6	<0.50	<0.50	<0.50	(0.61)	2.85/3.04
	07/13/05	10.30	7.87	--	--	--	--	--	--	--
	07/22/05	10.51	7.66	160	36	0.65	<0.50	2.5	(2.60)	1.4/1.3
	10/28/05	11.93	6.24	100	<0.50	<0.50	<0.50	<1.0	(1.70)	1.6/0.9
	01/17/06	8.25	9.92	1,400	510	29	16	47	(5.40)	1.9/0.8
	04/21/06	6.06	12.11	--	--	--	--	--	--	--
	05/01/06	6.83	11.34	1,350	74.4	<0.500	12.5	0.520	(3.30)	1.35/0.78
	08/30/06	11.00	7.17	940	77.7	2.67	2.94	5.57	(3.45)	0.80/0.98
	09/29/06	11.30	6.87	--	--	--	--	--	--	--
	11/03/06	12.29	5.88	346 j	83.6 j	5.17 j	2.34 j	13.5 j	(3.47 j)	1.10/0.80
	01/30/07	12.59	5.58	130	13	0.64	<0.50	7.2	(3.4)	0.76/0.64
	06/01/07	10.82	7.35	2,200 k	650	13	3.2 m	143	(7.8)	1.21/0.93
	08/16/07	11.95	6.22	1,000 k	200	4.0	1.1	47.7	(3.3)	0.8/0.2
	12/06/07	12.43	5.74	<50	<0.5	<0.5	<0.5	<0.5	<0.5	--
	02/25/08	9.40	8.77	<50	<0.5	<0.5	<0.5	<0.5	<5.0	3.14
	05/26/08	11.20	6.97	1,800	260	6.0	4.3	35	<17	0.86/4.39
	6/26/2008						Well Destroyed			

Pangea

Table 1. Groundwater Elevation and Analytical Data - Saberi, 1230 14th Street, Oakland, CA

Well ID	Date Measured	DTW (feet)	GWE (feet) (MSL)	TPHg (ug/L)	Benzene (ug/L)	Toluene (ug/L)	Ethylbenzene (ug/L)	Xylenes (ug/L)	MTBE (ug/L)	Dissolved Oxygen (mg/L)
Wells Installed September 2008										
MW-5R	07/02/08	11.91	--	22,000	4,100	710	750	2,300	<250	--
	08/18/08	12.59	--	27,000	3,100	340	780	2,100	<100	0.57/3.23
	11/20/08	13.24	--	23,000	5,200	470	1,200	1,500	<250	0.83/2.50
	02/18/09	11.58	--	32,000	4,500	610	990	1,400	<500	1.04/2.11
	05/26/09	10.92	--	15,000	3,500	520	680	1,500	<200	0.85/1.05
AS-1	07/02/08	12.08	--	28,000	390	350	620	2,500	<500	--
	08/18/08	13.05	--	1,500	12	6.1	6.7	91	<17	1.94/2.41
	11/20/08	13.69	--	640	2.4	2.7	1.0	8.5	<5.0	2.51/2.91
	02/18/09	12.09	--	270	1.1	2.2	<0.5	<0.5	<5.0	2.94/2.99
	05/26/09	11.40	--	250	1.7	0.70	<0.5	3.5	<5.0	3.01/2.94
AS-2	07/02/08	11.98	--	9,600	380	620	170	1,000	<50	--
AS-3	07/02/08	12.42	--	2,800	340	7.2	20	37	<50	--
DP-1	07/03/08	12.43	--	34,000	5,100	1,800	1,300	4,900	<350	--
DP-2	07/03/08	12.92	--	15,000	2,800	300	560	1,600	<150	--
DP-3	07/02/08	13.21	--	14,000	4,400	100	720	150	<350	--

Notes:

- a = Sample was analyzed outside of the EPA recommended holding time.
 - b = Hydrocarbon reported does not match the pattern of the laboratory's standard.
 - c = Top of casing change due to maintenance.
 - d = Sample contains discrete peak in addition to gasoline.
 - e = Quantity of unknown hydrocarbon(s) in sample based on gasoline.
 - f = The concentration reported reflects individual or discrete unidentified peaks not matching a typical fuel pattern.
 - g = The concentration indicated for this analyte is an estimated value above the calibration range of the instrument.
 - h = Secondary ion abundances were outside method requirements. Identification based on a⁻-lytical judgement.
 - i = Analyte was detected in the associated Method Blank.
 - j = pH>2
 - k = Analyzed by EPA Method 8015B (M).
 - l = The sample chromatographic pattern for TPH does not match the chromatographic pattern of the specified standard. Quantitation of the unknown hydrocarbon(s) in the sample was based upon the specified standard.
 - m = Analyte was detected at a concentration below the reporting limit and above the laboratory method detection limit. Reported value is estimated.
- Site surveyed November 1, 2001 by Virgil Chavez Land Surveying of Vallejo, CA.
 TPHg = Total petroleum hydrocarbons as gasoline by modified EPA Method 8015C.
 Benzene, Toluene, Ethylbenzene, and Xylenes by EPA Method 8260B from April 27, 2001 through August 16, 2007. Concentrations prior to April 27, 2001 and after August 16, 2007 by EPA Method 8021B.
 MTBE = Methyl tert-butyl ether by EPA Method 8021B, concentrations in parentheses by EPA Method 8260B
 -- = Not applicable
 ug/L = micrograms per liter (Parts per billion)
 mg/L = milligrams per liter (Parts per million)
 MSL = Mean sea level
 ft. = Feet
 <n = Below detection limit
 (D) = Duplicate sample
 n/n = Pre-purge/Post-purge Dissolved Oxygen Readings

Table 2 - Well Construction Details – 1230 14th Street, Oakland, CA

Well ID	Slot Size (inches)	Total Depth of Well (feet bgs)	Screened Interval (ft bgs)	Well Casing Nominal Diameter (inches)	Filter Pack Interval (ft bgs)	Casing Material
MW-1	0.020	22	7-22	2	6-27	PVC – Sched 40
MW-2	0.020	22.5	7.5-22.5	2	6-22.5	PVC – Sched 40
MW-3	0.020	21.5	7-21.5	2	6-21.5	PVC – Sched 40
MW-4	0.020	22	7-22	2	6-22	PVC – Sched 40
MW-5R	0.010	23	5-20	4	4-23	PVC – Sched 40
MW-6	0.020	20	5-20	4	4-20	PVC – Sched 40
MW-7	0.020	20	5-20	4	4-20	PVC – Sched 40
VW/MW-2	0.020	22	6-22	2	5-22	PVC – Sched 40
VW/MW-4	0.020	20	5-20	2	4-21.5	PVC – Sched 40
DP-1	0.010	23	8-20	4	7-23	PVC – Sched 40
DP-2	0.010	23	8-20	4	7-23	PVC – Sched 40
DP-3	0.010	23	8-20	4	7-23	PVC – Sched 40
AS-1	0.010	25	22-25	1	21-25	PVC – Sched 80
AS-2	0.010	25	22-25	1	21-25	PVC – Sched 80
AS-3	0.010	25	22-25	1	21-25	PVC – Sched 80
VMP-1	0.0057*	5	4.25-4.75	1/2	4-5	Stainless Steel/Polyethylene

bgs = below ground surface

* = pore screen size

APPENDIX A

Groundwater Monitoring Program

Table A. Quarterly Groundwater Monitoring Program During Active Remediation

1230 14th Street, Oakland, CA

Well ID	Well Type	Screened Interval (ft bgs)	Well Location for Monitoring	Casing Diam. (in)	Gauge Frequency	Sample Frequency ¹
Monitoring Wells						
MW-1	Mon	7-22	Downgradient	2	Q	Q
MW-2	Mon	7.5-22.5	S Upgradient	2	Q	Q
MW-3	Mon	7-21.5	W Upgradient	2	Q	Q
MW-4	Mon	7-22	NW Crossgradient	2	Q	Q
MW-5R	Mon	5-20	Source	4	Q	Q
MW-6	Mon	5-20	E Downgradient	4	Q	Q
MW-7	Mon	5-20	NE Downgradient	4	Q	Q
VMP-1	Vapor Monitoring	4.25-4.75	N Boundary (Downgradient)	1/2	--	--
Remediation/Monitoring Wells						
AS-1	Mon/Air Sparging	22-25	N Source	1	Q	Q
AS-2	Air Sparging	22-25	--	1	--	--
AS-3	Air Sparging	22-25	--	1	--	--
VW/MW-2	Mon/Vapor Extraction	6-22	W Crossgradient	2	Q	Q
VW/MW-4	Mon/Vapor Extraction	5-20	SW Downgradient	2	Q	Q
DP-1	Dual Phase Extraction (Rem)	8-20	--	4	Q	Q
DP-2	Dual Phase Extraction (Rem)	8-20	--	4	Q	Q
DP-3	Dual Phase Extraction (Rem)	8-20	--	4	Q	Q

Notes and Abbreviations:

1= Sample Analytes: Total Petroleum Hydrocarbons as Gasoline (TPHg), benzene, toluene, ethylbenzene, xylenes (BTEX) and methyl tertiary butyl ether (MTBE) by EPA Method 8015Cm/8021B.

Q = All four quarters. Typically B months (February, May, August, November)

Mon = Groundwater Monitoring Well

Rem= Remediation Well

VW = Vapor Extraction Well

VMP= Vapor Monitoring Well

DP = Dual Phase Extraction

N, S, W, E = Cardinal directions North, South, West, East and other directions (e.g., Northeast = NE)

-- = Not applicable, gauged or sampled.

Table B. Semi-Annual Groundwater Monitoring Program

1230 14th Street, Oakland, CA

Well ID	Well Type	Screened Interval (ft bgs)	Well Location for Monitoring	Casing Diam. (in)	Gauge Frequency	Sample Frequency ¹
Monitoring Wells						
MW-1	Mon	7-22	Downgradient	2	2nd, 4th	2nd, 4th
MW-2	Mon	7.5-22.5	S Upgradient	2	2nd, 4th	2nd
MW-3	Mon	7-21.5	W Upgradient	2	2nd, 4th	2nd
MW-4	Mon	7-22	NW Crossgradient	2	2nd, 4th	2nd
MW-5R	Mon	5-20	Source	4	2nd, 4th	2nd, 4th
MW-6	Mon	5-20	E Downgradient	4	2nd, 4th	2nd, 4th
MW-7	Mon	5-20	NE Downgradient	4	2nd, 4th	2nd, 4th
VMP-1	Vapor Monitoring	4.25-4.75	N Boundary (Downgradient)	1/2	--	--
Remediation/Monitoring Wells						
AS-1	Mon/Air Sparging	22-25	N Source	1	2nd, 4th	2nd, 4th
AS-2	Air Sparging	22-25	--	1	--	--
AS-3	Air Sparging	22-25	--	1	--	--
VW/MW-2	Mon/Vapor Extraction	6-22	W Crossgradient	2	2nd, 4th	2nd, 4th
VW/MW-4	Mon/Vapor Extraction	5-20	SW Downgradient	2	2nd, 4th	2nd, 4th
DP-1	Dual Phase Extraction (Rem)	8-20	--	4	--	--
DP-2	Dual Phase Extraction (Rem)	8-20	--	4	--	--
DP-3	Dual Phase Extraction (Rem)	8-20	--	4	--	--

Notes and Abbreviations:

1= Sample Analytes: Total Petroleum Hydrocarbons as Gasoline (TPHg), benzene, toluene, ethylbenzene, xylenes (BTEX) and methyl tertiary butyl ether (MTBE) by EPA Method 8015Cm/8021B.

2nd, 4th = Semi Annually during second and fourth quarter, typically May and November

2nd = Annually during second quarter, typically May

Mon = Groundwater Monitoring Well

Rem= Remediation Well

VW = Vapor Extraction Well

VMP= Vapor Monitoring Well

DP = Dual Phase Extraction

N, S, W, E = Cardinal directions North, South, West, East and other directions (e.g., Northeast = NE)

-- = Not applicable, gauged or sampled.

APPENDIX B

Groundwater Monitoring Field Data Sheets

Well Gauging Data Sheet

Project.Task #:1150.001 219				Project Name: Saberi - 1230 14th St.			
Address:1230 14th Street, Oakland, CA						Date:5/26/09	
Name: Sanjiv Gill				Signature: 			
Well ID	Well Size (in.)	Time	Depth to Immiscible Liquid (ft)	Thickness of Immiscible Liquid (ft)	Depth to Water (ft)	Total Depth (ft)	Measuring Point
MW-1	2"	7:50			11.18	21.32	TOC
MW-2	2"	7:20			10.31	22.02	TOC
MW-3	2"	7:15			10.62	18.65	TOC
MW-4	2"	7:10			10.47	19.81	TOC
MW-5R	4"	7:55			10.92	22.60	TOC
MW-6	4"	7:25			11.46	19.70	TOC
MW-7	4"	7:30			11.90	19.81	TOC
AS-1	1"	7:40			11.40	25.33	TOC
VW/MW-2	2"	7:45			10.76	21.89	TOC
VW/MW-4	2"	7:35			10.55	18.23	TOC

Comments:

MONITORING FIELD DATA SHEET

Well ID: MW-2

Project.Task #: 1150.001 219		Project Name: Saberi - 1230 14th St.							
Address: 1230 14th Street, Oakland, CA									
Date: 5/26/09		Weather: <u>Sunny</u>							
Well Diameter: <u>2"</u>		Volume/ft. <table border="1"> <tr> <td>1" = 0.04</td> <td>3" = 0.37</td> <td>6" = 1.47</td> </tr> <tr> <td>2" = 0.16</td> <td>4" = 0.65</td> <td>radius** 0.163</td> </tr> </table>		1" = 0.04	3" = 0.37	6" = 1.47	2" = 0.16	4" = 0.65	radius** 0.163
1" = 0.04	3" = 0.37	6" = 1.47							
2" = 0.16	4" = 0.65	radius** 0.163							
Total Depth (TD): <u>22.02</u>		Depth to Product:							
Depth to Water (DTW): <u>10.31</u>		Product Thickness:							
Water Column Height: <u>11.71</u>		1 Casing Volume: <u>1.87</u> gallons							
Reference Point: TOC		<u>3</u> Casing Volumes: <u>5.61</u> gallons							
Purging Device: <u>Disposable Bailer</u> 3" PVC Bailer, Parastaltic Pump									
Sampling Device: Disposable Bailer									
Time	Temp ©	pH	Cond (µs)	NTU	DO(mg/L)	ORP (mV)	Vol(gal)	DTW	
9:45	18.7	6.93	604				2		
9:47	18.7	6.90	621				4		
9:50	18.1	6.92	628				5.5		

Comments: YSI 550A DO meter pre purge DO = 1.03 mg/l
 post purge DO = 1.49 mg/l
turbid

Sample ID: <u>MW-2</u>	Sample Time: <u>9:53</u>
Laboratory: McCampbell Analytical, INC.	Sample Date: 5/26/09
Containers/Preservative: Voa/HCl	
Analyzed for: 8015, 8021	
Sampler Name: Sanjiv Gill	Signature: 

MONITORING FIELD DATA SHEET

Well ID: MW-7

Project.Task #: 1150.001 219			Project Name: Saberi - 1230 14th St.						
Address: 1230 14th Street, Oakland, CA									
Date: 5/26/09			Weather: <u>Sunny</u>						
Well Diameter: <u>4"</u>			Volume/ft.		1" = 0.04		3" = 0.37		6" = 1.47
					2" = 0.16		4" = 0.65		radius ² * 0.163
Total Depth (TD): <u>19.81</u>			Depth to Product:						
Depth to Water (DTW): <u>11.90</u>			Product Thickness:						
Water Column Height: <u>7.91</u>			1 Casing Volume: <u>5.14</u>			gallons			
Reference Point: TOC			3 Casing Volumes: <u>15.42</u>			gallons			
Purging Device: Disposable Bailer (<u>3" PVC Bailer</u>), Parastaltic Pump									
Sampling Device: Disposable Bailer									
Time	Temp (°C)	pH	Cond (µs)	NTU	DO(mg/L)	ORP (mV)	Vol(gal)	DTW	
<u>10:35</u>	<u>18.9</u>	<u>7.24</u>	<u>629</u>				<u>5</u>		
<u>10:40</u>	<u>19.3</u>	<u>7.21</u>	<u>630</u>				<u>10</u>		
<u>10:45</u>	<u>19.6</u>	<u>7.21</u>	<u>633</u>				<u>15.5</u>		

Comments: YSI 550A DO meter pre purge DO = 1.02 mg/l
 post purge DO = 1.77 mg/l

very turbid, silty

Sample ID: <u>MW-7</u>		Sample Time: <u>10:48</u>	
Laboratory: McCampbell Analytical, INC.		Sample Date: 5/26/09	
Containers/Preservative: Voa/HCl			
Analyzed for: 8015, 8021			
Sampler Name: Sanjiv Gill		Signature: 	

MONITORING FIELD DATA SHEET

Well ID: AS-1

Project.Task #: 1150.001 219		Project Name: Saberi - 1230 14th St.						
Address: 1230 14th Street, Oakland, CA								
Date: 5/26/09		Weather: <u>Sunny</u>						
Well Diameter: <u>1"</u>		Volume/ft. 1" = 0.04 3" = 0.37 6" = 1.47 2" = 0.16 4" = 0.65 radius* = 0.163						
Total Depth (TD): <u>25.33</u>		Depth to Product:						
Depth to Water (DTW): <u>11.40</u>		Product Thickness:						
Water Column Height: <u>13.93</u>		1 Casing Volume: <u>0.55</u> gallons						
Reference Point: TOC		<u>3</u> Casing Volumes: <u>1.65</u> gallons						
Purging Device: <u>Disposable Bailer</u> , 3" PVC Bailer, Parastaltic Pump _____								
Sampling Device: Disposable Bailer								
Time	Temp ©	pH	Cond (µs)	NTU	DO(mg/L)	ORP (mV)	Vol(gal)	DTW
<u>11:25</u>	<u>18.9</u>	<u>6.99</u>	<u>772</u>				<u>0.5</u>	
<u>11:26</u>	<u>18.6</u>	<u>7.03</u>	<u>740</u>				<u>1.0</u>	
<u>11:27</u>	<u>18.7</u>	<u>7.10</u>	<u>735</u>				<u>1.5</u>	

Comments: YSI 550A DO meter pre purge DO = 3.01 mg/l out of hole
 post purge DO = 2.94 mg/l out of hole
inhib

Sample ID: <u>AS-1</u>	Sample Time: <u>11:30</u>
Laboratory: McCampbell Analytical, INC.	Sample Date: 5/26/09
Containers/Preservative: Voa/HCl	
Analyzed for: 8015, 8021	
Sampler Name: Sanjiv Gill	Signature: <u>[Signature]</u>

MONITORING FIELD DATA SHEET

Well ID: **VH-MW-2**

Project Task #: 1150.001 219		Project Name: Saberi - 1230 14th St.						
Address: 1230 14th Street, Oakland, CA								
Date: 5/26/09		Weather: Sunny						
Well Diameter: 2"	Volume/ft.	1" = 0.04	3" = 0.37					
		2" = 0.16	4" = 0.65					
6" = 1.47		radius ² * 0.163						
Total Depth (TD): 21.89	Depth to Product:							
Depth to Water (DTW): 10.76	Product Thickness:							
Water Column Height: 11.13	1 Casing Volume: 1.78	gallons						
Reference Point: TOC	3 Casing Volumes: 5.34	gallons						
Purging Device: <u>Disposable Bailer</u> , 3" PVC Bailer, Parastaltic Pump								
Sampling Device: Disposable Bailer								
Time	Temp ©	pH	Cond (µs)	NTU	DO(mg/L)	ORP (mV)	Vol(gal)	DTW
11:45	18.8	7.24	601				1.5	
11:47	19.4	7.17	593				3	
11:50	19.1	7.12	640				5	

Comments: YSI 550A DO meter pre purge DO = **0.84** mg/l
 post purge DO = **1.19** mg/l

very turbid, silty

Sample ID: VH-MW-2	Sample Time: 11:53
Laboratory: McCampbell Analytical, INC.	Sample Date: 5/26/09
Containers/Preservative: Voac/HCl	
Analyzed for: 8015, 8021	
Sampler Name: Sanjiv Gill	Signature: 

MONITORING FIELD DATA SHEET

Well ID: VW-MW-4

Project.Task #: 1150.001 219				Project Name: Saberi - 1230 14th St.				
Address: 1230 14th Street, Oakland, CA								
Date: 5/26/09				Weather: <u>Sunny</u>				
Well Diameter: <u>2"</u>				Volume/ft.	1" = 0.04	3" = 0.37	6" = 1.47	radius ² * 0.163
				2" = 0.16	4" = 0.65			
Total Depth (TD): <u>18.23</u>				Depth to Product:				
Depth to Water (DTW): <u>10.55</u>				Product Thickness:				
Water Column Height: <u>7.68</u>				1 Casing Volume: <u>1.22</u>		gallons		
Reference Point: TOC				<u>3</u> Casing Volumes: <u>3.66</u>		gallons		
Purging Device: <u>Disposable Bailer</u> , 3" PVC Bailer, Parastaltic Pump								
Sampling Device: Disposable Bailer								
Time	Temp @	pH	Cond (µs)	NTU	DO(mg/L)	ORP (mV)	Vol(gal)	DTW
<u>11:05</u>	<u>19.2</u>	<u>7.10</u>	<u>735</u>				<u>1.5</u>	
<u>11:06</u>	<u>19.7</u>	<u>7.21</u>	<u>730</u>				<u>2.5</u>	
<u>11:07</u>	<u>19.4</u>	<u>7.23</u>	<u>730</u>				<u>3.5</u>	

Comments: YSI 550A DO meter pre purge DO = 0.81 mg/l
post purge DO = 1.06 mg/l

very turbid, silty

Sample ID: <u>VW-MW-4</u>		Sample Time: <u>11:10</u>	
Laboratory: McCampbell Analytical, INC.		Sample Date: 5/26/09	
Containers/Preservative: <u>Voa/HCl</u>			
Analyzed for: 8015, 8021			
Sampler Name: Sanjiv Gill		Signature: 	

APPENDIX C

Laboratory Analytical Report



McC Campbell Analytical, Inc.

"When Quality Counts"

1534 Willow Pass Road, Pittsburg, CA 94565-1701
Web: www.mcccampbell.com E-mail: main@mcccampbell.com
Telephone: 877-252-9262 Fax: 925-252-9269

Pangea Environmental Svcs., Inc. 1710 Franklin Street, Ste. 200 Oakland, CA 94612	Client Project ID: #1150.001; Saberi-1230 14th St.	Date Sampled: 05/26/09
	Client Contact: Erica Ray	Date Received: 05/26/09
	Client P.O.:	Date Reported: 06/01/09
		Date Completed: 06/01/09

WorkOrder: 0905495

June 01, 2009

Dear Erica:

Enclosed within are:

- 1) The results of the **10** analyzed samples from your project: **#1150.001; Saberi-1230 14th St.,**
- 2) A QC report for the above samples,
- 3) A copy of the chain of custody, and
- 4) An invoice for analytical services.

All analyses were completed satisfactorily and all QC samples were found to be within our control limits.

If you have any questions or concerns, please feel free to give me a call. Thank you for choosing

McC Campbell Analytical Laboratories for your analytical needs.

Best regards,

Angela Rydelius
Laboratory Manager
McC Campbell Analytical, Inc.

0905495

McCAMPBELL ANALYTICAL, INC.

110 2nd AVENUE SOUTH, #D7
PACHECO, CA 94553-5560

Website: www.mccampbell.com Email: main@mccampbell.com

Telephone: (925) 798-1620 Fax: (925) 798-1622

CHAIN OF CUSTODY RECORD

TURN AROUND TIME

EDF Required? Cell (Normal) No Write On (DW) No RUSH 24 HR 48 HR 72 HR 5 DAY

Report To: Erica Ray Bill To: Pangea Environmental

Company: Pangea Environmental Services, Inc.

1710 Franklin Street, Suite 200
Oakland, CA 94612 E-Mail: eray@pangeaenv.com

Tele: 510-836-3702 Fax: (510) 836-3709

Project #: 1150.001 Project Name: Saberi-1230 14th St

Project Location: 1230 14th St, Oakland, CA

Sampler Signature: Muskan Environmental Sampling

Analysis Request

Other

Comments

- BTEX & TPH as Gas (602/8020 + 8015)ANTBE
- TPH as Diesel (8015)
- Total Petroleum Oil & Grease (5520 E&F/D&F)
- Total Petroleum Hydrocarbons (418.1)
- EPA 601 / 8010 / 8021
- BTEX ONLY (EPA 602 / 8020)
- EPA 608 / 8081
- EPA 608 / 8082 PCB'S ONLY
- EPA 8140 / 8141
- EPA 8150 / 8151
- EPA 524.2 / 624 / 8260
- EPA 525 / 625 / 8270
- PAH's / PNA's by EPA 625 / 8270 / 8310
- CAM-17 Metals (6010 / 6020)
- LUFT 5 Metals (6010 / 6020)
- Lead (200.8 / 200.9 / 6010)

Filter Samples for Metals analysis: Yes / No

SAMPLE ID (Field Point Name)	LOCATION	SAMPLING		# Containers	Type Containers	MATRIX					METHOD PRESERVED		
		Date	Time			Water	Soil	Air	Sludge	Other	ICE	HCL	HNO ₃
MW-1		5-26-09	12:13	3	vog	X					X	X	X
MW-2			9:53										
MW-3			9:27										
MW-4			9:10										
MW-5R			12:38										
MW-6			10:23										
MW-7			10:48										
AS-1			11:30										
VW/MW-2			11:53										
VW/MW-4			11:10	X	X	X					X	X	X

Relinquished By: [Signature] Date: 5-26-09 Time: 1410 Received By: [Signature]

Relinquished By: Date: Time: Received By:

Relinquished By: Date: Time: Received By:

ICE/ 6.2 COMMENTS:
 GOOD CONDITION ✓
 HEAD SPACE ABSENT ✓
 DECHLORINATED IN LAB ✓
 APPROPRIATE CONTAINERS ✓
 PRESERVED IN LAB ✓
 VOAS ✓ D&G METALS OTHER
 PRESERVATION pH<2

McC Campbell Analytical, Inc.



1534 Willow Pass Rd
Pittsburg, CA 94565-1701
(925) 252-9262

CHAIN-OF-CUSTODY RECORD

WorkOrder: 0905495

ClientCode: PEO

WriteOn
 EDF
 Excel
 Fax
 Email
 HardCopy
 ThirdParty
 J-flag

Report to:	Erica Ray	Email: eray@pangeaenv.com	Bill to:	Bob Clark-Riddell	Requested TAT: 5 days
	Pangea Environmental Svcs., Inc.	cc:		Pangea Environmental Svcs., Inc.	Date Received: 05/26/2009
	1710 Franklin Street, Ste. 200	PO:		1710 Franklin Street, Ste. 200	Date Printed: 05/26/2009
	Oakland, CA 94612	ProjectNo: #1150.001; Saberi-1230 14th St.		Oakland, CA 94612	
	(510) 836-3700 FAX (510) 836-3709				

Lab ID	Client ID	Matrix	Collection Date	Hold	Requested Tests (See legend below)												
					1	2	3	4	5	6	7	8	9	10	11	12	
0905495-001	MW-1	Water	5/26/2009 12:13	<input type="checkbox"/>	A	A											
0905495-002	MW-2	Water	5/26/2009 9:53	<input type="checkbox"/>	A												
0905495-003	MW-3	Water	5/26/2009 9:27	<input type="checkbox"/>	A												
0905495-004	MW-4	Water	5/26/2009 9:10	<input type="checkbox"/>	A												
0905495-005	MW-5R	Water	5/26/2009 12:38	<input type="checkbox"/>	A												
0905495-006	MW-6	Water	5/26/2009 10:23	<input type="checkbox"/>	A												
0905495-007	MW-7	Water	5/26/2009 10:48	<input type="checkbox"/>	A												
0905495-008	AS-1	Water	5/26/2009 11:30	<input type="checkbox"/>	A												
0905495-009	VW/MW-2	Water	5/26/2009 11:53	<input type="checkbox"/>	A												
0905495-010	VW/MW-4	Water	5/26/2009 11:10	<input type="checkbox"/>	A												

Test Legend:

1	G-MBTEX_W	2	PREDF REPORT	3		4		5	
6		7		8		9		10	
11		12							

Prepared by: Maria Venegas

Comments:

NOTE: Soil samples are discarded 60 days after results are reported unless other arrangements are made (Water samples are 30 days).
Hazardous samples will be returned to client or disposed of at client expense.



Sample Receipt Checklist

Client Name: **Pangea Environmental Svcs., Inc.**

Date and Time Received: **05/26/09 2:16:23 PM**

Project Name: **#1150.001; Saberi-1230 14th St.**

Checklist completed and reviewed by: **Maria Venegas**

WorkOrder N°: **0905495** Matrix Water

Carrier: Client Drop-In

Chain of Custody (COC) Information

- Chain of custody present? Yes No
- Chain of custody signed when relinquished and received? Yes No
- Chain of custody agrees with sample labels? Yes No
- Sample IDs noted by Client on COC? Yes No
- Date and Time of collection noted by Client on COC? Yes No
- Sampler's name noted on COC? Yes No

Sample Receipt Information

- Custody seals intact on shipping container/cooler? Yes No NA
- Shipping container/cooler in good condition? Yes No
- Samples in proper containers/bottles? Yes No
- Sample containers intact? Yes No
- Sufficient sample volume for indicated test? Yes No

Sample Preservation and Hold Time (HT) Information

- All samples received within holding time? Yes No
- Container/Temp Blank temperature Cooler Temp: 6.2°C NA
- Water - VOA vials have zero headspace / no bubbles? Yes No No VOA vials submitted
- Sample labels checked for correct preservation? Yes No
- TTLC Metal - pH acceptable upon receipt (pH<2)? Yes No NA
- Samples Received on Ice? Yes No

(Ice Type: WET ICE)

* NOTE: If the "No" box is checked, see comments below.

Client contacted:

Date contacted:

Contacted by:

Comments:



McC Campbell Analytical, Inc.

"When Quality Counts"

1534 Willow Pass Road, Pittsburg, CA 94565-1701
Web: www.mcccampbell.com E-mail: main@mcccampbell.com
Telephone: 877-252-9262 Fax: 925-252-9269

Pangea Environmental Svcs., Inc. 1710 Franklin Street, Ste. 200 Oakland, CA 94612	Client Project ID: #1150.001; Saberi-1230 14th St.	Date Sampled: 05/26/09
	Client Contact: Erica Ray	Date Received: 05/26/09
	Client P.O.:	Date Extracted: 05/28/09-05/30/09
		Date Analyzed: 05/28/09-05/30/09

Gasoline Range (C6-C12) Volatile Hydrocarbons as Gasoline with BTEX and MTBE*

Extraction method: SW5030B

Analytical methods: SW8021B/8015Bm

Work Order: 0905495

Lab ID	Client ID	Matrix	TPH(g)	MTBE	Benzene	Toluene	Ethylbenzene	Xylenes	DF	% SS	Comments
001A	MW-1	W	750	ND	31	7.1	3.5	23	1	115	d1
002A	MW-2	W	ND	ND	ND	ND	ND	ND	1	109	
003A	MW-3	W	ND	ND	ND	ND	ND	ND	1	101	
004A	MW-4	W	ND	ND	ND	ND	ND	ND	1	100	b1
005A	MW-5R	W	15,000	ND<200	3500	520	680	1500	10	98	d1
006A	MW-6	W	ND	ND	ND	ND	ND	ND	1	99	
007A	MW-7	W	ND	ND	2.8	0.60	ND	ND	1	105	
008A	AS-1	W	250	ND	1.7	0.70	ND	3.5	1	117	d6
009A	VW/MW-2	W	1000	ND	9.5	26	17	56	1	104	d1
010A	VW/MW-4	W	540	ND<10	16	11	1.3	1.1	1	109	d1

Reporting Limit for DF =1; ND means not detected at or above the reporting limit	W	50	5.0	0.5	0.5	0.5	0.5	0.5	μg/L
	S	1.0	0.05	0.005	0.005	0.005	0.005	0.005	mg/Kg

* water and vapor samples and all TCLP & SPLP extracts are reported in ug/L, soil/sludge/solid samples in mg/kg, wipe samples in μg/wipe, product/oil/non-aqueous liquid samples in mg/L.

cluttered chromatogram; sample peak coelutes with surrogate peak.

+The following descriptions of the TPH chromatogram are cursory in nature and McC Campbell Analytical is not responsible for their interpretation:

b1) aqueous sample that contains greater than ~1 vol. % sediment
d1) weakly modified or unmodified gasoline is significant
d6) one to a few isolated non-target peaks present in the TPH(g) chromatogram



QC SUMMARY REPORT FOR SW8021B/8015Bm

W.O. Sample Matrix: Water

QC Matrix: Water

BatchID: 43427

WorkOrder 0905495

EPA Method SW8021B/8015Bm		Extraction SW5030B							Spiked Sample ID: 0905497-002A			
Analyte	Sample	Spiked	MS	MSD	MS-MSD	LCS	LCSD	LCS-LCSD	Acceptance Criteria (%)			
	µg/L	µg/L	% Rec.	% Rec.	% RPD	% Rec.	% Rec.	% RPD	MS / MSD	RPD	LCS/LCSD	RPD
TPH(btex) [£]	ND	60	112	121	7.22	115	117	1.21	70 - 130	20	70 - 130	20
MTBE	ND	10	90.6	96.2	6.04	92.4	96.9	4.74	70 - 130	20	70 - 130	20
Benzene	ND	10	92.9	96.6	3.91	91.1	90.7	0.447	70 - 130	20	70 - 130	20
Toluene	ND	10	90.9	97	6.49	91.6	91.2	0.546	70 - 130	20	70 - 130	20
Ethylbenzene	ND	10	90.4	96.4	6.41	90.6	90.4	0.214	70 - 130	20	70 - 130	20
Xylenes	ND	30	92.2	98.1	6.28	92.6	92.2	0.454	70 - 130	20	70 - 130	20
%SS:	100	10	100	101	0.273	99	99	0	70 - 130	20	70 - 130	20

All target compounds in the Method Blank of this extraction batch were ND less than the method RL with the following exceptions:
NONE

BATCH 43427 SUMMARY

Lab ID	Date Sampled	Date Extracted	Date Analyzed	Lab ID	Date Sampled	Date Extracted	Date Analyzed
0905495-001A	05/26/09 12:13 PM	05/28/09	05/28/09 2:11 PM	0905495-002A	05/26/09 9:53 AM	05/28/09	05/28/09 5:42 AM
0905495-003A	05/26/09 9:27 AM	05/28/09	05/28/09 6:42 AM	0905495-004A	05/26/09 9:10 AM	05/28/09	05/28/09 7:12 AM
0905495-005A	05/26/09 12:38 PM	05/28/09	05/28/09 7:43 AM	0905495-006A	05/26/09 10:23 AM	05/28/09	05/28/09 9:13 AM
0905495-007A	05/26/09 10:48 AM	05/28/09	05/28/09 9:46 AM	0905495-008A	05/26/09 11:30 AM	05/30/09	05/30/09 2:37 AM
0905495-009A	05/26/09 11:53 AM	05/28/09	05/28/09 3:43 PM	0905495-010A	05/26/09 11:10 AM	05/28/09	05/28/09 10:19 AM

MS = Matrix Spike; MSD = Matrix Spike Duplicate; LCS = Laboratory Control Sample; LCSD = Laboratory Control Sample Duplicate; RPD = Relative Percent Deviation.

% Recovery = 100 * (MS-Sample) / (Amount Spiked); RPD = 100 * (MS - MSD) / ((MS + MSD) / 2).

MS / MSD spike recoveries and / or %RPD may fall outside of laboratory acceptance criteria due to one or more of the following reasons: a) the sample is inhomogenous AND contains significant concentrations of analyte relative to the amount spiked, or b) the spiked sample's matrix interferes with the spike recovery.

£ TPH(btex) = sum of BTEX areas from the FID.

cluttered chromatogram; sample peak coelutes with surrogate peak.

N/A = not enough sample to perform matrix spike and matrix spike duplicate.

NR = matrix interference and/or analyte concentration in sample exceeds spike amount for soil matrix or exceeds 2x spike amount for water matrix or sample diluted due to high matrix or analyte content, or inconsistency in sample containers.