



Subsurface Consultants, Inc.

ENVIRONMENTAL PROTECTION

98 AUG 24 PM 3:18

R. William Rudolph, P.E.
President

August 19, 1998
SCI 971.001

Mr. Thomas Peacock
Alameda County Health Care Services Agency
Department of Environmental Health
1131 Harbor Bay Parkway, 2nd Floor
Alameda, California 94502

*in lieu of
found.*

Work Plan

Additional Investigation

3250 School Street, STID ~~4907~~ 4905
Oakland, California

Dear Mr. Peacock:

This letter presents a work plan for additional investigation of the referenced site. Subsurface Consultants, Inc. (SCI) was retained by the property owner, Shiloh Christian Fellowship, to prepare this work plan. In a letter dated December 12, 1996 and a follow-up notice dated June 29, 1998, the Alameda County Health Care Services Agency (ACHCSA) indicated that they had reviewed SCI's Underground Tank Removal and Supplemental Excavation Report dated October 22, 1996 and determined that additional investigation was needed to define the lateral and vertical extent of contamination in the area of the former gasoline tanks. The ACHCSA December 12, 1996 letter specifically requested that at least two borings be drilled, one near previous sample location AB-3 and one near previous sample location AB-5, where detectable levels of benzene were identified at the limits of excavation. The overall objective of this phase of investigation will be to preliminarily evaluate whether vadose zone contamination has migrated to groundwater.

PROJECT BACKGROUND

The subject property was occupied by a gasoline service station which had ~~two gasoline and one waste oil underground tanks~~. The service station building was demolished in preparation of the construction of a supplemental parking lot for parishioners of Shiloh Christian Fellowship. In May 1995, SCI observed the removal of the three tanks and the overexcavation of about 60 cubic yards of impacted soil. Confirmation soil samples obtained at the limits of the excavations documented the following:

Mr. Thomas Peacock
Alameda County Health Care Services Agency
August 19, 1998
SCI 971.001
Page 2

Waste Oil Tank Area - Confirmation samples were non-detectable for petroleum hydrocarbons, volatile organic compounds, and semi-volatile organic compounds. ACHCSA concurred that neither additional investigation nor remedial activities were required.

Gasoline Tank Area - Confirmation samples contained relatively low concentrations of the contaminants of concern. The maximum contaminant concentrations left-in-place at a depth of 12 feet are summarized below:

Total Volatile Hydrocarbons	76 milligrams per kilogram (mg/kg)
Benzene	0.043 mg/kg
Toluene	0.280 mg/kg
Ethylbenzene	0.290 mg/kg
Total Xylenes	0.720 mg/kg
Lead	4.0 mg/kg

The tank excavations were backfilled with imported clean baserock materials and the areas were resurfaced to allow for automobile parking.

SCOPE OF SERVICES

The scope of services provided herein will provide current data to assess the vertical extent of soil contamination and whether shallow groundwater has been impacted by previous tank releases. SCI's scope of services will comprise the following tasks:

- Task 1 - Additional Investigation Near Sampling Locations AB-3 and AB-5 Near the Former Gasoline Tank Pit
- Task 2 - Report Preparation

These tasks are further described below.

Task 1 - Additional Investigation Near Sampling Locations AB-3 and AB-5 Near the Former Gasoline Tank Pit

SCI will obtain soil and grab groundwater samples (if groundwater is encountered) from two test borings drilled near sampling locations AB-3 and AB-5, where benzene concentrations measured following supplemental excavation were 0.0091 and 0.043 mg/kg, respectively. The proposed locations of the new borings are presented on the attached Site Plan.

Prior to field activities, SCI will obtain a drilling permit from the Alameda County Public Works Agency. SCI will retain the services of a licensed drilling contractor to drill and sample soil from the borings to a maximum depth of approximately 25 feet, using direct-push technologies. As

Mr. Thomas Peacock
Alameda County Health Care Services Agency
August 19, 1998
SCI 971.001
Page 3

requested by the ACHCSA, if groundwater is encountered at or above the 25-foot depth, then a grab groundwater sample will also be obtained. After sampling is completed, the borings will be filled with cement grout and surface patched to match existing conditions.

Up to six samples (six soil or four soil and two grab groundwater samples) will be submitted to a state-certified laboratory for chemical analyses. As requested, the chemical testing program will include analyses for total volatile hydrocarbons as gasoline, benzene, toluene, ethylbenzene, and xylenes, methyl-tertiary-butyl-ether, and polynuclear aromatic hydrocarbons.

Task 2 - Report Preparation

SCI will prepare a report summarizing the field investigation, sampling methodology, and data from chemical analyses. The report will include laboratory analysis reports and chain-of-custody documents, data summary tables, discussion and evaluation of the data, and conclusions and recommendations.

SCI is ready to implement this work plan pending your favorable review and upon receipt of cost pre-approval from the Fund. If you have any questions, please call either of the undersigned.

Very truly yours,

Subsurface Consultants, Inc.



Dennis Alexander
Field Technician



Jeriann Alexander, PE, REA
Project Manager





DA:JNA:TJM:ly proposed.wrk\971 wkpl.doc

2 copies submitted

Attachments: Site Plan



cc: Robert Duggan
Shiloh Christian Fellowship
3295 School Street
Oakland, California 94692

261-2057 x 161

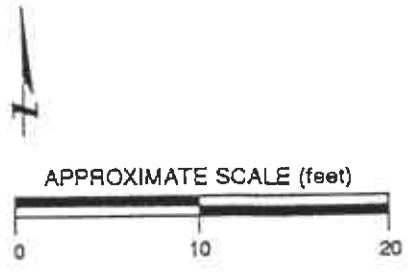
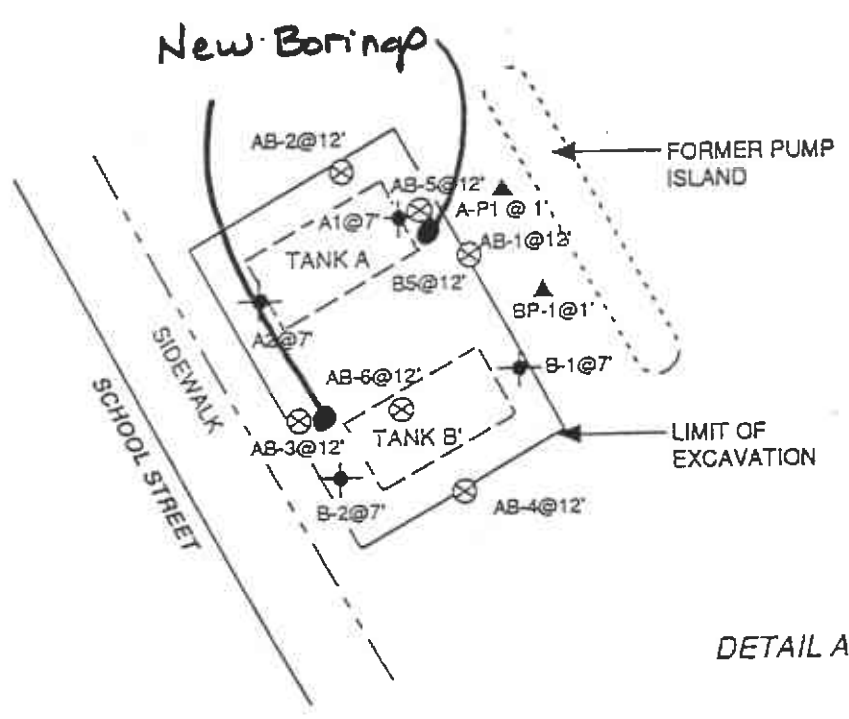
-  A1@7' TANK SOIL SAMPLE LOCATION (5/24/95)
-  AB-1@7' CONFIRMATION SOIL SAMPLE LOCATION (5/25/95)
-  BP1@1' PRODUCT LINE SOIL SAMPLE LOCATION (5/24/95)
-  PROPERTY BOUNDARY LINE



DETAIL A

-  C1@8' TANK SOIL SAMPLE LOCATION (5/24/95)
-  C5@10' CONFIRMATION SOIL SAMPLE LOCATION (3/22/96)

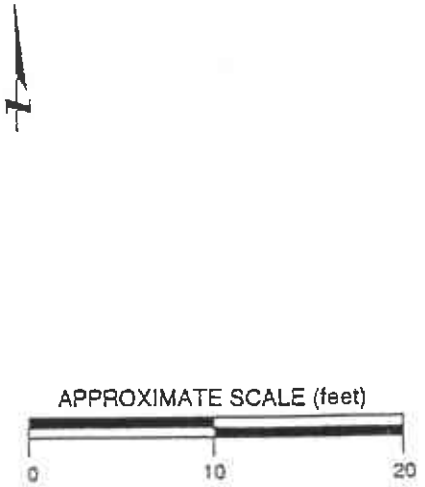
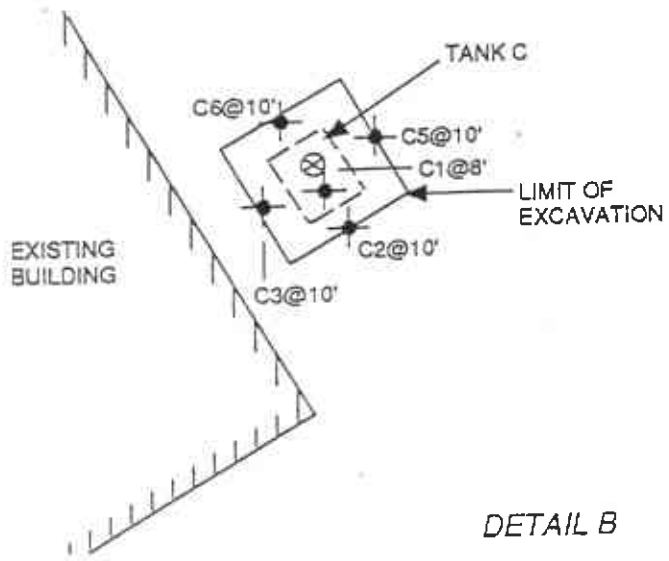

DETAIL B

DETAIL A AND DETAIL B

Subsurface Consultants

SHILOH CHRISTIAN FELLOWSHIP
OAKLAND, CA

JOB NUMBER	DATE	APPROVED
971.001	5/7/96	

PLATE
2