

2957

my 11/2/99 Her comments on this report.

ENVIRONMENTAL PROTECTION 99 NOV 10 PM 2:02

**ADDITIONAL SITE CHARACTERIZATION REPORT
744 EAST 12th STREET, OAKLAND**

Introduction: The site is located at the northeast corner of the intersection of East 12th Street and 8th Avenue in Oakland, California (Figure 1). This report discusses the additional site characterization, which included installation of three groundwater monitoring wells, two hydropunch borings, and collecting soil and groundwater samples at the site. The additional site characterization was conducted to determine the extent of petroleum contamination at the site.

Site History: One 500-gallon underground storage tank (UST) was previously located at the site. The UST reportedly contained gasoline and was removed in April 1996. Based on drawings provided in the Tank Closure Report, the physical size of the former tank is estimated to be 5 feet long by 4 feet in diameter. The tank was reportedly empty and had not been used for 10 years prior to being removed. During removal of the UST, it was noted that the single-walled steel tank had rusted through and had leaked. The approximate surface area of the removal excavation was 11 feet by 6 feet and the UST was located in the southwestern end of the excavation. Approximately 20 cubic yards of soil was over-excavated and transported off site for disposal. The bottom of the excavation was approximately 8 to 12 feet below the ground surface (bgs). The exact depth to the bottom of the UST was not recorded during the removal activities; the estimated depth to the bottom of the former UST is 6 feet bgs.

Five soil samples were collected from the sidewalls and bottom of the removal excavation. The soil samples were analyzed for benzene, toluene, ethylbenzene, and xylenes (BTEX), total petroleum hydrocarbons (TPH) as gasoline (TPH-g), and total lead. The highest concentrations of BTEX and TPH-g were detected in the southwestern end of the excavation. Groundwater was not encountered during removal of the UST.

Monitoring Well Installation: Three monitoring wells, identified on Figure 2 as MW-1, MW-2, and MW-3, were installed at the site during the additional site characterization. The monitoring well completion forms are presented in Appendix A. The location of MW-3 was moved northeast (closer to the former location of the UST) from the proposed location in the Work Plan. The change in the location of MW-3 was due to underground and overhead utility lines present at the site. The monitoring wells were advanced by using a continuous-flight, hollow-stem auger (HSA) drill rig. One soil sample was collected from each of the monitoring well borings at depths ranging from 10.5 to 12.5 feet bgs.

Soil cores were collected with a continuous core sampling tool for lithologic logging and analytical sampling purposes. The soil samples were collected in the vadose zone of each monitoring well boring and analyzed for BTEX, methyl tertiary-butyl ether (MTBE), and TPH-g.

The three monitoring wells were constructed of 2-inch-diameter, flush-joint, threaded, schedule 40 polyvinyl chloride (PVC) casing installed through the hollow stem auger. The bottom 10 feet of each monitoring well consisted of 0.010-inch (10 slot), machine-slotted well screen and was plugged with a

threaded end PVC cap. The casing joints formed water-tight unions, and no chemical cements, glues, oils, or solvents were used during the drilling activities or during construction of the wells.

The filter pack between the screened casing and the boring for each well was backfilled with clean, well-rounded, number 2\12 Monterey kiln-dried sand. The sand layer was placed to extend above the monitoring well screen for a distance of 1 foot for each of the wells. A seal of 3/8-inch bentonite chips (the annular seal) approximately 1-foot thick was placed above the filter pack. Distilled water was added to the annular seal and hydrated for at least 30 minutes prior to emplacement of the grout seal for each well. From the top of the bentonite seal to the ground surface, the annular space was filled with a cement-bentonite slurry (grout seal) consisting of neat cement grout with approximately 7 percent powdered bentonite.

The monitoring wells were completed with waterproof, traffic-rated, flush-mount protective boxes (Christy boxes). Each well head was equipped with an expandable, locking well cap.

Monitoring Well Development: The monitoring wells were developed by mechanical surging and pumping of the groundwater. Mechanical surging equipment consisted of a vented surge block attached to drill rod, of sufficient weight to cause the block to drop rapidly on the down stroke, forcing water contained within the well and the filter pack around the well into the surrounding aquifer. The initial surging action was relatively gentle to prevent blockage of the well screen. As water began to move easily both into and out of the screen, the surge block was lowered incrementally to the bottom of the well. The surge block was then gently raised and lowered inside the well casing below the groundwater surface for a minimum of 10 minutes for each well. Periodically during surging, a pump was used to remove dislodged sediment and/or well sand that had accumulated at the bottom of the well during the surging process. The pH, temperature, electrical conductivity, and turbidity of the development water were monitored to assess the physical properties of the groundwater; development was complete when the physical properties of the groundwater had stabilized.

Hydropunch Sampling: As part of the additional site characterization, two hydropunch borings, shown as SB-1 and SB-2 on Figure 2, were advanced at the site. An underground cable and pipe locator was used to find the metallic pipeline that exited the UST excavation; this pipeline was used to transport gasoline from the former UST to a former gas pump within the building next to the former UST. The pipeline runs approximately 40 feet into the building, then turns 90 degrees toward the southwestern wall of the building, approximately 17 feet away from this wall of the building. SB-1 was completed near the corner of this pipeline. The Work Plan called for the location of SB-2 to be located in the area of the former gas pump. SB-2 was relocated (to the location shown on Figure 2) in order to determine the extent of soil and groundwater contamination southwest of the former UST location because the soil cuttings from MW-3 showed signs of contamination.

A macro-core soil sampler, a 2-inch outside-diameter by 48-inch long continuous sampling tool, was used to collect soil from the borings for lithologic logging and analytical sampling purposes. Soil samples were collected in a 1.5-inch-diameter clear acetate sleeve. One soil sample was collected from the vadose zone in each boring and analyzed for BTEX, MTBE, and TPH-g.

Each hydropunch boring was advanced at least 5 feet into the saturated groundwater zone. A grab groundwater sample was collected from each boring and analyzed for BTEX, MTBE, and TPH-g.

The Work Plan called for only one groundwater sample to be collected from the hydropunch location near the underground pipeline (SB-1). However, a grab groundwater sample was also collected from SB-2 in order to determine the extent of contamination southwest of MW-3.

Site Lithology: Boring logs for the additional site characterization monitoring wells and hydropunch borings show that the soil underlying the site consists primarily of low plasticity clay from the surface to about 9 to 14 feet bgs. The clay overlies a sand and gravel zone. Hydrocarbon staining on the soil was detected in the boring for MW-3 at 8 to 11 feet bgs, and in SB-2 at 4 to 7 feet bgs. The sand and gravel zone is primarily where groundwater was encountered at the site. Groundwater was first encountered in the borings at depths from about 12 to 18 feet bgs. The groundwater appears to be slightly confined by the upper clay zone. After installation of the monitoring wells, the static water level was measured at depths ranging from 4.8 to 6.7 feet bgs. The boring logs are presented in Appendix B.

Groundwater Flow Direction and Gradient: Groundwater elevations were measured in the groundwater monitoring wells on June 7, 1999 during the additional site characterization sampling activities. The depth to groundwater from the top of casing at each well, the top of casing elevations for each well, and the groundwater elevations measured at the site are shown in Table 1. The groundwater flow direction and gradient were calculated using these data. The groundwater flow direction is south 70 degrees west (S70W), as shown on Figure 3; this flow direction follows the site topography. MW-3 is downgradient from the location of the former UST, and MW-1 and MW-2 are slightly upgradient to the north and southeast (respectively) of the former UST location. The groundwater gradient was calculated to be 0.005 feet/foot (ft/ft).

Laboratory Analytical Program: For the additional site characterization, the soil and groundwater samples were sent to Curtis & Tompkins Analytical Laboratories (C&T), in Berkeley, California for analysis. C&T is a California state-certified laboratory. Analyses for BTEX and MTBE were conducted using U.S. Environmental Protection Agency (US EPA) Method 8021B. Analyses for TPH-g were conducted using US EPA Method 8015M.

Groundwater Sample Analytical Results: Benzene was only detected in the groundwater sample collected from MW-3 at a concentration of 14 micrograms per liter (ug/L). Toluene and xylene compounds were only detected in the grab groundwater sample collected from SB-2 at concentrations of 0.63 and 2.2 ug/L, respectively. Ethylbenzene and TPH-g were not detected in the groundwater samples collected from the site. MTBE was detected in four of the five groundwater samples at concentrations ranging from 3 to 250 ug/L; MTBE was not detected in the groundwater sample collected from SB-1. Table 2 presents the analytical results of the groundwater samples. Figure 4 shows the concentrations of MTBE detected in groundwater at the site. The highest concentration of MTBE (250 ug/L) was detected in the groundwater sample collected from MW-3. The complete laboratory analytical package is provided in Appendix C.

Soil Sample Analytical Results: BTEX and TPH-g were not detected in the soil samples collected during the additional site characterization. MTBE is the only chemical compound that was detected in the soil samples. MTBE was detected in the soil samples collected from SB-2 and MW-3 at concentrations of 32 and 950 micrograms per kilogram (ug/Kg), respectively; MTBE was not detected in the remaining soil samples. Table 3 presents the analytical results of the additional site characterization soil samples. The complete laboratory analytical package is provided in Appendix C.

Conclusions and Recommendations: The analytical results of the additional site characterization samples and visual observation of the soil conditions during drilling activities show that some contamination is present at the site. Most of the contamination in the soil and groundwater is localized around MW-3. No mobile or potentially mobile free product appears to be present at the site. It is recommended that quarterly sampling should be started at the site. However, TtEMI recommends that the analytical data for the site be scrutinized by the Alameda County Health Care Services Agency to determine if 4 quarters (or less) of analytical data will be required for site closure. It is also recommended that the site be compared against the City of Oakland risk-based corrective action guidelines to determine if it is suitable for closure.

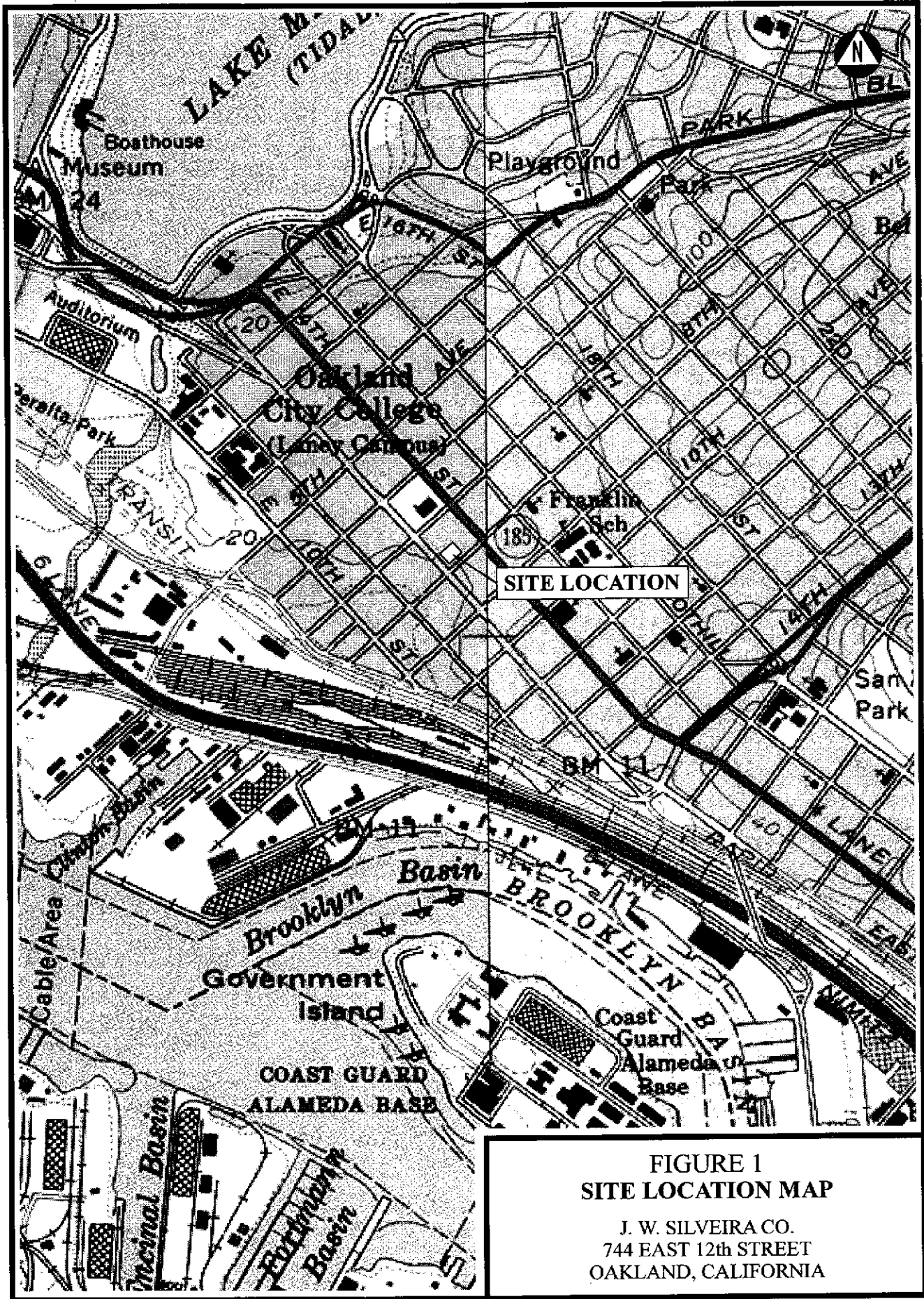

SITE LOCATION

**FIGURE 1
SITE LOCATION MAP**

J. W. SILVEIRA CO.
744 EAST 12th STREET
OAKLAND, CALIFORNIA

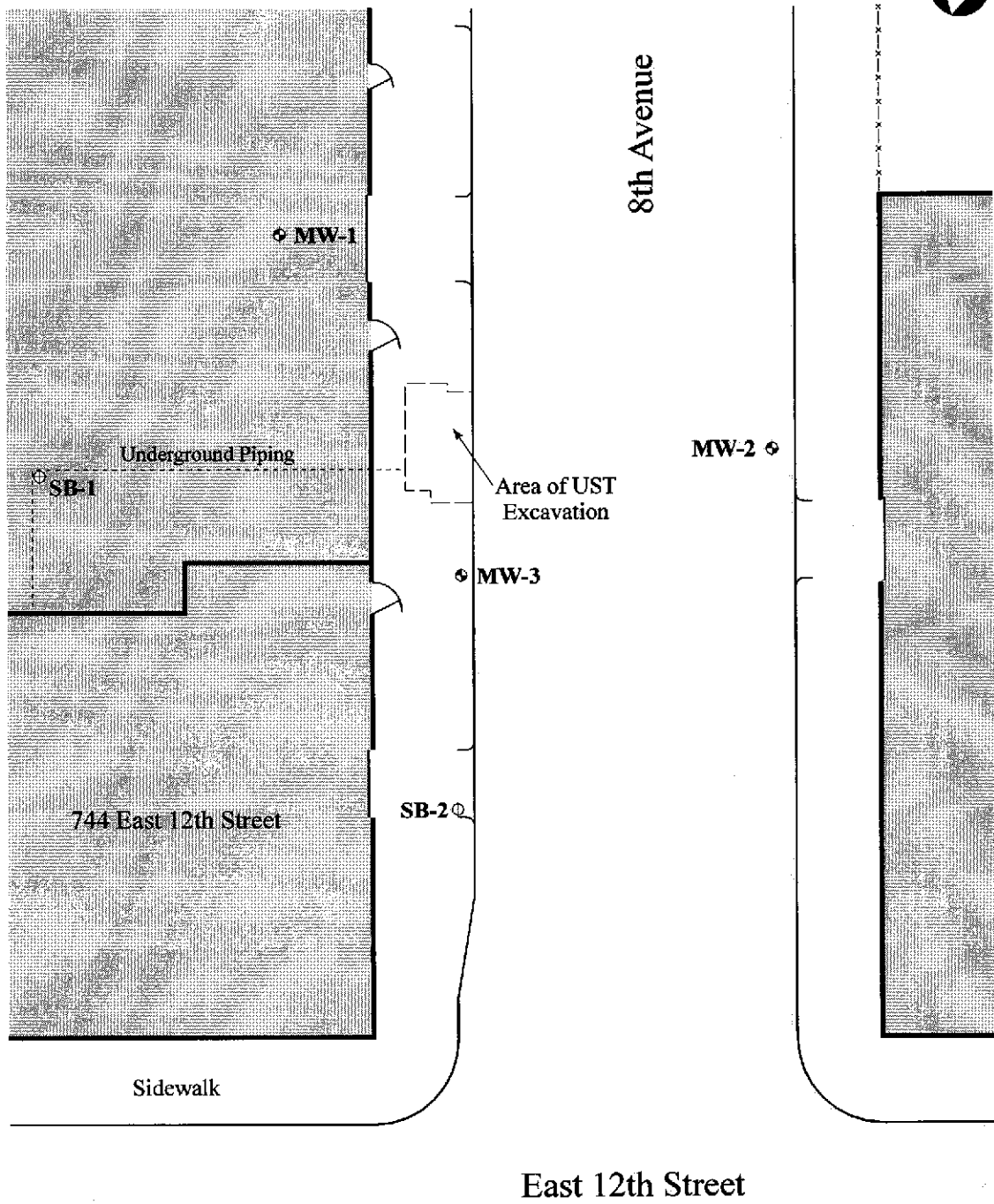

Notes:

- ◊ Monitoring Well (MW)
- Soil Boring (SB)

Scale: 1 inch = 20 feet

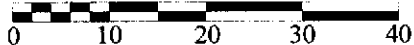

**FIGURE 2
MONITORING WELL
AND SOIL BORING LOCATIONS**

J. W. SILVEIRA CO.
744 EAST 12th STREET
OAKLAND, CALIFORNIA

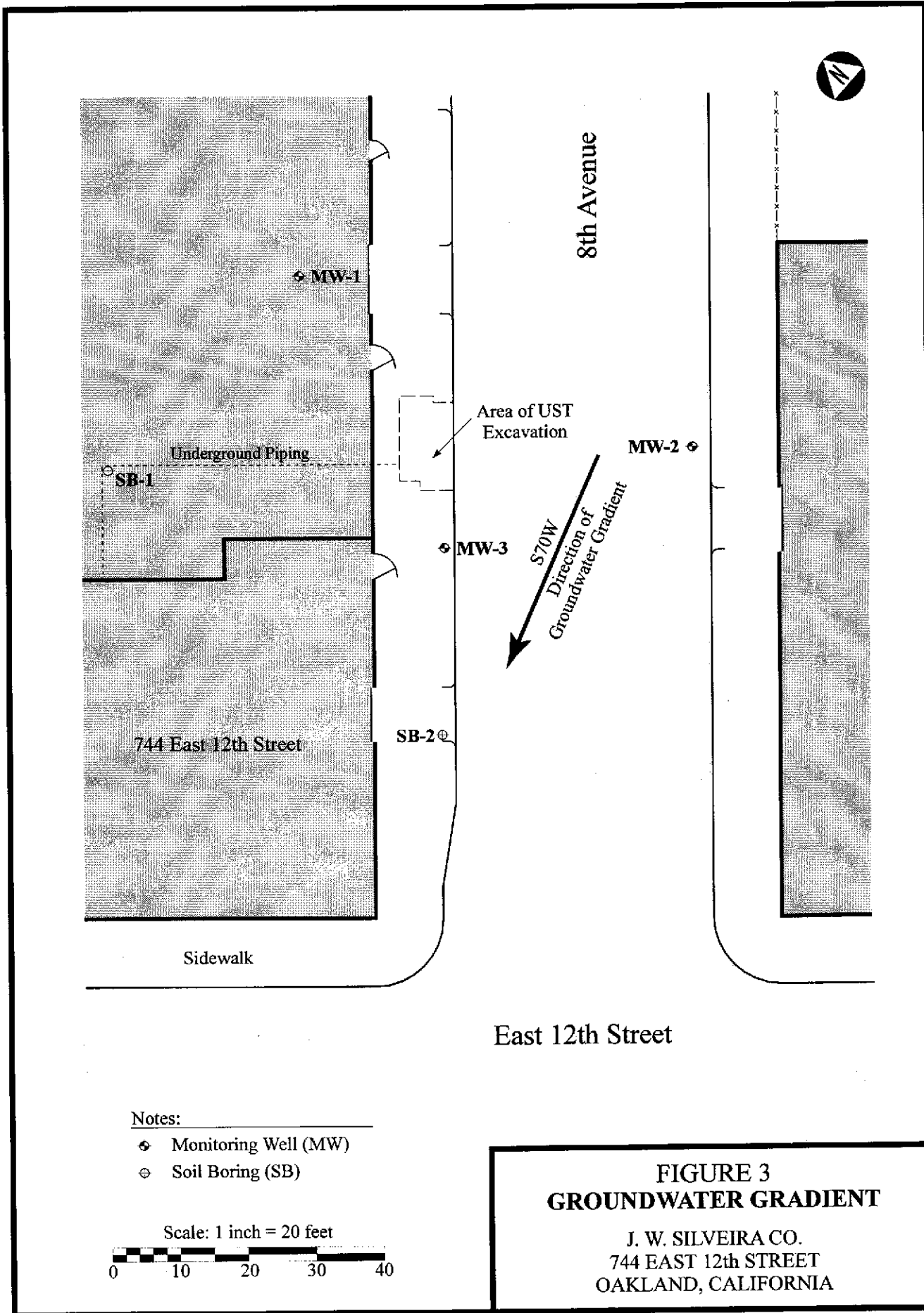

Notes:

- ◆ Monitoring Well (MW)
- ⊙ Soil Boring (SB)

Scale: 1 inch = 20 feet

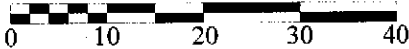

**FIGURE 3
GROUNDWATER GRADIENT**

J. W. SILVEIRA CO.
744 EAST 12th STREET
OAKLAND, CALIFORNIA

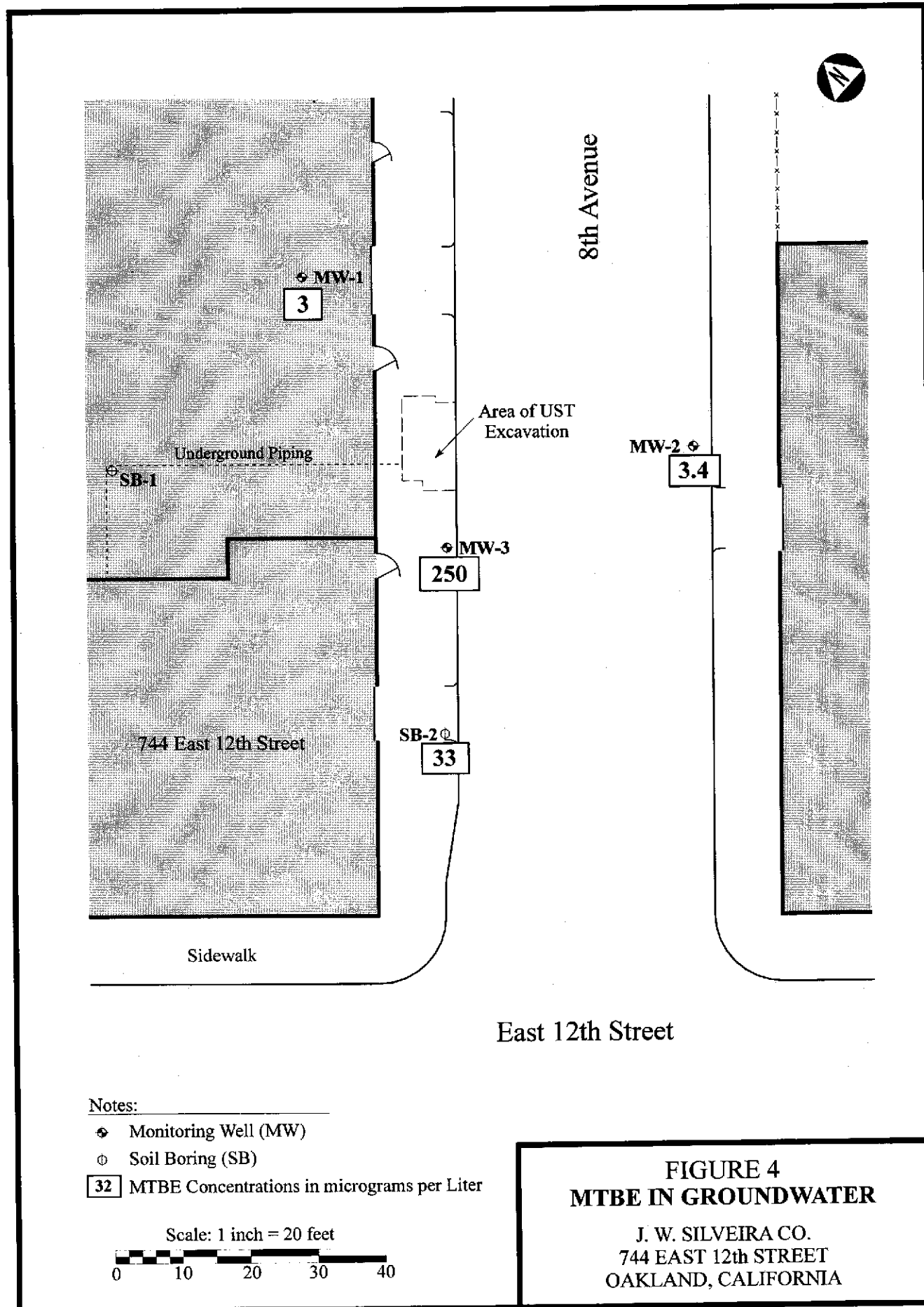

TABLE 1
GROUNDWATER ELEVATIONS
744 EAST 12TH STREET

Date	Groundwater Elevations from TOC		
	MW-1	MW-2	MW-3
6/7/99	8.52	8.51	8.37

Notes:

ft feet

MW-1 TOC Elevation: 18.17 ft

MW-2 TOC Elevation: 16.71 ft

MW-3 TOC Elevation: 16.35 ft

TOC Top of Casing

TABLE 2
VOC AND TPH COMPOUNDS IN GROUNDWATER
FROM MONITORING WELLS AND SOIL BORINGS, 1999
744 EAST 12TH STREET

Analyte	Monitoring Well			Soil Boring	
	MW-1	MW-2	MW-3	SB-1	SB-2
VOC (µg/L)					
Benzene	ND	ND	14	ND	ND
Ethylbenzene	ND	ND	ND	ND	ND
Toluene	ND	ND	ND	ND	0.63
m,p-Xylenes	ND	ND	ND	ND	2.2
o-Xylene	ND	ND	ND	ND	0.74
MTBE	3	3.4	250	ND	33
TPH (µg/L)					
Gasoline	ND	ND	ND	ND	ND

Notes:

µg/L micrograms per Liter
 ND Not Detected
 TPH Total Petroleum Hydrocarbons
 VOC Volatile Organic Compound

TABLE 3
VOC AND TPH COMPOUNDS IN SOIL
FROM MONITORING WELLS AND SOIL BORINGS, 1999
744 EAST 12TH STREET

Analyte	Location and Depth				
	MW-1 12.5-13 ft bgs	MW-2 10.5-11 ft bgs	MW-3 10.5-11 ft bgs	SB-1 10.5-11 ft bgs	SB-2 9.5-10 ft bgs
VOC ($\mu\text{g}/\text{Kg}$)					
Benzene	ND	ND	ND	ND	ND
Ethylbenzene	ND	ND	ND	ND	ND
Toluene	ND	ND	ND	ND	ND
m,p-Xylenes	ND	ND	ND	ND	ND
o-Xylene	ND	ND	ND	ND	ND
MTBE	ND	ND	950	ND	32
TPH (mg/Kg)					
Gasoline	ND	ND	ND	ND	ND

Notes:

bgs below ground surface
ft feet
 $\mu\text{g}/\text{Kg}$ micrograms per Kilogram
mg/Kg milligrams per Kilogram
ND Not Detected
TPH Total Petroleum Hydrocarbons
VOC Volatile Organic Compound

APPENDIX A
MONITORING WELL COMPLETION RECORD

MONITORING WELL COMPLETION RECORD

DRILLING INFORMATION

DRILLING BEGAN:
 DATE 6-2-99 TIME 1100
 WELL INSTALLATION BEGAN:
 DATE 6-2-99 TIME 1230
 WELL COMPLETION FINISHED:
 DATE 6-2-99 TIME 1800
 DRILLING CO. FAST-TEK
 DRILLER Tom FORTNER
 LICENSE 589008
 DRILL RIG CME-25
 DRILLING METHOD:
 HOLLOW STEM AUGER
 AIR ROTARY

 DIAMETER OF AUGERS:
 ID 8/4" OD 3 3/4"

BENTONITE SEAL

AMOUNT CALCULATED 2.6 gal
 AMOUNT USED 3 gal
 PELLETS, SIZE _____
 CHIPS, SIZE 3/8"

 PRODUCT HOLE PLUG
 MFG. BY DARIOD INC.
 METHOD INSTALLED:
 POURED TREMIE
 AMOUNT OF WATER USED 2 gal

FILTER PACK

AMOUNT CALCULATED 31 gal
 AMOUNT USED 30 gal
 SAND, SIZE # 2/12
 FORMATION COLLAPSE:
 FROM _____ TO _____
 PRODUCT MONTEREY KILN DRIED SAND
 MFG. BY RMC LONESTAR
 METHOD INSTALLED:
 POURED TREMIE

SURVEY INFORMATION

TOC ELEVATION 18.17
 GROUND ELEVATION _____
 NORTHING CORD. _____
 EASTING CORD. _____
 DATE SURVEYED 7-12-99
 SURVEY CO. TTBNI

SURFACE COMPLETION

FLUSH MOUNT
 ABOVE GROUND W/BUMPER POST
 CONCRETE ASPHALT

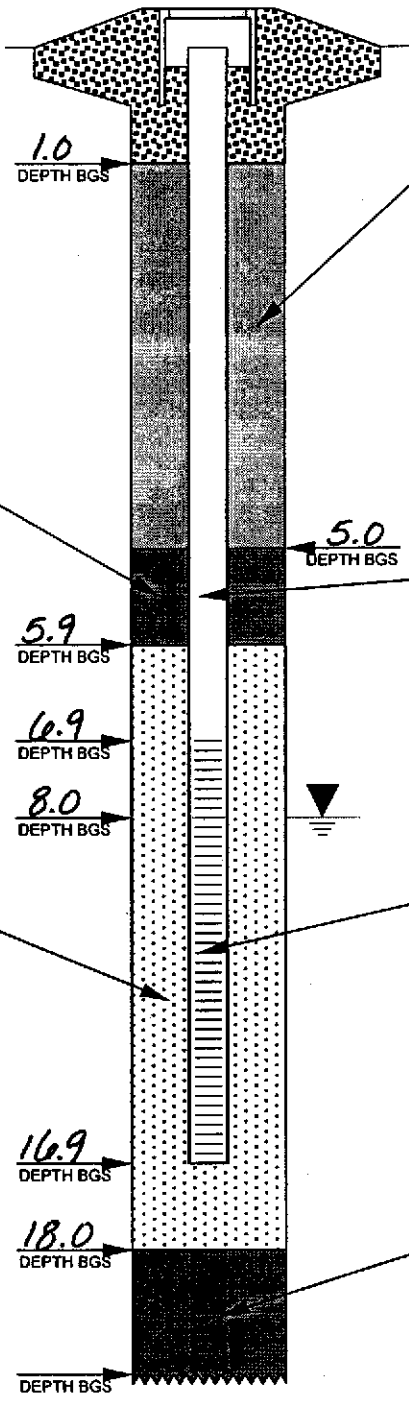

CENTRALIZERS

DEPTHS _____
 NO CENTRALIZERS USED

MONITORING WELL

MONITORING WELL NO. MW1
 PROJECT SILVEIRA - OAKLAND
 SITE 3-744 EAST 12th ST.
 BOREHOLE NO. _____
 WELL PERMIT NO. X9900416
 TOC TO BOTTOM OF WELL 16.9

ANNULAR SEAL

AMOUNT CALCULATED 10 gal
 AMOUNT USED 10 gal
 GROUT FORMULA
 PORTLAND CEMENT 63%
 BENTONITE 7%
 WATER 30%
 PREPARED MIX
 PRODUCT _____
 MFG. BY _____
 METHOD INSTALLED:
 POURED TREMIE

CASING

SCHEDULE 40 PVC

 PRODUCT _____
 MFG. BY TEMCO INC.
 CASING DIAMETER:
 ID 2.0 OD 2.4"
 LENGTH OF CASING 7'

WELL SCREEN

SCHEDULE 40 PVC

 PRODUCT _____
 MFG. BY TEMCO INC.
 CASING DIAMETER:
 ID 2.0 OD 2.4"
 SLOT SIZE .010 INCH
 LENGTH OF SCREEN 10'

BOREHOLE BACKFILL

AMOUNT CALCULATED _____
 AMOUNT USED _____
 BENTONITE CHIPS, SIZE _____
 BENTONITE PELLETS, SIZE _____
 SLURRY _____
 FORMATION COLLAPSE _____
 PRODUCT _____
 MFG. BY _____
 METHOD INSTALLED:
 POURED TREMIE

MONITORING WELL COMPLETION RECORD

DRILLING INFORMATION

DRILLING BEGAN:
 DATE 10-2-99 TIME 0800
 WELL INSTALLATION BEGAN:
 DATE 10-2-99 TIME 0930
 WELL COMPLETION FINISHED:
 DATE 10-2-99 TIME 1800
 DRILLING CO. FAST-TEK
 DRILLER TOM FORTNER
 LICENSE 589008
 DRILL RIG CME-25
 DRILLING METHOD:
 HOLLOW STEM AUGER
 AIR ROTARY

 DIAMETER OF AUGERS:
 ID 8 1/4" OD 3 3/4"

BENTONITE SEAL

AMOUNT CALCULATED 2.7 gal
 AMOUNT USED 2.7 gal
 PELLETS, SIZE _____
 CHIPS, SIZE 3/8"

 PRODUCT HOLE PUG-WYOMING
 MFG. BY BARIOT INC.
 METHOD INSTALLED:
 POURED TREMIE
 AMOUNT OF WATER USED 1.5 gal

FILTER PACK

AMOUNT CALCULATED 30 gal
 AMOUNT USED 30 gal
 SAND, SIZE # 20/12
 FORMATION COLLAPSE:
 FROM _____ TO _____
 PRODUCT MONTEREY KUN DRIED SAND
 MFG. BY RMC LOWESTAR
 METHOD INSTALLED:
 POURED TREMIE

SURVEY INFORMATION

TOC ELEVATION 16.71
 GROUND ELEVATION _____
 NORTHING CORD. _____
 EASTING CORD. _____
 DATE SURVEYED T&E
 SURVEY CO. 7-12-99

SURFACE COMPLETION

FLUSH MOUNT
 ABOVE GROUND W/BUMPER POST
 CONCRETE ASPHALT

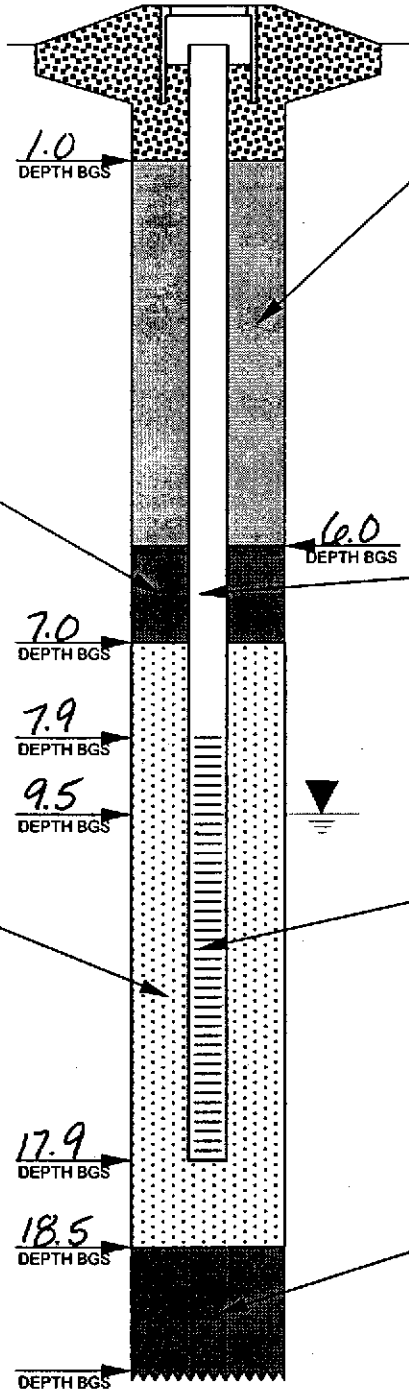

CENTRALIZERS

DEPTHS _____
 NO CENTRALIZERS USED

MONITORING WELL

MONITORING WELL NO. MW 2
 PROJECT SILVEIRA-OAKLAND
 SITE 3-744 EAST 121ST
 BOREHOLE NO. _____
 WELL PERMIT NO. X9900416
 TOC TO BOTTOM OF WELL 17.9'

ANNULAR SEAL

AMOUNT CALCULATED 13 gal
 AMOUNT USED 12 gal
 GROUT FORMULA
 PORTLAND CEMENT 63%
 BENTONITE 7%
 WATER 30%
 PREPARED MIX
 PRODUCT _____
 MFG. BY _____
 METHOD INSTALLED:
 POURED TREMIE

CASING

SCHEDULE 40 PVC

 PRODUCT _____
 MFG. BY Temco Inc.
 CASING DIAMETER:
 ID 2.0 OD 2.4
 LENGTH OF CASING 9.0'

WELL SCREEN

SCHEDULE 40 PVC

 PRODUCT _____
 MFG. BY Temco Inc.
 CASING DIAMETER:
 ID 2.0 OD 2.4
 SLOT SIZE .010"
 LENGTH OF SCREEN 10'

BOREHOLE BACKFILL

AMOUNT CALCULATED _____
 AMOUNT USED _____
 BENTONITE CHIPS, SIZE _____
 BENTONITE PELLETS, SIZE _____
 SLURRY _____
 FORMATION COLLAPSE _____
 PRODUCT _____
 MFG. BY _____
 METHOD INSTALLED:
 POURED TREMIE

MONITORING WELL COMPLETION RECORD

DRILLING INFORMATION

DRILLING BEGAN:
 DATE 6-2-99 TIME 1400
 WELL INSTALLATION BEGAN:
 DATE 6-2-99 TIME 1530
 WELL COMPLETION FINISHED:
 DATE 6-2-99 TIME 1800
 DRILLING CO. FAST-TEK
 DRILLER Tom Forster
 LICENSE 589008
 DRILL RIG CMB-25
 DRILLING METHOD:
 HOLLOW STEM AUGER
 AIR ROTARY

 DIAMETER OF AUGERS:
 ID 8 1/4" OD 3 3/4"

BENTONITE SEAL

AMOUNT CALCULATED 2.7 gal
 AMOUNT USED 2.5 gal
 PELLETS, SIZE _____
 CHIPS, SIZE 3/8"

 PRODUCT Ho-Ping Wyoming
 MFG. BY Darios Inc.
 METHOD INSTALLED:
 POURED TREMIE
 AMOUNT OF WATER USED 1.5 gal

FILTER PACK

AMOUNT CALCULATED 30 gal
 AMOUNT USED 30 gal
 SAND, SIZE # 2/12
 FORMATION COLLAPSE:
 FROM _____ TO _____
 PRODUCT Monterey King Debris Sand
 MFG. BY RMC LOWESTAR
 METHOD INSTALLED:
 POURED TREMIE

SURVEY INFORMATION

TOC ELEVATION 16.35
 GROUND ELEVATION _____
 NORTHING CORD. _____
 EASTING CORD. _____
 DATE SURVEYED 7-12-99
 SURVEY CO. TEEMI

SURFACE COMPLETION

FLUSH MOUNT
 ABOVE GROUND W/BUMPER POST
 CONCRETE ASPHALT

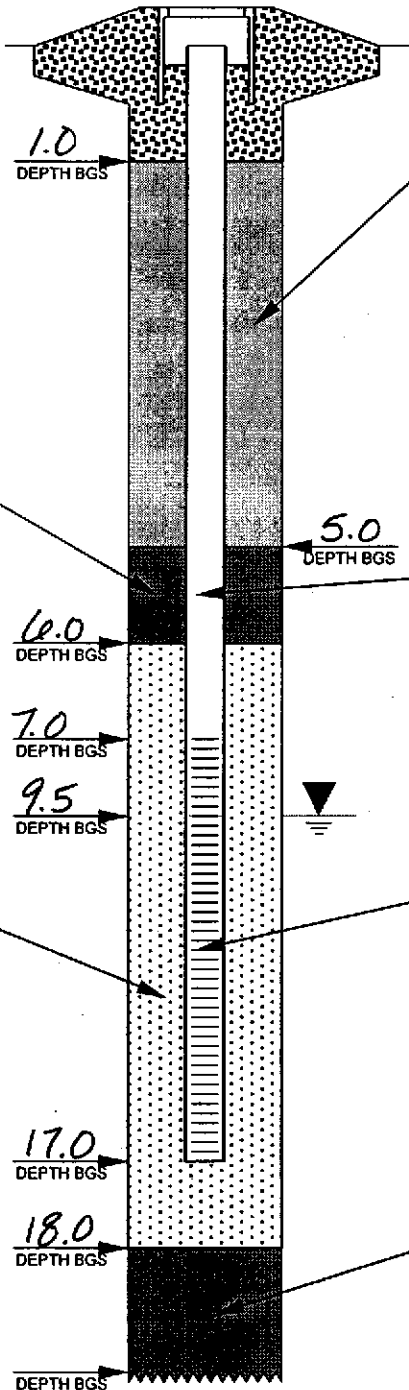

CENTRALIZERS

DEPTHS _____
 NO CENTRALIZERS USED

MONITORING WELL

MONITORING WELL NO. MW 3
 PROJECT SILVEIRA-DAKLAND
 SITE 3, 744 EAST 12TH ST
 BOREHOLE NO. _____
 WELL PERMIT NO. X9900416
 TOC TO BOTTOM OF WELL 18.0

ANNULAR SEAL

AMOUNT CALCULATED 10 gal
 AMOUNT USED 10 gal
 GROUT FORMULA
 PORTLAND CEMENT 63%
 BENTONITE 7%
 WATER 30%
 PREPARED MIX
 PRODUCT _____
 MFG. BY _____
 METHOD INSTALLED:
 POURED TREMIE

CASING

SCHEDULE 40 PVC

 PRODUCT _____
 MFG. BY Temco
 CASING DIAMETER:
 ID 2.0 OD 2.4
 LENGTH OF CASING 7'

WELL SCREEN

SCHEDULE 40 PVC

 PRODUCT Temco Inc.
 MFG. BY _____
 CASING DIAMETER:
 ID 2.0 OD 2.4
 SLOT SIZE .010 in
 LENGTH OF SCREEN 10 ft

BOREHOLE BACKFILL

AMOUNT CALCULATED _____
 AMOUNT USED _____
 BENTONITE CHIPS, SIZE _____
 BENTONITE PELLETS, SIZE _____
 SLURRY _____
 FORMATION COLLAPSE _____
 PRODUCT _____
 MFG. BY _____
 METHOD INSTALLED:
 POURED TREMIE

Tetra Tech EM Inc.

135 MAIN STREET, SUITE 1800
 SAN FRANCISCO, CA 94105
 415-543-4880

BORING ID: MW-1
 SITE: 744 E 12th ST.

PROJECT:
 SILVEIRA - OAKLAND

PROJECT NO.: P1106

DATE: 6-2-99

LOGGED BY: Roy GLENN

SAMPLE ID	SAMPLE TIME	SAMPLE DEPTH	PID READING	DRIVE INTERVAL INCHES RECOVERED INCHES DRIVEN	DEPTH (ft bgs)	MW SCREENED INT.	USCS SOIL TYPE
					1	CL	CONCRETE 6"
				42/40	2	CL	CLAY, LIGHT BROWNISH GRAY (2.5 y 6/2), LOW PLASTICITY, DAMP, STIFF.
				48/40	3	CL	
				48/40	4	CL	CLAY, LIGHT BROWNISH GRAY (2.5 y 6/2) w/ MOTTLED BLACK & REDDISH IRON STAINING 10%, LOW PLASTICITY, DAMP, STIFF
				48/40	5	CL	
				48/40	6	CL	w/ 5% FINE GRAVEL 4-8mm
				48/40	7	CL	
				48/40	8	CL	w/ 10% WHITE BROWN SHELLS 2-8mm
				48/40	9	CL	w/ 25% WHITE BROWN SHELLS 2-10mm
				48/40	10	CL	No SHELLS PRESENT AT 9.5' bgs.
				42/40	11	CL	SANDY-CLAY, LIGHT YELLOWISH BROWN (10 YR 6/4), LOW PLASTICITY, MOIST, MEDIUM STIFF, w/ 15% FINE GRAVEL.
JW3-2	1200			33/30	12	CL	w/ 40% FINE GRAVEL 4-6mm
				33/30	13	CL	GRAVELY-SAND, BROWN (10 YR 5/3), COARSE, SUB-ANGULAR, WELL GRADED SAND, WET, LOOSE, w/ 15% GRAVEL-FINE 2-8mm
				32/30	14	SW	
				32/30	15	SW	
				32/30	16	SW	
				32/30	17	SW	SATURATED
				32/30	18	SW	
				32/30	19	SW	
				32/30	20	SW	

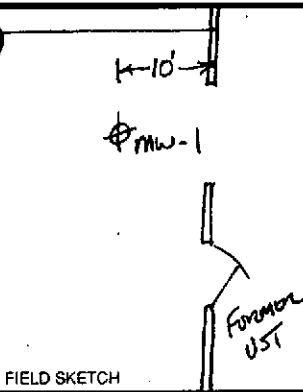

CONCRETE 6"

CLAY, LIGHT BROWNISH GRAY (2.5 y 6/2), LOW PLASTICITY, DAMP, STIFF.

CLAY, LIGHT BROWNISH GRAY (2.5 y 6/2) w/ MOTTLED BLACK & REDDISH IRON STAINING 10%, LOW PLASTICITY, DAMP, STIFF

w/ 5% FINE GRAVEL 4-8mm

w/ 10% WHITE BROWN SHELLS 2-8mm

w/ 25% WHITE BROWN SHELLS 2-10mm

No SHELLS PRESENT AT 9.5' bgs.

SANDY-CLAY, LIGHT YELLOWISH BROWN (10 YR 6/4), LOW PLASTICITY, MOIST, MEDIUM STIFF, w/ 15% FINE GRAVEL.

w/ 40% FINE GRAVEL 4-6mm

GRAVELY-SAND, BROWN (10 YR 5/3), COARSE, SUB-ANGULAR, WELL GRADED SAND, WET, LOOSE, w/ 15% GRAVEL-FINE 2-8mm

SATURATED

TD = 18.0 ft bgs.

Tetra Tech EM Inc.

135 MAIN STREET, SUITE 1800
 SAN FRANCISCO, CA 94105
 415-543-4880

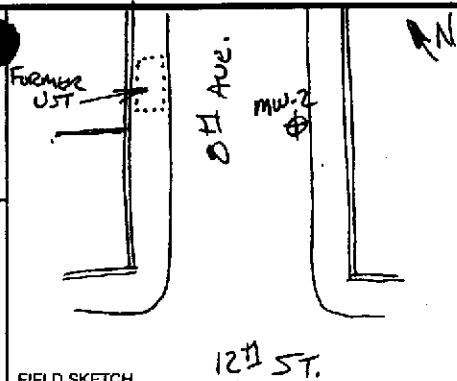

BIG ID: MW-2
 SITE: 744 E 12th ST.
 PROJECT: SILVEIRA - OAKLAND
 PROJECT NO.: P1106
 DATE: 6-2-99
 LOGGED BY: Roy Glenn

SAMPLE ID	SAMPLE TIME	SAMPLE DEPTH	PID READING	DRIVE INTERVAL INCHES RECOVERED INCHES DRIVEN	DEPTH (ft Dgs)	MW SCREEN	USCS SOIL TYPE
				44/48	1		
					2		
					3		
					4		
					5		
				40/48	6		
					7		
					8		
					9		
				32/36	10		
JW3-φ1	1030				11		
					12		
				36/36	13		
					14		
					15		
					16		
				43/48	17		
					18		
					19		
					20		

FIELD SKETCH

ASPHALT 2 1/2"

CLAY, GREENISH-GRAY (5G4 6/1), LOW PLASTICITY, DAMP, STIFF, w/5% VERY COARSE SAND.

CL

LIGHT BROWNISH GRAY (2.5 Y 6/2)

w/5% BLACK STAINING - OXIDE

CLAY, MOTTLED LIGHT BROWN (7.5 YR 6/3) w/BLACK & REDDISH IRON OXIDE STAINING-3φ%, LOW PLASTICITY, MOIST, MEDIUM STIFF.

SANDY-CLAY, LIGHT YELLOWISH BROWN (10 YR 6/4), LOW PLASTICITY, WET, SOFT.

SM

SILTY-SAND, BROWN (10 YR 5/3), MEDIUM SAND, WELL BOUNDED, WELL GRADED, SATURATED, LOOSE

GM

SILTY-GRAVEL, BROWN (10 YR 5/3), FINE, SUB BOUNDED, POORLY GRADED GRAVEL, SATURATED, LOOSE, w/10% COARSE SAND.

TD = 18 ft Dgs.

Tetra Tech EM Inc.

135 MAIN STREET, SUITE 1800
 SAN FRANCISCO, CA 94105
 415-543-4880

MW-1
 Ⓢ

Ⓢ Ave.

Boring ID: MW-3

SITE: 744 EAST 12th STREET

PROJECT:
 SILVEIRA - OAKLAND

PROJECT NO.: P1106

DATE: 6-2-99

LOGGED BY: Roy Glenn

SAMPLE ID	SAMPLE TIME	SAMPLE DEPTH	PID READING	DRIVE INTERVAL INCHES RECOVERED INCHES DRIVEN	DEPTH (ft bgs)	MW Screen	USCS SOIL TYPE
-----------	-------------	--------------	-------------	---	----------------	-----------	----------------

FIELD SKETCH

1						ML	CONCRETE 4 1/2" SILT, DARK BROWN (10YR 3/3), DAMP, SOFT
2				42/42		CL	CLAY, LIGHT BROWNISH GRAY (2.5Y 6/2), LOW PLASTICITY, DAMP, STIFF, w/ BLACK & IRON OXIDE STAINING 5%
3							
4							
5							
6				48/48			w/ 5% FINE GRAVEL 4-6 mm
7							
8							
9						CL	GRAVELLY-CLAY, STAINED GRAYISH-GREEN (5G4 6/1), LOW PLASTICITY, DAMP, MEDIUM STIFF, w/ 35% FINE TO COARSE GRAVEL (0mm - 25mm, HYDROCARBON ODOR PRESENT.
10				42/48			
11	JW3-φ3	1330					MOIST
12							SILTY-SAND, BROWN (10YR 5/3), MEDIUM SAND, SUB-ROUNDED, WELL GRADED, SATURATED, LOOSE
13				30/30			
14						SM	w/ 10% COARSE SAND & VERY FINE GRAVEL
15							
16				29/30			
17							
18							TD = 18 ft bgs.
19							
20							

Tetra Tech EM Inc.

135 MAIN STREET, SUITE 1800
 SAN FRANCISCO, CA 94105
 415-543-4880

MW-1

Boring ID: SB-1

SITE: 744 EAST 12TH ST.

PROJECT:

SILVEIRA - OAKLAND

PROJECT NO.: P1106

DATE: 6-2-99

LOGGED BY: Roy Glenn

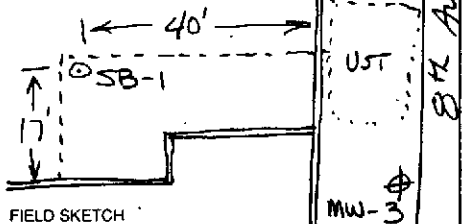

SAMPLE ID	SAMPLE TIME	SAMPLE DEPTH	PID READING	DRIVE INTERVAL INCHES RECOVERED	INCHES DRIVEN	DEPTH (ft bgs)	USCS SOIL TYPE
						1	CONCRETE 6"
					42/42	2	CL
						3	
						4	
					47/48	5	
						6	CL
						7	
						8	
					46/48	9	CL
						10	
JW3-4	1450					11	
						12	
					28/30	13	SW
						14	
						15	
					33/30	16	SW
						17	
						18	
						19	
						20	

FIELD SKETCH

CONCRETE 6"

CLAY, LIGHT BROWNISH GRAY (2.5 y_{6/2}), LOW PLASTICITY, DAMP, STIFF.

CLAY, MOTTLED LIGHT BROWNISH GRAY (2.5 y_{6/2}) w/ BLACK & REDDISH IRON OXIDE STAINING 1.5%, LOW PLASTICITY, DAMP, STIFF, w/ 10% FINE GRAVEL.

w/ 5% WHITE BROWN SHELLS 2-8 mm

SANDY-CLAY, LIGHT YELLOWISH BROWN (10 y_{4R/4}), LOW PLASTICITY, MOIST, MEDIUM STIFF, w/ 5% FINE GRAVEL.

WET

w/ 30% FINE GRAVEL 4-8 mm

GRAVELLY-SAND, BROWN (10 y_{4R/5/3}), COARSE, SUB-ANGULAR, WELL GRADED SAND, WET, LOOSE, w/ 20% FINE GRAVEL.

SATURATED
 TD = 18 ft bgs.

Tetra Tech EM Inc.

135 MAIN STREET, SUITE 1800
 SAN FRANCISCO, CA 94105
 415-543-4880

Boring ID: SB-2
 SITE: 744 EAST 12th ST.
 PROJECT:
 SILVEIRA - OAKLAND
 PROJECT NO.: P1106
 DATE: 6-2-99
 LOGGED BY: Roy Glenn

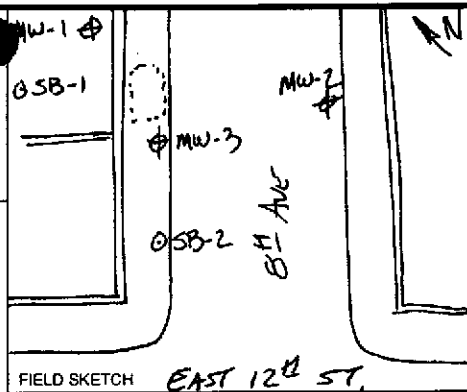

SAMPLE ID	SAMPLE TIME	SAMPLE DEPTH	PID READING	DRIVE INTERVAL INCHES RECOVERED INCHES DRIVEN	DEPTH (ft bgs)	USCS SOIL TYPE
				44/45	1	CL
					2	
					3	
				47/40	4	CL
					5	
					6	
					7	
					8	
					9	
JW3-06	1545			40/40	10	CL
					11	
					12	
				31/30	13	CL
					14	
					15	
					16	SM
				28/30	17	
					18	
					19	
					20	

FIELD SKETCH EAST 12th ST.

CONCRETE 3"
 CLAY, LIGHT BROWNISH GRAY (2.54^g/_g), LOW PLASTICITY,
 DAMP, STIFF.

w/BLACK & REDDISH IRON OXIDE STAINING 10%

CLAY, STAINED GREENISH-GREEN (5.94^g/_g), LOW PLASTICITY,
 DAMP, MEDIUM STIFF w/15% FINE GRAVEL 5-8mm,
 HYDROCARBON ODOR PRESENT.

SANDY-CLAY, LIGHT YELLOWISH BROWN (10.42^g/_g),
 LOW PLASTICITY, MOIST, MEDIUM STIFF.

MOIST

WET

GRAVELLY-CLAY, BROWN (10.42^g/_g), LOW PLASTICITY, DAMP,
 STIFF, w/20% FINE GRAVEL.

SILTY-SAND, BROWN (10.42^g/_g), MEDIUM SAND,
 SUB-ROUNDED, WELL GRADED SAND, SATURATED, LOOSE

TD = 18 ft logs.

The copy of the COCs delivered to the analytical laboratory does not include information about which location specific samples were collected from, nor is information provided on the laboratory copy of the COC about whether or not the sample is a quality control sample. Thus, the copy of the COCs which includes this information has also been included in this appendix.

Chain of Custody Record

135 Main St, Suite 1800
San Francisco, CA 94105
415-543-4880
Fax 415-543-5480

PO#	Lab:	Preservative Added													
		HCL	HCL	HCL											
Project name:	TIEMI technical contact:	No./Container Types					Analysis Required								
Project number:	TIEMI project manager:	40 ml VOA	1 Liter Amber	1 Liter Poly	Brass Tube	Glass Jar	ACETATE	CLP VOA	CLP SYOA	CLP Pest/PCBs	CLP Metals	TPH Purgeables	TPH Extractables	BTEX	MTBE
Field samplers:	Field samplers' signatures:														
Sample ID	Sample Description/Notes	Date	Time	Matrix											
JW3-01	MW2 10.5-11.0 ft	6-2-99	1030	SOIL								X	X	X	X
JW3-02	MW1 12.5-13.4 ft		1200	SOIL								X	X	X	X
JW3-03	MW3 10.5-11.0 ft		1330	SOIL								X	X	X	X
JW3-04	SB1 10.5-11.0 ft		1450	SOIL								X	X	X	X
JW3-05	SB1 GRAB GROUNDWATER		1505	WATER	4							X	X	X	X
JW3-06	SB2 9.5-10.0 ft		1545	SOIL								X	X	X	X
JW3-07	SB2 GRAB GW		1600	WATER	4							X	X	X	X
JW3-08	TRIP BANK		1705	WATER	1							X	X	X	X

Relinquished by:	Name (print)	Company Name	Date	Time
<i>Roy D. Glenn</i>	Roy D. Glenn	TETRA TECH EM, Inc.	6-3-99	
<i>Tracy Behr</i>	Tracy Behr	CAT	6-3-99	2:20
Relinquished by:				
Received by:				
Relinquished by:				
Received by:				
Relinquished by:				
Received by:				

Turnaround time/remarks:

Chain of Custody Record

135 Main St, Suite 1800
San Francisco, CA 94105
415-543-5880
Fax 415-543-5480

		POF	Lab:			No./Container Types					Preservative Added					Analysis Required																		
			C&T			40 ml VOA	1 Liter Amber	1 Liter Poly	Brass Tube	Glass Jar																								
Project name:		TIEMI technical contact:			Field samplers:																													
JW SILVEIRA USE OAKLAND		JACKIE LUTA			ROY GLENN																													
Project number:		TIEMI project manager:			Field samplers' signatures:																													
P106.05		HAR DAWSON			[Signatures]																													
Sample ID	Sample Description/Notes	Date	Time	Matrix								CLP VOA	CLP SVOA	CLP Pest/PCBs	CLP Metals	TPH Purgeables	TPH Extractables	MTBE	BTEX															
JW3-09	MW2 GW	6-7-99	1003	WATER	3											X	X	X																
JW3-10	MW1 GW	↓	1243	"	3											X	X	X																
JW3-11	MW3 GW	↓	1305	"	3											X	X	X																
XXXXXXXXXX		XXXXXXXXXX		XXXXXXXXXX																														

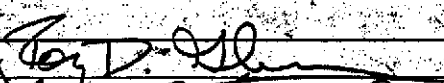
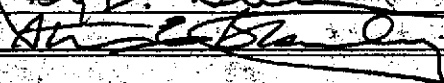
Relinquished by:	Name (print)	Company Name	Date	Time
	Roy Glenn	TT EM I	6-8	1600
	Steven Stanley	Curtis & Tompkins	6-8	1600
Relinquished by:				
Received by:				
Relinquished by:				
Received by:				
Relinquished by:				
Received by:				

Turnaround time/remarks:

Handwritten notes: 6/7/99, 1003, 1243, 1305



Curtis & Tompkins, Ltd., Analytical Laboratories, Since 1878

2323 Fifth Street, Berkeley, CA 94710, Phone (510) 486-0900, Fax (510) 486-0532

RECEIVED

Laboratory Number 139755

JUN 28 1999

TETRA TECH EM INC.

Tetra Tech EMI
135 Main Street
Suite 1800
San Francisco, CA 94105

Project#: P1106.05
Location: JW Silveria UST, Oak.

Sample ID	Lab ID
JW3-01	139755-001
JW3-02	139755-002
JW3-03	139755-003
JW3-04	139755-004
JW3-05	139755-005
JW3-06	139755-006
JW3-07	139755-007
JW3-08	139755-008

I certify that this data package has been reviewed for technical correctness and completeness. Please see attached narrative for a discussion of any analytical problems related to this sample set. Release of this data has been authorized by the Laboratory Manager or the Manager's designee, as verified by the following signatures.

The case narrative is an integral and inseparable part of this report.

Signature: 
Title: Operations Manager

Date: 6-21-99

Signature: 
Title: Project Manager

Date: 6/21/99



Laboratory Number: 139755
Client: Tetra Tech EMI
Location: JW Silveria USI, Oakland
Project#: P1106.05

Receipt Date: 06/03/99

CASE NARRATIVE

This hardcopy data package contains sample and QC results for five soil samples and three water samples that were received on June 3, 1999. Soil results were reported on a dry-weight basis.

TPH Purgeables/BTXE: No analytical problems were encountered.



Tetra Tech EM Inc.
San Francisco Office

1210

13975

Chain of Custody Record

Page 1 of 1

135 Main St. Suite 1800
San Francisco, CA 94105
415-543-4880
Fax 415-543-5480

Project name:	PO#	Lab:	Preservative Added															
			Analysis Required															
Project number:	TREMI technical contact:	Field samplers:	No./Container Types															
Sample ID	Sample Description/Notes	Date	Time	Matrix	40 ml VOA	1 Liter Amber	1 Liter Poly	Brass Tube	Glass Jar	ACETATE	CLP VOA	CLP SVOA	CLP Pest/PCBs	CLP Metals	TPH Purgeables	TPH Extractables	BTEX	MTBE
JW3-01	1	6-2-99	1030	SOIL											X	X	X	X
JW3-02	2		1200	SOIL											X	X	X	X
JW3-03	3		1330	SOIL											X	X	X	X
JW3-04	4		1450	SOIL											X	X	X	X
JW3-05	5		1505	WATER	4										X	X	X	X
JW3-06	6		1545	SOIL											X	X	X	X
JW3-07	7		1600	WATER	4										X	X	X	X
JW3-08	8		1705	WATER	1										X	X	X	X

Relinquished by:	Name (print)	Company Name	Date	Time
<i>Roy D. Glenn</i>	Roy D. Glenn	TETRA TECH EM, Inc.	6-3-99	
<i>Tracy B...</i>	Tracy B...	C&T	6-3-99	2:20
Relinquished by:				
Received by:				
Relinquished by:				
Received by:				
Relinquished by:				
Received by:				

Turnaround time/remarks:

3

JW S. IV 4.2 485 015



Curtis & Tompkins, Ltd.

COOLER RECEIPT CHECKLIST

Login#: 139755 Date Received: 6/3 Number of Coolers: 1
 Client: TTEME Project: P1106105

A. Preliminary Examination Phase

Date Opened: 6/3 By (print): D. Williams (sign) [Signature]

1. Did cooler come with a shipping slip (airbill, etc.)?..... YES NO
- If YES, enter carrier name and airbill number: _____
2. Were custody seals on outside of cooler?..... YES NO
- How many and where? _____ Seal date: _____ Seal name: _____
3. Were custody seals unbroken and intact at the date and time of arrival?..... YES NO
4. Were custody papers dry and intact when received?..... YES NO
5. Were custody papers filled out properly (ink, signed, etc.)?..... YES NO
6. Did you sign the custody papers in the appropriate place?..... YES NO
7. Was project identifiable from custody papers?..... YES NO
- If YES, enter project name at the top of this form. _____
8. If required, was sufficient ice used?..... YES NO
- Type of ice: Blue/white Temperature: 4°C

B. Login Phase

Date Logged In: 6/3 By (print): [Signature] (sign) [Signature]

1. Describe type of packing in cooler: _____
2. Did all bottles arrive unbroken?..... YES NO
3. Were labels in good condition and complete (ID, date, time, signature, etc.)?..... YES NO
4. Did bottle labels agree with custody papers?..... YES NO
5. Were appropriate containers used for the tests indicated?..... YES NO
6. Were correct preservatives added to samples?..... YES NO
7. Was sufficient amount of sample sent for tests indicated?..... YES NO
8. Were bubbles absent in VOA samples? If NO, list sample Ids below..... YES NO
9. Was the client contacted concerning this sample delivery?..... YES NO
- If YES, give details below. _____
- Who was called? _____ By whom? _____ Date: _____

Additional Comments:

Percent Moisture Summary Report

Date: 11-JUN-99
 Batch: 48586
 Analyst: MR

Sample	Method	Date	Tare(g)	Wet(g)	Dry(g)	Percent Solids	Percent Moisture
139707-001	CLP SOW 390	11-JUN-99	15.2086	22.613	21.2519	82	18
139755-001	CLP SOW 390	11-JUN-99	15.1006	22.1986	20.8668	81	19
139755-002	CLP SOW 390	11-JUN-99	15.9738	22.6529	21.7696	87	13
139755-003	CLP SOW 390	11-JUN-99	15.8485	22.223	21.2678	85	15
139755-004	CLP SOW 390	11-JUN-99	15.7932	23.4552	21.9956	81	19
139755-006	CLP SOW 390	11-JUN-99	15.3093	22.4025	21.3129	85	15
139767-002	CLP SOW 390	11-JUN-99	15.4967	22.9024	22.5271	95	5
139767-003	CLP SOW 390	11-JUN-99	15.2178	22.4455	21.8175	91	9
139767-004	CLP SOW 390	11-JUN-99	15.3789	22.26	21.9676	96	4
139767-005	CLP SOW 390	11-JUN-99	15.4881	23.4615	23.1166	96	4
139767-006	CLP SOW 390	11-JUN-99	14.6335	23.0883	22.6368	95	5
139767-007	CLP SOW 390	11-JUN-99	15.0383	23.8915	23.5369	96	4
139767-008	CLP SOW 390	11-JUN-99	15.9407	23.7889	23.4341	95	5
139767-009	CLP SOW 390	11-JUN-99	15.6188	23.1136	22.7085	95	5
139767-010	CLP SOW 390	11-JUN-99	15.4913	23.5108	23.058	94	6
139767-011	CLP SOW 390	11-JUN-99	15.6317	22.8891	22.4816	94	6
139767-012	CLP SOW 390	11-JUN-99	14.9898	23.7064	23.3221	96	4
139767-014	CLP SOW 390	11-JUN-99	15.2987	22.7277	22.2814	94	6
139767-015	CLP SOW 390	11-JUN-99	15.9725	23.8646	23.5281	96	4
139767-016	CLP SOW 390	11-JUN-99	14.996	22.7799	22.4097	95	5
QC99685	CLP SOW 390	11-JUN-99	14.9885	22.8706	21.6653	85	15
of 139755-006					RPD:	0.1%	0.5%



TVH-Total Volatile Hydrocarbons

Client: Tetra Tech EMI
Project#: P1106.05
Location: JW Silveria UST, Oak.

Analysis Method: EPA 8015M
Prep Method: EPA 5030

Sample #	Client ID	Batch #	Sampled	Extracted	Analyzed	Moisture
139755-001	JW3-01 MW2 10.5-11	48621	06/02/99	06/13/99	06/13/99	19%
139755-002	JW3-02 MW1 12.5-13	48621	06/02/99	06/13/99	06/13/99	13%
139755-003	JW3-03 MW3 10.5-11	48608	06/02/99	06/12/99	06/12/99	15%
139755-004	JW3-04 SD1-10.5-11	48621	06/02/99	06/13/99	06/13/99	19%

Matrix: Soil

Analyte	Units	139755-001	139755-002	139755-003	139755-004
Diln Fac:		1	1	1	1
Gasoline C7-C12	mg/Kg	<1.2	<1.1	<1.2	<1.2
Surrogate					
Trifluorotoluene	%REC	93	94	96	95
Bromofluorobenzene	%REC	88	92	93	91



BTXE

Client: Tetra Tech EMI	Analysis Method: EPA 8021B
Project#: P1106.05	Prep Method: EPA 5030
Location: JW Silveria UST, Oak.	

Sample #	Client ID	Batch #	Sampled	Extracted	Analyzed	Moisture.
139755-001	JW3-01	48621	06/02/99	06/13/99	06/13/99	19%
139755-002	JW3-02	48621	06/02/99	06/13/99	06/13/99	13%
139755-003	JW3-03 <i>W3 10.5-11</i>	48621	06/02/99	06/13/99	06/13/99	15%
139755-004	JW3-04	48621	06/02/99	06/13/99	06/13/99	19%

Matrix: Soil

Analyte	Units	139755-001	139755-002	139755-003	139755-004
Diln Fac:		1	1	2	1
MTBE	ug/Kg	<25	<23	950	<25
Benzene	ug/Kg	<6.2	<5.7	<12	<6.2
Toluene	ug/Kg	<6.2	<5.7	<12	<6.2
Ethylbenzene	ug/Kg	<6.2	<5.7	<12	<6.2
m,p-Xylenes	ug/Kg	<6.2	<5.7	<12	<6.2
o-Xylene	ug/Kg	<6.2	<5.7	<12	<6.2
Surrogate					
Trifluorotoluene	%REC	103	106	102	101
Bromofluorobenzene	%REC	98	101	100	98



TVH-Total Volatile Hydrocarbons

Client: Tetra Tech EMI
Project#: P1106.05
Location: JW Silveria UST, Oak.

Analysis Method: EPA 8015M
Prep Method: EPA 5030

Sample #	Client ID	Batch #	Sampled	Extracted	Analyzed	Moisture
139755-006	JW3-06	48621	06/02/99	06/13/99	06/13/99	15%

Matrix: Soil

Analyte	Units	139755-006
Diln Fac:		1
Gasoline C7-C12	mg/Kg	<1.2
Surrogate		
Trifluorotoluene	%REC	98
Bromofluorobenzene	%REC	92



BTXE

Client: Tetra Tech EMI
Project#: P1106.05
Location: JW Silveria UST, Oak.

Analysis Method: EPA 8021B
Prep Method: EPA 5030

Sample #	Client ID	Batch #	Sampled	Extracted	Analyzed	Moisture
139755-006	JW3-06	SB2 9,5-10 48621	06/02/99	06/13/99	06/13/99	15%

Matrix: Soil

Analyte	Units	139755-006
Diln Fac:		1
MTBE	ug/Kg	32
Benzene	ug/Kg	<5.9
Toluene	ug/Kg	<5.9
Ethylbenzene	ug/Kg	<5.9
m,p-Xylenes	ug/Kg	<5.9
o-Xylene	ug/Kg	<5.9
Surrogate		
Trifluorotoluene	%REC	104
Bromofluorobenzene	%REC	101



Lab #: 139755

BATCH QC REPORT

TVH-Total Volatile Hydrocarbons

Client: Tetra Tech EMI	Analysis Method: EPA 8015M
Project#: P1106.05	Prep Method: EPA 5030
Location: JW Silveria UST, Oak.	

METHOD BLANK

Matrix: Soil	Prep Date: 06/11/99
Batch#: 48608	Analysis Date: 06/11/99
Units: mg/Kg	
Diln Fac: 1	

MB Lab ID: QC99776

Analyte	Result	
Gasoline C7-C12	<1.0	
Surrogate	%Rec	Recovery Limits
Trifluorotoluene	93	62-143
Bromofluorobenzene	87	59-150



Lab #: 139755

BATCH QC REPORT

TVH-Total Volatile Hydrocarbons

Client: Tetra Tech EMI
Project#: P1106.05
Location: JW Silveria UST, Oak.

Analysis Method: EPA 8015M
Prep Method: EPA 5030

METHOD BLANK

Matrix: Soil
Batch#: 48621
Units: mg/Kg
Diln Fac: 1

Prep Date: 06/13/99
Analysis Date: 06/13/99

MB Lab ID: QC99837

Analyte	Result	
Gasoline C7-C12	<1.0	
Surrogate	%Rec	Recovery Limits
Trifluorotoluene	93	62-143
Bromofluorobenzene	91	59-150



Lab #: 139755

BATCH QC REPORT

BTXE

Client: Tetra Tech EMI
Project#: P1106.05
Location: JW Silveria UST, Oak.

Analysis Method: EPA 8021B
Prep Method: EPA 5030

METHOD BLANK

Matrix: Soil
Batch#: 48621
Units: ug/Kg
Diln Fac: 1

Prep Date: 06/13/99
Analysis Date: 06/13/99

MB Lab ID: QC99837

Analyte	Result
MTBE	<20
Benzene	<5.0
Toluene	<5.0
Ethylbenzene	<5.0
m,p-Xylenes	<5.0
o-Xylene	<5.0

Surrogate	%Rec	Recovery Limits
Trifluorotoluene	104	59-134
Bromofluorobenzene	100	38-150

Lab #: 139755

BATCH QC REPORT



Curtis & Tompkins, Ltd.
Page 1 of 1

TVH-Total Volatile Hydrocarbons

Client: Tetra Tech EMI
Project#: P1106.05
Location: JW Silveria UST, Oak.

Analysis Method: EPA 8015M
Prep Method: EPA 5030

LABORATORY CONTROL SAMPLE

Matrix: Soil
Batch#: 48608
Units: mg/Kg
Diln Fac: 1

Prep Date: 06/11/99
Analysis Date: 06/11/99

LCS Lab ID: QC99777

Analyte	Result	Spike Added	%Rec #	Limits
Gasoline C7-C12	10.24	10	102	77-122
Surrogate	%Rec	Limits		
Trifluorotoluene	94	62-143		
Bromofluorobenzene	108	59-150		

Column to be used to flag recovery and RPD values with an asterisk

* Values outside of QC limits

Spike Recovery: 0 out of 1 outside limits



Lab #: 139755

BATCH QC REPORT

BTXE

Client: Tetra Tech EMI
Project#: P1106.05
Location: JW Silveria UST, Oak.

Analysis Method: EPA 8021B
Prep Method: EPA 5030

LABORATORY CONTROL SAMPLE

Matrix: Soil
Batch#: 48621
Units: ug/Kg
Diln Fac: 1

Prep Date: 06/13/99
Analysis Date: 06/13/99

LCS Lab ID: QC99838

Analyte	Result	Spike Added	%Rec #	Limits
MTBE	79.18	100	79	59-135
Benzene	84.28	100	84	67-116
Toluene	88.45	100	88	77-122
Ethylbenzene	88.07	100	88	70-124
m,p-Xylenes	185.6	200	93	75-125
o-Xylene	90.56	100	91	75-126
Surrogate	%Rec	Limits		
Trifluorotoluene	103	59-134		
Bromofluorobenzene	100	38-150		

Column to be used to flag recovery and RPD values with an asterisk

* Values outside of QC limits

Spike Recovery: 0 out of 6 outside limits



Lab #: 139755

BATCH QC REPORT

TVH-Total Volatile Hydrocarbons	
Client: Tetra Tech EMI	Analysis Method: EPA 8015M
Project#: P1106.05	Prep Method: EPA 5030
Location: JW Silveria UST, Oak	
BLANK SPIKE/BLANK SPIKE DUPLICATE	
Matrix: Soil	Prep Date: 06/13/99
Batch#: 48621	Analysis Date: 06/13/99
Units: mg/Kg	
Diln Fac: 1	

BS Lab ID: QC99839

Analyte	Spike Added	BS	%Rec #	Limits
Gasoline C7-C12	10	9.26	93	77-122
Surrogate			%Rec	Limits
Trifluorotoluene			93	62-143
Bromofluorobenzene			105	59-150

BSD Lab ID: QC99840

Analyte	Spike Added	BSD	%Rec #	Limits	RPD #	Limit
Gasoline C7-C12	10	8.83	88	77-122	5	11
Surrogate			%Rec	Limits		
Trifluorotoluene			94	62-143		
Bromofluorobenzene			111	59-150		

Column to be used to flag recovery and RPD values with an asterisk
 * Values outside of QC limits
 RPD: 0 out of 1 outside limits
 Spike Recovery: 0 out of 2 outside limits



Lab #: 139755

BATCH QC REPORT

TVH-Total Volatile Hydrocarbons

Client: Tetra Tech EMI
Project#: P1106.05
Location: JW Silveria UST, Oak.

Analysis Method: EPA 8015M
Prep Method: EPA 5030

MATRIX SPIKE/MATRIX SPIKE DUPLICATE

Field ID: ZZZZZZ
Lab ID: 139853-002
Matrix: Soil
Batch#: 48608
Units: mg/Kg
Diln Fac: 1

Sample Date: 06/09/99
Received Date: 06/10/99
Prep Date: 06/12/99
Analysis Date: 06/12/99

MS Lab ID: QC99779

Analyte	Spike Added	Sample	MS	%Rec #	Limits
Gasoline C7-C12	10	<1	9.7	97	55-134
Surrogate	%Rec	Limits			
Trifluorotoluene	95	62-143			
Bromofluorobenzene	117	59-150			

MSD Lab ID: QC99780

Analyte	Spike Added	MSD	%Rec #	Limits	RPD #	Limit
Gasoline C7-C12	10	8.96	90	55-134	8	30
Surrogate	%Rec	Limits				
Trifluorotoluene	94	62-143				
Bromofluorobenzene	107	59-150				

Column to be used to flag recovery and RPD values with an asterisk

* Values outside of QC limits

RPD: 0 out of 1 outside limits

Spike Recovery: 0 out of 2 outside limits



Lab #: 139755

BATCH QC REPORT

BTXE

Client: Tetra Tech EMI
Project#: P1106.05
Location: JW Silveria UST, Oak.

Analysis Method: EPA 8021B
Prep Method: EPA 5030

MATRIX SPIKE/MATRIX SPIKE DUPLICATE

Field ID: ZZZZZZ
Lab ID: 139871-002
Matrix: Soil
Batch#: 48521
Units: ug/Kg
Diln Fac: 1

Sample Date: 06/05/99
Received Date: 06/11/99
Prep Date: 06/13/99
Analysis Date: 06/13/99

MS Lab ID: QC99841

Analyte	Spike Added	Sample	MS	%Rec #	Limits
MTBE	100	<20	79.02	79	51-145
Benzene	100	<5	78.43	78	57-125
Toluene	100	<5	74.41	74	64-124
Ethylbenzene	100	<5	73.03	73	41-131
m,p-Xylenes	200	<5	151.2	76	50-128
o-Xylene	100	<5	79.21	79	44-138
Surrogate	%Rec	Limits			
Trifluorotoluene	104	59-134			
Bromofluorobenzene	102	38-150			

MSD Lab ID: QC99842

Analyte	Spike Added	MSD	%Rec #	Limits	RPD #	Limit
MTBE	100	80.38	80	51-145	2	13
Benzene	100	73.47	73	57-125	7	10
Toluene	100	66.39	66	64-124	11	12
Ethylbenzene	100	65.84	66	41-131	10	13
m,p-Xylenes	200	148.1	74	50-128	2	13
o-Xylene	100	78.84	79	44-138	0	13
Surrogate	%Rec	Limits				
Trifluorotoluene	107	59-134				
Bromofluorobenzene	104	38-150				

Column to be used to flag recovery and RPD values with an asterisk

* Values outside of QC limits

RPD: 0 out of 6 outside limits

Spike Recovery: 0 out of 12 outside limits



TVH-Total Volatile Hydrocarbons

Client: Tetra Tech EMI
 Project#: P1106.05
 Location: JW Silveria UST, Oak.

Analysis Method: EPA 8015M
 Prep Method: EPA 5030

Sample #	Client ID	Batch #	Sampled	Extracted	Analyzed	Moisture
139755-005	JW3-05	48701	06/02/99	06/16/99	06/16/99	
139755-007	JW3-07	48632	06/02/99	06/16/99	06/16/99	
139755-008	JW3-08	48701	06/02/99	06/16/99	06/16/99	

SB1 grab-gw
SB2 " "
Tap B1

Matrix: Water

Analyte	Units	139755-005	139755-007	139755-008
Diln Fac:		1	1	1
Gasoline C7-C12	ug/L	<50	<50	<50
Surrogate				
Trifluorotoluene	%REC	105	111	110
Bromofluorobenzene	%REC	106	114	115



BTXE

Client: Tetra Tech EMI
 Project#: P1106.05
 Location: JW Silveria UST, Oak.

Analysis Method: EPA 8021B
 Prep Method: EPA 5030

Sample #	Client ID	Batch #	Sampled	Extracted	Analyzed	Moisture
139755-005	JW3-05	48701	06/02/99	06/16/99	06/16/99	
139755-007	JW3-07	48632	06/02/99	06/16/99	06/16/99	
139755-008	JW3-08	48701	06/02/99	06/16/99	06/16/99	

SB1 ggw
SB2 ggw
T.BI.

Matrix: Water

Analyte	Units	139755-005	139755-007	139755-008
Diln Fac:		1	1	1
MTBE	ug/L	<2	33	<2
Benzene	ug/L	<0.5	<0.5	<0.5
Toluene	ug/L	<0.5	<0.5	<0.5
Ethylbenzene	ug/L	<0.5	0.63	<0.5
m,p-Xylenes	ug/L	<0.5	2.2	<0.5
o-Xylene	ug/L	<0.5	0.74	<0.5
Surrogate				
Trifluorotoluene	%REC	109	113	116
Bromofluorobenzene	%REC	110	116	119



Lab #: 139755

BATCH QC REPORT

TVH-Total Volatile Hydrocarbons

Client: Tetra Tech EMI
Project#: P1106.05
Location: JW Silveria UST, Oak.

Analysis Method: EPA 8015M
Prep Method: EPA 5030

METHOD BLANK

Matrix: Water
Batch#: 48701
Units: ug/L
Diln Fac: 1

Prep Date: 06/16/99
Analysis Date: 06/16/99

MB Lab ID: QC00163

Analyte	Result	
Gasoline C7-C12	<50	
Surrogate	%Rec	Recovery Limits
Trifluorotoluene	98	53-150
Bromofluorobenzene	97	53-149



Lab #: 139755

BATCH QC REPORT

BTXE	
Client: Tetra Tech EMI	Analysis Method: EPA 8021B
Project#: P1106.05	Prep Method: EPA 5030
Location: JW Silveria UST, Oak.	
METHOD BLANK	
Matrix: Water	Prep Date: 06/16/99
Batch#: 48701	Analysis Date: 06/16/99
Units: ug/L	
Diln Fac: 1	

MB Lab ID: QC00163

Analyte	Result	
MTBE	<2.0	
Benzene	<0.5	
Toluene	<0.5	
Ethylbenzene	<0.5	
m,p-Xylenes	<0.5	
o-Xylene	<0.5	
Surrogate	%Rec	Recovery Limits
Trifluorotoluene	103	51-143
Bromofluorobenzene	102	37-146



Lab #: 139755

BATCH QC REPORT

TVH-Total Volatile Hydrocarbons			
Client:	Tetra Tech EMI	Analysis Method:	EPA 8015M
Project#:	P1106.05	Prep Method:	EPA 5030
Location:	JW Silveria UST, Oak.		
METHOD BLANK ✓			
Matrix:	Water	Prep Date:	06/15/99
Batch#:	48632	Analysis Date:	06/15/99
Units:	ug/L		
Diln Fac:	1		

MB Lab ID: QC99886

Analyte	Result	
Gasoline C7-C12	<50	
Surrogate	%Rec	Recovery Limits
Trifluorotoluene	93	53-150
Bromofluorobenzene	94	53-149



Lab #: 139755

BATCH QC REPORT

BTXE

Client: Tetra Tech EMI
Project#: P1106.05
Location: JW Silveria UST, Oak.

Analysis Method: EPA 8021B
Prep Method: EPA 5030

METHOD BLANK

Matrix: Water
Batch#: 48632
Units: ug/L
Diln Fac: 1

Prep Date: 06/15/99
Analysis Date: 06/15/99

MB Lab ID: QC99886

Analyte	Result
MTBE	<2.0
Benzene	<0.5
Toluene	<0.5
Ethylbenzene	<0.5
m,p-Xylenes	<0.5
o-Xylene	<0.5

Surrogate	%Rec	Recovery Limits
Trifluorotoluene	90	51-143
Bromofluorobenzene	92	37-146



Lab #: 139755

BATCH QC REPORT

TVH-Total Volatile Hydrocarbons			
Client: Tetra Tech EMI	Analysis Method: EPA 8015M		
Project#: P1106.05	Prep Method: EPA 5030		
Location: JW Silveria UST, Oak.			
LABORATORY CONTROL SAMPLE			
Matrix: Water	Prep Date: 06/16/99		
Batch#: 48701	Analysis Date: 06/16/99		
Units: ug/L			
Diln Fac: 1			

LCS Lab ID: QC00162

Analyte	Result	Spike Added	%Rec #	Limits
Gasoline C7-C12	1868	2000	93	77-117
Surrogate	%Rec	Limits		
Trifluorotoluene	107	53-150		
Bromofluorobenzene	120	53-149		

Column to be used to flag recovery and RPD values with an asterisk

* Values outside of QC limits

Spike Recovery: 0 out of 1 outside limits



Lab #: 139755

BATCH QC REPORT

TVH-Total Volatile Hydrocarbons

Client: Tetra Tech EMI
Project#: P1106.05
Location: JW Silveria UST, Oak.

Analysis Method: EPA 8015M
Prep Method: EPA 5030

LABORATORY CONTROL SAMPLE ✓

Matrix: Water
Batch#: 48632
Units: ug/L
Diln Fac: 1

Prep Date: 06/15/99
Analysis Date: 06/15/99

LCS Lab ID: QC99885

Analyte	Result	Spike Added	%Rec #	Limits
Gasoline C7-C12	1849	2000	92	77-117
Surrogate	%Rec	Limits		
Trifluorotoluene	108	53-150		
Bromofluorobenzene	121	53-149		

Column to be used to flag recovery and RPD values with an asterisk

* Values outside of QC limits

Spike Recovery: 0 out of 1 outside limits



Lab #: 139755

BATCH QC REPORT

BTXE

Client: Tetra Tech EMI
 Project#: P1106.05
 Location: JW Silveria UST, Oak.

Analysis Method: EPA 8021B
 Prep Method: EPA 5030

BLANK SPIKE/BLANK SPIKE DUPLICATE

Matrix: Water
 Batch#: 48701
 Units: ug/L
 Diln Fac: 1

Prep Date: 06/16/99
 Analysis Date: 06/16/99

BS Lab ID: QC00164

Analyte	Spike Added	BS	%Rec	#	Limits
MTBE	20	15.86	79		66-126
Benzene	20	18.1	91		65-111
Toluene	20	19.05	95		76-117
Ethylbenzene	20	19.47	97		71-121
m,p-Xylenes	40	38.98	97		80-123
o-Xylene	20	19.08	95		75-127
Surrogate	%Rec	Limits			
Trifluorotoluene	112	51-143			
Bromofluorobenzene	112	37-146			

BSD Lab ID: QC00165

Analyte	Spike Added	BSD	%Rec	#	Limits	RPD #	Limit
MTBE	20	15.95	80		66-126	1	12
Benzene	20	18.26	91		65-111	1	10
Toluene	20	18.7	94		76-117	2	10
Ethylbenzene	20	19.77	99		71-121	2	11
m,p-Xylenes	40	38.67	97		80-123	1	10
o-Xylene	20	18.92	95		75-127	1	11
Surrogate	%Rec	Limits					
Trifluorotoluene	108	51-143					
Bromofluorobenzene	107	37-146					

Column to be used to flag recovery and RPD values with an asterisk

* Values outside of QC limits

RPD: 0 out of 6 outside limits

Spike Recovery: 0 out of 12 outside limits



Lab #: 139755

BATCH QC REPORT

BTXE	
Client: Tetra Tech EMI	Analysis Method: EPA 8021B
Project#: P1106.05	Prep Method: EPA 5030
Location: JW Silveria UST, Oak.	
BLANK SPIKE/BLANK SPIKE DUPLICATE	
Matrix: Water	Prep Date: 06/15/99
Batch#: 48632	Analysis Date: 06/15/99
Units: ug/L	
Diln Fac: 1	

BS Lab ID: QC99887

Analyte	Spike Added	BS	%Rec #	Limits
MTBE	20	14.66	73	66-126
Benzene	20	15.66	78	65-111
Toluene	20	16.87	84	76-117
Ethylbenzene	20	16.8	84	71-121
m,p-Xylenes	40	33.87	85	80-123
o-Xylene	20	16.72	84	75-127
Surrogate	%Rec	Limits		
Trifluorotoluene	98	51-143		
Bromofluorobenzene	102	37-146		

BSD Lab ID: QC99888

Analyte	Spike Added	BSD	%Rec #	Limits	RPD #	Limit
MTBE	20	14.68	73	66-126	0	12
Benzene	20	15.78	79	65-111	1	10
Toluene	20	16.9	85	76-117	0	10
Ethylbenzene	20	17.03	85	71-121	1	11
m,p-Xylenes	40	34.25	86	80-123	1	10
o-Xylene	20	16.91	85	75-127	1	11
Surrogate	%Rec	Limits				
Trifluorotoluene	94	51-143				
Bromofluorobenzene	98	37-146				

Column to be used to flag recovery and RPD values with an asterisk

* Values outside of QC limits

RPD: 0 out of 6 outside limits

Spike Recovery: 0 out of 12 outside limits



Lab #: 139755

BATCH QC REPORT

TVH-Total Volatile Hydrocarbons			
Client: Tetra Tech EMI	Analysis Method: EPA 8015M		
Project#: P1106.05	Prep Method: EPA 5030		
Location: JW Silveria UST, Oak.			
MATRIX SPIKE/MATRIX SPIKE DUPLICATE			
Field ID: ZZZZZZ	Sample Date:	06/10/99	
Lab ID: 139898-008	Received Date:	06/11/99	
Matrix: Water	Prep Date:	06/16/99	
Batch#: 48701	Analysis Date:	06/16/99	
Units: ug/L			
Diln Fac: 1			

MS Lab ID: QC00166

Analyte	Spike Added	Sample	MS	%Rec #	Limits
Gasoline C7-C12	2000	<50	1798	90	69-131
Surrogate	%Rec	Limits			
Trifluorotoluene	119	53-150			
Bromofluorobenzene	137	53-149			

MSD Lab ID: QC00167

Analyte	Spike Added	MSD	%Rec #	Limits	RPD #	Limit
Gasoline C7-C12	2000	1783	89	69-131	1	13
Surrogate	%Rec	Limits				
Trifluorotoluene	120	53-150				
Bromofluorobenzene	137	53-149				

Column to be used to flag recovery and RPD values with an asterisk

* Values outside of QC limits

RPD: 0 out of 1 outside limits

Spike Recovery: 0 out of 2 outside limits



Lab #: 139755

BATCH QC REPORT

TVH-Total Volatile Hydrocarbons

Client: Tetra Tech EMI	Analysis Method: EPA 8015M
Project#: P1106.05	Prep Method: EPA 5030
Location: JW Silveria UST, Oak.	

MATRIX SPIKE/MATRIX SPIKE DUPLICATE

Field ID: ZZZZZZ	Sample Date: 06/10/99
Lab ID: 139856-002	Received Date: 06/11/99
Matrix: Water	Prep Date: 06/15/99
Batch#: 48632	Analysis Date: 06/15/99
Units: ug/L	
Diln Fac: 1	

MS Lab ID: QC99889

Analyte	Spike Added	Sample	MS	%Rec #	Limits
Gasoline C7-C12	2000	<50	2060	103	69-131
Surrogate	%Rec	Limits			
Trifluorotoluene	115	53-150			
Bromofluorobenzene	132	53-149			

MSD Lab ID: QC99890

Analyte	Spike Added	MSD	%Rec #	Limits	RPD #	Limit
Gasoline C7-C12	2000	2042	102	69-131	1	13
Surrogate	%Rec	Limits				
Trifluorotoluene	120	53-150				
Bromofluorobenzene	138	53-149				

Column to be used to flag recovery and RPD values with an asterisk

* Values outside of QC limits

RPD: 0 out of 1 outside limits

Spike Recovery: 0 out of 2 outside limits



Curtis & Tompkins, Ltd., Analytical Laboratories, Since 1878

2323 Fifth Street, Berkeley, CA 94710, Phone (510) 486-0900, Fax (510) 486-0532

RECEIVED

Laboratory Number 139796

JUN 28 1999

TETRA TECH EM INC.

Tetra Tech EMI
135 Main Street
Suite 1800
San Francisco, CA 94105

Project#: P1106.05
Location: JW Silveria UST, Oak.

Sample ID	Lab ID
JW3-09	139796-001
JW3-10	139796-002
JW3-11	139796-003

I certify that this data package has been reviewed for technical correctness and completeness. Please see attached narrative for a discussion of any analytical problems related to this sample set. Release of this data has been authorized by the Laboratory Manager or the Manager's designee, as verified by the following signatures.

The case narrative is an integral and inseparable part of this report.

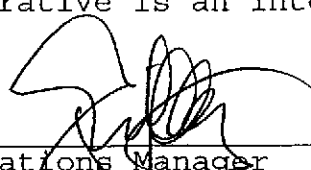
Signature: 
Title: Operations Manager

Date: 6-21-99

Signature: Carol Wortham
Title: Project Manager

Date: 6/21/99



Laboratory Number: 139796

Receipt Date: 06/08/99

Client: Tetra Tech EMI

Location: JW Silveria UST, Oakland

Project#: P1106.05

CASE NARRATIVE

This hardcopy data package contains sample and QC results for three water samples that were received on June 3, 1999.

TPH Purgeables/BTXE: No analytical problems were encountered.

139766

Chain of Custody Record

135 Main St. Suite 1800
San Francisco, CA 94105
415-543-4880
Fax 415-543-5480

PO#		Lab: C&T			No./Container Types					Preservative Added							
Project name: JW SILVEIRA UST OAKLAND		TIEMI technical contact: JACKIE LUTA			Field samplers: ROY GLENN					Analysis Required							
Project number: P1106.05		TIEMI project manager: HAL DAWSON			Field samplers' signatures:												
Sample ID	Sample Description/Notes	Date	Time	Matrix	40 ml VOA	1 Liter Amber	1 Liter Poly	Brass Tube	Glass Jar	CLP VOA	CLP SVOA	CLP Pest/PCBs	CLP Metals	TPH Purgeables	TPH Extractables	MTBE	BTEX
JW3-09	1	6-7-99	1003	WATER	3									X	X	X	
JW3-10	2	↓	1243	"	3									X	X	X	
JW3-11	3	↓	1305	4	3									X	X	X	

Relinquished by:	Name (print)	Company Name	Date	Time
<i>[Signature]</i>	Roy Glenn	TIEMI	6-8	1600
<i>[Signature]</i>	Steven Stanley	Curtis Tompkins	6-8	1600
Relinquished by:				
Received by:				
Relinquished by:				
Received by:				
Relinquished by:				
Received by:				

Turnaround time/remarks:

ω

JW Silver



Curtis & Tompkins, Ltd

COOLER RECEIPT CHECKLIST

Login#: 139796 Date Received: 6/6 Number of Coolers: 1
 Client: ITEM Project: P1106.05

A. Preliminary Examination Phase

Date Opened: 6/6 By (print): J.W. Silver (sign) J.W. Silver

1. Did cooler come with a shipping slip (airbill, etc.)?..... YES NO
- If YES, enter carrier name and airbill number: _____
2. Were custody seals on outside of cooler?..... YES NO
- How many and where? _____ Seal date: _____ Seal name: _____
3. Were custody seals unbroken and intact at the date and time of arrival?..... YES NO uh
4. Were custody papers dry and intact when received?..... YES NO
5. Were custody papers filled out properly (ink, signed, etc.)?..... YES NO
6. Did you sign the custody papers in the appropriate place?..... YES NO
7. Was project identifiable from custody papers?..... YES NO
- If YES, enter project name at the top of this form.
8. If required, was sufficient ice used?..... YES NO
- Type of ice: wet Temperature: 3.0°

B. Login Phase

Date Logged In: 6/6 By (print): J.W. Silver (sign) J.W. Silver

1. Describe type of packing in cooler: _____
2. Did all bottles arrive unbroken?..... YES NO
3. Were labels in good condition and complete (ID, date, time, signature, etc.)?..... YES NO
4. Did bottle labels agree with custody papers?..... YES NO
5. Were appropriate containers used for the tests indicated?..... YES NO
6. Were correct preservatives added to samples?..... YES NO
7. Was sufficient amount of sample sent for tests indicated?..... YES NO
8. Were bubbles absent in VOA samples? If NO, list sample Ids below..... YES NO
9. Was the client contacted concerning this sample delivery?..... YES NO
- If YES, give details below.
- Who was called? _____ By whom? _____ Date: _____

Additional Comments:



TVH-Total Volatile Hydrocarbons

Client: Tetra Tech EMI
Project#: P1106.05
Location: JW Silveria UST, Oak.

Analysis Method: EPA 8015M
Prep Method: EPA 5030

Sample #	Client ID	Batch #	Sampled	Extracted	Analyzed	Moisture
139796-001	JW3-09	48632	06/07/99	06/15/99	06/15/99	
139796-002	JW3-10	48632	06/07/99	06/15/99	06/15/99	
139796-003	JW3-11	48566	06/07/99	06/10/99	06/10/99	

Matrix: Water

Analyte	Units	139796-001	139796-002	139796-003
Diln Fac:		1	1	1
Gasoline C7-C12	ug/L	<50	<50	<50
Surrogate				
Trifluorotoluene	%REC	103	110	94
Bromofluorobenzene	%REC	102	113	98

BTXE

Client: Tetra Tech EMI
Project#: P1106.05
Location: JW Silveria UST, Oak.

Analysis Method: EPA 8021B
Prep Method: EPA 5030

Sample #	Client ID	Batch #	Sampled	Extracted	Analyzed	Moisture
139796-001	JW3-09	48632	06/07/99	06/15/99	06/15/99	
139796-002	JW3-10	48632	06/07/99	06/15/99	06/15/99	
139796-003	JW3-11	48632	06/07/99	06/16/99	06/16/99	

Matrix: Water

MW-3

Analyte	Units	139796-001	139796-002	139796-003
Diln Fac:		1	1	5
MTBE	ug/L	3.4	3 C	250
Benzene	ug/L	<0.5	<0.5	14
Toluene	ug/L	<0.5	<0.5	<2.5
Ethylbenzene	ug/L	<0.5	<0.5	<2.5
m,p-Xylenes	ug/L	<0.5	<0.5	<2.5
o-Xylene	ug/L	<0.5	<0.5	<2.5
Surrogate				
Trifluorotoluene	%REC	102	109	106
Bromofluorobenzene	%REC	104	114	109

C: Presence of this compound confirmed by second column, however, the confirmation concentration differed from the reported result by more than a factor of two



Lab #: 139796

BATCH QC REPORT

Page 1 of 1

TVH-Total Volatile Hydrocarbons

Client: Tetra Tech EMI
Project#: P1106.05
Location: JW Silveria UST,Oak.

Analysis Method: EPA 8015M
Prep Method: EPA 5030

METHOD BLANK

Matrix: Water
Batch#: 48566
Units: ug/L
Diln Fac: 1

Prep Date: 06/10/99
Analysis Date: 06/10/99

MB Lab ID: QC99611

Analyte	Result	
Gasoline C7-C12	<50	
Surrogate	%Rec	Recovery Limits
Trifluorotoluene	100	53-150
Bromofluorobenzene	100	53-149



Lab #: 139796

BATCH QC REPORT

TVH-Total Volatile Hydrocarbons

Client: Tetra Tech EMI
Project#: P1106.05
Location: JW Silveria UST, Oak.

Analysis Method: EPA 8015M
Prep Method: EPA 5030

METHOD BLANK

Matrix: Water
Batch#: 48632
Units: ug/L
Diln Fac: 1

Prep Date: 06/15/99
Analysis Date: 06/15/99

MB Lab ID: QC99886

Analyte	Result	
Gasoline C7-C12	<50	
Surrogate	%Rec	Recovery Limits
Trifluorotoluene	93	53-150
Bromofluorobenzene	94	53-149



Lab #: 139796

BATCH QC REPORT

BTXE

Client: Tetra Tech EMI
Project#: P1106.05
Location: JW Silveria UST, Oak.

Analysis Method: EPA 8021B
Prep Method: EPA 5030

METHOD BLANK

Matrix: Water
Batch#: 48632
Units: ug/L
Diln Fac: 1

Prep Date: 06/15/99
Analysis Date: 06/15/99

MB Lab ID: QC99886

Analyte	Result
MTBE	<2.0
Benzene	<0.5
Toluene	<0.5
Ethylbenzene	<0.5
m,p-Xylenes	<0.5
o-Xylene	<0.5

Surrogate	%Rec	Recovery Limits
Trifluorotoluene	90	51-143
Bromofluorobenzene	92	37-146



Lab #: 139796

BATCH QC REPORT

TVH-Total Volatile Hydrocarbons

Client: Tetra Tech EMI	Analysis Method: EPA 8015M
Project#: P1106.05	Prep Method: EPA 5030
Location: JW Silveria UST, Oak.	

LABORATORY CONTROL SAMPLE

Matrix: Water	Prep Date: 06/10/99
Batch#: 48566	Analysis Date: 06/10/99
Units: ug/L	
Diln Fac: 1	

LCS Lab ID: QC99609

Analyte	Result	Spike Added	%Rec #	Limits
Gasoline C7-C12	1836	2000	92	77-117
Surrogate	%Rec	Limits		
Trifluorotoluene	104	53-150		
Bromofluorobenzene	118	53-149		

Column to be used to flag recovery and RPD values with an asterisk

* Values outside of QC limits

Spike Recovery: 0 out of 1 outside limits



Lab #: 139796

BATCH QC REPORT

TVH-Total Volatile Hydrocarbons

Client: Tetra Tech EMI
Project#: P1106.05
Location: JW Silveria UST, Oak.

Analysis Method: EPA 8015M
Prep Method: EPA 5030

LABORATORY CONTROL SAMPLE

Matrix: Water
Batch#: 48632
Units: ug/L
Diln Fac: 1

Prep Date: 06/15/99
Analysis Date: 06/15/99

LCS Lab ID: QC99885

Analyte	Result	Spike Added	%Rec #	Limits
Gasoline C7-C12	1849	2000	92	77-117
Surrogate	%Rec	Limits		
Trifluorotoluene	108	53-150		
Bromofluorobenzene	121	53-149		

Column to be used to flag recovery and RPD values with an asterisk

* Values outside of QC limits

Spike Recovery: 0 out of 1 outside limits



Lab #: 139796

BATCH QC REPORT

BTXE

Client: Tetra Tech EMI
Project#: P1106.05
Location: JW Silveria UST, Oak.

Analysis Method: EPA 8021B
Prep Method: EPA 5030

BLANK SPIKE/BLANK SPIKE DUPLICATE

Matrix: Water
Batch#: 48632
Units: ug/L
Diln Fac: 1

Prep Date: 06/15/99
Analysis Date: 06/15/99

BS Lab ID: QC99887

Analyte	Spike Added	BS	%Rec #	Limits
MTBE	20	14.66	73	66-126
Benzene	20	15.66	78	65-111
Toluene	20	16.87	84	76-117
Ethylbenzene	20	16.8	84	71-121
m,p-Xylenes	40	33.87	85	80-123
o-Xylene	20	16.72	84	75-127
Surrogate	%Rec	Limits		
Trifluorotoluene	98	51-143		
Bromofluorobenzene	102	37-146		

BSD Lab ID: QC99888

Analyte	Spike Added	BSD	%Rec #	Limits	RPD #	Limit
MTBE	20	14.68	73	66-126	0	12
Benzene	20	15.78	79	65-111	1	10
Toluene	20	16.9	85	76-117	0	10
Ethylbenzene	20	17.03	85	71-121	1	11
m,p-Xylenes	40	34.25	86	80-123	1	10
o-Xylene	20	16.91	85	75-127	1	11
Surrogate	%Rec	Limits				
Trifluorotoluene	94	51-143				
Bromofluorobenzene	98	37-146				

Column to be used to flag recovery and RPD values with an asterisk

* Values outside of QC limits

RPD: 0 out of 6 outside limits

Spike Recovery: 0 out of 12 outside limits



Lab #: 139796

BATCH QC REPORT

Page 1 of 1

TVH-Total Volatile Hydrocarbons

Client: Tetra Tech EMI
 Project#: P1106.05
 Location: JW Silveria UST, Oak.

Analysis Method: EPA 8015M
 Prep Method: EPA 5030

MATRIX SPIKE/MATRIX SPIKE DUPLICATE

Field ID: ZZZZZZ
 Lab ID: 139822-002
 Matrix: Water
 Batch#: 48566
 Units: ug/L
 Diln Fac: 1

Sample Date: 06/09/99
 Received Date: 06/09/99
 Prep Date: 06/10/99
 Analysis Date: 06/10/99

MS Lab ID: QC99612

Analyte	Spike Added	Sample	MS	%Rec #	Limits
Gasoline C7-C12	2000	<50	2100	105	69-131
Surrogate	%Rec	Limits			
Trifluorotoluene	118	53-150			
Bromofluorobenzene	136	53-149			

MSD Lab ID: QC99613

Analyte	Spike Added	MSD	%Rec #	Limits	RPD #	Limit
Gasoline C7-C12	2000	2079	104	69-131	1	13
Surrogate	%Rec	Limits				
Trifluorotoluene	108	53-150				
Bromofluorobenzene	124	53-149				

Column to be used to flag recovery and RPD values with an asterisk

* Values outside of QC limits

RPD: 0 out of 1 outside limits

Spike Recovery: 0 out of 2 outside limits



TVH-Total Volatile Hydrocarbons

Client: Tetra Tech EMI
 Project#: P1106.05
 Location: JW Silveria UST, Oak.

Analysis Method: EPA 8015M
 Prep Method: EPA 5030

MATRIX SPIKE/MATRIX SPIKE DUPLICATE

Field ID: ZZZZZZ
 Lab ID: 139856-002
 Matrix: Water
 Batch#: 48632
 Units: ug/L
 Diln Fac: 1

Sample Date: 06/10/99
 Received Date: 06/11/99
 Prep Date: 06/15/99
 Analysis Date: 06/15/99

MS Lab ID: QC99889

Analyte	Spike Added	Sample	MS	%Rec #	Limits
Gasoline C7-C12	2000	<50	2060	103	69-131
Surrogate	%Rec	Limits			
Trifluorotoluene	115	53-150			
Bromofluorobenzene	132	53-149			

MSD Lab ID: QC99890

Analyte	Spike Added	MSD	%Rec #	Limits	RPD #	Limit
Gasoline C7-C12	2000	2042	102	69-131	1	13
Surrogate	%Rec	Limits				
Trifluorotoluene	120	53-150				
Bromofluorobenzene	138	53-149				

Column to be used to flag recovery and RPD values with an asterisk

* Values outside of QC limits

RPD: 0 out of 1 outside limits

Spike Recovery: 0 out of 2 outside limits