



**CONESTOGA-ROVERS  
& ASSOCIATES**

**RECEIVED**

2:05 pm, Aug 11, 2008

Alameda County  
Environmental Health

5900 Hollis Street, Suite A, Emeryville, California 94608  
Telephone: 510-420-0700 Facsimile: 510-420-9170  
www.CRAworld.com

August 7, 2008

Ms. Barbara Jakub  
Alameda County Health Care Services Agency  
1131 Harbor Bay Parkway, Suite 250  
Alameda, California 94502

Re: **Groundwater Monitoring Report  
Second Quarter 2008**  
Former Exxon Service Station  
3055 35th Avenue, Oakland, California  
Fuel Leak Case No. RO0000271  
CRA Project No. 130105

Dear Ms. Jakub:

On behalf of Golden Empire Properties, Inc., Conestoga-Rovers & Associates, Inc. (CRA) has prepared this *Groundwater Monitoring Report – Second Quarter 2008*. Presented in the report are the Second quarter 2008 activities and the anticipated Third quarter 2008 activities.

If you have any questions or comments regarding this report, please call me at (510) 420-3307.

Sincerely,  
**Conestoga-Rovers & Associates, Inc.**

Mark Jonas, P.G.  
Senior Project Geologist

Attachments: *Groundwater Monitoring Report – Second Quarter 2008*

cc: Golden Empire Properties, Inc. 5942 MacArthur Boulevard, Suite B, Oakland, California 94605  
Mr. Jeffrey Lawson, SVLG, 25 Metro Drive, Suite 600, San Jose, California 95110  
Ms. Dawn Zemo, Zemo & Associates, 986 Wander Way, Incline Village, NV 89451

Equal  
Employment  
Opportunity Employer



**CONESTOGA-ROVERS  
& ASSOCIATES**

## GROUNDWATER MONITORING REPORT - SECOND QUARTER 2008

**Former Exxon Service Station  
3055 35th Avenue, Oakland, California  
Fuel Leak Case No. RO0000271  
CRA Project No. 130105**

**August 7, 2008**

*Prepared for:*

Golden Empire Properties, Inc.  
5942 MacArthur Boulevard, Suite B  
Oakland, California 94605

*Prepared by:*

Conestoga-Rovers & Associates, Inc.  
5900 Hollis Street, Suite A  
Emeryville, California 94608

*Written by:*

John A. Miller  
Staff Geologist

Conestoga-Rovers & Associates, Inc. (CRA) prepared this document for use by our client and appropriate regulatory agencies. It is based partially on information available to CRA from outside sources and/or in the public domain, and partially on information supplied by CRA and its subcontractors. CRA makes no warranty or guarantee, expressed or implied, included or intended in this document, with respect to the accuracy of information obtained from these outside sources or the public domain, or any conclusions or recommendations based on information that was not independently verified by CRA. This document represents the best professional judgment of CRA. None of the work performed hereunder constitutes or shall be represented as a legal opinion of any kind or nature.

Mark Jonas, P.G.  
Senior Project Geologist

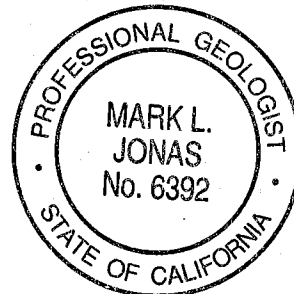



**CONESTOGA-ROVERS  
& ASSOCIATES**

## **GROUNDWATER MONITORING REPORT – SECOND QUARTER 2008**

**Former Exxon Service Station  
3055 35th Avenue, Oakland, California  
Fuel Leak Case No. RO0000271  
CRA Project No. 130105**

**August 7, 2008**

### **INTRODUCTION**

On behalf of Golden Empire Properties, Inc., Conestoga-Rovers & Associates, Inc. (CRA) has prepared this *Groundwater Monitoring Report – Second Quarter 2008* for the referenced site (see Figure 1). Presented in the report are the second quarter 2008 activities and anticipated third quarter 2008 activities.

Figure 1 is a vicinity map. Figure 2 presents recent monitoring groundwater elevations and selected hydrocarbon data. Table 1 presents well construction details. Table 2 provides recent and historic groundwater level measurements and elevations, and hydrocarbon data. Appendix A contains field data sheets for this monitoring event. Appendix B is the recent laboratory analytical report. Appendix C is time-series plots with benzene and total petroleum hydrocarbons as gasoline (TPHg) concentrations, and groundwater elevations.

### **SECOND QUARTER 2008 ACTIVITIES**

#### **Monitoring Activities**

**Field Activities:** On June 14, 2008, CRA subcontracted Muskan Environmental Sampling (MES) to perform quarterly monitoring activities. MES gauged and inspected for separate-phase hydrocarbons (SPH) in all monitoring wells (Figure 2). Groundwater samples were collected from wells MW-1 through MW-4, RW-5, and RW-9. Groundwater monitoring field data sheets are presented in Appendix A. The monitoring data was submitted to the GeoTracker database.

Prior to groundwater sampling, groundwater levels were measured in all monitoring wells. Each monitoring well was then purged before sampling. MES purged at least three well-casing volumes of groundwater from each monitoring well. Field measurements of pH, conductivity, and temperature of purged groundwater were measured after the extraction of each successive casing volume. Well purging continued until consecutive pH, specific conductance, and temperature measurements appeared to stabilize. Field measurements, purge volumes, and sample collection data were recorded on field sampling data forms, presented in Appendix A.



Groundwater samples were collected using new disposable bailers, decanted into appropriate sampling containers supplied by the analytical laboratory. Samples were labeled, placed in protective foam sleeves, stored on crushed, water-based ice at or below 4 degrees Celsius and transported under a chain-of-custody (COC) to the laboratory. The COC used for this monitoring event is provided in Appendix B.

**Sample Analyses:** Groundwater samples were analyzed for total petroleum hydrocarbons as gasoline (TPHg) and total petroleum hydrocarbons as diesel (TPHd) with silica gel clean-up by modified EPA Method SW8015C; and for benzene, toluene, ethylbenzene and xylenes (BTEX) and methyl tertiary butyl ether (MTBE) by EPA Method SW8021B. The laboratory used a modified Zemo & Associates' *Protocol for Gravity Separation of Groundwater Samples to Isolate the Water Phase*. Groundwater samples were also collected for field measurement of dissolved oxygen (DO) from each of the sampled wells. DO was recorded on field data sheets provided in Appendix A. The laboratory analytical report is presented as Appendix B. The analytical data has been submitted to the GeoTracker database.

## **Monitoring Results**

**Groundwater Flow Direction:** Based on depth to water measurements collected during MES's June 14, 2008 site visit, groundwater beneath the site flows towards the west with a gradient of 0.05 ft/ft (Figure 2). The groundwater gradient is generally consistent with historical static groundwater conditions. Groundwater monitoring data is presented in Table 2.

**Hydrocarbon Distribution in Groundwater:** Hydrocarbon concentrations were detected in all six sampled wells. TPHg concentrations ranged from 1,200 micrograms per liter ( $\mu\text{g/L}$ ) to 36,000  $\mu\text{g/L}$ , with the highest concentration detected in well MW-3. Benzene concentrations ranged from 310  $\mu\text{g/L}$  to 4,700  $\mu\text{g/L}$ , with the highest concentration detected in well MW-3. TPHd concentrations ranged from 190  $\mu\text{g/L}$  to 4,900  $\mu\text{g/L}$ , with the highest concentration detected in well MW-3. MTBE was not detected at or above the laboratory reporting during this sampling event. Hydrocarbon concentrations are generally stable or slightly higher than the first quarter 2008 monitoring event (see Appendix C for individual well concentration trend graphs). Analytical results are summarized in Table 2 and shown on Figure 2.

## **Corrective Action Activities**

No corrective action activities took place during the second quarter 2008.

## **ANTICIPATED THIRD QUARTER 2008 ACTIVITIES**

### **Monitoring Activities**

During the third quarter 2008, CRA will coordinate with MES to gauge the site wells, check the wells for SPH, and collect groundwater samples from monitoring wells MW-1 through MW-4, RW-5, and RW-9.



**CONESTOGA-ROVERS  
& ASSOCIATES**

Groundwater Monitoring Report – Second Quarter 2008

Fuel Leak Case No. RO0000271

August 7, 2008

All sampled wells will be field measured for DO. Groundwater samples will be analyzed for TPHg and TPHd with silica gel clean-up by Modified EPA Method SW8015C; and for BTEX and MTBE by EPA Method SW8021B. The laboratory shall also use the Zemo & Associates *Protocol for Gravity Separation of Groundwater Samples to Isolate the Water Phase* only for TPHd analysis. CRA will summarize groundwater monitoring activities and results in the *Groundwater Monitoring Report – Third Quarter 2008*.

### **Offsite and Onsite Characterization**

CRA is currently in the process of obtaining access agreements to complete the offsite investigation. Once access agreements are obtained, CRA will schedule a driller, obtain the necessary permits from Alameda County and the City of Oakland and complete the offsite and onsite investigation. A Characterization Report will be submitted after field activities are complete.

### **ATTACHMENTS**

Figure 1 – Vicinity Map

Figure 2 – Groundwater Elevation and Hydrocarbon Concentration Map – June 14, 2008

Table 1 – Well Construction Details

Table 2 – Groundwater Elevations and Analytical Data

Appendix A – Field Data Sheets

Appendix B – Laboratory Analytical Report

Appendix C – TPHg and Benzene Concentration Trend Graphs

I:\R\Golden Empire Properties\Reports & QM\QM2008\2Q08\QMR 2Q08 Golden Empire Prop 130105.doc

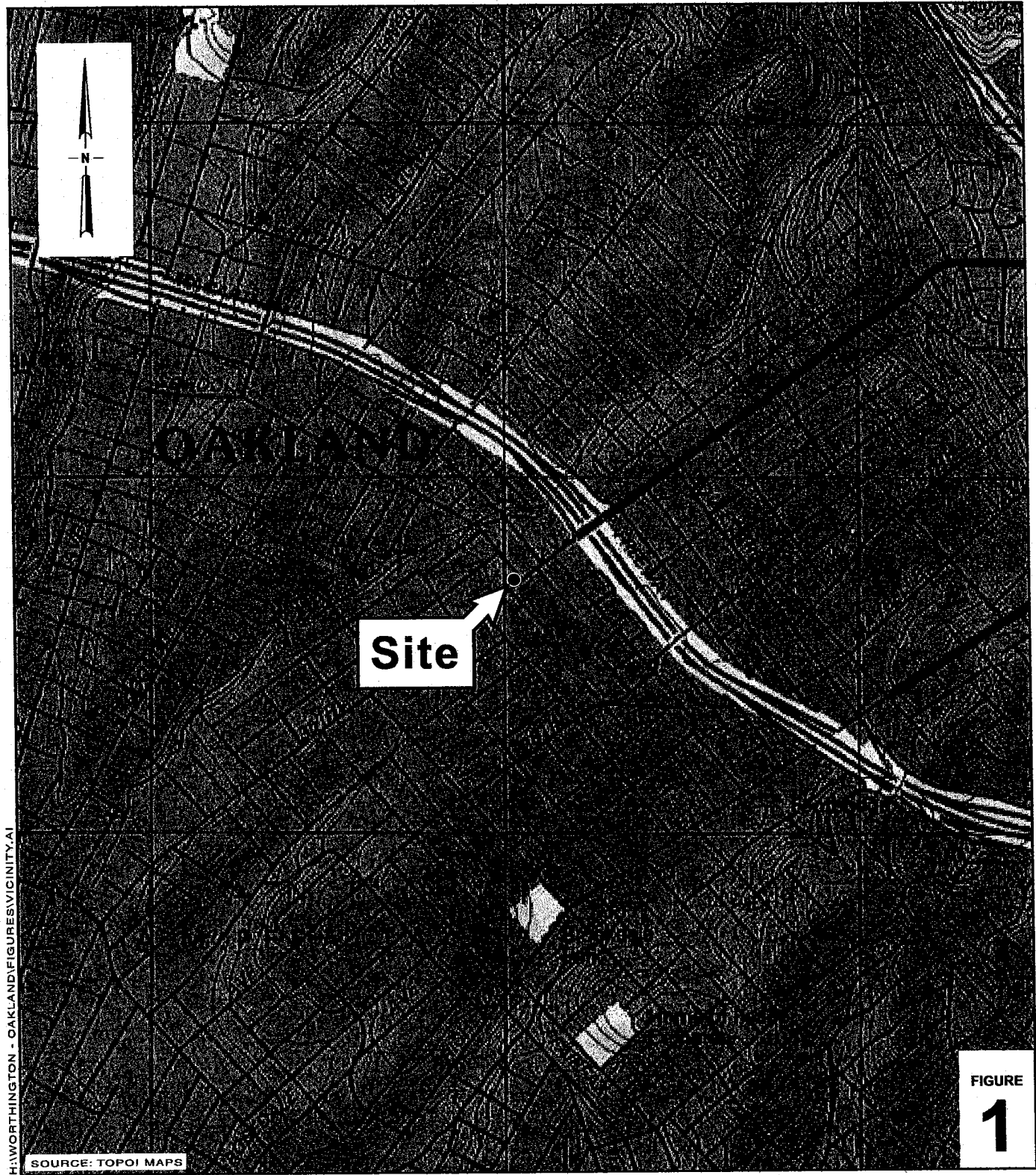

H:\WORTHINGTON - OAKLAND\FIGURES\VICINITY.A1

SOURCE: TOPOI MAPS

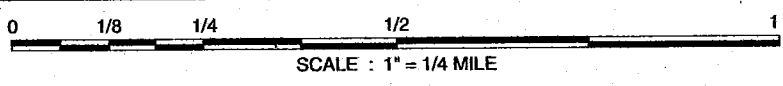
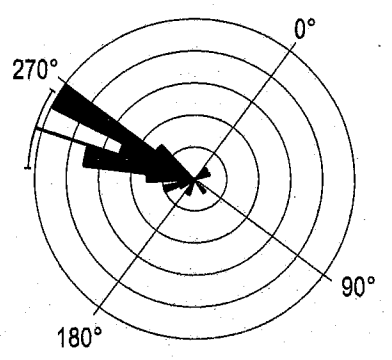
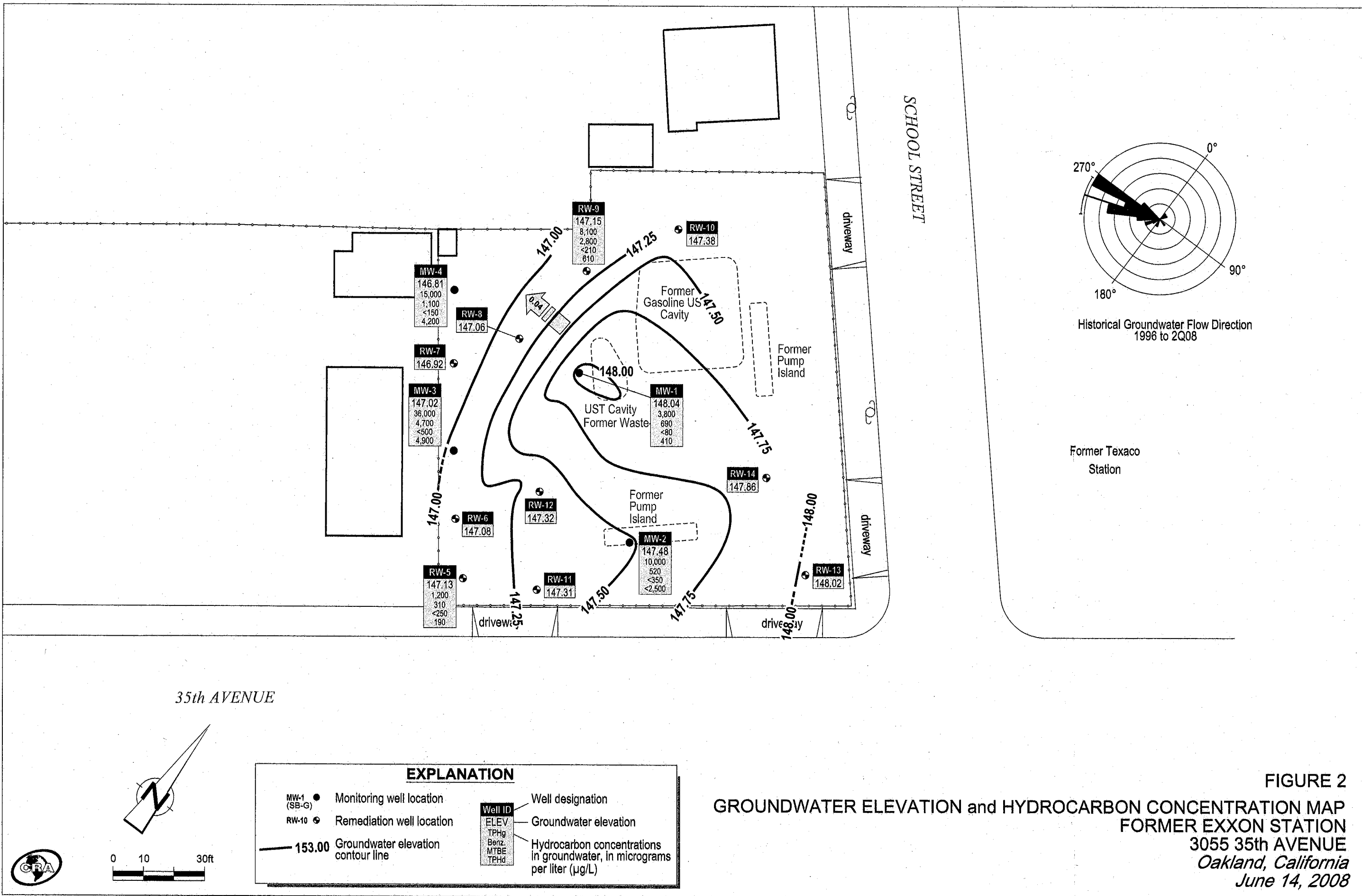

FIGURE  
**1**

**Former Exxon Station**  
 3035 35th Avenue  
 Oakland, California



**Vicinity Map**



Historical Groundwater Flow Direction  
1996 to 2Q08

Former Texaco  
Station

35th AVENUE

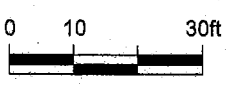

EXPLANATION	
MW-1 (SB-G)	Monitoring well location
RW-10	Remediation well location
153.00	Groundwater elevation contour line
Well ID	Well designation
ELEV	Groundwater elevation
TPHg	Hydrocarbon concentrations in groundwater, in micrograms per liter (µg/L)
Benz	
MTBE	
TPHd	

**FIGURE 2**  
**GROUNDWATER ELEVATION and HYDROCARBON CONCENTRATION MAP**  
**FORMER EXXON STATION**  
**3055 35th AVENUE**  
**Oakland, California**  
**June 14, 2008**

# Conestoga-Rovers & Associates

**Table 1. Well Construction Details - Former Exxon Service Station, 3055 35th Avenue, Oakland, California**

Well ID	Date Installed	Borehole Depth (ft)	Borehole Diameter (in)	Casing Diameter (in)	Screen Interval (ft bgs)	Screen Size (in)	Filter Pack (ft bgs)	Bentonite Seal (ft bgs)	Cement Seal (ft bgs)	TOC Elevation (ft msl)
MW-1	May 9, 1994	26.5	NA	4	10 - 25	0.010	9.5 - 25	7.5 - 9.5	0 - 7.5	167.02
MW-2	May 9, 1994	26.5	NA	4	10 - 25	0.010	9.5 - 25	7.5 - 8.5	0 - 7.5	166.14
MW-3	May 9, 1994	26.5	NA	2	10 - 25	0.010	9 - 25	7 - 9 25 - 26.5	0 - 7	162.94
MW-4	Feb. 26, 1997	30.0	NA	2	10 - 30	0.010	8 - 30	7 - 8	0 - 7	163.49
RW-5	Aug. 5, 1998	25.7	NA	4	5 - 25.5	0.010 (?)	4.5 - 25.7	2.5 - 4.5	0 - 2.5	162.34
RW-6	Aug. 5, 1998	25.5	NA	4	5 - 25.5	0.010 (?)	5 - 25.5	2.5 - 5	0 - 2.5	162.36
RW-7	Aug. 5, 1998	29.5	NA	4	5 - 29.5	0.010 (?)	5 - 29.5	3 - 5	0 - 3	162.72
RW-8	Aug. 5, 1998	29.5	NA	4	5 - 29.5	0.010 (?)	5 - 29.5	3 - 5	0 - 3	164.13
RW-9	Aug. 6, 1998	25.0	NA	4	5 - 25	0.010 (?)	5 - 25	3 - 5	0 - 3	163.86
RW-10	Aug. 6, 1998	25.0	NA	4	5 - 25	0.010 (?)	5 - 25	3 - 5	0 - 3	163.02
RW-11	Aug. 6, 1998	25.0	NA	4	5 - 25	0.010 (?)	5 - 25	3 - 5	0 - 3	162.57
RW-12	Aug. 6, 1998	27.0	NA	4	5 - 27	0.010 (?)	5 - 27	3 - 5	0 - 3	163.06
RW-13	Aug. 6, 1998	25.0	NA	4	5 - 25	0.010 (?)	5 - 25	3 - 5	0 - 3	164.34
RW-14	Aug. 6, 1998	25.0	NA	4	5 - 25	0.010 (?)	5 - 25	3 - 5	0 - 3	163.76

**Abbreviations / Notes**

ft = feet

in = inches

ft bgs = feet below grade surface

ft msl = feet above mean sea level

TOC = top of casing

NA = Not Available



# Conestoga-Rovers & Associates

**Table 2. Groundwater Elevations and Analytical Data - Former Exxon Service Station, 3055 35th Avenue, Oakland, California**

Well ID	Date	TOC GW Depth (ft)	SPH (ft)	GW Elev. (ft)	Note	TPHg	TPHd	TPHmo	Concentrations in micrograms per liter (µg/L)				DO (mg/L)	DPE System Status	
									Benzene	Toluene	Ethylbenzene	Xylenes			
MW-1	5/25/1994	16.79	Sheen	84.06		120,000	25,000	<50,000	22,000	17,000	2,800	16,000	---	---	
100.85	7/19/1994	20.77	---	80.08		---	---	---	---	---	---	---	---	---	
	8/18/1994	21.04	Sheen	79.81		925,000	---	---	16,500	6,200	1,000	9,400	---	---	
	11/11/1994	15.80	---	85.05		57,000	---	---	14,000	4,400	1,400	6,400	---	---	
	2/27/1995	15.53	---	85.32		45,000	---	---	2,900	2,500	760	4,100	---	---	
	5/23/1995	15.29	---	85.56		22,000	---	---	9,900	990	790	2,000	---	---	
	8/22/1995	20.90	---	79.95		23,000	---	---	6,900	340	1,200	1,900	---	---	
	11/29/1995	22.19	---	78.66		37,000	---	---	9,900	530	1,600	2,900	---	---	
	2/21/1996	11.69	---	89.16		33,000	4,300	---	10,000	480	1,000	1,800	3,300	---	
	5/21/1996	14.62	---	86.23		36,000	8,500	---	8,500	1,400	1,300	2,800	1,900	---	
	8/22/1996	22.30	---	78.55		41,000	6,200	---	8,600	1,300	1,500	2,900	<200	8.0	
	11/27/1996	17.24	Sheen	83.61		38,000	6,100	---	9,600	950	1,600	3,100	<400	5.6	
	3/20/1997	16.65	---	84.20		33,000	10,000	---	6,100	560	970	2,200	<400	8.5	
	6/25/1997	19.77	---	81.08		31,000	7,400 <sup>d</sup>	---	7,400	440	890	1,800	<400	3.7	
	9/17/1997	20.12	---	80.73		32,000 <sup>d</sup>	3,500 <sup>e</sup>	---	9,100	550	1,000	2,000	<1,000	2.1	
	12/22/1997	12.95	---	87.90		26,000 <sup>d</sup>	5,800 <sup>e</sup>	---	7,900	370	920	1,500	<790	0.7	
	3/18/1998	12.34	Sheen	88.51		30,000 <sup>d</sup>	4,200 <sup>e,f</sup>	---	7,800	820	840	2,000	<1,100	1.3	
	7/14/1998	17.34	---	83.51		41,000 <sup>d</sup>	8,900 <sup>e,f</sup>	---	8,200	1,100	1,200	3,000	<200	1.8	
	9/30/1998	19.90	---	80.95		37,000	3,300	---	11,000	950	1,200	2,800	<20	2.0	
	12/8/1998	15.62	---	85.23		22,000	3,700	---	3,000	1,200	730	3,100	<900	---	
	3/29/1999	11.98	---	88.87		36,000 <sup>d</sup>	6,800 <sup>e</sup>	---	12,000	750	1,300	2,400	950	0.50	
	6/29/1999	20.77	---	80.08		28,000 <sup>d</sup>	3,500 <sup>e</sup>	---	7,300	420	810	1,700	<1,300	0.10	
	9/28/1999	19.68	---	81.17		13,000 <sup>d</sup>	3,600 <sup>e,f</sup>	---	3,200	130	320	1,100	<210	0.55	
	12/10/1999	17.02	---	83.83		25,000 <sup>d</sup>	2,900 <sup>e,f</sup>	---	5,400	130	620	1,400	<1,000	1.03	
	3/23/2000	12.76	---	88.09		21,000 <sup>d</sup>	3,300 <sup>f</sup>	---	4,700	140	470	1,100	<350	---	
	9/7/2000	19.45	---	81.40		40,000 <sup>d,g</sup>	12,000 <sup>g</sup>	---	3,700	1,400	910	4,900	<50	0.17	
	12/5/2000	18.60	---	82.25		26,000 <sup>a</sup>	3,400 <sup>e</sup>	---	7,900	150	580	810	<300	0.35	Not operating
	3/7/2001	16.19	---	84.66		13,000	2,400	---	2,700	43	69	300	<100	0.49	Not operating
	6/6/2001	18.47	---	82.38		19,000	4,000	---	4,500	130	270	430	<400	0.39	Not operating
	8/30/2001	21.70	---	79.15		8,800 <sup>a</sup>	1,400 <sup>d</sup>	---	2,100	45	91	240	<130	0.27	Operating
	12/7/2001	26.55	---	74.30		8,700 <sup>d</sup>	1,900 <sup>e,f</sup>	---	1,300	160	38	730	<20	0.59	Operating
	3/11/2002	17.13	---	83.72		9,400 <sup>d</sup>	1,400 <sup>e</sup>	---	2,100	200	74	470	<20	0.39	Operating
	6/10/2002	24.10	---	76.75		4,200 <sup>d</sup>	900 <sup>e,k</sup>	---	830	170	110	460	<100	---	Operating
	9/26/2002	20.30	---	80.55		7,000 <sup>d</sup>	1,300 <sup>e,lk</sup>	---	1,300	190	200	760	<100	0.70	Operating
	11/21/2002	21.55	---	79.30		83,000 <sup>d,g</sup>	200,000 <sup>g</sup>	---	7,100	1,700	3,000	13,000	<1,000	0.49	Operating
	1/13/2003	14.80	---	86.05		20,000 <sup>d</sup>	5,300 <sup>e,f</sup>	---	2,300	480	300	2,100	<500	0.33	Not operating
	4/25/2003	20.90	---	79.95		4,200 <sup>d</sup>	320 <sup>e</sup>	---	580	81	59	470	<50	---	Operating
	5/30/2003	16.65	---	84.20		---	---	---	---	---	---	---	---	---	Not operating
	9/3/2003	24.16	---	76.69		14,000 <sup>d</sup>	36,000 <sup>e,f</sup>	---	300	50	33	480	<50	---	Operating
	12/2/2003	24.12	Sheen <sup>Lab</sup>	76.73		7,100 <sup>d,g</sup>	9,300 <sup>e,g</sup>	---	1,400	230	160	820	<100	---	Operating

# Conestoga-Rovers & Associates

**Table 2. Groundwater Elevations and Analytical Data - Former Exxon Service Station, 3055 35th Avenue, Oakland, California**

Well ID	Date	TOC GW Depth (ft)	SPH (ft)	GW Elev. (ft)	Note	TPHg	TPHd	TPHmo	Concentrations in micrograms per liter (µg/L)				DO (mg/L)	DPE System Status	
									Benzene	Toluene	Ethylbenzene	Xylenes			
167.02	3/18/2004	17.70	---	83.15		3,600 <sup>d</sup>	1,100 <sup>e,f</sup>	---	650	59	38	370	<90	---	Operating
MW-1	6/16/2004	19.20	---	147.82		8,100 <sup>d</sup>	2,300 <sup>e,f</sup>	---	1,500	69	22	1,000	<100	---	Not operating
Continued	9/27/2004	23.07	---	143.95		7,800 <sup>d</sup>	1,700 <sup>e</sup>	---	1,800	110	120	670	<180	0.28	Not operating
	12/27/2004	17.04	---	149.98		10,000 <sup>d</sup>	1,400 <sup>e</sup>	---	2,400	170	170	1,500	<120	0.41	Not operating
	3/7/2005	10.73	---	156.29		8,700 <sup>d</sup>	1,300 <sup>e,fk</sup>	---	1,200	99	140	770	<500	0.91	Not operating
	6/21/2005	14.60	---	152.42		6,500 <sup>d</sup>	930 <sup>ek</sup>	---	820	26	57	110	<250	---	Not operating
	9/21/2005	19.64	---	147.38		2,900 <sup>d</sup>	860 <sup>e,k,f</sup>	---	430	19	46	150	<50	1.14	Not operating
	12/14/2005	17.63	Sheen Field	149.39		6,200 <sup>d</sup>	4,000 <sup>e,fk</sup>	---	570	32	72	420	<110	1.08	Not operating
	3/22/2006	10.52	Sheen Field	156.50		8,300 <sup>d</sup>	1,100 <sup>e,fk</sup>	---	1,700	100		660	<150	0.84	Not operating
	6/30/2006	16.33	Sheen Field	150.69		2,100 <sup>d,l</sup>	1,500 <sup>m,k,l</sup>	---	320	6.1	<1.0	77	<90	0.66	Not operating
	9/5/2006	19.96	Sheen Lab	147.06		5,500 <sup>d,g</sup>	1,500 <sup>e,fk,g</sup>	---	1,000	45	81	310	<120	0.38	Not operating
	12/6/2006	19.92	Sheen Lab	147.10		4,500 <sup>d,g</sup>	760 <sup>e,g</sup>	---	440	13	42	190	<60	0.55	Not operating
	3/16/2007	13.62	---	153.40		7,500 <sup>d</sup>	1,800 <sup>e,f</sup>	---	1,400	30	100	270	<150	0.58	Not operating
	6/15/2007	18.07	Sheen Field	148.95		5,600 <sup>d</sup>	1,500 <sup>e,k,f</sup>	---	1,200	29	84	190	56	0.74	Not operating
	9/6/2007	20.84	---	146.18		2,800 <sup>d</sup>	690 <sup>e,f</sup>	---	590	17	35	100	<80	0.90	Not operating
	12/8/2007	18.66	Sheen Field	148.36		4,500 <sup>d</sup>	520 <sup>e,f</sup>	---	570	13	57	200	<120	1.24	Not operating
	3/9/2008	12.98	Sheen Field	154.04	Z	4,600 <sup>d</sup>	470 <sup>e</sup>	<250	1,100	23	82	140	<50	1.17	Not operating
6/14/2008	18.98	---	148.04	Z	3,800 <sup>d</sup>	410 <sup>e</sup>	<250	690	12	64	240	<80	---	Not operating	
MW-2	5/25/1994	15.65	---	84.35		61,000	6,900	<5,000	9,900	7,400	960	4,600	---	---	
100.00	7/19/1994	19.81	---	80.19		---	---	---	---	---	---	---	---	---	
	8/18/1994	20.37	---	79.63		88,000	---	---	10,750	10,500	1,850	9,600	---	---	
	11/11/94	15.52	---	84.48		54,000	---	---	5,900	6,700	1,300	7,500	---	---	
	2/27/1995	14.46	Sheen	85.54		44,000	---	---	5,100	5,300	930	6,400	---	---	
	5/23/1995	14.17	---	85.83		33,000	---	---	8,200	5,600	900	6,600	---	---	
	8/22/1995	19.80	---	80.20		38,000	---	---	6,400	5,000	1,100	5,600	---	---	
	11/29/95	21.05	---	78.95		46,000	---	---	7,100	5,300	1,300	6,000	---	---	
	2/21/1996	10.53	---	89.47		59,000	---	---	8,000	6,000	1,800	8,900	4,500	---	
	5/21/1996	13.47	---	86.53		51,000	3,400	---	8,200	5,200	1,300	6,600	2,400	---	
	8/22/1996	19.12	---	80.88		37,000	5,700	---	5,100	3,500	960	4,500	<200	3.0	
	11/27/1996	16.61	Sheen	83.39		54,000	10,000	---	9,800	7,000	1,800	7,900	<2,000	3.1	
	3/20/1997	15.39	---	84.61		27,000	6,100	---	3,700	2,300	580	2,800	<400	8.1	
	6/25/1997	18.62	---	81.38		42,000	7,800 <sup>b</sup>	---	7,400	3,800	1,200	5,700	<200	0.9	
	9/17/1997	19.05	Sheen	80.95		41,000 <sup>d</sup>	8,900 <sup>e</sup>	---	5,200	3,400	1,300	5,900	<700	1.2	
	12/22/1997	14.09	---	85.91		47,000 <sup>d</sup>	6,100 <sup>e</sup>	---	8,500	4,600	1,800	8,400	<1,200	1.2	
	3/18/1998	10.83	Sheen	89.17		58,000 <sup>d</sup>	7,000 <sup>e,f</sup>	---	9,300	6,100	1,800	8,200	<1,100	1.1	
	7/14/1998	16.07	---	83.93		42,000 <sup>d</sup>	5,300 <sup>e,f</sup>	---	6,000	3,000	1,000	4,800	<200	1.5	
	9/30/1998	18.71	---	81.29		22,000	2,400	---	3,600	1,300	720	3,200	<30	1.8	
	12/8/1998	14.80	---	85.20		32,000	3,100	---	9,200	680	1,100	2,300	<2,000	---	
	3/29/1999	11.81	---	88.19		28,000 <sup>d</sup>	7,500 <sup>e,f</sup>	---	4,400	1,600	950	4,100	410	1.86	

# Conestoga-Rovers & Associates

**Table 2. Groundwater Elevations and Analytical Data - Former Exxon Service Station, 3055 35th Avenue, Oakland, California**

Well ID	Date	TOC GW Depth (ft)	SPH (ft)	GW Elev. (ft)	Note	TPHg	TPHd	TPHmo	Concentrations in micrograms per liter (µg/L)				DO (mg/L)	DPE System Status	
									Benzene	Toluene	Ethylbenzene	Xylenes			
MW-2	6/29/1999	19.54	---	80.46		28,000 <sup>d</sup>	3,300 <sup>e</sup>	---	3,500	1,100	690	3,100	<1,000	0.41	
Continued	9/28/1999	18.61	---	81.39		15,000 <sup>d</sup>	3,400 <sup>e,f</sup>	---	1,200	540	230	2,300	<36	1.18	
	12/10/1999	16.53	---	83.47		17,000 <sup>d</sup>	2,500 <sup>e,f</sup>	---	1,300	780	420	2,700	<40	0.17	
	3/23/2000	13.56	---	86.44		25,000 <sup>d</sup>	3,100 <sup>i</sup>	---	1,900	1,100	660	3,700	<500	---	
	9/7/2000	18.25	---	81.75		62,000 <sup>d,g</sup>	32,000 <sup>e,g</sup>	---	5,300	2,300	1,500	8,400	<100	0.39	
	12/5/2000	17.45	---	82.55		60,000 <sup>d,g</sup>	87,000 <sup>e,g</sup>	---	5,100	2,200	1,600	9,000	<200	0.31	Not operating
	3/7/2001	15.68	---	84.32		34,000	3,900	---	1,200	770	620	4,300	<200	0.44	Not operating
	6/6/2001	17.51	---	82.49		110,000	48,000	---	14,000	9,000	1,900	12,000	<950	0.24	Not operating
	8/30/2001	21.00	---	79.00		43,000 <sup>h</sup>	15,000 <sup>h</sup>	---	3,100	720	980	5,500	<200	---	Operating
	12/7/2001	24.45	---	75.55		4,100 <sup>d</sup>	750 <sup>e,f</sup>	---	510	88	8.2	580	<20	0.47	Operating
	3/11/2002	16.95	---	83.05		4,700 <sup>d</sup>	590 <sup>e</sup>	---	1,200	150	30	310	<50	0.24	Operating
	6/10/2002	18.59	---	81.41		14,000 <sup>d</sup>	2,000 <sup>e</sup>	---	2,600	710	150	2,000	<800	---	Operating
	9/26/2002	20.39	---	79.61		4,800 <sup>d</sup>	660 <sup>e</sup>	---	770	200	140	740	<50	0.29	Operating
	11/21/2002	18.75	---	81.25		210,000 <sup>d,g</sup>	350,000 <sup>e,g</sup>	---	14,000	23,000	4,400	28,000	<1,700	0.43	Operating
	1/13/2003	13.60	Sheen Lab	86.40		32,000 <sup>d,g</sup>	14,000 <sup>e,g,k</sup>	---	4,500	1,600	920	3,600	<1000	0.39	Not operating
	4/25/2003	19.05	---	80.95		3,800 <sup>d</sup>	310 <sup>e</sup>	---	460	78	72	410	310	---	Operating
	5/30/2003	15.23	---	84.77		---	---	---	---	---	---	---	---	---	Not operating
	9/3/2003	23.57	---	76.43		2,900 <sup>d</sup>	2,300 <sup>e</sup>	---	240	57	68	380	770	---	Operating
12/2/2003	23.17	Sheen Lab	76.83		2,400 <sup>d,g</sup>	3,300 <sup>e,g</sup>	---	91	20	14	250	890	---	Operating	
3/18/2004	15.78	---	84.22		4,200 <sup>d</sup>	870 <sup>e,f</sup>	---	730	89	<5.0	480	2,300	---	Operating	
166.14	6/16/2004	18.15	---	147.99		15,000 <sup>d</sup>	9,800 <sup>e,f</sup>	---	800	210	290	1,800	2,000	---	Not operating
(Monument	9/27/2004	27.55**	---	138.59		770 <sup>d</sup>	1,000 <sup>e,f,k</sup>	---	20	7.9	10	140	1,600	0.79	Operating
Well box)	12/27/2004	16.81	---	149.33		17,000 <sup>d</sup>	3,800 <sup>e,f</sup>	---	1,300	370	540	3,800	620	0.94	Not operating
	3/7/2005	9.31	Sheen Field & Lab	156.83		20,000 <sup>d,g</sup>	8,300 <sup>e,f,k,g</sup>	---	1,400	330	430	2,600	1,100	0.88	Not operating
	6/21/2005	13.42	Sheen Lab	152.72		36,000 <sup>d,g</sup>	15,000 <sup>e,g</sup>	---	1,700	310	460	3,100	1,200	---	Not operating
	9/21/2005	18.50	Sheen Field	147.64		4,600 <sup>d</sup>	1,100 <sup>e,f</sup>	---	370	62	110	740	1,100	0.86	Not operating
	12/14/2005	16.40	Sheen Field & Lab	149.74		29,000 <sup>d,g</sup>	49,000 <sup>e,f,k,g</sup>	---	1,700	260	600	3,700	1,000	0.99	Not operating
	3/22/2006	9.15	Sheen Lab	156.99		21,000 <sup>d,g</sup>	23,000 <sup>e,f,k,g</sup>	---	2,300	200	550	2,800	1,200	0.91	Not operating
	6/30/2006	16.78	Sheen Field & Lab	149.36		18,000 <sup>d,g</sup>	55,000 <sup>e,f,k,g</sup>	---	1,100	71	270	1,400	1,200	0.84	Not operating
	9/5/2006	18.96	Sheen Lab	147.18		15,000 <sup>d,g</sup>	19,000 <sup>e,f,k,g</sup>	---	680	70	260	1,400	<1,000	0.79	Not operating
	12/6/2006	18.01	Sheen Field & Lab	148.13		27,000 <sup>d,g</sup>	31,000 <sup>e,f,k,g</sup>	---	1,100	51	420	1,600	<900	0.48	Not operating
	3/16/2007	12.31	Sheen Field & Lab	153.83		44,000 <sup>d,g</sup>	49,000 <sup>e,f,k,g</sup>	---	1,800	71	670	2,200	<900	0.52	Not operating
	6/15/2007	17.31	Sheen Field & Lab	148.83		18,000 <sup>d,g</sup>	21,000 <sup>e,f,k,g</sup>	---	700	22	290	740	<650	0.68	Not operating
	9/6/2007	19.28	Sheen Field & Lab	146.86		17,000 <sup>h</sup>	8,400 <sup>e,g</sup>	---	1,000	53	450	1,100	<700	0.72	Not operating
	12/8/2007	17.72	Sheen Field & Lab	148.42		14,000 <sup>d,g</sup>	3,600 <sup>e,f,g</sup>	---	640	13	220	520	<300	0.80	Not operating
	3/9/2008	12.09	Sheen Field	154.05	Z	7,900 <sup>d</sup>	3,100 <sup>e</sup>	<250	840	24	280	380	<380	0.68	Not operating
	6/14/2008	18.66	Sheen Field	147.48	Z	10,000 <sup>d</sup>	2,500 <sup>e</sup>	<250	520	18	200	370	<350	0.97	Not operating
MW-3	5/25/1994	13.93	Sheen	82.94		56,000	14,000	<50,000	14,000	14,000	1,300	11,000	---	---	
96.87	7/19/1994	17.04	---	79.83		---	---	---	---	---	---	---	---	---	

# Conestoga-Rovers & Associates

**Table 2. Groundwater Elevations and Analytical Data - Former Exxon Service Station, 3055 35th Avenue, Oakland, California**

Well ID	Date	TOC GW	SPH	GW	Note	TPHg	TPHd	TPHmo	Benzene	Toluene	Ethylbenzene	Xylenes	MTBE	DO	DPE System
TOC		Depth (ft)	(ft)	Elev. (ft)		Concentrations in micrograms per liter (µg/L)							(mg/L)	Status	
MW-3	8/18/1994	17.75	--	79.12		116,000	--	--	28,300	26,000	2,400	15,000	--	--	
Continued	11/11/94	17.80	--	79.07		89,000	--	--	1,600	1,900	1,900	14,000	--	--	
	2/27/1995	11.86	Sheen	85.01		250,000	--	--	22,000	26,000	7,800	21,000	--	--	
	5/23/1995	11.60	Sheen	85.27		310,000	--	--	18,000	17,000	4,500	2,800	--	--	
	8/22/1995	17.10	--	79.77		74,000	--	--	14,000	13,000	1,900	11,000	--	--	
	11/29/1995	16.34	--	80.53		220,000	--	--	25,000	25,000	3,500	19,000	--	--	
	2/21/1996	7.92	--	88.95		60,000	--	--	10,000	7,800	1,500	8,800	3,400	--	
	5/21/1996	10.86	Sheen	86.01		69,000	13,000	--	17,000	9,400	1,700	9,400	2,600	--	
	8/22/1996	16.50	--	80.37		94,000	16,000	--	17,000	15,000	2,100	12,000	330	2.0	
	11/27/1996	13.47	Sheen	83.40		82,000	24,000	--	14,000	13,000	2,400	13,000	<1,000	2.4	
	3/20/1997	12.86	--	84.01		56,000	11,000	--	9,900	6,900	1,300	8,000	3,500	9.0	
	6/25/1997	15.98	--	80.89		49,000	7,700 <sup>b</sup>	--	9,700	7,100	1,300	7,000	220	5.8	
	9/17/1997	16.34	Sheen	80.53		78,000 <sup>d</sup>	15,000 <sup>e</sup>	--	11,000	9,900	1,800	10,000	<1,200	0.7	
	12/22/1997	10.71	Sheen	86.16		49,000 <sup>d</sup>	14,000 <sup>e</sup>	--	7,300	5,300	1,400	7,500	<1,100	3.1	
	3/18/1998	8.41	Sheen	88.46		120,000 <sup>d</sup>	20,000 <sup>e,f</sup>	--	21,000	19,000	2,600	15,000	<1,600	1.6	
	7/14/1998	13.51	--	83.36		94,000 <sup>d,g</sup>	65,000 <sup>e,f,g</sup>	--	18,000	14,000	1,900	11,000	<1,400	1.8	
	9/30/1998	16.14	--	80.73		91,000	9,800	--	17,000	13,000	2,100	12,000	<1300	2.0	
	12/8/1998	11.20	--	85.67		51,000	4,200	--	8,000	6,800	1,400	7,500	<1,100	--	
	3/29/1999	7.95	--	88.92		39,000 <sup>d</sup>	4,600 <sup>e</sup>	--	8,900	4,400	940	4,500	810	0.56	
	6/29/1999	16.98	--	79.89		71,000 <sup>d</sup>	6,900 <sup>e</sup>	--	12,000	7,300	1,400	8,400	<1,700	0.19	
	9/28/1999	15.99	--	80.88		60,000 <sup>d</sup>	7,800 <sup>e</sup>	--	9,400	9,200	1,000	9,900	200	0.53	
	12/10/1999	13.31	--	83.56		53,000 <sup>d</sup>	5,300 <sup>e,f</sup>	--	8,000	6,400	1,100	8,100	<200	0.48	
	3/23/2000	8.98	--	87.89		77,000 <sup>d,g</sup>	11,000 <sup>h,i</sup>	--	10,000	9,400	1,600	11,000	<430	--	
	9/7/2000	15.61	--	81.26		100,000 <sup>d,g</sup>	19,000 <sup>e,f,g</sup>	--	17,000	12,000	1,600	11,000	<500	--	
	12/5/2000	14.80	--	82.07		110,000 <sup>d,g</sup>	17,000 <sup>e,g</sup>	--	17,000	11,000	1,900	12,000	<750	0.37	Not operating
	3/7/2001	14.27	--	82.60		60,000	13,000	--	7,000	4,600	900	7,100	<350	0.49	Not operating
	6/6/2001	14.88	--	81.99		43,000	12,000	--	3,000	1,000	770	5,200	<400	1.71	Not operating
	8/30/2001	12.43	--	84.44		95,000 <sup>a,h</sup>	190,000 <sup>d,b</sup>	--	6,900	10,000	2,700	15,000	<250	0.24	Operating
	12/7/2001	24.65	--	72.22		25,000 <sup>d</sup>	3,900 <sup>e,f</sup>	--	2,500	1,700	64	2,200	<200	0.19	Operating
	3/11/2002	14.69	--	82.18		30,000 <sup>d</sup>	2,800 <sup>e,k</sup>	--	5,000	2,400	190	1,800	<1,300	0.30	Operating
	6/10/2002	22.94	--	73.93		9,000 <sup>d</sup>	990 <sup>e,k</sup>	--	1,800	1,300	96	1,000	<300	--	Operating
	9/26/2002	18.85	--	78.02		50,000 <sup>d,g</sup>	130,000 <sup>e,g</sup>	--	3,900	5,400	820	6,600	<500	0.19	Operating
	11/21/2002	17.85	0.05	79.06		37,000 <sup>d,g</sup>	120,000 <sup>e,g</sup>	--	4,000	660	1,200	5,100	<1,700	0.28	Operating
	1/13/2003	11.43	Sheen <sup>Lab</sup>	85.44		21,000 <sup>d,g</sup>	6,300 <sup>e,f,g,k</sup>	--	2,400	2,300	390	3,000	<500	0.31	Not operating
	4/25/2003	18.30	--	78.57		12,000 <sup>d</sup>	1,200 <sup>e</sup>	--	1,800	850	150	1,200	<500	--	Operating
	5/30/2003	13.30	--	83.57		--	--	--	--	--	--	--	--	--	Not operating
	9/3/2003	21.65	--	75.22		8,100 <sup>d</sup>	3,300 <sup>e</sup>	--	220	170	66	560	<50	--	Operating
	12/2/2003	17.70	Sheen <sup>Lab</sup>	79.17		30,000 <sup>d,g</sup>	8,400 <sup>e,g</sup>	--	2,900	2,100	530	3,600	<500	--	Operating
	3/18/2004	16.49	--	80.38		15,000 <sup>d</sup>	2,300 <sup>e,f</sup>	--	2,600	990	260	1,700	<300	--	Operating
162.94	6/16/2004	15.40	--	147.54		23,000 <sup>d</sup>	8,800 <sup>e,f</sup>	--	2,100	1,300	360	2,800	<1,000	--	Operating

# Conestoga-Rovers & Associates

**Table 2. Groundwater Elevations and Analytical Data - Former Exxon Service Station, 3055 35th Avenue, Oakland, California**

Well ID	Date	TOC GW	SPH	GW	Note	TPHg	TPHd	TPHmo	Benzene	Toluene	Ethylbenzene	Xylenes	MTBE	DO	DPE System
TOC		Depth (ft)	(ft)	Elev. (ft)		Concentrations in micrograms per liter (µg/L)							(mg/L)	Status	
MW-3	9/27/2004	23.65	---	139.29		5,200 <sup>d</sup>	1,700 <sup>e,f</sup>	---	430	220	100	680	250	0.55	Operating
Continued	12/27/2004	14.58	Sheen <sup>Lab</sup>	148.36		32,000 <sup>d,g</sup>	24,000 <sup>e,f,g,k</sup>	---	4,400	2,800	650	4,800	<250	0.71	Not operating
	3/7/2005	6.91	Sheen <sup>Field &amp; Lab</sup>	156.03		50,000 <sup>d,g</sup>	14,000 <sup>e,f,g</sup>	---	6,100	2,100	1,300	7,400	<500	0.62	Not operating
	6/21/2005	10.79	Sheen <sup>Field &amp; Lab</sup>	152.15		44,000 <sup>d,g</sup>	12,000 <sup>e,g</sup>	---	4,900	870	1,100	6,500	<1,200	---	Not operating
	9/21/2005	15.73	Sheen <sup>Field &amp; Lab</sup>	147.21		41,000 <sup>d,g</sup>	16,000 <sup>e,f,k,g</sup>	---	3,700	480	930	5,700	<500	0.90	Not operating
	12/14/2005	13.65	Sheen <sup>Field &amp; Lab</sup>	149.29		53,000 <sup>d,g</sup>	19,000 <sup>e,f,k,g</sup>	---	4,700	350	1,100	7,400	<1,000	0.95	Not operating
	3/22/2006	8.10	Sheen <sup>Field &amp; Lab</sup>	154.84		45,000 <sup>d,g</sup>	15,000 <sup>e,f,k,g</sup>	---	4,300	390	1,100	5,300	<1,000	0.88	Not operating
	6/30/2006	14.10	Sheen <sup>Field &amp; Lab</sup>	148.84		44,000 <sup>d,g</sup>	15,000 <sup>e,f,k,g</sup>	---	4,000	160	550	4,000	<450	0.81	Not operating
	9/5/2006	16.25	Sheen <sup>Field &amp; Lab</sup>	146.69		56,000 <sup>d,g</sup>	16,000 <sup>e,f,k,g</sup>	---	5,400	300	1,200	6,200	<500	0.55	Not operating
	12/6/2006	15.25	Sheen <sup>Field &amp; Lab</sup>	147.69		44,000 <sup>d,g</sup>	19,000 <sup>e,f,k,g</sup>	---	4,500	110	930	3,600	<500	0.70	Not operating
	3/16/2007	10.25	Sheen <sup>Field &amp; Lab</sup>	152.69		72,000 <sup>d,g</sup>	5,300 <sup>e,f,k,g</sup>	---	6,500	420	1,200	3,900	<1,000	0.61	Not operating
	6/15/2007	14.57	Sheen <sup>Field &amp; Lab</sup>	148.37		56,000 <sup>d,g</sup>	25,000 <sup>e,k,f,g</sup>	---	5,100	200	1,100	3,200	<1000	0.48	Not operating
	9/6/2007	16.55	Sheen <sup>Field &amp; Lab</sup>	146.39		41,000 <sup>d,g</sup>	14,000 <sup>e,f,g</sup>	---	4,400	180	1,000	3,800	<700	0.70	Not operating
	12/8/2007	14.49	Sheen <sup>Field &amp; Lab</sup>	148.45		33,000 <sup>d,g</sup>	4,000 <sup>e,f,g</sup>	---	4,300	120	370	2,200	<250	0.77	Not operating
	3/9/2008	10.40	Sheen <sup>Field</sup>	152.54	Z	23,000 <sup>d</sup>	3,400 <sup>e</sup>	310	4,200	120	650	1,600	<250	0.71	Not operating
	6/14/2008	15.92	Sheen <sup>Field</sup>	147.02	Z	36,000 <sup>d</sup>	4,900 <sup>e</sup>	600	4,700	140	830	1,600	<500	1.05	Not operating
MW-4	3/20/1997	13.75	---	83.59		47,000	3,100	---	11,000	4,500	1,100	5,200	3,400	8.4	
97.34	6/25/1997	16.15	---	81.19		61,000	5,800 <sup>b</sup>	---	16,000	6,100	1,500	5,900	780 <sup>c</sup>	1.4	
	9/17/1997	17.10	---	80.24		60,000 <sup>d</sup>	4,400 <sup>e</sup>	---	17,000	4,900	1,500	5,700	<1,500	1.5	
	12/22/1997	9.21	---	88.13		43,000 <sup>d</sup>	3,100 <sup>e</sup>	---	13,000	3,900	1,100	4,200	<960	3.7	
	3/18/1998	9.54	---	87.80		58,000 <sup>d</sup>	5,500 <sup>e,f</sup>	---	14,000	4,700	1,400	5,700	<1,200	0.8	
	7/14/1998	14.15	---	83.19		73,000 <sup>d</sup>	2,900 <sup>e,f</sup>	---	22,000	7,000	1,800	7,300	<200	1.0	
	9/30/1998	16.84	---	80.50		39,000	2,100	---	12,000	2,700	1,000	3,400	510	1.1	
	12/8/1998	13.45	---	83.89		27,000	1,600	---	8,900	1,600	730	2,300	<1,500	---	
	3/29/1999	9.10	---	88.24		48,000 <sup>d</sup>	2,400 <sup>e,h</sup>	---	15,000	3,000	1,300	5,000	1,300	1.32	
	06/29/99*	---	---	---		---	---	---	---	---	---	---	---	---	
	9/28/1999	16.58	---	80.76		24,000 <sup>d</sup>	3,200 <sup>e,f</sup>	---	7,500	1,200	190	2,200	210	14.29 <sup>h</sup>	
	12/10/1999	13.99	---	83.35		47,000 <sup>d</sup>	3,100 <sup>e,f</sup>	---	12,000	1,800	1,000	4,400	<100	0.62	
	3/23/2000	10.22	---	87.12		40,000 <sup>d</sup>	3,100 <sup>e,f</sup>	---	11,000	1,600	910	3,100	690	---	
	9/7/2000	16.40	---	80.94		43,000 <sup>d</sup>	5,900 <sup>e</sup>	---	10,000	1,100	1,100	3,400	<450	1.04	
	12/5/2000	15.55	---	81.79		69,000 <sup>d,g</sup>	2,600 <sup>e,g</sup>	---	16,000	1,300	1,300	3,400	<200	0.35	Not operating
	3/20/2001	14.03	---	83.31		46,000	---	---	13,000	1,000	900	2,800	<350	0.39	Not operating
	6/6/2001	15.49	---	81.85		75,000	5,400	---	22,000	1,800	1,900	6,400	<1,200	2.22	Not operating
	8/30/2001	18.00	---	79.34		43,000 <sup>a</sup>	3,200 <sup>d</sup>	---	6,400	630	510	2,600	<200	0.32	Operating
	12/7/2001	23.45	---	73.89		32,000 <sup>d,g</sup>	11,000 <sup>e,f,g</sup>	---	4,500	740	310	2,300	<200	0.21	Operating
	3/11/2002	14.95	---	82.39		15,000 <sup>d</sup>	1,600 <sup>e,f,k</sup>	---	3,700	500	92	790	<500	0.30	Operating
	6/10/2002	22.30	---	75.04		9,400 <sup>d</sup>	3,400 <sup>e</sup>	---	1,400	50	<5.0	690	<200	---	Operating
9/26/2002	17.93	---	79.41		21,000 <sup>d</sup>	800 <sup>e</sup>	---	3,300	1,300	450	2,900	<500	0.24	Operating	
11/21/2002	17.55	---	79.79		5,700 <sup>d</sup>	2,400 <sup>e,k</sup>	---	1,400	290	63	640	550	---	Operating	

# Conestoga-Rovers & Associates

**Table 2. Groundwater Elevations and Analytical Data - Former Exxon Service Station, 3055 35th Avenue, Oakland, California**

Well ID	Date	TOC GW	SPH	GW	Note	TPHg	TPHd	TPHmo	Benzene	Toluene	Ethylbenzene	Xylenes	MTBE	DO	DPE System
TOC		Depth (ft)	(ft)	Elev. (ft)		Concentrations in micrograms per liter (µg/L)							(mg/L)	Status	
MW-4	1/13/2003	11.75	Sheen Lab	85.59		35,000 <sup>d,g</sup>	15,000 <sup>e,f,g,k</sup>	---	5,100	1,500	510	4,500	<800	0.28	Not operating
Continued	4/25/2003	19.37	---	77.97		6,600 <sup>d</sup>	2,200 <sup>e,f</sup>	---	960	130	100	560	<170	---	Operating
	5/30/2003	13.56	---	83.78		---	---	---	---	---	---	---	---	---	Not operating
	9/3/2003	21.65	---	75.69		29,000 <sup>d</sup>	27,000 <sup>e,f</sup>	---	2,200	380	280	2,300	65	---	Operating
	12/2/2003	19.17	---	78.17		13,000 <sup>d</sup>	5,800 <sup>e,f</sup>	---	1,300	180	120	1,900	<250	---	Operating
	3/18/2004	14.92	---	82.42		5,300 <sup>d</sup>	1,500 <sup>e</sup>	---	1,300	55	37	440	<180	---	Operating
163.49	6/16/2004	16.02	---	147.47		9,100 <sup>d</sup>	3,400 <sup>e,f</sup>	---	940	96	120	800	<50	---	Not operating
	9/27/2004	19.93	---	143.56		1,300 <sup>d</sup>	980 <sup>e,f,k</sup>	---	140	10	11	81	<50	0.68	Not operating
	12/27/2004	14.79	Sheen Lab	148.70		10,000 <sup>d,g</sup>	5,300 <sup>e,f,g,k</sup>	---	1,000	99	34	1,600	<50	0.74	Not operating
	3/7/2005	7.81	Sheen Field & Lab	155.68		15,000 <sup>d,g</sup>	9,300 <sup>e,f,g</sup>	---	1,100	140	88	1,900	<100	0.65	Not operating
	6/21/2005	11.82	Sheen Field & Lab	151.67		30,000 <sup>d,g</sup>	12,000 <sup>e,g</sup>	---	3,300	270	250	2,800	<500	---	Not operating
	9/21/2005	16.55	Sheen Field & Lab	146.94		12,000 <sup>d,g</sup>	15,000 <sup>e,f,k,g</sup>	---	540	100	54	1,800	<50	0.89	Not operating
	12/14/2005	14.43	Sheen Field & Lab	149.06		5,200 <sup>d,g</sup>	9,800 <sup>e,f,k,g</sup>	---	710	41	91	540	<50	0.91	Not operating
	3/22/2006	7.52	Sheen Field & Lab	155.97		17,000 <sup>d,g</sup>	9,300 <sup>e,f,k,g</sup>	---	2,000	230	150	1,900	<50	0.80	Not operating
	6/30/2006	15.00	Sheen Field & Lab	148.49		18,000 <sup>d,g</sup>	19,000 <sup>e,f,g</sup>	---	1,400	50	60	1,300	<100	0.85	Not operating
	9/5/2006	16.96	Sheen Field & Lab	146.53		30,000 <sup>d,g</sup>	9,400 <sup>e,f,k,g</sup>	---	1,400	180	110	4,300	<500	0.75	Not operating
	12/6/2006	15.95	Sheen Field & Lab	147.54		21,000 <sup>d,g</sup>	22,000 <sup>e,f,g</sup>	---	920	56	73	1,500	<100	0.71	Not operating
	3/16/2007	10.71	Sheen Field & Lab	152.78		13,000 <sup>d,g</sup>	2,700 <sup>e,f,k,g</sup>	---	1,400	32	93	740	<100	0.65	Not operating
	6/15/2007	15.43	Sheen Field & Lab	148.06		14,000 <sup>d,g</sup>	7,200 <sup>e,g</sup>	---	1,200	46	63	850	<110	0.61	Not operating
	9/6/2007	17.25	Sheen Field & Lab	146.24		27,000 <sup>d,g</sup>	8,400 <sup>e,f,k,g</sup>	---	1,500	150	120	4,500	<250	0.55	Not operating
	12/8/2007	15.15	Sheen Field & Lab	148.34		7,600 <sup>d,g</sup>	790 <sup>e,f,g</sup>	---	690	27	39	570	<80	0.72	Not operating
	3/9/2008	10.77	Sheen Field	152.72	Z	8,100 <sup>d</sup>	3,000 <sup>e</sup>	<250	830	7.7	55	310	<50	0.79	Not operating
	6/14/2008	16.68	Sheen Field	146.81	Z	15,000 <sup>d</sup>	4,200 <sup>e</sup>	<250	1,100	50.0	86	1,300	<150	1.20	Not operating
RW-5	1/13/2003	10.20	---	---		14,000	3,000	---	2,100	750	300	1,800	950	0.17	
162.34	3/18/2003	14.48	---	---		12,000	---	---	2,000	380	190	1,500	830	---	
	6/16/2004	14.73	---	147.61		---	---	---	---	---	---	---	---	---	Not operating
	9/27/2004	25.55	---	136.79		---	---	---	---	---	---	---	---	---	Operating
	12/27/2004	10.45	---	151.89		---	---	---	---	---	---	---	---	---	Not operating
	3/7/2005	4.42	Sheen Field	157.92		7,000 <sup>d</sup>	6,100 <sup>e,f,k</sup>	---	720	63	97	670	<400	0.93	Not operating
	6/21/2005	10.02	Sheen Field	152.32		11,000 <sup>d</sup>	490 <sup>e</sup>	---	1,200	67	68	690	<500	---	Not operating
	9/21/2005	15.07	Sheen Field & Lab	147.27		2,000 <sup>d,g</sup>	2,500 <sup>e,f,k,g</sup>	---	390	16	24	170	1,300	0.99	Not operating
	12/14/2005	12.95	Sheen Field & Lab	149.39		8,900 <sup>d,g</sup>	6,200 <sup>e,f,k,g</sup>	---	1,500	92	180	750	2,300	1.03	Not operating
	3/22/2006	2.55	Sheen Field	159.79		7,400 <sup>d</sup>	2,700 <sup>e,f,k</sup>	---	59	76	20	120	<50	1.10	Not operating
	6/30/2006	13.32	Sheen Field	149.02		3,100 <sup>d</sup>	3,100 <sup>e,f,k</sup>	---	590	15	27	88	410	0.89	Not operating
	9/5/2006	15.55	Sheen Field & Lab	146.79		5,300 <sup>d,g</sup>	3,200 <sup>e,f,k,g</sup>	---	1,000	31	61	230	370	0.81	Not operating
	12/6/2006	14.53	Sheen Field & Lab	147.81		8,500 <sup>d,g</sup>	5,500 <sup>e,f,g</sup>	---	1,200	24	91	250	<900	0.79	Not operating
	3/16/2007	8.81	Sheen Field & Lab	153.53		2,400 <sup>d,g</sup>	2,500 <sup>e,f,k,g</sup>	---	180	3.3	7.3	10	<17	0.62	Not operating
	6/15/2007	13.84	Sheen Field & Lab	148.50		3,700 <sup>d,g</sup>	2,000 <sup>e,k,f,g</sup>	---	730	14	36	80	<150	0.65	Not operating
	9/6/2007	15.85	Sheen Field	146.49		2,500 <sup>d</sup>	1,000 <sup>e,f</sup>	---	600	12	24	92	180	0.68	Not operating

# Conestoga-Rovers & Associates

**Table 2. Groundwater Elevations and Analytical Data - Former Exxon Service Station, 3055 35th Avenue, Oakland, California**

Well ID	Date	TOC GW	SPH	GW	Note	TPHg	TPHd	TPHmo	Benzene	Toluene	Ethylbenzene	Xylenes	MTBE	DO	DPE System
TOC		Depth (ft)	(ft)	Elev. (ft)		Concentrations in micrograms per liter (µg/L)								(mg/L)	Status
RW-5	12/8/2007	13.99	Sheen <sup>Field</sup>	148.35		1,900 <sup>d</sup>	370 <sup>c,f</sup>	---	220	4.0	10	38	500	0.74	Not operating
Continued	3/9/2008	8.77	Sheen <sup>Field</sup>	153.57	Z	1,100 <sup>d</sup>	90 <sup>e</sup>	<250	220	5.3	4.9	10	<90	0.92	Not operating
	6/14/2008	15.21	Sheen <sup>Field</sup>	147.13	Z	1,200 <sup>d</sup>	190 <sup>e</sup>	<250	310	5.8	3.5	25	<250	1.73	Not operating
RW-6	3/11/2002	--	--	--		14,000	3,100	---	970	520	170	2,200	<130	---	
162.36	1/13/2003	10.35	--	--		15,000	2,900	---	2,200	1,200	130	2,200	440	0.24	
	3/18/2004	11.47	--	--		8,500	---	---	1,300	260	71	990	1,300	--	Not operating
	6/16/2004	14.80	--	147.56		---	---	---	---	---	---	---	---	---	Not operating
	9/27/2004	18.46	--	143.90		---	---	---	---	---	---	---	---	---	Not operating
	12/27/2004	9.82	--	152.54		---	---	---	---	---	---	---	---	---	Not operating
	3/7/2005	6.05	--	156.31		---	---	---	---	---	---	---	---	---	Not operating
	6/21/2005	10.13	--	152.23		---	---	---	---	---	---	---	---	---	Not operating
	9/21/2005	15.13	--	147.23		---	---	---	---	---	---	---	---	---	Not operating
	12/14/2005	13.02	--	149.34		---	---	---	---	---	---	---	---	---	Not operating
	3/22/2006	5.85	--	156.51		---	---	---	---	---	---	---	---	---	Not operating
	6/30/2006	13.44	--	148.92		---	---	---	---	---	---	---	---	---	Not operating
	9/5/2006	15.63	--	146.73		---	---	---	---	---	---	---	---	---	Not operating
	12/6/2006	14.63	--	147.73		---	---	---	---	---	---	---	---	---	Not operating
	3/16/2007	8.89	--	153.47		---	---	---	---	---	---	---	---	---	Not operating
	6/15/2007	13.90	--	148.46		---	---	---	---	---	---	---	---	---	Not operating
	9/6/2007	15.92	--	146.44		---	---	---	---	---	---	---	---	---	Not operating
	12/8/2007	14.21	--	148.15		---	---	---	---	---	---	---	---	---	Not operating
	3/9/2008	8.93	--	153.43		---	---	---	---	---	---	---	---	---	Not operating
	6/14/2008	15.28	--	147.08		---	---	---	---	---	---	---	---	---	Not operating
	RW-7	3/11/2002	--	--	--		<50	<50	---	<0.5	<0.5	<0.5	<0.5	<5.0	---
162.72	1/13/2003	10.95	--	--		<50	67	---	<0.5	<0.5	<0.5	<0.5	<5.0	0.22	
	3/18/2004	15.33	--	--		250	---	---	66	4.8	3.2	10	<15	---	
	6/16/2004	15.22	--	147.50		---	---	---	---	---	---	---	---	---	Not operating
	9/27/2004	18.98	--	143.74		---	---	---	---	---	---	---	---	---	Not operating
	12/27/2004	9.85	--	152.87		---	---	---	---	---	---	---	---	---	Not operating
	3/7/2005	5.82	--	156.90		---	---	---	---	---	---	---	---	---	Not operating
	6/21/2005	10.85	--	151.87		---	---	---	---	---	---	---	---	---	Not operating
	9/21/2005	15.70	--	147.02		---	---	---	---	---	---	---	---	---	Not operating
	12/14/2005	13.58	--	149.14		---	---	---	---	---	---	---	---	---	Not operating
	3/22/2006	5.75	--	156.97		---	---	---	---	---	---	---	---	---	Not operating
	6/30/2006	14.05	--	148.67		---	---	---	---	---	---	---	---	---	Not operating
	9/5/2006	16.12	--	146.60		---	---	---	---	---	---	---	---	---	Not operating
	12/6/2006	15.13	--	147.59		---	---	---	---	---	---	---	---	---	Not operating
	3/16/2007	9.69	--	153.03		---	---	---	---	---	---	---	---	---	Not operating

# Conestoga-Rovers & Associates

**Table 2. Groundwater Elevations and Analytical Data - Former Exxon Service Station, 3055 35th Avenue, Oakland, California**

Well ID	Date	TOC GW Depth (ft)	SPH (ft)	GW Elev. (ft)	Note	TPHg	TPHd	TPHmo	Benzene	Toluene	Ethylbenzene	Xylenes	MTBE	DO (mg/L)	DPE System Status
RW-7	6/15/2007	14.54	--	148.18		--	--	--	--	--	--	--	--	--	Not operating
Continued	9/6/2007	16.42	--	146.30		--	--	--	--	--	--	--	--	--	Not operating
	12/8/2007	14.46	--	148.26		--	--	--	--	--	--	--	--	--	Not operating
	3/9/2008	9.69	--	153.03		--	--	--	--	--	--	--	--	--	Not operating
	6/14/2008	15.80	--	146.92		--	--	--	--	--	--	--	--	--	Not operating
RW-8	3/11/2002	--	--	--		1,300	80	--	620	11	15	14	<60	--	
164.13	1/13/2003	12.80	--	--		390	56	--	150	11	4.1	4.1	13	0.31	
	3/18/2004	15.34	--	--		760	--	--	310	9.9	11	16	<25	--	
	6/16/2004	16.41	--	147.72		--	--	--	--	--	--	--	--	--	Not operating
	9/27/2004	19.74	--	144.39		--	--	--	--	--	--	--	--	--	Not operating
	12/27/2004	12.32	--	151.81		--	--	--	--	--	--	--	--	--	Not operating
	3/7/2005	8.10	--	156.03		--	--	--	--	--	--	--	--	--	Not operating
	6/21/2005	12.15	--	151.98		--	--	--	--	--	--	--	--	--	Not operating
	9/21/2005	16.90	--	147.23		--	--	--	--	--	--	--	--	--	Not operating
	12/14/2005	14.80	--	149.33		--	--	--	--	--	--	--	--	--	Not operating
	3/22/2006	7.88	--	156.25		--	--	--	--	--	--	--	--	--	Not operating
	6/30/2006	15.31	--	148.82		--	--	--	--	--	--	--	--	--	Not operating
	9/5/2006	17.38	--	146.75		--	--	--	--	--	--	--	--	--	Not operating
	12/6/2006	16.37	--	147.76		--	--	--	--	--	--	--	--	--	Not operating
	3/16/2007	11.04	--	153.09		--	--	--	--	--	--	--	--	--	Not operating
	6/15/2007	15.81	--	148.32		--	--	--	--	--	--	--	--	--	Not operating
	9/6/2007	17.63	--	146.50		--	--	--	--	--	--	--	--	--	Not operating
	12/8/2007	15.60	--	148.53		--	--	--	--	--	--	--	--	--	Not operating
	3/9/2008	11.05	--	153.08		--	--	--	--	--	--	--	--	--	Not operating
	6/14/2008	17.07	--	147.06		--	--	--	--	--	--	--	--	--	Not operating
	RW-9	3/11/2002	--	--	--		12,000	880	--	3,400	230	78	1,300	<240	--
163.86	1/13/2003	11.85	--	--		23,000	2,000	--	7,700	610	310	310	<500	0.39	
	3/18/2004	13.69	--	--		2,300	--	--	770	32	15	200	<50	--	
	6/16/2004	16.03	--	147.83		--	--	--	--	--	--	--	--	--	Not operating
	9/27/2004	19.83	--	144.03		--	--	--	--	--	--	--	--	--	Not operating
	12/27/2004	24.88	--	138.98		--	--	--	--	--	--	--	--	--	Not operating
	3/7/2005	7.87	--	155.99		9,000 <sup>d</sup>	510 <sup>c</sup>	--	2,600	69	200	550	<500	0.91	Not operating
	6/21/2005	11.90	--	151.96		9,400 <sup>d</sup>	630 <sup>c</sup>	--	2,400	69	210	470	<350	--	Not operating
	9/21/2005	16.62	Sheen <sup>Lab</sup>	147.24		8,300 <sup>d,g</sup>	820 <sup>c,f,g</sup>	--	2,500	36	190	310	<170	1.04	Not operating
	12/14/2005	14.52	--	149.34		6,300 <sup>d</sup>	1,100 <sup>c,f</sup>	--	1,900	29	150	260	<50	0.98	Not operating
	3/22/2006	7.63	--	156.23		7,600 <sup>d</sup>	680 <sup>c</sup>	--	2,900	59	190	310	<200	0.95	Not operating
	6/30/2006	15.04	--	148.82		14,000 <sup>d</sup>	1,400 <sup>c</sup>	--	3,100	53	130	260	<300	0.73	Not operating
	9/5/2006	17.02	--	146.84		14,000 <sup>d</sup>	1,100 <sup>c</sup>	--	3,900	39	200	230	<330	0.69	Not operating



# Conestoga-Rovers & Associates

**Table 2. Groundwater Elevations and Analytical Data - Former Exxon Service Station, 3055 35th Avenue, Oakland, California**

Well ID	Date	TOC GW	SPH	GW	Note	TPHg	TPHd	TPHmo	Benzene	Toluene	Ethylbenzene	Xylenes	MTBE	DO	DPE System
TOC		Depth (ft)	(ft)	Elev. (ft)		Concentrations in micrograms per liter (µg/L)							(mg/L)	Status	
RW-9	12/6/2006	16.04	Sheen <sup>Lab</sup>	147.82		13,000 <sup>d,g</sup>	660 <sup>e,g</sup>	--	3,000	29	180	260	<250	0.74	Not operating
Continued	3/16/2007	10.83	Sheen <sup>Lab</sup>	153.03		16,000 <sup>d,g</sup>	1,200 <sup>e</sup>	--	3,700	76	230	340	<350	0.71	Not operating
	6/15/2007	15.48	--	148.38		12,000 <sup>d</sup>	670 <sup>e</sup>	--	3,000	44	170	220	<250	0.68	Not operating
	9/6/2007	17.29	Sheen <sup>Field &amp; Lab</sup>	146.57		13,000 <sup>d,g</sup>	2,200 <sup>e,f,g</sup>	--	2,700	61	240	350	<400	0.66	Not operating
	12/8/2007	15.22	Sheen <sup>Field</sup>	148.64		9,300 <sup>d</sup>	1,000 <sup>e,f</sup>	--	2,900	24	150	170	<250	0.89	Not operating
	3/9/2008	10.86	--	153.00	Z	10,000 <sup>d</sup>	570 <sup>e</sup>	<250	4,200	71	180	380	<35	0.86	Not operating
	6/14/2008	16.71	--	147.15	Z	8,100 <sup>d</sup>	610	<250	2,800	33	100	220	<210	1.29	Not operating
RW-10	3/11/2002	--	--	--		12,000	740	--	3,900	150	110	1,100	<270	--	
163.02	1/13/2003	10.75	--	--		4,300	330	--	1,500	43	98	98	<100	0.41	
	3/18/2004	13.13	--	--		5,800	--	--	2,400	11	<10	110	<300	--	
	6/16/2004	15.03	--	147.99		--	--	--	--	--	--	--	--	--	Not operating
	9/27/2004	18.35	--	144.67		--	--	--	--	--	--	--	--	--	Not operating
	12/27/2004	19.39	--	143.63		--	--	--	--	--	--	--	--	--	Not operating
	3/7/2005	6.40	--	156.62		--	--	--	--	--	--	--	--	--	Not operating
	6/21/2005	10.95	--	152.07		--	--	--	--	--	--	--	--	--	Not operating
	9/21/2005	15.51	--	147.51		--	--	--	--	--	--	--	--	--	Not operating
	12/14/2005	13.37	--	149.65		--	--	--	--	--	--	--	--	--	Not operating
	3/22/2006	6.53	--	156.49		--	--	--	--	--	--	--	--	--	Not operating
	6/30/2006	14.13	--	148.89		--	--	--	--	--	--	--	--	--	Not operating
	9/5/2006	15.98	--	147.04		--	--	--	--	--	--	--	--	--	Not operating
	12/6/2006	15.02	--	148.00		--	--	--	--	--	--	--	--	--	Not operating
	3/16/2007	9.91	--	153.11		--	--	--	--	--	--	--	--	--	Not operating
	6/15/2007	14.52	--	148.50		--	--	--	--	--	--	--	--	--	Not operating
	9/6/2007	16.23	--	146.79		--	--	--	--	--	--	--	--	--	Not operating
	12/8/2007	14.23	--	148.79		--	--	--	--	--	--	--	--	--	Not operating
	3/9/2008	9.96	--	153.06		--	--	--	--	--	--	--	--	--	Not operating
	6/14/2008	15.64	--	147.38		--	--	--	--	--	--	--	--	--	Not operating
RW-11	3/11/2002	--	--	--		260	<50	--	34	5.3	8.1	48	<5.0	--	
162.57	1/13/2003	9.80	--	--		5,300	2,700	--	490	110	120	120	180	0.24	
	3/18/2004	12.45	--	--		9,300	--	--	980	120	180	770	2,000	--	
	6/16/2004	14.75	--	147.82		--	--	--	--	--	--	--	--	--	Not operating
	9/27/2004	18.44	--	144.13		--	--	--	--	--	--	--	--	--	Not operating
	12/27/2004	10.07	--	152.50		--	--	--	--	--	--	--	--	--	Not operating
	3/7/2005	5.95	--	156.62		--	--	--	--	--	--	--	--	--	Not operating
	6/21/2005	9.96	--	152.61		--	--	--	--	--	--	--	--	--	Not operating
	9/21/2005	15.09	--	147.48		--	--	--	--	--	--	--	--	--	Not operating
	12/14/2005	12.96	--	149.61		--	--	--	--	--	--	--	--	--	Not operating
	3/22/2006	5.70	--	156.87		--	--	--	--	--	--	--	--	--	Not operating

# Conestoga-Rovers & Associates

**Table 2. Groundwater Elevations and Analytical Data - Former Exxon Service Station, 3055 35th Avenue, Oakland, California**

Well ID	Date	TOC GW	SPH	GW	Note	TPHg	TPHd	TPHmo	Benzene	Toluene	Ethylbenzene	Xylenes	MTBE	DO	DPE System
TOC		Depth (ft)	(ft)	Elev. (ft)		Concentrations in micrograms per liter (µg/L)							(mg/L)	Status	
<i>RW-11</i>	6/30/2006	13.36	--	149.21		--	--	--	--	--	--	--	--	--	Not operating
<i>Continued</i>	9/5/2006	15.56	--	147.01		--	--	--	--	--	--	--	--	--	Not operating
	12/6/2006	14.55	--	148.02		--	--	--	--	--	--	--	--	--	Not operating
	3/16/2007	8.85	--	153.72		--	--	--	--	--	--	--	--	--	Not operating
	6/15/2007	13.90	--	148.67		--	--	--	--	--	--	--	--	--	Not operating
	9/6/2007	15.84	--	146.73		--	--	--	--	--	--	--	--	--	Not operating
	12/8/2007	13.83	--	148.74		--	--	--	--	--	--	--	--	--	Not operating
	3/9/2008	8.81	--	153.76		--	--	--	--	--	--	--	--	--	Not operating
	6/14/2008	15.26	--	147.31		--	--	--	--	--	--	--	--	--	Not operating
RW-12	3/11/2002	--	--	--		13,000	900	--	4,500	130	130	270	<5.0	--	
<i>163.06</i>	1/13/2003	10.90	--	--		4,100	1,800	--	1,000	130	99	99	<100	0.21	
	3/18/2004	13.63	--	--		17,000	--	--	2,700	960	230	1,500	1,400	--	
	6/16/2004	15.30	--	147.76		--	--	--	--	--	--	--	--	--	Not operating
	9/27/2004	19.09	--	143.97		--	--	--	--	--	--	--	--	--	Not operating
	12/27/2004	10.85	--	152.21		--	--	--	--	--	--	--	--	--	Not operating
	3/7/2005	6.59	--	156.47		--	--	--	--	--	--	--	--	--	Not operating
	6/21/2005	10.58	--	152.48		--	--	--	--	--	--	--	--	--	Not operating
	9/21/2005	15.63	--	147.43		--	--	--	--	--	--	--	--	--	Not operating
	12/14/2005	13.43	--	149.63		--	--	--	--	--	--	--	--	--	Not operating
	3/22/2006	6.35	--	156.71		--	--	--	--	--	--	--	--	--	Not operating
	6/30/2006	13.95	--	149.11		--	--	--	--	--	--	--	--	--	Not operating
	9/5/2006	16.11	--	146.95		--	--	--	--	--	--	--	--	--	Not operating
	12/6/2006	15.11	--	147.95		--	--	--	--	--	--	--	--	--	Not operating
	3/16/2007	9.52	--	153.54		--	--	--	--	--	--	--	--	--	Not operating
	6/15/2007	14.44	--	148.62		--	--	--	--	--	--	--	--	--	Not operating
	9/6/2007	16.42	--	146.64		--	--	--	--	--	--	--	--	--	Not operating
	12/8/2007	14.87	--	148.19		--	--	--	--	--	--	--	--	--	Not operating
	3/9/2008	9.43	--	153.63		--	--	--	--	--	--	--	--	--	Not operating
	6/14/2008	15.74	--	147.32		--	--	--	--	--	--	--	--	--	Not operating
RW-13	3/11/2002	--	--	--		830	79	--	190	13	13	34	<5.0	--	
<i>164.34</i>	1/13/2003	11.20	--	--		210	92	--	54	2.0	2.7	2.7	<5.0	0.35	
	3/18/2004	13.45	--	--		150	--	--	47	1.0	2.1	1.5	<5.0	--	
	6/16/2004	15.83	--	148.51		--	--	--	--	--	--	--	--	--	Not operating
	9/27/2004	19.55	--	144.79		--	--	--	--	--	--	--	--	--	Not operating
	12/27/2004	18.12	--	146.22		--	--	--	--	--	--	--	--	--	Not operating
	3/7/2005	6.90	--	157.44		--	--	--	--	--	--	--	--	--	Not operating
	6/21/2005	11.05	--	153.29		--	--	--	--	--	--	--	--	--	Not operating
	9/21/2005	16.20	--	148.14		--	--	--	--	--	--	--	--	--	Not operating

# Conestoga-Rovers & Associates

**Table 2. Groundwater Elevations and Analytical Data - Former Exxon Service Station, 3055 35th Avenue, Oakland, California**

Well ID	Date	TOC GW	SPH	GW	Note	TPHg	TPHd	TPHmo	Benzene	Toluene	Ethylbenzene	Xylenes	MTBE	DO	DPE System
TOC		Depth (ft)	(ft)	Elev. (ft)		Concentrations in micrograms per liter (µg/L)								(mg/L)	Status
<i>RW-13</i>	12/14/2005	14.11	--	150.23		--	--	--	--	--	--	--	--	--	Not operating
<i>Continued</i>	3/22/2006	6.65	--	157.69		--	--	--	--	--	--	--	--	--	Not operating
	6/30/2006	14.44	--	149.90		--	--	--	--	--	--	--	--	--	Not operating
	9/5/2006	16.62	--	147.72		--	--	--	--	--	--	--	--	--	Not operating
	12/6/2006	15.70	--	148.64		--	--	--	--	--	--	--	--	--	Not operating
	3/16/2007	9.93	--	154.41		--	--	--	--	--	--	--	--	--	Not operating
	6/15/2007	14.98	--	149.36		--	--	--	--	--	--	--	--	--	Not operating
	9/6/2007	16.95	--	147.39		--	--	--	--	--	--	--	--	--	Not operating
	12/8/2007	14.97	--	149.37		--	--	--	--	--	--	--	--	--	Not operating
	3/9/2008	9.85	--	154.49		--	--	--	--	--	--	--	--	--	Not operating
	6/14/2008	16.32	--	148.02		--	--	--	--	--	--	--	--	--	Not operating
<i>RW-14</i>	3/11/2002	--	--	--		270	82	--	44	0.99	<0.5	4.2	<5.0	--	
<i>163.76</i>	1/13/2003	11.00	--	--		3700	6800	--	230	77	91	91	<50	0.38	
	3/18/2004	12.81	--	--		220	--	--	42	1.4	0.99	5.2	<5.0	--	
	6/16/2004	15.41	--	148.35		--	--	--	--	--	--	--	--	--	Not operating
	9/27/2004	19.20	--	144.56		--	--	--	--	--	--	--	--	--	Not operating
	12/27/2004	12.62	--	151.14		--	--	--	--	--	--	--	--	--	Not operating
	3/7/2005	6.61	--	157.15		--	--	--	--	--	--	--	--	--	Not operating
	6/21/2005	10.80	--	152.96		--	--	--	--	--	--	--	--	--	Not operating
	9/21/2005	15.82	--	147.94		--	--	--	--	--	--	--	--	--	Not operating
	12/14/2005	13.73	--	150.03		--	--	--	--	--	--	--	--	--	Not operating
	3/22/2006	6.43	--	157.33		--	--	--	--	--	--	--	--	--	Not operating
	6/30/2006	14.10	--	149.66		--	--	--	--	--	--	--	--	--	Not operating
	9/5/2006	16.21	--	147.55		--	--	--	--	--	--	--	--	--	Not operating
	12/6/2006	15.31	--	148.45		--	--	--	--	--	--	--	--	--	Not operating
	3/16/2007	9.66	--	154.10		--	--	--	--	--	--	--	--	--	Not operating
	6/15/2007	14.61	--	149.15		--	--	--	--	--	--	--	--	--	Not operating
	9/6/2007	16.54	--	147.22		--	--	--	--	--	--	--	--	--	Not operating
	12/8/2007	14.57	--	149.19		--	--	--	--	--	--	--	--	--	Not operating
	3/9/2008	9.60	--	154.16		--	--	--	--	--	--	--	--	--	Not operating
	06/14/08	15.90	--	147.86		--	--	--	--	--	--	--	--	--	Not operating

# Conestoga-Rovers & Associates

**Table 2. Groundwater Elevations and Analytical Data - Former Exxon Service Station, 3055 35th Avenue, Oakland, California**

Well ID	Date	TOC GW	SPH	GW	Note	TPHg	TPHd	TPHmo	Benzene	Toluene	Ethylbenzene	Xylenes	MTBE	DO	DPE System
TOC		Depth (ft)	(ft)	Elev. (ft)		Concentrations in micrograms per liter (µg/L)								(mg/L)	Status

**Methods and Abbreviations:**

TOC = Top of casing elevation measured in feet relative to surveyor's datum.  
 All site wells were re-surveyed by Virgil Chavez Land Surveying on June 2, 2004 to the CA State Coordinate System, Zone III (NAD83). Benchmark elevation = 177.397 feet (NGVD 29).  
 TOC GW Depth = Groundwater depth measured in feet below TOC.  
 GW Elev. = Groundwater elevation measured in feet above mean sea level.  
 ft = Measured in feet  
 SPH = Separate-phase hydrocarbons depth measured from TOC.  
 Z = Laboratory used Gravity Separation of Groundwater Samples to Isolate the Water Phase Protocol (Zemo)  
 TPHg = Total petroleum hydrocarbons as gasoline by modified EPA Method SW8015C  
 TPHd = Total petroleum hydrocarbons as diesel by modified EPA Method SW8015C  
 TPHmo = Total petroleum hydrocarbons as motor oil by modified EPA Method SW8015C  
 Benzene, Toluene, Ethylbenzene, and Xylenes by EPA Method SW8021B  
 MTBE = Methyl tertiary-butyl ether by EPA Method SW8021B  
 DO = Dissolved oxygen  
 µg/L = Micrograms per liter, equivalent to parts per billion in water  
 mg/L = Milligrams per liter, equivalent to parts per million in water  
 DPE = Dual-phase extraction remediation  
 Sheen = A sheen was observed on the water's surface.  
 Field = Observed in field  
 Lab = Observed in analytical laboratory

**Notes:**

a = Result has an atypical pattern for diesel analysis  
 b = Result appears to be a lighter hydrocarbon than diesel  
 c = There is a >40% difference between primary and confirmation analysis  
 d = Unmodified or weakly modified gasoline is significant  
 e = Gasoline range compounds are significant  
 f = Diesel range compounds are significant; no recognizable pattern  
 g = Lighter than water immiscible sheen/product is present  
 h = One to a few isolated peaks present  
 i = Medium boiling point pattern does not match diesel (stoddard solvent)  
 j = Aged diesel is significant  
 k = Oil range compounds are significant  
 l = Liquid sample that contains greater than ~1 vol. % sediment  
 m = Stoddard solvent/mineral spirit  
  
 \* = Well inaccessible during site visit  
 \*\* = No water in well due to system operating in well, value reflects total well depth.  
 # = abnormally high reading due to added hydrogen peroxide  
 — = Not sampled; not analyzed ; not applicable; or no SPH measured or observed



**CONESTOGA-ROVERS  
& ASSOCIATES**

**APPENDIX A  
Field Data Sheet**



## WELL GAUGING SHEET

<b>Client:</b> Conestoga-Rovers and Associates						
<b>Site</b> <b>Address:</b> 3055 35th Avenue, Oakland, CA						
<b>Date:</b> 6/14/2008			<b>Signature:</b> 			
Well ID	Time	Depth to SPH	Depth to Water	SPH Thickness	Depth to Bottom	Comments
MW-1	8:25		18.98		27.35	
MW-2	9:10		18.66		27.60	
MW-3	8:45		15.92		25.09	
MW-4	8:30		16.68		30.30	
RW-5	8:55		15.21		25.65	
RW-6	8:50		15.28		25.35	
RW-7	8:40		15.80		29.20	
RW-8	8:35		17.07		29.00	
RW-9	8:20		16.71		25.20	
RW-10	8:15		15.64		24.95	
RW-11	9:00		15.26		24.95	





## WELL SAMPLING FORM

<b>Date:</b>		6/14/2008				
<b>Client:</b>		Conestoga-Rovers and Associates				
<b>Site Address:</b>		3055 35th Avenue, Oakland, CA				
<b>Well ID:</b>		MW-1				
<b>Well Diameter:</b>		4"				
<b>Purging Device:</b>		3" PVC Bailer				
<b>Sampling Method:</b>		Disposable Bailer				
<b>Total Well Depth:</b>		27.35	<b>Fe=</b> mg/L			
<b>Depth to Water:</b>		18.98	<b>ORP=</b> mV			
<b>Water Column Height:</b>		8.37	<b>DO=</b> 1.95 mg/L			
<b>Gallons/ft:</b>		0.65				
<b>1 Casing Volume (gal):</b>		5.44	<b>COMMENTS:</b> slow recharge			
<b>3 Casing Volumes (gal):</b>		16.32				
<b>TIME:</b>	<b>CASING VOLUME (gal)</b>	<b>TEMP (Celsius)</b>			<b>pH</b>	<b>COND. (µS)</b>
10:35	5.4	19.9			6.75	1406
11:05	10.9	19.1			6.68	1381
11:50	16.3	19.7	6.72	1354		
<b>Sample ID:</b>	<b>Sample Date:</b>	<b>Sample Time:</b>	<b>Container Type</b>	<b>Preservative</b>	<b>Analytes</b>	<b>Method</b>
MW-1	6/14/2008	5:40	40 ml VOA, 1 L Amber	HCl, ICE	TPHg BTEX MTBE TPHd	8015 with silica gel clean up, 8021 (Zemo)
				<b>Signature:</b>		





## WELL SAMPLING FORM

<b>Date:</b>		6/14/2008				
<b>Client:</b>		Conestoga-Rovers and Associates				
<b>Site Address:</b>		3055 35th Avenue, Oakland, CA				
<b>Well ID:</b>		MW-2				
<b>Well Diameter:</b>		4"				
<b>Purging Device:</b>		3" PVC Bailer				
<b>Sampling Method:</b>		Disposable Bailer				
<b>Total Well Depth:</b>		27.60	<b>Fe=</b>	mg/L		
<b>Depth to Water:</b>		18.66	<b>ORP=</b>	mV		
<b>Water Column Height:</b>		8.94	<b>DO=</b>	0.97 mg/L		
<b>Gallons/ft:</b>		0.65				
<b>1 Casing Volume (gal):</b>		5.81	<b>COMMENTS:</b> slow recharge, very turbid, silty, heavy sheen			
<b>3 Casing Volumes (gal):</b>		17.43				
<b>TIME:</b>	<b>CASING VOLUME (gal)</b>	<b>TEMP (Celsius)</b>			<b>pH</b>	<b>COND. (µS)</b>
4:00	5.8	20.6			6.75	894
4:40	11.6	20.5			6.77	846
5:15	17.4	20.5	6.81	859		
<b>Sample ID:</b>	<b>Sample Date:</b>	<b>Sample Time:</b>	<b>Container Type</b>	<b>Preservative</b>	<b>Analytes</b>	<b>Method</b>
MW-2	6/14/2008	6:20	40 ml VOA, 1 L Amber	HCl, ICE	TPHg BTEX MTBE TPHd	8015 with silica gel clean up, 8021 (Zemo)
				<b>Signature:</b>		



## WELL SAMPLING FORM

<b>Date:</b>		6/14/2008				
<b>Client:</b>		Conestoga-Rovers and Associates				
<b>Site Address:</b>		3055 35th Avenue, Oakland, CA				
<b>Well ID:</b>		MW-3				
<b>Well Diameter:</b>		2"				
<b>Purging Device:</b>		Disposable Bailer				
<b>Sampling Method:</b>		Disposable Bailer				
<b>Total Well Depth:</b>		25.09	<b>Fe=</b>	mg/L		
<b>Depth to Water:</b>		15.92	<b>ORP=</b>	mV		
<b>Water Column Height:</b>		9.17	<b>DO=</b>	1.05 mg/L		
<b>Gallons/ft:</b>		0.16				
<b>1 Casing Volume (gal):</b>		1.47	<b>COMMENTS:</b> slow recharge, very silty, heavy sheen			
<b>3 Casing Volumes (gal):</b>		4.40				
<b>TIME:</b>	<b>CASING VOLUME (gal)</b>	<b>TEMP (Celsius)</b>			<b>pH</b>	<b>COND. (µS)</b>
2:25	1.5	20.2			6.59	1520
2:55	2.9	19.9	6.64	1493		
3:45	4.4	20.5	6.61	1478		
<b>Sample ID:</b>	<b>Sample Date:</b>	<b>Sample Time:</b>	<b>Container Type</b>	<b>Preservative</b>	<b>Analytes</b>	<b>Method</b>
MW-3	6/14/2008	6:10	40 ml VOA, 1 L Amber	HCl, ICE	TPHg BTEX MTBE TPHd	8015 with silica gel clean up, 8021 (Zemo)
<b>Signature:</b>						



## WELL SAMPLING FORM

<b>Date:</b>		6/14/2008				
<b>Client:</b>		Conestoga-Rovers and Associates				
<b>Site Address:</b>		3055 35th Avenue, Oakland, CA				
<b>Well ID:</b>		MW-4				
<b>Well Diameter:</b>		2"				
<b>Purging Device:</b>		Disposable Bailer				
<b>Sampling Method:</b>		Disposable Bailer				
<b>Total Well Depth:</b>		30.30	<b>Fe=</b> mg/L			
<b>Depth to Water:</b>		16.68	<b>ORP=</b> mV			
<b>Water Column Height:</b>		13.62	<b>DO=</b> 1.20 mg/L			
<b>Gallons/ft:</b>		0.16				
<b>1 Casing Volume (gal):</b>		2.18	<b>COMMENTS:</b> very turbid, very silty, heavy sheen			
<b>3 Casing Volumes (gal):</b>		6.54				
<b>TIME:</b>	<b>CASING VOLUME (gal)</b>	<b>TEMP (Celsius)</b>			<b>pH</b>	<b>COND. (µS)</b>
1:50	2.2	19.9	6.49	879		
1:55	4.4	20.3	6.55	912		
2:00	6.5	20.6	6.58	905		
<b>Sample ID:</b>	<b>Sample Date:</b>	<b>Sample Time:</b>	<b>Container Type</b>	<b>Preservative</b>	<b>Analytes</b>	<b>Method</b>
MW-4	6/14/2008	6:00	40 ml VOA, 1 L Amber	HCL, ICE	TPHg BTEX MTBE TPHd	8015 with silica gel clean up, 8021 (Zemo)
				<b>Signature:</b>		



## WELL SAMPLING FORM

<b>Date:</b>		6/14/2008				
<b>Client:</b>		Conestoga-Rovers and Associates				
<b>Site Address:</b>		3055 35th Avenue, Oakland, CA				
<b>Well ID:</b>		RW-5				
<b>Well Diameter:</b>		4"				
<b>Purging Device:</b>		3" PVC Bailer				
<b>Sampling Method:</b>		Disposable Bailer				
<b>Total Well Depth:</b>		25.65	<b>Fe=</b> mg/L			
<b>Depth to Water:</b>		15.21	<b>ORP=</b> mV			
<b>Water Column Height:</b>		10.44	<b>DO=</b> 1.73 mg/L			
<b>Gallons/ft:</b>		0.65				
<b>1 Casing Volume (gal):</b>		6.79	<b>COMMENTS:</b> slow recharge, very turbid, heavy sheen			
<b>3 Casing Volumes (gal):</b>		20.36				
<b>TIME:</b>	<b>CASING VOLUME (gal)</b>	<b>TEMP (Celsius)</b>			<b>pH</b>	<b>COND. (µS)</b>
12:10	6.8	18.9			6.82	743
12:40	13.6	19.0			6.90	729
1:30	20.4	19.8	6.87	736		
<b>Sample ID:</b>	<b>Sample Date:</b>	<b>Sample Time:</b>	<b>Container Type</b>	<b>Preservative</b>	<b>Analytes</b>	<b>Method</b>
RW-5	6/14/2008	5:50	40 ml VOA, 1 L Amber	HCl, ICE	TPHg BTEX MTBE TPHd	8015 with silica gel clean up, 8021 (Zemo)
				<b>Signature:</b>		



## WELL SAMPLING FORM

<b>Date:</b>		6/14/2008				
<b>Client:</b>		Conestoga-Rovers and Associates				
<b>Site Address:</b>		3055 35th Avenue, Oakland, CA				
<b>Well ID:</b>		RW-9				
<b>Well Diameter:</b>		4"				
<b>Purging Device:</b>		3" PVC Bailer				
<b>Sampling Method:</b>		Disposable Bailer				
<b>Total Well Depth:</b>		25.20	<b>Fe=</b> mg/L			
<b>Depth to Water:</b>		16.71	<b>ORP=</b> mV			
<b>Water Column Height:</b>		8.49	<b>DO=</b> 1.29 mg/L			
<b>Gallons/ft:</b>		0.65				
<b>1 Casing Volume (gal):</b>		5.52	<b>COMMENTS:</b> slow recharge			
<b>3 Casing Volumes (gal):</b>		16.56				
<b>TIME:</b>	<b>CASING VOLUME (gal)</b>	<b>TEMP (Celsius)</b>			<b>pH</b>	<b>COND. (µS)</b>
9:30	5.5	19.8			6.75	1254
9:55	11.0	19.9			6.71	1259
10:20	16.6	20.2	6.72	1250		
<b>Sample ID:</b>	<b>Sample Date:</b>	<b>Sample Time:</b>	<b>Container Type</b>	<b>Preservative</b>	<b>Analytes</b>	<b>Method</b>
RW-9	6/14/2008	5:30	40 ml VOA, 1 L Amber	HCl, ICE	TPHg BTEX MTBE TPHd	8015 with silica gel clean up, 8021 (Zemo)
				<b>Signature:</b>		



**CONESTOGA-ROVERS  
& ASSOCIATES**

**APPENDIX B**  
**Laboratory Analytical Report**



**McC Campbell Analytical, Inc.**

"When Quality Counts"

1534 Willow Pass Road, Pittsburg, CA 94565-1701  
Web: www.mccampbell.com E-mail: main@mccampbell.com  
Telephone: 877-252-9262 Fax: 925-252-9269

Conestoga-Rovers & Associates  5900 Hollis St, Suite A  Emeryville, CA 94608	Client Project ID: #130105; Golden Empire Property	Date Sampled: 06/14/08
		Date Received: 06/16/08
	Client Contact: Mark Jonas	Date Reported: 06/23/08
	Client P.O.:	Date Completed: 06/23/08

**WorkOrder: 0806437**

June 23, 2008

Dear Mark:

Enclosed within are:

- 1) The results of the 6 analyzed samples from your project: **#130105; Golden Empire Property**,
- 2) A QC report for the above samples,
- 3) A copy of the chain of custody, and
- 4) An invoice for analytical services.

All analyses were completed satisfactorily and all QC samples were found to be within our control limits.

If you have any questions or concerns, please feel free to give me a call. Thank you for choosing

McC Campbell Analytical Laboratories for your analytical needs.

Best regards,

Angela Rydelius  
Laboratory Manager  
McC Campbell Analytical, Inc.

# McC Campbell Analytical, Inc.



1534 Willow Pass Rd  
Pittsburg, CA 94565-1701  
(925) 252-9262

# CHAIN-OF-CUSTODY RECORD

WorkOrder: 0806437

ClientCode: CETE

WriteOn   
  EDF   
  Excel   
  Fax   
  Email   
  HardCopy   
  ThirdParty   
  J-flag

**Report to:**

Mark Jonas  
Conestoga-Rovers & Associates  
5900 Hollis St, Suite A  
Emeryville, CA 94608  
(510) 420-0700    FAX (510) 420-9170

Email: mjonas@CRAworld.com  
cc:  
PO:  
ProjectNo: #130105; Golden Empire Property

**Bill to:**

Accounts Payable  
Conestoga-Rovers & Associates  
5900 Hollis St, Ste. A  
Emeryville, CA 94608

Requested TAT: 5 days

Date Received: 06/16/2008

Date Printed: 06/16/2008

Lab ID	Client ID	Matrix	Collection Date	Hold	Requested Tests (See legend below)												
					1	2	3	4	5	6	7	8	9	10	11	12	
0806437-001	MW-1	Water	6/14/2008 5:40	<input type="checkbox"/>	A	A	B										
0806437-002	MW-2	Water	6/14/2008 6:20	<input type="checkbox"/>	A		B										
0806437-003	MW-3	Water	6/14/2008 6:10	<input type="checkbox"/>	A		B										
0806437-004	MW-4	Water	6/14/2008 6:00	<input type="checkbox"/>	A		B										
0806437-005	RW-5	Water	6/14/2008 5:50	<input type="checkbox"/>	A		B										
0806437-006	RW-9	Water	6/14/2008 5:30	<input type="checkbox"/>	A		B										

**Test Legend:**

1	G-MBTX-DZ_W	2	PREDF REPORT	3	TPH(DMO)-DZ-MAIWSG_W	4		5	
6		7		8		9		10	
11		12							

Prepared by: Melissa Valles

**Comments:**

NOTE: Soil samples are discarded 60 days after results are reported unless other arrangements are made (Water samples are 30 days).  
Hazardous samples will be returned to client or disposed of at client expense.





**Sample Receipt Checklist**

Client Name: **Conestoga-Rovers & Associates**

Date and Time Received: **6/16/08 4:10:23 PM**

Project Name: **#130105; Golden Empire Property**

Checklist completed and reviewed by: **Melissa Valles**

WorkOrder N°: **0806437** Matrix Water

Carrier: Client Drop-In

**Chain of Custody (COC) Information**

- Chain of custody present? Yes  No
- Chain of custody signed when relinquished and received? Yes  No
- Chain of custody agrees with sample labels? Yes  No
- Sample IDs noted by Client on COC? Yes  No
- Date and Time of collection noted by Client on COC? Yes  No
- Sampler's name noted on COC? Yes  No

**Sample Receipt Information**

- Custody seals intact on shipping container/cooler? Yes  No  NA
- Shipping container/cooler in good condition? Yes  No
- Samples in proper containers/bottles? Yes  No
- Sample containers intact? Yes  No
- Sufficient sample volume for indicated test? Yes  No

**Sample Preservation and Hold Time (HT) Information**

- All samples received within holding time? Yes  No
- Container/Temp Blank temperature Cooler Temp: 3.6°C NA
- Water - VOA vials have zero headspace / no bubbles? Yes  No  No VOA vials submitted
- Sample labels checked for correct preservation? Yes  No
- TTLIC Metal - pH acceptable upon receipt (pH<2)? Yes  No  NA

\* NOTE: If the "No" box is checked, see comments below.



Client contacted:

Date contacted:

Contacted by:

Comments:



# McCAMPBELL ANALYTICAL, INC.

1534 WILLOW PASS ROAD  
PITTSBURG, CA 94565-1701

Website: [www.mccampbell.com](http://www.mccampbell.com) Email: [main@mccampbell.com](mailto:main@mccampbell.com)  
Telephone: (877) 252-9262 Fax: (925) 252-9269

## CHAIN OF CUSTODY RECORD

TURN AROUND TIME

RUSH 24 HR 48 HR 72 HR 5 DAY

GeoTracker EDF  PDF  Excel  Write On (DW)

Check if sample is effluent and "J" flag is required

Report To: Mark Jonas Bill To: Conestoga Rivers & Associates

Company: Conestoga Rivers & Associates

5900 Holtis St, Ste A  
Emeryville, CA

Tele: (510) 420-3307

E-Mail: mjonas@erworld.com

Fax: (510) 420-9170

Project #: 130105

Project Name: Golden Empire Project

Project Location: 3055 35th Ave., Oakland, CA

Sampler Signature: Muskan Environmental Sampling

### Analysis Request

Other

Comments

- BTX & TPH as Gas (602 / 8021 / 8015) / MTBE
- TPH as Diesel (8015) with silico gel cleanup
- Total Petroleum Oil & Grease (1664 / 5520 E/B&F)
- Total Petroleum Hydrocarbons (418.1)
- EPA 502.2 / 601 / 8010 / 8021 (HYOCs)
- MTBE / BTEX ONLY (EPA 602 / 8021)
- EPA 505 / 608 / 8081 (CI Pesticides)
- EPA 608 / 8082 PCB's ONLY; Aroclors / Congeners
- EPA 507 / 8141 (NP Pesticides)
- EPA 515 / 8151 (Acidic CI Herbicides)
- EPA 524.2 / 624 / 8260 (VOCs)
- EPA 525.2 / 625 / 8270 (SVOCs)
- EPA 8270 SIM / 8310 (PAHs / PNAs)
- CAM 17 Metals (200.7 / 200.8 / 6010 / 6020)
- LUFT 5 Metals (200.7 / 200.8 / 6010 / 6020)
- Lead (200.7 / 200.8 / 6010 / 6020)

Pre-analysis ground water separation preserved (Zemo)

Filter Samples for Metals analysis: Yes / No

SAMPLE ID	LOCATION/ Field Point Name	SAMPLING		# Containers	Type Containers	MATRIX					METHOD PRESERVED								
		Date	Time			Water	Soil	Air	Sludge	Other	ICE	HCL	HNO <sub>3</sub>	Other					
MW-1		6/14/08	5:40	2	VOA P/B	X					X	X	X	X					
MW-2			6:20								X	X	X	X					
MW-3			6:10								X	X	X	X					
MW-4			6:00								X	X	X	X					
RW-5			5:50								X	X	X	X					
RW-6			5:30								X	X	X	X					

Relinquished By: [Signature] Date: 6/14 Time: 4:05 Received By: [Signature]

Relinquished By: \_\_\_\_\_ Date: \_\_\_\_\_ Time: \_\_\_\_\_ Received By: \_\_\_\_\_

Relinquished By: \_\_\_\_\_ Date: \_\_\_\_\_ Time: \_\_\_\_\_ Received By: \_\_\_\_\_

ICE/° \_\_\_\_\_  
GOOD CONDITION \_\_\_\_\_  
HEAD SPACE ABSENT \_\_\_\_\_  
DECHLORINATED IN LAB \_\_\_\_\_  
APPROPRIATE CONTAINERS \_\_\_\_\_  
PRESERVED IN LAB \_\_\_\_\_

COMMENTS: Attached Zemo protocol

VOAS O&G METALS OTHER  
PRESERVATION pH<2



# McC Campbell Analytical, Inc.

"When Quality Counts"

1534 Willow Pass Road, Pittsburg, CA 94565-1701  
Web: www.mcccampbell.com E-mail: main@mcccampbell.com  
Telephone: 877-252-9262 Fax: 925-252-9269

Conestoga-Rovers & Associates  5900 Hollis St, Suite A  Emeryville, CA 94608	Client Project ID: #130105; Golden Empire Property	Date Sampled: 06/14/08
	Client Contact: Mark Jonas	Date Received: 06/16/08
	Client P.O.:	Date Extracted: 06/19/08-06/20/08
		Date Analyzed 06/19/08-06/20/08

## Gasoline Range (C6-C12) Volatile Hydrocarbons as Gasoline with BTEX and MTBE\*

Extraction method SW5030B/Dawn Zemo Separation Analytical methods SW8021B/8015Cm Work Order: 0806437

Lab ID	Client ID	Matrix	TPH(g)	MTBE	Benzene	Toluene	Ethylbenzene	Xylenes	DF	% SS
001A	MW-1	W	3800,d1	ND<80	690	12	64	240	5	109
002A	MW-2	W	10,000,d1	ND<350	520	18	200	370	10	120
003A	MW-3	W	36,000,d1	ND<500	4700	140	830	1600	100	112
004A	MW-4	W	15,000,d1	ND<150	1100	50	86	1300	10	100
005A	RW-5	W	1200,d1	ND<250	310	5.8	3.5	25	1	110
006A	RW-9	W	8100,d1	ND<210	2800	33	100	220	10	109

Reporting Limit for DF =1;	W	50	5.0	0.5	0.5	0.5	0.5	0.5	µg/L
ND means not detected at or above the reporting limit	S	1.0	0.05	0.005	0.005	0.005	0.005	0.005	mg/Kg

\* water and vapor samples and all TCLP & SPLP extracts are reported in ug/L, soil/sludge/solid samples in mg/kg, wipe samples in µg/wipe, product/oil/non-aqueous liquid samples in mg/L.

# cluttered chromatogram; sample peak coelutes with surrogate peak.

+The following descriptions of the TPH chromatogram are cursory in nature and McCampbell Analytical is not responsible for their interpretation:

d1) weakly modified or unmodified gasoline is significant



# McC Campbell Analytical, Inc.

"When Quality Counts"

1534 Willow Pass Road, Pittsburg, CA 94565-1701  
Web: www.mcccampbell.com E-mail: main@mcccampbell.com  
Telephone: 877-252-9262 Fax: 925-252-9269

Conestoga-Rovers & Associates 5900 Hollis St, Suite A Emeryville, CA 94608	Client Project ID: #130105; Golden Empire Property	Date Sampled: 06/14/08
	Client Contact: Mark Jonas	Date Received: 06/16/08
	Client P.O.:	Date Extracted: 06/16/08
		Date Analyzed: 06/19/08

### Total Extractable Petroleum Hydrocarbons with Dawn Zemo Separation & MAI Silica Gel Clean-Up\*

Extraction method: SW3510C/3630C/Dawn Zemo S

Analytical methods: SW8015C

Work Order: 0806437

Lab ID	Client ID	Matrix	TPH-Diesel (C10-C23)	TPH-Motor Oil (C18-C36)	DF	% SS
0806437-001B	MW-1	W	410,e4	ND	1	104
0806437-002B	MW-2	W	2500,e4	ND	1	103
0806437-003B	MW-3	W	4900,e4	600	1	107
0806437-004B	MW-4	W	4200,e4	ND	1	105
0806437-005B	RW-5	W	190,e4	ND	1	102
0806437-006B	RW-9	W	610,e4	ND	1	104

Reporting Limit for DF =1; ND means not detected at or above the reporting limit	W	50	250	µg/L
	S	NA	NA	mg/Kg

\* water samples are reported in µg/L, wipe samples in µg/wipe, soil/solid/sludge samples in mg/kg, product/oil/non-aqueous liquid samples in mg/L, and all DISTLC / STLC / SPLP / TCLP extracts are reported in µg/L.

#) cluttered chromatogram resulting in coeluted surrogate and sample peaks, or; surrogate peak is on elevated baseline, or; surrogate has been diminished by dilution of original extract; &) low or no surrogate due to matrix interference.

+The following descriptions of the TPH chromatogram are cursory in nature and McC Campbell Analytical is not responsible for their interpretation:

e4) gasoline range compounds are significant.



**QC SUMMARY REPORT FOR SW8021B/8015Cm**

W.O. Sample Matrix: Water

QC Matrix: Water

WorkOrder: 0806437

EPA Method SW8021B/8015Cm		Extraction SW5030B/Dawn Ze			BatchID: 36316			Spiked Sample ID: 0806437-006A				
Analyte	Sample	Spiked	MS	MSD	MS-MSD	LCS	LCSD	LCS-LCSD	Acceptance Criteria (%)			
	µg/L	µg/L	% Rec.	% Rec.	% RPD	% Rec.	% Rec.	% RPD	MS / MSD	RPD	LCS/LCSD	RPD
TPH(btex) <sup>f</sup>	570	60	NR	NR	NR	89	85.4	4.23	70 - 130	20	70 - 130	20
MTBE	ND<210	10	NR	NR	NR	108	100	6.98	70 - 130	20	70 - 130	20
Benzene	2800	10	NR	NR	NR	115	102	12.5	70 - 130	20	70 - 130	20
Toluene	33	10	NR	NR	NR	88	87.4	0.631	70 - 130	20	70 - 130	20
Ethylbenzene	100	10	NR	NR	NR	98.4	98	0.385	70 - 130	20	70 - 130	20
Xylenes	220	30	NR	NR	NR	98.7	96.6	2.19	70 - 130	20	70 - 130	20
%SS:	109	10	102	102	0	94	97	3.58	70 - 130	20	70 - 130	20

All target compounds in the Method Blank of this extraction batch were ND less than the method RL with the following exceptions:

NONE

BATCH 36316 SUMMARY

Lab ID	Date Sampled	Date Extracted	Date Analyzed	Lab ID	Date Sampled	Date Extracted	Date Analyzed
0806437-001A	06/14/08 5:40 AM	06/20/08	06/20/08 5:26 PM	0806437-002A	06/14/08 6:20 AM	06/20/08	06/20/08 6:01 PM
0806437-003A	06/14/08 6:10 AM	06/19/08	06/19/08 9:03 PM	0806437-004A	06/14/08 6:00 AM	06/20/08	06/20/08 9:30 PM
0806437-005A	06/14/08 5:50 AM	06/19/08	06/19/08 10:12 PM	0806437-006A	06/14/08 5:30 AM	06/20/08	06/20/08 10:04 PM

MS = Matrix Spike; MSD = Matrix Spike Duplicate; LCS = Laboratory Control Sample; LCSD = Laboratory Control Sample Duplicate; RPD = Relative Percent Deviation.

% Recovery = 100 \* (MS-Sample) / (Amount Spiked); RPD = 100 \* (MS - MSD) / ((MS + MSD) / 2).

MS / MSD spike recoveries and / or %RPD may fall outside of laboratory acceptance criteria due to one or more of the following reasons: a) the sample is inhomogenous AND contains significant concentrations of analyte relative to the amount spiked, or b) the spiked sample's matrix interferes with the spike recovery.

£ TPH(btex) = sum of BTEX areas from the FID.

# cluttered chromatogram; sample peak coelutes with surrogate peak.

N/A = not applicable or not enough sample to perform matrix spike and matrix spike duplicate.

NR = analyte concentration in sample exceeds spike amount for soil matrix or exceeds 2x spike amount for water matrix or sample diluted due to high matrix or analyte content, or different container was used.



### QC SUMMARY REPORT FOR SW8015C

W.O. Sample Matrix: Water

QC Matrix: Water

WorkOrder 0806437

Analyte	EPA Method SW8015C		Extraction SW3510C/3630C/Da			BatchID: 36239			Spiked Sample ID: N/A			
	Sample	Spiked	MS	MSD	MS-MSD	LCS	LCSD	LCS-LCSD	Acceptance Criteria (%)			
	µg/L	µg/L	% Rec.	% Rec.	% RPD	% Rec.	% Rec.	% RPD	MS / MSD	RPD	LCS/LCSD	RPD
TPH-Diesel (C10-C23)	N/A	1000	N/A	N/A	N/A	101	104	3.04	N/A	N/A	70 - 130	30
%SS:	N/A	2500	N/A	N/A	N/A	108	91	17.2	N/A	N/A	70 - 130	30

All target compounds in the Method Blank of this extraction batch were ND less than the method RL with the following exceptions:  
NONE

#### BATCH 36239 SUMMARY

Lab ID	Date Sampled	Date Extracted	Date Analyzed	Lab ID	Date Sampled	Date Extracted	Date Analyzed
0806437-001B	06/14/08 5:40 AM	06/16/08	06/19/08 4:31 PM	0806437-002B	06/14/08 6:20 AM	06/16/08	06/19/08 5:41 PM

MS = Matrix Spike; MSD = Matrix Spike Duplicate; LCS = Laboratory Control Sample; LCSD = Laboratory Control Sample Duplicate; RPD = Relative Percent Deviation.

% Recovery =  $100 * (MS - Sample) / (Amount Spiked)$ ; RPD =  $100 * (MS - MSD) / ((MS + MSD) / 2)$ .

MS / MSD spike recoveries and / or %RPD may fall outside of laboratory acceptance criteria due to one or more of the following reasons: a) the sample is inhomogenous AND contains significant concentrations of analyte relative to the amount spiked, or b) the spiked sample's matrix interferes with the spike recovery.

N/A = not enough sample to perform matrix spike and matrix spike duplicate.

NR = analyte concentration in sample exceeds spike amount for soil matrix or exceeds 2x spike amount for water matrix or sample diluted due to high matrix or analyte content.



**QC SUMMARY REPORT FOR SW8015C**

W.O. Sample Matrix: Water

QC Matrix: Water

WorkOrder 0806437

EPA Method SW8015C		Extraction SW3510C/3630C/Da			BatchID: 36318			Spiked Sample ID: N/A				
Analyte	Sample	Spiked	MS	MSD	MS-MSD	LCS	LCSD	LCS-LCSD	Acceptance Criteria (%)			
	µg/L	µg/L	% Rec.	% Rec.	% RPD	% Rec.	% Rec.	% RPD	MS / MSD	RPD	LCS/LCSD	RPD
TPH-Diesel (C10-C23)	N/A	1000	N/A	N/A	N/A	100	102	1.26	N/A	N/A	70 - 130	30
%SS:	N/A	2500	N/A	N/A	N/A	103	98	5.18	N/A	N/A	70 - 130	30

All target compounds in the Method Blank of this extraction batch were ND less than the method RL with the following exceptions:  
NONE

BATCH 36318 SUMMARY

Lab ID	Date Sampled	Date Extracted	Date Analyzed	Lab ID	Date Sampled	Date Extracted	Date Analyzed
0806437-003B	06/14/08 6:10 AM	06/16/08	06/19/08 6:52 PM	0806437-004B	06/14/08 6:00 AM	06/16/08	06/19/08 8:02 PM
0806437-005B	06/14/08 5:50 AM	06/16/08	06/19/08 9:13 PM	0806437-006B	06/14/08 5:30 AM	06/16/08	06/19/08 10:23 PM

MS = Matrix Spike; MSD = Matrix Spike Duplicate; LCS = Laboratory Control Sample; LCSD = Laboratory Control Sample Duplicate; RPD = Relative Percent Deviation.

% Recovery = 100 \* (MS-Sample) / (Amount Spiked); RPD = 100 \* (MS - MSD) / ((MS + MSD) / 2).

MS / MSD spike recoveries and / or %RPD may fall outside of laboratory acceptance criteria due to one or more of the following reasons: a) the sample is inhomogenous AND contains significant concentrations of analyte relative to the amount spiked, or b) the spiked sample's matrix interferes with the spike recovery.

N/A = not enough sample to perform matrix spike and matrix spike duplicate.

NR = analyte concentration in sample exceeds spike amount for soil matrix or exceeds 2x spike amount for water matrix or sample diluted due to high matrix or analyte content.

## WELL GAUGING SHEET

<b>Client:</b> Conestoga-Rovers and Associates						
<b>Site</b> <b>Address:</b> 3055 35th Avenue, Oakland, CA						
<b>Date:</b> 6/14/2008 <span style="float: right;"><b>Signature:</b></span>						
Well ID	Time	Depth to SPH	Depth to Water	SPH Thickness	Depth to Bottom	Comments
MW-1	8:25		18.98		27.35	
MW-2	9:10		18.66		27.60	
MW-3	8:45		15.92		25.09	
MW-4	8:30		16.68		30.30	
RW-5	8:55		15.21		25.65	
RW-6	8:50		15.28		25.35	
RW-7	8:40		15.80		29.20	
RW-8	8:35		17.07		29.00	
RW-9	8:20		16.71		25.20	
RW-10	8:15		15.64		24.95	
RW-11	9:00		15.26		24.95	





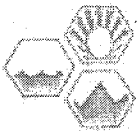

**McCAMPBELL ANALYTICAL, INC.**  
 1534 WILLOW PASS ROAD  
 PITTSBURG, CA 94565-1701  
 Website: [www.mccampbell.com](http://www.mccampbell.com) Email: [main@mccampbell.com](mailto:main@mccampbell.com)  
 Telephone: (877) 252-9262 Fax: (925) 252-9269

0806431

**CHAIN OF CUSTODY RECORD**

**TURN AROUND TIME**       
 RUSH 24 HR 48 HR 72 HR 5 DAY  
 GeoTracker EDF  PDF  Excel  Write On (DW)   
 Check if sample is effluent and "J" flag is required

Report To: Mark Jonas Bill To: Conejo-Rivers & Associates  
 Company: Conejo-Rivers & Associates  
5900 Hollis St. Ste A  
Emeryville, CA E-Mail: mjonas@coneriv.com  
 Tele: (510) 420-3307 Fax: (510) 420-9170  
 Project #: 130105 Project Name: Golden Empire Project  
 Project Location: 3055 35th Ave, Oakland, CA  
 Sampler Signature: Muskan Environmental Sampling

Analysis Request		Other	Comments
BTEX & TPH in Gas (602 / 801 / 8015) / MTBE			Filter Samples for Metals analysis: Yes / No
TPH as Diesel (8015)			
Total Petroleum Oil & Grease (1004 / 552) (BNC)			
Total Petroleum Hydrocarbons (AHL 1)			
EPA 801.2 / 601 / 8010 / 8021 (NYOC)			
MTBE / BTEX ONLY (EPA 602 / 802)			
EPA 505 / 608 / 804 (CI Pesticides)			
EPA 608 / 8082 FCU's ONLY, Aroclors / Congeners			
EPA 507 / 811 (NP Pesticides)			
EPA 514 / 815 (Acidic CI Herbicides)			
EPA 824.2 / 624 / 8260 (VOCs)			
EPA 825.2 / 625 / 8270 (SVOCs)			
EPA 8176 SNI / 8310 (PAHs / FNAP)			
CAM 17 Metals (200.7 / 200.8 / 6010 / 6020)			
LUFT'S Metals (200.7 / 200.8 / 6010 / 6020)			
Lead (200.7 / 200.8 / 6010 / 6020)			
<i>See analysis from 1/5/08 for            protocol (Geno)</i>			

SAMPLE ID	LOCATION/ Field Point Name	SAMPLING		# Containers	Type Containers	MATRIX					METHOD PRESERVED								
		Date	Time			Water	Soil	Air	Sludge	Other	ICE	HCL	HNO <sub>3</sub>	Other					
+ MW-1		6/4/08	5:40	2	2	X					X	X					X	X	
+ MW-2			6:20	1	1														
+ MW-3			6:30	1	1														
+ MW-4			6:00	1	1														
+ RW-5			5:50	1	1														
+ RW-6			5:30	1	X	X					X	X						X	

Relinquished By: [Signature] Date: 6/14/08 Time: 4:05 Received By: [Signature]  
 Relinquished By: \_\_\_\_\_ Date: \_\_\_\_\_ Time: \_\_\_\_\_ Received By: \_\_\_\_\_  
 Relinquished By: \_\_\_\_\_ Date: \_\_\_\_\_ Time: \_\_\_\_\_ Received By: \_\_\_\_\_

COMMENTS:  
ICE/ 3.60  
 GOOD CONDITION   
 HEAD SPACE ABSENT   
 DECHLORINATED IN LAB   
 APPROPRIATE CONTAINERS   
 PRESERVED IN LAB   
 YOAS  O&G METALS OTHER  
 pH < 2   
*(All the lead zero protocol)*



**CONESTOGA-ROVERS  
& ASSOCIATES**

**APPENDIX C  
TPHg and Benzene  
Concentration Trend Graphs**

**TPHg and Benzene Concentration Trends  
Well MW-1 (March 1997 to Present)**

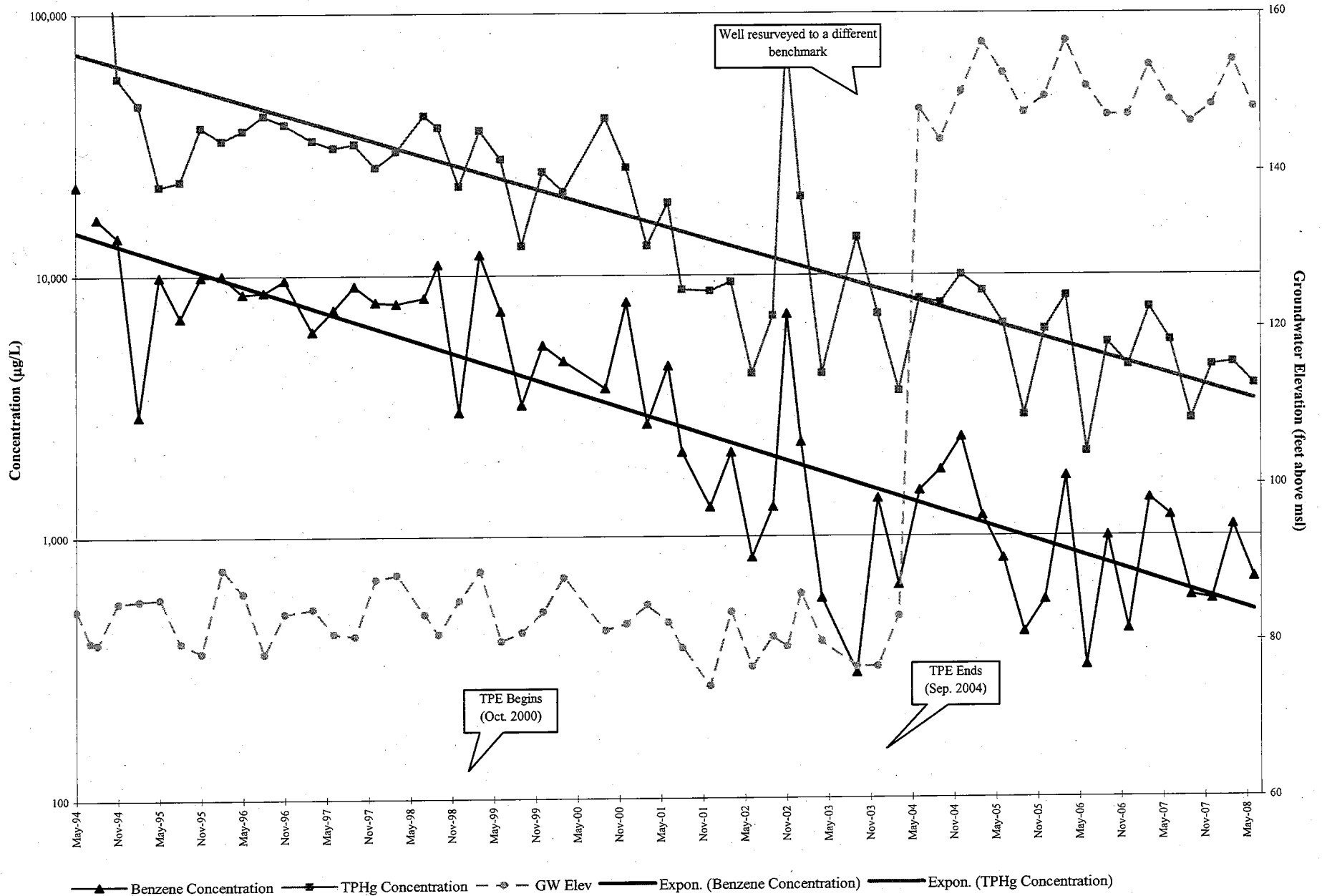

### TPHg and Benzene Concentration Trends Well MW-2 (March 1997 to Present)

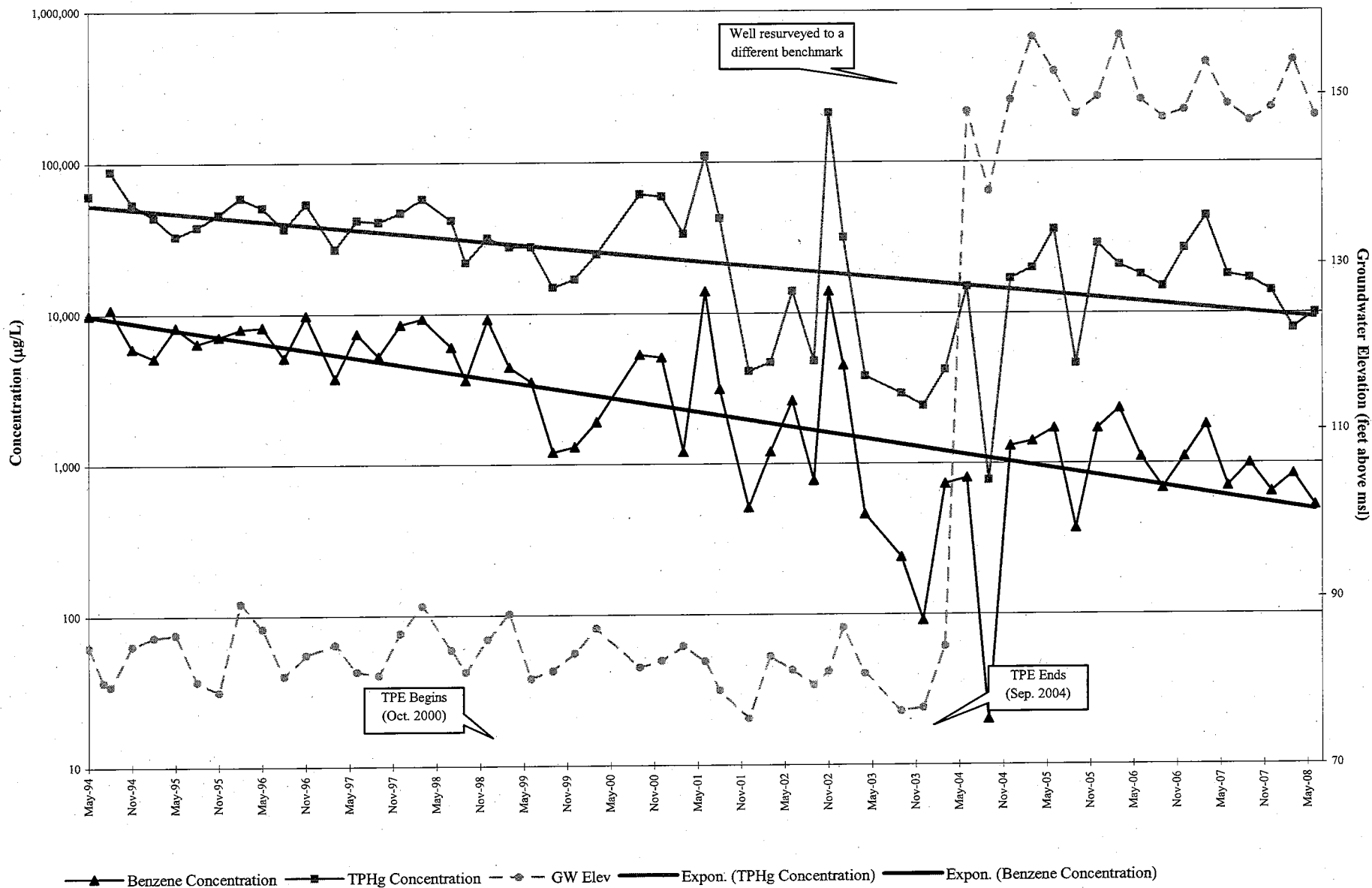

### TPHg and Benzene Concentration Trends Well MW-3 (March 1997 to Present)

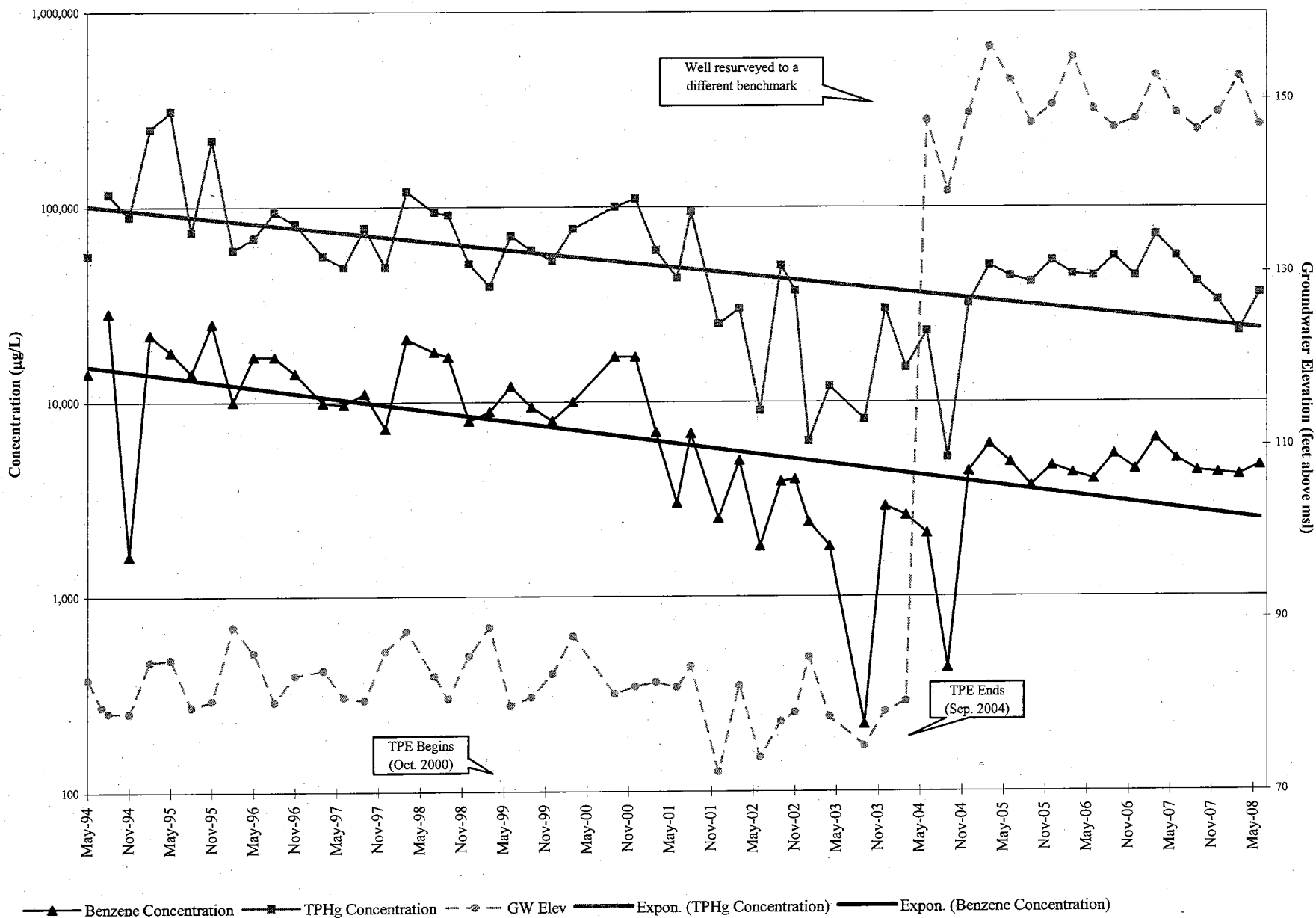

### TPHg and Benzene Concentration Trends Well MW-4 (March 1997 to Present)

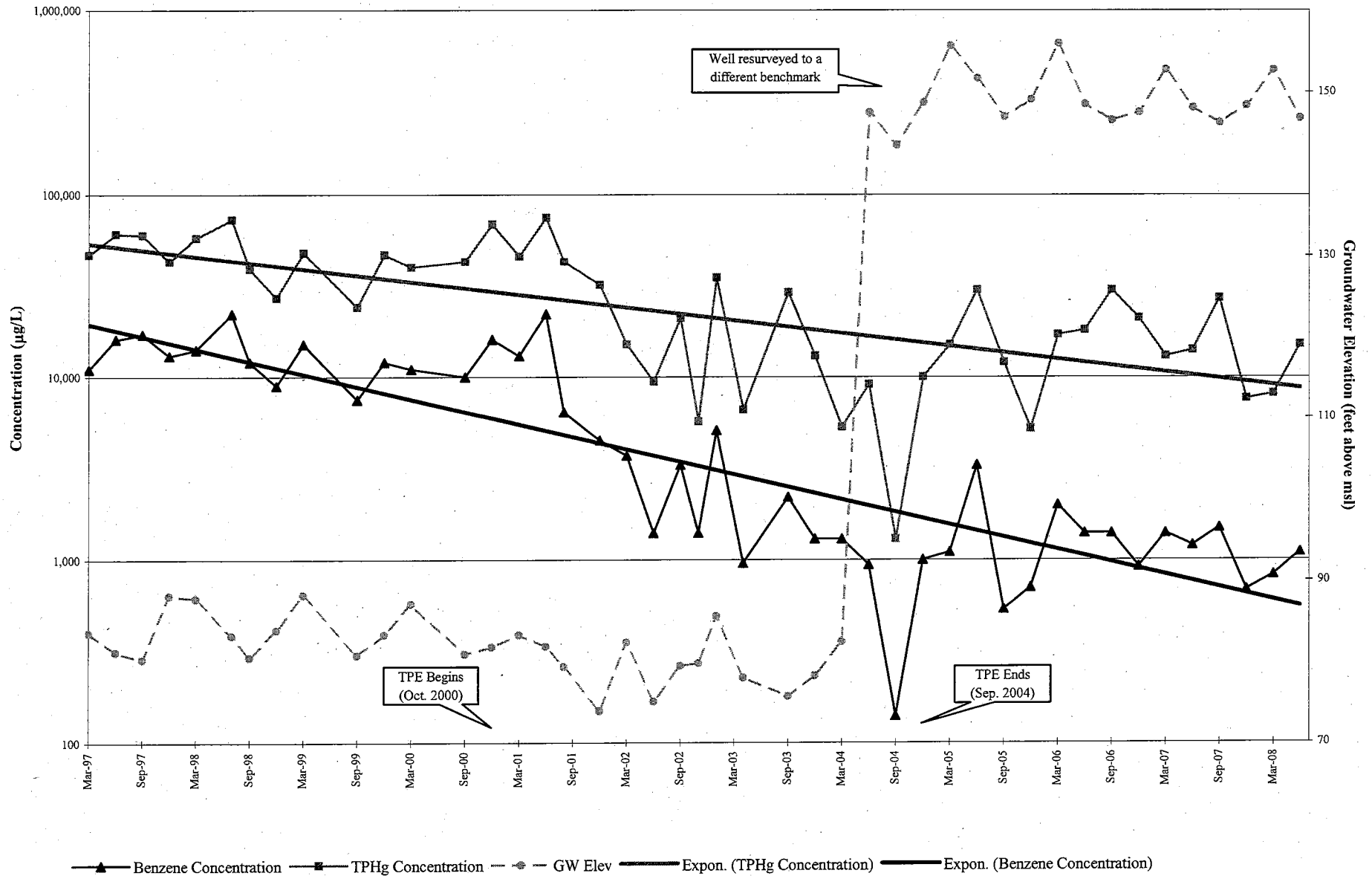

**TPHg and Benzene Concentration Trends  
Well RW-5 (March 2005 to Present)**

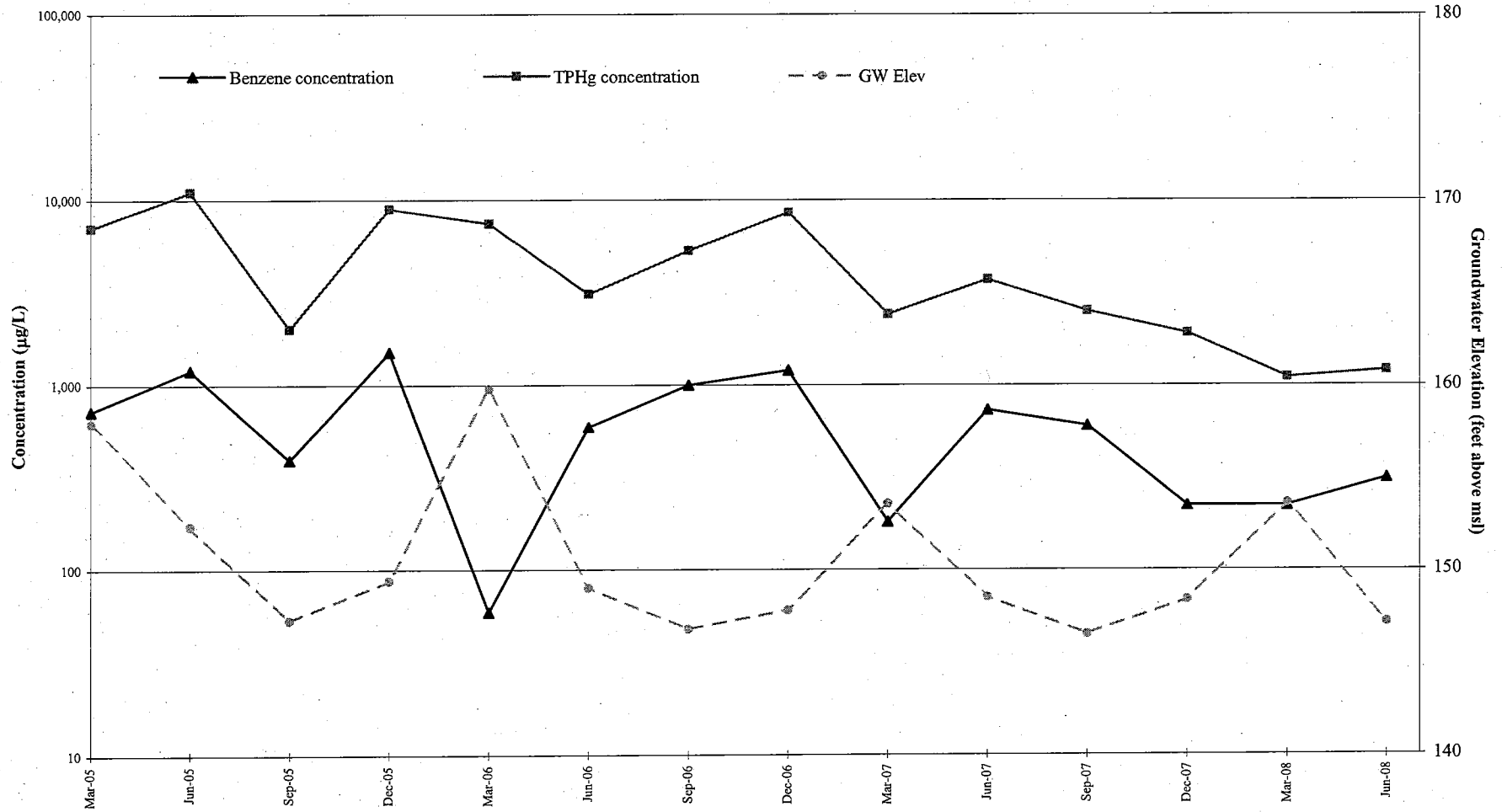



**TPHg and Benzene Concentration Trends  
Well RW-9 (March 2005 to Present)**

