

RECEIVED

9:32 am, Jul 08, 2009

Alameda County
Environmental Health



ENVIRONMENTAL ENGINEERING, INC.
6620 Owens Drive, Suite A • Pleasanton, CA 94588
TEL (925)734-6400 • FAX (925)734-6401
www.somaenv.com

July 6, 2009

Mr. Jerry Wickham
Alameda County
Department of Environmental Health Services
1131 Harbor Bay Parkway, Suite 250
Alameda, California 94502-6577

Subject: **Fuel Leak Case#RO0000265**
Site Address: 3609 International Blvd., Oakland, California

Dear Mr. Wickham:

SOMA's "Second Quarter 2009 Groundwater Monitoring and Remediation System Report With Evaluation of Effectiveness of Monthly MPE" for the subject property has been uploaded to the State's GeoTracker database and Alameda County's FTP site for your review.

Thank you for your time in reviewing our report. If you have any questions or comments, please call me at (925) 734-6400.

Sincerely,

Mansour Sepehr, Ph.D., PE
Principal Hydrogeologist

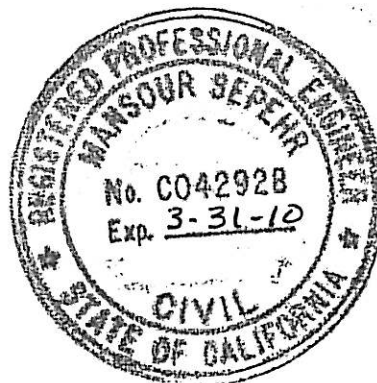

Enclosure

cc: Mr. Abolghassem Razi w/report enclosure
Tony's Express Auto Service

Mr. Vince Tong w/report enclosure
Traction International

**Second Quarter 2009
Groundwater Monitoring and
Remediation System Report
With Evaluation of Effectiveness
of Monthly MPE**

**Tony's Express Auto Service
3609 International Boulevard
Oakland, California**

July 6, 2009

Project 2331

**Prepared for
Mr. Abolghassem Razi
3609 International Boulevard
Oakland, California 94601**



ENVIRONMENTAL ENGINEERING, INC.

6620 Owens Drive Suite A Pleasanton CA 94588 Ph: 925.734.6400 F: 925.734-6401 www.somaenv.com

CERTIFICATION

SOMA Environmental Engineering, Inc. has prepared this report on behalf of Mr. Abolghassem Razi, property owner of 3609 International Boulevard, Oakland, California, to comply with Alameda County Environmental Health Services requirements for the Second Quarter 2009 groundwater monitoring event.

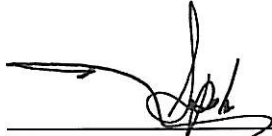

Mansour Sepehr, PhD, PE
Principal Hydrogeologist

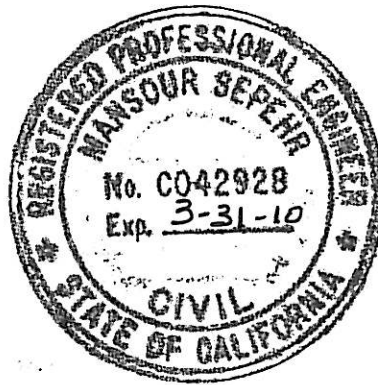

TABLE OF CONTENTS

CERTIFICATION	i
TABLE OF CONTENTS.....	ii
LIST OF TABLES.....	iii
LIST OF FIGURES	iii
LIST OF APPENDICES	iv
1. INTRODUCTION	1
1.1 Summary of Field Activities.....	1
1.2 Summary of Laboratory Analysis	1
2. RESULTS	2
2.1 Field Measurements	2
2.2 Laboratory Analysis	3
3. GROUNDWATER TREATMENT SYSTEM OPERATION	4
4. OPERATION OF AIR SPARGING SYSTEM	5
5. May 2009 MULTI-PHASE EXTRACTION EVENT	6
6. CONCLUSIONS AND RECOMMENDATIONS.....	7
6.1 Conclusions	7
6.2 Recommendations	8
7. REPORT LIMITATIONS	8

LIST OF TABLES

Table 1	Historical Groundwater Elevation Data and Analytical Results
Table 2	Total Volume of Water Treated, Historical Operational Data, and Laboratory Analytical Results for PSP#1 (Effluent) and GAC-1 Samples
Table 3	Total Mass of Petroleum Hydrocarbons Removed by the Vapor Extraction System and Historical Operational Data
Table 4	May 2009 MPE Event, Operational Data
Table 5	May 2009 MPE Event, Extraction Data and VOC Mass Removal Rate
Table 6	May 2009 MPE Event, Mass Removal
Table 7	Dissolved-Phase Hydrocarbon Concentrations, Pre- and Post-MPE Event

LIST OF FIGURES

Figure 1	Site Vicinity Map
Figure 2	Site Map Showing Locations of Air Sparging Wells, Groundwater Monitoring Wells, Additional Soil Vapor Wells, GAC System, SVE System, and Extraction Well
Figure 3	Groundwater Elevation Contour Map in Feet, June 8, 2009
Figure 4	Contour Map of TPH-g Concentrations in the Groundwater June 8, 2009
Figure 5	Contour Map of Benzene Concentrations in the Groundwater June 8, 2009
Figure 6	Contour Map of MtBE Concentrations in the Groundwater (EPA Method 8260B) June 8, 2009
Figure 7	Schematic of the Groundwater Remediation System
Figure 8	Cumulative Mass of TPH-g and MtBE Removed from Groundwater Since Installation of the Treatment System
Figure 9	Block Diagram of the SVE System
Figure 10	Block Diagram of the Air Sparge System
Figure 11	Dissolved-Phase Hydrocarbon Concentrations in Groundwater, TPH-g, Pre- and Post-MPE Event in MW-1

- Figure 12 Dissolved-Phase Hydrocarbon Concentrations in Groundwater, Benzene, Pre- and Post-MPE Event in MW-1
- Figure 13 Dissolved-Phase Hydrocarbon Concentrations in Groundwater, MtBE, Pre- and Post-MPE Event in MW-1
- Figure 14 Dissolved-Phase Hydrocarbon Concentrations in Groundwater, TPH-g, Pre- and Post-MPE Event in MW-3
- Figure 15 Dissolved-Phase Hydrocarbon Concentrations in Groundwater, Benzene, Pre- and Post-MPE Event in MW-3
- Figure 16 Dissolved-Phase Hydrocarbon Concentrations in Groundwater, MtBE, Pre- and Post-MPE Event in MW-3
- Figure 17 Cumulative Mass of VOCs Removed
- Figure 18 Mass of VOCs Removed per Event
- Figure 19 Comparison of TPH-g Concentrations in MW-1
- Figure 20 Comparison of Benzene Concentrations in MW-1
- Figure 21 Comparison of MtBE Concentrations in MW-1
- Figure 22 Comparison of TPH-g Concentrations in MW-3
- Figure 23 Comparison of Benzene Concentrations in MW-3
- Figure 24 Comparison of MtBE Concentrations in MW-3

LIST OF APPENDICES

- Appendix A Standard Operating Procedures for Conducting Groundwater Monitoring Activities
- Appendix B Table of Elevations and Coordinates on Monitoring Wells and Field Measurements of Physical, Chemical, and Biodegradation Parameters of Groundwater
- Appendix C Chain of Custody Form and Laboratory Report
- Appendix D Chain of Custody Forms and Laboratory Reports for the Groundwater Extraction Treatment System
- Appendix E: May 2009 MPE Event Field Data Sheets

1. INTRODUCTION

SOMA Environmental Engineering, Inc. (SOMA) has prepared this monitoring and groundwater remediation report on behalf of Mr. Abolghassem Razi, owner of the property at 3609 International Boulevard at the intersection of 36th Avenue and International Boulevard in Oakland, California (Figure 1). Tony's Express Auto Service operates on the property.

This report summarizes results of the Second Quarter 2009 groundwater monitoring event conducted at the site on June 8, 2009, and includes laboratory analytical results for groundwater samples.

This report also describes operation of the groundwater remediation systems composed of groundwater pump-and-treat and groundwater air sparging, and results of May 2009 multi-phase extraction (MPE) conducted at the site. Locations of groundwater remediation systems are shown in Figure 2.

1.1 Summary of Field Activities

On June 8, 2009, eight on-site monitoring wells (MW-1, MW-2, MW-3, MW-4R, MW-5 through MW-8), two off-site wells (MW-10, MW-12), three French drain risers (FD Center [FDC], FD East [FDE], and FD West [FDW]), and one extraction well (EX-1) were measured for depth to groundwater.

On June 8, 2009, additional field measurements and grab groundwater samples were collected from MW-1, MW-3, MW-6, MW-8, and MW-10. Quarterly sampling of MW-2, MW-4R, MW-5, MW-7, and MW-12 and all testing for ferrous iron, nitrate, and sulfate was discontinued per directive of Alameda County Environmental Health Services (ACEHS) dated August 26, 2008.

Groundwater monitoring activities were performed in accordance with general guidelines of the California Regional Water Quality Control Board (CRWQCB) and ACEHS. A description of groundwater monitoring procedures followed is included in Appendix A. Figure 2 shows well and riser locations.

A natural attenuation study was conducted during this monitoring event to evaluate whether petroleum hydrocarbons found in groundwater were biodegrading.

1.2 Summary of Laboratory Analysis

Curtis & Tompkins, Ltd., a California state-certified laboratory, analyzed groundwater samples for the following:

- Total petroleum hydrocarbons as gasoline (TPH-g)
- Benzene, toluene, ethylbenzene, total xylenes (BTEX)
- Methyl tertiary-butyl ether (MtBE)

Samples were prepared using EPA Method 5030 and analyzed using EPA Method 8260B.

2. RESULTS

Following are results of field measurements and laboratory analyses for the Second Quarter 2009 groundwater monitoring event.

2.1 Field Measurements

As shown in Table 1, depths to groundwater for monitoring wells ranged from 10.14 feet in MW-10 to 12.48 feet in MW-6. Corresponding groundwater elevations ranged from 26.01 feet in MW-12 to 29.24 feet in MW-5. Groundwater elevations for FD Center, FD East, FD West and extraction well EX-1 were 23.46 feet, 27.55 feet, 27.29 feet, and 23.70 feet, respectively.

Figure 3 shows the groundwater elevation contour map. Groundwater flows toward FDC and extraction well EX-1 at an approximate gradient of 0.07 feet/foot. The lowest site-wide groundwater elevation was measured in FDC. EX-1 and FDC are providing a capture zone within the region of the UST cavity and in general have reduced off-site contaminant migration.

Field notes for physical, chemical and biodegradation parameters measured during this monitoring event are included in Appendix B.

The most energetically preferred electron acceptor for redox reactions is dissolved oxygen (DO). Evaluating distribution of electron acceptors can provide evidence of where, and to what extent, hydrocarbon biodegradation is occurring.

Upon equalization of the surrounding aquifer, when the purge cycle was terminated, DO concentrations ranged from 0.66 mg/L in MW-1 to 1.75 mg/L in MW-3. Oxidation-reduction potential (ORP) showed negative redox potentials in MW-1, MW-3, MW-6, MW-8, and MW-10. Oxidation of petroleum hydrocarbons could have occurred in these monitoring wells because negative redox potential indicates that contaminants in groundwater are conducive to anaerobic biodegradation.

Testing for ferrous iron, nitrate, and sulfate was discontinued per ACEHS directive. Due to the extent of biodegradation data generated during quarterly monitoring events, SOMA has adequately characterized site groundwater.

2.2 Laboratory Analysis

Table 1 presents laboratory analysis results for groundwater samples collected during this monitoring event, and Appendix C contains chain of custody documentation and laboratory analytical reports.

TPH-g concentrations ranged from 2,600 µg/L in MW-10 to 19,000 µg/L in MW-6.

The following concentration trends since the previous monitoring event (First Quarter 2009) were observed:

- At MW-1 in the vicinity of the UST cavity, TPH-g increased; however, the current TPH-g concentration is significantly lower than in Fourth Quarter 2006.
- At MW-3 in the vicinity of the UST cavity, TPH-g has increased.
- TPH-g has increased at MW-6.
- TPH-g has increased in MW-8.
- TPH-g has increased in off-site well MW-10.

Refer to Table 1 for detailed TPH-g site concentration trends.

Figure 4 displays the contour map of TPH-g concentrations in groundwater. The highest TPH-g concentrations were detected in the vicinity of the pump islands at MW-6.

The following BTEX concentration trends were observed during this monitoring event:

- The highest BTEX concentrations were detected in MW-6 at 450 µg/L, 240 µg/L, 970 µg/L, and 1,960 µg/L, respectively.
- Since the previous monitoring event (First Quarter 2009), all BTEX concentrations have increased at MW-1, MW-3, MW-6, MW-8, and MW-10, except for benzene in MW-1.

Figure 5 shows the contour map of benzene concentrations in groundwater. The majority of the benzene plume appears to be in the vicinity of the pump islands at MW-6. Refer to Table 1 for benzene concentration trends.

MtBE was below the laboratory-detection limit in MW-6. Detectable MtBE concentrations ranged from 2.2 µg/L in MW-1 to 26 µg/L in MW-10. Figure 6

shows the contour map of MtBE concentrations in groundwater. Since the previous monitoring event (First Quarter 2009), MtBE has decreased in MW-1 and MW-8, and increased in MW-3 and MW-10.

3. GROUNDWATER TREATMENT SYSTEM OPERATION

The treatment system began operating on December 9, 1999. Since startup, 4,245,670 gallons of groundwater have been treated and discharged (as of June 22, 2009), into the East Bay Municipal Utility District (EBMUD) sewer system under the existing discharge permit.

As of January 9, 2004, the previously installed pneumatic downhole pumps in FDW and FDC were removed and replaced with electrical submersible pumps. On May 4, 2005, to maintain accurate recordings of total flow through the system, a newer totalizer meter was installed. On September 29, 2005, the existing 2,000-pound carbon vessel was replaced with a newer 2,000-pound carbon vessel that was refurbished with new carbon; the 200-pound carbon drum was also replaced. The former 2,000-pound vessel had become rusted from prolonged use. A schematic diagram of the remediation system is displayed in Figure 7.

On February 19, 2007, a carbon change-out was conducted on the remedial system, during which the 2,000-pound vessel was refurbished with new carbon and the 200-pound carbon drum was replaced.

To reduce the hydrocarbon source region in the vicinity of the UST cavity, SOMA oversaw installation of extraction well EX-1 by Gregg Drilling & Testing, Inc. on February 5, 2007. On April 20, 2007, SOMA installed an electric submersible pump in EX-1, connected it to the existing groundwater remediation system, and began extracting groundwater from the well. The pump is powered on the same electrical circuit as the two existing pumps inside the French drain risers. Underground piping to the existing system influent surge tank conveys the extracted groundwater, which is then treated using granular activated carbon (GAC) and discharged to the local sanitary sewer system, in accordance with the EBMUD discharge permit. Figure 2 shows the location of EX-1.

Table 2 presents total volume of treated groundwater and groundwater analytical results. All effluent samples have remained below discharge limits set forth by EBMUD. The most current laboratory reports for the groundwater treatment system are included in Appendix D.

As of June 8, 2009, the treatment system has removed approximately 250.62 pounds of hydrocarbons and 87.78 pounds of MtBE from groundwater at the site.

Figure 8 shows approximate masses of TPH-g and MtBE removed from impacted groundwater during operation of the treatment system.

4. OPERATION OF AIR SPARGING SYSTEM

From February 22, 2006 to March 6, 2006, SOMA oversaw installation of the air sparging system, which consists of nine vapor extraction wells and three air sparge wells. The air sparge wells were installed in the vicinity of the UST cavity, pump islands, and near MW-6 (Figure 2). Figures 9 and 10 provide block diagrams of the air sparging and soil vapor extraction (SVE) units.

In November 2005, prior to installation of the air sparging wells, SOMA collected air samples from previously existing SVE wells. Based on sampling results, which showed non-detectable contaminant levels, lines from SVE wells P-4 and ISL-1 to the vacuum pump were closed. This allowed for greater vacuum at the more impacted SVE wells.

The air sparging system was initially started on March 15, 2006. However, due to close proximity of the system to a residential area, the system was modified to reduce noise level. Specifically, a timer-controller was installed on the compressor to limit operation to daytime hours. To further reduce noise, the existing blower unit, installed in 2000, was rebuilt and foam placed around it as a noise suppressant.

To more effectively increase removal of contaminants from soil, an additional vacuum blower was installed in series to the existing vacuum blower on July 24, 2006. Rain causes the water table to rise, decreasing the actual layer of the unsaturated zone and greatly reducing the actual mass of contaminants in the soil that can be removed by the remedial system. Based on the reduction in the unsaturated region, as well as a reduction in the mass of contaminant vapors removed from the soil, the remedial system was shut down on November 7, 2006.

On May 23, 2007, SOMA restarted the SVE and air sparge systems and resumed recording field readings for these systems. Based on field measurements, it appeared that using both vacuum blowers in series on the same extraction manifold had little effect on the air flow rate into the system or concentrations of hydrocarbons in the extracted gases. Therefore, the inlet piping from the well field was divided into two manifolds with the intent to use each vacuum pump to extract from a separate set of wells. However, due to alterations in the facility's main electrical supply panel made by non-SOMA personnel without SOMA's knowledge, operation of both vacuum pumps at the same time was not possible because the resultant electrical load tripped the circuit breaker

that includes the SVE system. Subsequent operation of the SVE system was limited to one blower at a time.

As shown in Table 3, approximately 967.2 pounds of hydrocarbons as vapor have been removed from impacted soil, as of September 28, 2007. The air sparging remedial system has been shut down since then. Table 3 also outlines the history of the SVE system.

5. MAY 2009 MULTI-PHASE EXTRACTION EVENT

The May 2009 MPE event, on May 11-15, utilized wells MW-1, MW-3, MW-6, and MW-8. MPE operational data is presented in Table 4, extraction data in Table 5, and field data sheets in Appendix E. A representative sample was analyzed from the stack of the thermal oxidizer to show compliance with the Bay Area Air Quality Management District (BAAQMD) permit. Table 6 lists sample identifiers and analysis results of vapor samples.

MPE was performed at the above-mentioned wells starting Monday, May 11, 2009 at 12:30 and ending Friday, May 15, 2009 at 16:30. Total MPE time was 6,000 minutes, or 100 hours.

The total estimated mass of volatile organic compounds (VOCs) removed from soil vapor extracted during the MPE event was 20.29 lbs. The estimated VOC mass removal rate was 4.87 lbs/day.

As of the May 2009 MPE event, the cumulative total mass of VOCs extracted by MPE from extraction wells is 667.04 lbs (Figure 17). This includes the following amounts for each event: 64 lbs, December 2007 pilot test; 24.3 lbs, March 2008; 43.06 lbs, April 2008; 46.19 lbs, May 2008; 58.0 lbs, June 2008; 239.48 lbs, September 2008; 137.61 lbs, October 2008; 34.11 lbs, February 2009; and 20.29 lbs, May 2009. Figure 18 illustrates the mass of VOCs removed during each MPE event.

Listed in Table 7 are analysis results for groundwater samples collected from MW-1, MW-3, and MW-6 before and after the previous MPE events. For cost saving purposes, SOMA no longer conducts sampling before or after events. Instead, wells are sampled only during quarterly monitoring events. Figures 11 through 16 illustrate comparison of groundwater analysis results for previous MPE events.

Comparison of groundwater monitoring analysis results from First Quarter 2009 (before May 2009 event) and Second Quarter 2009 (after May 2009 event) groundwater monitoring events (Table 1) indicate that concentrations of TPH-g and BTEX increased at MW-1, MW-3, MW-6, MW-8, and MW-10, except for

benzene in MW-1, which decreased. In the same comparison, MtBE decreased in MW-1 and MW-8, and increased in MW-3 and MW-10. Increases in constituent concentrations illustrate that fuel hydrocarbons are still adsorbed to the smear zone while decreases illustrate that fuel hydrocarbons are being stripped and removed from the smear zone.

Figures 19 through 21 illustrate concentrations of TPH-g, benzene, and MtBE in monitoring well MW-1 from the Fourth Quarter 2007 monitoring event to the Second Quarter 2009 monitoring event, including six MPE events conducted during 2008. For cost reduction, no groundwater sampling was conducted during the February and May 2009 MPE events. Figures 22 through 24 illustrate concentrations of TPH-g, benzene, and MtBE in monitoring well MW-3 from the Fourth Quarter 2007 monitoring event to the Second Quarter 2009 monitoring event, including six MPE events conducted during 2008.

6. CONCLUSIONS AND RECOMMENDATIONS

6.1 Conclusions

Conclusions based on findings of Second Quarter 2009 groundwater monitoring are summarized below.

1. In general, based on low groundwater elevations observed at FDC and EX-1, a capture zone remains established at these locations.
2. The highest TPH-g concentration was detected in MW-6 at 19,000 µg/L. Compared with the previous monitoring event (First Quarter 2009), TPH-g concentrations have increased in all sampled wells. It appears that MW-1 and MW-6 are located within the remaining hotspot of the groundwater chemical plume.
3. It appears that MtBE concentrations in groundwater are diminishing across the site and that current maximum concentrations are below Environmental Screening Levels (ESLs) for industrial land use type where groundwater is not a potential drinking water source.
4. The source area remains in the vicinity of the UST cavity, pump islands, and eastern section of the mechanic shop at MW-1, MW-3, and MW-6. During this monitoring event, the highest BTEX concentrations were detected in MW-6 at 450 µg/L, 240 µg/L, 970 µg/L, and 1,960 µg/L, respectively.
5. In general, the GAC and SVE systems have effectively reduced peak contaminant levels beneath the site. Since initial startup, approximately 250.62 pounds of hydrocarbons and 87.78 pounds of MtBE have been

removed from groundwater. Approximately 967.2 pounds of petroleum hydrocarbons have been removed from the vadose zone.

6. MPE events at the site have effectively reduced contaminant concentrations. The cumulative total mass of VOCs extracted by MPE during the pilot test and eight subsequent MPE events is 667.04 lbs. Comparison of benzene concentrations with pre-MPE events shows a dramatic reduction in contaminant levels in source area wells such as MW-3 and MW-1.

6.2 Recommendations

Based on results of this monitoring event, and in accordance with ACEHS directive dated August 26, 2008, SOMA will conduct the following action items:

1. Continue operation of the pump-and-treat system to maintain the removal rate of contaminant masses in groundwater.
2. Continue groundwater monitoring of wells MW-1, MW-3, MW-6, MW-8, and MW-10 during quarterly monitoring events.
3. Conducting one additional MPE event using MW-6, MW-8 and MW-10 to reduce the contaminant levels below ESLs for site closure. Approximately 667.04 lbs of VOCs have been removed during MPE operations at the site.

7. REPORT LIMITATIONS

This report is the summary of work done by SOMA including observations and descriptions of site conditions. It includes analytical results produced by California state-certified laboratories for the current and previous monitoring events and summaries of data produced by environmental consultants for previous monitoring events. Quantities and locations of wells were selected to provide the required information, but may not be completely representative of entire site conditions. All conclusions and recommendations are based on laboratory analysis results. Conclusions beyond those specifically stated in this document should not be inferred from this report.

SOMA warrants that services were provided in accordance with generally accepted environmental engineering and consulting practices at the time of this sampling.

TABLES

Second Quarter 2009: Groundwater Monitoring and Remediation System Report
With Evaluation of Effectiveness of Monthly MPE

Table 1
Historical Groundwater Elevation Data & Analytical Results
3609 International Boulevard, Oakland, California

Monitoring Well	Date	Top Of Casing Elevation ¹ (feet)	Depth to Groundwater (feet)	Groundwater Elevation (feet)	TPH-g (µg/L)	Benzene (µg/L)	Toluene (µg/L)	Ethyl-Benzene (µg/L)	Total Xylenes (µg/L)	MtBE ² EPA 8260B (µg/L)
MW-1	10/5/1994	97.99	15.39	82.60	320,000	24,000	21,000	2,600	15,000	NA
	12/5/1994	97.99	9.32	88.67	80,000	3,800	6,600	2,300	11,000	NA
	3/2/1995	97.99	8.07	89.92	32,000	190	160	150	490	NA
	6/6/1995	97.99	9.53	88.46	21,000	950	650	570	150	NA
	10/5/1995	97.99	13.29	84.70	59,000	140	130	140	390	NA
	1/2/1996	97.99	10.07	87.92	30,000	71	73	50	120	NA
	4/1/1996	97.99	8.29	89.70	31,000	98	120	63	170	NA
	12/3/1996	97.99	11.67	86.32	NA	NA	NA	NA	NA	NA
	4/9/1997	97.99	11.14	86.85	NA	NA	NA	NA	NA	NA
	12/10/1997	97.99	9.30	88.69	27,000	2,300	2,100	1,400	5,100	NA
	9/10/1998	97.99	13.58	84.41	NA	NA	NA	NA	NA	NA
	12/16/1998	97.99	11.10	86.89	65,000	2,500	2,400	2,300	9,500	160
	3/16/1999	97.99	9.91	88.08	17,000	480	860	850	3,000	190
	6/10/1999	97.99	11.10	86.89	25,000	1,110	1,460	1,330	5,265	77
	8/23/1999	97.99	13.35	84.64	19,750	678	463	893	2,938	38
	11/9/1999	97.99	14.45	83.54	10,000	693	15	<5	3,471	50
	2/7/2000	97.99	11.20	86.79	40,000	2,280	1,380	8	6,130	47
5/31/2000	97.99	11.49	86.50	15,610	610	350	310	1,400	<5	
8/9/2000	97.99	13.36	84.63	11,000	638	<5	<5	<5	17.1	
11/2/2000	97.99	13.20	84.79	7,050	435	52	ND	689	10	

Table 1
Historical Groundwater Elevation Data & Analytical Results
3609 International Boulevard, Oakland, California

Monitoring Well	Date	Top Of Casing Elevation ¹ (feet)	Depth to Groundwater (feet)	Groundwater Elevation (feet)	TPH-g (µg/L)	Benzene (µg/L)	Toluene (µg/L)	Ethyl-Benzene (µg/L)	Total Xylenes (µg/L)	MtBE ² EPA 8260B (µg/L)
MW-1 cont.	3/13/2001	97.99	8.96	89.03	14,570	1,005	440	108	2,030	16
	5/22/2001	97.99	11.50	86.49	4,900	310	81	82	388	150
	8/8/2001	97.99	13.51	84.48	14,820	852	342	568	1,606	2,000
	11/19/2001	97.99	14.01	83.98	41,000	2,700	5,100	1,000	4,570	74,000
	2/21/2002	97.99	10.11	87.88	260,000	3,700	12,000	3,700	19,200	23,000
	5/7/2002	97.99	10.86	87.13	53,000	4,400	5,100	1300	7,000	32,000
	7/30/2002	40.11	12.80	27.31	29,000	2,400	2,500	920	4,400	13,000
	10/2/2002	40.11	15.50	24.61	27,000	2,200	2,400	950	4,500	34,000
	1/3/2003	40.11	9.73	30.38	62,000	3,500	6,000	1600	9,700	48,000
	5/3/2003	40.11	9.71	30.40	59,000	3,100	2,700	1500	7,000	14,000
	7/24/2003	40.11	12.44	27.67	36,000	4,800	1,800	1300	5,600	25,000
	10/22/2003	40.11	13.89	26.22	630,000 H	3,300	1900 C	3600	27,700	15,000
	1/22/2004	40.11	10.45	29.66	39,000	3,100	1,600	950	4,300	8,500
	4/1/2004	40.11	11.49	28.62	41,000	1,200	350C	830	2,740	4,300
	8/20/2004	40.11	13.81	26.30	22,000	2,000	220	560	3,090	6,900
	12/8/2004	40.11	11.10	29.01	22,790	1,634	319	895	2,851	5,504
	3/16/2005	40.11	8.40	31.71	44,400	3,150	811	1,090	2,856	7,180
	5/16/2005	40.11	9.72	30.39	33,900	3,440	1,700	1,090	2,276	3,210
	7/14/2005	40.11	11.31	28.80	50,100	4,350	1,760	1,500	2,853	3,980
	10/13/2005	40.11	13.51	26.60	43,100	1,960	325	639	3,080	3,000
	1/3/2006	40.11	8.82	31.29	55,000	1,100	510	1,100	4,070	2,200
	4/7/2006	40.11	7.12	32.99	42,500	1,780	1,010	1,610	2,449	2,110
	9/8/2006	40.11	12.64	27.47	37,200	3,280	1,460	1,290	2,685	2,180
	11/29/2006	40.11	12.49	27.62	29,400	2,490	782	1,510	1,815	1,540
	2/27/2007	40.11	9.68	30.43	17,000	1,400	452	989	1,583	1,150
	5/24/2007	40.11	11.58	28.53	8,630	575	121	306	687	235
	8/21/2007	40.11	13.34	26.77	7,480	544	87	356	537	172
	11/15/2007	40.11	12.73	27.38	18,500	413	93.1	523	627	86.6
	2/22/2008	40.11	9.82	30.29	3,450	20.7	3.73	60.2	78.0	8.11
	5/7/2008	40.11	12.09	28.02	4,470	26.1	14.8	57.6	464.6	10.6
	8/6/2008	40.11	13.43	26.68	3,400	17	7.8	73	309	3.7
	11/4/2008	40.11	13.69	26.42	7,500	40	49	190	810	8.7
	11/13/2008	40.11	NM	NM	7,700	43	30	180	740	8.8
3/24/2009	40.11	10.44	29.67	3,100	14	6.6	90	216	5.1	
6/8/2009	40.11	12.05	28.06	4,900 ^y	8.7	12	110	461	2.2	

Table 1
Historical Groundwater Elevation Data & Analytical Results
3609 International Boulevard, Oakland, California

Monitoring Well	Date	Top Of Casing Elevation ¹ (feet)	Depth to Groundwater (feet)	Groundwater Elevation (feet)	TPH-g (µg/L)	Benzene (µg/L)	Toluene (µg/L)	Ethyl-Benzene (µg/L)	Total Xylenes (µg/L)	MtBE ² EPA 8260B (µg/L)
MW-2	10/1/1994	98.58	15.36	83.22	NA	NA	NA	NA	NA	NA
	12/1/1994	98.58	8.60	89.98	NA	NA	NA	NA	NA	NA
	3/6/1995	98.58	7.68	90.90	490	3	3	3	1	NA
	6/5/1995	98.58	9.59	88.99	8,000	220	330	350	660	NA
	10/2/1995	98.58	13.42	85.16	46,000	160	130	93	240	NA
	1/3/1996	98.58	9.93	88.65	46,000	160	130	93	240	NA
	4/3/1996	98.58	8.13	90.45	27,000	0.1	92	44	13	NA
	12/9/1996	98.58	11.67	86.91	6,200	11	7	2	14	ND
	4/10/1997	98.58	11.40	87.18	53,000	150	110	37	0.12	ND
	12/30/1997	98.58	9.04	89.54	35,000	4,900	4,900	1,600	7,000	NA
	6/30/1998	98.58	NM	NM	25,000	2,000	2,000	1,300	4,300	NA
	9/29/1998	98.58	13.58	85.00	29,000	290	180	160	360	<0.5
	12/16/1998	98.58	10.94	87.64	26,000	1,400	1,600	880	9,500	<5
	3/16/1999	98.58	7.60	90.98	7,600	730	830	610	1,900	55
	6/10/1999	98.58	11.24	87.34	3,500	290	428	211	744	ND
	8/23/1999	98.58	13.50	85.08	60	6	9	4	11	ND
	11/9/1999	98.58	14.10	84.48	<50	<5	<5	<5	<5	<5
	2/7/2000	98.58	9.85	88.73	6,400	372	639	46	134	8
	5/31/2000	98.58	10.88	87.70	2,930	130	330	130	570	<5
	8/9/2000	98.58	13.03	85.55	<50	<5	<5	<5	<5	<5
	11/2/2000	98.58	12.60	85.98	ND	ND	ND	ND	ND	ND
	3/13/2001	98.58	8.55	90.03	932	18	34	1.3	225	ND
	5/22/2001	98.58	11.00	87.58	870	37	75	55	179	2.7
8/8/2001	98.58	13.53	85.05	125	4	4	3	11	ND	
11/19/2001	98.58	13.43	85.15	470	13	64	22	83	14	
2/21/2002	98.58	8.99	89.59	1,700	26	180	95	360	<2	
5/7/2002	98.58	10.59	87.99	1,800	31	140	110	348	<2	
7/30/2002	40.71	12.70	28.01	180	11	6.3	9.4	27	<2.0	
10/2/2002	40.71	14.23	26.48	<50	<0.5	<0.5	<0.5	0.64	<2.0	

Table 1
Historical Groundwater Elevation Data & Analytical Results
3609 International Boulevard, Oakland, California

Monitoring Well	Date	Top Of Casing Elevation ¹ (feet)	Depth to Groundwater (feet)	Groundwater Elevation (feet)	TPH-g (µg/L)	Benzene (µg/L)	Toluene (µg/L)	Ethyl-Benzene (µg/L)	Total Xylenes (µg/L)	MtBE ² EPA 8260B (µg/L)
MW-2 cont.	1/3/2003	40.71	8.66	32.05	510	5	30.0	24.0	92	<2.0
	5/3/2003	40.71	9.17	31.54	1,300	14	88.0	78.0	271	<2.0
	7/24/2003	40.71	12.23	28.48	220	3.9	4.3	7	14.5	<2.0
	10/22/2003	40.71	13.65	27.06	170 H	1.9	<0.5	2.2	2.2	<2.0
	1/22/2004	40.71	9.54	31.17	860	7.2	37	50	151	<2.0
	4/1/2004	40.71	10.80	29.91	730	6.6	19	38	87	<2.0
	8/20/2004	40.71	13.54	27.17	220	2.2	1.9	7	11.7	<0.5
	12/8/2004	40.71	10.52	30.19	99	1.7	3.3	8.3	25.1	<0.5
	3/15/2005	40.71	8.06	32.65	5,690	18.7	120	315	876	<1.0
	5/17/2005	40.71	9.10	31.61	6,320	12.5	75	429	557	<2.15
	7/14/2005	40.71	11.10	29.61	7,680	14.1	46.3	522	471	<2.15
	10/13/2005	40.71	13.25	27.46	562	4.25	3.28	15	8.29	<0.50
	1/3/2006	40.71	6.72	33.99	340	2.5	4.4	22	50.2	<0.5
	4/7/2006	40.71	5.75	34.96	6,160	24	84.8	385	474	<2.15
	9/7/2006	40.71	12.58	28.13	114	2.45	<2.0	8.62	6.85	<0.5
	11/29/2006	40.71	12.26	28.45	293	5.02	3.25	24	15.15	<0.5
	2/27/2007	40.71	8.78	31.93	3,190	18.30	49.20	396	466	<1.0
	5/23/2007	40.71	11.09	29.62	<50.0	<0.500	<2.00	6.22	4.68	<0.500
	8/21/2007	40.71	13.31	27.40	241	3.12	<2.00	17.6	7.59	<0.500
	11/16/2007	40.71	12.59	28.12	61.1	5.09	<2.00	1.67	<2.00	<0.5
	2/21/2008	40.71	8.56	32.15	<50	<0.5	<2.00	1.41	<2.00	<0.5
	5/7/2008	40.71	11.81	28.90	1,510	3.80	5.55	135	92.18	<0.5
	8/6/2008	40.71	13.39	27.32	1,900	4.6	6.7	98	114.7	<0.5
	11/4/2008	40.71	13.49	27.22	NA	NA	NA	NA	NA	NA
	3/24/2009	40.71	9.23	31.48	NA	NA	NA	NA	NA	NA
	6/8/2009	40.71	11.70	29.01	NA	NA	NA	NA	NA	NA
MW-3	10/5/1994	97.78	15.79	81.99	3,000,000	190,000	740,000	310,000	130,000	NA
	12/2/1994	97.78	9.79	87.99	250,000	19,000	22,000	4,400	28,000	NA
	3/6/1995	97.78	8.69	89.09	350,000	20,000	42,000	5,800	36,000	NA
	6/5/1995	97.78	10.25	87.53	350,000	20,000	42,000	5,800	36,000	NA
	10/2/1995	97.78	12.91	84.87	150,000	510	410	210	65	NA
	1/3/1996	97.78	10.55	87.23	150,000	510	410	210	650	NA
	4/3/1996	97.78	8.76	89.02	NA	NA	NA	NA	NA	NA
	12/3/1996	97.78	12.02	85.76	NA	NA	NA	NA	NA	NA

Table 1
Historical Groundwater Elevation Data & Analytical Results
3609 International Boulevard, Oakland, California

Monitoring Well	Date	Top Of Casing Elevation ¹ (feet)	Depth to Groundwater (feet)	Groundwater Elevation (feet)	TPH-g (µg/L)	Benzene (µg/L)	Toluene (µg/L)	Ethyl-Benzene (µg/L)	Total Xylenes (µg/L)	MtBE ² EPA 8260B (µg/L)
MW-3 cont.	4/1/1997	97.78	11.73	86.05	NA	NA	NA	NA	NA	NA
	12/1/1997	97.78	NM	NM	NA	NA	NA	NA	NA	NA
	9/1/1998	97.78	14.68	83.10	NA	NA	NA	NA	NA	NA
	12/16/1998	97.78	11.55	86.23	51,000	5,700	3,900	1,200	6,300	410
	3/16/1999	97.78	8.44	89.34	45,000	4,100	6,400	1,000	6,100	470
	6/10/1999	97.78	11.8	85.98	46,000	8,245	6,425	1,015	7,173	274
	8/23/1999	97.78	13.85	83.93	64,000	7,484	8,052	1,744	9,749	141
	11/9/1999	97.78	14.7	83.08	26,000	3,218	1,319	<5	6,697	126
	2/7/2000	97.78	10.95	86.83	44,000	6,090	3,360	<5	5,780	276
	5/31/2000	97.78	11.68	86.10	68,000	15,000	8,900	1,500	7,400	<5
	8/9/2000	97.78	13.73	84.05	76,000	8,900	5,636	883	7,356	176
	11/2/2000	97.78	13.4	84.38	48,000	6,789	4,816	676	7,258	83
	3/13/2001	97.78	9.43	88.35	14,754	2,250	140	ND	1,284	110
	5/22/2001	97.78	11.81	85.97	44,000	5,400	3,100	1,400	6,400	200
	8/8/2001	97.78	14.1	83.68	41,750	3,485	2,670	1,255	5,420	52
	11/19/2001	97.78	14.32	83.46	NA	NA	NA	NA	NA	NA
	2/21/2002	97.78	10.01	87.77	62,000	6,000	7,600	1,900	9,200	12,000
	5/7/2002	97.78	11.28	86.50	54,000	6,700	3,200	1,800	7,100	9,100
	7/30/2002	40.91	13.25	27.66	45,000	8,900	1,700	1,600	5,600	2,600
	10/2/2002	40.91	14.98	25.93	70,000	4,900	5,100	2,100	11,900	21,000
	1/3/2003	40.91	9.79	31.12	35,000	2,900	1,300	860	5,200	13,000
	5/3/2003	40.91	10.01	30.90	48,000	5,800	1,400	1,600	7,400	5,900
	7/24/2003	40.91	12.94	27.97	31,000	4,700	990	1,400	5,200	16,000
	10/22/2003	40.91	14.29	26.62	30,000	4,400	930	1,600	5,400	7,400
	1/22/2004	40.91	10.57	30.34	45,000	2,100	850	1,500	5,700	2,900
	4/1/2004	40.91	11.84	29.07	31,000	4,200	590	1,600	4,370	900
	8/20/2004	40.91	14.24	26.67	21,000	3,400	370	1,000	2,350	1,100
	12/8/2004	40.91	11.32	29.59	6,441	978	109	490	941	201
	3/16/2005	40.91	8.87	32.04	22,300	1,280	456	729	1,870	2,400
	5/17/2005	40.91	9.96	30.95	17,600	764	302	735	1,227	1,800
7/14/2005	40.91	11.50	29.41	34,600	1,390	492	1,460	2,054	1,090	
10/13/2005	40.91	13.78	27.13	15,000	1,290	267	675	838	893	

Table 1
Historical Groundwater Elevation Data & Analytical Results
3609 International Boulevard, Oakland, California

Monitoring Well	Date	Top Of Casing Elevation ¹ (feet)	Depth to Groundwater (feet)	Groundwater Elevation (feet)	TPH-g (µg/L)	Benzene (µg/L)	Toluene (µg/L)	Ethyl-Benzene (µg/L)	Total Xylenes (µg/L)	MtBE ² EPA 8260B (µg/L)
MW-3 cont.	1/3/2006	40.91	7.50	33.41	8,700	650	98	330	860	280
	4/7/2006	40.91	6.74	34.17	16,800	677	239	802	1,018	564
	9/8/2006	40.91	12.95	27.96	26,400	1,660	381	933	1,545	332
	11/29/2006	40.91	12.78	28.13	15,100	2,080	381	1,290	1,624	247
	2/27/2007	40.91	9.43	31.48	5,950	1,100	116	531	500	170
	5/24/2007	40.91	11.63	29.28	8,240	1,360	116	540	696	37
	8/21/2007	40.91	13.75	27.16	13,200	2,240	119	868	983	36.4
	11/16/2007	40.91	13.25	27.66	5,490	2,360	52	523	213.9	43
	2/22/2008	40.91	10.07	30.84	7,840	402	64.5	496	430	<1
	5/7/2008	40.91	12.69	28.22	8,180	232	66.7	208	942	5.11
	8/6/2008	40.91	14.09	26.82	3,000	140	21	97	233	1.7
	11/4/2008	40.91	14.16	26.75	9,000	510	250	380	1,460	9.4
	11/13/2008	40.91	NM	NM	7,100	420	70	300	830	7.0
	3/24/2009	40.91	10.21	30.70	76	0.69	<0.5	<0.5	2.29	1.2
		6/8/2009	40.91	12.44	28.47	4,500 ^Y	86	22	99	380
MW-4	1/3/1996	97.85	10.11	87.74	9,300	230	110	10	29	NA
	4/3/1996	97.85	8.35	89.50	1,900	12	8	5	14	NA
	12/9/1996	97.85	11.58	86.27	4,000	14	6	4	12	ND
	4/10/1997	97.85	11.23	86.62	ND	ND	ND	ND	ND	ND
	12/30/1997	97.85	9.43	88.42	2,300	410	270	100	1,500	NA
	6/30/1998	97.85	NM	NM	1,700	780	160	54	200	NA
	9/29/1998	97.85	13.64	84.21	6,200	910	77	68	200	18
	12/16/1998	97.85	11.13	86.72	1,400	590	33	28	94	24
	3/16/1999	97.85	8.46	89.39	600	200	35	19	56	11
	6/10/1999	97.85	11.30	86.55	1,000	298	44	19	64	13
	8/23/1999	97.85	13.20	84.65	660	497	41	54	145	6
	11/9/1999	97.85	14.10	83.75	<50	<5	<5	<5	<5	<5
	2/7/2000	97.85	11.25	86.60	7,800	1,200	61	<5	781	<5
	5/31/2000	97.85	11.46	86.39	552	42	19	16	67	<5
	8/9/2000	97.85	13.35	84.50	370	5.08	<5	<5	<5	<5
	11/2/2000	97.85	13.05	84.80	ND	5.30	ND	ND	8	ND
	3/13/2001	97.85	9.24	88.61	62	ND	ND	3.2	8.7	ND
	5/22/2001	97.85	11.50	86.35	80	12	1.9	4.1	9.8	ND
8/8/2001	97.85	13.80	84.05	133	12	2.2	3.9	9	ND	
11/19/2001	97.85	13.68	84.17	670	180	5	17	53	ND	

Table 1
Historical Groundwater Elevation Data & Analytical Results
3609 International Boulevard, Oakland, California

Monitoring Well	Date	Top Of Casing Elevation ¹ (feet)	Depth to Groundwater (feet)	Groundwater Elevation (feet)	TPH-g (µg/L)	Benzene (µg/L)	Toluene (µg/L)	Ethyl-Benzene (µg/L)	Total Xylenes (µg/L)	MtBE ² EPA 8260B (µg/L)
MW-4 cont.	2/21/2002	97.85	9.97	87.88	450	63	4.1	22	28.7	<2
	5/7/2002	97.85	10.81	87.04	570	72	29	27	74	<2
	7/30/2002	40.01	12.62	27.39	450	20	24	19	74	<2.0
	10/2/2002	40.01	14.34	25.67	320	69	0.99	9	5.49	<2.0
	1/3/2003	40.01	9.79	30.22	310	49	2.5	13	26.7	<2.0
	7/24/2003	40.01	12.44	27.57	<50	1	<0.5	<0.5	<0.5	<0.5
	10/22/2003	40.01	13.72	26.29	70	12	<0.5	4.7	3.0	<2.0
	1/22/2004	40.01	10.55	29.46	230	18	2.1	8.1	17.1	<2.0
	4/1/2004	40.01	11.39	28.62	<50	3.8	<0.5	1.6	1.9	<2.0
	8/20/2004	40.01	13.68	26.33	<50	1.6	<0.5	0.66	0.53	<2.0
	12/7/2004	40.01	10.95	29.06	<50	1.3	<0.5	2.80	<1.0	<0.5
	3/15/2005	40.01	8.61	31.40	661	72	4.13	39.7	48.42	<0.5
	MW-4R	5/17/2005	40.34	9.88	30.46	7,780	170	11.1	192	121.2
7/14/2005		40.34	11.61	28.73	847	25.3	<2.0	28.2	10.9	<0.5
10/13/2005		40.34	13.73	26.61	785	35.5	<2.0	48.2	8.35	<0.50
1/3/2006		40.34	9.18	31.16	2,500	65	3.8	70	62	<0.5
4/6/2006		40.34	7.70	32.64	852	42.4	2.25	28.4	17.13	<0.5
9/7/2006		40.34	12.96	27.38	97.7	9.29	<2.0	4.05	1.03	<0.5
11/28/2006		40.34	12.70	27.64	914	87	<2.0	15.10	10.40	<0.5
2/26/2007		40.34	9.78	30.56	561	38.4	<2.0	41.30	9.67	<0.5
5/23/2007		40.34	11.36	28.98	351	35.8	<2.0	23.20	4.82	<0.5
8/20/2007		40.34	13.45	26.89	223	24.7	<2.0	9.15	2.54	<0.5
11/15/2007		40.34	13.01	27.33	1,740	94.5	<2.0	41	15.52	<0.5
2/22/2008		40.34	9.68	30.66	122	8.12	<2.0	3.14	<2.0	<0.5
5/6/2008		40.34	12.17	28.17	68.9	3.12	<2.0	0.65	<2.0	<0.5
8/5/2008		40.34	13.58	26.76	630	33	0.59	13	2	<0.5
11/4/2008		40.34	13.81	26.53	NA	NA	NA	NA	NA	NA
3/24/2009		40.34	10.10	30.24	NA	NA	NA	NA	NA	NA
6/8/2009		40.34	12.22	28.12	NA	NA	NA	NA	NA	NA
MW-5	10/2/1995	99.04	13.57	85.47	1,500	1	1	4	5	NA
	1/3/1996	99.04	10.03	89.01	1,500	1	1	4	5	NA
	4/3/1996	99.04	8.24	90.80	780	1	1	5	4	NA
	12/9/1996	99.04	11.48	87.56	NA	NA	NA	NA	NA	NA
	4/10/1997	99.04	11.35	87.69	NA	NA	NA	NA	NA	NA

Table 1
Historical Groundwater Elevation Data & Analytical Results
3609 International Boulevard, Oakland, California

Monitoring Well	Date	Top Of Casing Elevation ¹ (feet)	Depth to Groundwater (feet)	Groundwater Elevation (feet)	TPH-g (µg/L)	Benzene (µg/L)	Toluene (µg/L)	Ethyl-Benzene (µg/L)	Total Xylenes (µg/L)	MtBE ² EPA 8260B (µg/L)
MW-5 cont.	12/30/1997	99.04	9.15	89.89	790	82	66	59	160	NA
	6/30/1998	99.04	NM	NM	400	<5	<5	15	<10	NA
	9/29/1998	99.04	13.82	85.22	270	2	1	3	3	<.5
	12/16/1998	99.04	11.20	87.84	1,400	1	1	ND	2	ND
	3/16/1999	99.04	7.73	91.31	650	3	1	16	2	10
	6/10/1999	99.04	11.50	87.54	270	4	3	6	4	ND
	8/23/1999	99.04	13.55	85.49	120	ND	4	ND	4	ND
	11/9/1999	99.04	14.30	84.74	<50	<5	<5	<5	<5	<5
	2/7/2000	99.04	9.85	89.19	70	<5	<5	<5	7	<5
	5/31/2000	99.04	11.03	88.01	627.4	7.4	24	12	32.4	<5
	8/9/2000	99.04	13.22	85.82	<50	<5	<5	<5	<5	<5
	11/2/2000	99.04	13.55	85.49	ND	ND	ND	ND	ND	ND
	3/13/2001	99.04	8.67	90.37	382	6.1	1.9	6.6	5.9	ND
	5/22/2001	99.04	11.12	87.92	180	ND	ND	2.1	0.57	4.4
	8/8/2001	99.04	13.79	85.25	258	1	1.1	3.4	7.3	1.4
	11/19/2001	99.04	13.72	85.32	920	17	160	26	135	40
	2/21/2002	99.04	9.04	90.00	290	3.5	2	6.2	6.2	<0.5
	5/7/2002	99.04	10.69	88.35	160	<0.5	0.78 C	2	2.15	2.3
	7/30/2002	41.16	12.94	28.22	110	<0.5	<0.5	0.77	<0.5	<0.5
	10/20/2002	41.16	14.51	26.65	77	<0.5	<0.5	<0.5	<0.5	<2.0
	1/3/2003	41.16	8.73	32.43	450 Y	<0.5	<0.5	4	0.54	2.1
	5/3/2003	41.16	9.24	31.92	130	<0.5	<0.5	1	<0.5	3.1
	7/24/2003	41.16	12.45	28.71	300	<0.5	1.9 C	0.76	<0.5	<2.0
	10/22/2003	41.16	13.89	27.27	460 H	<0.5	<0.5	<0.5	<0.5	1.9
	1/22/2004	41.16	9.60	31.56	160	<0.5	<0.5	0.55 C	<0.5	<5.0
	4/1/2004	41.16	11.06	30.10	280	<0.5	0.74C	0.62	<0.5	2.1
8/20/2004	41.16	13.75	27.41	250	<0.5	<0.5	<0.5	<0.5	2	
12/7/2004	41.16	10.73	30.43	150	<0.5	<0.5	<0.5	<1.0	2.6	

Table 1
Historical Groundwater Elevation Data & Analytical Results
3609 International Boulevard, Oakland, California

Monitoring Well	Date	Top Of Casing Elevation ¹ (feet)	Depth to Groundwater (feet)	Groundwater Elevation (feet)	TPH-g (µg/L)	Benzene (µg/L)	Toluene (µg/L)	Ethyl-Benzene (µg/L)	Total Xylenes (µg/L)	MtBE ² EPA 8260B (µg/L)
MW-5 cont.	3/15/2005	41.16	8.18	32.98	496	<0.5	<0.5	<0.5	<1.0	1.91
	5/17/2005	41.16	9.22	31.94	360	<0.5	<0.5	<0.5	<1.0	1.72
	7/14/2005	41.16	11.30	29.86	267	<0.5	<2.0	<0.5	<1.0	1.74
	10/13/2005	41.16	13.57	27.59	404	<0.50	<2.0	<0.50	<1.0	0.93
	1/3/2006	41.16	6.81	34.35	170	2.2	<0.5	1.8	3.1	1.1
	4/7/2006	41.16	5.81	35.35	449	<0.5	<2.0	0.53	<1.0	1.16
	9/7/2006	41.16	12.78	28.38	185	<0.5	<2.0	2.02	<1.0	<0.5
	11/28/2006	41.16	12.62	28.54	158	0.64	<2.0	<0.5	<2.0	<0.5
	2/26/2007	41.16	8.92	32.24	78.2	<0.5	<2.0	<0.5	<2.0	0.52
	5/23/2007	41.16	11.36	29.80	58.4	<0.5	<2.0	4.36	<2.0	<0.5
	8/20/2007	41.16	13.52	27.64	82.4	0.52	<2.0	4.49	2.3	<0.5
	11/16/2007	41.16	12.74	28.42	<50	3.45	<2.00	<0.5	<2.0	0.58
	2/21/2008	41.16	8.67	32.49	131	<0.5	<2.0	<0.5	<2.0	<0.5
	5/6/2008	41.16	12.06	29.10	300	<0.5	<2.0	<0.5	<2.0	0.52
	8/5/2008	41.16	13.64	27.52	<50	<0.5	<0.5	<0.5	<0.5	<0.5
	11/4/2008	41.16	13.68	27.48	NA	NA	NA	NA	NA	NA
	3/24/2009	41.16	9.31	31.85	NA	NA	NA	NA	NA	NA
6/8/2009	41.16	11.92	29.24	NA	NA	NA	NA	NA	NA	
MW-6	10/1/1995	98.77	13.94	84.83	NA	NA	NA	NA	NA	NA
	1/1/1996	98.77	10.55	88.22	120,000	350	310	200	610	NA
	4/1/1996	98.77	8.76	90.01	NA	NA	NA	NA	NA	NA
	12/1/1996	98.77	12.04	86.73	NA	NA	NA	NA	NA	NA
	4/1/1997	98.77	11.76	87.01	NA	NA	NA	NA	NA	NA
	12/1/1997	98.77	9.30	89.47	NA	NA	NA	NA	NA	NA
	9/1/1998	98.77	14.10	84.67	NA	NA	NA	NA	NA	NA
	12/1/1998	98.77	11.60	87.17	NA	NA	NA	NA	NA	NA
	3/16/1999	98.77	8.40	90.37	37,000	3,900	4,300	1,600	7,000	180
	6/10/1999	98.77	11.90	86.87	18,500	2,060	1,650	735	3,170	ND
	8/23/1999	98.77	13.90	84.87	42,000	3,806	3,649	1,554	7,996	10
	11/9/1999	98.77	14.75	84.02	40,000	1,084	130	<5	10,940	<5
	2/7/2000	98.77	10.95	87.82	17,000	1,360	521	<5	4,150	6
8/9/2000	98.77	13.78	84.99	24,000	1,306	870	<5	5,162	<5	
11/2/2000	98.77	13.40	85.37	19,000	1,387	618	ND	5,250	ND	

Table 1
Historical Groundwater Elevation Data & Analytical Results
3609 International Boulevard, Oakland, California

Monitoring Well	Date	Top Of Casing Elevation ¹ (feet)	Depth to Groundwater (feet)	Groundwater Elevation (feet)	TPH-g (µg/L)	Benzene (µg/L)	Toluene (µg/L)	Ethyl-Benzene (µg/L)	Total Xylenes (µg/L)	MtBE ² EPA 8260B (µg/L)
MW-6 cont.	3/13/2001	98.77	9.49	89.28	15,637	713	459	238	2,363	ND
	5/22/2001	98.77	11.82	86.95	27,000	760	450	1,600	4,270	ND
	8/8/2001	98.77	NM	NM	NA	NA	NA	NA	NA	NA
	11/19/2001	98.77	NM	NM	NA	NA	NA	NA	NA	NA
	2/21/2002	98.77	9.92	88.85	14,000	440	180	750	1,020	<10
	5/7/2002	98.77	11.33	87.44	10,000	400	160	470	970	<2
	7/30/2002	40.92	13.28	27.64	24,000	1,000	410	1,400	3,770	<20
	10/20/2002	40.92	14.93	25.99	22,000	1,200	620	1,300	2,800	<20
	1/3/2003	40.92	9.78	31.14	12,000	730	230	740	1,690	<20
	5/3/2003	40.92	9.92	31.00	150,000 H	1,400	780	2,500	8,700	<40
	7/24/2003	40.92	12.98	27.94	29,000	1,600	520	1,500	4,400	<200
	10/22/2003	40.92	14.35	26.57	36,000	1,300	430	1,600	4,570	<40
	1/22/2004	40.92	10.60	30.32	30,000	1,300	320	1,500	3,040	<50
	4/1/2004	40.92	11.80	29.12	99,000	1,700	580 C	2,200	5,200	<50
	8/20/2004	40.92	14.36	26.56	12,000	580	130	520	1,020	<10
	12/8/2004	40.92	11.22	29.70	12,631	649	134	1,009	2,037	<2.15
	3/16/2005	40.92	8.94	31.98	18,300	546	126	705	1,069	<2.15
	5/17/2005	40.92	10.02	30.90	38,500	1,290	395	1,550	1,652	<5.50
	7/15/2005	40.92	11.78	29.14	50,100	1,510	409	1,900	1,920	<5.50
	10/13/2005	40.92	14.04	26.88	9,620	513	97.4	523	422.3	<2.15
	1/3/2006	40.92	7.86	33.06	13,000	260	79.0	680	750	<4.2
	4/7/2006	40.92	6.93	33.99	18,200	650	151	918	715	<5.5
	9/8/2006	40.92	13.12	27.80	18,600	604	98.80	639	659	<2.15
	11/28/2006	40.92	12.95	27.97	20,300	656	96.30	1,060	760	7.86
	2/27/2007	40.92	9.68	31.24	8,440	249	36.30	697	316.8	<2.15
	5/24/2007	40.92	11.59	29.33	11,400	292	34.8	493	278.5	<2.15
8/21/2007	40.92	13.88	27.04	9,480	727	87.6	761	590	<2.15	
11/16/2007	40.92	13.29	27.63	5,430	436	29.8	439	147.8	<2.15	
2/22/2008	40.92	9.41	31.51	4,870	100	9.56	331	76.9	<1.0	
5/7/2008	40.92	12.47	28.45	8,700	125	10.3	365	209.3	<1.0	
8/6/2008	40.92	13.98	26.94	7,900	82	6.9	300	126.3	<2.0	
11/4/2008	40.92	14.24	26.68	11,000	880	260	770	1,240	<6.3	
11/13/2008	40.92	NM	NM	16,000	1,000	300	950	1,400	<2.0	

Table 1
Historical Groundwater Elevation Data & Analytical Results
3609 International Boulevard, Oakland, California

Monitoring Well	Date	Top Of Casing Elevation ¹ (feet)	Depth to Groundwater (feet)	Groundwater Elevation (feet)	TPH-g (µg/L)	Benzene (µg/L)	Toluene (µg/L)	Ethyl-Benzene (µg/L)	Total Xylenes (µg/L)	MtBE ² EPA 8260B (µg/L)
MW-6 cont.	3/24/2009	40.92	10.13	30.79	3,400	160	89	470	495	<3.1
	6/8/2009	40.92	12.48	28.44	19,000 ^Y	450	240	970	1,960	<6.3
MW-7	10/2/1995	97.83	12.95	84.88	NA	10	12	17	NA	3,300
	1/3/1996	97.83	9.57	88.26	3,300	9	12	17	45	NA
	4/3/1996	97.83	7.75	90.08	1,900	2	3	5	7	NA
	12/9/1996	97.83	10.97	86.86	NA	NA	NA	NA	NA	NA
	4/10/1997	97.83	12.95	84.88	NA	NA	NA	NA	NA	NA
	12/30/1997	97.83	8.65	89.18	1,400	130	98	75	200	NA
	6/30/1998	97.83	NM	NM	620	4	<5	9	<10	NA
	9/29/1998	97.83	13.09	84.74	1,800	1	1	1	2	68
	12/16/1998	97.83	10.52	87.31	990	5	10	5	20	160
	3/16/1999	97.83	7.00	90.83	300	3	1	1	1	62
	6/10/1999	97.83	10.70	87.13	320	3	7	4	3	26
	8/23/1999	97.83	12.80	85.03	570	5	10	ND	ND	ND
	11/9/1999	97.83	13.25	84.58	290	<5	9	<5	<5	12
	2/7/2000	97.83	9.50	88.33	80	<5	<5	<5	<5	23
	5/31/2000	97.83	10.52	87.31	494.9	4.9	22	4.2	21.9	29
	8/9/2000	97.83	12.63	85.20	80	<5	<5	<5	<5	11.7
	11/2/2000	97.83	11.95	85.88	50	ND	ND	ND	ND	9.1
	3/13/2001	97.83	8.04	89.79	82	0.97	ND	0.76	ND	78
	5/22/2001	97.83	10.60	87.23	370	ND	9.1	1.3	2.3	28
	8/8/2001	97.83	13.02	84.81	610	3.7	3	6.2	18.9	10
	11/19/2001	97.83	12.83	85.00	1,700	24	220	41	205	69
	2/21/2002	97.83	8.91	88.92	380	<0.5	2.5	2	3.8	78
	5/7/2002	97.83	10.13	87.70	560	15	28.0	9.2	44.0	37
7/30/2002	39.94	12.15	27.79	270	5.3	1.3 C	2.3	8.1	46	
10/20/2002	39.94	13.74	26.20	350	<0.5	2.1 C	<0.5	3.1 C	43	
1/3/2003	39.94	8.45	31.49	220 Y	<0.5	<0.5	0.78	0.55	19	
5/3/2003	39.94	7.69	32.25	280	<0.5	<0.5	<0.5	<0.5	11	
7/24/2003	39.94	11.72	28.22	230	<0.5	1.3 C	<0.5	0.63	5.9	
10/22/2003	39.94	13.10	26.84	460	<0.5	<0.5	<0.5	<0.5	5.0	

Table 1
Historical Groundwater Elevation Data & Analytical Results
3609 International Boulevard, Oakland, California

Monitoring Well	Date	Top Of Casing Elevation ¹ (feet)	Depth to Groundwater (feet)	Groundwater Elevation (feet)	TPH-g (µg/L)	Benzene (µg/L)	Toluene (µg/L)	Ethyl-Benzene (µg/L)	Total Xylenes (µg/L)	MtBE ² EPA 8260B (µg/L)
MW-7 cont.	1/22/2004	39.94	9.23	30.71	380	<0.5	1.4 C	<0.5	<0.5	<5.0
	4/1/2004	39.94	10.40	29.54	480	<0.5	2.5 C	<0.5	0.90	0.62
	8/20/2004	39.94	12.92	27.02	410	<0.5	.81 C	<0.5	<0.5	1.70
	12/7/2004	39.94	10.28	29.66	96	<0.5	<0.5	<0.5	<1.0	<0.5
	3/16/2005	39.94	7.44	32.50	209	<0.5	<0.5	<0.5	<1.0	1.74
	5/16/2005	39.94	8.53	31.41	262	4.85	2.19	2.36	4.24	0.73
	7/14/2005	39.94	10.61	29.33	753	20.6	11.9	16.8	33.23	2.36
	10/13/2005	39.94	12.80	27.14	1,690	5.3	2.71	12.6	54	1.93
	1/3/2006	39.94	6.39	33.55	250 Y	0.80	<0.5	0.61	<0.5	1.1
	4/7/2006	39.94	8.10	31.84	3,440	0.64	<2.0	17	<1.0	<0.5
	9/7/2006	39.94	14.52	25.42	320	2.87	<2.0	4.76	1.34	<0.5
	11/28/2006	39.94	12.17	27.77	774	1.81	<2.0	6.76	3.03	<0.5
	2/26/2007	39.94	10.41	29.53	1,240	<0.5	<2.0	6.83	<2.0	<0.5
	5/23/2007	39.94	10.16	29.78	265	<0.5	<2.0	5.38	<2.0	<0.5
	8/20/2007	39.94	12.98	26.96	<50.0	0.78	<2.0	4.87	2.36	<0.5
	11/15/2007	39.94	12.45	27.49	135	<0.5	<2.00	0.54	<2.0	<0.5
	2/21/2008	39.94	8.79	31.15	<50	3.18	<2.0	1.69	<2.0	<0.5
	5/6/2008	39.94	11.31	28.63	<50	<0.5	<2.0	<0.5	<2.0	<0.5
	8/5/2008	39.94	13.03	26.91	<50	<0.5	<0.5	<0.5	0.91	<0.5
	11/4/2008	39.94	13.19	26.75	NA	NA	NA	NA	NA	NA
3/24/2009	39.94	9.11	30.83	NA	NA	NA	NA	NA	NA	
	6/8/2009	39.94	11.15	28.79	NA	NA	NA	NA	NA	NA
MW-8	10/2/1995	97.25	12.86	84.39	NA	NA	NA	NA	NA	NA
	1/3/1996	97.25	9.79	87.46	94,000	310	250	180	480	NA
	4/3/1996	97.25	7.98	89.27	58,000	250	170	140	330	NA
	12/9/1996	97.25	11.13	86.12	27,000	88	43	44	80	ND
	4/10/1997	97.25	12.95	84.30	24,000	86	55	50	100	ND
	12/30/1997	97.25	8.95	88.30	28,000	6,000	1,600	2,100	4,700	NA
	6/30/1998	97.25	NM	NM	54,000	4,600	2,800	3,500	7,300	NA
	9/29/1998	97.25	13.02	84.23	NA	NA	NA	NA	NA	NA
	12/16/1998	97.25	10.75	86.50	61,000	6,300	1,700	2,200	4,400	1,300
	3/16/1999	97.25	7.58	89.67	22,000	1,800	470	2,000	2,000	820
	6/10/1999	97.25	10.80	86.45	39,500	3,610	1,635	2,175	5,913	988
	8/23/1999	97.25	12.75	84.50	58,000	5,379	2,438	3,001	6,960	639
	11/9/1999	97.25	13.65	83.60	10,500	92	<5	<5	3,414	769

Table 1
Historical Groundwater Elevation Data & Analytical Results
3609 International Boulevard, Oakland, California

Monitoring Well	Date	Top Of Casing Elevation ¹ (feet)	Depth to Groundwater (feet)	Groundwater Elevation (feet)	TPH-g (µg/L)	Benzene (µg/L)	Toluene (µg/L)	Ethyl-Benzene (µg/L)	Total Xylenes (µg/L)	MtBE ² EPA 8260B (µg/L)
MW-8 cont.	2/7/2000	97.25	10.85	86.40	44,200	1,080	617	<5	4,160	240
	5/31/2000	97.25	11.15	86.10	25,940	940	130	1,600	3,960	75
	8/9/2000	97.25	12.87	84.38	22,000	632	5.38	<5	2,686	37.3
	11/2/2000	97.25	12.55	84.70	3,000	278	350	209	980	21
	3/13/2001	97.25	8.75	88.50	2,360	81	16	71	270	221
	8/8/2001	97.25	12.97	84.28	5,620	153	46	373	345	174
	11/19/2001	97.25	13.19	84.06	13,000	600	270	750	1,200	400
	2/21/2002	97.25	9.88	87.37	240,000	1,400	<25	4,200	6,560	<100
	5/7/2002	97.25	10.32	86.93	9,000	360	56	560	622	2,100
	7/30/2002	39.38	11.79	27.59	8,400	340	78	530	517	1,200
	10/20/2002	39.38	13.80	25.58	18,000	950	75	1,400	1,269	700
	1/3/2003	39.38	9.48	29.90	8,100	300	29	370	302	1,100
	5/3/2003	39.38	9.48	29.90	18,000	380	33 C	1,000	516	540
	7/24/2003	39.38	11.92	27.46	12,000	460	54 C	910	435	890
	10/22/2003	39.38	13.09	26.29	16,000	830	87	2,000	675	280
	1/22/2004	39.38	10.32	29.06	18,000	330	37 C	860	239	500
	4/1/2004	39.38	11.23	28.15	12,000	240	26 C	650	128.8 C	<4
	8/20/2004	39.38	13.02	26.36	6,000	310	27	660	56.8 C	<4
	12/8/2004	39.38	10.79	28.59	6,650	171	15	360	35	166
	3/15/2005	39.38	7.62	31.76	11,400	125	21	418	55.3	865
	5/16/2005	39.38	9.15	30.23	10,100	122	13.2	440	34.73	406
	7/14/2005	39.38	10.81	28.57	11,600	213	27.8	854	71.51	184
	10/13/2005	39.38	12.81	26.57	6,590	256	27.7	655	48.50	375
	1/3/2006	39.38	7.40	31.98	4,800	53	5.2	130	21	210
	4/6/2006	39.38	6.04	33.34	8,240	82.5	14.6	364	28.06	771
	9/7/2006	39.38	12.15	27.23	4,130	86.80	7.32	173	19.73	48.60
	11/28/2006	39.38	11.92	27.46	3,680	198	15.10	313	23.82	149
	2/27/2007	39.38	8.52	30.86	5,690	122	15.10	455	33.62	203
	5/24/2007	39.38	10.79	28.59	3,400	32.60	4.35	177	14.65	69.5
	8/20/2007	39.38	12.71	26.67	1,310	58.60	4.22	106	7.20	26.8
11/15/2007	39.38	12.13	27.25	10,300	169	11.1	281	12.0	60.4	
2/22/2008	39.38	8.51	30.87	5,130	33.3	4.12	218	5.87	<0.5	
5/6/2008	39.38	11.41	27.97	3,490	20.3	2.38	90.3	0.77	21.8	
8/5/2008	39.38	12.82	26.56	2,900	97	11	170	17	13	
11/4/2008	39.38	13.11	26.27	2,900	110	15	420	25	10	

Table 1
Historical Groundwater Elevation Data & Analytical Results
3609 International Boulevard, Oakland, California

Monitoring Well	Date	Top Of Casing Elevation ¹ (feet)	Depth to Groundwater (feet)	Groundwater Elevation (feet)	TPH-g (µg/L)	Benzene (µg/L)	Toluene (µg/L)	Ethyl-Benzene (µg/L)	Total Xylenes (µg/L)	MtBE ² EPA 8260B (µg/L)
MW-8 cont.	3/24/2009	39.38	9.29	30.09	3,000	21	2.8	90	17.81	6.1
	6/8/2009	39.38	11.38	28.00	6,700 ^Y	81	22	420	283	3.9
MW-10	12/1/1996	94.54	10.44	84.10	NA	NA	NA	NA	NA	NA
	4/10/1997	94.54	10.07	84.47	1,000	21	9	3	3	ND
	12/30/1997	94.54	8.78	85.76	10,000	5,300	76	1,100	780	NA
	9/29/1998	94.54	11.93	82.61	9,900	5,400	66	970	620	2,600
	12/16/1998	94.54	10.19	84.35	8,700	3,800	51	790	420	1,800
	3/16/1999	94.54	7.30	87.24	4,100	15	28	420	250	2,800
	6/10/1999	94.54	9.95	84.59	4,200	1,168	34	264	154	1,195
	8/23/1999	94.54	11.60	82.94	3,250	2,135	97	600	248	1,800
	11/9/1999	94.54	12.50	82.04	2,950	1,134	20	<5	70	652
	2/7/2000	94.54	9.25	85.29	<50	<5	<5	<5	<5	448
	5/31/2000	94.54	9.45	85.09	4,400	1,500	25	390	107.1	580
	8/9/2000	94.54	11.52	83.02	6,800	1,055	26	54	53.8	1,283
	11/2/2000	94.54	11.35	83.19	ND	ND	ND	ND	ND	145
	3/13/2001	94.54	8.07	86.47	4,935	969	18	41	72	630
	5/22/2001	94.54	9.80	84.74	2,900	630	11	200	31	270
	8/8/2001	94.54	11.64	82.90	242	35	1	11	2	64
	11/19/2001	94.54	12.06	82.48	3,500	900	260	310	258	410
	2/21/2002	94.54	8.28	86.26	4,700	1,100	20	370	63.7	500
	5/7/2002	94.54	9.49	85.05	3,400	660	13	260	48.0	270
	7/30/2002	36.71	10.93	25.78	160	26	0.55	8.1	1.0	72
	10/20/2002	36.71	12.54	24.17	550	130	3.00	31.0	2.7	70
	1/3/2003	36.71	8.23	28.48	17,000	870	11	290	27	270
	5/3/2003	36.71	8.30	28.41	2,500	650	10	190	15.81 C	180
	7/24/2003	36.71	10.76	25.95	750	160	4	58	6.66 C	79
	10/22/2003	36.71	11.91	24.80	2,000	410	11	170	9.14 C	110
	1/22/2004	36.71	8.91	27.80	4,000	600	15	280	15.3 C	110
	4/1/2004	36.71	9.62	27.09	5,100	580	<1	330	26.4	160
	8/20/2004	36.71	11.50	25.21	3,400	550	13	240	17.0	100
12/7/2004	36.71	9.29	27.42	2,524	556	10	184	16.0	144	
3/15/2005	36.71	7.48	29.23	4,340	354	6.07	166	17.1	258	
5/16/2005	36.71	8.24	28.47	4,750	415	6.87	254	10.4	126	
7/14/2005	36.71	9.78	26.93	6,050	594	9.53	297	10.7	190	
10/13/2005	36.71	11.32	25.39	6,230	811	11.3	355	5.6	167	

Table 1
Historical Groundwater Elevation Data & Analytical Results
3609 International Boulevard, Oakland, California

Monitoring Well	Date	Top Of Casing Elevation ¹ (feet)	Depth to Groundwater (feet)	Groundwater Elevation (feet)	TPH-g (µg/L)	Benzene (µg/L)	Toluene (µg/L)	Ethyl-Benzene (µg/L)	Total Xylenes (µg/L)	MtBE ² EPA 8260B (µg/L)	
MW-10 cont.	1/3/2006	36.71	6.81	29.90	2,000	350	6.0	210	16	88	
	4/6/2006	36.71	6.03	30.68	600	86.5	<2.0	59.1	2.36	30.4	
	9/7/2006	36.71	10.90	25.81	6,960	360	<8.60	253	11.30	103	
	11/28/2006	36.71	10.92	25.79	2,800	305	<8.6	228	<8.6	72.8	
	2/26/2007	36.71	8.02	28.69	9,470	1,400	29.3	1,260	32.60	263.0	
	5/23/2007	36.71	9.54	27.17	860	138	2.45	69.2	4.65	30.9	
	8/20/2007	36.71	11.47	25.24	86.6	2.88	<2.00	5.98	2.30	2.68	
	11/15/2007	36.71	11.12	25.59	492	104	<2.00	41.2	<2.0	18.7	
	2/21/2008	36.71	7.85	28.86	2,040	228	4.44	193	2.68	11	
	5/6/2008	36.71	10.19	26.52	2,510	161	3.36	130	<2.0	23	
	8/5/2008	36.71	11.50	25.21	200	3.2	<0.5	3.7	<0.5	2.9	
	11/4/2008	36.71	11.94	24.77	130	3.8	<0.5	4.3	<0.5	3.0	
	3/24/2009	36.71	8.48	28.23	2,000	160	4.3	130	6.1	22	
	6/8/2009	36.71	10.14	26.57	2,600 ^Y	170	4.9	140	8.2	26	
	MW-11	12/1/1996	95.94	11.99	83.95	NA	NA	NA	NA	NA	NA
		4/1/1997	95.94	11.47	84.47	NA	NA	NA	NA	NA	NA
12/30/1997		95.94	10.40	85.54	710	66	97	59	190	NA	
6/30/1998		95.94	NM	NM	1,100	45	24	71	100	NA	
9/29/1998		95.94	13.24	82.70	170	7	1	4	9	22	
12/16/1998		95.94	11.58	84.36	650	27	4	25	33	>0.5	
3/16/1999		95.94	8.81	87.13	710	30	6	53	84	8	
6/10/1999		95.94	11.50	84.44	4,600	1,240	35	290	159	1,291	
8/23/1999		95.94	12.75	83.19	170	4	4	ND	6	ND	
11/9/1999		95.94	13.85	82.09	<50	<5	<5	<5	<5	<5	
2/7/2000		95.94	13.60	82.34	700	20	15	<5	35	<5	
8/9/2000		95.94	14.87	81.07	590	10.5	5.94	<5	7.75	<5	
11/2/2000		95.94	12.55	83.39	60	ND	ND	ND	ND	ND	
3/13/2001		95.94	9.61	86.33	273	8.6	2.1	10	14	ND	
5/22/2001		95.94	11.15	84.79	280	12	8.3	3.3	9.8	12	
8/8/2001		95.94	13.04	82.90	NA	NA	NA	NA	NA	NA	
11/19/2001		95.94	13.48	82.46	300	7.9	26	5.1	28.9	ND	
2/21/2002		95.94	9.69	86.25	560	34	20	32	37.3	< 0.5	
5/7/2002		95.94	10.99	84.95	280	16	3	7.6	7.6	<2	
7/30/2002	NS	13.24	NC	120	5.6	<0.5	0.61	0.53	<2.0		
10/20/2002	NS	NM	NC	NA	NA	NA	NA	NA	NA		

Table 1
Historical Groundwater Elevation Data & Analytical Results
3609 International Boulevard, Oakland, California

Monitoring Well	Date	Top Of Casing Elevation ¹ (feet)	Depth to Groundwater (feet)	Groundwater Elevation (feet)	TPH-g (µg/L)	Benzene (µg/L)	Toluene (µg/L)	Ethyl-Benzene (µg/L)	Total Xylenes (µg/L)	MtBE ² EPA 8260B (µg/L)
MW-11 cont.	1/3/2003	NS	9.76	NC	700	32	5.7	25	14.10	<2.0
	5/3/2003	NS	9.66	NC	280	17	1.5 C	8	4.10	<2.0
	7/24/2003	NS	12.30	NC	340	19 C	3.2	0.58	0.89	<2.0
	10/22/2003	NS	13.38	NC	210	5.0 C	<0.5	<0.5	<0.5	<0.5
	1/22/2004	NS	NM	NC	NA	NA	NA	NA	NA	NA
	4/1/2004	NS	NM	NC	NA	NA	NA	NA	NA	NA
	8/20/2004	NS	NM	NC	NA	NA	NA	NA	NA	NA
	12/7/2004	NS	10.54	NC	486	24	3.0	18	4.00	<0.5
	3/15/2005	NS	NM	NC	NA	NA	NA	NA	NA	NA
	5/16/2005	NS	NM	NC	NA	NA	NA	NA	NA	NA
	7/14/2005	NS	NM	NC	NA	NA	NA	NA	NA	NA
	10/13/2005	NS	NM	NC	NA	NA	NA	NA	NA	NA
	1/3/2006	NS	NM	NC	NA	NA	NA	NA	NA	NA
	4/6/2006	NS	7.72	NC	872	19.8	3.63	37.5	3.28	<0.5
	5/6/2008	NS	NM	NC	NA	NA	NA	NA	NA	NA
	8/5/2008	NS	NM	NC	NA	NA	NA	NA	NA	NA
	11/4/2008	NS	NM	NC	NA	NA	NA	NA	NA	NA
3/24/2009	NS	NM	NC	NA	NA	NA	NA	NA	NA	
6/8/2009	NS	NM	NC	NC	NA	NA	NA	NA	NA	NA
MW-12	11/9/1999	94.84	13.20	81.64	80	<5	<5	<5	<5	229
	2/7/2000	94.84	10.20	84.64	4,000	351	37	<5	24	513
	5/31/2000	94.84	10.48	84.36	3,930	230	10	34	12	200
	8/9/2000	94.84	12.07	82.77	1,730	15.4	12.4	<5	<5	185
	11/2/2000	94.84	12.05	82.79	1,010	9.3	19.0	ND	7.40	215
	3/13/2001	94.84	9.04	85.80	1,517	13	5.6	5.5	11	214
	5/22/2001	94.84	10.52	84.32	31,000	1,200	ND	95	165	1,900
	8/8/2001	94.84	12.24	82.60	2,090	71	1.8	3	4	142
	11/19/2001	94.84	12.76	82.08	3,000	81	69	13	73	120
	2/21/2002	94.84	8.78	86.06	2,500	77	<0.5	5.7	7.4	95
	5/7/2002	94.84	10.26	84.58	2,700	74	<0.5	20	5.1	94
	7/30/2002	36.84	10.93	25.91	2,200	57	<0.5	11	2.6	100
	10/20/2002	36.84	13.13	23.71	2,600	71	<0.5	<0.5	10.3	84

Table 1
Historical Groundwater Elevation Data & Analytical Results
3609 International Boulevard, Oakland, California

Monitoring Well	Date	Top Of Casing Elevation ¹ (feet)	Depth to Groundwater (feet)	Groundwater Elevation (feet)	TPH-g (µg/L)	Benzene (µg/L)	Toluene (µg/L)	Ethyl-Benzene (µg/L)	Total Xylenes (µg/L)	MtBE ² EPA 8260B (µg/L)
MW-12 cont.	1/3/2003	36.84	9.23	27.61	2,300	65	<0.5	1	4.00	86
	5/3/2003	36.84	9.24	27.60	2,200	58	<0.5	4.2 C	4.1 C	96
	7/24/2003	36.84	11.44	25.40	2,200	32 C	16 C	<0.5	9.20	66
	10/22/2003	36.84	12.50	24.34	2200 H	31 C	<0.5	<0.5	3.5 C	49
	1/22/2004	36.84	9.56	27.28	1,700	24 C	14 C	3	5.00	72
	4/1/2004	36.84	10.21	26.63	2,000	11 C	<0.5	<0.5	5 C	36
	8/20/2004	36.84	12.00	24.84	1,900	8.9 C	<0.5	<0.5	1.1 C	26
	12/7/2004	36.84	10.03	26.81	1,018	2	<0.5	<0.5	<1.0	26
	3/15/2005	36.84	8.49	28.35	1,890	4.25	<0.5	6.38	<1.0	30.6
	5/16/2005	36.84	9.07	27.77	1,080	<0.5	<0.5	<0.5	<1.0	20.6
	7/14/2005	36.84	10.43	26.41	1,580	2.71	<2.0	3.33	<1.0	29.3
	10/13/2005	36.84	12.08	24.76	1,560	0.74	<2.0	<0.50	<1.0	28.1
	1/3/2006	36.84	7.89	28.95	480 Y	13	<0.5	<0.5	<0.5	30
	4/6/2006	36.84	7.92	28.92	1,310	<0.5	<2.0	<0.5	<1.0	31.1
	9/7/2006	36.84	11.44	25.40	1,220	0.61	<2.0	2.69	<1.0	23.7
	11/28/2006	36.84	11.61	25.23	543	2.15	<2.0	1.72	<2.0	27.6
	2/26/2007	36.84	9.04	27.80	5,580	9.81	11	8.52	31.3	14.2
	5/23/2007	36.84	10.37	26.47	350	<0.5	<2.0	4.74	2.32	18.9
	8/20/2007	36.84	12.03	24.81	556	0.68	<2.0	4.81	2.41	20.3
	11/15/2007	36.84	11.84	25.00	678	0.79	<2.0	0.51	<2.0	20.4
	2/21/2008	36.84	8.86	27.98	375	0.59	<2.0	1.06	<2.0	2.52
	5/6/2008	36.84	10.85	25.99	742	<0.5	<2.0	0.70	<2.0	8.92
	8/5/2008	36.84	12.15	24.69	550	0.56	<0.5	<0.5	<0.5	13
11/4/2008	36.84	12.78	24.06	NA	NA	NA	NA	NA	NA	
3/24/2009	36.84	9.37	27.47	NA	NA	NA	NA	NA	NA	
	6/8/2009	36.84	10.83	26.01	NA	NA	NA	NA	NA	NA
FDC	2/7/2000	97.10	15.40	81.70	NA	NA	NA	NA	NA	NA
	5/31/2000	97.10	12.41	84.69	NA	NA	NA	NA	NA	NA
	8/9/2000	97.10	15.70	81.40	NA	NA	NA	NA	NA	NA
	11/2/2000	97.10	16.85	80.25	NA	NA	NA	NA	NA	NA
	3/13/2001	97.10	9.39	87.71	NA	NA	NA	NA	NA	NA
	5/22/2001	97.10	15.85	81.25	NA	NA	NA	NA	NA	NA
	8/8/2001	97.10	13.30	83.80	NA	NA	NA	NA	NA	NA
	11/19/2001	97.10	17.82	79.28	NA	NA	NA	NA	NA	NA

Table 1
Historical Groundwater Elevation Data & Analytical Results
3609 International Boulevard, Oakland, California

Monitoring Well	Date	Top Of Casing Elevation ¹ (feet)	Depth to Groundwater (feet)	Groundwater Elevation (feet)	TPH-g (µg/L)	Benzene (µg/L)	Toluene (µg/L)	Ethyl-Benzene (µg/L)	Total Xylenes (µg/L)	MtBE ² EPA 8260B (µg/L)
FDC cont.	2/21/2002	97.10	16.74	80.36	NA	NA	NA	NA	NA	NA
	5/7/2002	97.10	10.36	86.74	NA	NA	NA	NA	NA	NA
	7/30/2002	39.35	11.93	27.42	NA	NA	NA	NA	NA	NA
	10/20/2002	39.35	13.74	25.61	NA	NA	NA	NA	NA	NA
	1/3/2003	39.35	15.18	24.17	NA	NA	NA	NA	NA	NA
	5/3/2003	39.35	16.20	23.15	NA	NA	NA	NA	NA	NA
	7/24/2003	39.35	16.45	22.90	NA	NA	NA	NA	NA	NA
	10/22/2003	39.35	16.53	22.82	NA	NA	NA	NA	NA	NA
	1/22/2004	39.35	13.74	25.61	NA	NA	NA	NA	NA	NA
	4/1/2004	39.35	16.30	23.05	NA	NA	NA	NA	NA	NA
	8/20/2004	39.35	16.05	23.30	NA	NA	NA	NA	NA	NA
	12/7/2004	39.35	14.56	24.79	NA	NA	NA	NA	NA	NA
	3/16/2005	39.35	13.55	25.80	NA	NA	NA	NA	NA	NA
	5/17/2005	39.35	14.88	24.47	NA	NA	NA	NA	NA	NA
	7/14/2005	39.35	14.32	25.03	NA	NA	NA	NA	NA	NA
	10/13/2005	39.35	14.99	24.36	NA	NA	NA	NA	NA	NA
	1/3/2006	39.35	11.82	27.53	NA	NA	NA	NA	NA	NA
	4/6/2006	39.35	13.60	25.75	NA	NA	NA	NA	NA	NA
	9/7/2006	39.35	15.05	24.30	NA	NA	NA	NA	NA	NA
	11/28/2006	39.35	15.47	23.88	NA	NA	NA	NA	NA	NA
	2/26/2007	39.35	13.01	26.34	NA	NA	NA	NA	NA	NA
	5/23/2007	39.35	14.23	25.12	NA	NA	NA	NA	NA	NA
	8/20/2007	39.35	15.92	23.43	NA	NA	NA	NA	NA	NA
	11/15/2007	39.35	15.98	23.37	NA	NA	NA	NA	NA	NA
	2/21/2008	39.35	10.22	29.13	NA	NA	NA	NA	NA	NA
	5/6/2008	39.35	14.95	24.40	NA	NA	NA	NA	NA	NA
	8/5/2008	39.35	16.05	23.30	NA	NA	NA	NA	NA	NA
	11/4/2008	39.35	16.02	23.33	NA	NA	NA	NA	NA	NA
	3/24/2009	39.35	12.78	26.57	NA	NA	NA	NA	NA	NA
	6/8/2009	39.35	15.89	23.46	NA	NA	NA	NA	NA	NA

Table 1
Historical Groundwater Elevation Data & Analytical Results
3609 International Boulevard, Oakland, California

Monitoring Well	Date	Top Of Casing Elevation ¹ (feet)	Depth to Groundwater (feet)	Groundwater Elevation (feet)	TPH-g (µg/L)	Benzene (µg/L)	Toluene (µg/L)	Ethyl-Benzene (µg/L)	Total Xylenes (µg/L)	MtBE ² EPA 8260B (µg/L)
FDE	5/31/2000	97.90	13.22	84.68	NA	NA	NA	NA	NA	NA
	8/9/2000	97.90	NM	NM	NA	NA	NA	NA	NA	NA
	11/2/2000	97.90	12.75	85.15	NA	NA	NA	NA	NA	NA
	3/13/2001	97.90	9.14	88.76	NA	NA	NA	NA	NA	NA
	5/22/2001	97.90	13.05	84.85	NA	NA	NA	NA	NA	NA
	8/8/2001	97.90	13.69	84.21	NA	NA	NA	NA	NA	NA
	11/19/2001	97.90	13.92	83.98	NA	NA	NA	NA	NA	NA
	2/21/2002	97.90	13.18	84.72	NA	NA	NA	NA	NA	NA
	5/7/2002	97.90	11.18	86.72	NA	NA	NA	NA	NA	NA
	7/30/2002	40.06	12.81	27.25	NA	NA	NA	NA	NA	NA
	10/20/2002	40.06	14.53	25.53	NA	NA	NA	NA	NA	NA
	1/3/2003	40.06	13.13	26.93	NA	NA	NA	NA	NA	NA
	5/3/2003	40.06	11.79	28.27	NA	NA	NA	NA	NA	NA
	7/24/2003	40.06	13.10	26.96	NA	NA	NA	NA	NA	NA
	10/22/2003	40.06	13.85	26.21	NA	NA	NA	NA	NA	NA
	1/22/2004	40.06	13.27	26.79	NA	NA	NA	NA	NA	NA
	4/1/2004	40.06	13.20	26.86	NA	NA	NA	NA	NA	NA
	8/20/2004	40.06	14.97	25.09	NA	NA	NA	NA	NA	NA
	12/7/2004	40.06	14.25	25.81	NA	NA	NA	NA	NA	NA
	3/16/2005	40.06	12.50	27.56	NA	NA	NA	NA	NA	NA
	5/17/2005	40.06	13.93	26.13	NA	NA	NA	NA	NA	NA
	7/14/2005	40.06	13.98	26.08	NA	NA	NA	NA	NA	NA
	10/13/2005	40.06	13.60	26.46	NA	NA	NA	NA	NA	NA
	1/3/2006	40.06	9.83	30.23	NA	NA	NA	NA	NA	NA
	4/6/2006	40.06	11.30	28.76	NA	NA	NA	NA	NA	NA
	9/7/2006	40.06	13.52	26.54	NA	NA	NA	NA	NA	NA
	11/28/2006	40.06	13.73	26.33	NA	NA	NA	NA	NA	NA
	2/26/2007	40.06	11.20	28.86	NA	NA	NA	NA	NA	NA
	5/23/2007	40.06	12.72	27.34	NA	NA	NA	NA	NA	NA
	8/20/2007	40.06	13.49	26.57	NA	NA	NA	NA	NA	NA
	11/15/2007	40.06	13.28	26.78	NA	NA	NA	NA	NA	NA
	2/21/2008	40.06	9.86	30.20	NA	NA	NA	NA	NA	NA
	5/6/2008	40.06	12.42	27.64	NA	NA	NA	NA	NA	NA
8/5/2008	40.06	13.54	26.52	NA	NA	NA	NA	NA	NA	
11/4/2008	40.06	13.63	26.43	NA	NA	NA	NA	NA	NA	
3/24/2009	40.06	10.58	29.48	NA	NA	NA	NA	NA	NA	
6/8/2009	40.06	12.51	27.55	27.55	NA	NA	NA	NA	NA	NA

Table 1
Historical Groundwater Elevation Data & Analytical Results
3609 International Boulevard, Oakland, California

Monitoring Well	Date	Top Of Casing Elevation ¹ (feet)	Depth to Groundwater (feet)	Groundwater Elevation (feet)	TPH-g (µg/L)	Benzene (µg/L)	Toluene (µg/L)	Ethyl-Benzene (µg/L)	Total Xylenes (µg/L)	MtBE ² EPA 8260B (µg/L)
FDW	5/31/2000	96.90	12.20	84.70	NA	NA	NA	NA	NA	NA
	8/9/2000	96.90	NM	NM	NA	NA	NA	NA	NA	NA
	11/2/2000	96.90	15.50	81.40	NA	NA	NA	NA	NA	NA
	3/13/2001	96.90	10.12	86.78	NA	NA	NA	NA	NA	NA
	5/22/2001	96.90	13.50	83.40	NA	NA	NA	NA	NA	NA
	8/8/2001	96.90	13.08	83.82	NA	NA	NA	NA	NA	NA
	11/19/2001	96.90	14.31	82.59	NA	NA	NA	NA	NA	NA
	2/21/2002	96.90	12.78	84.12	NA	NA	NA	NA	NA	NA
	5/7/2002	96.90	10.14	86.76	NA	NA	NA	NA	NA	NA
	7/30/2002	39.16	11.79	27.37	NA	NA	NA	NA	NA	NA
	10/20/2002	39.16	13.50	25.66	NA	NA	NA	NA	NA	NA
	1/3/2003	39.16	12.13	27.03	NA	NA	NA	NA	NA	NA
	5/3/2003	39.16	10.84	28.32	NA	NA	NA	NA	NA	NA
	7/24/2003	39.16	12.12	27.04	NA	NA	NA	NA	NA	NA
	10/22/2003	39.16	13.48	25.68	NA	NA	NA	NA	NA	NA
	1/22/2004	39.16	13.58	25.58	NA	NA	NA	NA	NA	NA
	4/1/2004	39.16	13.90	25.26	NA	NA	NA	NA	NA	NA
	8/20/2004	39.16	15.69	23.47	NA	NA	NA	NA	NA	NA
	12/7/2004	39.16	14.85	24.31	NA	NA	NA	NA	NA	NA
	3/16/2005	39.16	13.10	26.06	NA	NA	NA	NA	NA	NA
	5/17/2005	39.16	14.60	24.56	NA	NA	NA	NA	NA	NA
	7/14/2005	39.16	15.10	24.06	NA	NA	NA	NA	NA	NA
	10/13/2005	39.16	13.34	25.82	NA	NA	NA	NA	NA	NA
	1/3/2006	39.16	12.61	26.55	NA	NA	NA	NA	NA	NA
	4/6/2006	39.16	12.80	26.36	NA	NA	NA	NA	NA	NA
	9/7/2006	39.16	15.80	23.36	NA	NA	NA	NA	NA	NA
	11/28/2006	39.16	14.10	25.06	NA	NA	NA	NA	NA	NA
	2/26/2007	39.16	10.21	28.95	NA	NA	NA	NA	NA	NA
	5/23/2007	39.16	12.44	26.72	NA	NA	NA	NA	NA	NA
	8/20/2007	39.16	15.08	24.08	NA	NA	NA	NA	NA	NA
	11/15/2007	39.16	15.12	24.04	NA	NA	NA	NA	NA	NA
	2/21/2008	39.16	8.93	30.23	NA	NA	NA	NA	NA	NA
	5/6/2008	39.16	12.01	27.15	NA	NA	NA	NA	NA	NA
8/5/2008	39.16	14.15	25.01	NA	NA	NA	NA	NA	NA	
11/4/2008	39.16	13.94	25.22	NA	NA	NA	NA	NA	NA	
3/24/2009	39.16	9.66	29.50	NA	NA	NA	NA	NA	NA	
6/8/2009	39.16	11.87	27.29	NA	NA	NA	NA	NA	NA	

Table 1
Historical Groundwater Elevation Data & Analytical Results
3609 International Boulevard, Oakland, California

Monitoring Well	Date	Top Of Casing Elevation ¹ (feet)	Depth to Groundwater (feet)	Groundwater Elevation (feet)	TPH-g (µg/L)	Benzene (µg/L)	Toluene (µg/L)	Ethyl-Benzene (µg/L)	Total Xylenes (µg/L)	MtBE ² EPA 8260B (µg/L)
EX-1	2/27/2007	40.51	9.05	31.46	15,900	1,400	1,190	725	2,880	185
	5/23/2007	40.51	15.37	25.14	NA	NA	NA	NA	NA	NA
	8/20/2007	40.51	17.42	23.09	NA	NA	NA	NA	NA	NA
	11/15/2007	40.51	13.28	27.23	NA	NA	NA	NA	NA	NA
	2/21/2008	40.51	16.91	23.60	NA	NA	NA	NA	NA	NA
	5/6/2008	40.51	17.38	23.13	NA	NA	NA	NA	NA	NA
	8/5/2008	40.51	17.38	23.13	NA	NA	NA	NA	NA	NA
	11/4/2008	40.51	16.75	23.76	NA	NA	NA	NA	NA	NA
	3/24/2009	40.51	17.04	23.47	NA	NA	NA	NA	NA	NA
	6/8/2009	40.51	16.81	23.70	NA	NA	NA	NA	NA	NA

Notes:

¹ Top of casing elevations were re-surveyed to comply with the EDF requirements for electronic reporting of data to the State Water Resources Control Board Database on August 9, 2002.

² MtBE was analyzed using the EPA Method 8021B and confirmed using 8260B.

C Presence confirmed, but confirmation concentration differed by more than a factor of two.

H: Heavier hydrocarbons may have contributed to the quantitation.

NA: Not Analyzed

NA: Not Applicable, Well/Drain did not exist at time of sampling

NC: Not calculated. No top of casing elevation was available for MW-11.

ND, < : Not Detected above laboratory reporting limits.

NM: Not Measured

NS: Not Surveyed.

Y: Sample exhibits fuel pattern which does not resemble standard.

FDC: French drain center riser.

FDE: French drain east riser.

FDW: French drain west riser.

Well MW-4R replaced damaged well MW-4 on April 11, 2005. The first time well MW-4R was monitored was in the Second Quarter 2005

NS: Not surveyed. Well MW-11 was not surveyed due to obstructions surrounding well.

Well EX-1 was installed in the First Quarter 2007 and initially monitored in February 2007.

Table 2
Total Volume of Water Treated, Historical Operational Data,
and Laboratory Analytical Results for PSP #1 (Effluent) and GAC-1 Samples
3609 International Boulevard, Oakland, California

Month	Date	Effluent Totalizer Reading (gallons)	Lab Results For PSP #1 ¹ and GAC-1 Samples					
			MtBE ² (ug/L)	TPH-g (ug/L)	Benzene (ug/L)	Toluene (ug/L)	Ethyl- benzene (ug/L)	Total Xylenes (ug/L)
2009								
June	6/8/2009	4,239,570	<0.5 <0.5	<50 <50	<0.5 <0.5	<0.5 <0.5	<0.5 <0.5	<0.5 <0.5
March	3/17/2009	4,133,498	<0.5 <0.5	<50 <50	<0.5 <0.5	<0.5 <0.5	<0.5 <0.5	<0.5 <0.5
2008								
December	12/11/2008	4,013,030	<0.5 <0.5	<50 <50	<0.5 <0.5	<0.5 <0.5	<0.5 <0.5	<0.5 <0.5
September	9/8/2008	3,973,338	<0.5 <0.5	<50 <50	<0.5 <0.5	<0.5 <0.5	<0.5 <0.5	<0.5 <0.5
June	6/9/2008	3,927,778	<0.5 <0.5	<50 <50	<0.5 <0.5	<2.0 <2.0	<0.5 <0.5	<2.0 <2.0
May	5/21/2008	55-gallon polishing vessel changed						
March	3/4/2008	3,839,508	<0.5 <0.5	<50 <50	<0.5 <0.5	<2.0 <2.0	<0.5 <0.5	<2.0 <2.0
2007								
October	10/31/2007	3,673,410	<0.5 <0.5	<50 <50	<0.5 <0.5	<2.0 <2.0	<0.5 <0.5	<2.0 <2.0
July	7/27/2007	3,643,880	<0.5 <0.5	<50 <50	<0.5 <0.5	<2.0 <2.0	<0.5 <0.5	<2.0 <2.0
May	5/17/2007	3,590,070	<0.5 <0.5	<50 <50	<0.5 <0.5	<2.0 <2.0	<0.5 <0.5	<2.0 <2.0
April	4/27/2007	3,561,230	<0.5 <0.5	<50 <50	<0.5 <0.5	<2.0 <2.0	<0.5 <0.5	<2.0 <2.0
	4/20/2007	3,546,800	Startup of groundwater extraction from the new extraction well EX-1. As of this date, groundwater is being extracted from three wells at the site (EX-1, West Riser, and Center Riser).					
March	3/16/2007	3,528,090	<0.5 <0.5	<50 <50	<0.5 <0.5	<2.0 <2.0	<0.5 <0.5	<2.0 <2.0

Table 2
Total Volume of Water Treated, Historical Operational Data,
and Laboratory Analytical Results for PSP #1 (Effluent) and GAC-1 Samples
3609 International Boulevard, Oakland, California

Month	Date	Effluent Totalizer Reading (gallons)	Lab Results For PSP #1 ¹ and GAC-1 Samples					
			MtBE ² (ug/L)	TPH-g (ug/L)	Benzene (ug/L)	Toluene (ug/L)	Ethyl- benzene (ug/L)	Total Xylenes (ug/L)
February	2/22/2007	3,510,560	<0.5 <0.5	<50 <50	<0.5 <0.5	<2.0 <2.0	<0.5 <0.5	<2.0 <2.0
	2/19/2007	3,508,300	Carbon Change-out of 2000 lb vessel and 55 gallon polishing vessel					
January	1/16/2007	3,488,140	<0.5 1.37	<50 <50	<0.5 1.68	<2.0 <2.0	<0.5 1.25	<2.0 <2.0
2006								
December	12/22/2006	3,469,890	<0.5 <0.5	<50 <50	<0.5 <0.5	<0.5 <0.5	<0.5 <0.5	<0.5 <0.5
November	11/20/2006	3,455,980	<0.5 <0.5	<50 <50	<0.5 <0.5	<2.0 <2.0	<0.5 <0.5	<2.0 <2.0
October	10/18/2006	3,447,850	<0.5 <0.5	<50 <50	<0.5 <0.5	<2.0 <2.0	<0.5 <0.5	<1.0 <1.0
September	9/27/2006	3,441,500	<0.5 <0.5	<50 <50	<0.5 <0.5	<0.5 <0.5	<0.5 <0.5	<0.5 <0.5
August	8/14/2006	3,425,340	<0.5 <0.5	<50 <50	<0.5 <0.5	<2.0 <2.0	<0.5 <0.5	<1.0 <1.0
July	7/24/2006	3,414,800	<0.5 <0.5	<50 <50	<0.5 0.94	<2.0 <2.0	<0.5 <0.5	<1.0 <1.0
June	6/15/2006	3,387,940	Carbon Change-out of 2000 lb vessel and 55 gallon polishing vessel					
	6/7/2006	3,379,880	<0.5 2.89	<50 <50	<0.5 5.3	<2.0 <2.0	<0.5 1.24	<1.0 4.91
May	5/18/2006	3,350,260	replaced existing 200 gallon holding tank with newer 200 gallon tank					
May	5/11/2006	3,337,750	<0.5 0.61	<50 <50	<0.5 <0.5	<2.0 <2.0	<0.5 <0.5	<1.0 <1.0
April	4/19/2006	3,268,110	<0.5 1.66	<50 <50	<0.5 <0.5	<2.0 <2.0	<0.5 <0.5	<1.0 <1.0
	4/10/2006	3,236,770	Carbon Change-out of 2000 lb vessel and 55 gallon polishing vessel					

Table 2
Total Volume of Water Treated, Historical Operational Data,
and Laboratory Analytical Results for PSP #1 (Effluent) and GAC-1 Samples
3609 International Boulevard, Oakland, California

Month	Date	Effluent Totalizer Reading (gallons)	Lab Results For PSP #1 ¹ and GAC-1 Samples					
			MtBE ² (ug/L)	TPH-g (ug/L)	Benzene (ug/L)	Toluene (ug/L)	Ethyl- benzene (ug/L)	Total Xylenes (ug/L)
2006								
March	3/10/2006	3,220,570	<0.5 <0.5	<50 <50	<0.5 <0.5	<2.0 <2.0	<0.5 <0.5	<1.0 <1.0
February	2/10/2006	3,186,590	<0.5 <0.5	<50 <50	<0.5 <0.5	<2.0 <2.0	<0.5 <0.5	<1.0 <1.0
January	1/4/2006	3,122,610	<0.5 <0.5	<50 <50	<0.5 <0.5	<0.5 <0.5	<0.5 <0.5	<0.5 <0.5
2005								
December	12/9/2005	3,081,750	<0.5 <0.5	<50 <50	<0.5 <0.5	<2.0 <2.0	<0.5 <0.5	<1.0 <1.0
November	11/14/2005	3,072,540	<0.5 <0.5	<50 <50	<0.5 <0.5	<2.0 <2.0	<0.5 <0.5	<1.0 <1.0
October	10/17/2005	3,065,260	<0.5 <0.5	<50 <50	<0.5 <0.5	<2.0 <2.0	<0.5 <0.5	<1.0 <1.0
September	9/29/2005	3,060,640	Replaced existing 2000 lb carbon vessel with newer 2000 lb vessel, also replaced 55 gallon polishing vessel					
	9/12/2005	3,055,676						
August	8/8/2005	3,042,586	<0.5 0.51	<200 <200	<0.5 <0.5	<2.0 <2.0	<0.5 <0.5	<1.0 <1.0
July	7/7/2005	3,026,010	<0.5 <0.5	<200 <200	<0.5 <0.5	<2.0 <2.0	<0.5 <0.5	<1.0 <1.0
June	6/9/2005	3,000,386	<0.5 0.61	<200 <200	<0.5 <0.5	<2.0 <2.0	<0.5 <0.5	<1.0 <1.0
May	5/9/2005	2,971,430	<0.5 <0.5	<200 <200	<0.5 <0.5	<0.5 <0.5	<0.5 <0.5	<1.0 <1.0
	5/4/2005	2,964,270	Carbon Change-out of 2000 lb vessel and 55 gallon polishing vessel totalizer changed at meter reading of 2,189,270					
April	4/4/2005	2,904,500	<0.5 <0.5	<200 <200	<0.5 <0.5	<0.5 <0.5	<0.5 <0.5	<1.0 <1.0

Table 2
Total Volume of Water Treated, Historical Operational Data,
and Laboratory Analytical Results for PSP #1 (Effluent) and GAC-1 Samples
3609 International Boulevard, Oakland, California

Month	Date	Effluent Totalizer Reading (gallons)	Lab Results For PSP #1 ¹ and GAC-1 Samples					
			MtBE ² (ug/L)	TPH-g (ug/L)	Benzene (ug/L)	Toluene (ug/L)	Ethyl- benzene (ug/L)	Total Xylenes (ug/L)
2005								
March	3/21/2005	2,874,170	<0.5 <0.5	<200 <200	<0.5 <0.5	<0.5 <0.5	<0.5 <0.5	<1.0 <1.0
February	2/14/2005	2,828,000	55 Gallon Drum Changed Out					
	2/7/2005	2,819,000	<5.0 <5.0	<50 <50	<5.0 <5.0	<5.0 <5.0	<5.0 <5.0	<5.0 <5.0
January	1/19/2005	2,775,000	Carbon Change-out of 2000 lb vessel and 55 gallon polishing vessel					
	1/3/2005	2,730,480	3.6 3.8	<50 <50	<0.5 <0.5	<0.5 <0.5	<0.5 <0.5	<0.5 <0.5
2004								
December	12/6/2004	2,667,620	<0.5 <0.5	<50 <50	<0.5 <0.5	<0.5 <0.5	<0.5 <0.5	<1.0 <1.0
November	11/8/2004	2,631,600	<0.5 <0.5	<50 <50	<0.5 <0.5	<0.5 <0.5	<0.5 <0.5	<0.5 <0.5
October	10/13/2004	2,606,420	< 2.0 <2.0	< 50 <50	<0.5 <0.5	<0.5 <0.5	<0.5 <0.5	<0.5 <0.5
September	9/13/2004	2,594,390	< 2.0 < 2.0	< 50 < 50	<0.5 <0.5	<0.5 <0.5	<0.5 <0.5	<0.5 <0.5
August	8/25/2004	2,586,010	55 Gallon Drum Changed Out					
	8/9/2004	2,581,250	< 2.0 < 2.0	< 50 < 50	<0.5 <0.5	<0.5 <0.5	<0.5 <0.5	<0.5 <0.5
July	7/13/2004	2,568,830	< 2.0 < 2.0	< 50 < 50	<0.5 <0.5	<0.5 <0.5	<0.5 <0.5	<0.5 <0.5
	7/21/2004	2,564,710	55 Gallon Drum Changed Out					
June	6/14/2004	2,549,470	< 2.0 < 2.0	< 50 < 50	<0.5 <0.5	<0.5 <0.5	<0.5 <0.5	<0.5 <0.5
May	5/26/2004	2,530,000	Carbon Change-out of 2000 lb vessel and 55 gallon polishing vessel Semi Annual Treatment System Meeting With Ebmud Replaced 55-gallon polishing vessel and restarted the system Carbon Changed Out and 55 Gallon Drum Changed Out					
	5/10/2004	2,488,760						
	5/17/2004	2,518,910						
	5/5/2004	2,500,650						
	5/3/2004	2,497,350	< 2.0 < 2.0	< 50 < 50	<0.5 <0.5	<0.5 <0.5	<0.5 <0.5	<0.5 <0.5
April	4/15/2004	2,436,190	< 5.0 <5.0	< 50 < 50	< 5.0 < 5.0	< 5.0 < 5.0	< 5.0 < 5.0	< 5.0 < 5.0

Table 2
Total Volume of Water Treated, Historical Operational Data,
and Laboratory Analytical Results for PSP #1 (Effluent) and GAC-1 Samples
3609 International Boulevard, Oakland, California

Month	Date	Effluent Totalizer Reading (gallons)	Lab Results For PSP #1 ¹ and GAC-1 Samples					
			MtBE ² (ug/L)	TPH-g (ug/L)	Benzene (ug/L)	Toluene (ug/L)	Ethyl- benzene (ug/L)	Total Xylenes (ug/L)
2004								
March	3/17/2004	2,376,200	Carbon Change-out of 2000 lb vessel and 55 gallon polishing vessel					
February	2/24/2004	2,276,770	< 5.0 <5.0	< 5.0 < 50	< 5.0 < 5.0	< 5.0 < 5.0	< 5.0 < 5.0	< 5.0 < 5.0
January	1/27/2004	2,165,220	< 5.0 <5.0	< 5.0 < 50	< 5.0 < 5.0	< 5.0 < 5.0	< 5.0 < 5.0	< 5.0 < 5.0
	1/13/2004	2,116,720	< 5.0 <5.0	< 5.0 < 50	< 5.0 < 5.0	< 5.0 < 5.0	< 5.0 < 5.0	< 5.0 < 5.0
2003								
December	12/8/2003	2,092,330	< 5.0 <5.0	< 5.0 < 50	< 5.0 < 5.0	< 5.0 < 5.0	< 5.0 < 5.0	< 5.0 < 5.0
November	11/17/2003	2,087,670	< 5.0 <5.0	< 5.0 < 50	< 5.0 < 5.0	< 5.0 < 5.0	< 5.0 < 5.0	< 5.0 < 5.0
	11/3/2003	2,079,460	< 5.0 <5.0	< 5.0 < 50	< 5.0 < 5.0	< 5.0 < 5.0	< 5.0 < 5.0	< 5.0 < 5.0
October	10/13/2003	2,073,060	5.3 <5.0	< 5.0 < 50	< 5.0 < 5.0	< 5.0 < 5.0	< 5.0 < 5.0	< 5.0 < 5.0
	10/1/2003	2,072,610	Carbon Change-out of 2000 lb vessel and 55 gallon polishing vessel					
September	9/15/2003	2,056,910	<5.0 6	< 5.0 < 50	< 5.0 < 5.0	< 5.0 < 5.0	< 5.0 < 5.0	< 5.0 < 5.0
	9/2/2003	2,040,040	<5.0 <5.0	< 5.0 < 50	< 5.0 < 5.0	< 5.0 < 5.0	< 5.0 < 5.0	< 5.0 < 5.0
August	8/19/2003	2,021,040	<5.0 <5.0	< 5.0 < 50	< 5.0 < 5.0	< 5.0 < 5.0	< 5.0 < 5.0	< 5.0 < 5.0
July	7/21/2003	1,995,240	< 5.0 40	< 5.0 < 50	< 5.0 < 5.0	< 5.0 < 5.0	< 5.0 < 5.0	< 5.0 < 5.0
	7/9/2003	1,990,260	< 5.0 36	< 5.0 < 50	< 5.0 < 5.0	< 5.0 < 5.0	< 5.0 < 5.0	< 5.0 < 5.0
June	6/18/2003	1,978,560	Carbon Change-out of 2000 lb vessel and 55 gallon polishing vessel					
	6/10/2003	1,972,780	< 5.0 <5.0	< 5.0 < 50	< 5.0 < 5.0	< 5.0 < 5.0	< 5.0 < 5.0	< 5.0 < 5.0
May	5/21/2003	1,951,830	< 5.0 < 5.0	< 5.0 < 50	< 5.0 < 5.0	< 5.0 < 5.0	< 5.0 < 5.0	< 5.0 < 5.0
	5/1/2003	1,918,270	< 5.0 <5.0	< 5.0 < 50	< 5.0 < 5.0	< 5.0 < 5.0	< 5.0 < 5.0	< 5.0 < 5.0
April	4/11/2003	1,882,440	< 5.0 <5.0	< 5.0 < 50	< 5.0 < 5.0	< 5.0 < 5.0	< 5.0 < 5.0	< 5.0 < 5.0

Table 2
Total Volume of Water Treated, Historical Operational Data,
and Laboratory Analytical Results for PSP #1 (Effluent) and GAC-1 Samples
3609 International Boulevard, Oakland, California

Month	Date	Effluent Totalizer Reading (gallons)	Lab Results For PSP #1 ¹ and GAC-1 Samples					
			MtBE ² (ug/L)	TPH-g (ug/L)	Benzene (ug/L)	Toluene (ug/L)	Ethyl- benzene (ug/L)	Total Xylenes (ug/L)
2003								
March	3/19/2003	1,846,490	< 5.0 < 5.0	< 50 < 50	< 5.0 < 5.0	< 5.0 < 5.0	< 5.0 < 5.0	< 5.0 < 5.0
February	2/25/2003 2/19/2003	1,804,960 1,791,720	replaced 55-gallon polishing vessel with new 55 gallon carbon drum					
			< 5.0 < 5.0	< 50 < 50	< 5.0 < 5.0	< 5.0 < 5.0	< 5.0 < 5.0	< 5.0 < 5.0
January	1/27/2003	1,733,500	< 5.0 < 5.0	< 50 < 50	< 5.0 < 5.0	< 5.0 < 5.0	< 5.0 < 5.0	< 5.0 < 5.0
	1/2/2003	1,675,600	< 5.0 < 5.0	< 50 < 50	< 5.0 < 5.0	< 5.0 < 5.0	< 5.0 < 5.0	< 5.0 < 5.0
2002								
December	12/10/2002	1,672,870	< 5.0 < 5.0	< 50 < 50	< 5.0 < 5.0	< 5.0 < 5.0	< 5.0 < 5.0	< 5.0 < 5.0
November	11/22/2002	1,668,650	< 5.0 < 5.0	< 50 < 50	< 5.0 < 5.0	< 5.0 < 5.0	< 5.0 < 5.0	< 5.0 < 5.0
	11/13/2002	1,664,780	replaced gasket on top of 2000 lb GAC vessel, slight leak was detected					
	11/7/2002	1,663,880	Carbon Change-out of 2000 lb vessel and 55 gallon polishing vessel					
October	10/16/02 ³	1,661,590	< 310 < 0.5	2,000 Y Z < 50	< 310 < 0.5	< 310 < 0.5	< 310 < 0.5	< 310 < 0.5
September	9/19/2002	1,653,600	< 5 < 5	< 50 < 50	< 5 < 5	< 5 < 5	< 5 < 5	< 5 < 5
August	8/23/2002	1,641,650	1 < 0.5	< 50 < 50	< 0.5 < 0.5	< 0.5 < 0.5	< 0.5 < 0.5	< 0.5 < 0.5
July	7/23/2002	1,632,834	<5.0 < 5.0	< 50 < 50	<5.0 < 5.0	<5.0 < 5.0	<5.0 < 5.0	<5.0 < 5.0
June	6/24/2002	1,610,050	1.7 < 0.5	< 50 < 50	< 0.5 < 0.5	< 0.5 < 0.5	< 0.5 < 0.5	< 0.5 < 0.5
May	5/30/2002	1,571,630	< 0.5 < 0.5	< 50 < 50	< 0.5 < 0.5	< 0.5 < 0.5	< 0.5 < 0.5	< 0.5 < 0.5
	5/20/2002 5/8/2002 5/1/2002	1,548,000 1,538,850 1,529,650	removed newly installed compressor, installed another compressor installed new compressor installed new 55 gallon GAC Vessel					
April	4/24/2002	1,528,740	< 0.5 < 0.5	< 50 < 50	< 0.5 < 0.5	< 0.5 < 0.5	< 0.5 < 0.5	< 0.5 < 0.5
	4/1/2002	1,478,500	repaired valve plate assembly on compressor					

Table 2
Total Volume of Water Treated, Historical Operational Data,
and Laboratory Analytical Results for PSP #1 (Effluent) and GAC-1 Samples
3609 International Boulevard, Oakland, California

Month	Date	Effluent	Lab Results For PSP #1 ¹ and GAC-1 Samples					
		Totalizer Reading (gallons)	MtBE ² (ug/L)	TPH-g (ug/L)	Benzene (ug/L)	Toluene (ug/L)	Ethyl-benzene (ug/L)	Total Xylenes (ug/L)
2002								
March	3/25/2002 3/18/2002 3/14/2002	1,478,420 NR 1,478,330	performed carbon change-out on treatment system replaced piston on compressor compressor not building up pressure					
February	2/27/2002	1,449,830	< 0.5 1.1	< 50 < 50	< 0.5 < 0.5	< 0.5 < 0.5	< 0.5 < 0.5	< 0.5 < 0.5
January	1/22/2002	1,381,370	< 2.0 < 2.0	< 50 < 50	< 0.5 < 0.5	< 0.5 < 0.5	< 0.5 < 0.5	< 0.5 < 0.5
2001								
December	12/12/2001	1,311,340	ND ND	ND ND	ND ND	ND ND	ND ND	ND ND
November	11/2/2001	1,272,660	ND 0.6	ND ND	ND ND	ND ND	ND ND	ND ND
September	9/28/2001	NA	ND ND	ND ND	ND ND	ND ND	ND ND	ND ND
August	8/22/2001	1,243,100	ND ND	ND ND	ND ND	ND ND	ND ND	ND ND
July	7/26/2001 7/11/2001	1,227,270 1,226,730	ND ND NA NA	ND ND NA NA	ND ND NA NA	ND ND NA NA	ND ND NA NA	ND ND NA NA
June	6/29/2001 6/26/2001 6/16/2001 6/7/2001	1,224,600 NR 1,216,580 1,216,580	NA ND NA NA	NA ND NA NA	NA ND NA NA	NA ND NA NA	NA ND NA NA	NA ND NA NA
			installed new compressor					
			compressor not working, repaired compressor					
May	5/30/2001 5/23/2001 5/17/2001 5/10/2001 5/5/2001	1,205,198 1,194,390 1,182,360 1,166,850 1,151,600	NA NA NA ND ND NA NA	NA NA NA ND ND NA NA	NA NA NA ND ND NA NA	NA NA NA ND ND NA NA	NA NA NA ND ND NA NA	NA NA NA ND ND NA NA
April	4/28/2001 4/21/2001 4/11/2001 4/6/2001	1,135,690 1,113,570 1,082,700 1,065,540	NA NA NA ND NA NA	NA NA NA ND NA NA	NA NA NA ND NA NA	NA NA NA ND NA NA	NA NA NA ND NA NA	NA NA NA ND NA NA

Table 2
Total Volume of Water Treated, Historical Operational Data,
and Laboratory Analytical Results for PSP #1 (Effluent) and GAC-1 Samples
3609 International Boulevard, Oakland, California

Month	Date	Effluent Totalizer Reading (gallons)	Lab Results For PSP #1 ¹ and GAC-1 Samples						
			MtBE ² (ug/L)	TPH-g (ug/L)	Benzene (ug/L)	Toluene (ug/L)	Ethyl- benzene (ug/L)	Total Xylenes (ug/L)	
2001									
March	3/29/2001	1,036,330	NA NA	NA NA	NA NA	NA NA	NA NA	NA NA	
	3/21/2001	1,036,070	NA NA	NA NA	NA NA	NA NA	NA NA	NA NA	
	system was re-started								
	3/17/2001	1,035,100	NA NA	NA NA	NA NA	NA NA	NA NA	NA NA	
	belt replaced on compressor								
	3/13/2001	1,032,500	ND NA	ND NA	ND NA	ND NA	ND NA	ND NA	
	3/2/2001	996,520	NA NA	NA NA	NA NA	NA NA	NA NA	NA NA	
	3/1/2001	NR	system re-started after carbon change-out						
February	2/28/2001	NR	Carbon Change-out was performed on GAC-1, washed algae from holding tank, cleaned 2000 lb GAC, re-started system System shut down for maintenance and cleaning.						
	2/10/2001	975,490							
January	1/29/2001	957,880	ND ND	ND ND	ND ND	ND ND	ND ND	ND ND	
2000									
December	12/5/2000	883,000	ND ND	ND ND	ND ND	ND ND	ND ND	ND ND	
November	11/24/2000	NR	ND ND	ND ND	ND ND	ND ND	ND ND	ND ND	
	11/1/2000	842,000	ND ND	ND ND	ND ND	ND ND	ND ND	ND ND	
October	10/1/2000	809,000	ND ND	ND ND	ND ND	ND ND	ND ND	ND ND	
August	8/27/2000	781,000	ND	ND	ND	ND	ND	ND	
	8/24/2000	778,000							totalizer changed at meter reading of 775,000
July	7/26/2000	726,000	ND	ND	ND	ND	ND	ND	
	7/19/2000	718,000	ND	ND	ND	ND	ND	ND	
	7/13/2000	712,000	ND	ND	ND	ND	ND	ND	
	7/7/2000	706,000	ND	ND	ND	ND	ND	ND	

Table 2
Total Volume of Water Treated, Historical Operational Data,
and Laboratory Analytical Results for PSP #1 (Effluent) and GAC-1 Samples
3609 International Boulevard, Oakland, California

		Effluent	Lab Results For PSP #1 ¹ and GAC-1 Samples						
Month	Date	Totalizer Reading	MtBE ² (ug/L)	TPH-g (ug/L)	Benzene (ug/L)	Toluene (ug/L)	Ethyl- benzene (ug/L)	Total Xylenes (ug/L)	
		(gallons)							
2000									
June	6/29/2000	700,000	ND	ND	ND	ND	ND	ND	
	6/21/2000	682,220	ND	ND	ND	ND	ND	ND	
May	6/16/2000	669,720	ND	ND	ND	ND	ND	ND	
	6/10/2000	651,200	ND	ND	ND	ND	ND	ND	
	5/31/2000	629,000	ND	ND	ND	ND	ND	ND	
	5/23/2000	603,700	ND	ND	ND	ND	ND	ND	
	5/18/2000	570,000	ND	ND	ND	ND	ND	ND	
April	5/10/2000	530,400	ND	ND	ND	ND	ND	ND	
	4/30/2000	488,300	ND	ND	ND	ND	ND	ND	
	4/18/2000	485,300	ND	ND	ND	ND	ND	0.51	
	compressor stopped, system shut down until April 29, 2000								
	4/10/2000	440,200	ND	ND	ND	ND	ND	ND	
	4/4/2000	390,100	ND	ND	ND	ND	ND	ND	
	4/2/2000	NR	performed a carbon change-out on GAC-1						
March	3/31/2000	NR	replaced GAC-2 with a special GAC designed for removal of MtBE						
	3/24/2000	388,000	ND	ND	ND	ND	ND	ND	
	3/17/2000	357,100	ND	ND	ND	ND	ND	ND	
	3/10/2000	329,000	ND	ND	ND	ND	ND	ND	
	3/3/2000	300,000	transfer overheated, repaired pump, restarted system 3/6/00						
February	2/25/2000	274,000	ND	ND	ND	ND	ND	ND	
	2/18/2000	233,000	ND	ND	ND	ND	ND	ND	
	2/11/2000	190,000	ND	ND	ND	ND	ND	ND	
	2/4/2000	160,800	ND	ND	ND	ND	ND	ND	
January	1/28/2000	130,600	ND	ND	ND	ND	ND	ND	
	1/21/2000	103,435	ND	ND	ND	ND	ND	ND	
	1/17/2000	NR	GAC-1 was replaced with 2,000 lb GAC unit						
	1/14/2000	83,500	second polishing GAC was replaced with 55 gallon GAC unit						
			185	ND	ND	ND	ND	ND	
1999									
December	12/23/1999	51,680	1486	NA	ND	ND	ND	ND	
			ND	NA	ND	ND	ND	ND	
	12/16/1999	30,450	963	NA	ND	ND	ND	ND	
				ND	NA	ND	ND	ND	
	12/9/1999	9,000	230	ND	ND	ND	ND	ND	
Pumping began on December 6, 1999									

Notes:

- The designator "Effluent" used on sampling and laboratory documents refers to samples collected from PSP #1.
 - MTBE was analyzed using EPA Method 8260B, prior to the September 2003. After September 2003, MtBE was only analyzed by EPA Method 8021B.
 - Lab data as shown for Oct. 2002 is erroneous data. During lab analysis a high detection of 2-Butanone was detected in only the effluent sample. The influent sample for 2-Butanone was at only 20 ppb. This caused a high dilution factor causing a high non-detectable value. The high TPH-g value was misrepresentative due to the Y and Z flags.
- ND, < : Not Detected above laboratory reporting limits
NA: Not Analyzed
NR: Not recorded. Totalizer reading not recorded.
Y: Sample exhibits fuel pattern which does not resemble standard
Z: Sample exhibits unknown single peak or peaks

Table 3
Total Mass of Petroleum Hydrocarbons Removed
by the Vapor Extraction System & Historical Operational Data
3609 International Boulevard, Oakland, California

Date	Time	PID (ppmv)		Flow Rate (ft ³ /min)	Time Elapsed (Hours)	Air Flow (Liters)	Air Flow (ft ³)	Mass Removed ¹ (Pounds)
		Influent	Effluent					
2000								
7/24/2000	5:00 PM	394	0	85	0.0	0	0	0.00
7/25/2000	5:15 PM	38	2	95	24.3	3,911,768	138,225	1.35
7/26/2000	5:05 PM	207	1	80	24.0	3,260,160	115,200	6.15
7/27/2000	9:00 AM	160	5	92	16.0	2,499,456	88,320	3.64
7/28/2000	4:30 PM	141	7	87	31.5	4,653,369	164,430	5.98
7/29/2000	1:30 PM	225	8	85	21.0	3,030,930	107,100	6.21
7/30/2000	9:00 AM	226	12	85	19.5	2,814,435	99,450	5.79
7/31/2000	3:00 PM	141	5	85	30.0	4,329,900	153,000	5.56
8/1/2000	5:00 PM	135	4	80	26.0	3,531,840	124,800	4.34
8/2/2000	4:00 PM	80	4	80	23.0	3,124,320	110,400	2.28
8/3/2000	5:00 PM	60	5	85	25.0	3,608,250	127,500	1.97
8/4/2000	3:00 PM	57	4	85	22.0	3,175,260	112,200	1.65
8/5/2000	2:00 PM	97	8	87	23.0	3,397,698	120,060	3.00
8/6/2000	12:00 PM	114	8	80	22.0	2,988,480	105,600	3.10
8/7/2000	12:00 PM	93	9	85	24.0	3,463,920	122,400	2.93
8/8/2000	4:30 PM	152	10	85	28.5	4,113,405	145,350	5.70
8/10/2000	10:00 AM	173	1	85	41.5	5,989,695	211,650	9.44
8/11/2000	7:00 AM	78	4	70	21.0	2,496,060	88,200	1.77
8/12/2000	9:00 AM	100	6	70	26.0	3,090,360	109,200	2.82
8/13/2000	5:00 PM	107	9	70	32.0	3,803,520	134,400	3.71
8/14/2000	12:30 PM	122	5	70	19.5	2,317,770	81,900	2.58
8/15/2000	6:00 PM	103	12	70	29.5	3,506,370	123,900	3.29
8/16/2000	12:30 PM	112	0	70	18.5	2,198,910	77,700	2.24
8/18/2000	9:00 AM	90	0	75	44.5	5,667,075	200,250	4.65
8/21/2000	12:00 PM	74	5	80	75.0	10,188,000	360,000	6.87
8/24/2000	12:00 PM	68	13	80	72.0	9,780,480	345,600	6.06
8/27/2000	12:30 PM	68.5	2	80	72.5	9,848,400	348,000	6.15
8/31/2000	1:30 PM	52	6	80	97.0	13,176,480	465,600	6.24

Table 3
Total Mass of Petroleum Hydrocarbons Removed
by the Vapor Extraction System & Historical Operational Data
3609 International Boulevard, Oakland, California

Date	Time	PID (ppmv)		Flow Rate (ft ³ /min)	Time Elapsed (Hours)	Air Flow (Liters)	Air Flow (ft ³)	Mass Removed ¹ (Pounds)
		Influent	Effluent					
2000								
9/4/2000	12:30 PM	54	5	80	95.0	12,904,800	456,000	6.35
9/7/2000	12:00 PM	55	3	80	71.5	9,712,560	343,200	4.87
9/11/2000	4:30 PM ²	141	0	80	100.5	13,651,920	482,400	17.54
9/14/2000	9:30 AM	56	5	80	65.0	8,829,600	312,000	4.50
9/18/2000	2:00 PM	46	9.5	80	100.5	13,651,920	482,400	5.72
9/18/2000	4:30 PM ³	34	0	80	2.5	339,600	12,000	0.11
9/21/2000	4:30 PM	43	1	80	72.0	9,780,480	345,600	3.83
9/25/2000	5:30 PM	55	6	80	97.0	13,176,480	465,600	6.60
9/28/2000	9:00 AM	47.5	7.5	80	63.5	8,625,840	304,800	3.73
10/1/2000	1:00 PM	38.5	6	80	76.0	10,323,840	364,800	3.62
10/5/2000	3:00 PM ⁴	28.5	3	80	98.0	13,312,320	470,400	3.46
10/5/2000	5:00 PM	36	0	80	2.0	271,680	9,600	0.09
10/8/2000	3:00 PM	28.5	3	80	70.0	9,508,800	336,000	2.47
10/14/2000	3:00 PM	24.5	2.5	80	144.0	19,560,960	691,200	4.37
10/17/2000	2:00 PM	36.5	3.5	80	71.0	9,644,640	340,800	3.21
10/20/2000	8:30 AM	18.5	3.5	80	66.5	9,033,360	319,200	1.52
10/25/2000	2:00 PM	38	3.7	80	125.5	17,047,920	602,400	5.90
10/29/2000	10:00 AM	35	4	80	93.0	12,633,120	446,400	4.03
11/2/2000	4:00 PM	30.5	4	80	102.0	13,855,680	489,600	3.85
11/7/2000	4:00 PM	30	6	80	120.0	16,300,800	576,000	4.46
11/19/2000	12:00 PM	92.7	5.5	80	284.0	38,578,560	1,363,200	32.57
11/24/2000	1:30 PM	25	6.5	80	121.5	16,504,560	583,200	3.76
11/29/2000	3:00 PM	14.5	3.5	80	121.5	16,504,560	583,200	2.18
12/4/2000	4:30 PM	10.7	1	80	121.5	16,504,560	583,200	1.61
12/13/2000	3:30 PM	24	3	80	263.0	35,725,920	1,262,400	7.81
12/28/2000	2:30 PM	10	6	85	359.0	51,814,470	1,830,900	4.72

Table 3
Total Mass of Petroleum Hydrocarbons Removed
by the Vapor Extraction System & Historical Operational Data
3609 International Boulevard, Oakland, California

Date	Time	PID (ppmv)		Flow Rate (ft ³ /min)	Time Elapsed (Hours)	Air Flow (Liters)	Air Flow (ft ³)	Mass Removed ¹ (Pounds)
		Influent	Effluent					
2001								
1/4/2001 ⁵	2:00 PM	8.7	3.7	85	167.5	24,175,275	854,250	1.92
8/8/2001	3:00 PM	217	0	85	0.5	72,165	2,550	0.14
9/6/2001	12:00 PM	85	0	85	693.0	100,020,690	3,534,300	77.45
9/13/2001	4:00 PM	186	8	85	172.0	24,824,760	877,200	42.07
9/18/2001	3:00 PM	184	9	85	119.0	17,175,270	606,900	28.79
9/21/2001 ⁶		--	--	--	NC	NC	NC	NC
10/12/01 ⁷		--	--	--	NC	NC	NC	NC
10/23/2001	5:00 PM	114	58	87	0.5	73,863	2,610	0.08
10/25/01 ⁴	3:00 PM	133	0	85	46.0	6,639,180	234,600	8.04
10/29/2001 ⁸	1:20 PM	569	0	85	94.5	13,639,185	481,950	70.70
11/7/2001	3:30 PM	177	0	87	218.0	32,204,268	1,137,960	51.93
11/16/2001	3:00 PM	117	0	87	215.5	31,834,953	1,124,910	33.93
11/21/01 ⁹	12:00 PM	85	72	87	117.0	17,283,942	610,740	13.38
2002								
2/15/02 ¹⁰	4:30 PM	49	0	80	0.5	67,920	2,400	0.03
2/16/2002	3:45 PM	50	0	80	23.3	3,158,280	111,600	1.44
2/21/2002	4:00 PM	37	4	80	120.3	16,334,760	577,200	5.51
2/27/2002	10:30 AM	11	0	83	138.5	19,519,359	689,730	1.96
3/7/02 ¹¹	12:20 PM	10		80	194.0	26,352,960	931,200	2.40
6/12/2002 ¹²	4:15 PM	53	2	75	NA	NA	NA	NA
6/17/2002	11:00 AM	28	2	80	120.0	16,306,560	576,204	4.16
6/24/2002	11:20 AM	24	3.1	80	168.3	22,866,400	808,000	5.00
7/5/2002	1:25 PM	20	5	80	266.0	36,133,440	1,276,800	6.58
7/11/2002	3:30 PM	26	8.0	80	146.0	19,832,640	700,800	4.70
7/23/2002	10:10 AM	28	7.5	83	282.8	39,849,089	1,408,095	10.16
8/9/2002	12:20 PM	7.5	0	80	410.3	55,728,360	1,969,200	3.81
8/15/2002 ¹¹	3:00 PM	7.0	1	80	146.5	19,900,560	703,200	1.27
8/23/2002 ¹³	3:20 PM	NC	NC	NC	NC	NC	NC	NC
8/26/2002	11:15 AM	14.0	2.0	80	71.0	9,644,640	340,800	1.23
9/11/2002	10:10 AM	34.4	0	80	383.0	52,020,588	1,838,183	16.30
9/19/2002	10:55 AM	8.8	1.1	80	192.8	26,183,160	925,200	2.10
9/25/2002	10:30 AM	18.8	1.8	80	143.5	19,493,040	688,800	3.34

Table 3
Total Mass of Petroleum Hydrocarbons Removed
by the Vapor Extraction System & Historical Operational Data
3609 International Boulevard, Oakland, California

Date	Time	PID (ppmv)		Flow Rate (ft ³ /min)	Time Elapsed (Hours)	Air Flow (Liters)	Air Flow (ft ³)	Mass Removed ¹ (Pounds)
		Influent	Effluent					
2002								
10/2/2002	8:10 AM	17.1	2.5	80	165.70	22,508,688	795,360	3.51
10/9/2002		PID malfunction		80	NC	NC	NC	NC
10/16/2002	1:45 PM	17.0	4.0	80	341.50	46,389,360	1,639,200	7.18
10/24/2002	10:00 AM	16.5	6.4	80	188.25	25,571,880	903,600	3.84
11/1/2002	10:00 AM	21.1	0.0	85	192.00	27,711,360	979,200	5.33
11/6/2002	10:12 AM	PID malfunction		87	NC	NC	NC	NC
11/7/2002	11:00 AM	17.5	0.0	85	24.75	3,572,168	126,225	0.57
11/13/2002	11:30 AM	15.0	0.0	85	144.50	20,855,685	736,950	2.85
11/22/2002	2:30 PM	6.6	0.0	80	219.00	29,748,960	1,051,200	1.79
11/22/2002		system shut-down due to rainy season and low influent readings						
2003								
5/9/2003	10:30 AM	0.1	0.0	82	0.5	69,618	2,460	0.00
5/12/2003	10:30 AM	0.4	0.3	85	72.00	10,391,760	367,200	0.04
5/21/2003	11:00 AM	2.2	2.2	83	216.50	30,512,211	1,078,170	0.61
6/4/2003	10:30 AM	2.5	0.1	82	335.50	46,713,678	1,650,660	1.06
6/10/2003	10:30 AM	2.2	0.08	82	144.00	20,049,984	708,480	0.40
6/16/2003	12:15 PM	2.1	0.07	82	146.25	20,363,265	719,550	0.39
6/24/2003	4:55 PM	2.6	0.08	82	196.75	27,394,683	968,010	0.65
6/30/2003	11:30 AM	2.2	0.1	82	138.50	19,284,186	681,420	0.39
7/16/2003	12:00 PM	2.2	0.22	82	384.50	53,536,242	1,891,740	1.07
7/21/2003	10:50 AM	2.1	0.21	82	119.00	16,569,084	585,480	0.32
7/28/2003	11:15 AM	2.2	0.22	82	168.25	23,426,457	827,790	0.47
8/11/2003	12:15 PM	2.1	0.21	82	337.00	46,922,532	1,658,040	0.90
8/19/2003	10:05 AM	2.1	0.22	82	190.00	26,454,840	934,800	0.51
8/25/2003	11:30 AM	2.2	0.23	81	145.50	20,011,779	707,130	0.40
9/2/2003	10:50 AM	2.1	0.21	80	191.50	26,013,360	919,200	0.50
9/8/2003	2:10 PM	9.1	3.19	83	147.30	20,759,578	733,554	1.72
9/11/2003	10:00 AM	All 4 SVE carbon drums changed-out						
9/22/2003	1:30 PM	7	0.2	88	334.25	49,944,972	1,764,840	3.19

Table 3
Total Mass of Petroleum Hydrocarbons Removed
by the Vapor Extraction System & Historical Operational Data
3609 International Boulevard, Oakland, California

Date	Time	PID (ppmv)		Flow Rate (ft ³ /min)	Time Elapsed (Hours)	Air Flow (Liters)	Air Flow (ft ³)	Mass Removed ¹ (Pounds)
		Influent	Effluent					
2003								
10/1/2003	10:30 AM	6.5	0.2	85	213.00	30,742,290	1,086,300	1.82
10/6/2003	11:00 AM	7	0.3	85	120.50	17,391,765	614,550	1.11
10/13/2003	11:15 AM	5	0.2	85	168.25	24,283,523	858,075	1.11
10/29/2003	10:00 AM	2.4	0	85	382.75	55,242,308	1,952,025	1.21
11/3/2003	11:30 AM	3	0	85	121.50	17,536,095	619,650	0.48
11/10/2003	11:10 AM	3.5	0	85	167.67	24,199,330	855,100	0.77
11/17/2003	1:50 PM	4.1	0	85	170.70	24,637,131	870,570	0.92
11/24/2003	11:00 AM	3.8	0	85	165.20	23,843,316	842,520	0.83
11/24/2003	system shut-down due to rainy season and low influent readings							
2004								
4/5/2004	1:00 PM	5.6	0.11	85	0.5	72165	2550	0.004
4/12/2004	10:30 AM	6.5	0.2	83	165.5	23,324,577	824,190	1.38
4/20/2004	12:00 PM	7.1	0.9	84	193.5	27,599,292	975,240	1.79
4/23/2004	11:00 AM	7.2	2.3	80	71	9,644,640	340,800	0.63
5/3/2004	12:00 PM	7.1	3.4	80	241	32,737,440	1,156,800	2.12
5/5/2004	11:00 PM	All 4 SVE carbon drums changed-out						
5/17/2004	12:00 PM	2.7	0.8	82	336	46,783,296	1,653,120	1.15
5/26/2004	11:00 AM	3.8	0.5	82	215	29,935,740	1,057,800	1.04
6/1/2004	1:00 PM	3.6	0.9	82	146	20,328,456	718,320	0.67
6/7/2004	11:50 AM	3.2	0	82	142.75	19,875,939	702,330	0.58
6/14/2004	11:50 AM	10.9	0	86	168	24,532,704	866,880	2.44
6/21/2004	10:50: AM	13.5	0	83	167	23,535,978	831,660	2.89
6/28/2004	11:50 AM	10.9	0.5	85	169	24,391,770	861,900	2.42
7/2/2004	11:30 AM	8.7	0	85	95.8	13,826,814	488,580	1.10
7/13/2004	2:00 PM	9.1	0.22	85	266.5	38,463,945	1,359,150	3.19
7/21/2004	12:00 PM	8.9	0.5	85	190	27,422,700	969,000	2.22
7/26/2004	11:50 AM	8.5	0.4	85	119.5	17,247,435	609,450	1.34
8/2/2004	11:30 AM	4.9	0.1	85	167.8	24,218,574	855,780	1.08
8/9/2004	11:50 AM	5.6	0.2	85	168.3	24,290,739	858,330	1.24
8/16/2004	12:00 PM	6	0.4	85	168.1	24,261,873	857,310	1.33
8/24/2004	11:50 AM	6.2	1.2	85	191.9	27,696,927	978,690	1.56
8/30/2004	11:30 AM	6	0.4	85	143.66	20,734,448	732,666	1.13
9/7/2004	1:05 PM	5.5	0.8	85	193.5	27,927,855	986,850	1.40
9/13/2004	12:05 PM	5.3	0.9	85	143	20,639,190	729,300	1.00
9/20/2004	11:08 AM	7	2.9	85	167	24,103,110	851,700	1.54
9/27/2004	2:50 PM	6.5	2.1	85	171.75	24,788,678	875,925	1.47

Table 3
Total Mass of Petroleum Hydrocarbons Removed
by the Vapor Extraction System & Historical Operational Data
3609 International Boulevard, Oakland, California

Date	Time	PID (ppmv)		Flow Rate (ft ³ /min)	Time Elapsed (Hours)	Air Flow (Liters)	Air Flow (ft ³)	Mass Removed ¹ (Pounds)
		Influent	Effluent					
2004								
10/4/2004	11:30 AM	6.9	3	85	164.55	23,749,502	839,205	1.49
10/13/2004	10:30 AM	6.5	2.9	85	215	31,030,950	1,096,500	1.84
10/18/2004	2:30 PM	6	1.5	85	124	17,896,920	632,400	0.98
10/28/2004	2:00 PM	3.1	0.9	85	239.5	34,567,035	1,221,450	0.98
10/28/2004	system shut-down due to rainy season and low influent readings							
2005								
4/11/2005	system re-started, all four vapor phase carbon drums replaced with new carbon							
4/18/2005	10:50 AM	6.5	0.8	85	167.83	24,223,481	855,953	1.43
4/25/2005	5:30 PM	6	0.7	85	174.33	25,161,626	889,103	1.38
5/4/2005	11:20 AM	0.4	0	85	209.83	30,285,341	1,070,153	0.11
5/9/2005	11:00 AM	1	0.4	85	119.67	17,271,538	610,302	0.16
5/16/2005	10:15 AM	3	0	85	167.25	24,139,193	852,975	0.66
5/23/2005	11:05 AM	0.4	0	90	168.83	25,801,110	911,700	0.09
6/3/2005	3:30 PM	0.2	0	90	268.48	41,029,114	1,449,792	0.07
6/9/2005	3:00 PM	0.2	0	90	143.50	21,929,670	774,900	0.04
6/15/2005	2:15 PM	1	0	85	143.25	20,675,273	730,575	0.19
6/20/2005	12:00 PM	0.6	0	88	117.75	17,594,676	621,720	0.10
6/26/2005	12:00 PM	0.5	0	85	144.00	20,783,520	734,400	0.09
7/7/2005	2:45 PM	0.2	0	90	266.75	40,764,735	1,440,450	0.07
7/11/2005	3:00 PM	0.3	0	90	96.25	14,708,925	519,750	0.04
7/18/2005	1:00 PM	1	0	85	166.00	23,958,780	846,600	0.22
7/25/2005	12:00 PM	1.5	0	87	167.00	24,670,242	871,740	0.34
8/1/2005	1:30 PM	1	0	85	169.50	24,463,935	864,450	0.22
8/8/2005	11:50 AM	0.7	0	80	166.40	22,603,776	798,720	0.14
8/15/2005	1:30 PM	0.9	0	83	169.60	23,902,406	844,608	0.20
8/24/2005	12:00 PM	0.8	0	85	214.50	30,958,785	1,093,950	0.23
8/29/2005	11:45 AM	0.7	0	85	119.75	17,283,518	610,725	0.11
9/6/2005	12:15 PM	0.8	0	85	192.50	27,783,525	981,750	0.20
9/12/2005	12:10 PM	1.2	0	85	144.00	20,783,520	734,400	0.23
9/20/2005	11:30 AM	1.1	0	84	192.60	27,470,923	970,704	0.28

Table 3
Total Mass of Petroleum Hydrocarbons Removed
by the Vapor Extraction System & Historical Operational Data
3609 International Boulevard, Oakland, California

Date	Time	PID (ppmv)		Flow Rate (ft ³ /min)	Time Elapsed (Hours)	Air Flow (Liters)	Air Flow (ft ³)	Mass Removed ¹ (Pounds)
		Influent	Effluent					
2005								
10/6/2005	3:00 PM	all 4 vapor phase carbon drums replaced with new carbon drums						
10/14/2005	3:30 PM	33	5	83	192.5	27,129,795	958,650	8.16
10/17/2005	12:00 PM	33	5	86	68.5	10,002,918	353,460	3.01
10/28/2005	11:00 AM	77	1.5	83	263	37,065,642	1,309,740	26.00
11/1/2005	9:40 AM	33	7	86	94.75	13,836,153	488,910	4.16
11/3/2005	3:30 PM	33	7	87	54	7,977,204	281,880	2.40
11/9/2005	3:15 PM	all 4 vapor phase carbon drums replaced with new carbon drums						
11/14/2005	11:30 AM	0.3	0	89	260	39,291,720	1,388,400	0.11
11/22/2005	2:40 PM	0.8	0	88	195	29,137,680	1,029,600	0.21
11/17/2005-11/23/2005		3 new vapor wells installed onsite						
2006								
1/6/2006	10:00 AM	System shut-down due to rainy conditions						
2/22/2006-3/6/2006		Air Sparge and Additional SVE system installed						
4/8/2006		Existing vacuum eductor, which was built and installed in 2000, was rebuilt. To reduce the noise level, foam was placed around the vacuum eductor to act as a noise suppressant						
4/14/2006	2:00 PM	system re-started, all 4 vapor phase carbon drums replaced with new carbon drums						
4/14/2006	2:30 PM	33	0	85	0.5	72,165	2,550	0.02
5/18/2006	12:00 PM	14	0	87	813.5	120,175,101	4,246,470	15.33
5/31/2006	12:30 PM	15	2	83	312.5	44,041,875	1,556,250	6.02
6/7/2006	10:00 AM	17.7	5.8	85	165.5	23,886,615	844,050	3.85
6/14/2006	10:00 AM	8.2	0	89	168	25,388,496	897,120	1.90
6/19/2006	2:30 PM	220	0	88	124.5	18,603,288	657,360	37.29
6/22/2006	11:00 AM	18	0	85	68.5	9,886,605	349,350	1.62
7/6/2006	2:45 PM	3.2	0	80	339.75	46,151,640	1,630,800	1.35
7/24/2006	2:00 PM	Additional vacuum eductor installed in series with the existing blower						
8/2/2006	11:00 AM	25	0	65	644.25	71,105,873	2,512,575	16.19
8/9/2006	11:30 AM	7.3	3.5	110	168.5	31,472,430	1,112,100	2.09
8/14/2006	12:00 PM	8	2.3	100	120.5	20,460,900	723,000	1.49
8/25/2006	12:30 PM	2	0	100	264.5	44,912,100	1,587,000	0.82
8/28/2006	2:30 PM	2.5	0	110	74.5	13,915,110	491,700	0.32
9/7/2006	2:30 PM	1.4	0	105	240	42,789,600	1,512,000	0.55
9/13/2006	12:45 PM	1.6	0	105	142.25	25,361,753	896,175	0.37
9/22/2006	3:00 PM	1.3	0	115	219.25	42,812,948	1,512,825	0.51
9/27/2006	2:15 PM	5.6	1.1	110	119.25	22,273,515	787,050	1.14

Table 3
Total Mass of Petroleum Hydrocarbons Removed
by the Vapor Extraction System & Historical Operational Data
3609 International Boulevard, Oakland, California

Date	Time	PID (ppmv)		Flow Rate (ft ³ /min)	Time Elapsed (Hours)	Air Flow (Liters)	Air Flow (ft ³)	Mass Removed ¹ (Pounds)	
		Influent	Effluent						
2006									
10/4/2006	11:15 AM	5.9	1.6	105	165	29,417,850	1,039,500	1.58	
10/10/2006	11:30 AM	0.9	0	105	144.25	25,718,333	908,775	0.21	
10/18/2006	3:15 PM	0.9	0	105	195.75	34,900,268	1,233,225	0.29	
10/27/2006	10:00 AM	303	0	60	210.75	21,471,210	758,700	59.27	
11/1/2006	10:00 AM	0.2	0	90	120	18,338,400	648,000	0.03	
11/7/2006	12:00 PM	0.2	0	80	146	19,832,640	700,800	0.04	
11/7/2006	12:00 PM	System shut-down due to rainy conditions							
2007									
5/23/2007	System Re-started								
5/23/2007	10:45 AM	31.3	0	85	1	144,330	5,100	0.04	
5/29/2007	11:00 AM	11.2	1.7	80	144.25	19,594,920	692,400	2.00	
6/11/2007	12:00 PM	8.1	1.1	80	313	42,517,920	1,502,400	3.14	
6/20/2007	3:00 PM	1.4	0.5	75	219	27,889,650	985,500	0.36	
7/3/2007	12:00 PM	1.5	0.4	75	1	127,350	4,500	0.00	
7/12/2007	12:00 PM	8	0.3	80	144.25	19,594,920	692,400	1.43	
7/27/2007	9:30 AM	8.5	0.4	85	313	45,175,290	1,596,300	3.50	
8/7/2007	3:30 PM	14	0.9	105	219	39,045,510	1,379,700	4.98	
8/21/2007	2:00 PM	16.5	0	110	1	186,780	6,600	0.03	
9/7/2007	12:30 PM	12.2	0.1	105	144.25	25,718,333	908,775	2.86	
9/21/2007	10:00 AM	1.9	0.3	84	313	44,643,816	1,577,520	0.77	
9/28/2007	11:00 AM	1.9	0.3	85	219	31,608,270	1,116,900	0.55	
Total Mass of Petroleum Hydrocarbons Removed =								967.20	
Average Daily Removal Rate (pounds / day)=								0.37	

Notes:

- ¹ The representative molecular weight of hydrocarbons was assumed to be 150 gram/mole and use the measured temperature of Vapor (25°C) in converting ppm-v to ppm on mass basis.
- ² System accidentally shut down from main box, readings taken 30 minutes after startup
- ³ GAC Replaced
- ⁴ GAC-1 removed, new GAC installed at effluent end
- ⁵ SVE System turned off for rainy season due to low influent concentration
- ⁶ system down, hoses disconnected and GAC moved for replacement
- ⁷ system down for electrical repair
- ⁸ Carbon change-out of three drums, moved new effluent drum on 10/25/01 to GAC-
- ⁹ system shut-down due to high effluent value
- ¹⁰ System re-started (since November 21, 2001), installed new 4-55 gallon vapor phase carbon vessels, repaired blow
- ¹¹ System was shut-down due to low influent reading
- ¹² System was restarted on 6/12/02
- ¹³ System was re-started but no readings were taken

Data for October 28, 2005 based on lab data

NC: Not Calculated

Calculations

Airflow: Flowrate (ft³/min) * 60 min * Time Elapsed (hrs) * 28.3 liters/ft³

Mass Removed: Time Elapsed (hrs) * 60 min * Flowrate (ft³/min) * (28.3 m³/ft³) * ((PID reading * (102 grams TPH-g /mole) * (1 mole / 24.4 L)) * (1/1000 m³)) * (1 lb/454 grams)

Table 4
May 2009 MPE Event
Operational Data

3609 International Boulevard
Oakland, California

DATE	TIME	PID (ppmv)	WELL MANIFOLD VACUUM (In of Hg)	OXIDIZER TEMPERATURE (°F)	EFFLUENT TEMPERATURE (°F)	PITOT TUBE (In of H2O)	CALCULATED FLOW RATE USING PITOT TUBE (scfm)	SYSTEM (BLOWER) VACUUM (In of Hg)	SYSTEM TOTALIZER READING (gallons)	COMMENTS
5/11/2009	1230									begin at MW-1, MW-3
	1330	1,635	18.3	1,599	154	0.10	38	25.8	178	
	1430	1,030	17.7	1,565	154	0.10	38	25.3	359	
	1530	769	24.3	1,588	154	0.10	38	26.4	557	
	1630	632	24.2	1,589	154	0.10	38	26.4	713	
5/12/2009	MW-3 & MW-6 overnight, added MW-8 @ 8:45 AM									
	900	464	17	1,507	154	0.10	38	25.2	3,195	In = 464; Eff = 3
	1000	706	23.1	1,548	154	0.10	38	25.7	3,427	
	1400	428	22.6	1,520	154	0.10	38	25.6	4,306	
	1530	442	22.7	1,529	154	0.10	38	25.6	4,622	
	1630	439	22.7	1,531	154	0.10	38	25.5	4,813	
5/13/2009	630	310	22.2	1,474	154	0.10	38	25.4	7,588	
	1030	324	22.2	1,498	154	0.10	38	25.4	8,345	
	1430	334	22	1,508	154	0.10	38	25.2	9,141	
	1530	339	21.9	1,503	154	0.10	38	25.2	9,293	
	1630	459	21.4	1,500	154	0.10	38	25.2	9,527	
5/14/2009	700	294	21.8	1,450	146	0.12	42	25	12,238	Added MW-1 after reading; system shut down 10 mins later from influent overload- high-high level sensor closed valve
	1230	294	21.7	1,471	146	0.12	42	25.2	13,332	
	1330	304	21.7	1,485	146	0.12	42	25.1	13,440	
	1430	302	21.6	1,480	148	0.12	42	25	13,617	
	1530	304	21.6	1,483	148	0.12	42	25	13,724	

Table 4
May 2009 MPE Event
Operational Data

3609 International Boulevard
Oakland, California

DATE	TIME	PID (ppmv)	WELL MANIFOLD VACUUM (In of Hg)	OXIDIZER TEMPERATURE (°F)	EFFLUENT TEMPERATURE (°F)	PITOT TUBE (In of H2O)	CALCULATED FLOW RATE USING PITOT TUBE (scfm)	SYSTEM (BLOWER) VACUUM (In of Hg)	SYSTEM TOTALIZER READING (gallons)	COMMENTS
5/15/2009	1630	301	21.6	1,484	148	0.12	42	25	13,839	
	1000	328	21.6	1,500	148	0.12	42	25	15,988	
	1230	280	21.6	1,500	148	0.12	42	25	16,328	
	1330	299	21.6	1,501	148	0.12	42	25	16,448	
	1430	265	21.6	1,502	148	0.12	42	25	16,575	
	1530	244	21.6	1,504	148	0.12	42	25	16,799	
	1630	286	21.6	1,500	148	0.12	42	25	16,923	

Totalizer readings = 16,923 gallons
Total time of test = 6,000 minutes = 100 hours

Notes

ppmv parts per million vapor
In of Hg inches of mercury
In of H₂O inches of water
°F degrees Fahrenheit
scfm standard cubic feet per minute
**Flow Equation Used: $Q \text{ (SCFM)} = 128.8 \cdot K \cdot D^3 \cdot \sqrt{((P \cdot \Delta P) / ((T + 460) \cdot S_a))}$
ΔP = Differential pressure measured through pitot tube expressed in inches of water column
Q = Flow expressed in SCFM, (standard cubic feet per minute)
K = 0.67, Flow coefficient for 3 inch diameter pipe

D = 3, Diameter of pipe expressed in inches
P = 14.7, Standard Atmospheric Pressure (psia)
T = Temperature in degrees Fahrenheit + 460 = °Rankine
S_a = 1 = Specific Gravity of air at 60°F (15.6°C)

Table 5
May 2009 MPE Event
Extraction Data and VOC Mass Removal Rate

3609 International Boulevard
 Oakland, California

WELL	COMMENT	DATE	CLOCK TIME	INCREMENTAL TIME	ELAPSED TIME	Q			PID		MASS REMOVAL			
						minutes	minutes	minutes	SCFM	ft ³ of extracted air	Moles of extracted air	ppmv as hexane	VOC mole %	lb VOC mass removal as hexane
MW-1/3	START	5/11/2009	1230	0										
			1330	60	60	38	2,280	6.0162	1,635	0.0016	0.8479	0.0141	20	
			1430	60	120	38	2,280	6.0162	1,030	0.0010	0.5342	0.0089	13	
			1530	60	180	38	2,280	6.0162	769	0.0008	0.3988	0.0066	10	
MW-3/6/8		5/12/2009	1630	60	240	38	2,280	6.0162	632	0.0006	0.3278	0.0055	8	
			900	990	1,230	38	37,622	99.2667	464	0.0005	3.9704	0.0040	6	
			1000	60	1,290	38	2,280	6.0162	706	0.0007	0.3661	0.0061	9	
			1400	240	1,530	38	9,121	24.0647	428	0.0004	0.8878	0.0037	5	
MW-1/3/6/8		5/13/2009	1530	90	1,620	38	3,420	9.0242	442	0.0004	0.3438	0.0038	6	
			1630	60	1,680	38	2,280	6.0162	439	0.0004	0.2277	0.0038	5	
			630	840	2,520	38	31,922	84.2263	310	0.0003	2.2507	0.0027	4	
			1030	240	2,760	38	9,121	24.0647	324	0.0003	0.6721	0.0028	4	
		5/14/2009	1430	240	3,000	38	9,121	24.0647	334	0.0003	0.6928	0.0029	4	
			1530	60	3,060	38	2,280	6.0162	339	0.0003	0.1758	0.0029	4	
			1630	60	3,120	38	2,280	6.0162	459	0.0005	0.2380	0.0040	6	
			700	870	3,990	42	36,456	96.1892	294	0.0003	2.4377	0.0028	4	
		5/15/2009	1230	330	4,320	42	13,828	36.4855	294	0.0003	0.9246	0.0028	4	
			1330	60	4,380	42	2,514	6.6337	304	0.0003	0.1738	0.0029	4	
			1430	60	4,440	42	2,510	6.6228	302	0.0003	0.1724	0.0029	4	
			1530	60	4,500	42	2,510	6.6228	304	0.0003	0.1735	0.0029	4	
			1630	60	4,560	42	2,510	6.6228	301	0.0003	0.1718	0.0029	4	
			1000	1050	5,610	42	43,926	115.8993	328	0.0003	3.2769	0.0031	4	
			1230	150	5,760	42	6,275	16.5570	280	0.0003	0.3996	0.0027	4	
			1330	60	5,820	42	2,510	6.6228	299	0.0003	0.1707	0.0028	4	
STOP	1430	60	5,880	42	2,510	6.6228	265	0.0003	0.1513	0.0025	4			
	1530	60	5,940	42	2,510	6.6228	244	0.0002	0.1393	0.0023	3			
	1630	60	6,000	42	2,510	6.6228	286	0.0003	0.1633	0.0027	4			
	TOTAL				6,000		38	239,136	631	326	0.0003	20.29	0.0034	4.87
	MEDIAN													

Notes

Q volumetric flow rate
 SCFM standard cubic feet per minute
 ft³ cubic feet per minute
 VOC volatile organic compounds
 PID photo-ionization detector
 ppmv parts per million vapor

DERIVATION OF MASS REMOVAL RATE

ppmv as hexane/1,000,000 = VOC mole %
 ft³ of extracted air/(379 ft³ air/lb-mole air) = moles of extracted air
 (moles of extracted air)(VOC mole %)(86.2 lb/lb-mole hexane) = lbs of VOC removed as hexane
 (lbs of VOC mass removed as hexane)(elapsed time) = lbs/min of VOC removed as hexane
 (lbs/min of VOC removed as hexane)(60 min/1 hour)(24 hours/1 day) = lbs/day of VOC removed as hexane

Table 6

**Second Quarter 2009 MPE Event
Mass Removal**

3609 International Boulevard
Oakland, California

Extraction Well	Vapor Sample ID	Collection Date/Time	PID	Q (CFM)	Mass Removal Rate (lbs/day) (VOCs)	Total Test time (minutes/days)	Total Mass Removed (lbs) (VOCs)
			ppmv (hexane)				
MW-1/3/4R/6/8	Influent	5/12/09 @ 0900	464(a)	38	4.87	6,000/4.17	20.29 (b)
MW-1/3/4R/6/8	Stack	5/12/09 @ 0850	3(a)	38	N/A	N/A	N/A
REMOVAL EFFICIENCIES			99.3534%				

Notes

- CFM cubic feet per minute
- lbs/day pounds per day
- (a) dilution factor 1
- (b) average value

**DERIVATION OF MASS REMOVAL RATE
DERIVATION OF TOTAL MASS REMOVED**
Table 2

DERIVATION OF REMOVAL EFFICIENCIES
INFLUENT sample concentration / STACK concentration

Table 7**Dissolved-Phase Hydrocarbon Concentrations
Pre- and Post-MPE Event**3609 International Boulevard
Oakland, California

Monitoring Well	Date	MPE Event	TPH-g (µg/L)	Benzene (µg/L)	Toluene (µg/L)	Ethyl benzene (µg/L)	Total Xylenes (µg/L)	MtBE (µg/L)
MW-1	12/3/2007	Pilot Test	839	9	<2	1	<2.5	4
	12/7/2007	Pilot Test	2,270	20	6	34	50	11
	3/24/2008	March 2008	<50	<0.5	<2.0	<0.5	<2.5	<0.5
	3/28/2008	March 2008	705	10	4	8	40	5
	4/14/2008	April 2008	<50	<0.5	<2.0	<0.5	<2.5	<0.5
	4/18/2008	April 2008	3,710	27	21	47	303	11
	5/12/2008	May 2008	<50	<0.5	<2.0	<0.5	<2.0	1
	5/16/2008	May 2008	2,780	28	3	2	82	25
	6/9/2008	June 2008	<50	<0.5	<2.0	<0.5	<2.0	1
	6/13/2008	June 2008	1,730	11	8	53	92	9
	9/8/2008	September 2008	170 ^Y	0.68	<0.5	<0.5	<0.5	<0.5
	9/16/2008	September 2008	420 ^Y	1.20	1	1	16	<0.5
	10/6/2008	October 2008	130	0.78	<0.5	<0.5	1	<0.5
	10/14/2008	October 2008	160	1.30	1	1	9	<0.5

Table 7**Dissolved-Phase Hydrocarbon Concentrations
Pre- and Post-MPE Event**3609 International Boulevard
Oakland, California

Monitoring Well	Date	MPE Event	TPH-g (µg/L)	Benzene (µg/L)	Toluene (µg/L)	Ethyl benzene (µg/L)	Total Xylenes (µg/L)	MtBE (µg/L)
MW-3	12/3/2007	Pilot Test	2,040	2,200	<22	115	33	25
	12/7/2007	Pilot Test	4,610	785	57	275	262	6
	3/24/2008	March 2008	4,720	251	8	384	270	3
	3/28/2008	March 2008	13,700	653	395	514	1,153	<2.15
	4/14/2008	April 2008	6,350	124	19	231	464	<0.5
	4/18/2008	April 2008	4,630	191	101	74	692	<2.15
	5/12/2008	May 2008	3,460	111	8	99	222	<0.5
	5/16/2008	May 2008	16,600	795	371	427	3,807	10
	6/9/2008	June 2008	3,770	177	8	161	209	1
	6/13/2008	June 2008	6,910	534	283	233	1,241	<5.5
	9/8/2008	September 2008	2200 ^Y	64	14	73	103	2
	9/16/2008	September 2008	320 ^Y	9	1	<0.5	22	5
	10/6/2008	October 2008	2,400	250	59	99	320	6
	10/14/2008	October 2008	270	16	2	1	24	5
MW-6	9/8/2008	September 2008	4600 ^Y	340	15	120	118	<2.5
	9/12/2008	September 2008	5,800 ^Y	300	66	110	518	<2
	10/6/2008	October 2008	5,400	890	110	53	588	<5
	10/14/2008	October 2008	10,000	900	280	540	1,550	<6.3

Notes:

TPHg = Total petroleum hydrocarbons as gasoline

TPHd = Total petroleum hydrocarbons as diesel

MTBE = methyl-tertiary-butyl ether

ug/l - Micrograms per liter

FIGURES

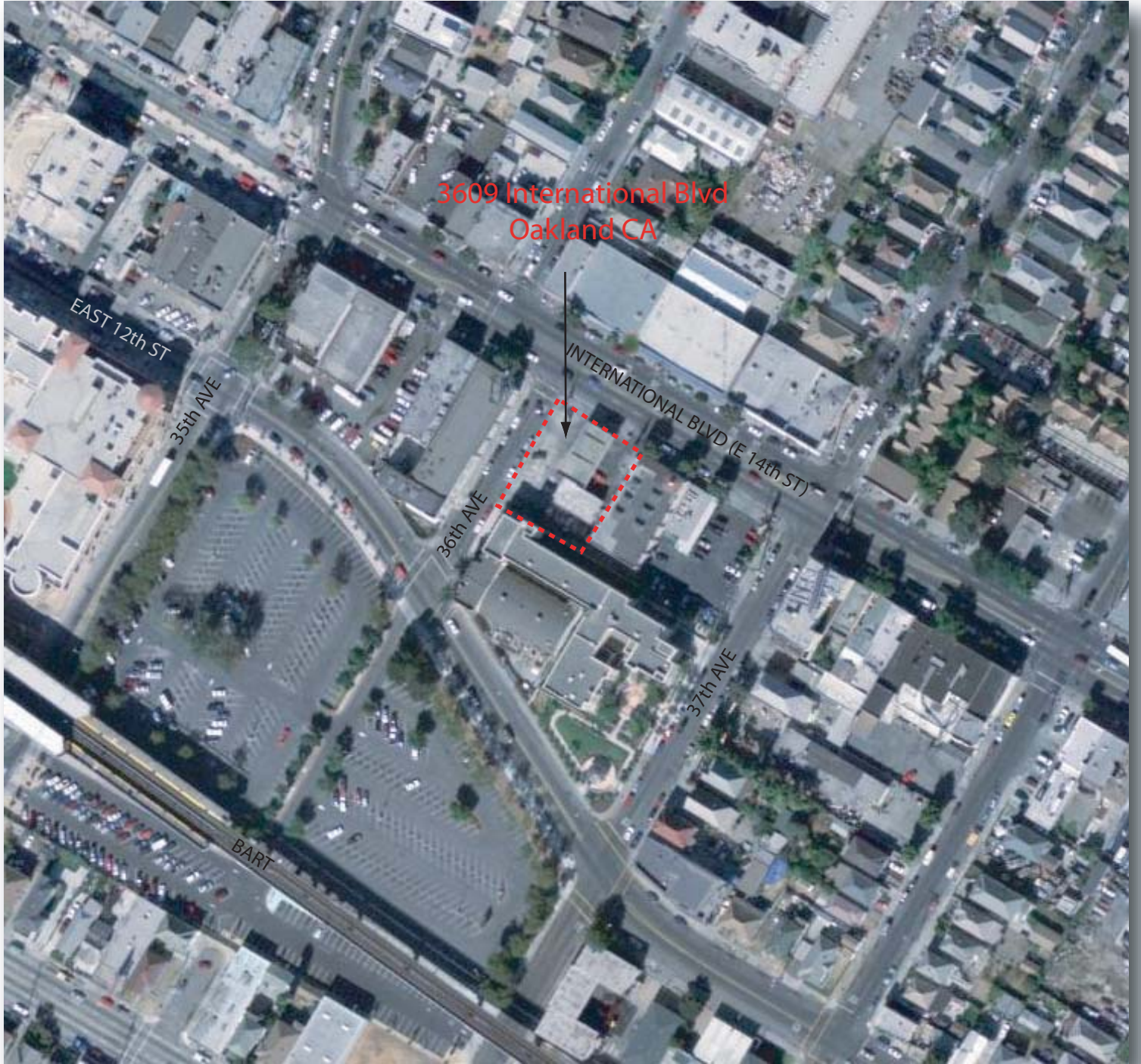

3609 International Blvd
Oakland CA

EAST 12th ST

35th AVE

36th AVE

37th AVE

INTERNATIONAL BLVD (E 14th ST)

BART

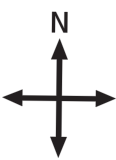

approximate scale in feet



Figure 1: Site vicinity map.

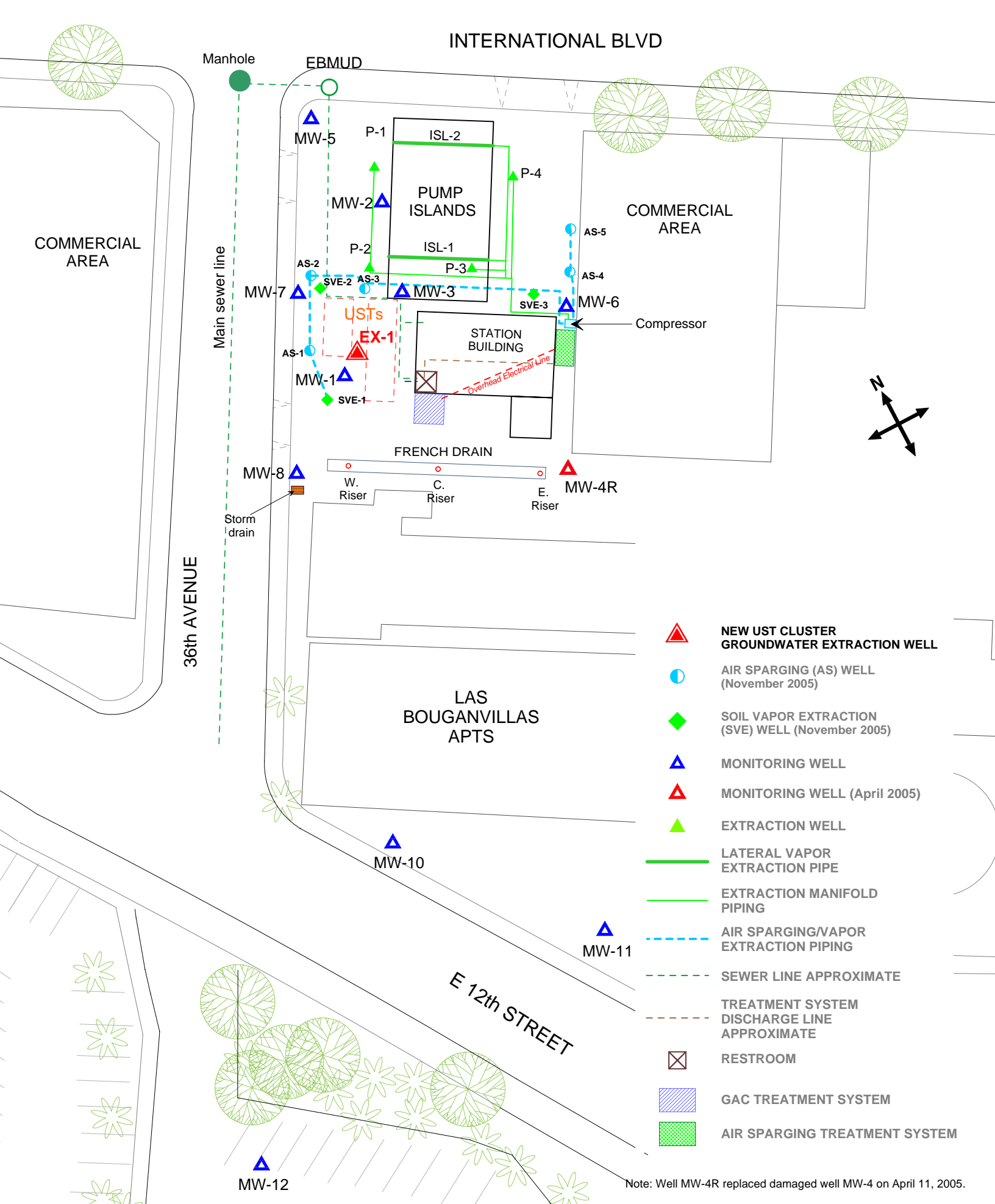

approximate scale in feet
 0 20 40

Figure 2: Site map showing the locations of air sparging wells, groundwater monitoring wells, additional soil vapor wells, GAC System, SVE system, & extraction well



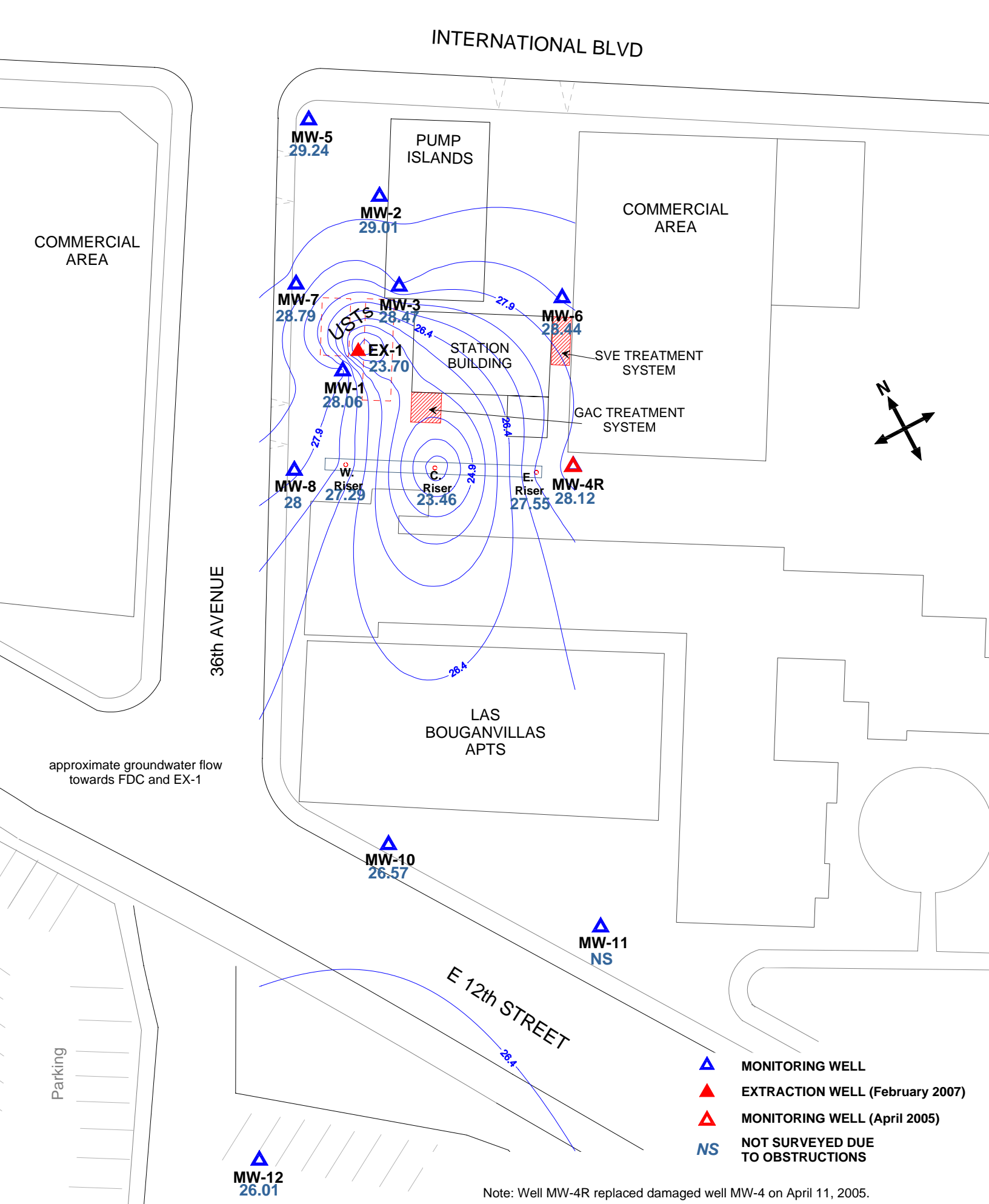
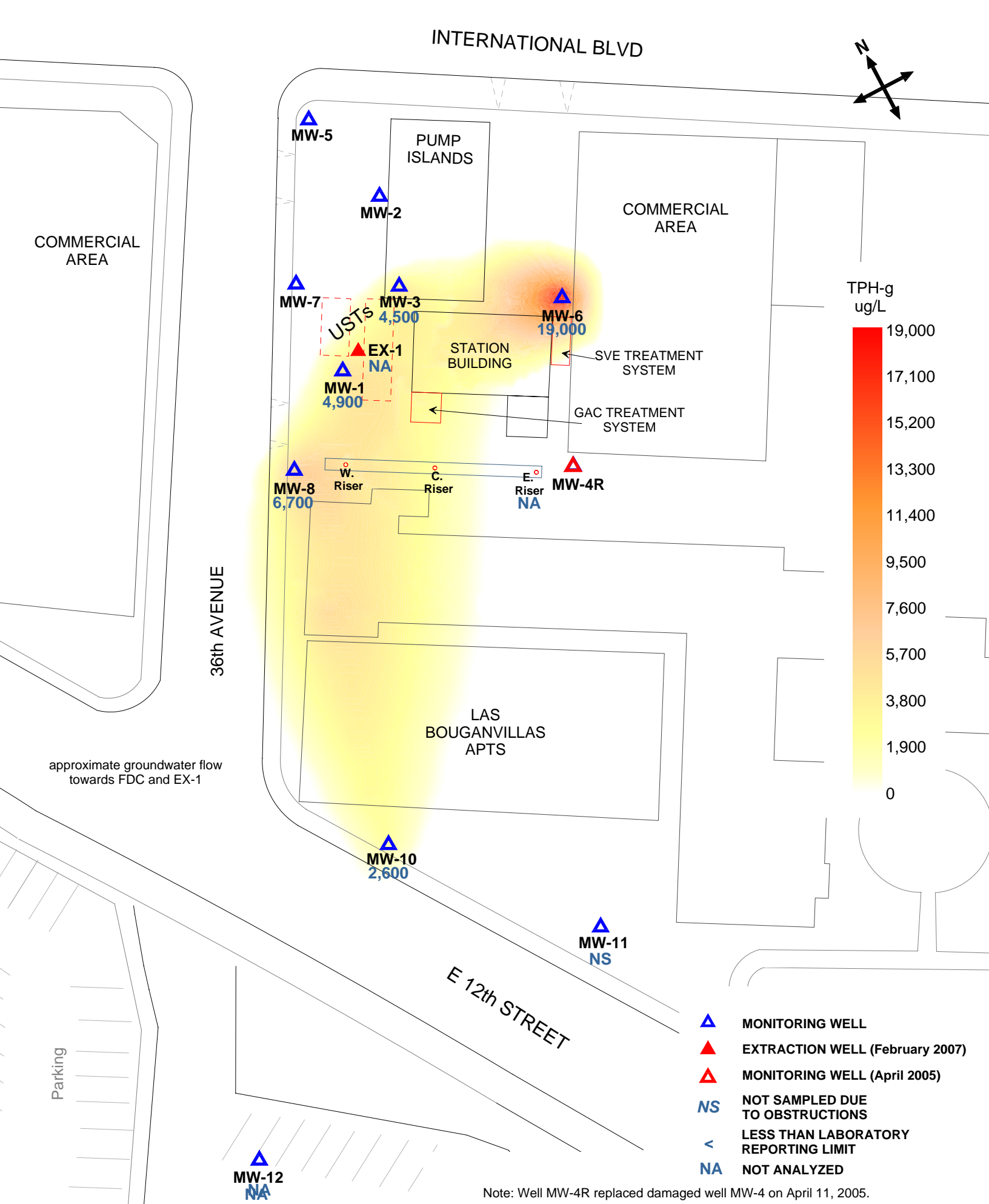

Figure 3: Groundwater elevation contour map in feet, June 8, 2009





Note: Well MW-4R replaced damaged well MW-4 on April 11, 2005.

approximate scale in feet
 0 20 40

Figure 4: Contour map of TPH-g concentrations in the groundwater. June 8, 2009



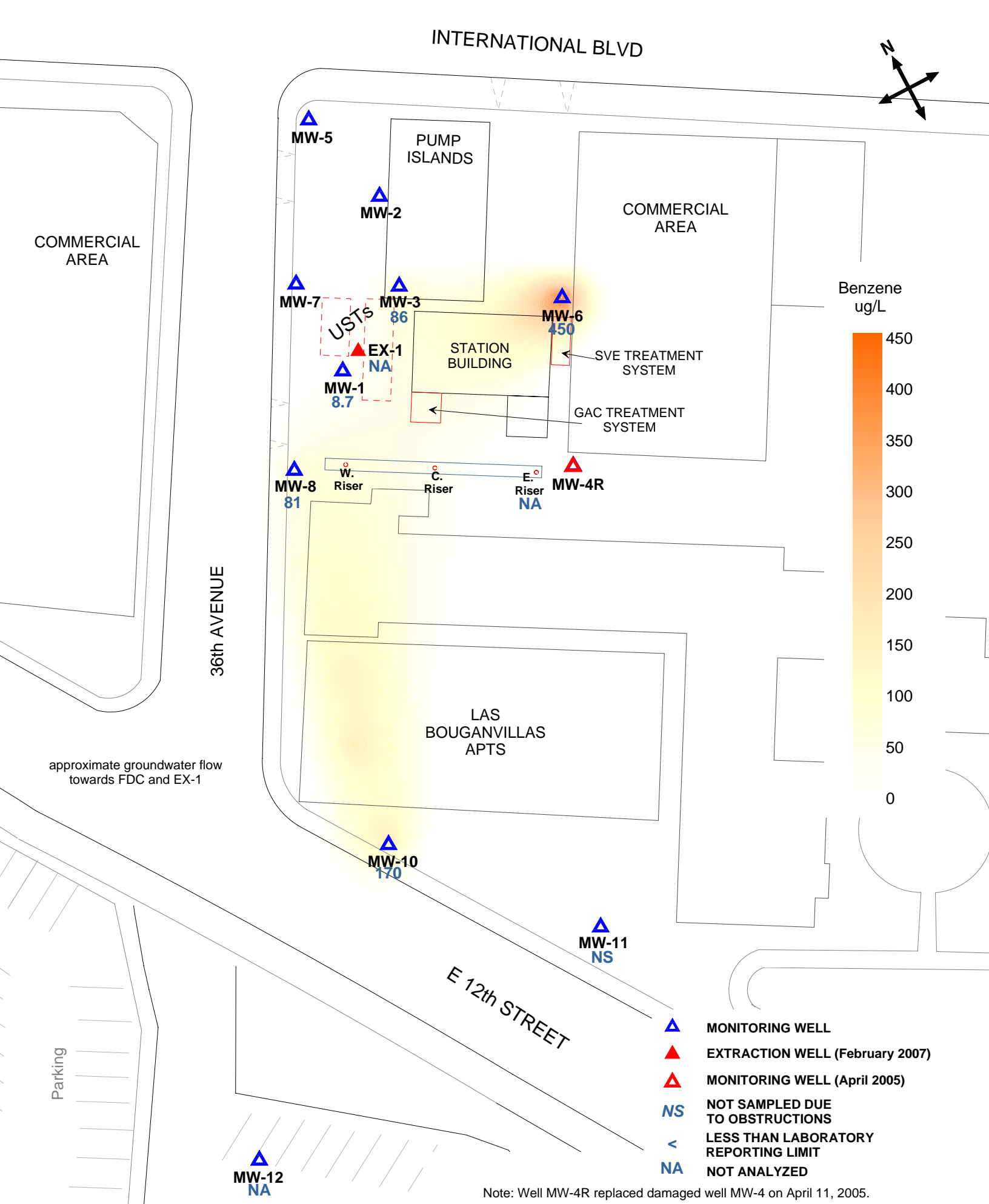

approximate scale in feet



Figure 5: Contour map of benzene concentrations in the groundwater.
June 8, 2009

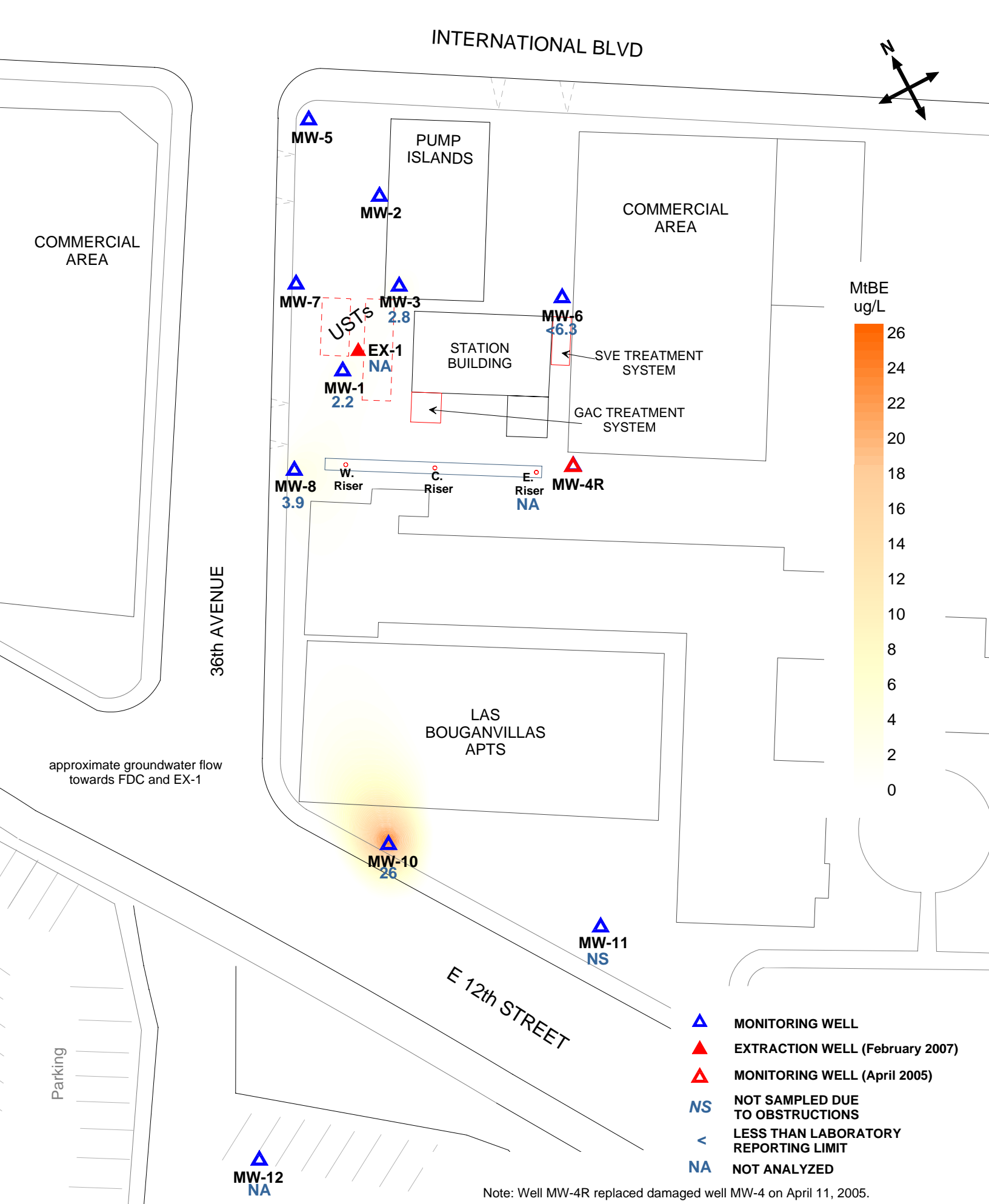

Note: Well MW-4R replaced damaged well MW-4 on April 11, 2005.

approximate scale in feet
0 20 40

Figure 6: Contour map of MtBE concentrations in the groundwater (EPA Method 8260B). June 8, 2009



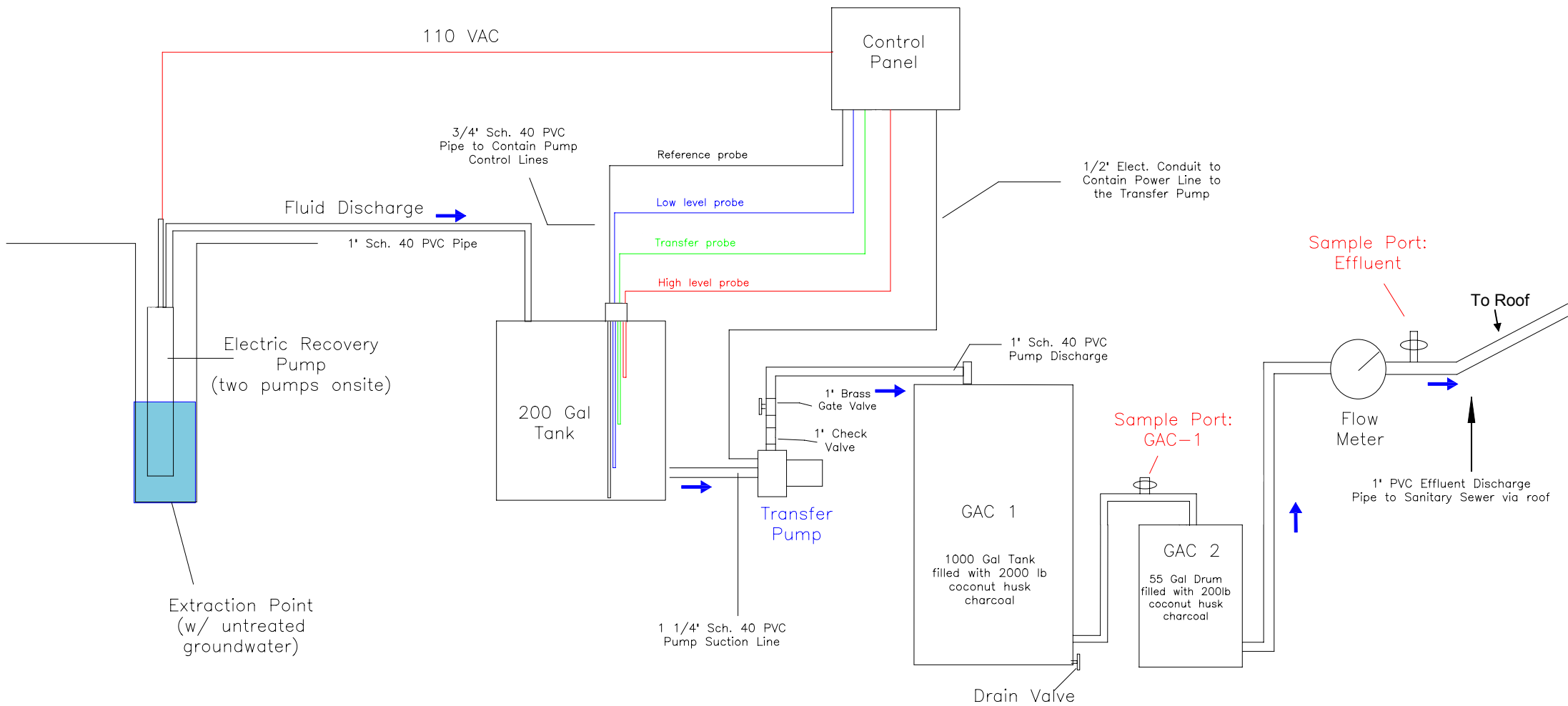

(Discharge permit No: 504-27421)
 Tony's Express Auto Service. November 14, 2011 permit expires

Figure 7: Schematic of the Groundwater Remediation System.
 3609 International Blvd., Oakland, CA

Figure 8: Cumulative Mass of TPH-g and MtBE Removed from Groundwater since the Installation of the Treatment System

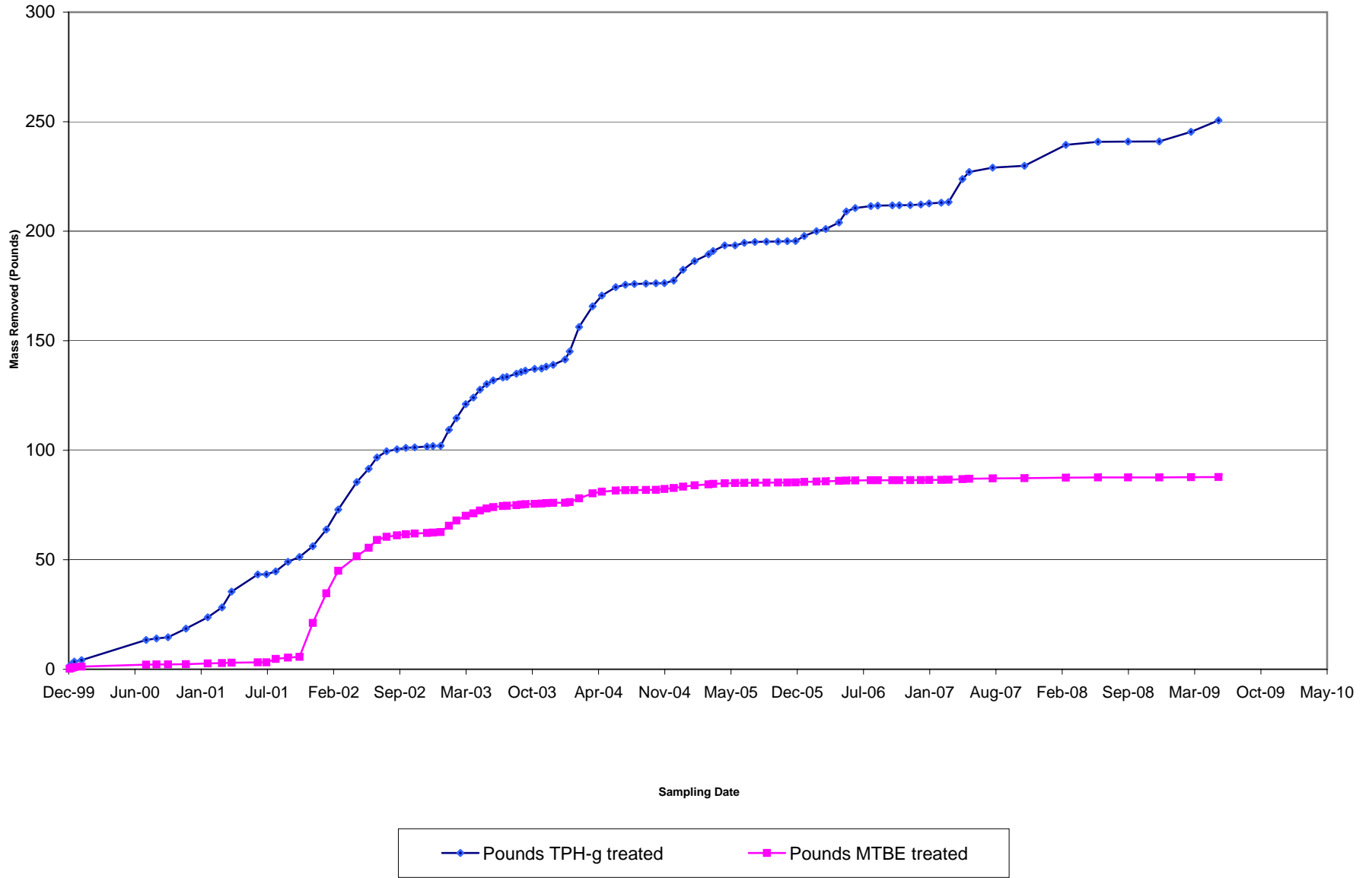

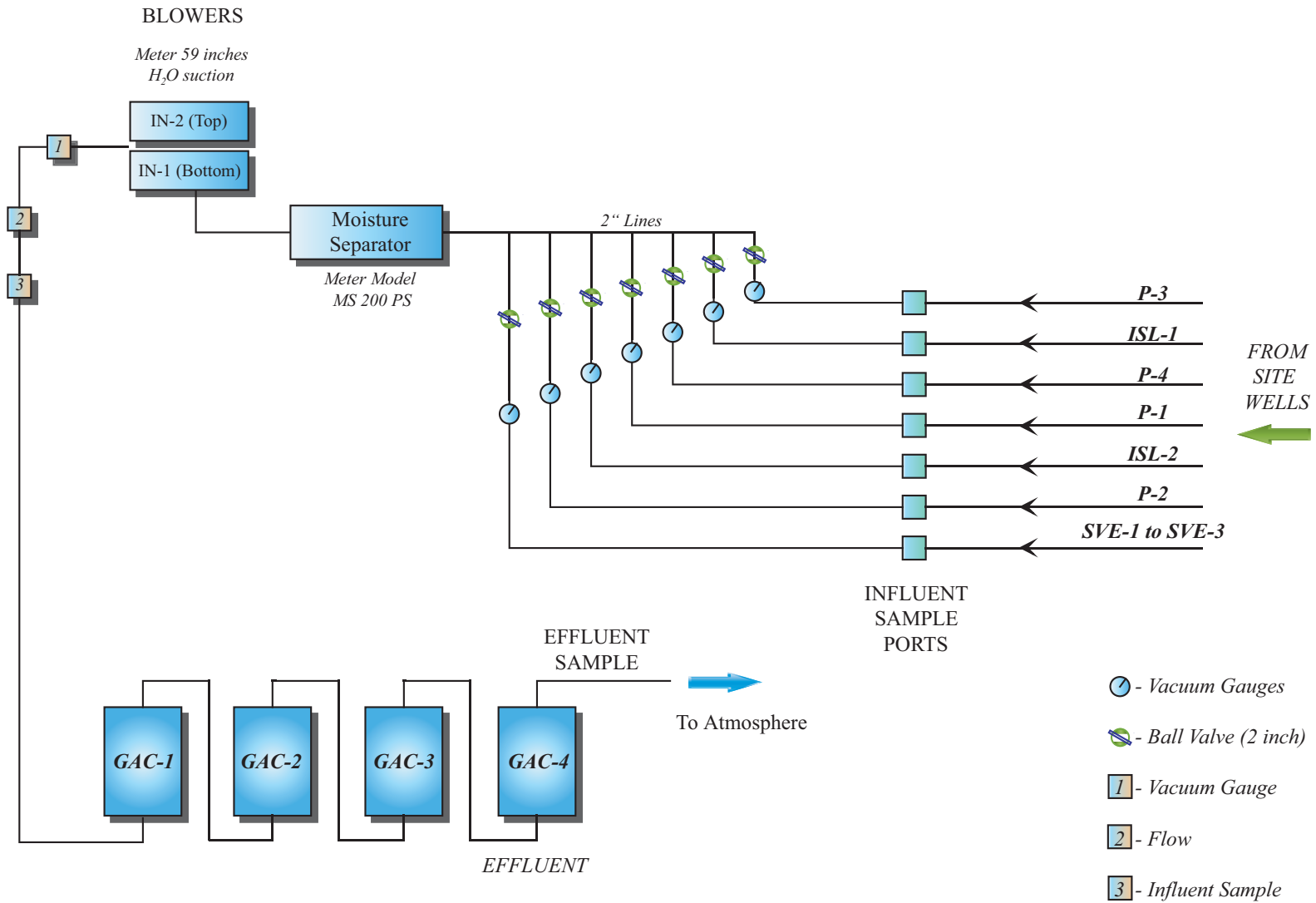

Figure 9: Block Diagram of SVE System

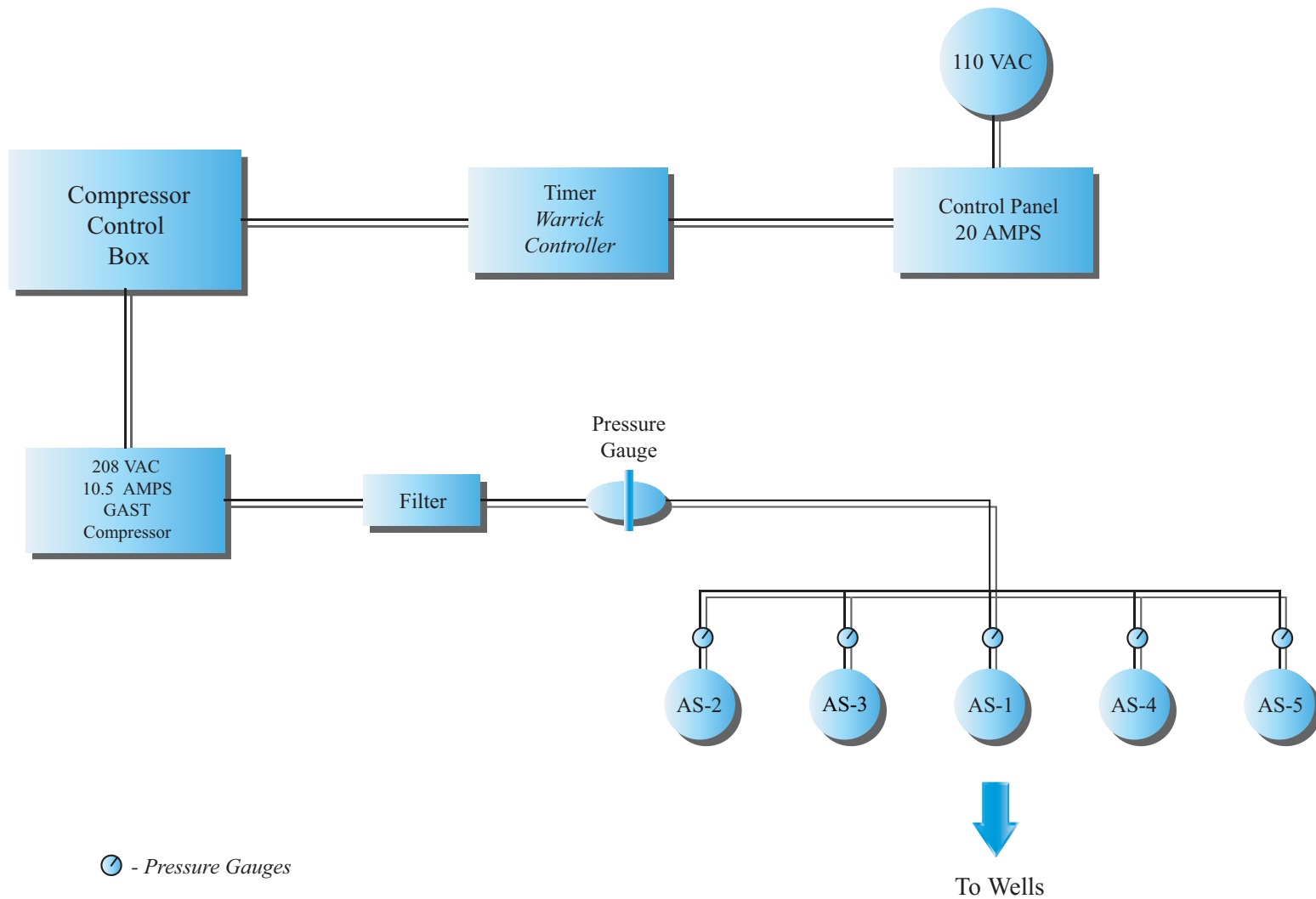

Figure 10: Block diagram of the Air Sparge System

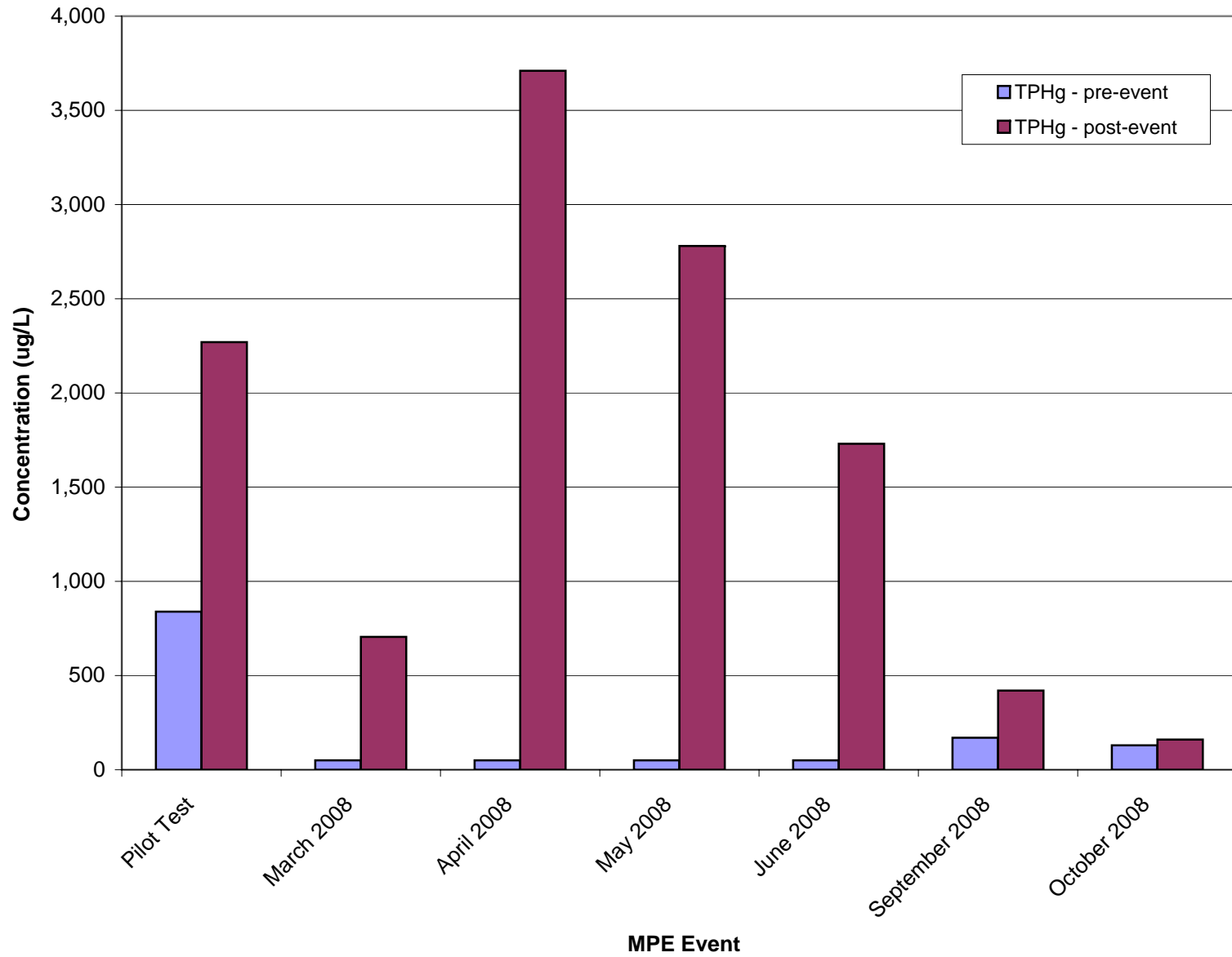

Figure 11: Dissolved-Phase Hydrocarbon Concentrations in Groundwater, TPH-g, Pre- and Post-MPE Event, MW-1

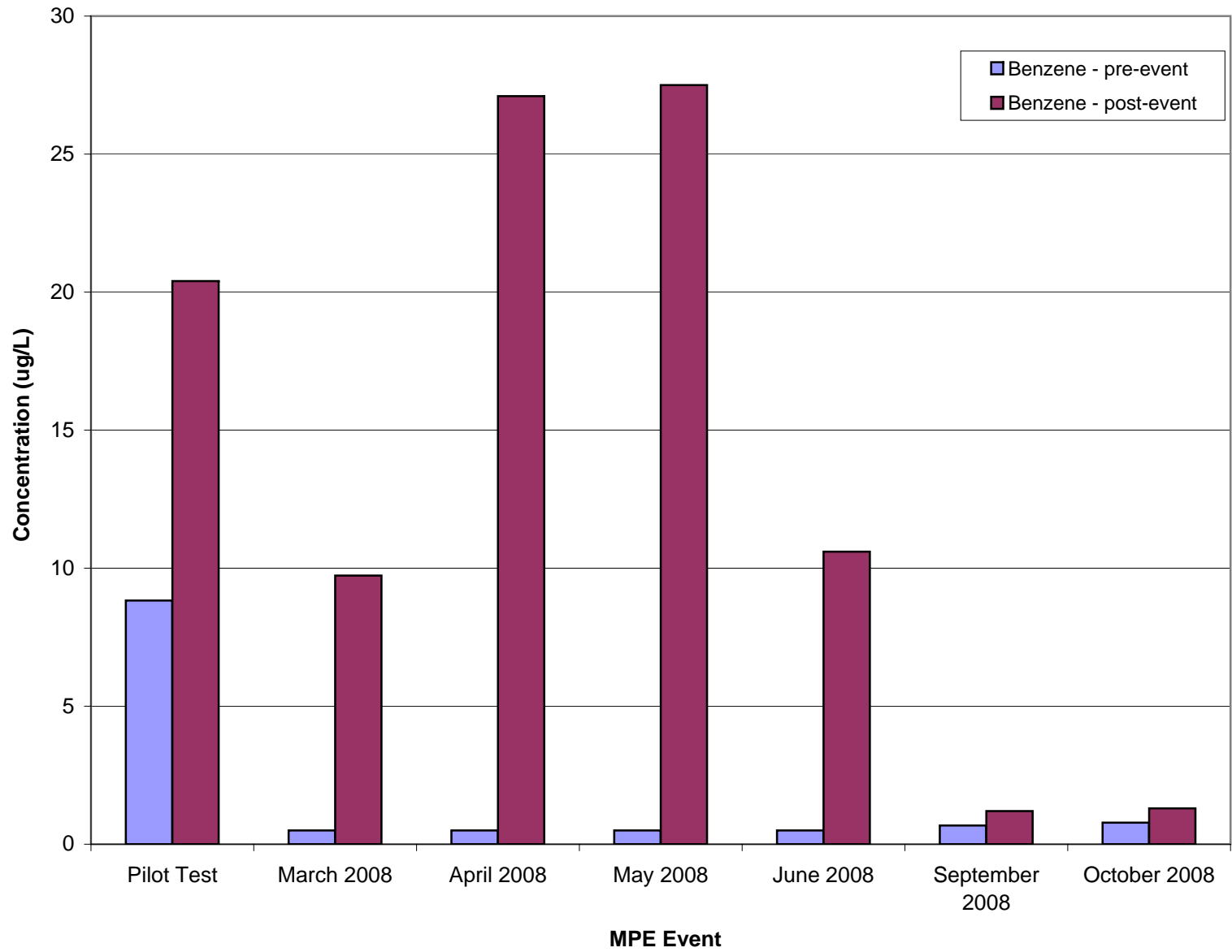

Figure 12: Dissolved-Phase Hydrocarbon Concentrations in Groundwater, Benzene, Pre- and Post-MPE Event, MW-1

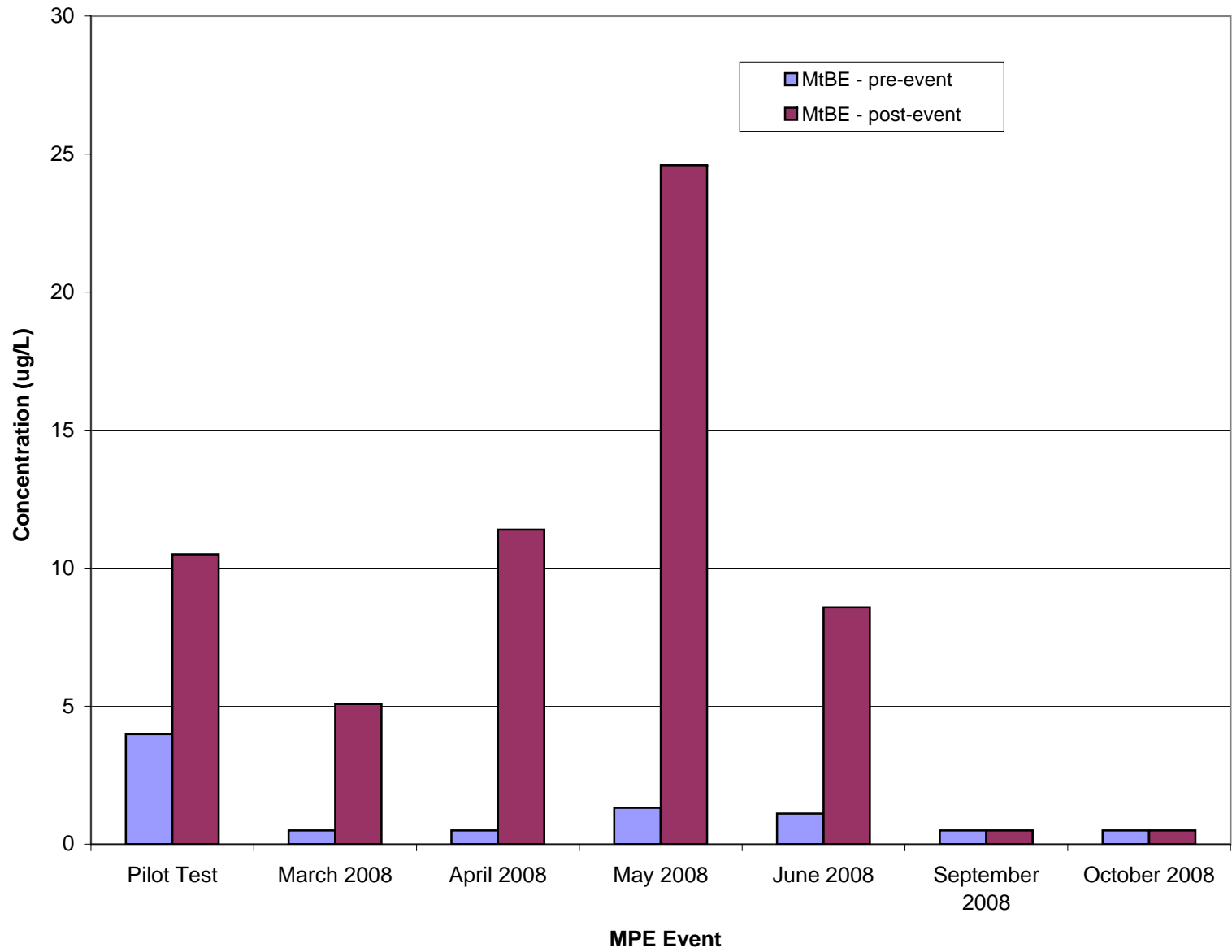

Figure 13: Dissolved-Phase Hydrocarbon Concentrations in Groundwater, MtBE, Pre- and Post-MPE Event, MW-1

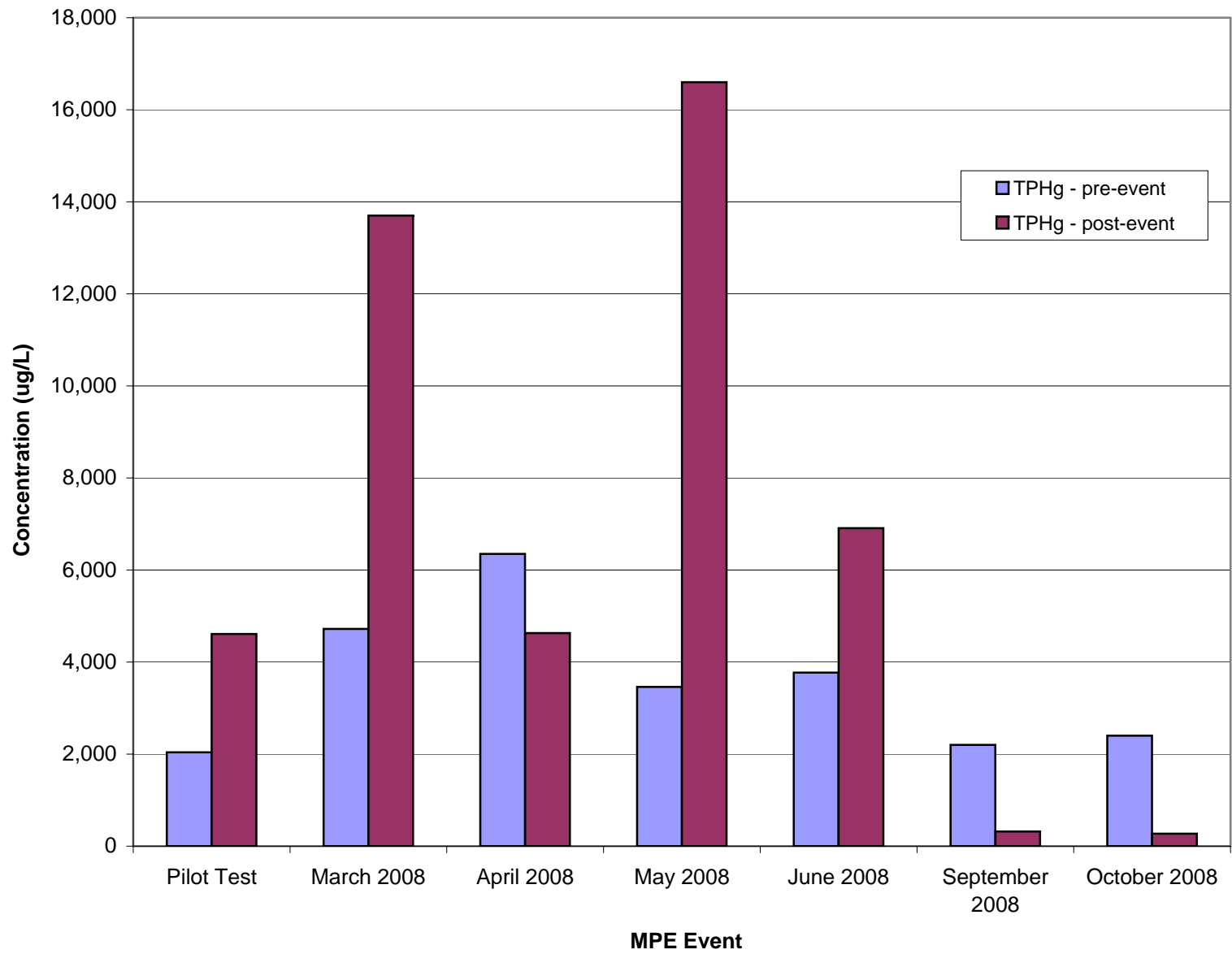

Figure 14: Dissolved-Phase Hydrocarbon Concentrations in Groundwater, TPH-g, Pre- and Post-MPE Event, MW-3

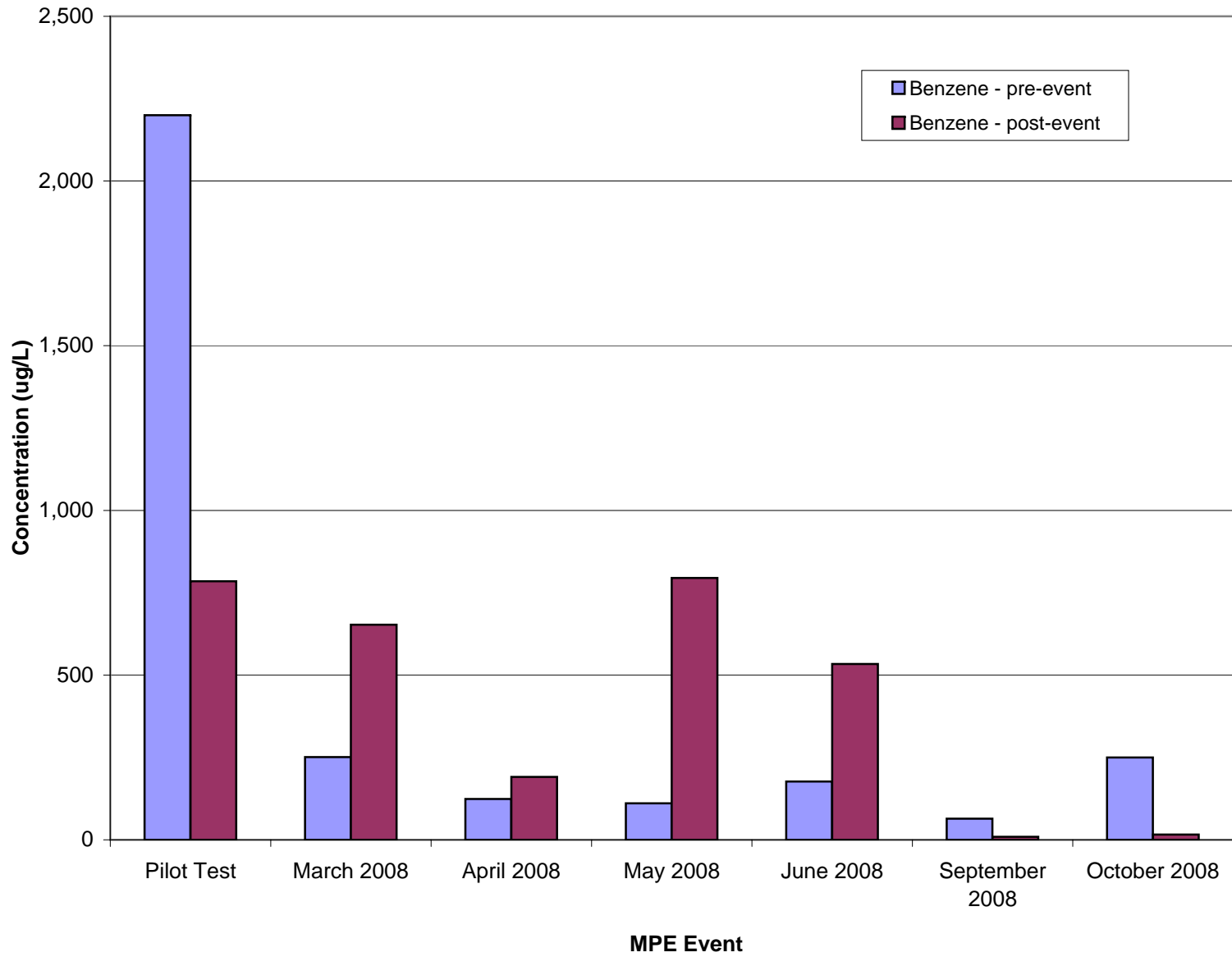

Figure 15: Dissolved-Phase Hydrocarbon Concentrations in Groundwater, Benzene, Pre- and Post-MPE Event, MW-3

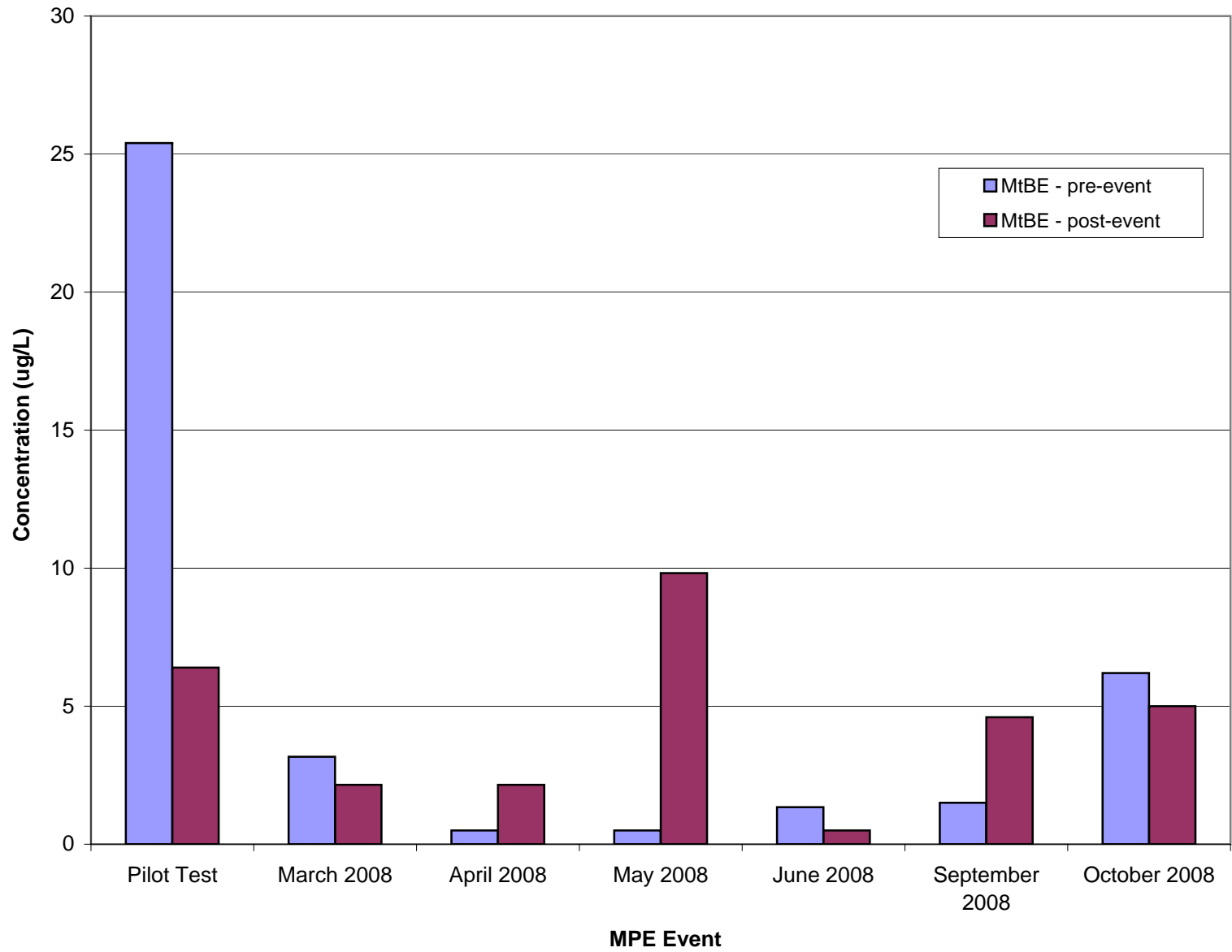

Figure 16: Dissolved-Phase Hydrocarbon Concentrations in Groundwater, MtBE, Pre- and Post-MPE Event, MW-3

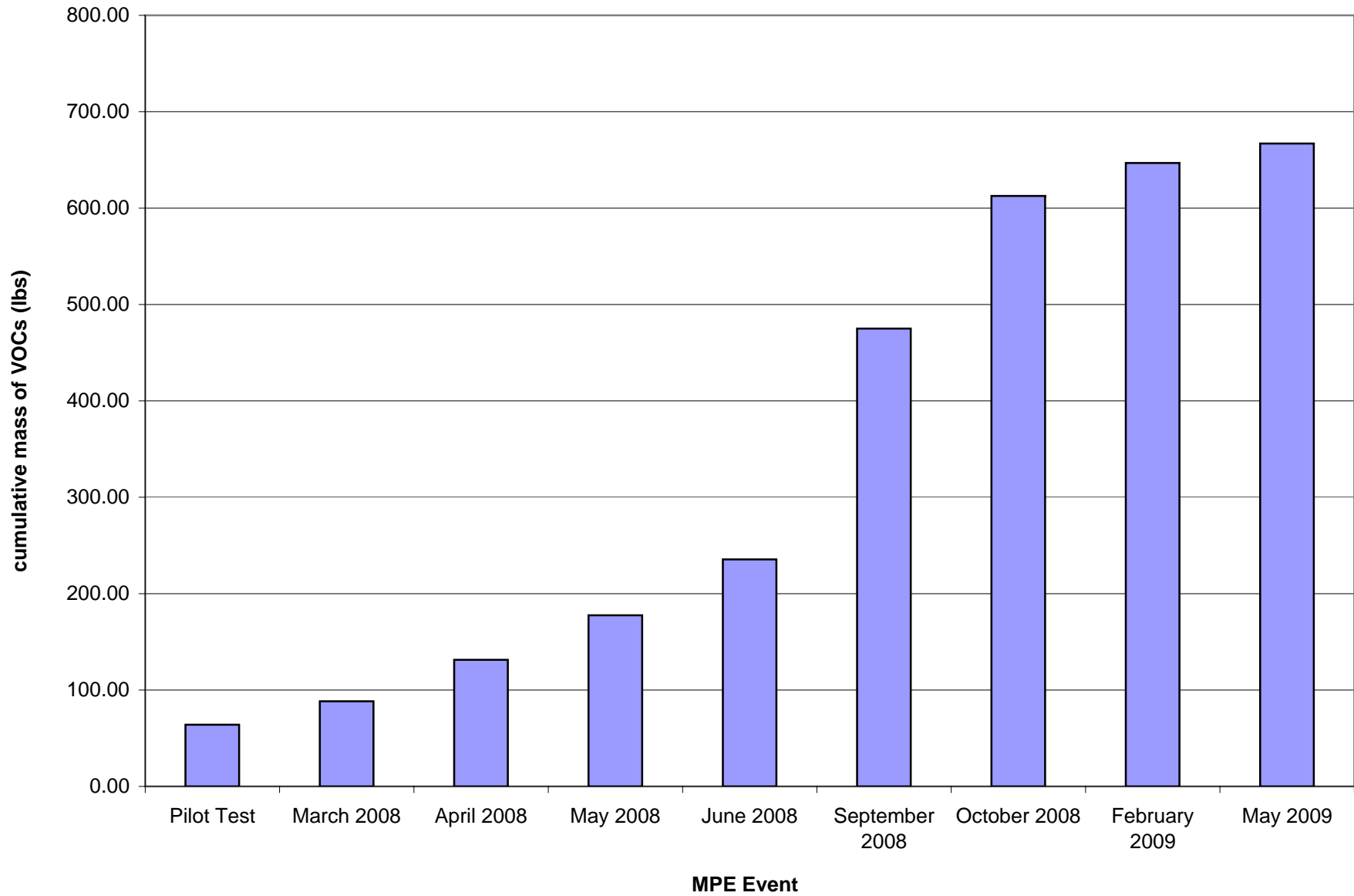

Figure 17: Cumulative Mass of VOCs Removed

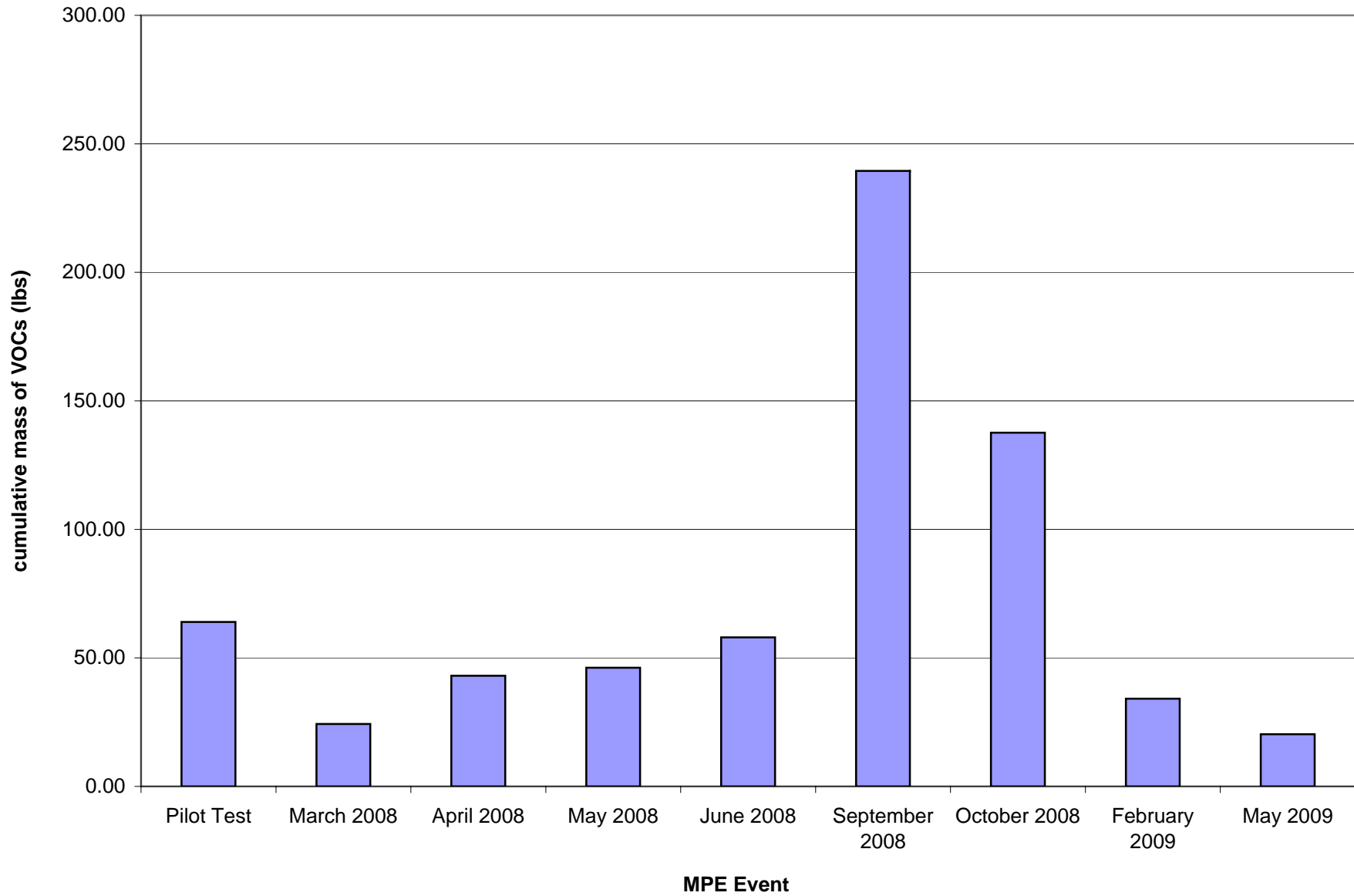

Figure 18: Mass of VOCs Removed Per Event

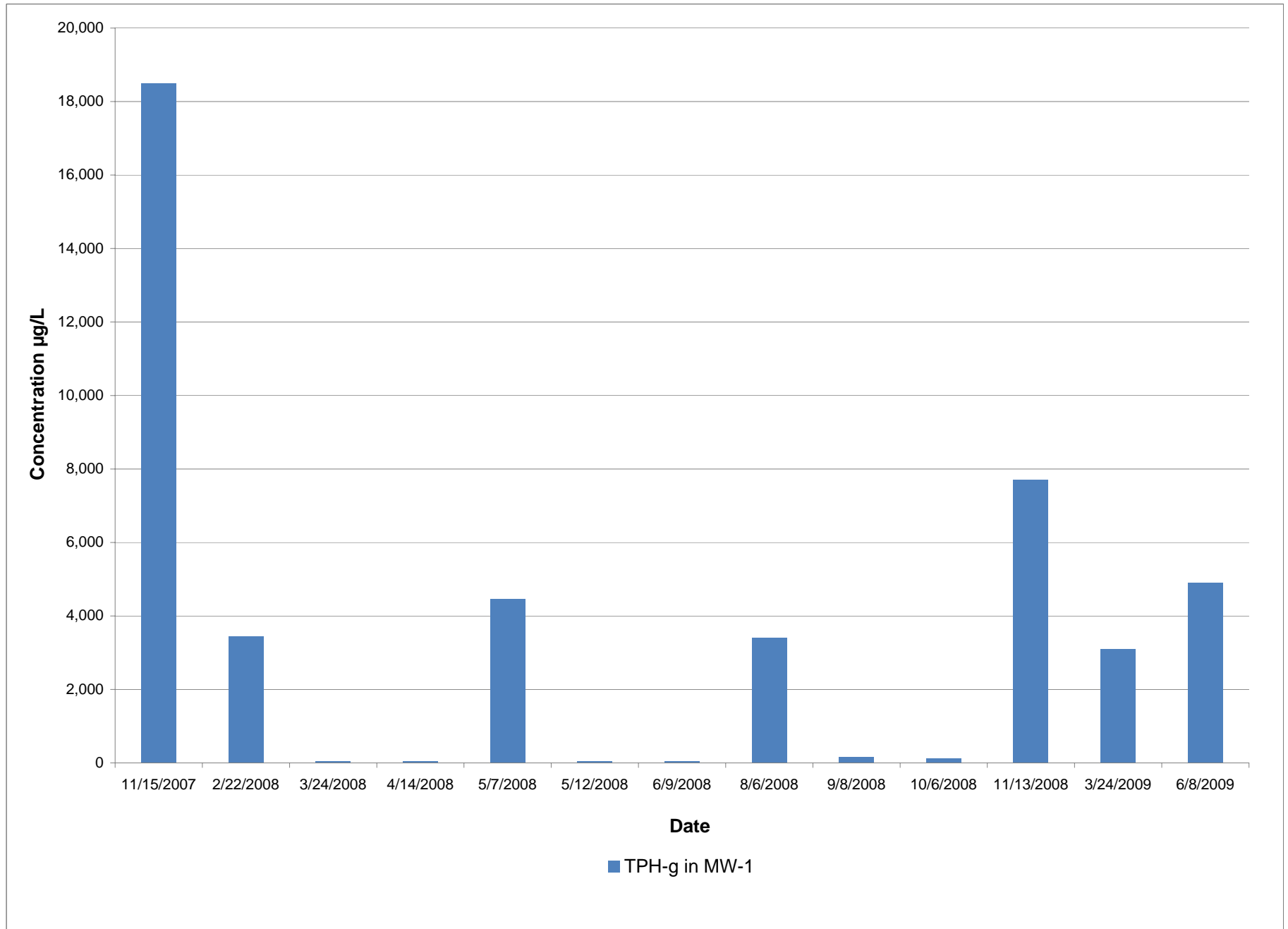

Figure 19: Comparison of TPH-g Concentrations in MW-1

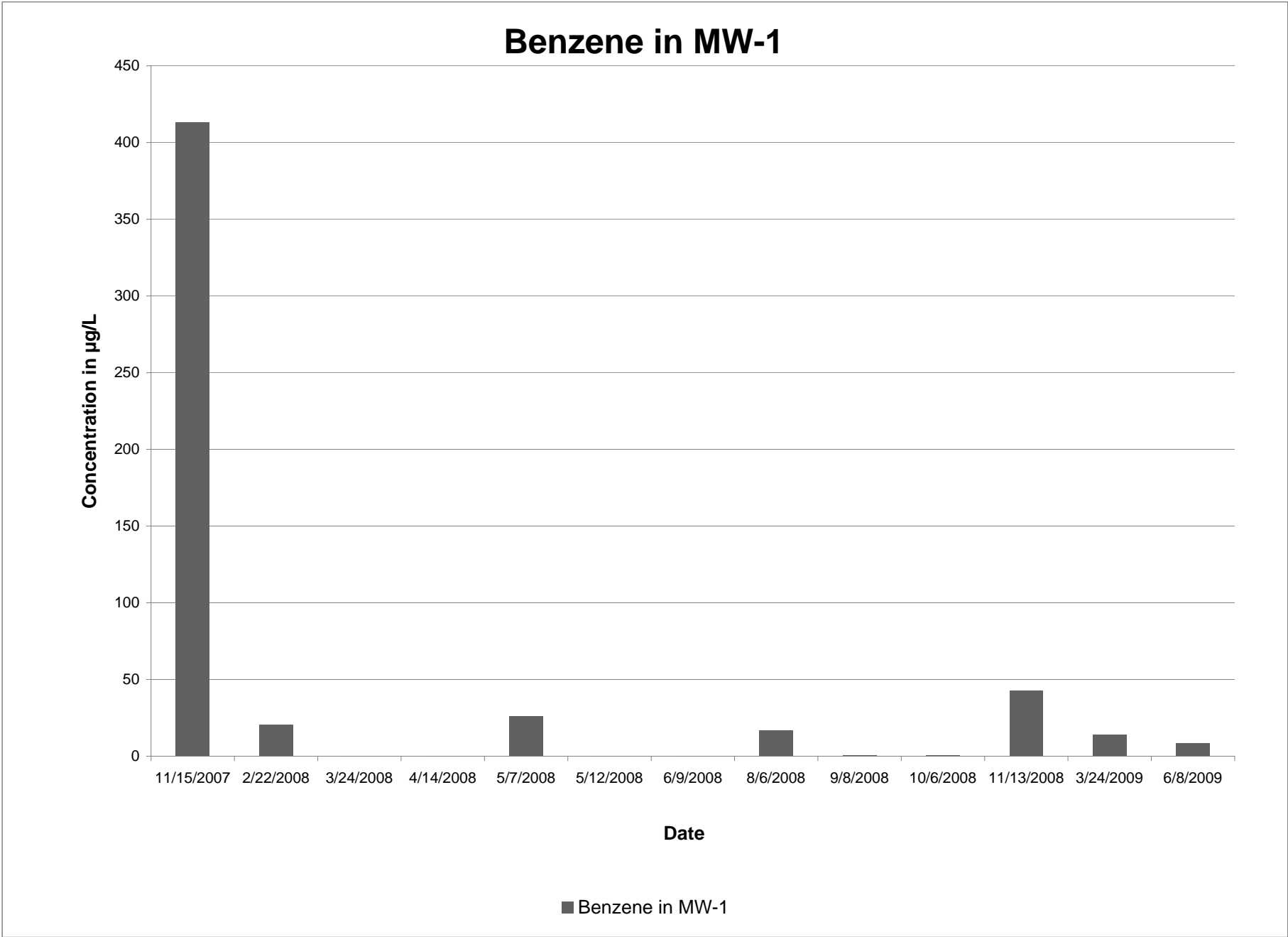

Figure 20: Comparison of Benzene Concentrations in MW-1

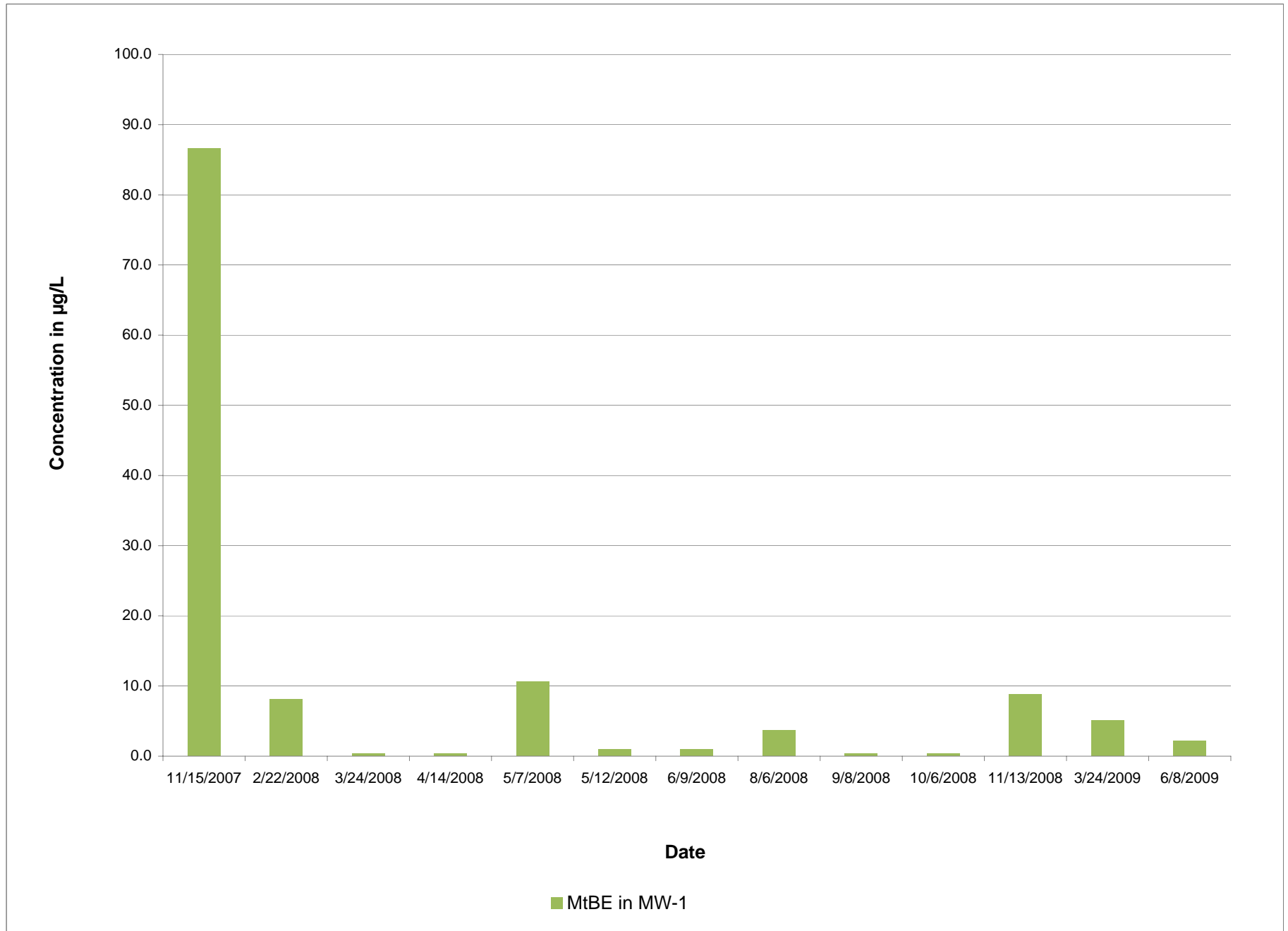

Figure 21: Comparison of MtBE Concentrations in MW-1

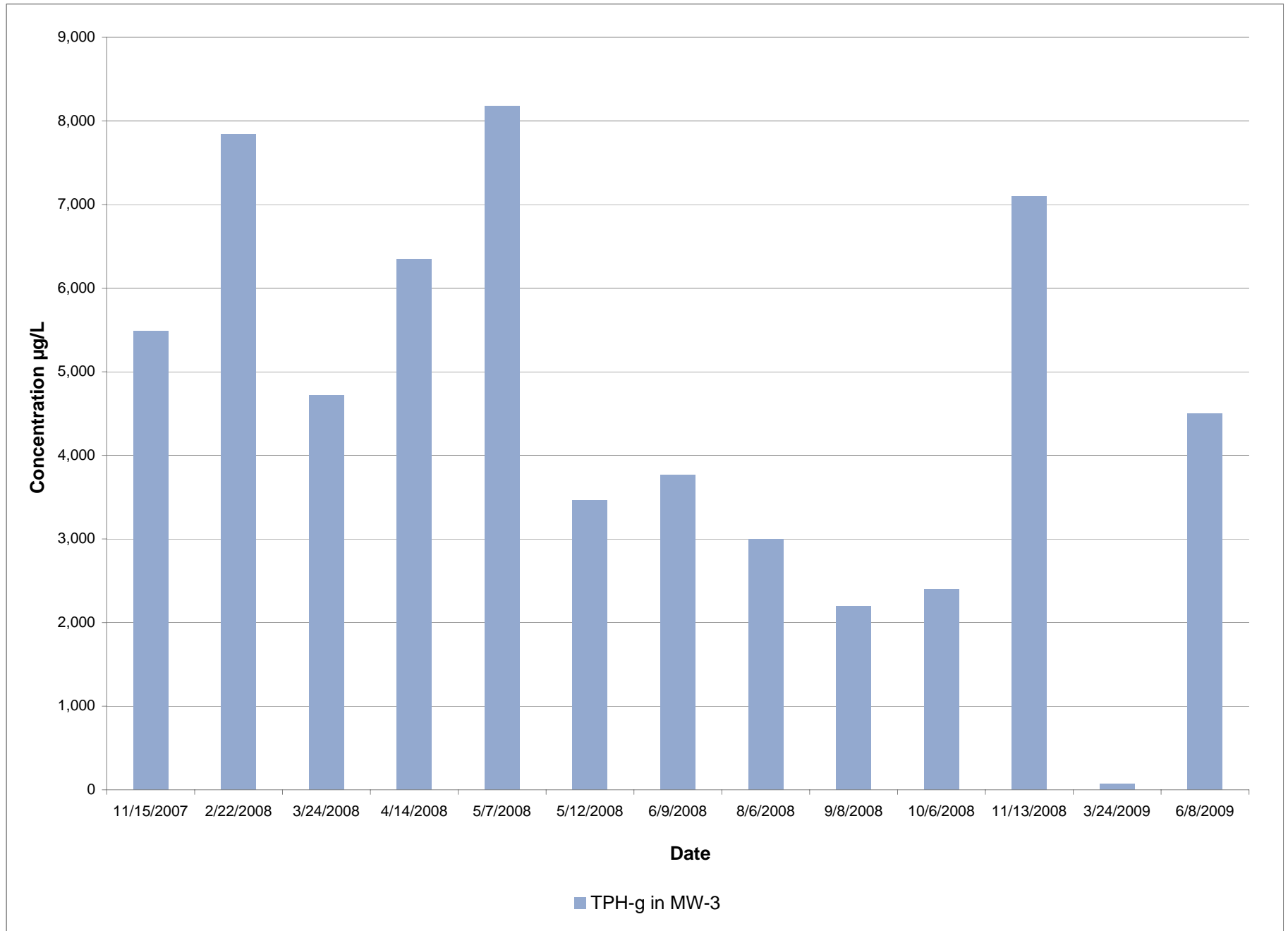

Figure 22: Comparison of TPH-g Concentrations in MW-3

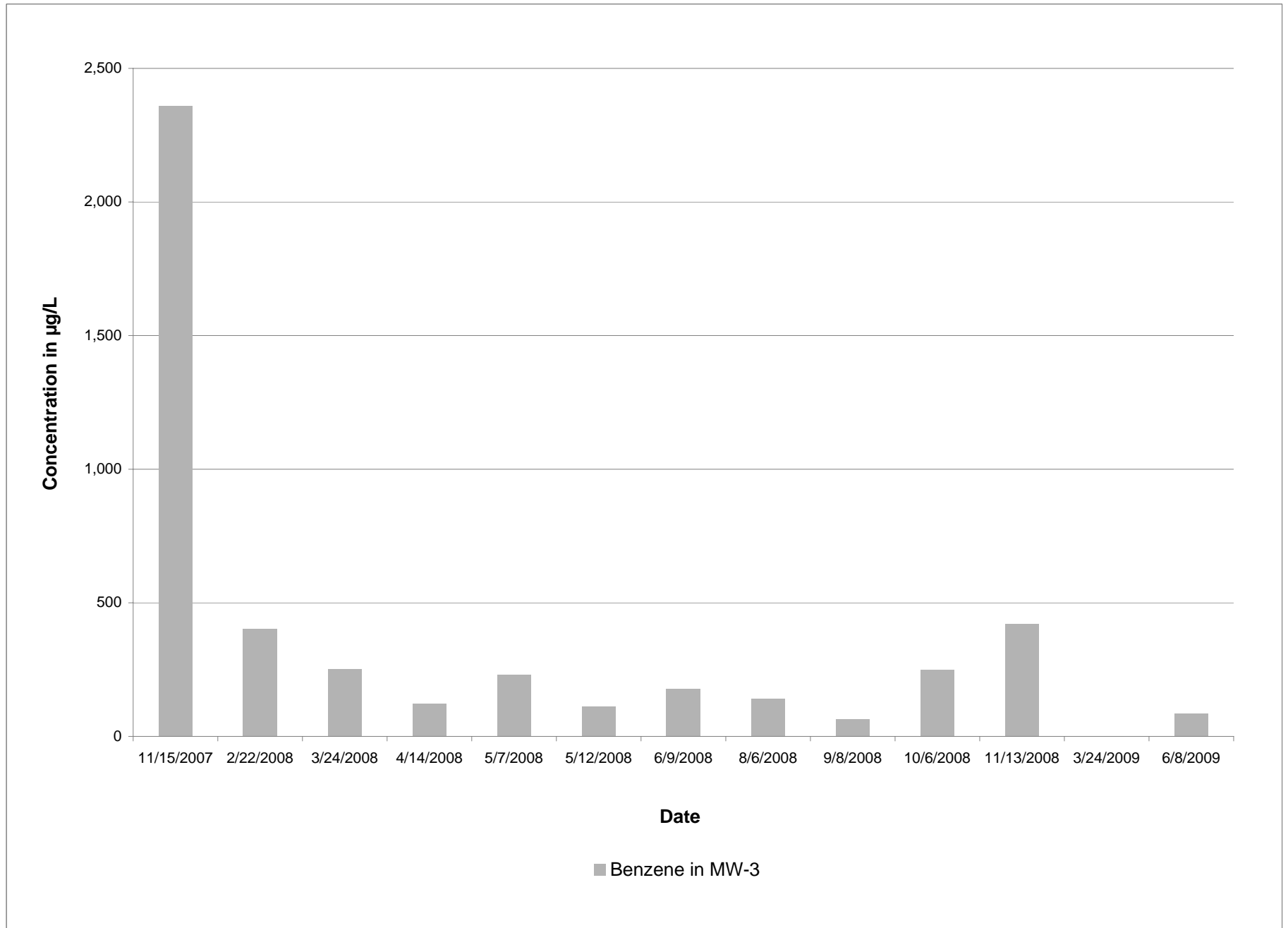

Figure 23: Comparison of Benzene Concentrations in MW-3

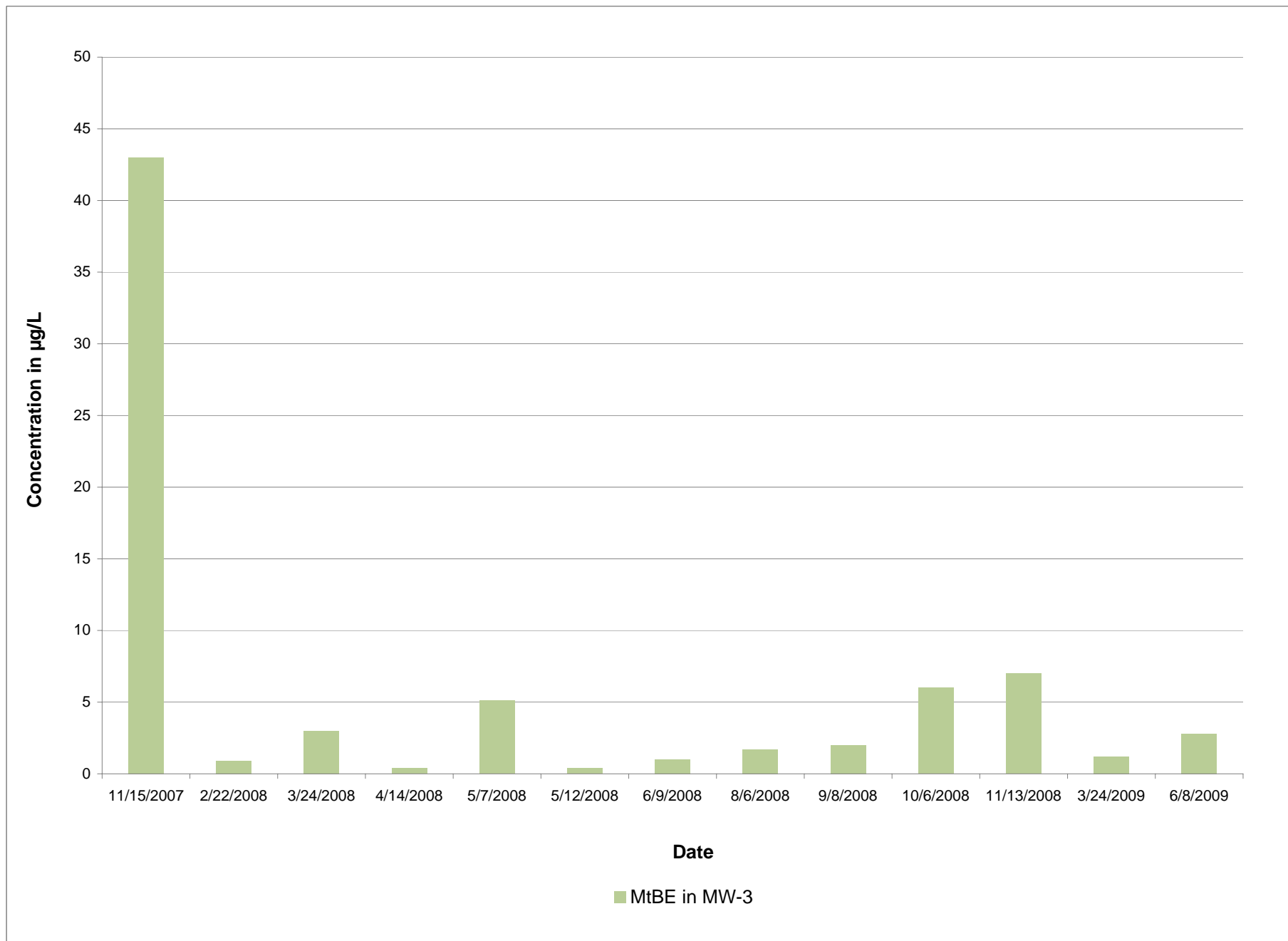

Figure 24: Comparison of MtBE Concentrations in MW-3

APPENDIX A

Standard Operating Procedures for Conducting Groundwater Monitoring Activities

Second Quarter 2009: Groundwater Monitoring and Remediation System Report
With Evaluation of Effectiveness of Monthly MPE

Standard Operating Procedures for Conducting Groundwater Monitoring Activities

Prior to measurement of groundwater depth at each well, equalization with the surrounding aquifer must be achieved. Initially, the well cap is removed and the pressure is allowed to dissipate, creating a more stable water table level within the well. After about 10-15 minutes, once the water level in the well stabilizes, the depth to groundwater is measured from the top of the casing to the nearest 0.01 foot using an electric sounder.

Prior to sample collection, each well is purged using a battery-operated, 2-inch-diameter pump (Model ES-60 DC). During purging, groundwater is measured for parameters such as dissolved oxygen (DO), pH, temperature, electrical conductivity (EC), and oxygen-reduction potential (ORP) using a Hanna HI-9828 multi-parameter instrument. Turbidity is measured using a Hanna HI-98703 portable turbidimeter. The equipment is calibrated at the Site using standard solutions and procedures provided by the manufacturer.

The pH of groundwater has an effect on the activity of microbial populations in the groundwater. The groundwater temperature affects the metabolic activity of bacteria. The groundwater EC is directly related to the concentration of total dissolved solids (TDS) in solution.

There is a strong correlation between the turbidity level and the biological oxygen demand of natural water bodies. The main purpose for checking the turbidity level is to provide a general overview of the extent of the suspended solids in the groundwater.

ORP is the measure of the potential for an oxidation or reduction process to occur. In the oxidation process, a molecule or ion loses one or several electrons. In the reduction process, a molecule or ion gains one or several electrons. The unit of the redox potential is the volt or millivolt. The most important redox reaction in petroleum-contaminated groundwater is the oxidation of petroleum hydrocarbons in the presence of bacteria and free molecular oxygen. Because the solubility of O₂ in water is low (9 mg/L at 25 °C and 11 mg/L at 5 °C), and because the rate of O₂ replenishment in subsurface environments is limited, DO can be entirely consumed when the oxidation of only a small amount of petroleum hydrocarbons occurs.

Oxidation of petroleum hydrocarbons can still occur when all the dissolved O₂ in the groundwater is consumed; however, the oxidizing agents (i.e., the constituents that undergo reduction) now become NO₃⁻, MnO₂, Fe (OH)₃, SO₄²⁻ and others (Freeze and Cherry, 1979). As these oxidizing agents are consumed, the groundwater environment becomes more and more reduced. If the process advances far enough, the environment may become so strongly reduced that the

petroleum hydrocarbons undergo anaerobic degradation, resulting in the production of methane and carbon dioxide. The concept of oxidation and reduction in terms of changes in oxidation states is illustrated below.

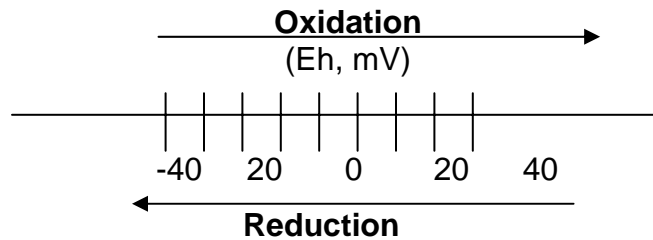

Purging of wells continues until the parameters for DO, pH, temperature, EC, turbidity, and redox stabilize, or three casing volumes are purged.

Once stabilization occurs, the groundwater samples are also tested on-site for ferrous iron (Fe^{+2}), nitrate (NO_3^-), and sulfate (SO_4^{-2}) concentrations.

Fe^{+2} , NO_3^- , and SO_4^{-2} are measured colorimetrically using the Hach Colorimeter Model 890, a microprocessor-controlled photometer suitable for colorimetric testing in the laboratory or the field. The required reagents for each specific test are provided in AccuVac ampuls.

For sampling purposes, after purging a disposable polyethylene bailer is used to collect sufficient samples from each monitoring well for laboratory analyses. Groundwater samples are transferred into 40-mL VOA vials and preserved with hydrochloric acid. The vials are sealed to prevent development of air bubbles within the headspace. For TPH-d analysis, groundwater samples are collected using 1-L, amber, nonpreserved glass containers. Samples are placed in an ice-filled cooler and maintained at 4°C. A chain of custody form is prepared to be delivered with the samples, which are delivered promptly to a California state-certified analytical laboratory.

Appendix B

Table of Elevations and Coordinates of Monitoring Wells
and Field Measurements of Physical, Chemical, and
Biodegradation Parameters of Groundwater

**TABLE OF ELEVATIONS & COORDINATES
 ON MONITORING WELLS**
 SOMA ENVIRONMENTAL
 Oakland-E. 14 the St. "International Blvd"

WELL NO.	NORTHING	EASTING	ELEVATION	DESCRIPTION
FD-C	2109299.85	6064039.85	39.35 40.25	Notch on north side of PVC Punch north rim of box
FD-E	2109281.13	6064067.87	40.06 40.55	Notch on north side of PVC Punch north rim of box
FD-W	2109314.99	6064017.59	39.16 39.95	Notch on north side of PVC Punch north rim of box
MW-1	2109338.74	6064025.97	40.11 40.76	Notch on north side of PVC Punch north rim of box
MW-2	2109383.20	6064073.06	40.71 41.61	Notch on north side of PVC Punch north rim of box
MW-3	2109351.11	6064064.63	40.91 41.68	Notch on north side of PVC Punch north rim of box
MW-4	2109278.18	6064076.40	40.01 40.67	Notch on north side of PVC Punch north rim of box
MW-5	2109410.84	6064058.46	41.16 41.60	Notch on south side of PVC Punch south rim of box
MW-6	2109320.46	6064105.06	40.92 41.52	Notch on north side of PVC Punch north rim of box
MW-7	2109368.19	6064025.54	39.94 40.54	Notch on north side of PVC Punch north rim of box
MW-8	2109321.68	6064000.46	39.38 39.72	Notch on north side of PVC Punch north rim of box

**TABLE OF ELEVATIONS & COORDINATES
ON MONITORING WELLS**
SOMA ENVIRONMENTAL
Oakland-E. 14 the St. "International Blvd"

WELL NO.	NORTHING	EASTING	ELEVATION	DESCRIPTION
MW-10	2109193.97	6063957.39	36.71 37.70	Notch on north side of PVC Punch north rim of box
MW-11	2109125.26	6064007.52	XXXX	NO ELEVATION , BOAT ON TOP
MW-12	2109121.85	6063865.00	36.84 36.87	Notch on north side of PVC

Bench mark: NGS Bench mark No.M 554. To reach the station from the intersection of Interstate Highway 880 and Hegenberger Rd in South Oakland go northeast on Hegenberger Rd for 0.5 MI to a side road right Baldwin St. Turn right and go south on Baldwin St for 0.35 MI to a T-intersection, 85th Ave. for 0.1 MI to a side road right, Railroad Ave. Turn right and go south on Railroad Ave. for 0.1 MI to the station on the left, east, side of the road in a large concrete headwall for a culvert.

Elevation = 14.20 NAVD88 Datum

Coordinate values are based on the California Coordinate System, Zone III NAD 83 Datum.

Harrington Surveys Inc.
Land Surveying & Mapping

2278 Larkey Lane, Walnut Creek, Ca. 94597 Phone (925)935-7228 Fax (925)935-5118
Cell (925)788-7359 E-Mail (ben5132@pacbell.net)

SOMA ENVIRONMENTAL ENGINEERING
2680 BISHOP DR. # 203
SAN RAMON, CA. 94583

MAY 20, 2005

ATTN: ELENA

3609 INTERNATIONAL BLVD.
OAKLAND CA.

SURVEY REPORT

CONTROLLING POINTS FROM SURVEY BY KIER & WRIGHT, DATED 08-27-02:

MW-5 NOTCH, CALIFORNIA COORDINATE SYSTEM, ZONE 3. NAD 83.
NORTH 2,109,410.84 - EAST 6,064,058.45, LAT. N37°46'17.42024"
W122°13'18.51054".
ELEVATION 41.06, NAVD 88,

MW-7 NOTCH, CALIFORNIA COORDINATE SYSTEM, ZONE 3,
NORTH 2,109,368.19 - EAST 6,064,025.54. LAT N37°46'30.32592",
W122°13'18.88771"
ELEVATION 39.94 NAVD 88,

INSTRUMENTATION:
TRIMBLE GPS, MODEL 5800 AND LEICA TCA 1800, 1" HORZ. & VERT.
OBSERVATION: EPOCH = 180.

FIELD SURVEY: APRIL 20, 2005.

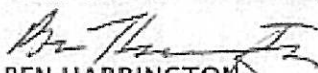
BEN HARRINGTON
PLS 5132



DATE: 8/17/05

Job No. 07-014

DATE OF SURVEY 3/8/07

INSTRUMENTS: Leica SR530 L530, Leica -

TCRA 1102 - Total Station,

Leica - NA 3003 - Level

TABLE OF ELEVATIONS & COORDINATES

3609 International Blvd., Oakland
SOMA ENVIRONMENTAL, PROJECT # 2331

WELL ID #	NORTHING (FT.) / LATITUDE (D.M.S.)	EASTING (FT.) / LONGITUDE (D.M.S.)	ELEVATION (FT.)	DESCRIPTION
EX-1	2109341.80	6064034.13	40.51	Casing
			40.93	Vault
EX-1 DECIMAL DEGREES	37.7752931	-122.2218880		

LOCAL CONTROL

MW-7	2109368.62	6064025.48	39.94	Casing
	37.7753663	-122.2219197	40.54	Vault
MW-8	2109321.68	6064000.47	39.38	Casing
	37.7752361	-122.2220033	39.72	Vault

NOTE

THE VALUES FOR EX-1 ARE DERIVED FROM LOCAL CONTROL BASED UPON CONTROL VALUES
USED FROM THE PREVIOUS SITE SURVEY AS PROVIDED BY KIER AND WRIGHT DATED 08-27-2002

BENCH MARK: NGS Bench mark No.M 554

TO REACH THE STATION FROM THE INTERSECTION OF INTERSTATE HIGHWAY 880 AND HEGENBERGER RD IN SOUTH OAKLAND
GO NORTHEAST ON HEGENBERGER ROAD FOR 0.5MI TO A SITE ROAD RIGHT BALDWIN ST. TURN RIGHT AND GO SOUTH ON BALDWIN ST.
FOR 0.35MI TO A T-INTERSECTION, 85TH AVE. FOR 0.1MI TO A SIDE ROAD RIGHT, RAILROAD AVE. TURN RIGHT AND GO
SOUTH ON RAILROAD AVE. FOR 0.1MI TO THE STATION ON THE LEFT, EAST, SIDE OF THE ROAD IN A LARGE CONCRETE HEADWALL FOR A
CULVERT.

Coordinate values are based on the California Coordinate System, Zone III NAD 83 Datum.

Elevation =14.20 FEET NAVD88 Datum



Joseph M. Brajkovich

PLS Surveys, Inc.
2220 Livingston Street, Suite 202
Oakland, CA 94606
510.261.0900

PRINTED: 3/19/2007
9:24 AM



ENVIRONMENTAL ENGINEERING, INC

Well No.: MW-1
 Casing Diameter: 2 inch
 Depth of Well: 30.00 ft
 Top of Casing Elevation: 40.11 ft
 Depth to Groundwater: 12.05 ft
 Groundwater Elevation: 28.06 ft
 Water Column Height: 17.95 ft
 Purged Volume: 10 gallons

Project No.: 2331
 Address: Tony's Express Auto Service
 3609 International Blvd
 Oakland, CA
 Date: June 8, 2009
 Sampler: Lizzie Hightower

Purging Method: Bailer Pump
 Sampling Method: Bailer Pump

Color: No Yes Describe Cloudy
 Sheen: No Yes Describe _____
 Odor: No Yes Describe Slight Petro Odor

Field Measurements:

Time	Volume (gallons)	D.O. mg/L	pH	Temp °C	E.C. (µS/cm)	Turb. NTU	ORP
13:38	Started purging well						
13:39	2	1.70	7.48	19.53	675	169	-138.8
13:40	4	1.09	7.50	19.57	666	281	-155.3
13:41	6	0.71	7.56	19.91	663	448	-162.7
13:42	8	0.66	7.53	19.96	662	162	-162.5
13:43	10	0.66	7.52	19.97	663	94.3	-162.5
13:48	Sampled						

Notes:

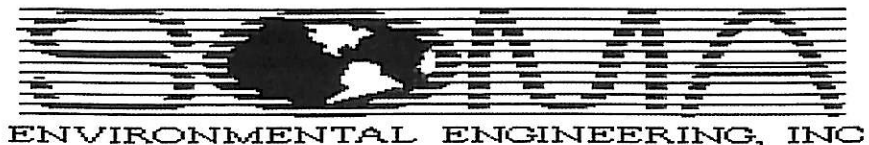

Well No.: MW-2 Project No.: 2331
 Casing Diameter: 4 inch Address: Tony's Express Auto Service
 Depth of Well: 31.00 ft 3609 International Blvd
 Top of Casing Elevation: 40.71 ft Oakland, CA
 Depth to Groundwater: 11.70 ft Date: June 8, 2009
 Groundwater Elevation: 29.01 ft Sampler: Lizzie Hightower
 Water Column Height: 19.30 ft
 Purged Volume: — gallons

Not purged

Purging Method: Bailer Pump
 Sampling Method: Bailer Pump Not sampled
 Color: No Yes Describe Unknown
 Sheen: No Yes Describe Unknown
 Odor: No Yes Describe Unknown

Field Measurements:

Time	Volume (gallons)	D.O. mg/L	pH	Temp °C	E.C. (µS/cm)	Turb. NTU	ORP

Notes: Quarterly sampling of the well discontinued starting 4th Qrtr. 2008, per ACHCS directive dated August 26, 2008



ENVIRONMENTAL ENGINEERING, INC

Well No.: MW-3
 Casing Diameter: 4 inch
 Depth of Well: 31.50 ft
 Top of Casing Elevation: 40.91 ft
 Depth to Groundwater: 12.44 ft
 Groundwater Elevation: 28.47 ft
 Water Column Height: 19.06 ft
 Purged Volume: 24 gallons

Project No.: 2331
 Address: Tony's Express Auto Service
 3609 International Blvd
 Oakland, CA
 Date: June 8, 2009
 Sampler: Lizzie Hightower

Purging Method: Bailer Pump

Sampling Method: Bailer Pump

Color: No Yes Describe _____

Sheen: No Yes Describe _____

Odor: No Yes Describe Very slight Petro

Field Measurements:

Time	Volume (gallons)	D.O. mg/L	pH	Temp °C	E.C. (µS/cm)	Turb. NTU	ORP
14:06	Started purging well						
14:07	2	6.11	7.44	19.74	656	15.3	-117.8
14:10	8	3.50	7.25	19.76	654	11.2	-143.2
14:13	14	2.60	7.43	19.78	656	8.97	-181.5
14:16	20	2.11	7.49	19.79	657	8.12	-194.5
14:18	24	1.75	7.50	19.80	657	8.27	-202.4
14:23	Sampled						

Notes:



ENVIRONMENTAL ENGINEERING, INC

Well No.: MW-4R
 Casing Diameter: 2 inch
 Depth of Well: 26.00 ft
 Top of Casing Elevation: 40.34 ft
 Depth to Groundwater: 12.22 ft
 Groundwater Elevation: 28.12 ft
 Water Column Height: 13.78 ft
 Purged Volume: — gallons
Not purged

Project No.: 2331
 Address: Tony's Express Auto Service
 3609 International Blvd
 Oakland, CA
 Date: June 8, 2009
 Sampler: Lizzie Hightower

Purging Method: Bailer Pump
 Sampling Method: Bailer Pump Not sampled

Color: No Yes Describe Unknown
 Sheen: No Yes Describe Unknown
 Odor: No Yes Describe Unknown

Field Measurements:

Time	Volume (gallons)	D.O. mg/L	pH	Temp °C	E.C. (µS/cm)	Turb. NTU	ORP

Notes: Quarterly sampling of this well discontinued starting 4th Qrtr. 2008, per ACTCS directive dated 8/26/08.



ENVIRONMENTAL ENGINEERING, INC

Well No.: MW-5 Project No.: 2331
 Casing Diameter: 2 inch Address: Tony's Express Auto Service
 Depth of Well: 26.20 ft 3609 International Blvd
 Top of Casing Elevation: 41.16 ft Oakland, CA
 Depth to Groundwater: 11.92 ft Date: June 8, 2009
 Groundwater Elevation: 29.24 ft Sampler: Lizzie Hightower
 Water Column Height: 14.28 ft
 Purged Volume: — gallons
Not purged

Purging Method: Bailer Pump
 Sampling Method: Bailer Pump *Not Sampled*
 Color: No Yes Describe Unknown
 Sheen: No Yes Describe Unknown
 Odor: No Yes Describe Unknown

Field Measurements:

Time	Volume (gallons)	D.O. mg/L	pH	Temp °C	E.C. (µS/cm)	Turb. NTU	ORP

Notes: Quarterly sampling of this well discontinued starting 4th Qtr. 2008, per ACHCS directive dated 8/26/08.



ENVIRONMENTAL ENGINEERING, INC

Well No.: MW-6
 Casing Diameter: 2 inch
 Depth of Well: 25.00 ft
 Top of Casing Elevation: 40.92 ft
 Depth to Groundwater: 12.48 ft
 Groundwater Elevation: 28.44 ft
 Water Column Height: 12.52 ft
 Purged Volume: 6 gallons

Project No.: 2331
 Address: Tony's Express Auto Service
 3609 International Blvd
 Oakland, CA
 Date: June 8, 2009
 Sampler: Lizzie Hightower

Purging Method: Bailer Pump

Sampling Method: Bailer Pump

Color: No Yes Describe Cloudy
 Sheen: No Yes Describe Rainbow Sheen
 Odor: No Yes Describe Petro odor

Field Measurements:

Time	Volume (gallons)	D.O. (mg/L)	pH	Temp (°C)	E.C. (µS/cm)	Turb. (NTU)	ORP
15:18	Started purging well						
15:19	2	2.61	7.58	18.91	803	49.0	-161.9
15:20	4	1.42	7.61	19.01	760	100	-173.0
15:21	6	1.12	7.60	19.07	744	67.2	-174.5
15:26	sampled						

Notes:



ENVIRONMENTAL ENGINEERING, INC

Well No.: MW-8
 Casing Diameter: 2 inch
 Depth of Well: 26.50 ft
 Top of Casing Elevation: 39.38 ft
 Depth to Groundwater: 11.38 ft
 Groundwater Elevation: 28.00 ft
 Water Column Height: 15.12 ft
 Purged Volume: 8 gallons

Project No.: 2331
 Address: Tony's Express Auto Service
 3609 International Blvd
 Oakland, CA
 Date: June 8, 2009
 Sampler: Lizzie Hightower

Purging Method: Bailer Pump
 Sampling Method: Bailer Pump

Color: No Yes Describe Very Slightly Cloudy
 Sheen: No Yes Describe Rainbow Sheen
 Odor: No Yes Describe Very Slight Petro Odor

Field Measurements:

Time	Volume (gallons)	D.O. mg/L	pH	Temp °C	E.C. (µS/cm)	Turb. NTU	ORP
13:11	started purging well						
13:12	2	2.55	7.59	18.98	673	83.1	-144.8
13:13	4	1.36	7.62	18.96	720	69.6	-162.9
13:14	6	0.91	7.64	18.99	725	110	-177.5
13:15	8	0.70	7.65	19.04	722	96.0	-181.1
13:20	sampled						

Notes:



Well No.: MW-10
 Casing Diameter: 2 inch
 Depth of Well: 23.40 ft
 Top of Casing Elevation: 36.71 ft
 Depth to Groundwater: 10.14 ft
 Groundwater Elevation: 26.57 ft
 Water Column Height: 13.26 ft
 Purged Volume: 6 gallons

Project No.: 2331
 Address: Tony's Express Auto Service
 3609 International Blvd
 Oakland, CA
 Date: June 8, 2009
 Sampler: Lizzie Hightower

Purging Method: Bailer

Pump

Sampling Method: Bailer

Pump

Color: No

Yes Describe _____

Sheen: No

Yes Describe _____

Odor: No

Yes Describe _____

Field Measurements:

Time	Volume (gallons)	D.O. (mg/L)	pH	Temp (°C)	E.C. (µS/cm)	Turb. (NTU)	ORP
12:44	Started purging well						
12:45	2	1.89	6.79	18.09	772	8.39	-94.5
12:46	4	1.45	7.22	18.03	771	5.77	-120.2
12:47	6	1.09	7.24	18.04	769	4.49	-136.4
12:52	Sampled						

Notes:



ENVIRONMENTAL ENGINEERING, INC

Well No.: MW-11 Project No.: 2331
 Casing Diameter: — inch Address: Tony's Express Auto Service
 Depth of Well: — ft 3609 International Blvd
 Top of Casing Elevation: — ft Oakland, CA
 Depth to Groundwater: — ft Date: June 8, 2009
 Groundwater Elevation: — ft Sampler: Lizzie Hightower
 Water Column Height: — ft
 Purged Volume: — gallons
not purged

Purging Method: Bailer Pump
 Sampling Method: Bailer Pump *Not sampled*

Color: No Yes Describe Unknown
 Sheen: No Yes Describe Unknown
 Odor: No Yes Describe Unknown

Field Measurements:

Time	Volume (gallons)	D.O. (mg/L)	pH	Temp (°C)	E.C. (µS/cm)	Turb. (NTU)	ORP

Notes: Gate w/ access to the well is locked. Unable to get to the well. No field measurements or samples taken.



ENVIRONMENTAL ENGINEERING, INC

Well No.: MW-12
 Casing Diameter: 4 inch
 Depth of Well: 30.00 ft
 Top of Casing Elevation: 36.84 ft
 Depth to Groundwater: 10.83 ft
 Groundwater Elevation: 26.01 ft
 Water Column Height: 19.17 ft
 Purged Volume: — gallons

Project No.: 2331
 Address: Tony's Express Auto Service
 3609 International Blvd
 Oakland, CA
 Date: June 8, 2009
 Sampler: Lizzie Hightower

Not purged

Purging Method: Bailer Pump

Sampling Method: Bailer Pump Not sampled

Color: No Yes Describe Unknown

Sheen: No Yes Describe Unknown

Odor: No Yes Describe Unknown

Field Measurements:

Time	Volume (gallons)	D.O. mg/L	pH	Temp °C	E.C. (µS/cm)	Turb. NTU	ORP

Notes: Quarterly sampling of this well discontinued starting 4th Qrtr. 2008, per ACHCS directive dated 8/26/08



ENVIRONMENTAL ENGINEERING, INC

Well No.: *French Drain Riser* F.D. Center Project No.: 2331
 Casing Diameter: 4 inch Address: Tony's Express Auto Service
 Depth of Well: NM ft 3609 International Blvd
 Top of Casing Elevation: 39.35 ft Oakland, CA
 Depth to Groundwater: 15.89 ft Date: June 8 2009
 Groundwater Elevation: 23.46 ft Sampler: Lizzie Hightower
 Water Column Height: NC ft
 Purged Volume: - gallons
Not purged

Purging Method: Bailer Pump
 Sampling Method: Bailer Pump *Not sampled*
 Color: No Yes Describe Unknown
 Sheen: No Yes Describe Unknown
 Odor: No Yes Describe Unknown

Field Measurements:

Time	Volume (gallons)	D.O. (mg/L)	pH	Temp (°C)	E.C. (µS/cm)	Turb. NTU	ORP

Notes: *French drain riser is part of remedial system. Only depth to groundwater measurement taken.*



ENVIRONMENTAL ENGINEERING, INC

Well No.: French Drain Riser F.D. East
 Casing Diameter: 4 inch
 Depth of Well: NM ft
 Top of Casing Elevation: 40.06 ft
 Depth to Groundwater: 12.51 ft
 Groundwater Elevation: 27.55 ft
 Water Column Height: NC ft
 Purged Volume: — gallons

Project No.: 2331
 Address: Tony's Express Auto Service
 3609 International Blvd
 Oakland, CA
 Date: June 8, 2009
 Sampler: Lizzie Hightower

Not purged

Purging Method: Bailer Pump

Sampling Method: Bailer Pump *Not sampled*

Color: No Yes Describe Unknown

Sheen: No Yes Describe Unknown

Odor: No Yes Describe Unknown

Field Measurements:

Time	Volume (gallons)	D.O. mg/L	pH	Temp °C	E.C. (µS/cm)	Turb. NTU	ORP

Notes: French drain riser is part of the FD remedial system; however, no active pump is in the riser. Only groundwater measurement taken.



ENVIRONMENTAL ENGINEERING, INC

Well No.: French Drain Riser F.D. West
 Casing Diameter: 4 inch
 Depth of Well: NM ft
 Top of Casing Elevation: 39.16 ft
 Depth to Groundwater: 11.87 ft
 Groundwater Elevation: 27.29 ft
 Water Column Height: NC ft
 Purged Volume: - gallons
Not purged

Project No.: 2331
 Address: Tony's Express Auto Service
 3609 International Blvd
 Oakland, CA
 Date: June 8, 2009
 Sampler: Lizzie Hightower

Purging Method: Bailer Pump
 Sampling Method: Bailer Pump Not sampled
 Color: No Yes Describe Unknown
 Sheen: No Yes Describe Unknown
 Odor: No Yes Describe Unknown

Field Measurements:

Time	Volume (gallons)	D.O. (mg/L)	pH	Temp (°C)	E.C. (µS/cm)	Turb. NTU	ORP

Notes: FD west riser is part of the remedial system. Only depth to groundwater measurement taken.

Appendix C

Chain of Custody Form and Laboratory Report

Second Quarter 2009: Groundwater Monitoring and Remediation System Report
With Evaluation of Effectiveness of Monthly MPE



Curtis & Tompkins, Ltd., Analytical Laboratories, Since 1878

2323 Fifth Street, Berkeley, CA 94710, Phone (510) 486-0900

Laboratory Job Number 212740
ANALYTICAL REPORT

SOMA Environmental Engineering Inc.
6620 Owens Dr.
Pleasanton, CA 94588

Project : 2331
Location : 3609 Int'l Blvd., Oakland
Level : II

Table with 2 columns: Sample ID, Lab ID. Rows include MW-1 through MW-10 with corresponding Lab IDs.

This data package has been reviewed for technical correctness and completeness. Release of this data has been authorized by the Laboratory Manager or the Manager's designee, as verified by the following signatures. The results contained in this report meet all requirements of NELAC and pertain only to those samples which were submitted for analysis. This report may be reproduced only in its entirety.

Signature: [Handwritten Signature]
Project Manager

Date: 06/16/2009

Signature: [Handwritten Signature]
Senior Program Manager

Date: 06/17/2009

CASE NARRATIVE

Laboratory number: 212740
Client: SOMA Environmental Engineering Inc.
Project: 2331
Location: 3609 Int'l Blvd., Oakland
Request Date: 06/09/09
Samples Received: 06/09/09

This data package contains sample and QC results for five water samples, requested for the above referenced project on 06/09/09. The samples were received cold and intact.

Volatile Organics by GC/MS (EPA 8260B):
No analytical problems were encountered.

CHAIN OF CUSTODY

Curtis & Tompkins, Ltd.
 Analytical Laboratory Since 1878
 2323 Fifth Street
 Berkeley, CA 94710
 (510)486-0900 Phone
 (510)486-0532 Fax

C&T LOGIN # 212740

Analysis

Project No: 2331
Project Name: 3609 International Blvd. Oakland CA
Turnaround Time: Standard

Sampler: Lizzie Hightower
Report To: Joyce Bobek
Company : SOMA Environmental
Telephone: 925-734-6400
Fax: 925-734-6401

TPHg, BTEX, MtBE 8260B																			

Lab No.	Sample ID.	Sampling Date	Time	Matrix			# of Containers	Preservative											
				Soil	Water	Waste		HCL	H2SO4	HNO3	ICE								
1	MW-1	6/8/09	13:48	*			3 VOAs	*			*								
2	MW-3		14:23	*			3 VOAs	*			*								
3	MW-6		15:26	*			3 VOAs	*			*								
4	MW-8		13:20	*			3 VOAs	*			*								
5	MW-10		12:52	*			3 VOAs	*			*								

Notes: EDF OUTPUT REQUIRED

 rec'd intact + cold Ag

RELINQUISHED BY: E. Hightower 6/8/09 10:00 DATE/TIME	RECEIVED BY: [Signature] 6/8/9 1000 DATE/TIME
DATE/TIME	DATE/TIME
DATE/TIME	DATE/TIME

COOLER RECEIPT CHECKLIST

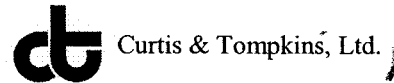

Login # 212740 Date Received 6-9-9 Number of coolers 1
Client SOMA Project 2331 PROJECT

Date Opened 6-9-9 By (print) S. EVANS (sign) [Signature]
Date Logged in By (print) (sign)

1. Did cooler come with a shipping slip (airbill, etc) YES NO
Shipping info

2A. Were custody seals present? ... YES (circle) on cooler on samples NO
How many Name Date

2B. Were custody seals intact upon arrival? YES NO N/A

3. Were custody papers dry and intact when received? YES NO

4. Were custody papers filled out properly (ink, signed, etc)? YES NO

5. Is the project identifiable from custody papers? (If so fill out top of form) YES NO

6. Indicate the packing in cooler: (if other, describe)

- Bubble Wrap, Foam blocks, Bags, None, Cloth material, Cardboard, Styrofoam, Paper towels

7. Temperature documentation:

Type of ice used: Wet Blue/Gel None Temp(C)

Samples Received on ice & cold without a temperature blank

Samples received on ice directly from the field. Cooling process had begun

8. Were Method 5035 sampling containers present? YES NO
If YES, what time were they transferred to freezer?

9. Did all bottles arrive unbroken/unopened? YES NO

10. Are samples in the appropriate containers for indicated tests? YES NO

11. Are sample labels present, in good condition and complete? YES NO

12. Do the sample labels agree with custody papers? YES NO

13. Was sufficient amount of sample sent for tests requested? YES NO

14. Are the samples appropriately preserved? YES NO N/A

15. Are bubbles > 6mm absent in VOA samples? YES NO N/A

16. Was the client contacted concerning this sample delivery? YES NO

If YES, Who was called? By Date:

COMMENTS

Blank lines for handwritten comments.

Gasoline by GC/MS			
Lab #:	212740	Location:	3609 Int'l Blvd., Oakland
Client:	SOMA Environmental Engineering Inc.	Prep:	EPA 5030B
Project#:	2331	Analysis:	EPA 8260B
Matrix:	Water	Sampled:	06/08/09
Units:	ug/L	Received:	06/09/09

Field ID:	MW-1	Diln Fac:	3.333
Type:	SAMPLE	Batch#:	151990
Lab ID:	212740-001	Analyzed:	06/15/09

Analyte	Result	RL
Gasoline C7-C12	4,900 Y	170
MTBE	2.2	1.7
Benzene	8.7	1.7
Toluene	12	1.7
Ethylbenzene	110	1.7
m,p-Xylenes	370	1.7
o-Xylene	91	1.7

Surrogate	%REC	Limits
Dibromofluoromethane	98	80-122
1,2-Dichloroethane-d4	91	77-137
Toluene-d8	99	80-120
Bromofluorobenzene	110	80-125

Field ID:	MW-3	Diln Fac:	3.333
Type:	SAMPLE	Batch#:	151990
Lab ID:	212740-002	Analyzed:	06/15/09

Analyte	Result	RL
Gasoline C7-C12	4,500 Y	170
MTBE	2.8	1.7
Benzene	86	1.7
Toluene	22	1.7
Ethylbenzene	99	1.7
m,p-Xylenes	290	1.7
o-Xylene	90	1.7

Surrogate	%REC	Limits
Dibromofluoromethane	97	80-122
1,2-Dichloroethane-d4	88	77-137
Toluene-d8	99	80-120
Bromofluorobenzene	110	80-125

Y= Sample exhibits chromatographic pattern which does not resemble standard
 ND= Not Detected
 RL= Reporting Limit

Gasoline by GC/MS			
Lab #:	212740	Location:	3609 Int'l Blvd., Oakland
Client:	SOMA Environmental Engineering Inc.	Prep:	EPA 5030B
Project#:	2331	Analysis:	EPA 8260B
Matrix:	Water	Sampled:	06/08/09
Units:	ug/L	Received:	06/09/09

Field ID: MW-6 Diln Fac: 12.50
 Type: SAMPLE Batch#: 151938
 Lab ID: 212740-003 Analyzed: 06/12/09

Analyte	Result	RL
Gasoline C7-C12	19,000 Y	630
MTBE	ND	6.3
Benzene	450	6.3
Toluene	240	6.3
Ethylbenzene	970	6.3
m,p-Xylenes	1,500	6.3
o-Xylene	460	6.3

Surrogate	%REC	Limits
Dibromofluoromethane	97	80-122
1,2-Dichloroethane-d4	85	77-137
Toluene-d8	100	80-120
Bromofluorobenzene	111	80-125

Field ID: MW-8 Diln Fac: 6.250
 Type: SAMPLE Batch#: 151990
 Lab ID: 212740-004 Analyzed: 06/15/09

Analyte	Result	RL
Gasoline C7-C12	6,700 Y	310
MTBE	3.9	3.1
Benzene	81	3.1
Toluene	22	3.1
Ethylbenzene	420	3.1
m,p-Xylenes	270	3.1
o-Xylene	13	3.1

Surrogate	%REC	Limits
Dibromofluoromethane	97	80-122
1,2-Dichloroethane-d4	88	77-137
Toluene-d8	99	80-120
Bromofluorobenzene	111	80-125

Y= Sample exhibits chromatographic pattern which does not resemble standard
 ND= Not Detected
 RL= Reporting Limit

Gasoline by GC/MS			
Lab #:	212740	Location:	3609 Int'l Blvd., Oakland
Client:	SOMA Environmental Engineering Inc.	Prep:	EPA 5030B
Project#:	2331	Analysis:	EPA 8260B
Matrix:	Water	Sampled:	06/08/09
Units:	ug/L	Received:	06/09/09

Field ID: MW-10 Diln Fac: 2.500
 Type: SAMPLE Batch#: 151938
 Lab ID: 212740-005 Analyzed: 06/12/09

Analyte	Result	RL
Gasoline C7-C12	2,600 Y	130
MTBE	26	1.3
Benzene	170	1.3
Toluene	4.9	1.3
Ethylbenzene	140	1.3
m,p-Xylenes	8.2	1.3
o-Xylene	ND	1.3

Surrogate	%REC	Limits
Dibromofluoromethane	97	80-122
1,2-Dichloroethane-d4	82	77-137
Toluene-d8	100	80-120
Bromofluorobenzene	107	80-125

Type: BLANK Batch#: 151938
 Lab ID: QC499781 Analyzed: 06/12/09
 Diln Fac: 1.000

Analyte	Result	RL
Gasoline C7-C12	ND	50
MTBE	ND	0.50
Benzene	ND	0.50
Toluene	ND	0.50
Ethylbenzene	ND	0.50
m,p-Xylenes	ND	0.50
o-Xylene	ND	0.50

Surrogate	%REC	Limits
Dibromofluoromethane	99	80-122
1,2-Dichloroethane-d4	93	77-137
Toluene-d8	99	80-120
Bromofluorobenzene	106	80-125

Y= Sample exhibits chromatographic pattern which does not resemble standard
 ND= Not Detected
 RL= Reporting Limit

Gasoline by GC/MS			
Lab #:	212740	Location:	3609 Int'l Blvd., Oakland
Client:	SOMA Environmental Engineering Inc.	Prep:	EPA 5030B
Project#:	2331	Analysis:	EPA 8260B
Matrix:	Water	Sampled:	06/08/09
Units:	ug/L	Received:	06/09/09

Type:	BLANK	Batch#:	151990
Lab ID:	QC499996	Analyzed:	06/15/09
Diln Fac:	1.000		

Analyte	Result	RL
Gasoline C7-C12	ND	50
MTBE	ND	0.50
Benzene	ND	0.50
Toluene	ND	0.50
Ethylbenzene	ND	0.50
m,p-Xylenes	ND	0.50
o-Xylene	ND	0.50

Surrogate	%REC	Limits
Dibromofluoromethane	97	80-122
1,2-Dichloroethane-d4	90	77-137
Toluene-d8	99	80-120
Bromofluorobenzene	109	80-125

Y= Sample exhibits chromatographic pattern which does not resemble standard
 ND= Not Detected
 RL= Reporting Limit

Batch QC Report

Gasoline by GC/MS			
Lab #:	212740	Location:	3609 Int'l Blvd., Oakland
Client:	SOMA Environmental Engineering Inc.	Prep:	EPA 5030B
Project#:	2331	Analysis:	EPA 8260B
Matrix:	Water	Batch#:	151938
Units:	ug/L	Analyzed:	06/12/09
Diln Fac:	1.000		

Type: BS Lab ID: QC499782

Analyte	Spiked	Result	%REC	Limits
MTBE	25.00	24.84	99	73-122
Benzene	25.00	26.03	104	80-120
Toluene	25.00	25.20	101	80-120
Ethylbenzene	25.00	26.63	107	80-121
m,p-Xylenes	50.00	53.31	107	80-122
o-Xylene	25.00	26.41	106	80-120

Surrogate	%REC	Limits
Dibromofluoromethane	104	80-122
1,2-Dichloroethane-d4	93	77-137
Toluene-d8	99	80-120
Bromofluorobenzene	110	80-125

Type: BSD Lab ID: QC499783

Analyte	Spiked	Result	%REC	Limits	RPD	Lim
MTBE	25.00	24.77	99	73-122	0	20
Benzene	25.00	26.83	107	80-120	3	20
Toluene	25.00	25.13	101	80-120	0	20
Ethylbenzene	25.00	27.07	108	80-121	2	20
m,p-Xylenes	50.00	53.64	107	80-122	1	20
o-Xylene	25.00	26.93	108	80-120	2	20

Surrogate	%REC	Limits
Dibromofluoromethane	102	80-122
1,2-Dichloroethane-d4	93	77-137
Toluene-d8	99	80-120
Bromofluorobenzene	111	80-125

RPD= Relative Percent Difference

Batch QC Report

Gasoline by GC/MS			
Lab #:	212740	Location:	3609 Int'l Blvd., Oakland
Client:	SOMA Environmental Engineering Inc.	Prep:	EPA 5030B
Project#:	2331	Analysis:	EPA 8260B
Matrix:	Water	Batch#:	151938
Units:	ug/L	Analyzed:	06/12/09
Diln Fac:	1.000		

Type: BS Lab ID: QC499784

Analyte	Spiked	Result	%REC	Limits
Gasoline C7-C12	950.0	987.1	104	80-120

Surrogate	%REC	Limits
Dibromofluoromethane	101	80-122
1,2-Dichloroethane-d4	94	77-137
Toluene-d8	100	80-120
Bromofluorobenzene	109	80-125

Type: BSD Lab ID: QC499785

Analyte	Spiked	Result	%REC	Limits	RPD	Lim
Gasoline C7-C12	950.0	995.8	105	80-120	1	20

Surrogate	%REC	Limits
Dibromofluoromethane	99	80-122
1,2-Dichloroethane-d4	92	77-137
Toluene-d8	101	80-120
Bromofluorobenzene	107	80-125

RPD= Relative Percent Difference

Batch QC Report

Gasoline by GC/MS			
Lab #:	212740	Location:	3609 Int'l Blvd., Oakland
Client:	SOMA Environmental Engineering Inc.	Prep:	EPA 5030B
Project#:	2331	Analysis:	EPA 8260B
Matrix:	Water	Batch#:	151990
Units:	ug/L	Analyzed:	06/15/09
Diln Fac:	1.000		

Type: BS Lab ID: QC499999

Analyte	Spiked	Result	%REC	Limits
Gasoline C7-C12	750.0	823.9	110	80-120

Surrogate	%REC	Limits
Dibromofluoromethane	97	80-122
1,2-Dichloroethane-d4	88	77-137
Toluene-d8	101	80-120
Bromofluorobenzene	107	80-125

Type: BSD Lab ID: QC500000

Analyte	Spiked	Result	%REC	Limits	RPD	Lim
Gasoline C7-C12	750.0	841.1	112	80-120	2	20

Surrogate	%REC	Limits
Dibromofluoromethane	96	80-122
1,2-Dichloroethane-d4	88	77-137
Toluene-d8	99	80-120
Bromofluorobenzene	107	80-125

RPD= Relative Percent Difference

Date : 15-JUN-2009 21:23

Client ID: DYNA P&T

Sample Info: S,212740-001

Instrument: MSV0A08.i

Operator: voc

Column diameter: 2.00

Column phase:

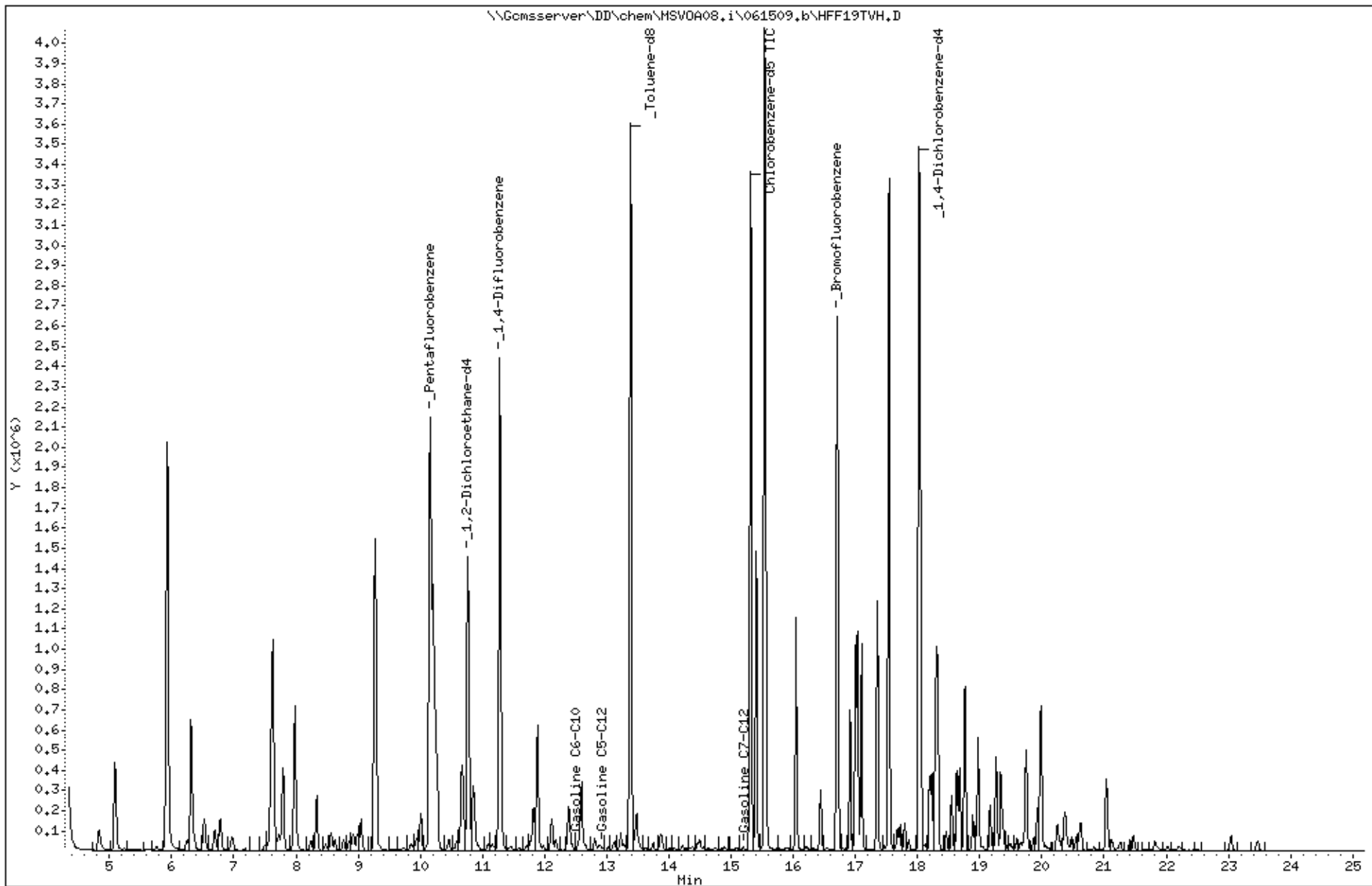

Date : 15-JUN-2009 21:59

Client ID: DYNA P&T

Sample Info: S,212740-002

Instrument: MSV0A08.i

Operator: voc

Column diameter: 2.00

Column phase:

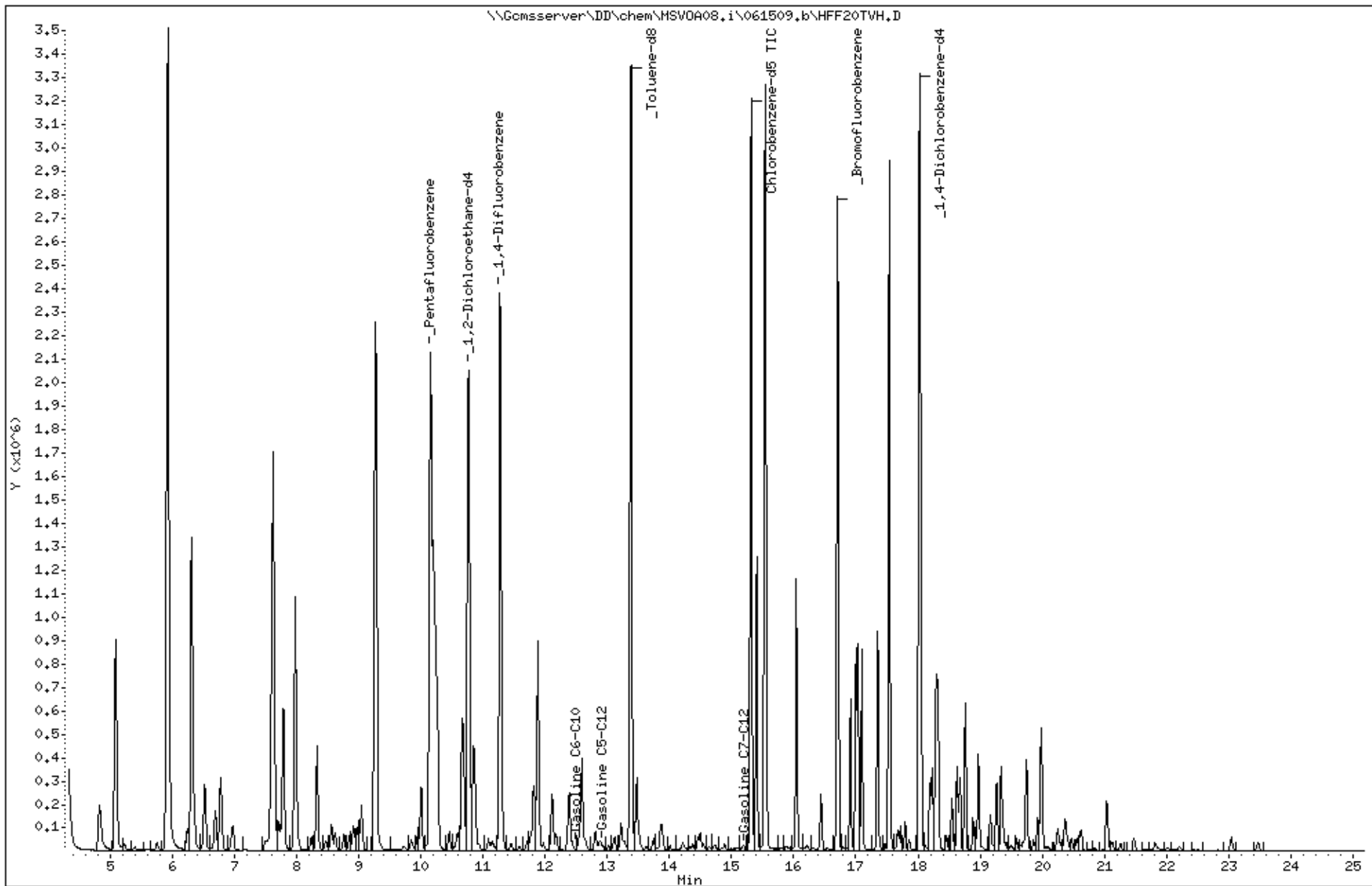

Date : 12-JUN-2009 22:32

Client ID: DYNA P&T

Sample Info: S,212740-003

Instrument: MSV0A08.i

Operator: voc

Column diameter: 2.00

Column phase:

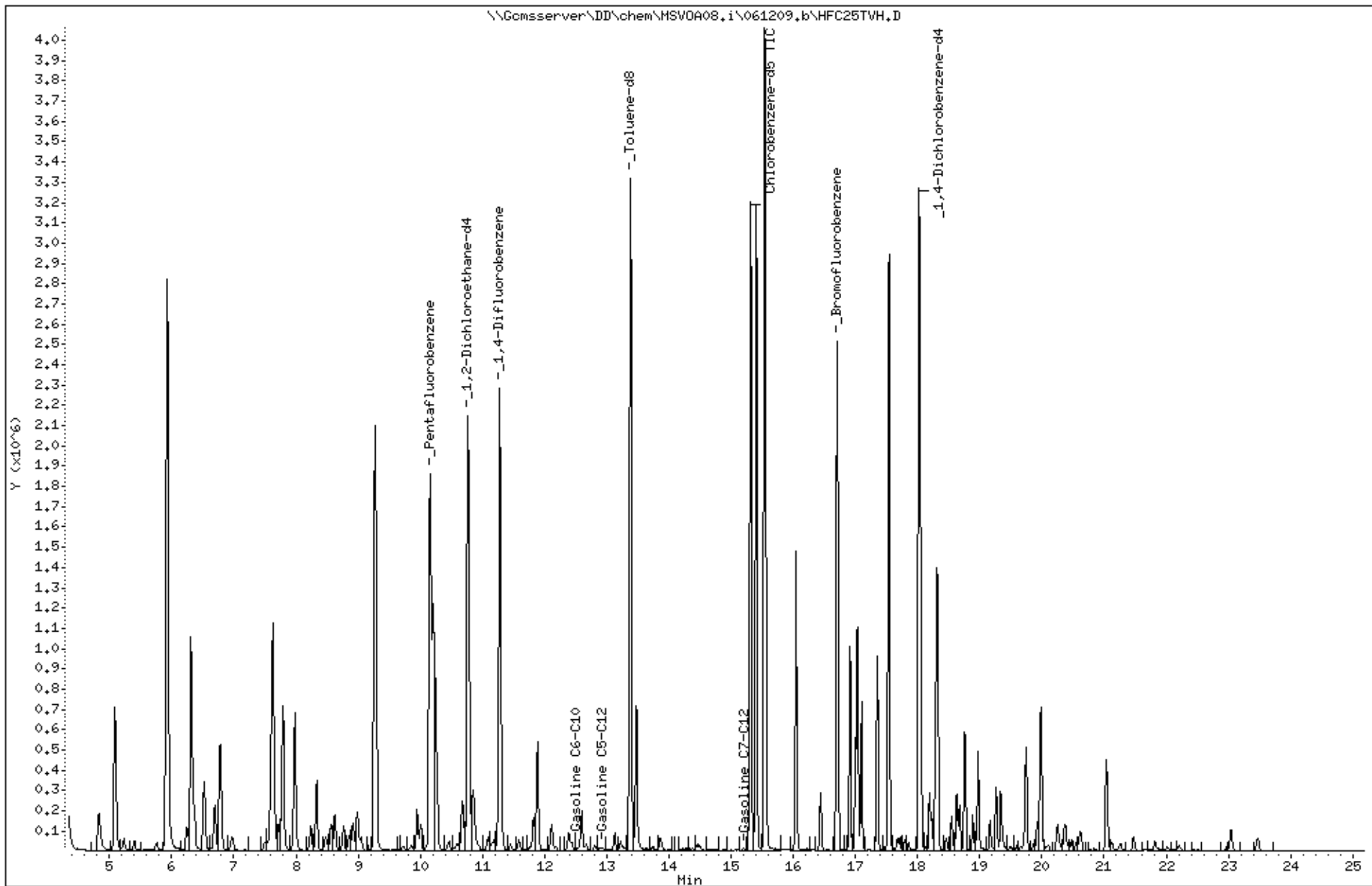

Date : 15-JUN-2009 23:11

Client ID: DYNA P&T

Sample Info: S,212740-004

Instrument: MSV0A08.i

Operator: voc

Column diameter: 2.00

Column phase:

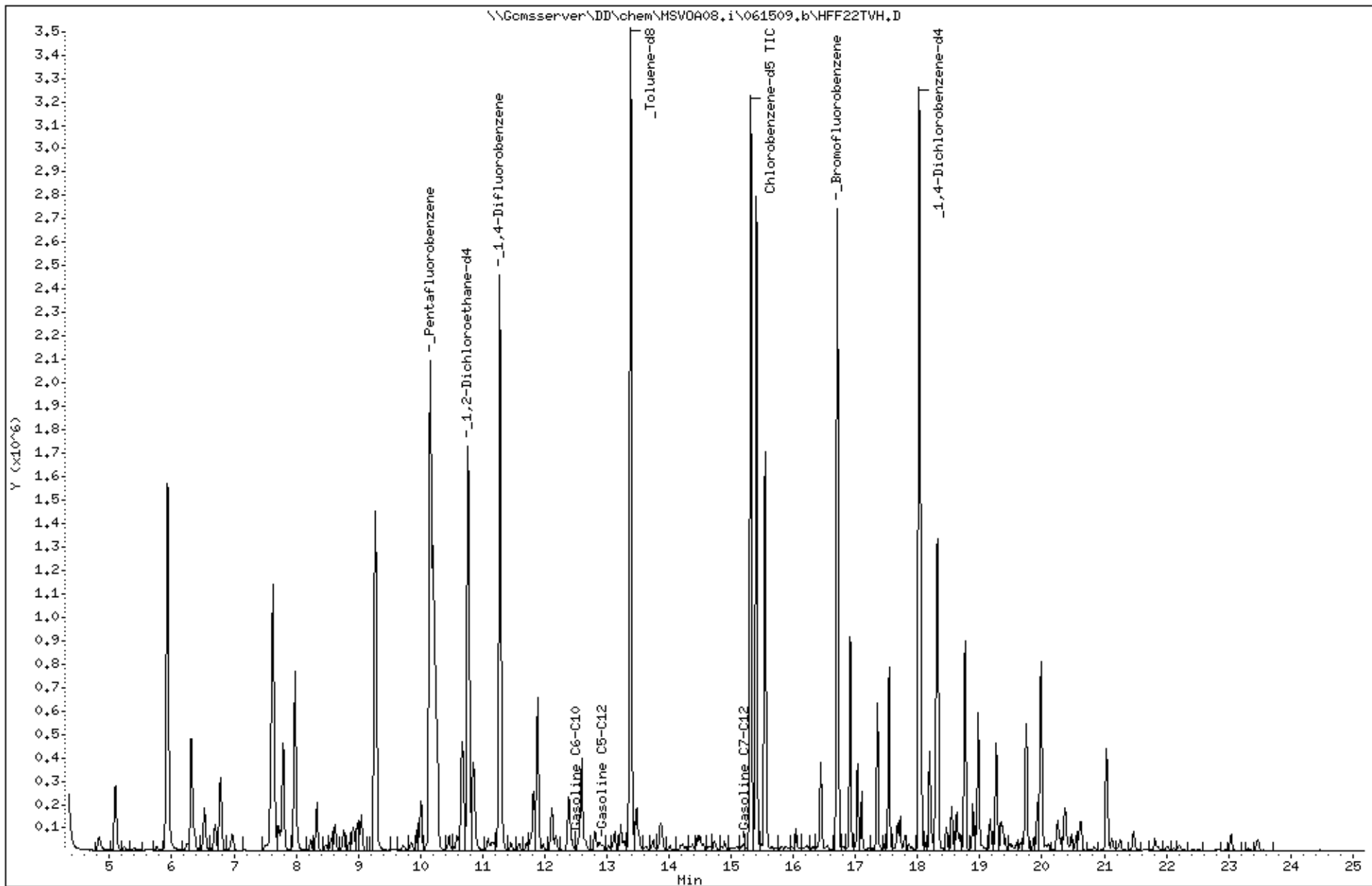

Date : 12-JUN-2009 19:30

Client ID: DYNA P&T

Sample Info: S,212740-005

Instrument: MSV0A08.i

Operator: voc

Column diameter: 2.00

Column phase:

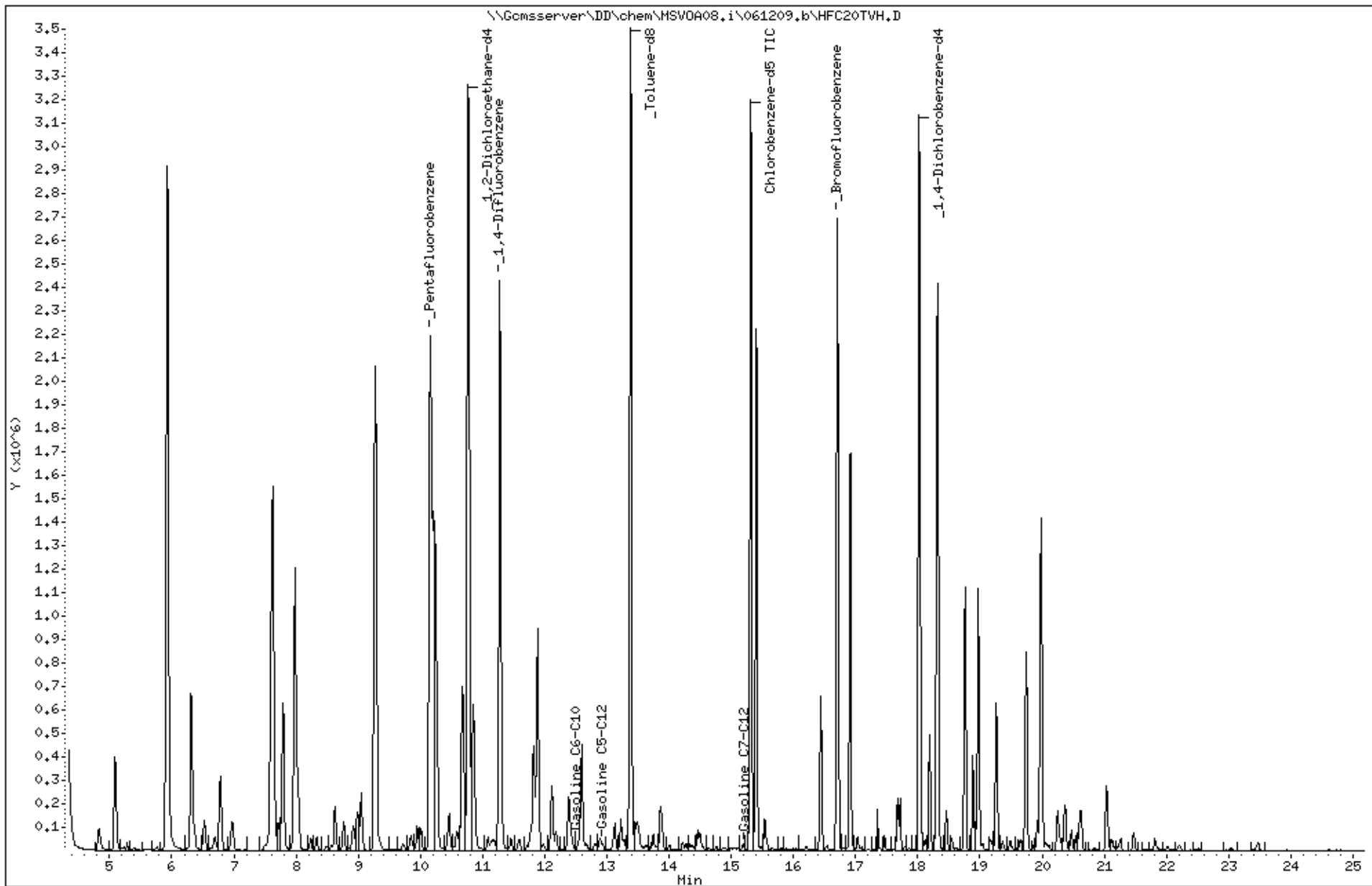

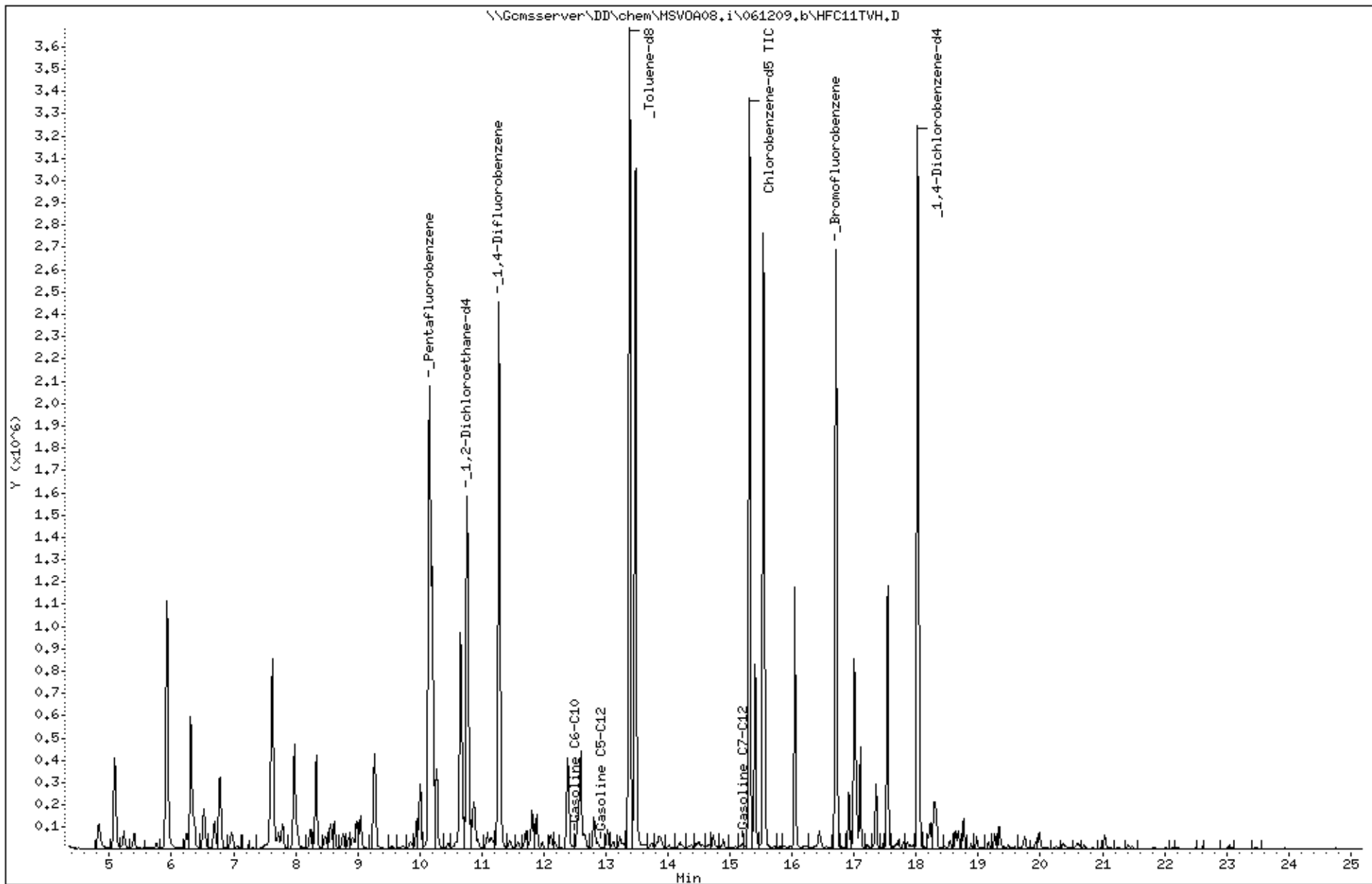

Appendix D

Chain of Custody Forms and Laboratory Reports
for the Groundwater Extraction Treatment System

Second Quarter 2009: Groundwater Monitoring and Remediation System Report
With Evaluation of Effectiveness of Monthly MPE



Curtis & Tompkins, Ltd., Analytical Laboratories, Since 1878

2323 Fifth Street, Berkeley, CA 94710, Phone (510) 486-0900

Laboratory Job Number 212766
ANALYTICAL REPORT

SOMA Environmental Engineering Inc.
6620 Owens Dr.
Pleasanton, CA 94588

Project : 2333
Location : 3609 International Blvd
Level : II

<u>Sample ID</u>	<u>Lab ID</u>
PSP-1	212766-001
GAC-1	212766-002
INFLUENT	212766-003

This data package has been reviewed for technical correctness and completeness. Release of this data has been authorized by the Laboratory Manager or the Manager's designee, as verified by the following signatures. The results contained in this report meet all requirements of NELAC and pertain only to those samples which were submitted for analysis. This report may be reproduced only in its entirety.

Signature: 
Project Manager

Date: 06/16/2009

Signature: 
Senior Program Manager

Date: 06/17/2009

NELAP # 01107CA

CASE NARRATIVE

Laboratory number: 212766
Client: SOMA Environmental Engineering Inc.
Project: 2333
Location: 3609 International Blvd
Request Date: 06/10/09
Samples Received: 06/10/09

This data package contains sample and QC results for three water samples, requested for the above referenced project on 06/10/09. The samples were received cold and intact.

Volatile Organics by GC/MS (EPA 8260B):
No analytical problems were encountered.

COOLER RECEIPT CHECKLIST



Curtis & Tompkins, Ltd.

Login # 212 763 / 212760 Date Received 6/10/09 Number of coolers 1
Client JMD Project 2693 / 2333

Date Opened 6/10/09 By (print) Tracy BBA7 (sign) Tracy BBA7
Date Logged in 6/11 By (print) Tracy BBA7 (sign) Tracy BBA7

1. Did cooler come with a shipping slip (airbill, etc) YES NO
Shipping info

2A. Were custody seals present? ... YES (circle) on cooler on samples NO
How many Name Date

2B. Were custody seals intact upon arrival? YES NO N/A

3. Were custody papers dry and intact when received? YES NO

4. Were custody papers filled out properly (ink, signed, etc)? YES NO

5. Is the project identifiable from custody papers? (If so fill out top of form) YES NO

6. Indicate the packing in cooler: (if other, describe)

- Bubble Wrap, Cloth material, Foam blocks, Cardboard, Bags, Styrofoam, None, Paper towels

7. Temperature documentation:

Type of ice used: Wet Blue/Gel None Temp(C)

Samples Received on ice & cold without a temperature blank

Samples received on ice directly from the field. Cooling process had begun

8. Were Method 5035 sampling containers present? YES NO
If YES, what time were they transferred to freezer?

9. Did all bottles arrive unbroken/unopened? YES NO

10. Are samples in the appropriate containers for indicated tests? YES NO

11. Are sample labels present, in good condition and complete? YES NO

12. Do the sample labels agree with custody papers? YES NO

13. Was sufficient amount of sample sent for tests requested? YES NO

14. Are the samples appropriately preserved? YES NO N/A

15. Are bubbles > 6mm absent in VOA samples? YES NO N/A

16. Was the client contacted concerning this sample delivery? YES NO

If YES, Who was called? By Date:

COMMENTS

Blank lines for handwritten comments.

Gasoline by GC/MS			
Lab #:	212766	Location:	3609 International Blvd
Client:	SOMA Environmental Engineering Inc.	Prep:	EPA 5030B
Project#:	2333	Analysis:	EPA 8260B
Matrix:	Water	Sampled:	06/08/09
Units:	ug/L	Received:	06/10/09

Field ID: PSP-1 Diln Fac: 1.000
 Type: SAMPLE Batch#: 151938
 Lab ID: 212766-001 Analyzed: 06/12/09

Analyte	Result	RL
Gasoline C7-C12	ND	50
MTBE	ND	0.50
Benzene	ND	0.50
Toluene	ND	0.50
Ethylbenzene	ND	0.50
m,p-Xylenes	ND	0.50
o-Xylene	ND	0.50

Surrogate	%REC	Limits
Dibromofluoromethane	94	80-122
1,2-Dichloroethane-d4	87	77-137
Toluene-d8	99	80-120
Bromofluorobenzene	105	80-125

Field ID: GAC-1 Diln Fac: 1.000
 Type: SAMPLE Batch#: 151938
 Lab ID: 212766-002 Analyzed: 06/12/09

Analyte	Result	RL
Gasoline C7-C12	ND	50
MTBE	ND	0.50
Benzene	ND	0.50
Toluene	ND	0.50
Ethylbenzene	ND	0.50
m,p-Xylenes	ND	0.50
o-Xylene	ND	0.50

Surrogate	%REC	Limits
Dibromofluoromethane	96	80-122
1,2-Dichloroethane-d4	91	77-137
Toluene-d8	101	80-120
Bromofluorobenzene	109	80-125

Y= Sample exhibits chromatographic pattern which does not resemble standard
 ND= Not Detected
 RL= Reporting Limit

Gasoline by GC/MS			
Lab #:	212766	Location:	3609 International Blvd
Client:	SOMA Environmental Engineering Inc.	Prep:	EPA 5030B
Project#:	2333	Analysis:	EPA 8260B
Matrix:	Water	Sampled:	06/08/09
Units:	ug/L	Received:	06/10/09

Field ID:	INFLUENT	Diln Fac:	10.00
Type:	SAMPLE	Batch#:	151990
Lab ID:	212766-003	Analyzed:	06/15/09

Analyte	Result	RL
Gasoline C7-C12	5,900 Y	500
MTBE	120	5.0
Benzene	230	5.0
Toluene	48	5.0
Ethylbenzene	30	5.0
m,p-Xylenes	680	5.0
o-Xylene	210	5.0

Surrogate	%REC	Limits
Dibromofluoromethane	96	80-122
1,2-Dichloroethane-d4	88	77-137
Toluene-d8	100	80-120
Bromofluorobenzene	109	80-125

Type:	BLANK	Batch#:	151938
Lab ID:	QC499781	Analyzed:	06/12/09
Diln Fac:	1.000		

Analyte	Result	RL
Gasoline C7-C12	ND	50
MTBE	ND	0.50
Benzene	ND	0.50
Toluene	ND	0.50
Ethylbenzene	ND	0.50
m,p-Xylenes	ND	0.50
o-Xylene	ND	0.50

Surrogate	%REC	Limits
Dibromofluoromethane	99	80-122
1,2-Dichloroethane-d4	93	77-137
Toluene-d8	99	80-120
Bromofluorobenzene	106	80-125

Y= Sample exhibits chromatographic pattern which does not resemble standard
 ND= Not Detected
 RL= Reporting Limit

Gasoline by GC/MS			
Lab #:	212766	Location:	3609 International Blvd
Client:	SOMA Environmental Engineering Inc.	Prep:	EPA 5030B
Project#:	2333	Analysis:	EPA 8260B
Matrix:	Water	Sampled:	06/08/09
Units:	ug/L	Received:	06/10/09

Type:	BLANK	Batch#:	151990
Lab ID:	QC499996	Analyzed:	06/15/09
Diln Fac:	1.000		

Analyte	Result	RL
Gasoline C7-C12	ND	50
MTBE	ND	0.50
Benzene	ND	0.50
Toluene	ND	0.50
Ethylbenzene	ND	0.50
m,p-Xylenes	ND	0.50
o-Xylene	ND	0.50

Surrogate	%REC	Limits
Dibromofluoromethane	97	80-122
1,2-Dichloroethane-d4	90	77-137
Toluene-d8	99	80-120
Bromofluorobenzene	109	80-125

Y= Sample exhibits chromatographic pattern which does not resemble standard
 ND= Not Detected
 RL= Reporting Limit

Batch QC Report

Gasoline by GC/MS			
Lab #:	212766	Location:	3609 International Blvd
Client:	SOMA Environmental Engineering Inc.	Prep:	EPA 5030B
Project#:	2333	Analysis:	EPA 8260B
Matrix:	Water	Batch#:	151938
Units:	ug/L	Analyzed:	06/12/09
Diln Fac:	1.000		

Type: BS Lab ID: QC499784

Analyte	Spiked	Result	%REC	Limits
Gasoline C7-C12	950.0	987.1	104	80-120

Surrogate	%REC	Limits
Dibromofluoromethane	101	80-122
1,2-Dichloroethane-d4	94	77-137
Toluene-d8	100	80-120
Bromofluorobenzene	109	80-125

Type: BSD Lab ID: QC499785

Analyte	Spiked	Result	%REC	Limits	RPD	Lim
Gasoline C7-C12	950.0	995.8	105	80-120	1	20

Surrogate	%REC	Limits
Dibromofluoromethane	99	80-122
1,2-Dichloroethane-d4	92	77-137
Toluene-d8	101	80-120
Bromofluorobenzene	107	80-125

RPD= Relative Percent Difference

Batch QC Report

Gasoline by GC/MS			
Lab #:	212766	Location:	3609 International Blvd
Client:	SOMA Environmental Engineering Inc.	Prep:	EPA 5030B
Project#:	2333	Analysis:	EPA 8260B
Matrix:	Water	Batch#:	151990
Units:	ug/L	Analyzed:	06/15/09
Diln Fac:	1.000		

Type: BS Lab ID: QC499999

Analyte	Spiked	Result	%REC	Limits
Gasoline C7-C12	750.0	823.9	110	80-120

Surrogate	%REC	Limits
Dibromofluoromethane	97	80-122
1,2-Dichloroethane-d4	88	77-137
Toluene-d8	101	80-120
Bromofluorobenzene	107	80-125

Type: BSD Lab ID: QC500000

Analyte	Spiked	Result	%REC	Limits	RPD	Lim
Gasoline C7-C12	750.0	841.1	112	80-120	2	20

Surrogate	%REC	Limits
Dibromofluoromethane	96	80-122
1,2-Dichloroethane-d4	88	77-137
Toluene-d8	99	80-120
Bromofluorobenzene	107	80-125

RPD= Relative Percent Difference

Batch QC Report

Gasoline by GC/MS			
Lab #:	212766	Location:	3609 International Blvd
Client:	SOMA Environmental Engineering Inc.	Prep:	EPA 5030B
Project#:	2333	Analysis:	EPA 8260B
Field ID:	ZZZZZZZZZZ	Batch#:	151990
MSS Lab ID:	212774-001	Sampled:	06/11/09
Matrix:	Water	Received:	06/11/09
Units:	ug/L	Analyzed:	06/16/09
Diln Fac:	1.000		

Type: MS Lab ID: QC500113

Analyte	MSS Result	Spiked	Result	%REC	Limits
MTBE	<0.1000	25.00	24.14	97	73-124
Benzene	<0.1000	25.00	28.24	113	80-122
Toluene	<0.1000	25.00	28.56	114	80-121
Ethylbenzene	<0.1525	25.00	29.52	118	80-121
m,p-Xylenes	<0.1000	50.00	58.19	116	80-120
o-Xylene	<0.1000	25.00	29.06	116	80-120

Surrogate	%REC	Limits
Dibromofluoromethane	95	80-122
1,2-Dichloroethane-d4	85	77-137
Toluene-d8	101	80-120
Bromofluorobenzene	109	80-125

Type: MSD Lab ID: QC500114

Analyte	Spiked	Result	%REC	Limits	RPD	Lim
MTBE	25.00	24.72	99	73-124	2	20
Benzene	25.00	26.87	107	80-122	5	20
Toluene	25.00	27.06	108	80-121	5	20
Ethylbenzene	25.00	29.13	117	80-121	1	20
m,p-Xylenes	50.00	58.25	116	80-120	0	20
o-Xylene	25.00	28.88	116	80-120	1	20

Surrogate	%REC	Limits
Dibromofluoromethane	97	80-122
1,2-Dichloroethane-d4	86	77-137
Toluene-d8	99	80-120
Bromofluorobenzene	109	80-125

RPD= Relative Percent Difference

Date : 15-JUN-2009 23:47

Client ID: DYNA P&T

Sample Info: S,212766-003

Instrument: MSV0A08.i

Operator: voc

Column diameter: 2.00

Column phase:

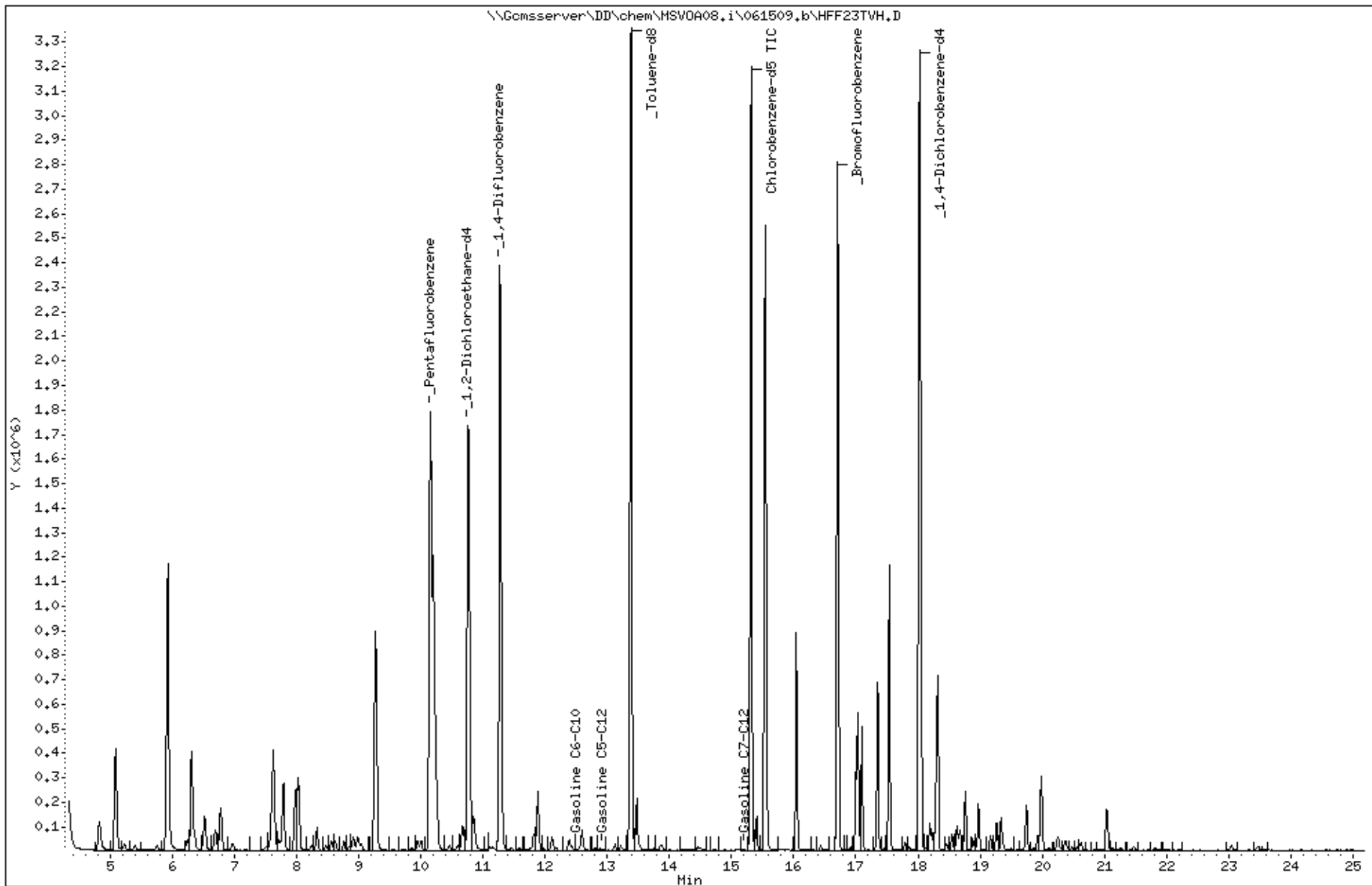

Date : 12-JUN-2009 13:47

Client ID: DYNA P&T

Sample Info: CCV/BS, QC499784, 151938, S12208, .0095/100

Instrument: MSV0A08.i

Operator: voc

Column diameter: 2.00

Column phase:

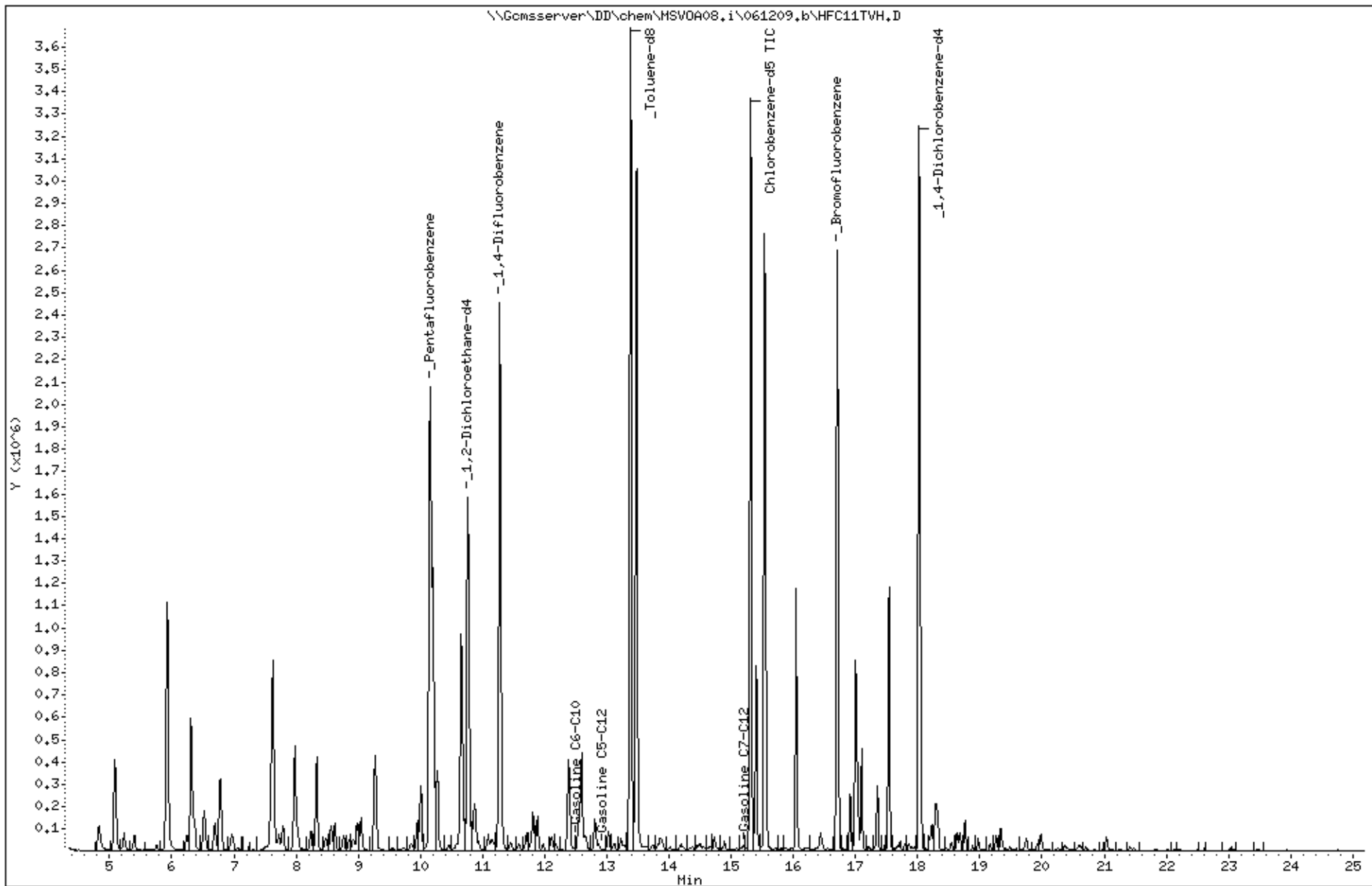

Appendix E

May 2009 MPE Event Field Data Sheets

Second Quarter 2009: Groundwater Monitoring and Remediation System Report
With Evaluation of Effectiveness of Monthly MPE



ADDRESS: 3609 International Blvd., Oakland
 PROJECT #: 2335

MTS OPERATIONAL DATA

DATE	TIME	OXIDIZER TEMPERATURE (F)	PUMP/AIR TEMPERATURE (F)	STINGER VACUUM (IN-Hg)	PUMP VACUUM (IN-Hg)	TOTAL FLOW (SCFM)	DILUTION FLOW (SCFM)	WELL FLOW (SCFM)	EFFLUENT FLOW (IN-H2O)	EFFLUENT TEMP (F)	INFLUENT CONC (PPMV)	WATER TOTALIZER
5/11/2009	1230	Begin extraction from wells MW-1,3; Too much water being extracted w/ all wells										
	1330	1599	171	18.3	25.8	57	0	57	0.10	154	1,635	178
	1430	1565	174	17.7	25.3	65	0	65	0.10	154	1,030	359
	1530	1588	173	24.3	26.4	47	0	47	0.10	154	769	557
	1630	1589	173	24.2	26.4	47	0	47	0.10	154	632	713
5/12/2009	MW-3 & MW-6 overnight, added MW-8 @ 8:45 AM											
	900	1507	173	17	25.2	66	0	66	0.10	154	eff=3; in=464	3,195
	1000	1548	172	23.1	25.7	58	0	58	0.10	154	706	3,427
	1400	1520	192	22.6	25.6	60	0	60	0.10	154	428	4,306
	1530	1529	184	22.7	25.6	60	0	60	0.10	154	442	4,622
	1630	1531	174	22.7	25.5	62	0	62	0.10	154	439	4,813
5/13/2009	630	1474	174	22.2	25.4	63	0	63	0.10	154	310	7,588
	1030	1498	173	22.2	25.4	63	0	63	0.10	154	324	8,345
	1430	1508	178	22	25.2	66	0	66	0.10	154	334	9,141
	1530	1503	173	21.9	25.2	66	0	66	0.10	154	339	9,293
	Added MW-1 after reading; system shutdown 10 mins later from influent overload; high-high level sensor closed valve											
	1630	1500	174	21.4	25.2	66	0	66	0.10	154	459	9,527
5/14/2009	700	1450	174	21.8	25	70	0	70	0.12	146	294	12,238
	1230	1471	178	21.7	25.2	66	0	66	0.12	146	294	13,332
	1330	1485	174	21.7	25.1	68	0	68	0.12	146	304	13,440
	1430	1480	186	21.6	25	70	0	70	0.12	148	302	13,617



ADDRESS: 3609 International Blvd., Oakland
PROJECT #: 2335

MTS OPERATIONAL DATA

DATE	TIME	OXIDIZER TEMPERATURE (F)	PUMP/AIR TEMPERATURE (F)	STINGER VACUUM (IN-Hg)	PUMP VACUUM (IN-Hg)	TOTAL FLOW (SCFM)	DILUTION FLOW (SCFM)	WELL FLOW (SCFM)	EFFLUENT FLOW (IN-H2O)	EFFLUENT TEMP (F)	INFLUENT CONC (PPMV)	WATER TOTALIZER
	1530	1483	180	21.6	25	70	0	70	0.12	148	304	13,724
	1630	1484	187	21.6	25	70	0	70	0.12	148	301	13,839
5/15/2009	1000	1500	172	21.6	25	70	0	70	0.12	148	328	15,988
	1230	1500	174	21.6	25	70	0	70	0.12	148	280	16,328
	1330	1501	173	21.6	25	70	0	70	0.12	148	299	16,448
	1430	1502	174	21.6	25	70	0	70	0.12	148	265	16,575
	1530	1504	174	21.6	25	70	0	70	0.12	148	244	16,799
	1630	1500	175	21.6	25	70	0	70	0.12	148	286	16,923
		End extraction										