

1252 Quarry Lane
P.O. Box 9019
Pleasanton, CA 94566
(510) 426-2600
Fax (510) 426-0106

Clayton
ENVIRONMENTAL
CONSULTANTS

April 29, 1993

Ms. Juliett Shin
Hazardous Materials Specialist
ALAMEDA COUNTY HEALTH CARE SERVICES AGENCY
80 Swan Way, Room 200
Oakland, California 94621

Clayton Project No. 45040.08

Subject: Revised Quarterly Report for the South Shore Sopping Center in Alameda,
California

Dear Ms. Shin:

Clayton Environmental Consultants, Inc. is pleased to present a copy of our revised quarterly report for the activities conducted from November 1992 to February 1993 at the South Shore Shopping Center, located at the corner of Park Street and Shoreline Drive in Alameda, California.

The original quarterly report was sent to you in March 1993. Please note that following revisions have been incorporated into the revised report.

- The location of monitoring wells MW-24 and MW-25 have been modified in the maps to reflect their correct locations.
- The quarterly report for Kamur Industries is included in the revised report as Appendix C.
- Groundwater contamination plums have adjusted for the new locations of monitoring wells MW-24 and MW-25.
- Minor changes have been made to the isoconcentration maps for chlorinated hydrocarbons in the former Texaco Gas Station area to more accurately reflect the size of the groundwater contamination plume.

Ms. Juliatt Shin
Alameda County Health Care Services
April 29, 1993

Page 2
Clayton Project No. 45040.08

If you have any questions or comments regarding this report, please contact me at
(510) 426-2616 or Dariush Dastmalchi at (510) 426-2609.

Sincerely,

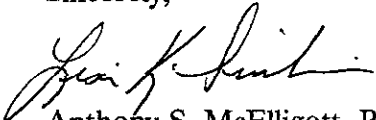

for
Anthony S. McElligott, P.E.
Supervisor, Remediation
Western Operations

ASM/cmh

Enclosure

cc: Mr. Bernard Levy of Harsch Investment Corp., Portland
Mr. Lester Feldman of the Regional Water Quality Control Board
Mr. Bob Robles of Texaco Refining and Marketing Inc.
Mr. Murray Stevens of Kamur Industries
Mr. Bob Leste and Mr. Herman Engbers, Harsch Investment Corp., Oakland

Western Operations

1252 Quarry Lane
P.O. Box 9019
Pleasanton, CA 94566
(510) 426-2600
Fax (510) 426-0106

Clayton
ENVIRONMENTAL
CONSULTANTS

Revised Quarterly Report
for
South Shore Shopping Center
Corner of Shore Line Drive and Park Street
Alameda, California

Clayton Project No. 45040.08
April 26, 1993

CONTENTS

<u>Section</u>	<u>Page</u>
1.0 <u>INTRODUCTION</u>	1
2.0 <u>TASK 1: MONITORING WELL INSTALLATION</u>	1
3.0 <u>TASK 2: MONITORING WELL DEVELOPMENT</u>	2
4.0 <u>TASK 3: GROUNDWATER MONITORING AND SAMPLING</u>	2
5.0 <u>TASK 4: SOIL AND GROUNDWATER SAMPLE ANALYSES</u>	2
6.0 <u>FINDINGS AND CONCLUSIONS</u>	3
7.0 <u>FUTURE ACTIVITIES</u>	5

Figures

- 1 Site Location and Topographic Map
- 2 New Monitoring Well Locations
- 3 Monitoring Well Schematic for MW-22
- 4 Monitoring Well Schematic for MW-23
- 5 Isoconcentration Map for Gasoline
- 6 Isoconcentration Map for Benzene
- 7 Isoconcentration Map for Diesel
- 8 Isoconcentration Map for Cis-1,2,-dichloroethene
- 9 Isoconcentration Map for Trichloroethene
- 10 Isoconcentration Map for Tetrachloroethene
- 11 Isoconcentration Map for 1,2-dichloroethane
- 12 Groundwater Elevations

CONTENTS
(continued)

Appendices

- A BORING LOGS
- B DRILLING, WELL CONSTRUCTION, AND SAMPLING PROTOCOLS
FOR BOREHOLE/MONITORING WELL INSTALLATION
- C KAMUR INDUSTRIES REPORT
- D MONITORING WELL SAMPLING PROTOCOLS BASED ON THE
RWQCB AND ACHCSA GUIDELINES
- E WATER SAMPLING FIELD SURVEY FORMS
- F PREVIOUS GROUNDWATER SAMPLING RESULTS
- G CLAYTON'S LABORATORY ANALYTICAL REPORTS

1.0 INTRODUCTION

Clayton Environmental Consultants, Inc. was retained by Harsch Investment Corp. to conduct quarterly monitoring activities at the South Shore Shopping Center at the corner of Shore Line Drive and Park Street in Alameda, California (Figure 1). These activities were conducted from November, 1992 to February, 1993. The following tasks were completed during this period:

- Task 1 - Monitoring Well Installation (MW-22, MW-23, MW-24 and MW-25)
- Task 2 - Monitoring Well Development
- Task 3 - Groundwater monitoring and sampling
- Task 4 - Soil and groundwater samples analysis

2.0 TASK 1: MONITORING WELL INSTALLATION

On February 16, 1993, Clayton observed the installation of two monitoring wells MW-22 and MW-23 (Figure 2). Before commencing the drilling activities, Clayton had prepared a health and safety plan based on the planned work activities and environmental investigations, in accordance with Title 29 of the Code of Federal Regulations, Section 1910.120 (29 CFR 1910.120).

During the drilling of the monitoring wells, soil characteristics were logged in the field by Mr. Dariush Dastmalchi, Clayton geologist, using the Unified Soil Classification System (Appendix A). Distinguishing features such as color, odor, and relative soil moisture content were noted in the field logs. Drilling and sampling activities were conducted in accordance with the Regional Water Quality Control Board (RWQCB), and Tri-Regional and Alameda County Health Care Services Agency (ACHCSA) guidelines. Clayton's drilling, well construction, and sampling protocols for borehole/monitoring well installation (Appendix B) was supervised by a civil engineer registered in the State of California.

To aid in locating contamination, Clayton screened the soil cuttings during the drilling activity for total ionizable organic compounds using a photoionization detector (PID), and visually examined the soil for petroleum compounds. Clayton collected soil samples with a 2.5-inch split-barrel sampler until groundwater was encountered.

Monitoring well MW-22 was installed to assess the extent of the contamination from the former Texaco Gas Station. It was drilled southeast of the Lyon's Restaurant (former Texaco service station). Monitoring well MW-22 was permitted by the East Bay Regional Parks District and was constructed within park property. The well was constructed of 2-inch diameter polyvinyl chloride (PVC) casing to a depth of 25 feet below ground surface (bgs).

Monitoring well MW-23 was installed to determine the possible extent of the contamination from operation of the hydraulic lifts in the former Goodyear Service Station (currently a Big 5 Sporting Goods Store). Monitoring well MW-23 was permitted by Alameda County Flood Control and Water Conservation District (Zone 7). The well was constructed of 2-inch diameter PVC casing to a depth of 20 feet bgs.

The monitoring wells were constructed using screened casing extending above the water table. Solid casing was then installed to the surface. The sand pack was

extended to 1 foot above the screen. A 1-foot thick bentonite seal was placed on top of the sand pack, and the well was sealed to the surface using cement grout. A locking cap was used to secure the well in a Christie box that was raised above the surface grade by approximately 1 inch. Figures 3 and 4 show the schematic diagrams for construction of these wells.

The Kamur Industries report for groundwater sampling and installation of monitoring wells MW-24 and MW-25 is included in Appendix C. Please note that in the Kamur Industries report monitoring well MW-24 is identified as STMW-6 and monitoring well MW-25 is referred to as STMW-5.

3.0 TASK 2: MONITORING WELL DEVELOPMENT

The well seal in newly constructed wells was allowed to set for 72 hours prior to development. Development of the well can volatilize the contaminants present; therefore, the wells were sampled 72 hours after development.

The wells were developed using disposable bailers until water turbidity and specific conductance stabilized.

4.0 TASK 3: GROUNDWATER MONITORING AND SAMPLING

On February 23 and 24, 1993, Clayton collected groundwater samples from monitoring wells MW-5B, MW-7B, MW-8B, MW-11, MW-14, MW-15, MW-16, MW-17, MW-18, MW-22 and MW-23. The groundwater samples were collected in clean laboratory-supplied containers and placed immediately into an iced cooler for transport to Clayton's laboratory. One trip blank was furnished in accordance with Clayton's quality assurance/quality control (QA/QC) program. Groundwater sampling activities were conducted according to Clayton's monitoring well sampling protocols based on the RWQCB and ACHCSA guidelines (Appendix D). Details of the groundwater sampling activities are provided in the water sampling field survey forms (Appendix E).

Monitoring wells MW-10 (designated as STMW-1 by Kamur Industries), MW-12 (designated as STMW-3 by Kamur Industries) MW-24 and MW-25 were sampled by Kamur Industries (see Appendix C).

The groundwater elevations were measured by Clayton in monitoring wells MW-13 (designated as STMW-4 by Kamur Industries), MW-19, MW-20, and MW-21 to determine the groundwater gradient beneath the subject property. However, no samples were collected for laboratory analysis from these monitoring wells.

5.0 TASK 4: SOIL AND GROUNDWATER SAMPLE ANALYSES

Clayton collected one soil sample at the soil and water interphase from each well for laboratory analysis. The soil sample collected from the monitoring well MW-22 was analyzed by the following Environmental Protection Agency (EPA) Methods:

- EPA Method 8015 for total petroleum hydrocarbons as gasoline (TPH-G)
- EPA Method 8020 for benzene, toluene, ethylbenzene and xylene (BTEX)

The soil sample collected from monitoring well MW-23 was analyzed by the following methods:

- EPA Method 8015 for TPH-G
- EPA Method 8020 for BTEX
- EPA Method 8015 for total petroleum hydrocarbons as diesel (TPH-D)
- EPA Method 8015 for total petroleum hydrocarbons as motor oil
- EPA Method 8010 for halogenated hydrocarbons

The groundwater samples were analyzed by one or more of the following methods:

- EPA Method 8015 for TPH-G
- EPA Method 8020 for BTEX
- EPA Method 8015 for (TPH-D)
- EPA Method 601 for halogenated hydrocarbons
- EPA Method 6010 for metals
- EPA Method 160.1 for total dissolved solids (TDS)
- Standard Method 5520-F for total hydrocarbons oil and grease (O&G)

Laboratory analysis performed for the groundwater samples are shown in Table 1.

Table 2 summarizes the laboratory results for the groundwater samples collected in February 1993. The regulatory guidelines are also listed in this table. Previous groundwater sampling results are included in Appendix F. Table 2 lists only those compounds detected at or above analytical detection limits. Clayton's laboratory analytical reports are presented in Appendix G. Kamur Industries analytical reports are included in Appendix C.

Past sampling activities of monitoring wells MW-15 and MW-18 through MW-21, did not reveal any constituents at or above analytical detection limits. Therefore these wells are not include in Appendix F. Monitoring wells MW-10 through MW-13 were monitored by the Kamur Industries, therefore, the historical data for these wells is not included in this report.

6.0 FINDINGS AND CONCLUSIONS

Based on the laboratory reports, we conclude the following:

- The highest concentration of TPH-G was detected in the groundwater sample collected from MW-12. TPH-G was also present in the groundwater samples collected from MW-5B, MW-10 and MW-25. No drinking water standards are published for TPH-G at this time. The isoconcentration map for TPH-G is presented in Figure 5.
- Benzene was detected in the groundwater samples collected from monitoring wells MW-5B, MW-10, MW-12 and MW-25 only, at levels that exceeds the drinking water standard. Figure 6 shows an isoconcentration contour map for benzene.
- The concentrations of total xylenes and ethylbenzene in the groundwater sample collected from MW-12 exceed the drinking water standards. The groundwater

samples collected from MW-5B and MW-10 contained xylenes and ethylbenzene at concentrations lower than the drinking water standards.

- The concentration of toluene in the groundwater samples collected from MW-5B, MW-10, MW-12 and MW-25 ranged from 4.2 micrograms per liter ($\mu\text{g/l}$) to 1900 $\mu\text{g/l}$. No drinking water standard has been published for toluene at this time.
- The concentration of TPH-D in the groundwater samples from MW-5B, MW-14, MW-15, and MW-22 exceeds the Suggested No-Adverse Response Levels (SNARL) set by the USEPA. No drinking water standard is published for diesel at this time. Figure 7 shows an isoconcentration map for TPH-D.
- The concentrations of cis-1,2-dichloroethene, trichloroethene, and tetrachloroethene in the groundwater samples collected from monitoring wells MW-7B and MW-8 exceeds their respective drinking water standards. Isoconcentration contour lines for these compounds are presented in Figures 8, 9, and 10.
- Chlorobenzene, trans-1,4-dichloroethene, and 1,1-dichloroethene historically have been present in the groundwater samples from MW-7B. However, they were not detected in the groundwater sample from MW-7B. The detection limits were increased above the concentrations used for drinking water standards due to matrix interference from tetrachloroethene; therefore, these compounds may be present in the sample at concentrations above the drinking water standards but less than the detection limits achieved.
- The concentration of 1,2-dichloroethane in the groundwater samples collected from monitoring wells MW-14 and MW-22 exceeds the drinking water standard. The concentration of 1,2-dichloroethane increases with increasing distance from the former Texaco site, in the direction of the groundwater flow. The cause for this increase is not known at this time. However, this may indicate that the contaminant plume has moved away from the site and the concentration in monitoring well MW-5B is the tail end of the plume. An isoconcentration map for 1,2-dichloroethane is shown on Figure 11.
- The groundwater sample from monitoring well MW-12 contained 3,900 $\mu\text{g/l}$ oil and grease. No drinking water standards have been published for oil and grease at this time.
- The groundwater flow direction beneath the subject property is presented in Figure 12. The groundwater flow beneath the former Texaco Gas Station and the former dry cleaner site is similar to the ground surface topography toward San Francisco Bay. In contrast, the groundwater beneath Kamur Industries flows in a northerly direction and away from San Francisco Bay. The cause for this flow direction beneath Kamur Industries is not known at this time. However, it may be caused by a ruptured or leaking water line(s) or excessive water infiltration from the surface.
- TDS concentrations in groundwater samples collected from monitoring wells MW-16, MW-17, and MW-18 exceeds the State Water Resources guideline of 3,000 milligrams per liter (mg/l) for potential drinking water sources.

- The soil sample collected during the installation of monitoring well MW-22 contained 0.007 milligrams per kilogram (mg/kg) toluene. The laboratory reports did not indicate any compounds at concentrations at or above the analytical detection limits in other soil samples collected by Clayton or Kamur Industries.

7.0 FUTURE ACTIVITIES

On October 9, 1992, ACHCSA requested that Harsch Investment Corp. prepare a work plan for further investigations and possible remediation. We are currently in the process of preparing this work plan. We expect to present the work plan to RWQCB and ACHCSA by April 26, 1993.

This report prepared by:



Dariush Dastmalchi
Geologist

This report reviewed by:



for Anthony S. McElligott
Supervisor, Remediation
Western Operations

April 26, 1993

FIGURES

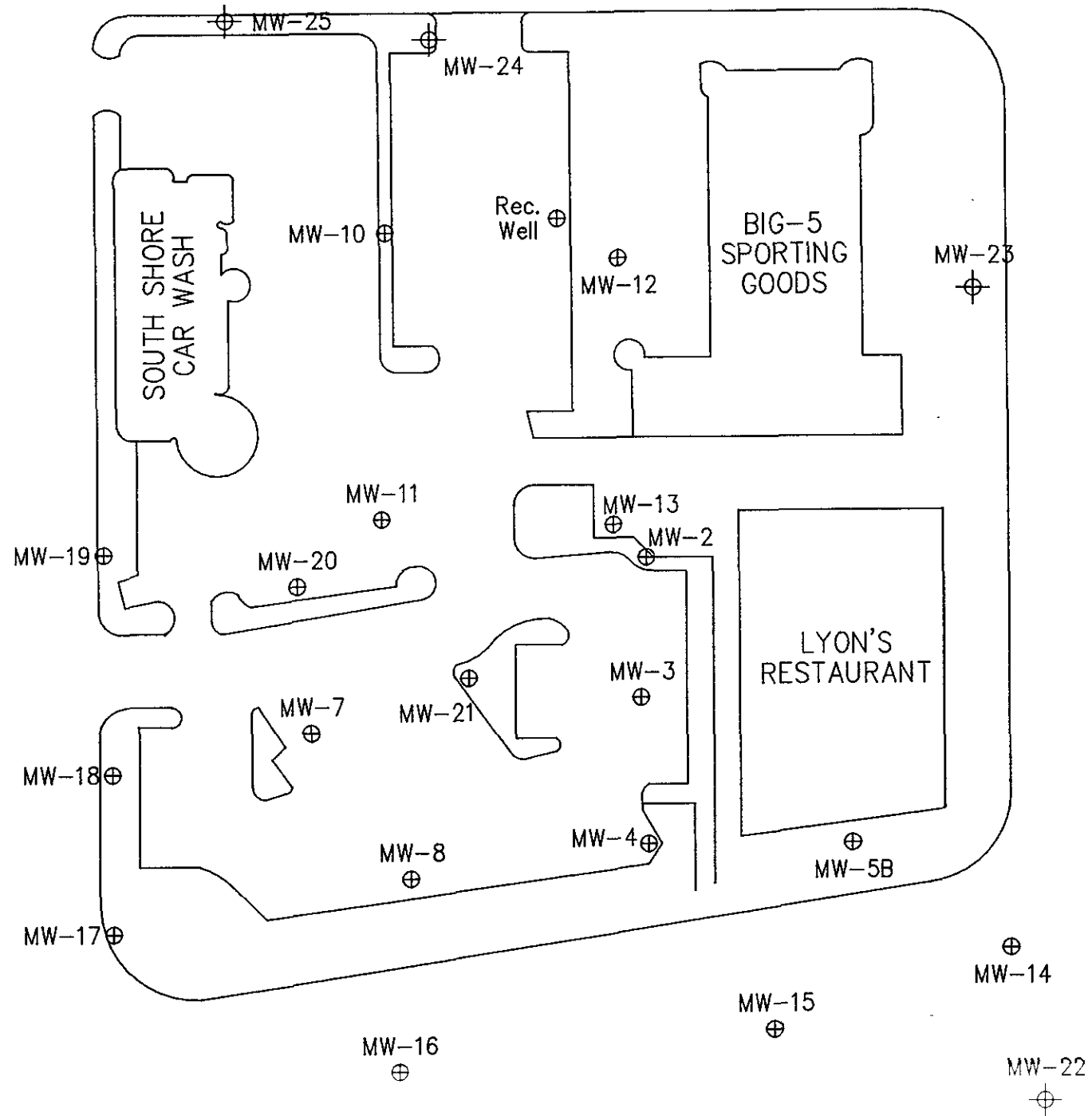

LEGEND

- ⊕ Existing Monitoring Wells
- ⊕⊥ New Monitoring Wells
- Not detected at or above detection limit

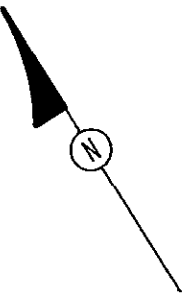

New Monitoring Wells Location
 SOUTH SHORE SHOPPING CENTER
 Corner of South Shore Drive and Park Street
 Alameda, California

(not to scale) Clayton Project No. 45040.08

Figure
 2
 45040-DL-16

Clayton
 ENVIRONMENTAL
 CONSULTANTS

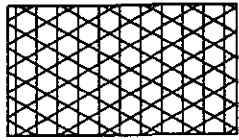

Concrete



Bentonite

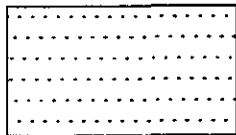

Sand #2/12

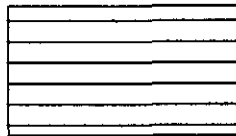

0.01" Slotted
Screen

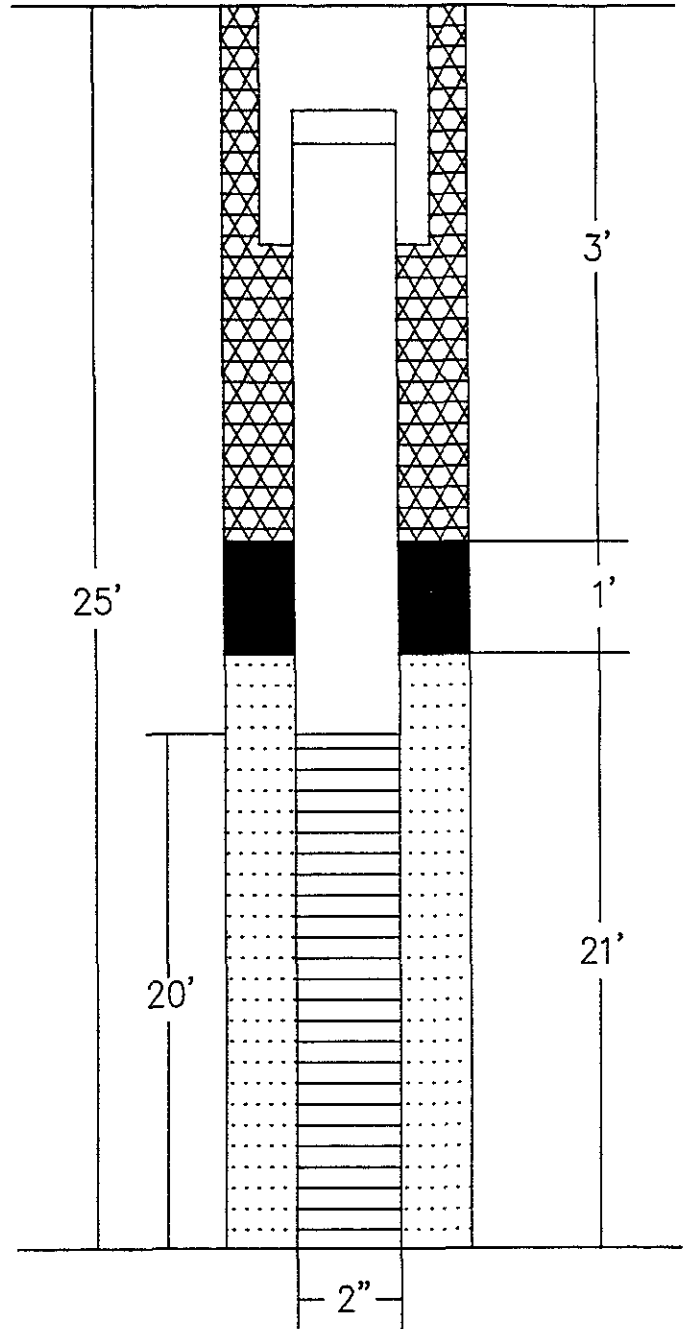

Schematic Diagram for Monitoring Well MW-22
 SOUTH SHORE SHOPPING CENTER
 Corner of South Shore Drive and Park Street
 Alameda, California

(not to scale) Clayton Project No. 45040.08

Figure

3

Clayton
 ENVIRONMENTAL
 CONSULTANT

45040-MW-16

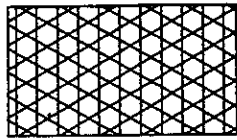

Concrete



Bentonite

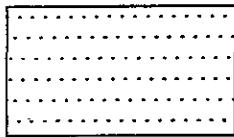

Sand #2/12



0.01" Slotted
Screen

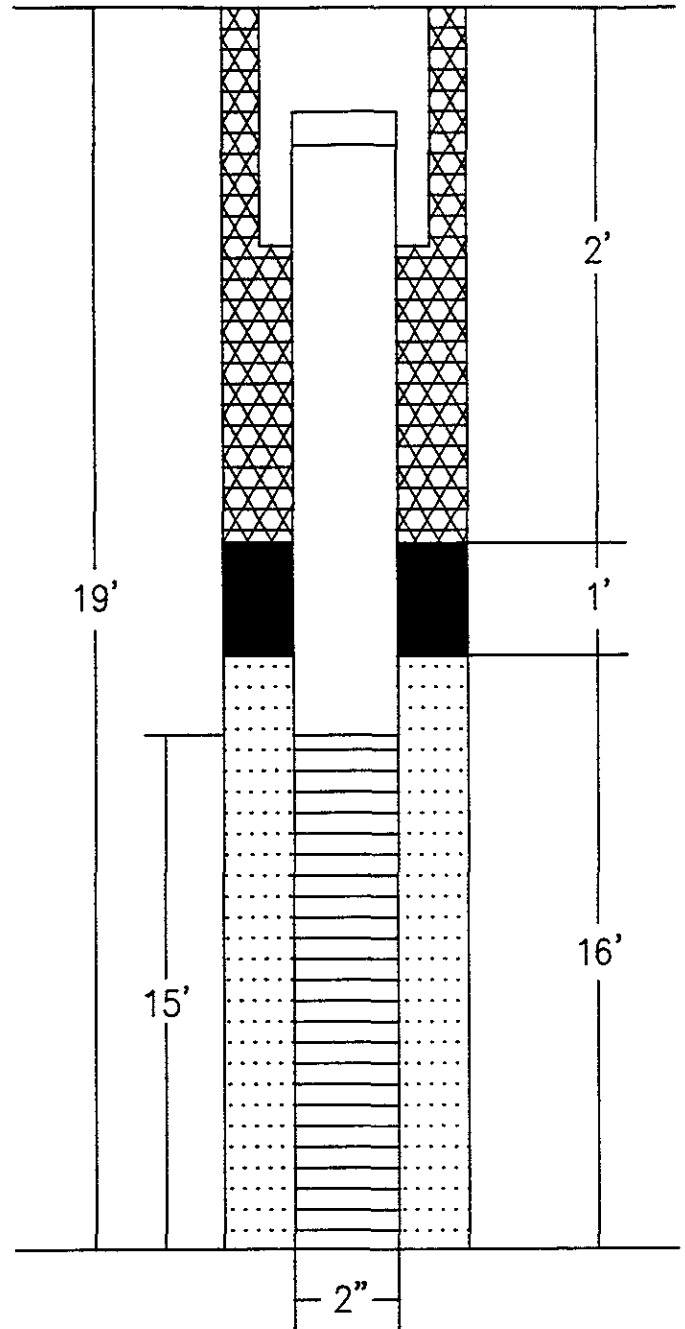

Schematic Diagram for Monitoring Well MW-23
 SOUTH SHORE SHOPPING CENTER
 Corner of South Shore Drive and Park Street
 Alameda, California

(not to scale) Clayton Project No. 45040.08

Figure

4

Clayton
 ENVIRONMENTAL
 CONSULTANT

45040-MW-17

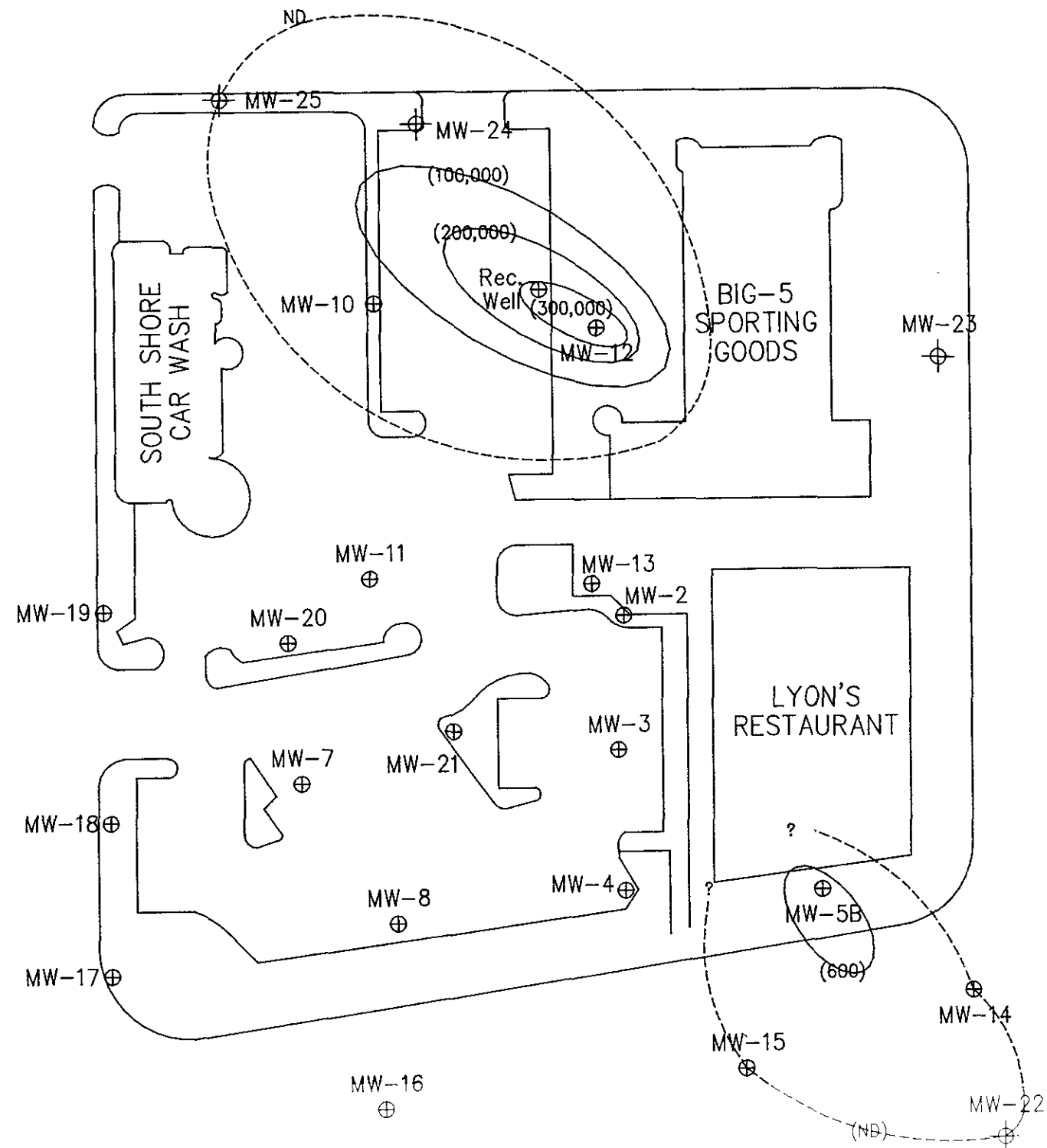

LEGEND	
	Isoconcentration Line (Dashed where inferred)
(200)	Concentration
⊕	Existing Monitoring Wells
⊕	New Monitoring Wells
ND	Not detected at or above detection limit

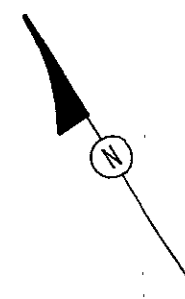



Isoconcentration Map for Gasoline
 SOUTH SHORE SHOPPING CENTER
 Corner of South Shore Drive and Park Street
 Alameda, California
 Clayton Project No. 45040.08

Figure
 5
 45040-GS-16

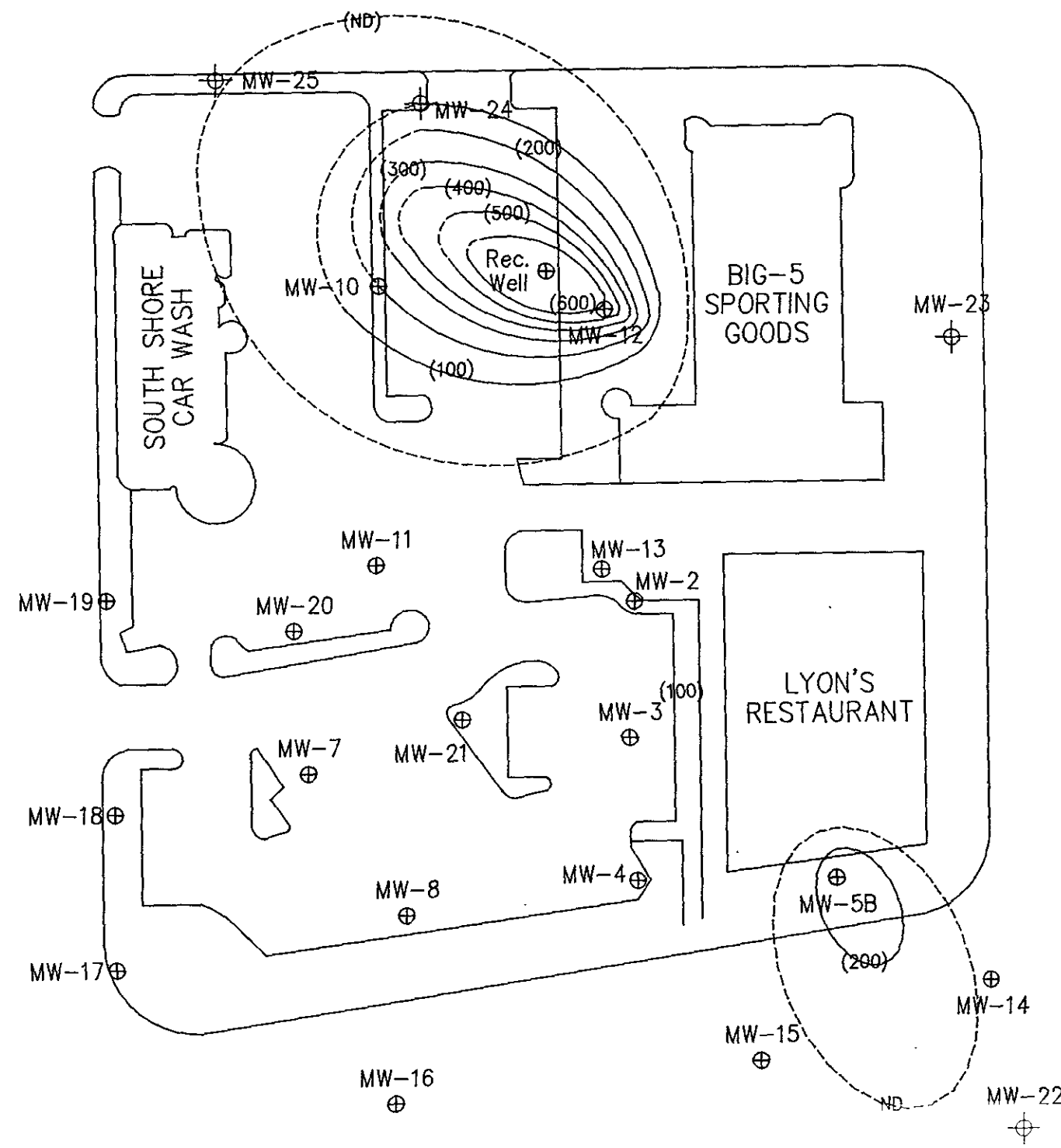
Clayton
 ENVIRONMENTAL
 CONSULTANTS

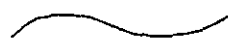
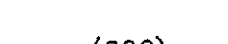

LEGEND	
	Isoconcentration Line
	(Dashed where inferred)
(200)	Concentration
	Existing Monitoring Wells
	New Monitoring Wells
ND	Not detected at or above detection limit

Isoconcentration Map for Benzene
 SOUTH SHORE SHOPPING CENTER
 Corner of Shore Line Drive and Park Street
 Alameda, California
 Clayton Project No. 45040.08

Figure
 6
 45040-BZ-16

Clayton
 ENVIRONMENTAL
 CONSULTANTS

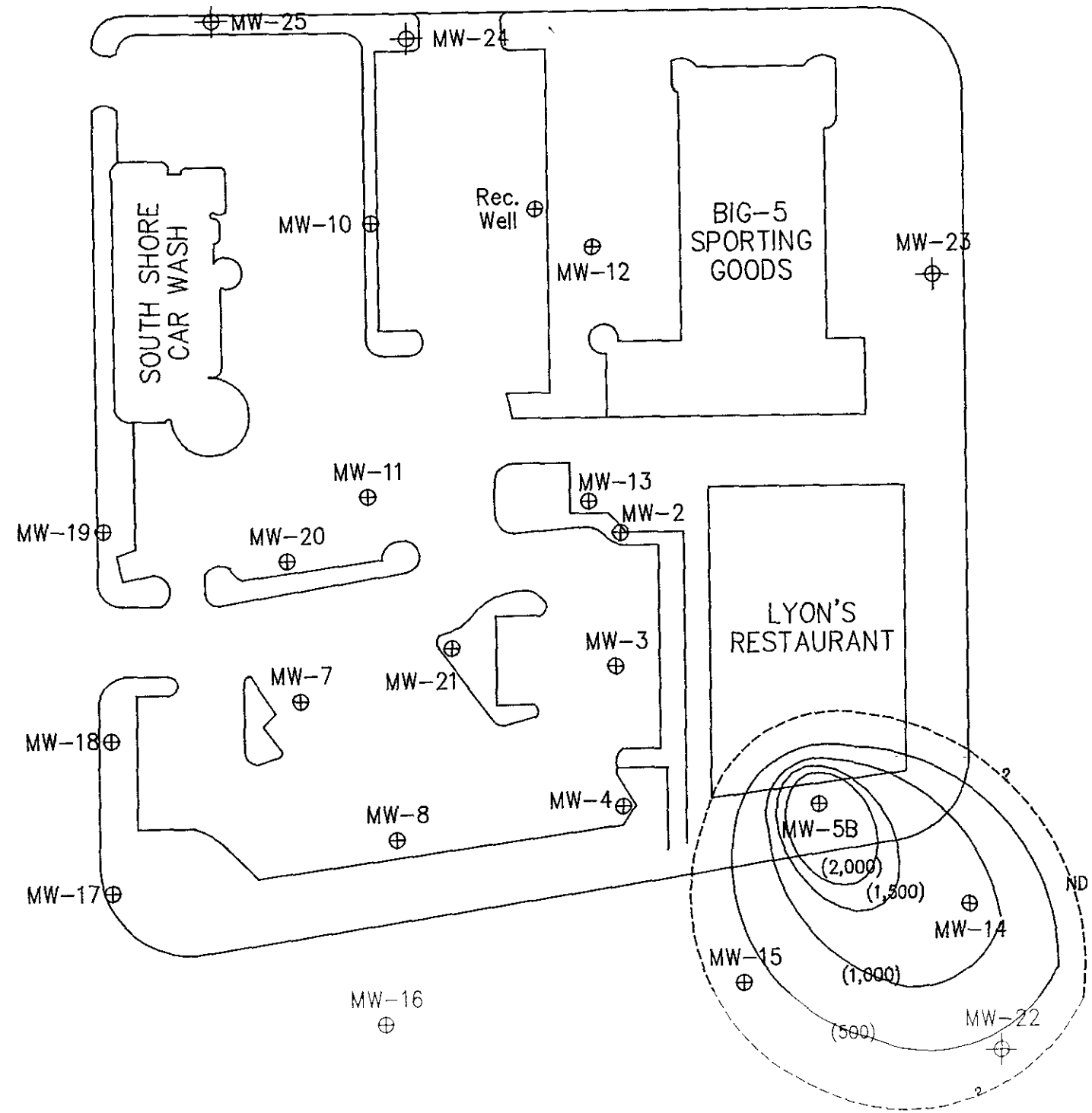

LEGEND	
	Isoconcentration Line (Dashed where inferred)
(200)	Concentration
⊕	Existing Monitoring Wells
⊕	New Monitoring Wells
ND	Not detected at or above detection limit

Isoconcentration Map for Diesel
 SOUTH SHORE SHOPPING CENTER
 Corner of South Shore Drive and Park Street
 Alameda, California
 Clayton Project No. 45040.08

Figure
 7
 45040-DL-16

Clayton
 ENVIRONMENTAL
 CONSULTANTS

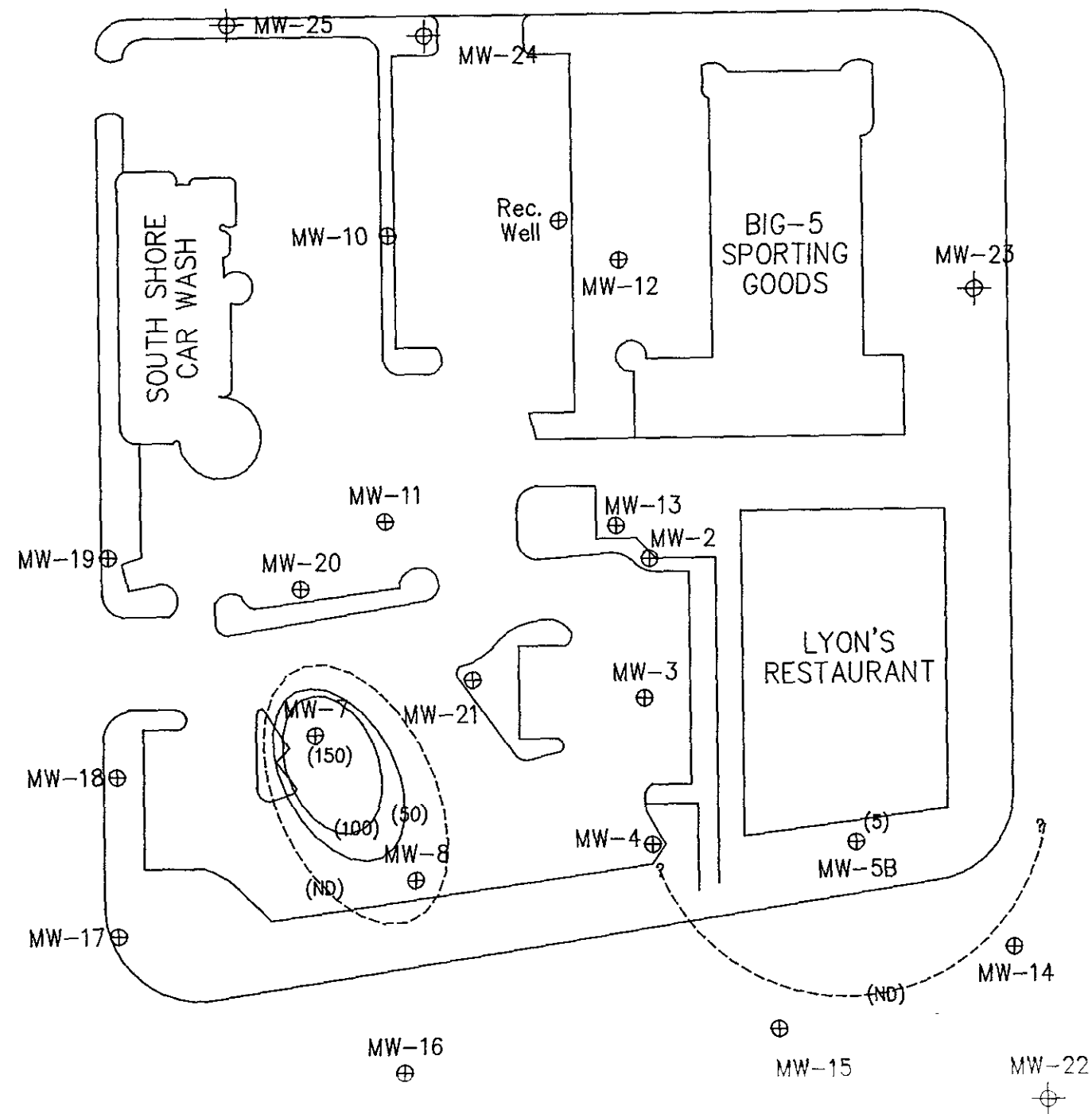

LEGEND	
	Isoconcentration Line (Dashed where inferred)
(200)	Concentration
⊕	Existing Monitoring Wells
⊕	New Monitoring Wells
ND	Not detected at or above detection limit

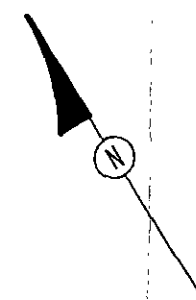

Isoconcentration Map for Cis-1,2-dichloroethene
 SOUTH SHORE SHOPPING CENTER
 Corner of South Shore Drive and Park Street
 Alameda, California
 Clayton Project No. 45040.08

Figure
 8
 45040-DE-16

Clayton
 ENVIRONMENTAL
 CONSULTANTS

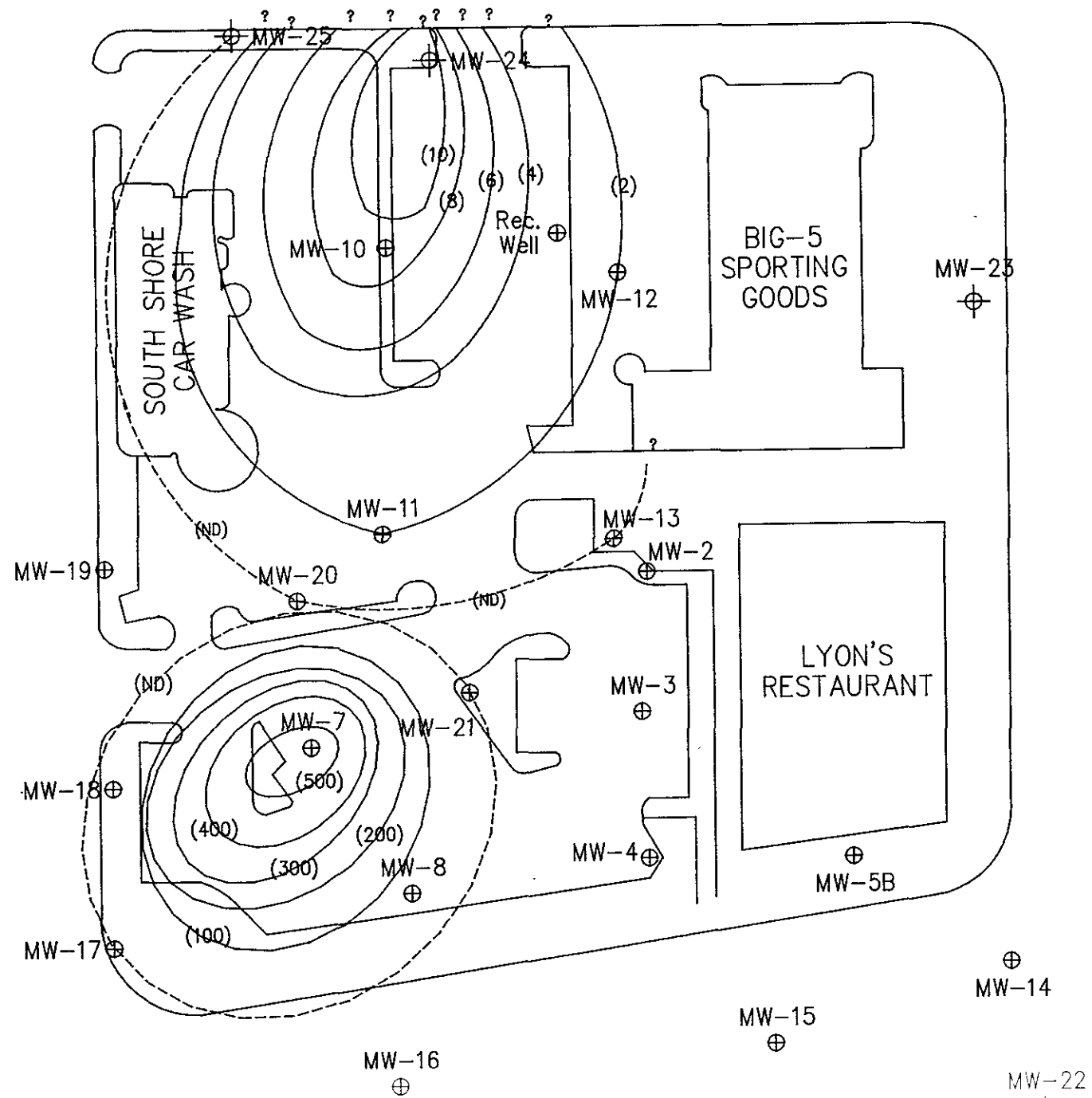

LEGEND	
	Isoconcentration Line (Dashed where inferred)
(200)	Concentration
	Existing Monitoring Wells
	New Monitoring Wells
ND	Not detected at or above detection limit

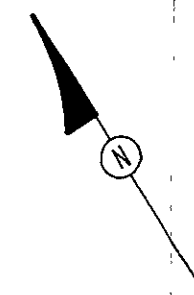

Isoconcentration Map for Trichloroethene
 SOUTH SHORE SHOPPING CENTER
 Corner of South Shore Drive and Park Street
 Alameda, California
 Clayton Project No. 45040.08

Figure
 9
 45040-TC-16

Clayton
 ENVIRONMENTAL
 CONSULTANTS

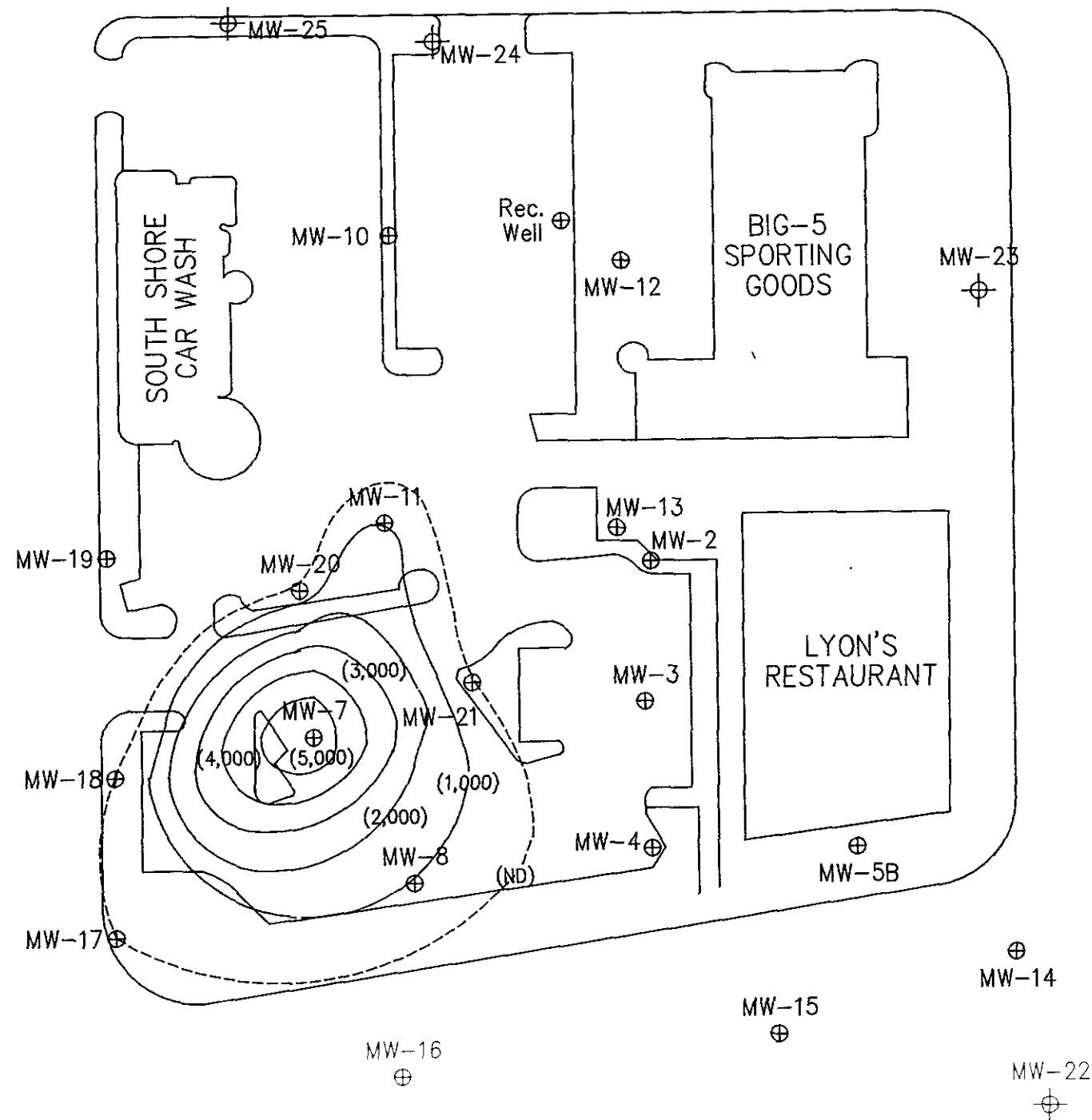

LEGEND	
	Isoconcentration Line (Dashed where inferred)
(200)	Concentration
	Existing Monitoring Wells
	New Monitoring Wells
ND	Not detected at or above detection limit

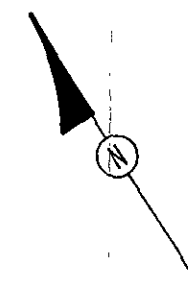

Isoconcentration Map for Tetrachloroethene
 SOUTH SHORE SHOPPING CENTER
 Corner of South Shore Drive and Park Street
 Alameda, California
 Clayton Project No. 45040.08

Figure
 10
 45040-PC-16

Clayton
 ENVIRONMENTAL
 CONSULTANTS

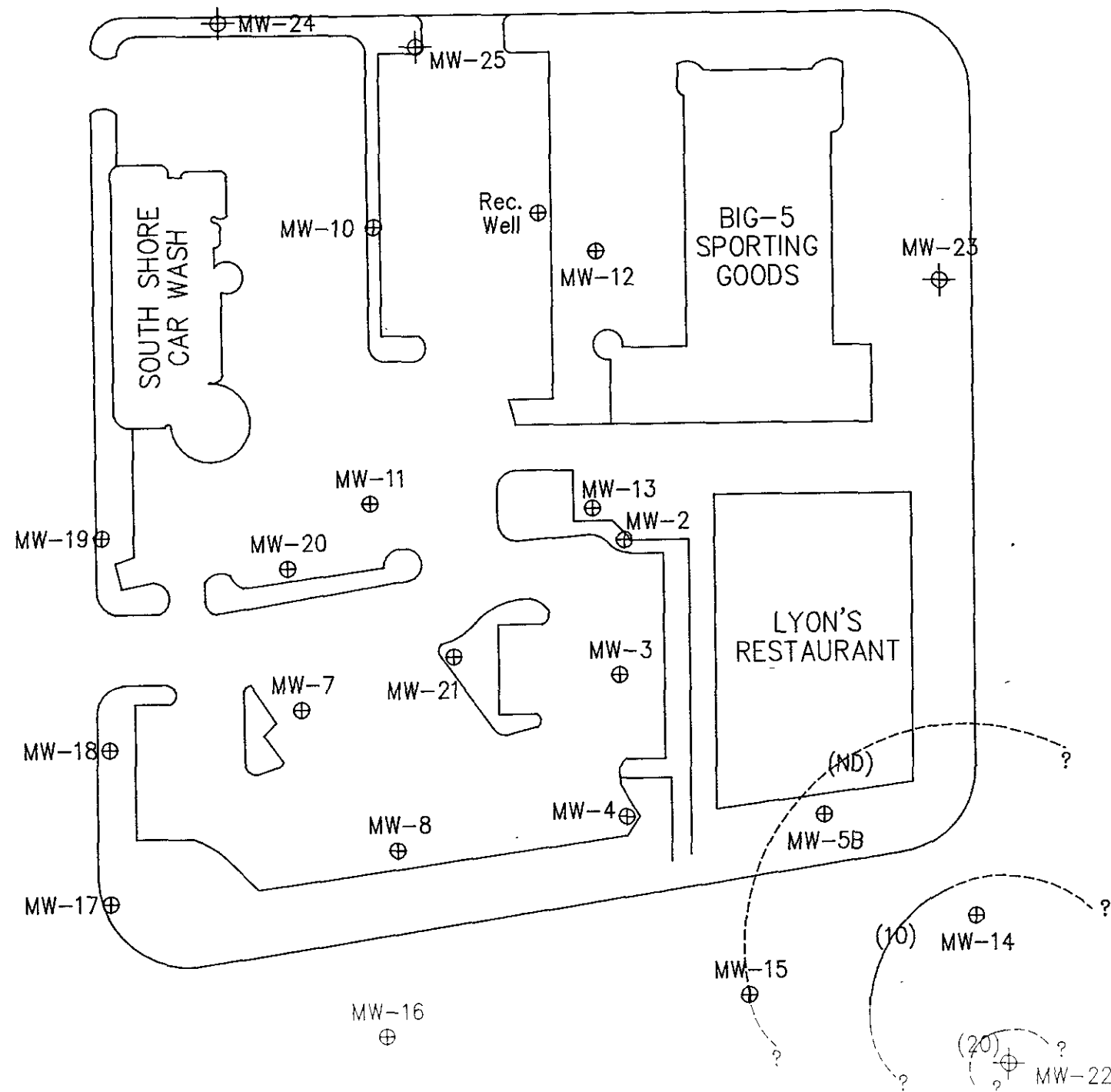

LEGEND	
	Isoconcentration Line (Dashed where inferred)
(200)	Concentration
	Existing Monitoring Wells
	New Monitoring Wells
ND	Not detected at or above detection limit

Isoconcentration Map for 1,2-dichloroethane
 SOUTH SHORE SHOPPING CENTER
 Corner of South Shore Drive and Park Street
 Alameda, California
 Clayton Project No. 45040.08

Figure
 11
 45040-DA-16

Clayton
 ENVIRONMENTAL
 CONSULTANTS

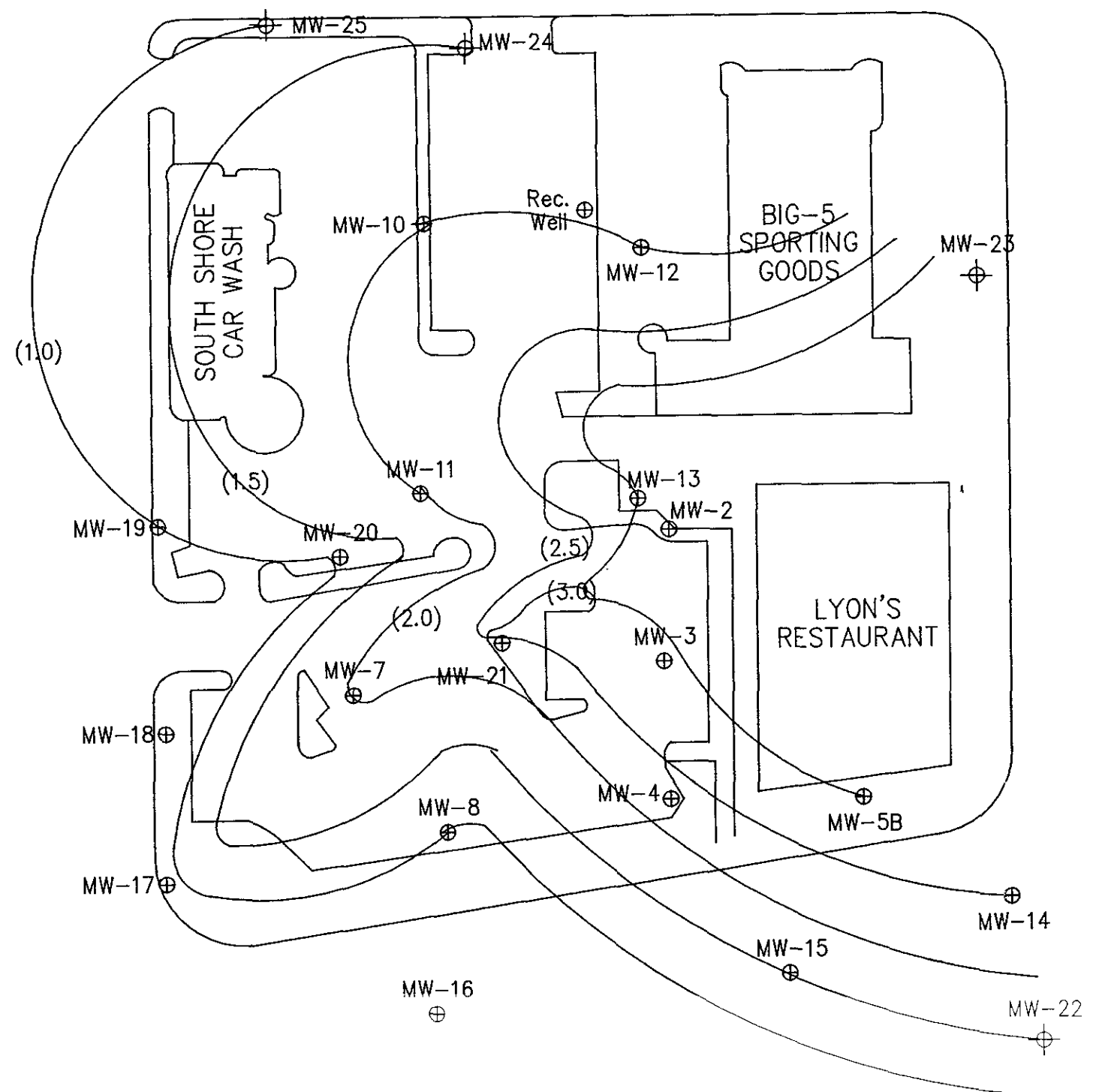

LEGEND	
	Line of Equipotential
(200)	Groundwater Elevation
	Existing Monitoring Wells
	New Monitoring Wells

Groundwater Elevations
 SOUTH SHORE SHOPPING CENTER
 Corner of South Shore Drive and Park Street
 Alameda, California
 Clayton Project No. 45040.08

Figure
 12
 45040-WA-16

Clayton
 ENVIRONMENTAL
 CONSULTANTS

TABLES

Table 1

**Laboratory Analysis for Groundwater Samples
 Collected in February 1993**

Sample LD.	TPH-G	BTEX	TPH-D	Halogenated Hydrocarbons	O&G	TDS
MW-5B	Shaded	Shaded		Shaded		Shaded
MW-7B				Shaded		Shaded
MW-8B				Shaded		Shaded
MW-10	Shaded	Shaded		Shaded		
MW-11				Shaded		Shaded
MW-12	Shaded	Shaded	Shaded	Shaded	Shaded	
MW-14	Shaded			Shaded		Shaded
MW-15	Shaded	Shaded	Shaded	Shaded		Shaded
MW-16	Shaded	Shaded	Shaded	Shaded		Shaded
MW-17				Shaded		Shaded
MW-18				Shaded		Shaded
MW-22	Shaded	Shaded	Shaded	Shaded		Shaded
MW-23	Shaded	Shaded	Shaded	Shaded	Shaded	Shaded
MW-24	Shaded	Shaded		Shaded		
MW-25	Shaded	Shaded		Shaded		

Shaded box represents sample analysis

Table 2

Analytical Summary for Groundwater Samples Collected in February 1993
All Concentrations in Micrograms per Liter ($\mu\text{g/l}$)

Sample I.D.	PCE	TCE	1,2-DCA	1,2-DCE	Benzene	Toluene	Xylenes	Ethylbenzene	Gas	Diesel	Oil & Grease	TDS	DTW	W.E.	C.E.
MW-5B	ND	3.4	0.4	5.0	210	4.2	2.0	1.9	640	2,400	NA	1,400	2.42	+2.66	5.08
MW-7B	5,800	540	ND	150	NA	NA	NA	NA	NA	NA	NA	1,100	3.33	+2.19	5.52
MW-8B	5.0	14	ND	9.0	NA	NA	NA	NA	NA	NA	NA	930	4.92	+1.23	6.15
MW-10	ND	9.5	ND	ND	210	480	1,200	510	66,000	NA	NA	NA	6.04	+2.06	8.10
MW-11	5.8	2.0	ND	ND	NA	NA	NA	NA	NA	NA	NA	630	4.95	+2.26	7.01
MW-12	ND	2.4	ND	ND	620	1,900	6,000	2,200	330,000	NA	3,900	NA	5.92	+2.41	8.33
MW-13	NA	NA	NA	NA	NA	NA	NA	NA	NA	NA	NA	NA	4.75	+2.70	7.45
MW-14	ND	ND	3.4	ND	ND	ND	ND	ND	ND	660	NA	2,000	3.42	+2.35	5.77
MW-15	ND	ND	ND	ND	ND	ND	ND	ND	ND	200	NA	880	3.50	+0.96	4.46
MW-16	ND	ND	ND	ND	ND	ND	ND	ND	ND	ND	NA	24,000	0.42	+3.10	3.52
MW-17	ND	ND	ND	NA	NA	NA	NA	NA	NA	NA	NA	18,000	2.50	+0.82	3.32
MW-18	ND	ND	ND	NA	NA	NA	NA	NA	NA	NA	NA	19,000	4.38	+0.34	4.72
MW-19	ND	ND	ND	NA	NA	NA	NA	NA	NA	NA	NA	NA	4.46	+0.82	5.28
MW-20	ND	ND	ND	NA	NA	NA	NA	NA	NA	NA	NA	NA	5.71	+0.95	6.66
MW-21	ND	ND	ND	NA	NA	NA	NA	NA	NA	NA	NA	NA	NA	NA	6.48
MW-22	ND	ND	22	ND	ND	ND	ND	ND	ND	120	NA	2,100	6.33	NA	NA
MW-23	ND	ND	ND	ND	ND	ND	ND	ND	ND	ND	ND	160	3.42	NA	NA
MW-24	ND	ND	ND	ND	ND	ND	ND	ND	ND	ND	NA	NA	NA	NA	NA
MW-25	ND	11	ND	ND	100	230	500	270	33,000	NA	NA	NA	NA	NA	NA
MCL	5	5	0.5	6.0	1.0	NP	1,750	680	NP	NP	NP	---	---	---	---

- ND Not detected at or above analytical detection limits
- NA Not analyzed
- DTW Depth to water
- W.E. Water elevation

APPENDIX A

BORING LOGS

**LOG OF
EXPLORATORY BORING**

Project No.: 45040.00 Date: February 16, 1993
 Client: Harach
 Location: Corner of Park & Shore Line Drive
 Logged By: D. Dastmalchi Driller: Great Sierra

**BORING M
MW-22**
Sheet 1 of

Field Location of Boring:

 Ground Elevation: Datum:

Drilling Method: Hollow stem
 Hole Diameter: 8"
 Casing Installation Data: 20' screened, 2' PVC casing (0.01), 5' solid, 2' sand, 2' bentonite, 2' concrete

Blow Count	PID GVA (ppm)	D E F T H	S A M P L E	Soil Group Symbol (ASTM)	Litho- graphic Symbol

Water Level					
Time					
Date					

DESCRIPTION					
		1			Sand, little to no silt or clay, yellowish brown (10 YR, 5/6), moist
		2			
	000	3			
		4			
		5			
	000	6		SP	Shell fragments
		7			
		8			
6	000	9			
9		9			
12		9			Wet, free water
		10			
		11			
		12			
		13			
		14			
		15			
		16			
		17			
		18			Fine sand with very little silt, gray (7.5 YR, 5/N5), wet

LOG OF EXPLORATORY BORING						Project No.: 45040.00	Date: February 16, 1993	BORING MW-23	
Field Location of Boring: Ground Elevation: Datum:						Client: Hirsch			Sheet 1 of
						Location: Corner of Park & Shore Line Drive			
						Logged By: D. Dastmalchi Driller: Great Sierra			
						Drilling Method: Hollow stem			
						Hole Diameter: 8"			
						Casing Installation Data: 15' screened, 2" PVC casing (0.01), 4' solid, 16' sand bentonite, 2' concrete			
						Water Level			
						Time			
						Date			
Blow Count	PID DVA (ppm)	D F T H	S A M P L E	Soil Color Symbol (Muns)	Litho Graphic Symbol	DESCRIPTION			
		1				Top soil for plants and landscaping, dark brown to black			
		2							
		3				Sand, little to no silt, yellowish brown (10 YR, 5/6), moist			
		4							
		5							
		6							
		7							
		8							
		9			SP				
		10							
		11				Sand, gray (7.5, YR, 5/NS), shell fragments			
		12							
		13							
		14							
		15							
		16							
		17							
		18							

**LOG OF
EXPLORATORY BORING**

Project No.: 45040.00 Date: February 16, 1993
 Client: Harach
 Location: Corner of Park & Shore Line Drive
 Logged By: D. Destmalchi Driller: Great Sierra

BORING
MW-23
Sheet 1 of

Field Location of Boring:

 Ground Elevation: Datum:

Drilling Method: Hollow stem
 Hole Diameter: 8"
 Casing Installation Data: 15' screened, 2" PVC casing (0.01), 4' solid, 16' sand, bentonite, 2' concrete

Flow Count	PH GVA (ppm)	D E F G H	A M P L E	Soil Group Symbol (USCS)	Litho- graphic Description	Water Level					
						Time					
						Date					
						DESCRIPTION					

		19		SP							
		20									
		21									
		22									
		23									
		24									
		25									
		26									
		27									
		28									
		29									
		30									
		31									
		32									
		33									
		34									
		35									
		36									

Fine sand with little silt, very dark gray (7.5 YR, 3/N3), shell fragments

TD = 20.5'

APPENDIX B

**DRILLING, WELL CONSTRUCTION, AND SAMPLING PROTOCOLS FOR
BOREHOLE/MONITORING WELL INSTALLATION**

DRILLING, WELL CONSTRUCTION, AND SAMPLING PROTOCOLS FOR BOREHOLE/MONITORING WELL INSTALLATION

BOREHOLE INSTALLATION

Clayton Environmental Consultants, Inc. acquires the proper governmental agency permits to bore, drill, or destroy all proposed boreholes and monitoring wells that intersect with groundwater aquifers and writes a health and safety plan.

Clayton subcontracts only with drillers who possess a current C-57 water well contractor's license issued by the State of California and whose personnel have attended the OSHA 40-hour Hazardous Materials Safety Training. Prior to starting work, a "tailgate" safety meeting including discussion of the safety hazards and precautions relevant to the particular job will be held with all personnel working on the job. Well drillers are identified on permit applications.

Borings are drilled dry by hollow- or solid-stem, continuous flight augers. Augers, drill rods, and other working components of the drilling rig are steam-cleaned before arriving onsite to prevent the introduction of contaminants. These components are also steam-cleaned between borings away from boring locations. Cleaned augers, rods, and other components are stored, and/or covered when not in use.

Our bore logs include a detailed description of subsurface stratigraphy. Clayton examines the soil brought to the surface by drilling operations, and samples undisturbed soil every 5 feet or as otherwise specified. Soil cuttings are screened for hydrocarbon contamination using a photoionization detector. Boring logs are filled out in the field by a professional geologist, civil engineer, engineering geologist who is registered by the State of California, or a technician who is trained and working under the supervision of one of the previously mentioned persons, using the Unified Soil Classification System.

SOIL SAMPLING

Soil samples are taken every 5 feet, at areas of obvious contamination, or as otherwise specified, with a California modified split-spoon sampler that is lined with three six-inch brass tubes. The sampler and rod are inserted into the borehole to the current depth and a hammer of known weight and height above the sampler are allowed to free-fall onto the rod, advancing the assembly 18 inches into undisturbed soil. Clayton uses the number of blows necessary to drive the sampler into the ground to help evaluate the consistency of materials encountered. The sampler is then pulled from the borehole and disassembled, and the three brass tubes are separated for inspection and labeling.

Clayton uses new brass liners or liners cleaned with a trisodium phosphate (TSP) solution, double rinsed with clean tap water, and air dried prior to each sampling. The sampler is also cleaned with TSP and rinsed with tap water between sampling events.

Soil samples selected for laboratory analysis are left in the brass liners, sealed with aluminum foil and plastic caps, taped for air tightness, labeled, and immediately placed into a pre-cooled ice chest chilled to less than 4°C. Labels contain the following information: site name, date and time sampled, borehole number and depth, and the sampler's initials. The samples are transported under chain-of-custody to a state-certified laboratory. The laboratory analyzes soil samples within the prescribed holding time, storing them at temperatures below 4°C at all times.

Pending results of laboratory analysis, excess drilling and sampling cuttings are placed into Department of Transportation (DOT)-approved drums, labeled with the name of the site, address, and well number, and left at the site. Uncontaminated soil may be disposed of by the client. Soil found to contain levels of contaminants above local or state action levels will require that the client dispose of it in accordance with hazardous waste regulations. At the client's request, we will assist with the disposal of contaminated soil.

WELL CONSTRUCTION

Boreholes are converted to monitoring wells by placing 2-inch or 4-inch diameter well casing with flush-threaded joints and slotted screen into the borehole. Construction materials include polyvinyl chloride (PVC), stainless steel, or low carbon steel. The most suitable material for a particular installation will depend on the parameters to be monitored. All screens and casings used are in a contaminant-free

condition when placed in the ground. No thread lubrication is used, other than teflon tape, for connecting the casing segments.

Wells extend at least 10 feet into the upper saturated zone, but do not extend through any clay layers greater than 5 feet that are below the shallow water table. The standard practice for wells installed at hydrocarbon contamination sites is to construct a well with a 20-foot long perforated interval extending 15 feet below and 5 feet above the water table in an unconfined aquifer. The top of the well is solid casing. The annular space of the borehole is backfilled with washed, kiln-dried sand to a point at least 1 foot above the slotted screen. A seal above the filter pack is formed by placing a 1- to 2-foot layer of bentonite pellets on top of the sand. The bentonite pellets are moistened by pouring clean tap water down the hole so that they can expand and seal the annulus. A neat cement grout is placed above the bentonite seal and brought to the ground surface.

Well casings are protected from surface contamination, accidental damage, and unauthorized entry or tampering with water-tight locking caps on the well casings. The caps are usually surrounded by a concrete vault. Wells are clearly identified with a metal tag or other device where the following information is recorded: well number, depth to water, depth of well, casing data including location of screened interval.

WELL DEVELOPMENT

The well seal in newly developed wells must set up for 48 to 72 hours prior to development. Since development of the well can volatilize contaminants present, the well must also settle for at least 48 to 72 hours between development and the first purging/sampling incident.

All monitoring wells are initially developed to clean the well and stabilize sand, gravel, and disturbed aquifer materials around the screened internal perforations. Wells are developed by pumping (or bailing) and surging until water turbidity and specific conductance stabilize. In some cases, where wells are installed in low permeability formations and the wells purge dry, the well is allowed to recover and is purged dry three times. Clean tap water is introduced into the well if it does not recover rapidly enough.

Pending results by laboratory analysis, purge water from well development and sampling is placed into DOT-approved drums, labeled with the name of the site, address, well number, and left at the site. Uncontaminated water may be disposed of by the client. Water found to contain levels of contaminants above local or state action levels requires that the client dispose of it in accordance with hazardous waste requirements. At the client's request, we can assist with the disposal of contaminated purge water.

GROUNDWATER SAMPLING

To collect a representative sample of the groundwater, stagnant water within the well casing and filter material must be purged and fresh aquifer water allowed to replace it. The water is purged from the well by pumping or bailing at least three well volumes. Well volumes are calculated by measuring depth to groundwater to the nearest 0.01 foot upon arrival at the well before any purging has begun. Groundwater samples are collected only after purging has been of sufficient duration for pH, temperature, and electrical conductivity to stabilize. When purging low-yield wells, the wells are purged to dryness. When the well recovers to 80% of the depth measured upon arrival, samples are collected.

Field sampling logs maintained for each well include:

- Monitoring well identification
- Static water level, before and after pumping
- Well depth
- Condition of water prior to purging (e.g., amount of free product)
- Purge rate and volume
- pH, temperature, and conductivity during purging
- Time purged
- Time of sample collection
- Sampling method
- Name of sampler
- Climatic conditions

Water samples are collected using clean teflon bailers. All equipment that contacts samples is thoroughly cleaned before arrival at the site and between sampling events.

Water is collected in clean laboratory-supplied containers, labeled, placed immediately into an ice chest pre-cooled to 4°C, and transported to Clayton's laboratory for analysis. One trip blank will be furnished in accordance with our quality assurance/quality control (QA/QC) program.

All samples are collected in such a manner so as to minimize the volatilization of a sample due to agitation and/or transfer from bailer to sample container. Samples are collected so that contaminants most sensitive to volatilization are sampled first.

Preservatives are not added to any sample, unless instructed. If requested, they are supplied by Clayton's laboratory.

All sample containers are labeled in the field. Labels contain the following information: project name, sample identification number, project number, date and time of collection, and sampler's initials.

Under no circumstances are sealed sample containers opened by anyone other than the laboratory personnel who perform the requested analyses. If it is necessary for samples or sample chests to leave the immediate control of the sampler prior to delivery to the laboratory, for example during shipment by Federal Express, a custody seal is placed on each sample container and/or sample chest to ensure that the samples have not been tampered with during transportation. The custody seal is signed by the sampler, and the date and time that the seal was placed is recorded. The elapsed time between sample collection and delivery to the laboratory never exceeds 48 hours. Water samples are not held for more than 14 days prior to analysis and are kept at 4°C at all times.

To document and trace samples from time of collection, a signed chain-of-custody record is filled out by the sampler and accompanies the samples through the laboratory analyses. The completed chain-of-custody is included with the analytical report from the laboratory.

REFERENCES

Groundwater Monitoring Guidelines, Revised February 1990. Alameda County District Groundwater Protection Program.

Leaking Underground Fuel Tank (LUFT) Field Manual: Guidelines for Site Assessment, Cleanup, and Underground Tank Closure, May 1988. State of California LUFT Task Force.

Regional Board Staff Recommendations for Initial Evaluation and Investigation of Underground Tanks, Revised November 1989. North Coast, San Francisco Bay, and Central Valley regions of the California State Water Quality Control Board.

Standards for the Construction and Destruction of Wells and Other Deep Excavations in Santa Clara County, Revised June 1989. Santa Clara Valley Water District.

APPENDIX C

KAMUR INDUSTRIES REPORT

File No. 8-90-418-SI

**INSTALLATION OF TWO ADDITIONAL MONITORING
WELLS FOR SOUTHSORE CAR WASH PROPERTY
LOCATED AT 2351 SHORELINE DRIVE
ALAMEDA, CALIFORNIA
MARCH 15, 1993**

**PREPARED FOR:
KAMUR INDUSTRIES, INC.
2351 SHORELINE DRIVE
ALAMEDA, CALIFORNIA 94501**

**BY:
SOIL TECH ENGINEERING, INC.
298 BROKAW ROAD
SANTA CLARA, CALIFORNIA 95050**

SOIL TECH ENGINEERING, INC.

LIST OF TABLES

- TABLE 1 ... WATER ELEVATION AND MONITORING WELLS OBSERVATION DATA.
- TABLE 2 ... SOIL ANALYTICAL RESULTS.
- TABLE 3 ... GROUNDWATER ANALYTICAL RESULTS.

LIST OF FIGURES

- FIGURE 1 ... SITE VICINITY MAP SHOWING 2351 SHORELINE DRIVE, ALAMEDA, CALIFORNIA.
- FIGURE 2 ... SITE PLAN SHOWING LOCATIONS OF MONITORING WELLS AND GROUNDWATER FLOW DIRECTION.

LIST OF APPENDICES

- APPENDIX "A" ... TABLE 1, TABLE 2 AND TABLE 3.
- APPENDIX "B" ... SITE VICINITY MAP AND SITE PLAN.
- APPENDIX "C" ... STE'S STANDARD OPERATION PROCEDURES.
- APPENDIX "D" ... BORING LOGS AND PIEZOMETER SCHEMATIC.
- APPENDIX "E" ... PRIORITY ENVIRONMENTAL LABS ANALYTICAL REPORT OF SOIL SAMPLES AND WATER SAMPLES.
- APPENDIX "F" ... ALAMEDA COUNTY FLOOD CONTROL AND WATER CONVERSATION DISTRICT--ZONE 7 WELL INSTALLATION PERMIT AND WELL COMPLETION REPORT.

TABLE OF CONTENTS

Page No.

LETTER OF TRANSMITTAL	1
PURPOSE	1
SCOPE OF WORK	2
FIELD ACTIVITIES	2-3
ANALYTICAL RESULTS	
SOIL	3-4
WATER	4
SUMMARY	4-5
RECOMMENDATION	5
LIMITATIONS AND UNIFORMITY OF CONDITIONS	5-6
 <u>APPENDIX "A"</u>	
TABLE 1 - WATER ELEVATION AND MONITORING WELLS OBSERVATION DATA	T1
TABLE 2 - SOIL ANALYTICAL RESULTS	T2
TABLE 3 - GROUNDWATER ANALYTICAL RESULTS	T3
 <u>APPENDIX "B"</u>	
FIGURE 1 - VICINITY MAP	M1
FIGURE 2 - SITE PLAN	M2

File No. 8-90-418-SI

TABLE OF CONTENTS

Page No.

APPENDIX "C"

DRILLING AND SOIL SAMPLING PROCEDURE	SOP1-SOP2
MONITORING WELL INSTALLATION	SOP3-SOP4
WELL DEVELOPMENT	SOP5
GROUNDWATER SAMPLING	SOP6

APPENDIX "D"

BORING LOGS	B1-B2
PIEZOMETER SCHEMATIC	B3-B4

APPENDIX "E"

PRIORITY ENVIRONMENTAL LABS REPORT ON SOIL SAMPLES AND CHAIN-OF-CUSTODY DOCUMENT	
PRIORITY ENVIRONMENTAL LABS REPORT ON WATER SAMPLES AND CHAIN-OF-CUSTODY DOCUMENT	

APPENDIX "F"

ACFCWCD--ZONE 7 WELL INSTALLATION PERMIT WELL COMPLETION REPORT	
--	--

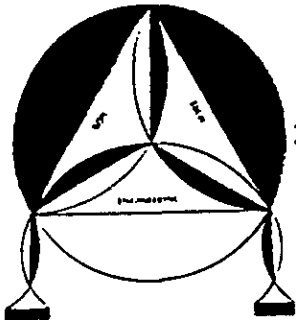

SOIL TECH ENGINEERING

Soil, Foundation and Geological Engineers

298 BROKAW ROAD, SANTA CLARA, CA 95050 ■ (408) 496-0265 OR (408) 496-0266

March 15, 1993

File No. 8-90-418-SI

Kamur Industries, Inc.
2351 Shoreline Drive
Alameda, California 94501

ATTENTION: MR. MURRAY STEVENS

SUBJECT: INSTALLATION OF TWO ADDITIONAL MONITORING
WELLS FOR SOUTHSORE CAR WASH PROPERTY
Located at 2351 Shoreline Drive, in
Alameda, California

Dear Mr. Stevens:

This report summarizes the additional work conducted by Soil Tech Engineering, Inc. (STE), at 2351 Shoreline Drive in the City of Alameda, California (Figure 1). Additional monitoring wells were installed at the subject site as required by the Alameda County Health Care Services Agency--Hazardous Material Division.

PURPOSE:

Alameda County Health Care Services Agency requested installation of the two additional monitoring wells, in order to define the extent of contaminants in the vicinity of former underground storage tanks.

SCOPE OF WORK:

- Install two additional monitoring wells at the property.
- Soil sampling.
- Well development.
- Water sampling of the newly installed wells and the existing on-site wells STMW-1 and STMW-3.
- Analyze soil and the water samples.
- Review the analytical results and prepare a technical report.

FIELD ACTIVITIES:

Prior to installation of the two additional monitoring wells, STE obtained the necessary permits from the Alameda County Flood Control District Zone 7. A copy of the permit is attached (Appendix "F").

On February 2, 1993, two additional wells STMW-5 and STMW-6 were installed. The locations are shown in Figure 2. All drilling, soil sampling, well installation and development were conducted in accordance with the existing local and state regulations and STE's Standard Operation Procedures (SOP) (Appendix "C").

The soil encountered during the drilling consist of mainly silty sandy materials with some gravel. The shallow groundwater encountered during drilling was approximately eight to nine feet below grade. The borings were terminated at approximately fifteen feet below grade. The logs of the boring and the wells construction details are attached in Appendix "D".

One soil sample was taken from each well boring at approximately 5 feet below grade. The soil samples were logged and visually classified according to American Society of Testing Materials. Soil samples were retained in the brass tubes covered both ends with aluminum foil, capped with plastic lids, sealed with adhesive tape, labeled and placed on dry ice, until delivered to Priority Environmental Labs in Milpitas, California. Proper chain-of-custody procedures were used for the soil sampling. All soil cuttings were placed in plastic pending chemical analytical results. The new wells were developed by a clean Teflon bailer on February 7, 1993.

On February 8, 1993, STE's staff conducted the water sampling of the newly installed wells STMW-5 and STMW-6 and existing wells STMW-1 and STMW-3.

ANALYTICAL RESULTS:

SOIL:

The two soil samples were analyzed for Total Petroleum Hydrocarbons as gasoline (TPHg), Benzene, Toluene, Ethylbenzene, Total

Xylenes (BTEX), and Volatile Organic Compounds (VOC's) per EPA Metals 5030, 8015, 8020 and 8010.

WATER:

The four water samples were analyzed for TPHg, BTEX, and VOC's per EPA Method 5030/602 and 601. In addition, STMW-3 was analyzed for TPHd and Total Oil and Grease (TOG).

The analytical results are summarized in Table 3. No TPHg, BTEX or VOC's were detected in the two soil samples. The two existing on-site wells continued to show elevated concentrations of TPHg, low to moderate levels of BTEX and a very low level of Trichloroethene. No TPHg, BTEX or VOC's were detected in newly installed well STMW-5. Well STMW-6 did detect elevated levels of TPH as gasoline, low levels of BTEX and one Volatile Organic Compound Trichloroethene at 0.011 milligrams per liter (mg/L).

A copy of the laboratory analyses and the appropriate chain-of-custody are attached in Appendix "E".

SUMMARY:

- Soil encountered on the newly installed wells consist of mainly silty sand materials. The groundwater beneath the site during sampling ranged from 5.1 feet to 7.17 feet below the grade.

- Petroleum odors and light petroleum sheen were detected in wells STMW-1 and STMW-3 only.
- Dissolved petroleum hydrocarbons and one VOC's were detected in the newly installed well STE-6. The existing well STMW-1 and STMW-3 continued to detect low to moderate levels of TPHg, BTEX, and one Volatile Organic Compounds.

RECOMMENDATION:

This report should be sent to the Alameda County Health Care Services Agency--Hazardous Material Division. The quarterly monitoring and sampling of all on-site wells should be continued as requested by the County.

LIMITATIONS AND UNIFORMITY OF CONDITIONS:

The monitoring well installation services or soil and water sampling for pollution on this project was a direct request by Soil Tech Engineering, Inc.'s client. These installations were performed to meet the existing requirements for near-surface groundwater monitoring.

This service does not make Soil Tech Engineering, Inc., liable for future maintenance, repairs, damages, injury to a third party or any other elements causing future problems.

The locations of these monitoring wells are approximate and should not be used for any reference point, surveying, or any other uses except studying groundwater.

Any recommendations that were made in this report are based upon the assumption that the soil conditions do not deviate from those disclosed in the borings.

This report is issued with the understanding that it is the responsibility of the owner or his representative to ensure that the information and recommendations contained herein are called to the attention of the Local Environmental Agency.

The findings of this report are based on the results of an independent laboratory and are valid as of the present date. However, changes in the conditions of a property can occur with the passage of time, whether they are due to natural processes or the works of man, on this property or adjacent properties.

If you have any questions or require additional information, please feel free to contact our office at your convenience.

Sincerely,

SOIL TECH ENGINEERING, INC.

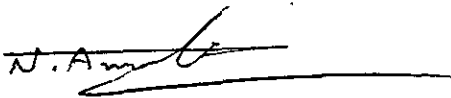

NOORODDIN AMELI
PROJECT ENGINEER



LAWRENCE KOO, P. E.
C. E. #22906



FRANK HAMEDI-FARD
GENERAL MANAGER

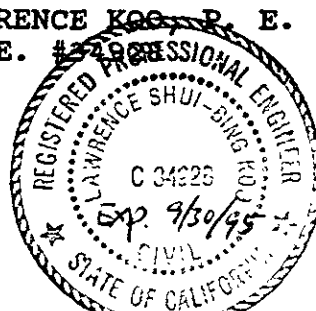

SOIL TECH ENGINEERING, INC.

File No. 8-90-418-SI

A P P E N D I X "A"

SOIL TECH ENGINEERING, INC.

**TABLE 1
WATER ELEVATION AND MONITORING WELLS
OBSERVATION DATA**

Date	Well No./ Elevation	Depth-to- Water	Groundwater Elevation	FFP Thickness	Odor
2/08/93	STMW-1 (8.10)	6.23	1.87	Rainbow Sheen	Strong Petroleum
	STMW-2 (7.01)	4.90	2.11	None	None
	STMW-3 (8.33)	5.96	2.37	Brown Non- Measurable	Strong Petroleum
	STMW-4 (7.45)	4.93	2.52	None	None
	STMW-5	8.67	NA	None	None
	STMW-6	7.88	NA	None	Light Sewage

NA - Not Available

TABLE 2
SOIL ANALYTICAL RESULTS
IN
MILLIGRAMS PER KILOGRAM (mg/Kg)

Date	Well No.	TPHg	B	T	E	X	VOC'S
2/02/93	STMW-5-5	ND	ND	ND	ND	ND	ND
	STMW-6-5	ND	ND	ND	ND	ND	ND

VOC'S - Volatile Organic Compounds
TPHg - Total Petroleum Hydrocarbons as gasoline
BTEX - Benzene, Toluene, Ethylbenzene, Total Xylenes
ND - Not Detected (Below Laboratory Detection Limit)

**TABLE 3
GROUNDWATER ANALYTICAL RESULTS
IN
MILLIGRAMS PER LITER (mg/L)**

A. TPHd, TPHg, BTEX and TOG Results

Date	Well No.	TPHd	TPHg	B	T	E	X	TOG
2/08/93	STMW-1	NA	66	0.21	0.48	0.51	1.2	NA
	STMW-3	ND	330	0.62	1.9	2.2	6.0	3.9
	STMW-5	NA	ND	ND	ND	ND	ND	NA
	STMW-6	NA	33	0.1	0.23	0.27	0.5	NA

B. Volatile Organic Compounds Per EPA Method 601 Results

Date	Well No.	VOC's Detected	Concentration	Detection Limit
2/08/93	STMW-1	Trichloroethene	0.0095	0.0005
	STMW-3	Trichloroethene	0.0024	0.0005
	STMW-5	None Detected	None	0.0005
	STMW-6	Trichloroethene	0.011	0.0005

VOC's - Volatile Organic Compounds
 TPHd - Total Petroleum Hydrocarbons as diesel
 TPHg - Total Petroleum Hydrocarbons as gasoline
 BTEX - Benzene, Toluene, Ethylbenzene, Total Xylenes
 TOG - Total Oil and Grease
 NA - Not Analyzed
 ND - Not Detected (Below Laboratory Detection Limit)

File No. 8-90-418-SI

A P P E N D I X "B"

SOIL TECH ENGINEERING, INC.

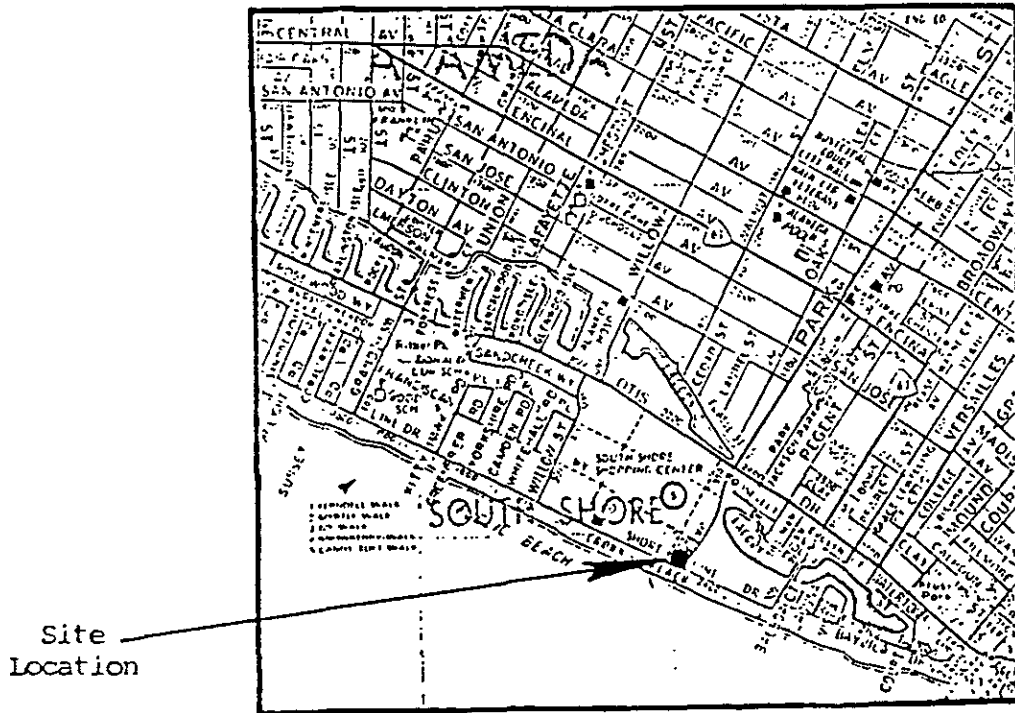

Thomas Brothers Map 1982 Edition
Alameda - Contra Costa Counties

SHORELINE DRIVE

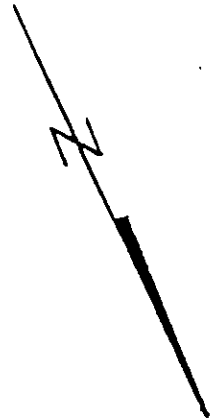

Approximate Direction
of Groundwater Flow
as of 2/08/93

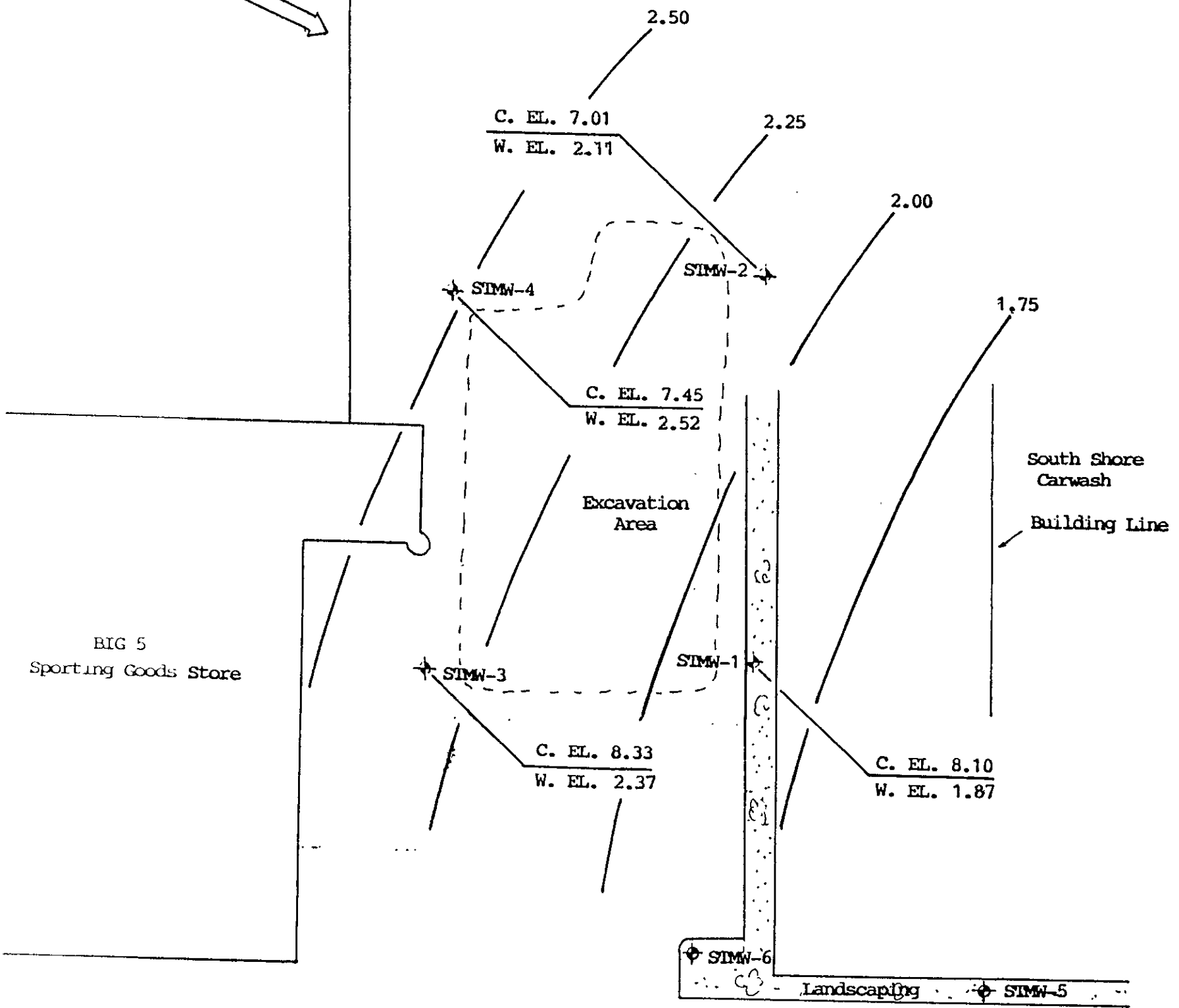

NOTE: New well elevations are tied with the off-site well elevations.

2351 SHORELINE DRIVE, ALAMEDA, CALIFORNIA

SCALE: 1"=30'

PROJECT NO. 8-90-418-SI

FIGURE - 2

DRAWN BY N.A.

2/08/93

SOIL TECH ENGINEERING, INC.
298 BROKAW ROAD, SANTA CLARA, CALIFORNIA 95050

File No. 8-90-418-SI

A P P E N D I X "C"

SOIL TECH ENGINEERING, INC.

DRILLING AND SOIL SAMPLING PROCEDURE

A truck-mounted drill rig, using a continuous, solid-flight, hollow stem auger was used in drilling the soil borings to the desired depths.

Prior to drilling, all drilling equipment (auger, pin, drilling head) were thoroughly steam-cleaned to minimize the possibility of cross-contamination and/or vertical migration of possible contaminants.

In addition, prior to obtaining each individual soil sample, all sampling tools, including the split-spoon sampler and brass liners were thoroughly washed in a Trisodium Phosphate (TSP) solution followed by a rinse in distilled water.

During the drilling operation, relatively undisturbed soil samples were taken from the required depth by forcing a 2-inch I.D. split-spoon sampler insert with a brass liner into the ground at various depths by means of a 140-lb. hammer falling 30-inches or by hydraulic forces.

The samplers were contained relatively undisturbed soil. In general, the first section of soil from the sampler (shoe) was used in the field for lithologic inspection and evidence of contamination. The selected brass liner was immediately trimmed, the ends of the brass liner were covered tightly with aluminum foil and

plastic caps, sealed with tape, labelled, placed in a plastic bag and stored in a cold ice chest in order to minimize the escape of any volatiles present in the samples. Soil samples for analysis were then sent to a state-certified hazardous waste laboratory accompanied by a chain-of-custody record.

Soil samples collected at each sampling interval were inspected for possible contamination (odor or peculiar colors). Soil vapor concentrations was measured in the field by using a Photoionization Detector (PID), PhotoVac Tip Air Analyzer. The soil sample was sealed in a Zip-Loc plastic bag and placed in the sun to enhance volatilization of the hydrocarbons from the sample. The purpose of this field analysis is to qualitatively determine the presence or absence of hydrocarbons and to establish which soil samples will be analyzed at the laboratory. The data was recorded on the drilling log at the depth corresponding to the sampling point.

Other soil samples may be collected to document the stratigraphy and estimate relative permeability of the subsurface materials.

Soil tailings that are obtained during drilling are stored at the site, pending the analytical test results to determine proper disposal.

MONITORING WELL INSTALLATION

The boreholes for the monitoring wells were hand augered with a diameter of at least two inches larger than the casing outside diameter (O.D.).

The monitoring wells were cased with threaded, factory-perforated and blank, schedule 40 P.V.C. The perforated interval consisted of slotted casing, generally 0.010 to 0.040 inch wide by 1.5 inch long slot size, with 42 slots per foot (slots which match formation grain size as determined by field grain-size distribution analysis). A P.V.C. cap was fastened to the bottom of the casing (no solvents, adhesive, or cements were used), the well casing was thoroughly washed and steam-cleaned.

After setting the casing inside the borehole, kiln-dried sand or gravel-filter material was poured into the annular space to fill from the bottom of the boring to two feet above the perforated interval. A one to two feet thick bentonite plug was placed above this filter material to prevent grout from infiltrating down into the filter material. Approximately one to two gallons of distilled water were added to hydrate the bentonite pellets. Then the well was sealed from the top of the bentonite seal to the surface with concrete or neat cement containing about 5% bentonite (see Well Construction Detail).

To protect the well from vandalism and surface water contamination, Christy boxes with a special type of Allen screw were installed around the well head, (for wells in parking lots, drive-ways and building areas). Steel stove pipes with padlocks were usually set over well-heads in landscaped areas.

In general, groundwater monitoring wells extend to the base of the upper aquifer, as defined by the consistent (less than 5 feet thick) clay layer below the upper aquifer, or at least 10 to 15 feet below the top of the upper aquifer, whichever is shallower. The wells do not extend through the laterally extensive clay layer below the upper aquifer. The wells are terminated one to two feet into such a clay layer.

WELL DEVELOPMENT

For all newly installed groundwater monitoring wells, the well casing, filter pack and adjacent formations were cleared of disturbed sediment and water.

Well development techniques included pumping, bailing, surging, swabbing, jetting, flushing or air lifting by using a stainless steel or Teflon bailer, a submersible stainless steel pump, or air lift pump. The well development continued until the discharged water appeared to be relatively free of all turbidity.

All water and sediment generated by well development were collected in 55-gallon steel drums (Department of Transportation approved), closed-head (17-H) for temporarily storage, and were then disposed of properly, depending on analytical results.

To assure that cross-contamination did not occur between wells, all well development tools were steam-cleaned or thoroughly washed in a Trisodium Phosphate (TSP) solution followed by a rinse in distilled water before each well development.

GROUNDWATER SAMPLING

Prior to collection of groundwater samples, all of the sampling equipment (i.e. bailer, cables, bladder pump, discharge lines and etc...) were cleaned by pumping TSP water solution followed by distilled water.

Prior to purging, the well "Water Sampling Field Survey Forms" was filled out (depth to water and total depth of water column were measured and recorded). The well was then bailed or pumped to remove four to ten well volumes or until the discharged water temperature, conductivity and pH stabilized. "Stabilized" is defined as three consecutive readings within 15% of one another.

The groundwater sample was collected when the water level in the well recovered to 80% of its static level.

Forty milliliter (ml.), glass volatile organic analysis (VOA) vials with Teflon septa were used as sample containers. The groundwater sample was decanted into each VOA vial in such a manner that there was a meniscus at the top. The cap was quickly placed over the top of the vial and securely tightened. The VOA vial was then inverted and tapped to see if air bubbles were present. If none were present, the sample was labeled and refrigerated for delivery under chain-of-custody to the laboratory. The label information would include a sample identification number, job identification number, date, time, type of analysis requested, and the sampler's name.

File No. 8-90-418-SI

A P P E N D I X "D"

SOIL TECH ENGINEERING, INC.

Logged By: Noori Ameli		Exploratory Boring Log		Boring No: SIMW-5	
Date Drilled: 2/02/93		Approx. Elevation		Boring Diameter: 8-inch	
Drilling Method Mobile drill rig B-40L			Sampling Method		
Depth, Ft.	Sample No.	Field Test for Total Ionization	Penetration Resistance Blows/Ft.	Unified Soil Classification	DESCRIPTION
1				SW	Very dark greyish-brown silty gravelly sandy clay, damp, stiff. Munsell Color: HUE 2.5Y 3/2
2					Color changes to dark olive-grey silty fine sand with some gravel, damp.
3					Munsell Color: HUE 5Y 3/2
4					
5	SIMW-5-5			SM	Dark olive-grey fine sand, damp. Munsell Color: HUE 5Y 3/2
6					
7					
8					
9					▽ First groundwater encountered at 9 feet.
10				SP	Color gets lighter to olive-grey fine sand, moist. Munsell Color: HUE 5Y 4/2
11					
12					
13					
14					
15				CL	Dark greyish-brown silty clay at bottom of auger, wet, stiff. Munsell Color: HUE 2.5Y 4/2
16					Boring terminated at 15 feet.

Remarks

Logged By Noori Ameli	Exploratory Boring Log	Boring No STMW-6
Date Drilled. 2/02/93	Approx. Elevation	Boring Diameter 8-inch

Drilling Method Mobile drill rig B-40L	Sampling Method
--	-----------------

Depth, Ft.	Sample No.	Field Test for Total Ionization	Penetration Resistance Blows/Ft.	Unified Soil Classification	DESCRIPTION
1				SM	Olive fine sand, damp. Munsell Color: HUE 5Y 4/3
2					
3					
4					Color gets darker to dark olive-grey fine sand, damp. Munsell Color: HUE 5Y 3/2
5	STMW-6-5			SM	Dark olive-grey fine sand, damp. Munsell Color: HUE 5Y 3/2
6					
7					
8					▽ First groundwater encountered at 8 feet. Color gets lighter to olive-grey fine sand, damp, moist, very light petroleum odor.
9					
10					
11					
12					
13					
14					
15				CL	Olive silty clay at bottom of the auger, wet, stiff. Munsell Color: HUE 5Y 4/3 Boring terminated at 15 feet.
16					

Remarks

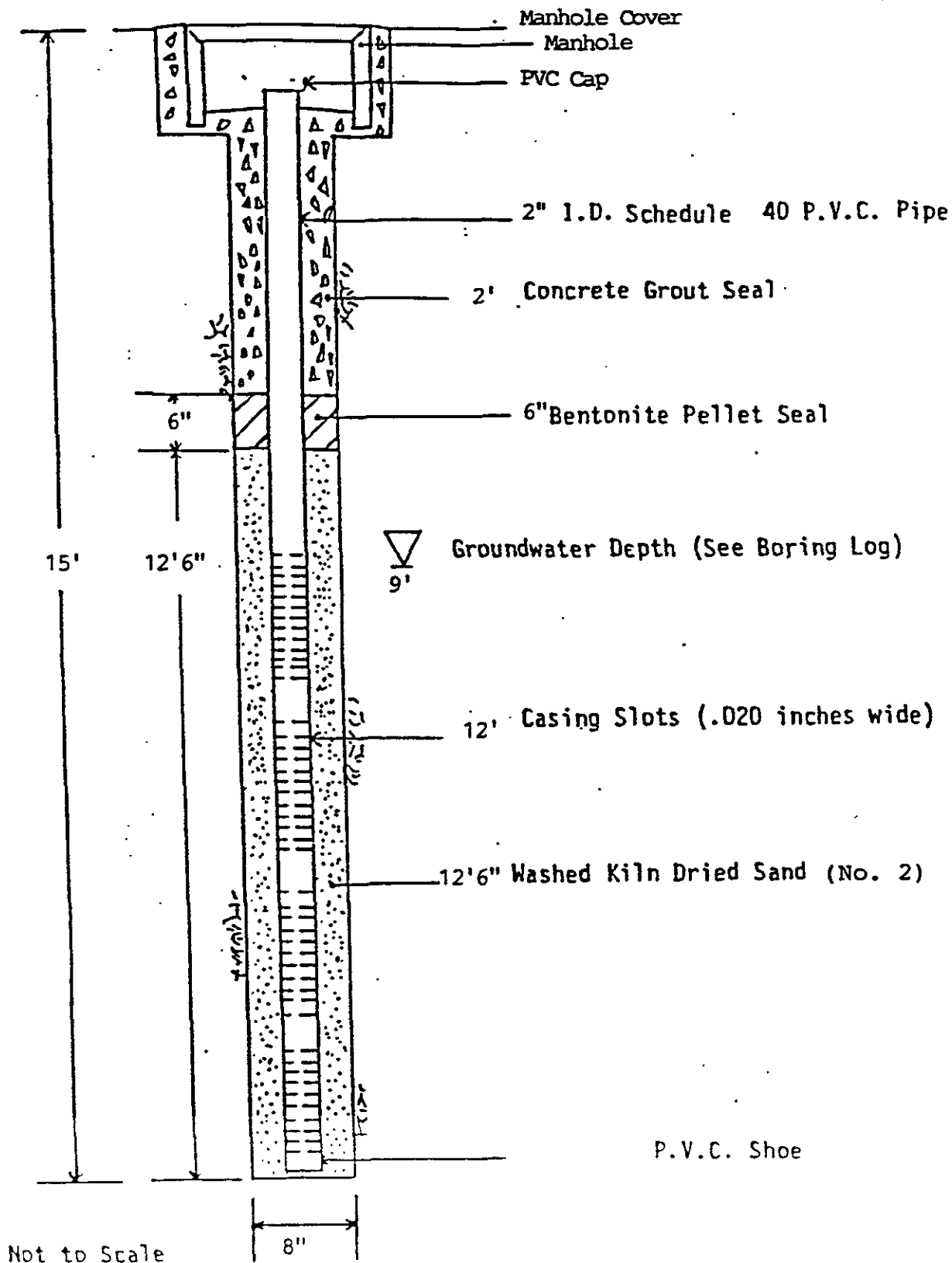

STM-5

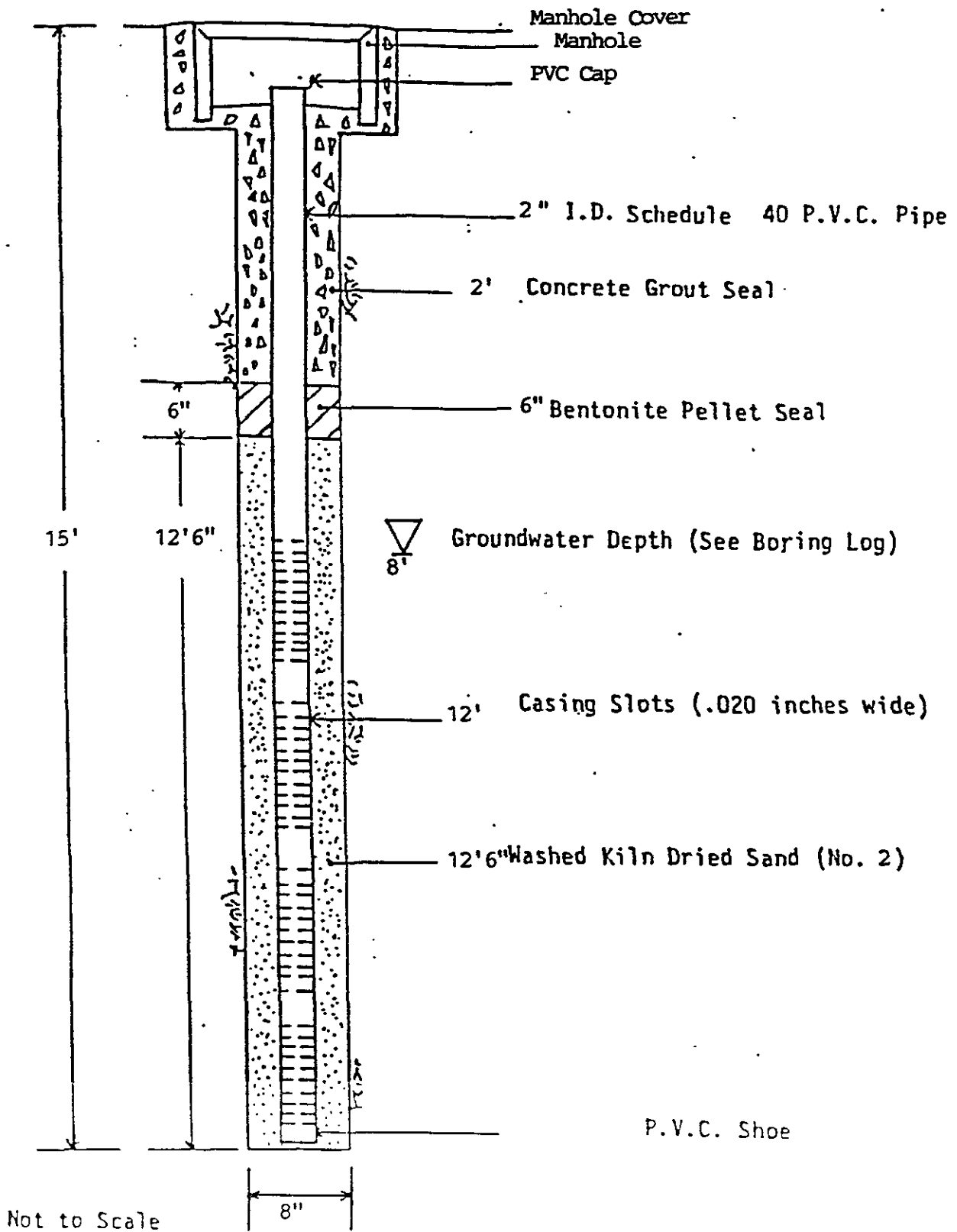

SIMW-6

File No. 8-90-418-SI

A P P E N D I X "E"

SOIL TECH ENGINEERING, INC.



PRIORITY ENVIRONMENTAL LABS

Environmental Analytical Laboratory

February 04, 1993

PEL # 9302002

SOIL TECH ENGINEERING

Attn: Noori Ameli

Re: Two soil samples for Gasoline/BTEX analysis.

Project name: 2351 Shoreline Dr., - Alameda

Project number: 8-90-418-SI

Date sampled: Feb 02, 1993

Date extracted: Feb 03, 1993

Date submitted: Feb 03, 1993

Date analyzed: Feb 03, 1993

RESULTS:

SAMPLE I.D.	Gasoline (mg/Kg)	Benzene (ug/Kg)	Toluene (ug/Kg)	Ethyl Benzene (ug/Kg)	Total Xylenes (ug/Kg)
STMW-5-5	N.D.	N.D.	N.D.	N.D.	N.D.
STMW-6-5	N.D.	N.D.	N.D.	N.D.	N.D.
Blank	N.D.	N.D.	N.D.	N.D.	N.D.
Spiked Recovery	101.8%	98.3%	103.2%	94.6%	105.7%
Detection limit	1.0	5.0	5.0	5.0	5.0
Method of Analysis	5030 / 8015	8020	8020	8020	8020

David Duong
Laboratory Director



PRIORITY ENVIRONMENTAL LABS

Environmental Analysis Laboratory

February 04, 1993

PEL # 9302002

SOIL TECH ENGINEERING

Attn: Noori Ameli

Project name: 2351 Shoreline Dr.-Alameda

Project number: 8-90-418-9

Sample I.D.: STMW-5-5

Date Sampled: Feb 02, 1993
Date Analyzed: Feb 03-04, 1993

Date Submitted: Feb 03, 1993

Method of Analysis: EPA 8010

Detection limit: 5.0 ug/Kg

COMPOUND NAME	CONCENTRATION (ug/Kg)	SPIKE RECOVERY (%)
Chloromethane	N.D.	-----
Vinyl Chloride	N.D.	86.4
Bromomethane	N.D.	-----
Chloroethane	N.D.	-----
Trichlorofluoromethane	N.D.	-----
1,1-Dichloroethene	N.D.	-----
Methylene Chloride	N.D.	92.1
1,2-Dichloroethene (TOTAL)	N.D.	-----
1,1-Dichloroethane	N.D.	-----
Chloroform	N.D.	90.3
1,1,1-Trichloroethane	N.D.	-----
Carbon Tetrachloride	N.D.	-----
1,2-Dichloroethane	N.D.	-----
Trichloroethene	N.D.	97.6
1,2-Dichloropropane	N.D.	-----
Bromodichloromethane	N.D.	-----
2-Chloroethylvinylether	N.D.	-----
Trans-1,3-Dichloropropene	N.D.	-----
Cis-1,3-Dichloropropene	N.D.	-----
1,1,2-Trichloroethane	N.D.	-----
Tetrachloroethene	N.D.	92.8
Dibromochloromethane	N.D.	-----
Chlorobenzene	N.D.	-----
Bromoform	N.D.	-----
1,1,2,2-Tetrachloroethane	N.D.	-----
1,3-Dichlorobenzene	N.D.	-----
1,4-Dichlorobenzene	N.D.	-----
1,2-Dichlorobenzene	N.D.	-----

David Duong
Laboratory Director



PRIORITY ENVIRONMENTAL LABS

Precision Environmental Analytical Laboratory

February 04, 1993

PEL # 9302002

SOIL TECH ENGINEERING

Attn: Noori Ameli

Project name: 2351 Shoreline Dr.-Alameda

Project number: 8-90-418-9

Sample I.D.: STMW-6-5

Date Sampled: Feb 02, 1993
Date Analyzed: Feb 03-04, 1993

Date Submitted: Feb 03, 1993

Method of Analysis: EPA 8010

Detection limit: 5.0 ug/Kg

COMPOUND NAME	CONCENTRATION (ug/Kg)	SPIKE RECOVERY (%)
Chloromethane	N.D.	-----
Vinyl Chloride	N.D.	86.4
Bromomethane	N.D.	-----
Chloroethane	N.D.	-----
Trichlorofluoromethane	N.D.	-----
1,1-Dichloroethene	N.D.	-----
Methylene Chloride	N.D.	92.1
1,2-Dichloroethene (TOTAL)	N.D.	-----
1,1-Dichloroethane	N.D.	-----
Chloroform	N.D.	90.3
1,1,1-Trichloroethane	N.D.	-----
Carbon Tetrachloride	N.D.	-----
1,2-Dichloroethane	N.D.	-----
Trichloroethene	N.D.	97.6
1,2-Dichloropropane	N.D.	-----
Bromodichloromethane	N.D.	-----
2-Chloroethylvinylether	N.D.	-----
Trans-1,3-Dichloropropene	N.D.	-----
Cis-1,3-Dichloropropene	N.D.	-----
1,1,2-Trichloroethane	N.D.	-----
Tetrachloroethene	N.D.	92.8
Dibromochloromethane	N.D.	-----
Chlorobenzene	N.D.	-----
Bromoform	N.D.	-----
1,1,2,2-Tetrachloroethane	N.D.	-----
1,3-Dichlorobenzene	N.D.	-----
1,4-Dichlorobenzene	N.D.	-----
1,2-Dichlorobenzene	N.D.	-----

David Duong
Laboratory Director



PRIORITY ENVIRONMENTAL LABS

Environmental Analytical Laboratory

February 12, 1993

PEL # 9302017

SOIL TECH ENGINEERING, INC.

Attn: Noori Ameli

Re: Four water samples for Gasoline/BTEX, Diesel, and Oil & Grease analyses.

Project name: 2351 Shoreline Dr., - Alameda

Project number: 8-90-418-SI

Date sampled: Feb 08, 1993
Date extracted: Feb 09-11, 1993

Date submitted: Feb 09, 1993
Date analyzed: Feb 09-11, 1993

RESULTS:

SAMPLE I.D.	Gasoline (ug/L)	Diesel (ug/L)	Benzene (ug/L)	Toluene (ug/L)	Ethyl Benzene (ug/L)	Total Xylenes (ug/L)	Oil & Grease (mg/L)
STMW-1	66000	---	210	480	510	1200	---
STMW-3	330000	N.D.	620	1900	2200	6000	3.9
STMW-5	N.D.	---	N.D.	N.D.	N.D.	N.D.	---
STMW-6	33000	---	100	230	270	500	---
Blank	N.D.	N.D.	N.D.	N.D.	N.D.	N.D.	N.D.
Spiked Recovery	101.8%	91.6%	98.3%	103.2%	94.6%	105.7%	---
Duplicate Spiked Recovery	97.6%	---	90.4%	94.2%	89.5%	97.0%	---
Detection limit	50	50	0.5	0.5	0.5	0.5	0.5
Method of Analysis	5030 / 8015	3510 / 8015	602	602	602	602	5520 C & F



David Duong
Laboratory Director



PRIORITY ENVIRONMENTAL LABS

Precision Environmental Analytical Laboratory

February 12, 1993

PEL #: 9302017

SOIL TECH ENGINEERING, INC.
Project name: 2351 Shoreline Dr.-Alameda

Attn: Noori Ameli
Project number: 8-90-418-SI

Sample I.D.: STMW-1

Date Sampled: Feb 08, 1993
Date Analyzed: Feb 09-10, 1993

Date Submitted: Feb 09, 1993

Method of Analysis: EPA 601

Detection limit: 0.5 ug/L

COMPOUND NAME	CONCENTRATION (ug/L)	SPIKE RECOVERY (%)
Chloromethane	N.D.	-----
Vinyl Chloride	N.D.	83.2
Bromomethane	N.D.	-----
Chloroethane	N.D.	-----
Trichlorofluoromethane	N.D.	-----
1,1-Dichloroethene	N.D.	91.4
Methylene Chloride	N.D.	-----
1,2-Dichloroethene (TOTAL)	N.D.	-----
1,1-Dichloroethane	N.D.	-----
Chloroform	N.D.	92.8
1,1,1-Trichloroethane	N.D.	-----
Carbon Tetrachloride	N.D.	-----
1,2-Dichloroethane	N.D.	-----
Trichloroethene	9.5	-----
1,2-Dichloropropane	N.D.	-----
Bromodichloromethane	N.D.	-----
2-Chloroethylvinylether	N.D.	-----
Trans-1,3-Dichloropropene	N.D.	-----
Cis-1,3-Dichloropropene	N.D.	-----
1,1,2-Trichloroethane	N.D.	94.7
Tetrachloroethene	N.D.	-----
Dibromochloromethane	N.D.	-----
Chlorobenzene	N.D.	-----
Bromoform	N.D.	-----
1,1,2,2-Tetrachloroethane	N.D.	-----
1,3-Dichlorobenzene	N.D.	-----
1,4-Dichlorobenzene	N.D.	-----
1,2-Dichlorobenzene	N.D.	-----

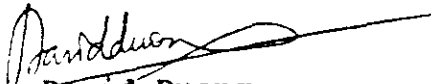
David Duong
Laboratory Director



PRIORITY ENVIRONMENTAL LABS

Environmental Engineering Analytical Laboratory

February 12, 1993

PEL #: 9302017

SOIL TECH ENGINEERING, INC.
Project name: 2351 Shoreline Dr.-Alameda

Attn: Noori Ameli
Project number: 8-90-418-SI

Sample I.D.: STMW-3

Date Sampled: Feb 08, 1993
Date Analyzed: Feb 09-10, 1993

Date Submitted: Feb 09, 1993

Method of Analysis: EPA 601

Detection limit: 0.5 ug/L

COMPOUND NAME	CONCENTRATION (ug/L)	SPIKE RECOVERY (%)
Chloromethane	N.D.	-----
Vinyl Chloride	N.D.	83.2
Bromomethane	N.D.	-----
Chloroethane	N.D.	-----
Trichlorofluoromethane	N.D.	-----
1,1-Dichloroethene	N.D.	91.4
Methylene Chloride	N.D.	-----
1,2-Dichloroethene (TOTAL)	N.D.	-----
1,1-Dichloroethane	N.D.	-----
Chloroform	N.D.	92.8
1,1,1-Trichloroethane	N.D.	-----
Carbon Tetrachloride	N.D.	-----
1,2-Dichloroethane	N.D.	-----
Trichloroethene	2.4	-----
1,2-Dichloropropane	N.D.	-----
Bromodichloromethane	N.D.	-----
2-Chloroethylvinylether	N.D.	-----
Trans-1,3-Dichloropropene	N.D.	-----
Cis-1,3-Dichloropropene	N.D.	-----
1,1,2-Trichloroethane	N.D.	94.7
Tetrachloroethene	N.D.	-----
Dibromochloromethane	N.D.	-----
Chlorobenzene	N.D.	-----
Bromoform	N.D.	-----
1,1,2,2-Tetrachloroethane	N.D.	-----
1,3-Dichlorobenzene	N.D.	-----
1,4-Dichlorobenzene	N.D.	-----
1,2-Dichlorobenzene	N.D.	-----

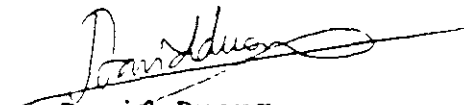
David Duong
Laboratory Director

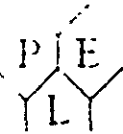

PRIORITY ENVIRONMENTAL LABS

Environmental Analysis Laboratory

February 12, 1993

PEL #: 9302017

SOIL TECH ENGINEERING, INC.
Project name: 2351 Shoreline Dr.-Alameda

Attn: Noori Ameli
Project number: 8-90-418-SI

Sample I.D.: STMW-5

Date Sampled: Feb 08, 1993
Date Analyzed: Feb 09-10, 1993

Date Submitted: Feb 09, 1993

Method of Analysis: EPA 601

Detection limit: 0.5 ug/L

COMPOUND NAME	CONCENTRATION (ug/L)	SPIKE RECOVERY (%)
---------------	---------------------------	-----------------------

Chloromethane	N.D.	-----
Vinyl Chloride	N.D.	83.2
Bromomethane	N.D.	-----
Chloroethane	N.D.	-----
Trichlorofluoromethane	N.D.	-----
1,1-Dichloroethene	N.D.	91.4
Methylene Chloride	N.D.	-----
1,2-Dichloroethene (TOTAL)	N.D.	-----
1,1-Dichloroethane	N.D.	-----
Chloroform	N.D.	92.8
1,1,1-Trichloroethane	N.D.	-----
Carbon Tetrachloride	N.D.	-----
1,2-Dichloroethane	N.D.	-----
Trichloroethene	N.D.	-----
1,2-Dichloropropane	N.D.	-----
Bromodichloromethane	N.D.	-----
2-Chloroethylvinylether	N.D.	-----
Trans-1,3-Dichloropropene	N.D.	-----
Cis-1,3-Dichloropropene	N.D.	-----
1,1,2-Trichloroethane	N.D.	94.7
Tetrachloroethene	N.D.	-----
Dibromochloromethane	N.D.	-----
Chlorobenzene	N.D.	-----
Bromoform	N.D.	-----
1,1,2,2-Tetrachloroethane	N.D.	-----
1,3-Dichlorobenzene	N.D.	-----
1,4-Dichlorobenzene	N.D.	-----
1,2-Dichlorobenzene	N.D.	-----

David Duong
Laboratory Director

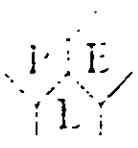

PRIORITY ENVIRONMENTAL LABS

February 12, 1993

PEL #: 9302017

SOIL TECH ENGINEERING, INC.
Project name: 2351 Shoreline Dr.-Alameda

Attn: Noori Ameli
Project number: 8-90-418-SI

Sample I.D.: STMW-6

Date Sampled: Feb 08, 1993
Date Analyzed: Feb 09-10, 1993

Date Submitted: Feb 09, 1993

Method of Analysis: EPA 601

Detection limit: 0.5 ug/L

COMPOUND NAME	CONCENTRATION (ug/L)	SPIKE RECOVERY (%)
Chloromethane	N.D.	-----
Vinyl Chloride	N.D.	83.2
Bromomethane	N.D.	-----
Chloroethane	N.D.	-----
Trichlorofluoromethane	N.D.	-----
1,1-Dichloroethene	N.D.	91.4
Methylene Chloride	N.D.	-----
1,2-Dichloroethene (TOTAL)	N.D.	-----
1,1-Dichloroethane	N.D.	-----
Chloroform	N.D.	92.8
1,1,1-Trichloroethane	N.D.	-----
Carbon Tetrachloride	N.D.	-----
1,2-Dichloroethane	N.D.	-----
Trichloroethene	11	-----
1,2-Dichloropropane	N.D.	-----
Bromodichloromethane	N.D.	-----
2-Chloroethylvinylether	N.D.	-----
Trans-1,3-Dichloropropene	N.D.	-----
Cis-1,3-Dichloropropene	N.D.	-----
1,1,2-Trichloroethane	N.D.	94.7
Tetrachloroethene	N.D.	-----
Dibromochloromethane	N.D.	-----
Chlorobenzene	N.D.	-----
Bromoform	N.D.	-----
1,1,2,2-Tetrachloroethane	N.D.	-----
1,3-Dichlorobenzene	N.D.	-----
1,4-Dichlorobenzene	N.D.	-----
1,2-Dichlorobenzene	N.D.	-----

David Duong
Laboratory Director

File No. 8-90-418-SI

A P P E N D I X "F"

SOIL TECH ENGINEERING, INC.



ALAMEDA COUNTY FLOOD CONTROL AND WATER CONSERVATION DISTRICT

5997 PARKSIDE DRIVE

PLEASANTON, CALIFORNIA 94568

(510) 484-2600

26 January 1993

Soil Tech Engineering, Inc.
298 Brokaw Road
Santa Clara, CA 95050

Gentlemen:

Enclosed is drilling permit 93024 for a monitoring well construction project at 2351 Shoreline Drive in Alameda for Kamur Industries.

Please note that permit condition A-2 requires that a well construction report be submitted after completion of the work. The report should include drilling and completion logs, location sketch and permit number.

If you have any questions, please contact Wyman Hong or me at 484-2600.

Very truly yours,

Craig A. Mayfield

Craig A. Mayfield
Water Resources Engineer III

WH:mm
Enc.



ZONE 7 WATER AGENCY

5997 PARKSIDE DRIVE

PLEASANTON, CALIFORNIA 94588

VOICE (510) 484-2600

FAX (510) 462-3914

DRILLING PERMIT APPLICATION

FOR APPLICANT TO COMPLETE

FOR OFFICE USE

LOCATION OF PROJECT 2351 Shoreline Dr.
Alameda CA 94501

PERMIT NUMBER 93024

LOCATION NUMBER _____

CLIENT

Name KAMUR INDUSTRIES
Address 2351 Shoreline Dr. Phone (510) 523-7866
City Alameda CA Zip 94501

PERMIT CONDITIONS

Circled Permit Requirements Apply

APPLICANT

Name SOIL TECH ENGINEERING INC.
Address 298 Brockway Rd. Phone (408) 496-0265
City SANTA CLARA Zip 95050

TYPE OF PROJECT

Well Construction _____ Geotechnical Investigation _____
Cathodic Protection _____ General _____
Water Supply _____ Contamination _____
Monitoring Well Destruction _____

PROPOSED WATER SUPPLY WELL USE

Domestic _____ Industrial _____ Other _____
Municipal _____ Irrigation _____

DRILLING METHOD:

Mud Rotary _____ Air Rotary _____ Auger
Cable _____ Other _____

DRILLER'S LICENSE NO. C57 507520

WELL PROJECTS

Drill Hole Diameter 8 in. Maximum _____
Casing Diameter 2 in. Depth 15 ft.
Surface Seal Depth _____ ft. Number 3

GEOTECHNICAL PROJECTS

Number of Borings _____ Maximum _____
Hole Diameter _____ in. Depth _____ ft.

ESTIMATED STARTING DATE 1/27/93

ESTIMATED COMPLETION DATE 1/29/93

I hereby agree to comply with all requirements of this permit and Alameda County Ordinance No. 73-68

Approved

Wyman Hong
Wyman Hong

Date 21 Jan

APPLICANT'S

SIGNATURE N. Amadio Date 1/20/93

CONFIDENTIAL

STATE OF CALIFORNIA DWR
WELL COMPLETION REPORT
(WELL LOGS)

REMOVED

CONFIDENTIAL

STATE OF CALIFORNIA DWR
WELL COMPLETION REPORT
(WELL LOGS)

REMOVED

APPENDIX D

CLAYTON GROUNDWATER MONITORING WELL SAMPLING PROTOCOLS

CLAYTON GROUNDWATER MONITORING WELL

SAMPLING PROTOCOLS

To collect a representative sample of the groundwater, stagnant water within the well casing and filter material must be purged and fresh aquifer water allowed to replace it. The water is purged from the well by pumping or bailing at least three well volumes. Well volumes are calculated by measuring depth to groundwater to the nearest 0.01 foot upon arrival at the well before any purging has begun.

Groundwater samples are collected only after purging has been of sufficient duration for pH, temperature, and electrical conductivity to stabilize. When purging low-yield wells, the wells are purged to dryness. When the well recovers to 80% of the depth measured upon arrival, samples are collected.

Field sampling logs maintained for each well include:

- Monitoring well identification
- Static water level, before and after pumping
- Well depth
- Condition of water prior to purging (e.g., amount of free product)
- Purge rate and volume
- pH, temperature, and conductivity during purging
- Time purged
- Time of sample collection
- Sampling method
- Name of sampler
- Climatic conditions

Water samples are collected using clean teflon or disposable bailers. All equipment that contacts samples is thoroughly cleaned before arrival at the site and between sampling events.

Water is collected in clean laboratory-supplied containers, labeled, placed immediately into an ice chest pre-cooled to 4°C, and transported to Clayton's laboratory for analysis. One trip blank will be furnished in accordance with our quality assurance/quality control (QA/QC) program.

All samples are collected in such a manner so as to minimize the volatilization of a sample due to agitation and/or transfer from bailer to sample container. Samples are collected so that contaminants most sensitive to volatilization are sampled first.

Preservatives are not added to any sample, unless instructed. If requested, they are supplied by Clayton's laboratory.

All sample containers are labeled in the field. Labels contain the following information: project name, sample identification number, project number, date and time of collection, and sampler's initials.

Under no circumstances are sealed sample containers opened by anyone other than the laboratory personnel who perform the requested analyses. If it is necessary for samples or sample chests to leave the immediate control of the sampler prior to delivery to the laboratory, for example during shipment by Federal Express, a custody seal is placed on each sample container and/or sample chest to ensure that the samples have not been tampered with during transportation. The custody seal is signed by the sampler, and the date and time that the seal was placed is recorded. The elapsed time between sample collection and delivery to the laboratory never exceeds 48 hours. Water samples are not held for more than 14 days prior to analysis and are kept at 4°C at all times.

To document and trace samples from time of collection, a signed chain-of-custody record is filled out by the sampler and accompanies the samples through the laboratory analyses. The completed chain-of-custody is included with the analytical report from the laboratory.

REFERENCES

Groundwater Monitoring Guidelines, Revised February 1990. Alameda County District Groundwater Protection Program.

Leaking Underground Fuel Tank (LUFT) Field Manual: Guidelines for Site Assessment, Cleanup, and Underground Tank Closure, May 1988. State of California LUFT Task Force.

Regional Board Staff Recommendations for Initial Evaluation and Investigation of Underground Tanks, Revised November 1989. North Coast, San Francisco Bay, and Central Valley regions of the California State Water Quality Control Board.

APPENDIX E

WATER SAMPLING FIELD SURVEY FORMS

**CLAYTON ENVIRONMENTAL CONSULTANTS, INC.
WATER SAMPLING FIELD SURVEY FORM**

Job No: 45040.06

Site: Harsch

Date: 2/24/93

Well No: MW-15

Sampling Team: M. Springman

Sampling Method: Disposable bailer/2-inch pump

Field Conditions: Clear, cool

Describe Equipment Decontamination Before Sampling This Well:

Pump washed with soap and rinsed with deionized water

Total Depth of Well:

19.25 ft.

Time:

1115

Depth to Water Before Purging:

3.5 ft.

Height of Water Column:

15.7 ft.

2-inch

.16

4-inch

.65

Volume

= 2.51 gals

Purge Factor

* 4

Volume To Purge

= 10.04 gals.

Depth Purging From: 6 ft.

Time Purging Begins: 1125

Notes on Initial Discharge:

Time	Volume Purged	pH	Conductivity	TC	Comments
1130	3	8.5	1380	16.6	Clear
1135	6	8.9	882	16.3	Clear
1140	9	9.5	507	16.3	Clear
1145	11	9.5	226	16.6	Clear

CLAYTON ENVIRONMENTAL CONSULTANTS, INC.
WATER SAMPLING FIELD SURVEY FORM
(CONTINUED)

Time Field Parameter Measurement Begins: 1200

	Rep #1	Rep #2	Rep #3	Rep #4
pH	9.5	9.5	9.5	9.5
Conductivity	250	250	250	250
T°C	16.5	16.5	16.5	16.5

Pre-Sample Collection Gallons Purged: 11
Time Sample Collection Begins: 1150
Time Sample Collection Ends: 1155
Total Gallons Purged: 12

Comments:

**CLAYTON ENVIRONMENTAL CONSULTANTS, INC.
WATER SAMPLING FIELD SURVEY FORM**

Job No: 45040.06

Site: Harsch

Date: 2/23/93

Well No: MW-22

Sampling Team: G. Williams

Sampling Method: Disposable bailer/2-inch pump

Field Conditions: Cloudy, cool

Describe Equipment Decontamination Before Sampling This Well:

Pump washed with soap and rinsed with deionized water

Total Depth of Well:

23.75 ft.

Time:

0930

Depth to Water Before Purging:

6.33 ft.

Height of Water Column:

17.42 ft.

2-inch

.16

4-inch

.65

=

Volume

2.78 gals

*

Purge Factor

4

=

Volume To Purge

11.14 gals.

Depth Purging From:

Time Purging Begins:

Notes on Initial Discharge:

Time	Volume Purged	pH	Conductivity	T/C	Comments
0935	3	8.7	1490	14.8	Turbid
0940	6	8.6	1380	14.8	Turbid
0945	9	8.6	1340	14.4	Turbid
1000	12	8.5	1300	14.6	Turbid

CLAYTON ENVIRONMENTAL CONSULTANTS, INC.
WATER SAMPLING FIELD SURVEY FORM
(CONTINUED)

Time Field Parameter Measurement Begins: 1003

	Rep #1	Rep #2	Rep #3	Rep #4
pH	8.6	8.5	8.6	8.6
Conductivity	1260	1280	1160	1140
T°C	14.6	14.6	14.6	14.6

Pre-Sample Collection Gallons Purged: 12
Time Sample Collection Begins: 1010
Time Sample Collection Ends: 1015
Total Gallons Purged: 13

Comments:

**CLAYTON ENVIRONMENTAL CONSULTANTS, INC.
WATER SAMPLING FIELD SURVEY FORM**

Job No: 45040.06

Site: Harsch

Date: 2/24/93

Well No: MW-23

Sampling Team: G. Williams

Sampling Method: Disposable bailer/2-inch pump

Field Conditions: Clear, cool

Describe Equipment Decontamination Before Sampling This Well:

Pump washed with soap and rinsed with deionized water

Total Depth of Well:

18.38 ft.

Time:

1440

Depth to Water Before Purging:

3.42 ft.

Height of Water Column:

15 ft.

2-inch

.16

4-inch

.65

=

Volume

2.4 gals

*

Purge Factor

4

=

Volume To Purge

9.6 gals.

Depth Purging From:

Time Purging Begins:

Notes on Initial Discharge: Silty

Time	Volume Purged	pH	Conductivity	Temp	Comments
1450	3	9.1	181	13.7	Turbid
1453	6	8.7	209	14.7	Turbid
1458	9	8.6	225	14.4	Turbid

CLAYTON ENVIRONMENTAL CONSULTANTS, INC.
WATER SAMPLING FIELD SURVEY FORM
(CONTINUED)

Time Field Parameter Measurement Begins: 1505

	Rep #1	Rep #2	Rep #3	Rep #4
pH	8.6	8.6	8.4	8.2
Conductivity	252	265	278	300
T°C	14.4	14.2	14.6	14.6

Pre-Sample Collection Gallons Purged: 10
Time Sample Collection Begins: 1520
Time Sample Collection Ends: 1525
Total Gallons Purged: 12

Comments:

**CLAYTON ENVIRONMENTAL CONSULTANTS, INC.
WATER SAMPLING FIELD SURVEY FORM**

Job No: 45040.06

Site: Harsch

Date: 2/25/93

Well No: MW-5B

Sampling Team: G. Williams

Sampling Method: Disposable bailer/2-inch pump

Field Conditions: Clear, cool

Describe Equipment Decontamination Before Sampling This Well:

Pump washed with soap and rinsed with deionized water

Total Depth of Well:

12.79 ft.

Time:

1042

Depth to Water Before Purging:

2.42 ft.

Height of Water Column:

10.25 ft.

2-inch

.16

4-inch

.65

=

Volume

6.66 gals

*

Purge Factor

4

=

Volume To Purge

26.65 gals.

Depth Purging From:

Time Purging Begins:

Notes on Initial Discharge: Clear, no odor

Time	Volume Purged	pH	Conductivity	TC	Comments
1050	5	8.0	976	15.4	Clear
1055	10	7.9	1187	15.5	Clear
1100	15	7.8	1640	15.6	Clear
1105	20	7.7	1996	15.7	Clear
1110	25	7.6	Off scale	15.9	Clear

CLAYTON ENVIRONMENTAL CONSULTANTS, INC.
WATER SAMPLING FIELD SURVEY FORM
(CONTINUED)

Time Field Parameter Measurement Begins: 1112

	Rep #1	Rep #2	Rep #3	Rep #4
pH	7.6	7.6	7.7	7.6
Conductivity	Off scale	Off scale	Off scale	Off scale
T°C	15.8	15.7	15.8	15.8

Pre-Sample Collection Gallons Purged: 27
Time Sample Collection Begins: 1115
Time Sample Collection Ends: 1120
Total Gallons Purged: 29

Comments:

**CLAYTON ENVIRONMENTAL CONSULTANTS, INC.
WATER SAMPLING FIELD SURVEY FORM**

Job No: 45040.06

Site: Harsch

Date: 2/25/93

Well No: MW-11

Sampling Team: G. Williams

Sampling Method: Disposable bailer

Field Conditions: Cloudy, cool

Describe Equipment Decontamination Before Sampling This Well:

N/A

Total Depth of Well:

11.42 ft.

Time:

1220

Depth to Water Before Purging:

4.75 ft.

Height of Water Column:

6.6 ft.

2-inch

.16

4-inch

.65

=

Volume

1.07 gals

*

Purge Factor

4

=

Volume To Purge

4.29 gals

Depth Purging From: ft.

Time Purging Begins:

Notes on Initial Discharge:

Time	Volume Purged	pH	Conductivity	TC	Comments
1255	2	8.5	850	14.5	Turbid
1258	4	8.5	830	14.5	Clear
1304	5	8.3	810	14.4	Clear

CLAYTON ENVIRONMENTAL CONSULTANTS, INC.
WATER SAMPLING FIELD SURVEY FORM
(CONTINUED)

Time Field Parameter Measurement Begins: 1310

	Rep. #1	Rep. #2	Rep. #3	Rep. #4
pH	8.3	8.3	8.4	8.3
Conductivity	810	800	800	780
T°C	14.4	14.6	14.6	14.8

Pre-Sample Collection Gallons Purged: 5
Time Sample Collection Begins: 1315
Time Sample Collection Ends: 1316
Total Gallons Purged: 6

Comments:

**CLAYTON ENVIRONMENTAL CONSULTANTS, INC.
WATER SAMPLING FIELD SURVEY FORM**

Job No: 45040.06

Site: Harsch

Date: 2/24/93

Well No: MW-16

Sampling Team: G. Williams

Sampling Method: Disposable bailer/2-inch pump

Field Conditions: Clear, cool

Describe Equipment Decontamination Before Sampling This Well:

Pump washed with soap and rinsed with deionized water

Total Depth of Well:

29.42 ft.

Time:

1120

Depth to Water Before Purging:

0.42 ft.

Height of Water Column: 29 ft.

2-inch

4-inch

Volume

Purge Factor

Volume To Purge

*

.16

.65

=

4.14 gals

*

4

=

18.56 gals.

Depth Purging From:

Time Purging Begins:

Notes on Initial Discharge: Clear

Time	Volume Purged	pH	Conductivity	TC	Comments
1130	5	8.1	Off scale	18.2	Clear
1140	10	8.0	Off scale	19.1	Clear
1155	15	8.0	Off scale	19.0	Clear

CLAYTON ENVIRONMENTAL CONSULTANTS, INC.
WATER SAMPLING FIELD SURVEY FORM
(CONTINUED)

Time Field Parameter Measurement Begins: 1155

	Rep #1	Rep #2	Rep #3	Rep #4
pH	8.0	8.0	8.0	8.0
Conductivity	Off scale	Off scale	Off scale	Off scale
T°C	19.1	19.0	19.0	19.0

Pre-Sample Collection Gallons Purged: 17.5
Time Sample Collection Begins: 1158
Time Sample Collection Ends: 1159
Total Gallons Purged: 18.5

Comments:

**CLAYTON ENVIRONMENTAL CONSULTANTS, INC.
WATER SAMPLING FIELD SURVEY FORM**

Job No: 45040.06

Site: Harsch

Date: 2/24/93

Well No: MW-14

Sampling Team: G. Williams

Sampling Method: Disposable bailer/2-inch pump

Field Conditions: Clear, warm

Describe Equipment Decontamination Before Sampling This Well:

Pump washed with soap and rinsed with deionized water

Total Depth of Well:

14.2 ft.

Time:

1245

Depth to Water Before Purging:

3.42 ft.

Height of Water Column:

10.75 ft.

2-inch

.16

4-inch

.65

=

Volume

6.98 gals

*

Purge Factor

4

=

Volume To Purge

27.95 gals.

Depth Purging From:

Time Purging Begins:

Notes on Initial Discharge:

Time	Volume Purged	pH	Conductivity	TC	Comments
1250	5	8.2	Off scale	16.6	Clear
1255	10	8.1	Off scale	17.2	Clear
1300	15	8.7	Off scale	16.3	Clear
1305	20	8.7	Off scale	16.3	Clear
1310	25	8.6	Off scale	16.4	Clear

**CLAYTON ENVIRONMENTAL CONSULTANTS, INC.
WATER SAMPLING FIELD SURVEY FORM
(CONTINUED)**

Time Field Parameter Measurement Begins: 1312

	Rep #1	Rep #2	Rep #3	Rep #4
pH	8.7	8.7	8.6	8.7
Conductivity	Off scale	Off scale	Off scale	Off scale
TC	16.4	16.2	16.6	16.6

Pre-Sample Collection Gallons Purged: 28
Time Sample Collection Begins: 1315
Time Sample Collection Ends: 1318
Total Gallons Purged: 29

Comments:

**CLAYTON ENVIRONMENTAL CONSULTANTS, INC.
WATER SAMPLING FIELD SURVEY FORM**

Job No: 45040.06

Site: Harsch

Date: 2/23/93

Well No: MW-18

Sampling Team: G. Williams

Sampling Method: Disposable bailer/2-inch pump

Field Conditions: Rain, windy, cold

Describe Equipment Decontamination Before Sampling This Well:

Pump washed with soap and rinsed with deionized water

Total Depth of Well:

24.67 ft.

Time:

1445

Depth to Water Before Purging:

4.38 ft.

Height of Water Column:

20.42 ft.

2-inch

.16

4-inch

.65

=

Volume

3.26 gals

*

Purge Factor

4

=

Volume To Purge

13.06 gals

Depth Purging From:

Time Purging Begins:

Notes on Initial Discharge:

Time	Volume Purged	pH	Conductivity	T.C.	Comments
1255	5	7.5	Off scale	18.6	Clear
1300	10	7.4	Off scale	18.6	Clear
1305	15	7.4	Off scale	18.6	Clear

CLAYTON ENVIRONMENTAL CONSULTANTS, INC.
WATER SAMPLING FIELD SURVEY FORM
(CONTINUED)

Time Field Parameter Measurement Begins: 1310

	Rep #1	Rep #2	Rep #3	Rep #4
pH	7.4	7.4	7.4	7.4
Conductivity	Off scale	Off scale	Off scale	Off scale
T°C	18.6	18.6	18.6	18.6

Pre-Sample Collection Gallons Purged: 15
Time Sample Collection Begins: 1315
Time Sample Collection Ends: 1317
Total Gallons Purged: 16

Comments:

**CLAYTON ENVIRONMENTAL CONSULTANTS, INC.
WATER SAMPLING FIELD SURVEY FORM**

Job No: 45040.06

Site: Harsch

Date: 2/23/93

Well No: MW-17

Sampling Team: G. Williams

Sampling Method: Disposable bailer/2-inch D.C. pump

Field Conditions: Rain, cool

Describe Equipment Decontamination Before Sampling This Well:

Pump washed with soap and rinsed with deionized water

Total Depth of Well:

24.42 ft.

Time:

1115

Depth to Water Before Purging:

2.5 ft.

Height of Water Column:

22 ft.

2-inch

.16

4-inch

.65

=

Volume

3.52 gals

*

Purge Factor

5

=

Volume To Purge

17.6 gals.

Depth Purging From:

Time Purging Begins:

Notes on Initial Discharge:

Time	Volume Purged	pH	Conductivity	TC	Comments
1125	5	8.3	Off scale	18.4	Turbid
1140	10	8.7	Off scale	18.7	Clearing
1150	15	8.9	Off scale	18.4	Clearing

CLAYTON ENVIRONMENTAL CONSULTANTS, INC.
WATER SAMPLING FIELD SURVEY FORM
(CONTINUED)

Time Field Parameter Measurement Begins: 1155

	Rep #1	Rep #2	Rep #3	Rep #4
pH	8.8	8.8	8.8	8.8
Conductivity	Off scale	Off scale	Off scale	Off scale
T°C	18.3	18.2	18.2	18.2

Pre-Sample Collection Gallons Purged: 17.5
Time Sample Collection Begins: 1210
Time Sample Collection Ends: 1213
Total Gallons Purged: 19

Comments:

**CLAYTON ENVIRONMENTAL CONSULTANTS, INC.
WATER SAMPLING FIELD SURVEY FORM**

Job No: 45040.06

Site: Harsch

Date: 2/23/93

Well No: MW-SB

Sampling Team: G. Williams

Sampling Method: Disposable bailer/2-inch pump

Field Conditions: Rain, windy, cool

Describe Equipment Decontamination Before Sampling This Well:

Pump washed with soap and rinsed with deionized water

Total Depth of Well:

21.92 ft.

Time:

1350

Depth to Water Before Purging:

4.92 ft.

Height of Water Column: 17 ft.

2-inch

*

.16

4-inch

.65

=

Volume

11.05 gals

*

Purge Factor

4

=

Volume To Purge

44.2 gals.

Depth Purging From:

Time Purging Begins:

Notes on Initial Discharge:

Time	Volume Purged	pH	Conductivity	°C	Comments
1405	10	8.2	Inoperative	16.9	Clear
1410	20	8.2	Inoperative	16.9	Clear
1415	30	8.2	Inoperative	16.8	Clear
1420	40	8.2	Inoperative	16.7	Clear
1425	45	8.2	Inoperative	16.9	Clear

CLAYTON ENVIRONMENTAL CONSULTANTS, INC.
WATER SAMPLING FIELD SURVEY FORM
(CONTINUED)

Time Field Parameter Measurement Begins: 1430

	Rep #1	Rep #2	Rep #3	Rep #4
pH	8.2	8.2	8.2	8.2
Conductivity	Off scale	Off scale	Off scale	Off scale
T°C	16.9	16.9	16.9	16.9

Pre-Sample Collection Gallons Purged: 45
Time Sample Collection Begins: 1435
Time Sample Collection Ends: 1437
Total Gallons Purged: 47

Comments:

**CLAYTON ENVIRONMENTAL CONSULTANTS, INC.
WATER SAMPLING FIELD SURVEY FORM**

Job No: 45040.06

Site: Harsch

Date: 2/23/93

Well No: MW-7B

Sampling Team: G. Williams

Sampling Method: Disposable bailer/2-inch pump

Field Conditions: Rain, cold

Describe Equipment Decontamination Before Sampling This Well:

Pump washed with soap and rinsed with deionized water

Total Depth of Well:

13.00 ft.

Time:

1230

Depth to Water Before Purging:

3.33 ft.

Height of Water Column:

9.5 ft.

2-inch

.16

4-inch

.65

=

Volume

6.17 gals

*

Purge Factor

4

=

Volume To Purge

24.7 gals.

Depth Purging From:

Time Purging Begins:

Notes on Initial Discharge:

Time	Volume Purged	pH	Conductivity	T°C	Comments
1245	5	8.7	1037	16.8	Clear
1250	10	8.4	810	16.8	Clear
1252	15	8.3	814	16.8	Clear
1255	20	8.3	103	17.3	Clear
1257	25	8.3	680	17.9	Clear

CLAYTON ENVIRONMENTAL CONSULTANTS, INC.
 WATER SAMPLING FIELD SURVEY FORM
 (CONTINUED)

Time Field Parameter Measurement Begins: 1325

	Rep #1	Rep #2	Rep #3	Rep #4
pH	8.3	8.3	8.3	8.3
Conductivity	640	570	620	624
T°C	17.8	17.8	17.9	17.9

Pre-Sample Collection Gallons Purged: 25
Time Sample Collection Begins: 1335
Time Sample Collection Ends: 1340
Total Gallons Purged: 27

Comments:

APPENDIX F

PREVIOUS GROUNDWATER SAMPLING RESULTS

Historical Groundwater Analysis Results for Horach Investment Property in Alameda
for Samples Collected from November 1990 to November 1991
 All Concentrations in milligrams per liter (µg/l)

Chemical	MW-2				MW-3				MW-4				MW-5B				MW-9B				MW-14				Regulatory Guidelines
	11/90	4/91	7/91	11/91	11/90	4/91	7/91	11/91	11/90	4/91	7/91	11/91	11/90	4/91	7/91	11/91	11/90	4/91	7/91	11/91	11/90	4/91	7/91	11/91	
EPA Method 8015/8020 for:																									
Benzene	<0.4	<0.4	<0.4	<0.4	<0.4	<0.4	<0.4	<0.4	<0.4	<0.4	<0.4	<0.4	800	1,300	3.1	21	<0.4	<0.4	<0.4	<0.4		29	0.8	22	1 ⁽¹⁾
Toluene	<0.3	<0.3	<0.3	<0.3	0.5	<0.3	<0.3	<0.3	<0.3	<0.3	<0.3	<0.3	12	45	3.7	4.6	<0.3	<0.3	<0.3	<0.3		<0.3	0.8	<0.3	100 ⁽²⁾
Ethylbenzene	<0.3	<0.3	<0.3	<0.3	<0.3	<0.3	<0.3	<0.3	<0.3	<0.3	<0.3	<0.3	320	370	13	10	<0.3	<0.3	<0.3	<0.3		<0.3	<0.3	<0.3	680 ⁽¹⁾
Xylenes	<0.4	<0.4	<0.4	<0.4	<0.4	<0.4	<0.4	<0.4	<0.4	<0.4	<0.4	<0.4	66	100	2.2	2.2	<0.4	<0.4	<0.4	<0.4		0.5	0.8	1.8	1,750 ⁽¹⁾
Gasoline	<50	<50	<50	<50	<50	<50	<50	<50	<50	<50	<50	<50	2,900	4,000	400	700	<50	<50	<50	<50		<50	<50	50	Not available
EPA Method 3510 for:																									
Diesel	<50	<50	NA	<50	<50	<50	NA	<50	<50	<50	NA	<50	(a) <800	(a) <500	(a) <400	220	<50	<50	NA	<50		230	180	140	100 ⁽³⁾
EPA Method 418.1 for:																									
TRPH	1,000	NA	NA	NA	<1,000	NA	NA	NA	<1,000	NA	NA	NA	2,000	NA	NA	NA	1,000	NA	NA	NA		NA	NA	NA	Not available
EPA Method 5520 for:																									
Total oil and grease hydrocarbons	NA	<5,000	NA	<5,000	NA	<5,000	NA	<5,000	NA	<5,000	NA	<5,000	NA	<5,000	<5,000	<5,000	NA	<5,000	NA	<5,000		<5,000	<5,000	<5,000	Not available
EPA Method 601 Purgeable Halocarbons for:																									
Cis-1,2-dichloroethene	<0.4	<0.4	<0.4	<0.4	<0.4	<0.4	<0.4	<0.4	<0.4	<0.4	<0.4	<0.4	<0.4	<4	<0.4	<0.4	<0.4	<0.4	<0.4		<0.4	<0.4	<0.4	6 ⁽¹⁾	
1,2-dichloroethane	<0.3	<0.3	<0.3	<0.3	<0.3	<0.3	<0.3	<0.3	<0.3	<0.3	<0.3	<0.3	<0.3	<3	<0.3	<0.3	<0.3	<0.3	<0.3		4.6	6.6	1.5	0.5 ⁽¹⁾	
Trichloroethene	<0.3	<0.3	<0.3	<0.3	0.5	<0.3	<0.3	<0.3	0.5	<0.3	<0.3	<0.3	<0.3	<3	<0.3	<0.3	<0.3	<0.3	<0.3		0.4	<0.3	<0.3	5 ⁽¹⁾	
Tetrachloroethene	<0.5	<0.5	<0.5	<0.5	<0.5	3	<0.5	1.3	<0.5	<0.5	<0.5	<0.5	<0.5	<5	<0.5	<0.5	1.5	3.3	<0.5	<0.5		16	<0.5	<0.5	5 ⁽¹⁾
1,1-dichloroethene	<0.2	<0.2	<0.2	<0.2	<0.2	<0.2	<0.2	<0.2	<0.2	<0.2	<0.2	<0.2	<0.2	<2	<0.2	<0.2	<0.2	<0.2	<0.2		0.5	<0.2	<0.2	6 ⁽¹⁾	
Trans-1,4-dichloroethene	<0.4	<0.4	<0.4	<0.4	0.4	<0.4	<0.4	<0.4	0.4	<0.4	<0.4	<0.4	<0.4	<4	<0.4	<0.4	<0.4	<0.4	<0.4		<0.4	<0.4	<0.4	10 ⁽¹⁾	
1,1,2-trichloroethene	<0.6	<0.6	<0.6	<0.6	0.6	<0.6	<0.6	<0.6	0.6	<0.6	<0.6	<0.6	<0.6	<6	<0.6	<0.6	<0.6	<0.6	<0.6		<0.6	<0.6	<0.6	32 ⁽¹⁾	
Bromoform	<0.7	<0.7	<0.7	<0.7	0.7	<0.7	<0.7	<0.7	0.7	<0.7	<0.7	<0.7	<0.7	<7	<0.7	<0.7	<0.7	<0.7	<0.7		<0.7	<0.7	<0.7	7 ⁽¹⁾	
Chlorobenzene	<0.7	<0.7	<0.7	<0.7	0.7	<0.7	<0.7	<0.7	0.7	<0.7	<0.7	<0.7	<0.7	<7	<0.7	<0.7	<0.7	<0.7	<0.7		<0.7	<0.7	<0.7	30 ⁽¹⁾	

NA = not analyzed
 (a) = detection limit increased due to the presence of gasoline in the sample
 TRPH = total recoverable petroleum hydrocarbons
 < = less than the limit of detection
 800 = above regulatory guidelines
 900 = detected, but less than regulatory guidelines

(1) Maximum contaminant level (MCL) for drinking water standards (DHS)
 (2) California State Action Level (DHS)
 (3) Health Advisor or Suggested No-Adverse-Response Levels (EPA) (DHS)

Regulatory guidelines are taken from Jon B. Marshack's "A Compilation of Water Quality Goals, October 1990," published by Regional Water Quality Control Board Central Valley Region

Historical Groundwater Analysis Results for Harach Investment Property in Alameda
for Samples Collected from November 1990 to July 1992
 All concentrations in micrograms per liter (µg/L)

Chemical	MW-7B							MW-8B							MW-16							MW-17							Regulatory Guidelines
	11/90	4/91	7/91	11/91	3/92	6/92	10/92	11/90	4/91	7/91	11/91	3/92	6/92	10/92	11/90	4/91	7/91	11/91	3/92	6/92	10/92	11/90	4/91	7/91	11/91	3/92	6/92	10/92	
EPA Method 8015/8020 for:																													
Benzene	<0.4	<0.4	NA	<0.4	<0.4	NA	NA	<0.4	<0.4	NA	<0.4	<0.4	NA	NA	-	-	-	-	<0.4	NA	NA	-	-	-	-	<0.4	NA	NA	1 ⁽¹⁾
Toluene	<0.3	<0.3	NA	<0.3	<0.3	NA	NA	<0.3	<0.3	NA	<0.3	<0.3	NA	NA	-	-	-	-	<0.3	NA	NA	-	-	-	-	<0.3	NA	NA	100 ⁽²⁾
Ethylbenzene	<0.3	<0.3	NA	<0.3	<0.3	NA	NA	<0.3	<0.3	NA	<0.3	<0.3	NA	NA	-	-	-	-	<0.3	NA	NA	-	-	-	-	<0.3	NA	NA	680 ⁽¹⁾
Xylenes	<0.4	<0.4	NA	<0.4	<0.4	NA	NA	<0.4	<0.4	NA	<0.4	<0.4	NA	NA	-	-	-	-	<0.4	NA	NA	-	-	-	-	<0.4	NA	NA	1,750 ⁽¹⁾
Gasoline	<50	<50	NA	<50	<50	NA	NA	<50	<50	NA	<50	<50	NA	NA	-	-	-	-	<50	NA	NA	-	-	-	-	<50	NA	NA	Not app.
EPA Method 3510 for:																													
Diesel	<50	<50	NA	<50	NA	NA	NA	<50	<50	NA	<50	NA	NA	NA	-	-	-	-	NA	NA	NA	-	-	-	-	NA	NA	NA	100 ⁽³⁾
EPA Method 418.1 for:																													
TRPH	<1,000	NA	NA	NA	NA	NA	NA	<1,000	NA	NA	NA	NA	NA	NA	-	-	-	-	NA	NA	NA	-	-	-	-	NA	NA	NA	Not app.
EPA Method 5520 for:																													
Total oil and grease hydrocarbons	NA	<5,000	NA	<5,000	NA	NA	NA	NA	<5,000	NA	<5,000	NA	NA	NA	-	-	-	-	NA	NA	NA	-	-	-	-	NA	NA	NA	Not app.
EPA Method 601 Purgeable Halocarbons for:																													
Cis-1,2-dichloroethene	440	90	170	140	<40	190	540	1.2	6.8	11	6.3	7.9	7.0	20	-	-	-	-	<0.4	<0.4	<0.4	-	-	-	-	<0.4	<0.4	<0.4	6 ⁽¹⁾
Trichloroethene	520	200	660	700	390	450	1,200	3.0	7.7	19	12	13	10	23	-	-	-	-	<0.5	<0.5	<0.5	-	-	-	-	<0.5	<0.5	<0.5	5 ⁽¹⁾
Tetrachloroethene	1,900	1,600	7,800	6,600	3,200	8,500	13,000	0.9	1.1	0.9	5	<0.5	<0.5	<0.5	-	-	-	-	1.1	2.7	<0.5	-	-	-	-	<0.5	<0.5	<0.5	5 ⁽¹⁾
1,1-dichloroethene	<20	<5	4.6	<20	<20	3.7	<5*	<0.2	<0.2	<0.2	<0.2	<0.2	<0.2	<0.2	-	-	-	-	<0.2	<0.2	<0.2	-	-	-	-	<0.2	<0.2	<0.2	6 ⁽¹⁾
Trans-1,4-dichloroethene	<40	<10	2.6	<40	<40	1.3	<20*	<0.4	<0.4	<0.4	<0.4	<0.4	<0.4	<0.4	-	-	-	-	<0.4	<0.4	<0.4	-	-	-	-	<0.4	<0.4	<0.4	10 ⁽¹⁾
1,1,2-trichloroethene	<60	<20	0.8	<60	<60	<0.6	<20*	<0.6	<0.6	<0.6	<0.6	<0.6	<0.6	<0.6	-	-	-	-	<0.6	<0.6	<0.6	-	-	-	-	<0.6	<0.6	<0.6	32 ⁽¹⁾
Bromoform	<70	<20	1.7	<70	<70	<0.7	<20*	<0.7	<0.7	<0.7	<0.7	<0.7	<0.7	<0.7	-	-	-	-	<0.7	<0.7	<0.7	-	-	-	-	<0.7	<0.7	<0.7	7 ⁽¹⁾
Chlorobenzene	<70	<20	4.8	<70	<70	4.6	<20*	<0.7	<0.7	<0.7	<0.7	<0.7	<0.7	<0.7	-	-	-	-	<0.7	<0.7	<0.7	-	-	-	-	<0.7	<0.7	<0.7	30 ⁽¹⁾
IDS	NA	NA	NA	NA	NA	NA	1,000,000	NA	NA	NA	NA	NA	NA	3,800,000	-	-	-	-	-	-	24,000,000	-	-	-	-	-	-	18,000,000	3,000,000 ⁽⁴⁾

* = detection limit increased due to dilution necessary for quantitation
 NA = not analyzed
 - = not in place
 TRPH = total recoverable petroleum hydrocarbons
 < = less than the limit of detection
 800 = above regulatory guidelines
 800 = detected, but less than regulatory guidelines

(1) Maximum contaminant level (MCL) for drinking water standards (DHS)
 (2) California State Action Level (DHS)
 (3) Health Advisor or Suggested No-Adverse-Response Levels (EPA) (DHS)
 (4) State Water Resources guideline for potential drinking water sources
 Regulatory guidelines are taken from Jon B. Marshack's "A Compilation of Water Quality Goals, October 1990," published by Regional Water Quality Control Board Central Valley Region

APPENDIX G

CLAYTON LABORATORY ANALYTICAL RESULTS

1252 Quarry Lane
P.O. Box 9019
Pleasanton, CA 94566
(510) 426-2600
Fax (510) 426-0106

Clayton
ENVIRONMENTAL
CONSULTANTS

March 5, 1993

Mr. Dariush Dastmalchi
CLAYTON ENVIRONMENTAL CONSULTANTS, INC.
1252 Quarry Lane
Pleasanton, CA 94566

Client Ref. 45040.01
Clayton Project No. 93022.69

Dear Mr. Dastmalchi:

Attached is our analytical laboratory report for the samples received on February 23, 1993. A copy of the Chain-of-Custody form acknowledging receipt of these samples is attached.

Please note that any unused portion of the samples will be disposed of 30 days after the date of this report, unless you have requested otherwise.

We appreciate the opportunity to be of assistance to you. If you have any questions, please contact Suzanne Silvera, Client Services Supervisor, at (510) 426-2657.

Sincerely,

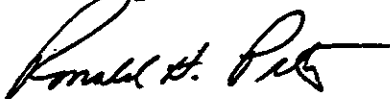

Ronald H. Peters, CIH
Director, Laboratory Services
Western Operations

RHP/tb
Attachments

Results of Analysis
for
Harsch Investments

Client Reference: 45040.01
Clayton Project No. 93022.69

Sample Identification: MW-7B	Date Sampled: 02/23/93
Lab Number: 9302269-01A	Date Received: 02/23/93
Sample Matrix/Media: WATER	Date Analyzed: 03/02/93
Analytical Method: EPA 601	

Analyte	CAS #	Concentration (ug/L)	Limit of Detection (ug/L)
<u>Purgeable Halocarbons</u>			
Chloromethane	74-87-3	ND	60
Bromomethane	74-83-9	ND	70
Vinyl chloride	75-01-4	ND	50
Chloroethane	75-00-3	ND	50
Methylene chloride	75-09-2	ND	200
1,1-Dichloroethene	75-35-4	ND	20
1,1-Dichloroethane	75-35-3	ND	40
Trans-1,2-Dichloroethene	156-60-5	ND	40
Cis-1,2-Dichloroethene	156-59-2	150	40
Chloroform	67-66-3	ND	50
1,2-Dichloroethane	107-06-2	ND	30
1,1,1-Trichloroethane	71-55-6	ND	50
Carbon tetrachloride	56-23-5	ND	60
Bromodichloromethane	75-27-4	ND	70
1,2-Dichloropropane	78-87-5	ND	50
Cis-1,3-Dichloropropene	10061-01-5	ND	50
Trichloroethene	79-01-6	540	30
Dibromochloromethane	124-48-1	ND	60
1,1,2-Trichloroethane	79-00-5	ND	60
Trans-1,3-Dichloropropene	10061-02-6	ND	60

ND Not detected at or above limit of detection
-- Information not available or not applicable

Note: Detection limits increased due to dilution necessary for quantitation

Results of Analysis
for
Harsch Investments

Client Reference: 45040.01
Clayton Project No. 93022.69

Sample Identification:	MW-7B	Date Sampled:	02/23/93
Lab Number:	9302269-01A	Date Received:	02/23/93
Sample Matrix/Media:	WATER	Date Analyzed:	03/02/93
Analytical Method:	EPA 601		

Analyte	CAS #	Concentration (ug/L)	Limit of Detection (ug/L)
<u>Purgeable Halocarbons (continued)</u>			
2-Chloroethylvinylether	110-75-8	ND	100
Bromoform	75-25-2	ND	70
Tetrachloroethene	127-18-4	5,800	50
1,1,2,2-Tetrachloroethane	79-34-5	ND	50
Chlorobenzene	108-90-7	ND	70
1,3-Dichlorobenzene	541-73-7	ND	200
1,2-Dichlorobenzene	95-50-1	ND	400
1,4-Dichlorobenzene	106-46-7	ND	400
Dichlorodifluoromethane	75-71-8	ND	100
Trichlorofluoromethane	75-69-4	ND	40
Freon 113	76-13-1	ND	60
<u>Surrogates</u>		<u>Recovery (%)</u>	<u>QC Limits (%)</u> LCL UCL
Bromochloromethane	74-97-5	90	50 - 150

ND Not detected at or above limit of detection
-- Information not available or not applicable

Note: Detection limits increased due to dilution necessary for quantitation

Results of Analysis
for
Harsch Investments

Client Reference: 45040.01
Clayton Project No. 93022.69

Sample Identification:	MW-8B	Date Sampled:	02/23/93
Lab Number:	9302269-02A	Date Received:	02/23/93
Sample Matrix/Media:	WATER	Date Analyzed:	02/25/93
Analytical Method:	EPA 601		

Analyte	CAS #	Concentration (ug/L)	Limit of Detection (ug/L)
<u>Purgeable Halocarbons</u>			
Chloromethane	74-87-3	ND	0.6
Bromomethane	74-83-9	ND	0.7
Vinyl chloride	75-01-4	ND	0.5
Chloroethane	75-00-3	ND	0.5
Methylene chloride	75-09-2	ND	2
1,1-Dichloroethene	75-35-4	ND	0.2
1,1-Dichloroethane	75-35-3	ND	0.4
Trans-1,2-Dichloroethene	156-60-5	ND	0.4
Cis-1,2-Dichloroethene	156-59-2	9.0	0.4
Chloroform	67-66-3	ND	0.5
1,2-Dichloroethane	107-06-2	ND	0.3
1,1,1-Trichloroethane	71-55-6	ND	0.5
Carbon tetrachloride	56-23-5	ND	0.6
Bromodichloromethane	75-27-4	ND	0.7
1,2-Dichloropropane	78-87-5	ND	0.5
Cis-1,3-Dichloropropene	10061-01-5	ND	0.5
Trichloroethene	79-01-6	14	0.3
Dibromochloromethane	124-48-1	ND	0.6
1,1,2-Trichloroethane	79-00-5	ND	0.6
Trans-1,3-Dichloropropene	10061-02-6	ND	0.6

ND Not detected at or above limit of detection
-- Information not available or not applicable

Results of Analysis
for
Harsch Investments

Client Reference: 45040.01
Clayton Project No. 93022.69

Sample Identification:	MW-8B	Date Sampled:	02/23/93
Lab Number:	9302269-02A	Date Received:	02/23/93
Sample Matrix/Media:	WATER	Date Analyzed:	02/25/93
Analytical Method:	EPA 601		

Analyte	CAS #	Concentration (ug/L)	Limit of Detection (ug/L)
<u>Purgeable Halocarbons (continued)</u>			
2-Chloroethylvinylether	110-75-8	ND	1
Bromoform	75-25-2	ND	0.7
Tetrachloroethene	127-18-4	5.0	0.5
1,1,2,2-Tetrachloroethane	79-34-5	ND	0.5
Chlorobenzene	108-90-7	ND	0.7
1,3-Dichlorobenzene	541-73-7	ND	2
1,2-Dichlorobenzene	95-50-1	ND	4
1,4-Dichlorobenzene	106-46-7	ND	4
Dichlorodifluoromethane	75-71-8	ND	1
Trichlorofluoromethane	75-69-4	ND	0.4
Freon 113	76-13-1	ND	0.6
<u>Surrogates</u>		<u>Recovery (%)</u>	<u>QC Limits (%)</u> LCL UCL
Bromochloromethane	74-97-5	104	50 - 150

ND Not detected at or above limit of detection
-- Information not available or not applicable

Results of Analysis
for
Harsch Investments

Client Reference: 45040.01
Clayton Project No. 93022.69

Sample Identification: MW-17	Date Sampled: 02/23/93
Lab Number: 9302269-03A	Date Received: 02/23/93
Sample Matrix/Media: WATER	Date Analyzed: 03/01/93
Analytical Method: EPA 601	

Analyte	CAS #	Concentration (ug/L)	Limit of Detection (ug/L)
<u>Purgeable Halocarbons</u>			
Chloromethane	74-87-3	ND	0.6
Bromomethane	74-83-9	ND	0.7
Vinyl chloride	75-01-4	ND	0.5
Chloroethane	75-00-3	ND	0.5
Methylene chloride	75-09-2	ND	2
1,1-Dichloroethene	75-35-4	ND	0.2
1,1-Dichloroethane	75-35-3	ND	0.4
Trans-1,2-Dichloroethene	156-60-5	ND	0.4
Cis-1,2-Dichloroethene	156-59-2	ND	0.4
Chloroform	67-66-3	ND	0.5
1,2-Dichloroethane	107-06-2	ND	0.3
1,1,1-Trichloroethane	71-55-6	ND	0.5
Carbon tetrachloride	56-23-5	ND	0.6
Bromodichloromethane	75-27-4	ND	0.7
1,2-Dichloropropane	78-87-5	ND	0.5
Cis-1,3-Dichloropropene	10061-01-5	ND	0.5
Trichloroethene	79-01-6	ND	0.3
Dibromochloromethane	124-48-1	ND	0.6
1,1,2-Trichloroethane	79-00-5	ND	0.6
Trans-1,3-Dichloropropene	10061-02-6	ND	0.6

ND Not detected at or above limit of detection
-- Information not available or not applicable

Results of Analysis
for
Harsch Investments

Client Reference: 45040.01
Clayton Project No. 93022.69

Sample Identification:	MW-17	Date Sampled:	02/23/93
Lab Number:	9302269-03A	Date Received:	02/23/93
Sample Matrix/Media:	WATER	Date Analyzed:	03/01/93
Analytical Method:	EPA 601		

Analyte	CAS #	Concentration (ug/L)	Limit of Detection (ug/L)
<u>Purgeable Halocarbons (continued)</u>			
2-Chloroethylvinylether	110-75-8	ND	1
Bromoform	75-25-2	ND	0.7
Tetrachloroethene	127-18-4	ND	0.5
1,1,2,2-Tetrachloroethane	79-34-5	ND	0.5
Chlorobenzene	108-90-7	ND	0.7
1,3-Dichlorobenzene	541-73-7	ND	2
1,2-Dichlorobenzene	95-50-1	ND	4
1,4-Dichlorobenzene	106-46-7	ND	4
Dichlorodifluoromethane	75-71-8	ND	1
Trichlorofluoromethane	75-69-4	ND	0.4
Freon 113	76-13-1	ND	0.6
<u>Surrogates</u>		<u>Recovery (%)</u>	<u>QC Limits (%)</u> LCL UCL
Bromochloromethane	74-97-5	93	50 - 150

ND Not detected at or above limit of detection
-- Information not available or not applicable

Results of Analysis
for
Harsch Investments

Client Reference: 45040.01
Clayton Project No. 93022.69

Sample Identification:	MW-18	Date Sampled:	02/23/93
Lab Number:	9302269-04A	Date Received:	02/23/93
Sample Matrix/Media:	WATER	Date Analyzed:	03/01/93
Analytical Method:	EPA 601		

Analyte	CAS #	Concentration (ug/L)	Limit of Detection (ug/L)
<u>Purgeable Halocarbons</u>			
Chloromethane	74-87-3	ND	0.6
Bromomethane	74-83-9	ND	0.7
Vinyl chloride	75-01-4	ND	0.5
Chloroethane	75-00-3	ND	0.5
Methylene chloride	75-09-2	ND	2
1,1-Dichloroethene	75-35-4	ND	0.2
1,1-Dichloroethane	75-35-3	ND	0.4
Trans-1,2-Dichloroethene	156-60-5	ND	0.4
Cis-1,2-Dichloroethene	156-59-2	ND	0.4
Chloroform	67-66-3	ND	0.5
1,2-Dichloroethane	107-06-2	ND	0.3
1,1,1-Trichloroethane	71-55-6	ND	0.5
Carbon tetrachloride	56-23-5	ND	0.6
Bromodichloromethane	75-27-4	ND	0.7
1,2-Dichloropropane	78-87-5	ND	0.5
Cis-1,3-Dichloropropene	10061-01-5	ND	0.5
Trichloroethene	79-01-6	ND	0.3
Dibromochloromethane	124-48-1	ND	0.6
1,1,2-Trichloroethane	79-00-5	ND	0.6
Trans-1,3-Dichloropropene	10061-02-6	ND	0.6

ND Not detected at or above limit of detection
-- Information not available or not applicable

Results of Analysis
for
Harsch Investments

Client Reference: 45040.01
Clayton Project No. 93022.69

Sample Identification: MW-18	Date Sampled: 02/23/93
Lab Number: 9302269-04A	Date Received: 02/23/93
Sample Matrix/Media: WATER	Date Analyzed: 03/01/93
Analytical Method: EPA 601	

Analyte	CAS #	Concentration (ug/L)	Limit of Detection (ug/L)
<u>Purgeable Halocarbons (continued)</u>			
2-Chloroethylvinylether	110-75-8	ND	1
Bromoform	75-25-2	ND	0.7
Tetrachloroethene	127-18-4	ND	0.5
1,1,2,2-Tetrachloroethane	79-34-5	ND	0.5
Chlorobenzene	108-90-7	ND	0.7
1,3-Dichlorobenzene	541-73-7	ND	2
1,2-Dichlorobenzene	95-50-1	ND	4
1,4-Dichlorobenzene	106-46-7	ND	4
Dichlorodifluoromethane	75-71-8	ND	1
Trichlorofluoromethane	75-69-4	ND	0.4
Freon 113	76-13-1	ND	0.6
<u>Surrogates</u>		<u>Recovery (%)</u>	<u>QC Limits (%)</u> LCL UCL
Bromochloromethane	74-97-5	97	50 - 150

ND Not detected at or above limit of detection
-- Information not available or not applicable

Results of Analysis
for
Harsch Investments

Client Reference: 45040.01
Clayton Project No. 93022.69

Sample Identification: METHOD BLANK
Lab Number: 9302269-06A
Sample Matrix/Media: WATER
Analytical Method: EPA 601

Date Sampled: --
Date Received: --
Date Analyzed: 02/25/93

Analyte	CAS #	Concentration (ug/L)	Limit of Detection (ug/L)
<u>Purgeable Halocarbons</u>			
Chloromethane	74-87-3	ND	0.6
Bromomethane	74-83-9	ND	0.7
Vinyl chloride	75-01-4	ND	0.5
Chloroethane	75-00-3	ND	0.5
Methylene chloride	75-09-2	ND	2
1,1-Dichloroethene	75-35-4	ND	0.2
1,1-Dichloroethane	75-35-3	ND	0.4
Trans-1,2-Dichloroethene	156-60-5	ND	0.4
Cis-1,2-Dichloroethene	156-59-2	ND	0.4
Chloroform	67-66-3	ND	0.5
1,2-Dichloroethane	107-06-2	ND	0.3
1,1,1-Trichloroethane	71-55-6	ND	0.5
Carbon tetrachloride	56-23-5	ND	0.6
Bromodichloromethane	75-27-4	ND	0.7
1,2-Dichloropropane	78-87-5	ND	0.5
Cis-1,3-Dichloropropene	10061-01-5	ND	0.5
Trichloroethene	79-01-6	ND	0.3
Dibromochloromethane	124-48-1	ND	0.6
1,1,2-Trichloroethane	79-00-5	ND	0.6
Trans-1,3-Dichloropropene	10061-02-6	ND	0.6

ND Not detected at or above limit of detection
-- Information not available or not applicable

Results of Analysis
for
Harsch Investments

Client Reference: 45040.01
Clayton Project No. 93022.69

Sample Matrix/Media: WATER
Analysis Method: EPA 160.1

Date Received: 02/23/93
Date Analyzed: 03/04/93

Lab Number	Sample Identification	Date Sampled	Total Dissolved Solids (mg/L)	Detection Limit (mg/L)
01C	MW-7B	02/23/93	1,100	10
02C	MW-8B	02/23/93	930	10
03C	MW-17	02/23/93	18,000	10
04C	MW-18	02/23/93	19,000	10
06A	METHOD BLANK	--	<10	10

ND Not detected at or above limit of detection
< Not detected at or above limit of detection
-- Information not available or not applicable

Clayton

ENVIRONMENTAL
CONSULTANTS

A Marsh & McLennan Company

REQUEST FOR LABORATORY ANALYTICAL SERVICES

For Clayton Use Only Page 1 of 1

Project No. 45040.01

Batch No. 9302269

Ind. Code _____ W.P. _____

Date Logged In 2/24/93 By TS

REPORT RESULTS TO	Name <u>D. DALSIMACHI</u>		Title _____		Purchase Order No. _____		Client Job No. _____																																																																																																			
	Company <u>CCC</u>		Dept. <u>EE</u>		Name _____		Dept. _____																																																																																																			
	Mailing Address _____				Company <u>HARSCO</u>																																																																																																					
	City, State, Zip _____				Address _____																																																																																																					
Telephone No. _____		Telefax No. _____		City, State, Zip <u>ALAMEDA</u>																																																																																																						
Date Results Req.: <u>STANDARD</u>		Rush Charges Authorized? <input type="checkbox"/> Yes <input checked="" type="checkbox"/> No		Phone / Fax Results <input type="checkbox"/> <input type="checkbox"/>		ANALYSIS REQUESTED (Enter an 'X' in the box below to indicate request; Enter a 'P' if Preservative added.)																																																																																																				
Special Instructions: (method, limit of detection, etc.) _____				Samples are: (check if applicable) <input type="checkbox"/> Drinking Water <input type="checkbox"/> Collected in the State of New York		<table border="1"> <thead> <tr> <th rowspan="2">Number of Containers</th> <th colspan="7">ANALYSIS REQUESTED</th> <th rowspan="2">FOR LAB USE ONLY</th> </tr> <tr> <th>WOL</th> <th>TDS</th> <th>HOLD</th> <th></th> <th></th> <th></th> <th></th> </tr> </thead> <tbody> <tr> <td>MW-7B</td> <td>2</td> <td>X</td> <td></td> <td></td> <td></td> <td></td> <td></td> <td>01A,B</td> </tr> <tr> <td></td> <td>1</td> <td></td> <td>X</td> <td></td> <td></td> <td></td> <td></td> <td>N.C.</td> </tr> <tr> <td>MW-8B</td> <td>2</td> <td>X</td> <td></td> <td></td> <td></td> <td></td> <td></td> <td>02A,B</td> </tr> <tr> <td></td> <td>1</td> <td></td> <td>X</td> <td></td> <td></td> <td></td> <td></td> <td>N.C.</td> </tr> <tr> <td>MW-17</td> <td>2</td> <td>X</td> <td></td> <td></td> <td></td> <td></td> <td></td> <td>03A,B</td> </tr> <tr> <td></td> <td>1</td> <td></td> <td>X</td> <td></td> <td></td> <td></td> <td></td> <td>N.C.</td> </tr> <tr> <td>MW-18</td> <td>2</td> <td>X</td> <td></td> <td></td> <td></td> <td></td> <td></td> <td>04A,B</td> </tr> <tr> <td></td> <td>1</td> <td></td> <td>X</td> <td></td> <td></td> <td></td> <td></td> <td>C</td> </tr> <tr> <td>TRIP BLANKS (0012693)</td> <td>2</td> <td></td> <td></td> <td>X</td> <td></td> <td></td> <td></td> <td>05A,B</td> </tr> </tbody> </table>				Number of Containers	ANALYSIS REQUESTED							FOR LAB USE ONLY	WOL	TDS	HOLD					MW-7B	2	X						01A,B		1		X					N.C.	MW-8B	2	X						02A,B		1		X					N.C.	MW-17	2	X						03A,B		1		X					N.C.	MW-18	2	X						04A,B		1		X					C	TRIP BLANKS (0012693)	2			X				05A,B
Number of Containers	ANALYSIS REQUESTED										FOR LAB USE ONLY																																																																																															
	WOL	TDS	HOLD																																																																																																							
MW-7B	2	X						01A,B																																																																																																		
	1		X					N.C.																																																																																																		
MW-8B	2	X						02A,B																																																																																																		
	1		X					N.C.																																																																																																		
MW-17	2	X						03A,B																																																																																																		
	1		X					N.C.																																																																																																		
MW-18	2	X						04A,B																																																																																																		
	1		X					C																																																																																																		
TRIP BLANKS (0012693)	2			X				05A,B																																																																																																		
CLIENT SAMPLE IDENTIFICATION				DATE SAMPLED	MATRIX/MEDIA	AIR VOLUME (specify units)																																																																																																				
MW-7B				2-27-93	H ₂ O	40ML	2	X																																																																																																		
				"	"	236ml PI	1		X																																																																																																	
MW-8B				"	"	40 ML	2	X																																																																																																		
				"	"	236ml PI	1		X																																																																																																	
MW-17				"	"	40 ML	2	X																																																																																																		
				"	"	236ml PI	1		X																																																																																																	
MW-18				"	"	40ml	2	X																																																																																																		
				"	"	236ml PI	1		X																																																																																																	
TRIP BLANKS (0012693)						40ML	2			X																																																																																																

CHAIN OF CUSTODY	Collected by: <u>G WILLIAMS</u> (print)	Collector's Signature: <u>[Signature]</u>
	Relinquished by: <u>G WILLIAMS</u>	Date/Time: <u>2-23-93 1730</u>
	Relinquished by: _____	Date/Time: _____
	Method of Shipment: _____	Date/Time: <u>2/23/93 6:55:30pm</u>
Authorized by: _____ Date: _____ (Client Signature <u>Must</u> Accompany Request)		Received by: <u>[Signature]</u>
		Received at Lab by: <u>[Signature]</u>
		Sample Condition Upon Receipt: <input checked="" type="checkbox"/> Acceptable <input type="checkbox"/> Other (explain)

Please return completed form and samples to one of the Clayton Environmental Consultants, Inc. labs listed below:

22345 Roethel Drive Raritan Center 400 Chastain Center Blvd., N.W. 1252 Quarry Lane
Novi, MI 48375 160 Fieldcrest Ave. Suite 490 Pleasanton, CA 94566

DISTRIBUTION:
WHITE - Clayton Laboratory
YELLOW - Clayton Accounting

1252 Quarry Lane
P.O. Box 9019
Pleasanton, CA 94566
(510) 426-2600
Fax (510) 426-0106

Clayton
ENVIRONMENTAL
CONSULTANTS

March 9, 1993

Mr. Dariush Dastmalchi
CLAYTON ENVIRONMENTAL CONSULTANTS, INC.
1252 Quarry Lane
Pleasanton, CA 94566

Client Ref. 45040.06
Clayton Project No. 93022.92

Dear Mr. Dastmalchi:

Attached is our analytical laboratory report for the samples received on February 25, 1993. A copy of the Chain-of-Custody form acknowledging receipt of these samples is attached.

Please note that any unused portion of the samples will be disposed of 30 days after the date of this report, unless you have requested otherwise.

We appreciate the opportunity to be of assistance to you. If you have any questions, please contact Suzanne Silvera, Client Services Supervisor, at (510) 426-2657.

Sincerely,

Ronald H. Peters for

Ronald H. Peters, CIH
Director, Laboratory Services
Western Operations

RHP/caa
Attachments

Results of Analysis
for
Harsch Investments

Client Reference: 45040.06
Clayton Project No. 93022.92

Sample Identification:	MW-22	Date Sampled:	02/25/93
Lab Number:	9302292-01A	Date Received:	02/25/93
Sample Matrix/Media:	WATER	Date Prepared:	03/01/93
Preparation Method:	EPA 5030	Date Analyzed:	03/01/93
Analytical Method:	EPA 8015/8020		

Analyte	CAS #	Concentration (ug/L)	Limit of Detection (ug/L)
<u>BTEX/Gasoline</u>			
Benzene	71-43-2	ND	0.4
Toluene	108-88-3	ND	0.3
Ethylbenzene	100-41-4	ND	0.3
p,m-Xylenes	--	ND	0.4
o-Xylene	95-47-6	ND	0.4
Gasoline	--	ND	50
<u>Surrogates</u>		<u>Recovery (%)</u>	<u>QC Limits (%)</u>
a,a,a-Trifluorotoluene	98-08-8	109	50 - 150

ND: Not detected at or above limit of detection
--: Information not available or not applicable

Results of Analysis
for
Harsch Investments

Client Reference: 45040.06
Clayton Project No. 93022.92

Sample Identification:	MW-5B	Date Sampled:	02/25/93
Lab Number:	9302292-02A	Date Received:	02/25/93
Sample Matrix/Media:	WATER	Date Prepared:	03/01/93
Preparation Method:	EPA 5030	Date Analyzed:	03/01/93
Analytical Method:	EPA 8015/8020		

Analyte	CAS #	Concentration (ug/L)	Limit of Detection (ug/L)
<u>BTEX/Gasoline</u>			
Benzene	71-43-2	210	0.4
Toluene	108-88-3	4.2	0.3
Ethylbenzene	100-41-4	1.9	0.3
p,m-Xylenes	--	1.4	0.4
o-Xylene	95-47-6	0.6	0.4
Gasoline	--	640	50
<u>Surrogates</u>		<u>Recovery (%)</u>	<u>QC Limits (%)</u>
a,a,a-Trifluorotoluene	98-08-8	122	50 - 150

ND: Not detected at or above limit of detection
--: Information not available or not applicable

Results of Analysis
for
Harsch Investments

Client Reference: 45040.06
Clayton Project No. 93022.92

Sample Identification:	METHOD BLANK	Date Sampled:	--
Lab Number:	9302292-06A	Date Received:	--
Sample Matrix/Media:	WATER	Date Prepared:	03/01/93
Preparation Method:	EPA 5030	Date Analyzed:	03/01/93
Analytical Method:	EPA 8015/8020		

Analyte	CAS #	Concentration (ug/L)	Limit of Detection (ug/L)
<u>BTEX/Gasoline</u>			
Benzene	71-43-2	ND	0.4
Toluene	108-88-3	ND	0.3
Ethylbenzene	100-41-4	ND	0.3
p,m-Xylenes	--	ND	0.4
o-Xylene	95-47-6	ND	0.4
Gasoline	--	ND	50
<u>Surrogates</u>		<u>Recovery (%)</u>	<u>QC Limits (%)</u>
a,a,a-Trifluorotoluene	98-08-8	111	50 - 150

ND: Not detected at or above limit of detection
--: Information not available or not applicable

Results of Analysis
for
Harsch Investments

Client Reference: 45040.06
Clayton Project No. 93022.92

Sample Identification:	MW-22	Date Sampled:	02/25/93
Lab Number:	9302292-01E	Date Received:	02/25/93
Sample Matrix/Media:	WATER	Date Analyzed:	03/01/93
Analytical Method:	EPA 601		

Analyte	CAS #	Concentration (ug/L)	Limit of Detection (ug/L)
<u>Purgeable Halocarbons</u>			
Chloromethane	74-87-3	ND	0.6
Bromomethane	74-83-9	ND	0.7
Vinyl chloride	75-01-4	ND	0.5
Chloroethane	75-00-3	ND	0.5
Methylene chloride	75-09-2	ND	2
1,1-Dichloroethene	75-35-4	ND	0.2
1,1-Dichloroethane	75-35-3	ND	0.4
Trans-1,2-Dichloroethene	156-60-5	ND	0.4
Cis-1,2-Dichloroethene	156-59-2	ND	0.4
Chloroform	67-66-3	ND	0.5
1,2-Dichloroethane	107-06-2	22	0.3
1,1,1-Trichloroethane	71-55-6	ND	0.5
Carbon tetrachloride	56-23-5	ND	0.6
Bromodichloromethane	75-27-4	ND	0.7
1,2-Dichloropropane	78-87-5	ND	0.5
Cis-1,3-Dichloropropene	10061-01-5	ND	0.5
Trichloroethene	79-01-6	ND	0.3
Dibromochloromethane	124-48-1	ND	0.6
1,1,2-Trichloroethane	79-00-5	ND	0.6
Trans-1,3-Dichloropropene	10061-02-6	ND	0.6

ND Not detected at or above limit of detection
-- Information not available or not applicable

Results of Analysis
for
Harsch Investments

Client Reference: 45040.06
Clayton Project No. 93022.92

Sample Identification: MW-22	Date Sampled: 02/25/93
Lab Number: 9302292-01E	Date Received: 02/25/93
Sample Matrix/Media: WATER	Date Analyzed: 03/01/93
Analytical Method: EPA 601	

Analyte	CAS #	Concentration (ug/L)	Limit of Detection (ug/L)
<u>Purgeable Halocarbons (continued)</u>			
2-Chloroethylvinylether	110-75-8	ND	1
Bromoform	75-25-2	ND	0.7
Tetrachloroethene	127-18-4	ND	0.5
1,1,2,2-Tetrachloroethane	79-34-5	ND	0.5
Chlorobenzene	108-90-7	ND	0.7
1,3-Dichlorobenzene	541-73-7	ND	2
1,2-Dichlorobenzene	95-50-1	ND	4
1,4-Dichlorobenzene	106-46-7	ND	4
Dichlorodifluoromethane	75-71-8	ND	1
Trichlorofluoromethane	75-69-4	ND	0.4
Freon 113	76-13-1	ND	0.6
<u>Surrogates</u>		<u>Recovery (%)</u>	<u>QC Limits (%)</u> LCL UCL
Bromochloromethane	74-97-5	102	50 - 150

ND Not detected at or above limit of detection
-- Information not available or not applicable

Results of Analysis
for
Harsch Investments

Client Reference: 45040.06
Clayton Project No. 93022.92

Sample Identification: MW-5B	Date Sampled: 02/25/93
Lab Number: 9302292-02E	Date Received: 02/25/93
Sample Matrix/Media: WATER	Date Analyzed: 03/01/93
Analytical Method: EPA 601	

Analyte	CAS #	Concentration (ug/L)	Limit of Detection (ug/L)
<u>Purgeable Halocarbons</u>			
Chloromethane	74-87-3	ND	0.6
Bromomethane	74-83-9	ND	0.7
Vinyl chloride	75-01-4	ND	0.5
Chloroethane	75-00-3	ND	0.5
Methylene chloride	75-09-2	ND	2
1,1-Dichloroethene	75-35-4	ND	0.2
1,1-Dichloroethane	75-35-3	ND	0.4
Trans-1,2-Dichloroethene	156-60-5	ND	0.4
Cis-1,2-Dichloroethene	156-59-2	5.0	0.4
Chloroform	67-66-3	ND	0.5
1,2-Dichloroethane	107-06-2	0.4	0.3
1,1,1-Trichloroethane	71-55-6	ND	0.5
Carbon tetrachloride	56-23-5	ND	0.6
Bromodichloromethane	75-27-4	ND	0.7
1,2-Dichloropropane	78-87-5	ND	0.5
Cis-1,3-Dichloropropene	10061-01-5	ND	0.5
Trichloroethene	79-01-6	3.4	0.3
Dibromochloromethane	124-48-1	ND	0.6
1,1,2-Trichloroethane	79-00-5	ND	0.6
Trans-1,3-Dichloropropene	10061-02-6	ND	0.6

ND Not detected at or above limit of detection

-- Information not available or not applicable

Results of Analysis
for
Harsch Investments

Client Reference: 45040.06
Clayton Project No. 93022.92

Sample Identification: MW-5B	Date Sampled: 02/25/93
Lab Number: 9302292-02E	Date Received: 02/25/93
Sample Matrix/Media: WATER	Date Analyzed: 03/01/93
Analytical Method: EPA 601	

Analyte	CAS #	Concentration (ug/L)	Limit of Detection (ug/L)
<u>Purgeable Halocarbons (continued)</u>			
2-Chloroethylvinylether	110-75-8	ND	1
Bromoform	75-25-2	ND	0.7
Tetrachloroethene	127-18-4	ND	0.5
1,1,2,2-Tetrachloroethane	79-34-5	ND	0.5
Chlorobenzene	108-90-7	ND	0.7
1,3-Dichlorobenzene	541-73-7	ND	2
1,2-Dichlorobenzene	95-50-1	ND	4
1,4-Dichlorobenzene	106-46-7	ND	4
Dichlorodifluoromethane	75-71-8	ND	1
Trichlorofluoromethane	75-69-4	ND	0.4
Freon 113	76-13-1	ND	0.6
<u>Surrogates</u>		<u>Recovery (%)</u>	<u>QC Limits (%)</u> LCL UCL
Bromochloromethane	74-97-5	80	50 - 150

ND Not detected at or above limit of detection
-- Information not available or not applicable

Results of Analysis
for
Harsch Investments

Client Reference: 45040.06
Clayton Project No. 93022.92

Sample Identification:	MW-11	Date Sampled:	02/25/93
Lab Number:	9302292-03A	Date Received:	02/25/93
Sample Matrix/Media:	WATER	Date Analyzed:	03/01/93
Analytical Method:	EPA 601		

Analyte	CAS #	Concentration (ug/L)	Limit of Detection (ug/L)
<u>Purgeable Halocarbons</u>			
Chloromethane	74-87-3	ND	0.6
Bromomethane	74-83-9	ND	0.7
Vinyl chloride	75-01-4	ND	0.5
Chloroethane	75-00-3	ND	0.5
Methylene chloride	75-09-2	ND	2
1,1-Dichloroethene	75-35-4	ND	0.2
1,1-Dichloroethane	75-35-3	ND	0.4
Trans-1,2-Dichloroethene	156-60-5	ND	0.4
Cis-1,2-Dichloroethene	156-59-2	ND	0.4
Chloroform	67-66-3	ND	0.5
1,2-Dichloroethane	107-06-2	ND	0.3
1,1,1-Trichloroethane	71-55-6	ND	0.5
Carbon tetrachloride	56-23-5	ND	0.6
Bromodichloromethane	75-27-4	ND	0.7
1,2-Dichloropropane	78-87-5	ND	0.5
Cis-1,3-Dichloropropene	10061-01-5	ND	0.5
Trichloroethene	79-01-6	2.0	0.3
Dibromochloromethane	124-48-1	ND	0.6
1,1,2-Trichloroethane	79-00-5	ND	0.6
Trans-1,3-Dichloropropene	10061-02-6	ND	0.6

ND Not detected at or above limit of detection
-- Information not available or not applicable

Results of Analysis
for
Harsch Investments

Client Reference: 45040.06
Clayton Project No. 93022.92

Sample Identification: MW-11	Date Sampled: 02/25/93
Lab Number: 9302292-03A	Date Received: 02/25/93
Sample Matrix/Media: WATER	Date Analyzed: 03/01/93
Analytical Method: EPA 601	

Analyte	CAS #	Concentration (ug/L)	Limit of Detection (ug/L)
<u>Purgeable Halocarbons (continued)</u>			
2-Chloroethylvinylether	110-75-8	ND	1
Bromoform	75-25-2	ND	0.7
Tetrachloroethene	127-18-4	5.8	0.5
1,1,2,2-Tetrachloroethane	79-34-5	ND	0.5
Chlorobenzene	108-90-7	ND	0.7
1,3-Dichlorobenzene	541-73-7	ND	2
1,2-Dichlorobenzene	95-50-1	ND	4
1,4-Dichlorobenzene	106-46-7	ND	4
Dichlorodifluoromethane	75-71-8	ND	1
Trichlorofluoromethane	75-69-4	ND	0.4
Freon 113	76-13-1	ND	0.6
<u>Surrogates</u>		<u>Recovery (%)</u>	<u>QC Limits (%)</u> LCL UCL
Bromochloromethane	74-97-5	108	50 - 150

ND Not detected at or above limit of detection
-- Information not available or not applicable

Results of Analysis
for
Harsch Investments

Client Reference: 45040.06
Clayton Project No. 93022.92

Sample Identification: METHOD BLANK	Date Sampled: --
Lab Number: 9302292-06A	Date Received: --
Sample Matrix/Media: WATER	Date Analyzed: 03/01/93
Analytical Method: EPA 601	

Analyte	CAS #	Concentration (ug/L)	Limit of Detection (ug/L)
<u>Purgeable Halocarbons</u>			
Chloromethane	74-87-3	ND	0.6
Bromomethane	74-83-9	ND	0.7
Vinyl chloride	75-01-4	ND	0.5
Chloroethane	75-00-3	ND	0.5
Methylene chloride	75-09-2	ND	2
1,1-Dichloroethene	75-35-4	ND	0.2
1,1-Dichloroethane	75-35-3	ND	0.4
Trans-1,2-Dichloroethene	156-60-5	ND	0.4
Cis-1,2-Dichloroethene	156-59-2	ND	0.4
Chloroform	67-66-3	ND	0.5
1,2-Dichloroethane	107-06-2	ND	0.3
1,1,1-Trichloroethane	71-55-6	ND	0.5
Carbon tetrachloride	56-23-5	ND	0.6
Bromodichloromethane	75-27-4	ND	0.7
1,2-Dichloropropane	78-87-5	ND	0.5
Cis-1,3-Dichloropropene	10061-01-5	ND	0.5
Trichloroethene	79-01-6	ND	0.3
Dibromochloromethane	124-48-1	ND	0.6
1,1,2-Trichloroethane	79-00-5	ND	0.6
Trans-1,3-Dichloropropene	10061-02-6	ND	0.6

ND Not detected at or above limit of detection
-- Information not available or not applicable

Results of Analysis
for
Harsch Investments

Client Reference: 45040.06
Clayton Project No. 93022.92

Sample Identification: METHOD BLANK	Date Sampled: --
Lab Number: 9302292-06A	Date Received: --
Sample Matrix/Media: WATER	Date Analyzed: 03/01/93
Analytical Method: EPA 601	

Analyte	CAS #	Concentration (ug/L)	Limit of Detection (ug/L)
<u>Purgeable Halocarbons (continued)</u>			
2-Chloroethylvinylether	110-75-8	ND	1
Bromoform	75-25-2	ND	0.7
Tetrachloroethene	127-18-4	ND	0.5
1,1,2,2-Tetrachloroethane	79-34-5	ND	0.5
Chlorobenzene	108-90-7	ND	0.7
1,3-Dichlorobenzene	541-73-7	ND	2
1,2-Dichlorobenzene	95-50-1	ND	4
1,4-Dichlorobenzene	106-46-7	ND	4
Dichlorodifluoromethane	75-71-8	ND	1
Trichlorofluoromethane	75-69-4	ND	0.4
Freon 113	76-13-1	ND	0.6
<u>Surrogates</u>		<u>Recovery (%)</u>	<u>QC Limits (%)</u> LCL UCL
Bromochloromethane	74-97-5	95	50 - 150

ND Not detected at or above limit of detection
-- Information not available or not applicable

Results of Analysis
for
Harsch Investments

Client Reference: 45040.06
Clayton Project No. 93022.92

Sample Matrix/Media: WATER
Analysis Method: EPA 160.1

Date Received: 02/25/93
Date Analyzed: 03/05/93

Lab Number	Sample Identification	Date Sampled	Total Dissolved Solids (mg/L)	Detect. Limit (mg/)
01G	MW-22	02/25/93	2,100	1
02G	MW-5B	02/25/93	1,400	1
03C	MW-11	02/25/93	630	1
06A	METHOD BLANK	--	<10	1

ND Not detected at or above limit of detection
< Not detected at or above limit of detection
-- Information not available or not applicable

Results of Analysis
for
Harsch Investments

Client Reference: 45040.06
Clayton Project No. 93022.92

Sample Matrix/Media: WATER
Preparation Method: EPA 3510
Analysis Method: EPA 8015

Date Received: 02/25/93
Date Prepared: 02/26/93
Date Analyzed: 03/01/93

Lab Number	Sample Identification	Date Sampled	Diesel (ug/L)	Detection Limit (ug/L)
01C	MW-22	02/25/93	120 a	50
02C	MW-5B	02/25/93	2,400 a	50
06A	METHOD BLANK	--	ND	50

ND Not detected at or above limit of detection
< Not detected at or above limit of detection
-- Information not available or not applicable

a The hydrocarbons detected in these samples appear to be intermediate between diesel and motor oil: quantitation was based on diesel standards

Clayton

ENVIRONMENTAL
CONSULTANTS

A Marsh & McLennan Company

REQUEST FOR LABORATORY ANALYTICAL SERVICES

For Clayton Use Only Page 1 of 1

Project No. 45840.06

Batch No. 9.302292

Ind. Code _____ W.P. _____

Date Logged In 2/25/93 By T. ALTON

REPORT RESULTS TO	Name <u>D. DASTMAGH</u>	Title _____	PURCHASE ORDER No. _____	CLIENT JOB No. _____
	Company <u>CFC</u>	Dept. <u>EE</u>		
	Mailing Address _____			
	City, State, Zip _____			
	Telephone No. _____	Telefax No. _____		
SEND INVOICE TO	Name _____			
	Company <u>MARSH</u>	Dept. _____		
	Address _____			
	City, State, Zip <u>FLAMING</u>			

Date Results Req. STANDARD Rush Charges Authorized? Yes No Phone / Fax Results

Special Instructions: (method, limit of detection, etc.) _____

* Explanation of Preservative: H₂O ON BTEX + DIESEL

Samples are: (check if applicable)
 Drinking Water
 Collected in the State of New York

ANALYSIS REQUESTED (Enter an 'X' in the box below to indicate request; Enter a 'P' if Preservative added. *)

CLIENT SAMPLE IDENTIFICATION	DATE SAMPLED	MATRIX/MEDIA	AIR VOLUME (specify units)	Number of Containers	ANALYSIS REQUESTED										FOR LAB USE ONLY				
MW-22	2-25-93	H ₂ O	40ML	2	X														O1A,B
"	"	"	1 LITER	2		X													I,C,D
"	"	"	40ML	2			X												E,F
"	"	"	100ML	1				X											G
MW-5B	"	"	40ML	2	X														O2A,B
"	"	"	1 LITER	2		X													I,C,D
"	"	"	40ML	2			X												E,F
"	"	"	100ML	1				X											G
MW-11	"	"	40ML	2			X												O3A,B
"	"	"	100ML	1				X											I,C

Collected by: G WILLIAMS (print) Collector's Signature: [Signature] * O1A,B
O2A,B
O3A,B

Relinquished by: G WILLIAMS Date/Time 2-25-93 1630 Received by: _____ Date/Time _____

Relinquished by: _____ Date/Time _____ Received at Lab by: Stammy Cotton Date/Time 2/25/93 4:30pm

Method of Shipment: _____ Sample Condition Upon Receipt: Acceptable Other (explain) _____

Authorized by: _____ Date _____

(Client Signature Must Accompany Request)

TRIP BLANKS - O1A,B - 0020593 H₂O
 O5A,B - 0020593

1252 Quarry Lane
P.O. Box 9019
Pleasanton, CA 94566
(510) 426-2600
Fax (510) 426-0106

Clayton
ENVIRONMENTAL
CONSULTANTS

February 26, 1993

Mr. Dariush Dastmalchi
CLAYTON ENVIRONMENTAL CONSULTANTS, INC.
1252 Quarry Lane
Pleasanton, CA 94566

Client Ref. 45040.04
Clayton Project No. 93021.90

Dear Mr. Dastmalchi:

Attached is our analytical laboratory report for the samples received on February 16, 1993. A copy of the Chain-of-Custody form acknowledging receipt of these samples is attached.

Please note that any unused portion of the samples will be disposed of 30 days after the date of this report, unless you have requested otherwise.

We appreciate the opportunity to be of assistance to you. If you have any questions, please contact Suzanne Silvera, Client Services Supervisor, at (510) 426-2657.

Sincerely,



Ronald H. Peters, CIH
Director, Laboratory Services
Western Operations

RHP/tb
Attachments

Results of Analysis
 for
 Clayton Environmental Consultants, Inc.

Client Reference: 45040.04
 Clayton Project No. 93021.90

Sample Identification:	MW-22-8.5	Date Sampled:	02/16/93
Lab Number:	9302190-01A	Date Received:	02/16/93
Sample Matrix/Media:	SOIL	Date Prepared:	02/18/93
Preparation Method:	EPA 5030	Date Analyzed:	02/23/93
Analytical Method:	EPA 8015/8020		

Analyte	CAS #	Concentration (mg/kg)	Limit of Detection (mg/kg)
<u>BTEX/Gasoline</u>			
Benzene	71-43-2	ND	0.005
Toluene	108-88-3	0.007	0.005
Ethylbenzene	100-41-4	ND	0.005
p,m-Xylenes	--	ND	0.005
o-Xylene	95-47-6	ND	0.005
Gasoline	--	ND	0.3
<u>Surrogates</u>		<u>Recovery (%)</u>	<u>QC Limits (%)</u> LCL UCL
a,a,a-Trifluorotoluene	98-08-8	91	50 - 150

ND Not detected at or above limit of detection
 -- Information not available or not applicable
 Results are reported on a wet weight basis, as received

**Results of Analysis
for
Clayton Environmental Consultants, Inc.**

Client Reference: 45040.04
Clayton Project No. 93021.90

Sample Identification: MW-23-4.5	Date Sampled: 02/16/93
Lab Number: 9302190-02A	Date Received: 02/16/93
Sample Matrix/Media: SOIL	Date Prepared: 02/18/93
Preparation Method: EPA 5030	Date Analyzed: 02/23/93
Analytical Method: EPA 8015/8020	

Analyte	CAS #	Concentration (mg/kg)	Limit of Detection (mg/kg)
<u>BTEX/Gasoline</u>			
Benzene	71-43-2	ND	0.005
Toluene	108-88-3	ND	0.005
Ethylbenzene	100-41-4	ND	0.005
p,m-Xylenes	--	ND	0.005
o-Xylene	95-47-6	ND	0.005
Gasoline	--	ND	0.3
<u>Surrogates</u>		<u>Recovery (%)</u>	<u>QC Limits (%)</u> LCL UCL
a,a,a-Trifluorotoluene	98-08-8	90	50 - 150

ND Not detected at or above limit of detection
 -- Information not available or not applicable
 Results are reported on a wet weight basis, as received

Results of Analysis
for
Clayton Environmental Consultants, Inc.

Client Reference: 45040.04
Clayton Project No. 93021.90

Sample Identification:	METHOD BLANK	Date Sampled:	--
Lab Number:	9302190-03A	Date Received:	--
Sample Matrix/Media:	SOIL	Date Prepared:	02/18/93
Preparation Method:	EPA 5030	Date Analyzed:	02/23/93
Analytical Method:	EPA 8015/8020		

Analyte	CAS #	Concentration (mg/kg)	Limit of Detection (mg/kg)
<u>BTEX/Gasoline</u>			
Benzene	71-43-2	ND	0.005
Toluene	108-88-3	ND	0.005
Ethylbenzene	100-41-4	ND	0.005
p,m-Xylenes	--	ND	0.005
o-Xylene	95-47-6	ND	0.005
Gasoline	--	ND	0.3
<u>Surrogates</u>		<u>Recovery (%)</u>	<u>QC Limits (%)</u> LCL UCL
a,a,a-Trifluorotoluene	98-08-8	103	50 - 150

ND Not detected at or above limit of detection
 -- Information not available or not applicable
 Results are reported on a wet weight basis, as received

Results of Analysis
for
Clayton Environmental Consultants, Inc.

Client Reference: 45040.04
Clayton Project No. 93021.90

Sample Identification:	MW-23-4.5	Date Sampled:	02/16/93
Lab Number:	9302190-02A	Date Received:	02/16/93
Sample Matrix/Media:	SOIL	Date Prepared:	02/18/93
Preparation Method:	EPA 5030	Date Analyzed:	02/23/93
Analytical Method:	EPA 8010		

Analyte	CAS #	Concentration (mg/kg)	Limit of Detection (mg/kg)
<u>Purgeable Halocarbons</u>			
Chloromethane	74-87-3	ND	0.06
Bromomethane	74-83-9	ND	0.07
Vinyl chloride	75-01-4	ND	0.05
Chloroethane	75-00-3	ND	0.05
Methylene chloride	75-09-2	ND	0.2
1,1-Dichloroethene	75-35-4	ND	0.03
1,1-Dichloroethane	75-35-3	ND	0.04
Trans-1,2-Dichloroethene	156-60-5	ND	0.04
Cis-1,2-Dichloroethene	156-59-2	ND	0.04
Chloroform	67-66-3	ND	0.05
1,2-Dichloroethane	107-06-2	ND	0.03
1,1,1-Trichloroethane	71-55-6	ND	0.05
Carbon tetrachloride	56-23-5	ND	0.06
Bromodichloromethane	75-27-4	ND	0.07
1,2-Dichloropropane	78-87-5	ND	0.05
Cis-1,3-Dichloropropene	10061-01-5	ND	0.05
Trichloroethene	79-01-6	ND	0.03
Dibromochloromethane	124-48-1	ND	0.06
1,1,2-Trichloroethane	79-00-5	ND	0.06
Trans-1,3-Dichloropropene	10061-02-6	ND	0.06

ND Not detected at or above limit of detection
 -- Information not available or not applicable
 Results are reported on a wet weight basis, as received

**Results of Analysis
for
Clayton Environmental Consultants, Inc.**

Client Reference: 45040.04
Clayton Project No. 93021.90

Sample Identification: MW-23-4.5	Date Sampled: 02/16/93
Lab Number: 9302190-02A	Date Received: 02/16/93
Sample Matrix/Media: SOIL	Date Prepared: 02/18/93
Preparation Method: EPA 5030	Date Analyzed: 02/23/93
Analytical Method: EPA 8010	

Analyte	CAS #	Concentration (mg/kg)	Limit of Detection (mg/kg)
<u>Purgeable Halocarbons (continued)</u>			
2-Chloroethylvinylether	110-75-8	ND	0.1
Bromoform	75-25-2	ND	0.07
Tetrachloroethene	127-18-4	ND	0.05
1,1,2,2-Tetrachloroethane	79-34-5	ND	0.05
Chlorobenzene	108-90-7	ND	0.07
1,3-Dichlorobenzene	541-73-7	ND	0.2
1,2-Dichlorobenzene	95-50-1	ND	0.4
1,4-Dichlorobenzene	106-46-7	ND	0.4
Dichlorodifluoromethane	75-71-8	ND	0.1
Trichlorofluoromethane	75-69-4	ND	0.04
Freon 113	76-13-1	ND	0.06

<u>Surrogates</u>		<u>Recovery (%)</u>	<u>QC Limits (%)</u>	
			LCL	UCL
Bromochloromethane	74-97-5	95	50	150

ND Not detected at or above limit of detection
 -- Information not available or not applicable
 Results are reported on a wet weight basis, as received

Results of Analysis
for
Clayton Environmental Consultants, Inc.

Client Reference: 45040.04
Clayton Project No. 93021.90

Sample Identification:	METHOD BLANK	Date Sampled:	--
Lab Number:	9302190-03A	Date Received:	--
Sample Matrix/Media:	SOIL	Date Prepared:	02/18/93
Preparation Method:	EPA 5030	Date Analyzed:	02/23/93
Analytical Method:	EPA 8010		

Analyte	CAS #	Concentration (mg/kg)	Limit of Detection (mg/kg)
<u>Purgeable Halocarbons</u>			
Chloromethane	74-87-3	ND	0.06
Bromomethane	74-83-9	ND	0.07
Vinyl chloride	75-01-4	ND	0.05
Chloroethane	75-00-3	ND	0.05
Methylene chloride	75-09-2	ND	0.2
1,1-Dichloroethene	75-35-4	ND	0.03
1,1-Dichloroethane	75-35-3	ND	0.04
Trans-1,2-Dichloroethene	156-60-5	ND	0.04
Cis-1,2-Dichloroethene	156-59-2	ND	0.04
Chloroform	67-66-3	ND	0.05
1,2-Dichloroethane	107-06-2	ND	0.03
1,1,1-Trichloroethane	71-55-6	ND	0.05
Carbon tetrachloride	56-23-5	ND	0.06
Bromodichloromethane	75-27-4	ND	0.07
1,2-Dichloropropane	78-87-5	ND	0.05
Cis-1,3-Dichloropropene	10061-01-5	ND	0.05
Trichloroethene	79-01-6	ND	0.03
Dibromochloromethane	124-48-1	ND	0.06
1,1,2-Trichloroethane	79-00-5	ND	0.06
Trans-1,3-Dichloropropene	10061-02-6	ND	0.06

ND Not detected at or above limit of detection
 -- Information not available or not applicable
 Results are reported on a wet weight basis, as received

Results of Analysis
for
Clayton Environmental Consultants, Inc.

Client Reference: 45040.04
Clayton Project No. 93021.90

Sample Identification: METHOD BLANK	Date Sampled: --
Lab Number: 9302190-03A	Date Received: --
Sample Matrix/Media: SOIL	Date Prepared: 02/18/93
Preparation Method: EPA 5030	Date Analyzed: 02/23/93
Analytical Method: EPA 8010	

Analyte	CAS #	Concentration (mg/kg)	Limit of Detection (mg/kg)
<u>Purgeable Halocarbons (continued)</u>			
2-Chloroethylvinylether	110-75-8	ND	0.1
Bromoform	75-25-2	ND	0.07
Tetrachloroethene	127-18-4	ND	0.05
1,1,2,2-Tetrachloroethane	79-34-5	ND	0.05
Chlorobenzene	108-90-7	ND	0.07
1,3-Dichlorobenzene	541-73-7	ND	0.2
1,2-Dichlorobenzene	95-50-1	ND	0.4
1,4-Dichlorobenzene	106-46-7	ND	0.4
Dichlorodifluoromethane	75-71-8	ND	0.1
Trichlorofluoromethane	75-69-4	ND	0.04
Freon 113	76-13-1	ND	0.06

<u>Surrogates</u>		<u>Recovery (%)</u>	<u>QC Limits (%)</u>	
			LCL	UCL
Bromochloromethane	74-97-5	110	50	150

ND Not detected at or above limit of detection
 -- Information not available or not applicable
 Results are reported on a wet weight basis, as received

Results of Analysis
for
Clayton Environmental Consultants, Inc.

Client Reference: 45040.04
Clayton Project No. 93021.90

Sample Matrix/Media: SOIL
Preparation Method: EPA 3550
Analysis Method: EPA 8015

Date Received: 02/16/93
Date Prepared: 02/18/93
Date Analyzed: 02/18/93

Lab Number	Sample Identification	Date Sampled	Diesel (mg/kg)	Detect. Limit (mg/)
02A	MW-23-4.5	02/16/93	ND	
03A	METHOD BLANK	--	ND	

ND Not detected at or above limit of detection
< Not detected at or above limit of detection
-- Information not available or not applicable

Results are reported on a wet weight basis, as received

Results of Analysis
for
Clayton Environmental Consultants, Inc.

Client Reference: 45040.04
Clayton Project No. 93021.90

Sample Matrix/Media: SOIL
Preparation Method: EPA 3550
Analysis Method: EPA 8015

Date Received: 02/16/93
Date Prepared: 02/18/93
Date Analyzed: 02/18/93

Lab Number	Sample Identification	Date Sampled	TPH as Motor Oil (mg/kg)	Detect. Limit (mg/l)
02A	MW-23-4.5	02/16/93	ND	
03A	METHOD BLANK	--	ND	

ND Not detected at or above limit of detection
< Not detected at or above limit of detection
-- Information not available or not applicable

Results are reported on a wet weight basis, as received

Clayton

ENVIRONMENTAL
CONSULTANTS

A Marsh & McLennan Company

REQUEST FOR LABORATORY ANALYTICAL SERVICES

For Clayton Use Only Page 1 of 1

Project No. 45040.04

Batch No. 9302230

Ind. Code _____ W.P. _____

Date Logged In 2/17/93 By TS

REPORT RESULTS TO	Name <u>Darwick D. Destro</u> Title _____		Purchase Order No. _____		Client Job No. _____		
	Company _____ Dept. _____		Name <u>Horsch</u>		Dept. _____		
	Mailing Address _____		Company _____		Dept. _____		
	City, State, Zip _____		Address _____		City, State, Zip _____		
Telephone No. _____		Telefax No. _____					
Date Results Req.: <u>RETUNE</u>		Rush Charges Authorized? <input type="checkbox"/> Yes <input checked="" type="checkbox"/> No		Phone / Fax Results <input type="checkbox"/> <input type="checkbox"/>		Samples are: (check if applicable)	
Special Instructions: (method, limit of detection, etc.)		Explanation of Preservative:		<input type="checkbox"/> Drinking Water <input type="checkbox"/> Collected in the State of New York		ANALYSIS REQUESTED (Enter an 'X' in the box below to indicate request; Enter a 'P' if Preservative added.)	
CLIENT SAMPLE IDENTIFICATION		DATE SAMPLED	MATRIX/MEDIA	AIR VOLUME (specify units)	Number of Containers		FOR LAB USE ONLY
<u>MW-22-8.5</u>		<u>2-16/93</u>	<u>Sand</u>	<u>B.C.</u>	<u>1</u>	<u>X</u>	<u>CIA</u>
<u>MW-23-4.5</u>		↓	↓	↓	<u>1</u>	<u>X X X X</u>	<u>O2A</u>
CHAIN OF CUSTODY		Collected by: <u>Darwick D. Destro</u> (print)		Collector's Signature: _____		Date/Time: <u>2/16/93 7:05p</u>	
		Relinquished by: <u>Darwick D. Destro</u>		Received by: _____		Date/Time: _____	
		Relinquished by: _____		Received at Lab by: _____		Date/Time: _____	
		Method of Shipment: _____		Sample Condition Upon Receipt: <input type="checkbox"/> Acceptable <input type="checkbox"/> Other (explain)			
Authorized by: _____		Date: _____					
		(Client Signature Must Accompany Request)					

Please return completed form and samples to one of the Clayton Environmental Consultants, Inc. labs listed below:

- 22345 Roethel Drive Raritan Center 400 Chastain Center Blvd., N.W. 1252 Quarry Lane
- North, NJ 08875 160 Eldercrest Ave. Suite 490 Pleasanton, CA 94566

DISTRIBUTION:
 WHITE - Clayton Laboratory
 YELLOW - Clayton Accounting

Western Operations

1252 Quarry Lane
P.O. Box 9019
Pleasanton, CA 94566
(510) 426-2600
Fax (510) 426-0106

Clayton
ENVIRONMENTAL
CONSULTANTS

March 9, 1993

Mr. Dariush Dastmalchi
CLAYTON ENVIRONMENTAL CONSULTANTS, INC.
1252 Quarry Lane
Pleasanton, CA 94566

Client Ref. 45040.01
Clayton Project No. 93022.80

Dear Mr. Dastmalchi:

Attached is our analytical laboratory report for the samples received on February 24, 1993. On March 2, 1993, you cancelled analysis of samples for metals and EPA Method 8270. A copy of the Chain-of-Custody form acknowledging receipt of these samples is attached.

Please note that any unused portion of the samples will be disposed of 30 days after the date of this report, unless you have requested otherwise.

We appreciate the opportunity to be of assistance to you. If you have any questions, please contact Suzanne Silvera, Client Services Supervisor, at (510) 426-2657.

Sincerely,

Narrative A. [Signature]

Ronald H. Peters, CIH
Director, Laboratory Services
Western Operations

RHP/tb
Attachments

Results of Analysis
for
Harsch Investments

Client Reference: 45040.01
Clayton Project No. 93022.80

Sample Identification: MW-23
Lab Number: 9302280-01A
Sample Matrix/Media: WATER
Preparation Method: EPA 5030
Analytical Method: EPA 8015/8020

Date Sampled: 02/24/93
Date Received: 02/24/93
Date Prepared: 03/01/93
Date Analyzed: 03/01/93

Analyte	CAS #	Concentration (ug/L)	Limit of Detection (ug/L)
<u>BTEX/Gasoline</u>			
Benzene	71-43-2	ND	0.4
Toluene	108-88-3	ND	0.3
Ethylbenzene	100-41-4	ND	0.3
p,m-Xylenes	--	ND	0.4
o-Xylene	95-47-6	ND	0.4
Gasoline	--	ND	50
<u>Surrogates</u>		<u>Recovery (%)</u>	<u>QC Limits (%)</u>
a,a,a-Trifluorotoluene	98-08-8	115	50 - 150

ND: Not detected at or above limit of detection
--: Information not available or not applicable

Results of Analysis
for
Harsch Investments

Client Reference: 45040.01
Clayton Project No. 93022.80

Sample Identification: MW-15
Lab Number: 9302280-04A
Sample Matrix/Media: WATER
Preparation Method: EPA 5030
Analytical Method: EPA 8015/8020

Date Sampled: 02/24/93
Date Received: 02/24/93
Date Prepared: 03/01/93
Date Analyzed: 03/01/93

Analyte	CAS #	Concentration (ug/L)	Limit of Detection (ug/L)
<u>BTEX/Gasoline</u>			
Benzene	71-43-2	ND	0.4
Toluene	108-88-3	ND	0.3
Ethylbenzene	100-41-4	ND	0.3
p,m-Xylenes	--	ND	0.4
o-Xylene	95-47-6	ND	0.4
Gasoline	--	ND	50
<u>Surrogates</u>		<u>Recovery (%)</u>	<u>QC Limits (%)</u>
a,a,a-Trifluorotoluene	98-08-8	110	50 - 150

ND: Not detected at or above limit of detection
--: Information not available or not applicable

Results of Analysis
for
Harsch Investments

Client Reference: 45040.01
Clayton Project No. 93022.80

Sample Identification:	MW-14	Date Sampled:	02/24/93
Lab Number:	9302280-05A	Date Received:	02/24/93
Sample Matrix/Media:	WATER	Date Prepared:	03/01/93
Preparation Method:	EPA 5030	Date Analyzed:	03/01/93
Analytical Method:	EPA 8015/8020		

Analyte	CAS #	Concentration (ug/L)	Limit of Detection (ug/L)
<u>BTEX/Gasoline</u>			
Benzene	71-43-2	ND	0.4
Toluene	108-88-3	ND	0.3
Ethylbenzene	100-41-4	ND	0.3
p,m-Xylenes	--	ND	0.4
o-Xylene	95-47-6	ND	0.4
Gasoline	--	ND	50
<u>Surrogates</u>		<u>Recovery (%)</u>	<u>QC Limits (%)</u>
a,a,a-Trifluorotoluene	98-08-8	113	50 - 150

ND: Not detected at or above limit of detection
--: Information not available or not applicable

Results of Analysis
for
Harsch Investments

Client Reference: 45040.01
Clayton Project No. 93022.80

Sample Identification:	METHOD BLANK	Date Sampled:	--
Lab Number:	9302280-06A	Date Received:	--
Sample Matrix/Media:	WATER	Date Prepared:	03/01/93
Preparation Method:	EPA 5030	Date Analyzed:	03/01/93
Analytical Method:	EPA 8015/8020		

Analyte	CAS #	Concentration (ug/L)	Limit of Detection (ug/L)
<u>BTEX/Gasoline</u>			
Benzene	71-43-2	ND	0.4
Toluene	108-88-3	ND	0.3
Ethylbenzene	100-41-4	ND	0.3
p,m-Xylenes	--	ND	0.4
o-Xylene	95-47-6	ND	0.4
Gasoline	--	ND	50
<u>Surrogates</u>		<u>Recovery (%)</u>	<u>QC Limits (%)</u>
a,a,a-Trifluorotoluene	98-08-8	111	50 - 150

ND: Not detected at or above limit of detection
--: Information not available or not applicable

Results of Analysis
for
Harsch Investments

Client Reference: 45040.01
Clayton Project No. 93022.80

Sample Identification:	MW-23	Date Sampled:	02/24/93
Lab Number:	9302280-01C	Date Received:	02/24/93
Sample Matrix/Media:	WATER	Date Analyzed:	03/01/93
Analytical Method:	EPA 601		

Analyte	CAS #	Concentration (ug/L)	Limit of Detection (ug/L)
<u>Purgeable Halocarbons</u>			
Chloromethane	74-87-3	ND	0.6
Bromomethane	74-83-9	ND	0.7
Vinyl chloride	75-01-4	ND	0.5
Chloroethane	75-00-3	ND	0.5
Methylene chloride	75-09-2	ND	2
1,1-Dichloroethene	75-35-4	ND	0.2
1,1-Dichloroethane	75-35-3	ND	0.4
Trans-1,2-Dichloroethene	156-60-5	ND	0.4
Cis-1,2-Dichloroethene	156-59-2	ND	0.4
Chloroform	67-66-3	ND	0.5
1,2-Dichloroethane	107-06-2	ND	0.3
1,1,1-Trichloroethane	71-55-6	ND	0.5
Carbon tetrachloride	56-23-5	ND	0.6
Bromodichloromethane	75-27-4	ND	0.7
1,2-Dichloropropane	78-87-5	ND	0.5
Cis-1,3-Dichloropropene	10061-01-5	ND	0.5
Trichloroethene	79-01-6	ND	0.3
Dibromochloromethane	124-48-1	ND	0.6
1,1,2-Trichloroethane	79-00-5	ND	0.6
Trans-1,3-Dichloropropene	10061-02-6	ND	0.6

ND Not detected at or above limit of detection
-- Information not available or not applicable

Results of Analysis
for
Harsch Investments

Client Reference: 45040.01
Clayton Project No. 93022.80

Sample Identification: MW-23	Date Sampled: 02/24/93
Lab Number: 9302280-01C	Date Received: 02/24/93
Sample Matrix/Media: WATER	Date Analyzed: 03/01/93
Analytical Method: EPA 601	

Analyte	CAS #	Concentration (ug/L)	Limit of Detection (ug/L)
<u>Purgeable Halocarbons (continued)</u>			
2-Chloroethylvinylether	110-75-8	ND	1
Bromoform	75-25-2	ND	0.7
Tetrachloroethene	127-18-4	ND	0.5
1,1,2,2-Tetrachloroethane	79-34-5	ND	0.5
Chlorobenzene	108-90-7	ND	0.7
1,3-Dichlorobenzene	541-73-7	ND	2
1,2-Dichlorobenzene	95-50-1	ND	4
1,4-Dichlorobenzene	106-46-7	ND	4
Dichlorodifluoromethane	75-71-8	ND	1
Trichlorofluoromethane	75-69-4	ND	0.4
Freon 113	76-13-1	ND	0.6
<u>Surrogates</u>		<u>Recovery (%)</u>	<u>QC Limits (%)</u> LCL UCL
Bromochloromethane	74-97-5	86	50 - 150

ND Not detected at or above limit of detection
-- Information not available or not applicable

Results of Analysis
for
Harsch Investments

Client Reference: 45040.01
Clayton Project No. 93022.80

Sample Identification:	MW-16	Date Sampled:	02/24/93
Lab Number:	9302280-03A	Date Received:	02/24/93
Sample Matrix/Media:	WATER	Date Analyzed:	03/01/93
Analytical Method:	EPA 601		

Analyte	CAS #	Concentration (ug/L)	Limit of Detection (ug/L)
<u>Purgeable Halocarbons</u>			
Chloromethane	74-87-3	ND	0.6
Bromomethane	74-83-9	ND	0.7
Vinyl chloride	75-01-4	ND	0.5
Chloroethane	75-00-3	ND	0.5
Methylene chloride	75-09-2	ND	2
1,1-Dichloroethene	75-35-4	ND	0.2
1,1-Dichloroethane	75-35-3	ND	0.4
Trans-1,2-Dichloroethene	156-60-5	ND	0.4
Cis-1,2-Dichloroethene	156-59-2	ND	0.4
Chloroform	67-66-3	ND	0.5
1,2-Dichloroethane	107-06-2	ND	0.3
1,1,1-Trichloroethane	71-55-6	ND	0.5
Carbon tetrachloride	56-23-5	ND	0.6
Bromodichloromethane	75-27-4	ND	0.7
1,2-Dichloropropane	78-87-5	ND	0.5
Cis-1,3-Dichloropropene	10061-01-5	ND	0.5
Trichloroethene	79-01-6	ND	0.3
Dibromochloromethane	124-48-1	ND	0.6
1,1,2-Trichloroethane	79-00-5	ND	0.6
Trans-1,3-Dichloropropene	10061-02-6	ND	0.6

ND Not detected at or above limit of detection
-- Information not available or not applicable

Results of Analysis
for
Harsch Investments

Client Reference: 45040.01
Clayton Project No. 93022.80

Sample Identification:	MW-16	Date Sampled:	02/24/93
Lab Number:	9302280-03A	Date Received:	02/24/93
Sample Matrix/Media:	WATER	Date Analyzed:	03/01/93
Analytical Method:	EPA 601		

Analyte	CAS #	Concentration (ug/L)	Limit of Detection (ug/L)
<u>Purgeable Halocarbons (continued)</u>			
2-Chloroethylvinylether	110-75-8	ND	1
Bromoform	75-25-2	ND	0.7
Tetrachloroethene	127-18-4	ND	0.5
1,1,2,2-Tetrachloroethane	79-34-5	ND	0.5
Chlorobenzene	108-90-7	ND	0.7
1,3-Dichlorobenzene	541-73-7	ND	2
1,2-Dichlorobenzene	95-50-1	ND	4
1,4-Dichlorobenzene	106-46-7	ND	4
Dichlorodifluoromethane	75-71-8	ND	1
Trichlorofluoromethane	75-69-4	ND	0.4
Freon 113	76-13-1	ND	0.6
<u>Surrogates</u>		<u>Recovery (%)</u>	<u>QC Limits (%)</u> LCL UCL
Bromochloromethane	74-97-5	85	50 - 150

ND Not detected at or above limit of detection
-- Information not available or not applicable

Results of Analysis
for
Harsch Investments

Client Reference: 45040.01
Clayton Project No. 93022.80

Sample Identification:	MW-15	Date Sampled:	02/24/93
Lab Number:	9302280-04E	Date Received:	02/24/93
Sample Matrix/Media:	WATER	Date Analyzed:	03/01/93
Analytical Method:	EPA 601		

Analyte	CAS #	Concentration (ug/L)	Limit of Detection (ug/L)
<u>Purgeable Halocarbons</u>			
Chloromethane	74-87-3	ND	0.6
Bromomethane	74-83-9	ND	0.7
Vinyl chloride	75-01-4	ND	0.5
Chloroethane	75-00-3	ND	0.5
Methylene chloride	75-09-2	ND	2
1,1-Dichloroethene	75-35-4	ND	0.2
1,1-Dichloroethane	75-35-3	ND	0.4
Trans-1,2-Dichloroethene	156-60-5	ND	0.4
Cis-1,2-Dichloroethene	156-59-2	ND	0.4
Chloroform	67-66-3	ND	0.5
1,2-Dichloroethane	107-06-2	ND	0.3
1,1,1-Trichloroethane	71-55-6	ND	0.5
Carbon tetrachloride	56-23-5	ND	0.6
Bromodichloromethane	75-27-4	ND	0.7
1,2-Dichloropropane	78-87-5	ND	0.5
Cis-1,3-Dichloropropene	10061-01-5	ND	0.5
Trichloroethene	79-01-6	ND	0.3
Dibromochloromethane	124-48-1	ND	0.6
1,1,2-Trichloroethane	79-00-5	ND	0.6
Trans-1,3-Dichloropropene	10061-02-6	ND	0.6

ND Not detected at or above limit of detection
-- Information not available or not applicable

Results of Analysis
for
Harsch Investments

Client Reference: 45040.01
Clayton Project No. 93022.80

Sample Identification:	MW-15	Date Sampled:	02/24/93
Lab Number:	9302280-04E	Date Received:	02/24/93
Sample Matrix/Media:	WATER	Date Analyzed:	03/01/93
Analytical Method:	EPA 601		

Analyte	CAS #	Concentration (ug/L)	Limit of Detection (ug/L)
<u>Purgeable Halocarbons (continued)</u>			
2-Chloroethylvinylether	110-75-8	ND	1
Bromoform	75-25-2	ND	0.7
Tetrachloroethene	127-18-4	ND	0.5
1,1,2,2-Tetrachloroethane	79-34-5	ND	0.5
Chlorobenzene	108-90-7	ND	0.7
1,3-Dichlorobenzene	541-73-7	ND	2
1,2-Dichlorobenzene	95-50-1	ND	4
1,4-Dichlorobenzene	106-46-7	ND	4
Dichlorodifluoromethane	75-71-8	ND	1
Trichlorofluoromethane	75-69-4	ND	0.4
Freon 113	76-13-1	ND	0.6
<u>Surrogates</u>		<u>Recovery (%)</u>	<u>QC Limits (LCL UCL)</u>
Bromochloromethane	74-97-5	104	50 - 150

ND Not detected at or above limit of detection
-- Information not available or not applicable

Results of Analysis
for
Harsch Investments

Client Reference: 45040.01
Clayton Project No. 93022.80

Sample Identification: MW-14	Date Sampled: 02/24/93
Lab Number: 9302280-05E	Date Received: 02/24/93
Sample Matrix/Media: WATER	Date Analyzed: 03/01/93
Analytical Method: EPA 601	

Analyte	CAS #	Concentration (ug/L)	Limit of Detection (ug/L)
<u>Purgeable Halocarbons</u>			
Chloromethane	74-87-3	ND	0.6
Bromomethane	74-83-9	ND	0.7
Vinyl chloride	75-01-4	ND	0.5
Chloroethane	75-00-3	ND	0.5
Methylene chloride	75-09-2	ND	2
1,1-Dichloroethene	75-35-4	ND	0.2
1,1-Dichloroethane	75-35-3	ND	0.4
Trans-1,2-Dichloroethene	156-60-5	ND	0.4
Cis-1,2-Dichloroethene	156-59-2	ND	0.4
Chloroform	67-66-3	ND	0.5
1,2-Dichloroethane	107-06-2	3.4	0.3
1,1,1-Trichloroethane	71-55-6	ND	0.5
Carbon tetrachloride	56-23-5	ND	0.6
Bromodichloromethane	75-27-4	ND	0.7
1,2-Dichloropropane	78-87-5	ND	0.5
Cis-1,3-Dichloropropene	10061-01-5	ND	0.5
Trichloroethene	79-01-6	ND	0.3
Dibromochloromethane	124-48-1	ND	0.6
1,1,2-Trichloroethane	79-00-5	ND	0.6
Trans-1,3-Dichloropropene	10061-02-6	ND	0.6

ND Not detected at or above limit of detection
-- Information not available or not applicable

Results of Analysis
for
Harsch Investments

Client Reference: 45040.01
Clayton Project No. 93022.80

Sample Identification:	MW-14	Date Sampled:	02/24/93
Lab Number:	9302280-05E	Date Received:	02/24/93
Sample Matrix/Media:	WATER	Date Analyzed:	03/01/93
Analytical Method:	EPA 601		

Analyte	CAS #	Concentration (ug/L)	Limit of Detection (ug/L)
<u>Purgeable Halocarbons (continued)</u>			
2-Chloroethylvinylether	110-75-8	ND	1
Bromoform	75-25-2	ND	0.7
Tetrachloroethene	127-18-4	ND	0.5
1,1,2,2-Tetrachloroethane	79-34-5	ND	0.5
Chlorobenzene	108-90-7	ND	0.7
1,3-Dichlorobenzene	541-73-7	ND	2
1,2-Dichlorobenzene	95-50-1	ND	4
1,4-Dichlorobenzene	106-46-7	ND	4
Dichlorodifluoromethane	75-71-8	ND	1
Trichlorofluoromethane	75-69-4	ND	0.4
Freon 113	76-13-1	ND	0.6
<u>Surrogates</u>		<u>Recovery (%)</u>	<u>QC Limits (%)</u> LCL UCL
Bromochloromethane	74-97-5	104	50 - 150

ND Not detected at or above limit of detection
-- Information not available or not applicable

Results of Analysis
for
Harsch Investments

Client Reference: 45040.01
Clayton Project No. 93022.80

Sample Identification: METHOD BLANK	Date Sampled: --
Lab Number: 9302280-06A	Date Received: --
Sample Matrix/Media: WATER	Date Analyzed: 03/01/93
Analytical Method: EPA 601	

Analyte	CAS #	Concentration (ug/L)	Limit of Detection (ug/L)
<u>Purgeable Halocarbons (continued)</u>			
2-Chloroethylvinylether	110-75-8	ND	1
Bromoform	75-25-2	ND	0.7
Tetrachloroethene	127-18-4	ND	0.5
1,1,2,2-Tetrachloroethane	79-34-5	ND	0.5
Chlorobenzene	108-90-7	ND	0.7
1,3-Dichlorobenzene	541-73-7	ND	2
1,2-Dichlorobenzene	95-50-1	ND	4
1,4-Dichlorobenzene	106-46-7	ND	4
Dichlorodifluoromethane	75-71-8	ND	1
Trichlorofluoromethane	75-69-4	ND	0.4
Freon 113	76-13-1	ND	0.6
<u>Surrogates</u>		<u>Recovery (%)</u>	<u>QC Limits (%)</u> LCL UCL
Bromochloromethane	74-97-5	95	50 - 150

ND Not detected at or above limit of detection
-- Information not available or not applicable

**Results of Analysis
for
Harsch Investments**

**Client Reference: 45040.01
Clayton Project No. 93022.80**

**Sample Matrix/Media: WATER
Preparation Method: SM 5520B
Analysis Method: SM 5520F**

**Date Received: 02/24/93
Date Prepared: 03/01/93
Date Analyzed: 03/02/93**

Lab Number	Sample Identification	Date Sampled	Hydrocarbons (mg/L)	Detect. Limit (mg/)
01H	MW-23	02/24/93	ND	
06A	METHOD BLANK	--	ND	

ND Not detected at or above limit of detection
< Not detected at or above limit of detection
-- Information not available or not applicable

**Results of Analysis
for
Harsch Investments**

Client Reference: 45040.01
Clayton Project No. 93022.80

Sample Matrix/Media: WATER
Analysis Method: EPA 160.1

Date Received: 02/24/93
Date Analyzed: 03/04/93

Lab Number	Sample Identification	Date Sampled	Total Dissolved Solids (mg/L)	Detect Limi (mg/
01J	MW-23	02/24/93	160	1
03C	MW-16	02/24/93	24,000	1
04G	MW-15	02/24/93	880	1
05G	MW-14	02/24/93	2,000	1
06A	METHOD BLANK	--	<10	1

ND Not detected at or above limit of detection
< Not detected at or above limit of detection
-- Information not available or not applicable

**Results of Analysis
for
Harsch Investments**

Client Reference: 45040.01
Clayton Project No. 93022.80

Sample Matrix/Media: WATER
Preparation Method: EPA 3510
Analysis Method: EPA 8015

Date Received: 02/24/93
Date Prepared: 02/26/93
Date Analyzed: 03/01/93

Lab Number	Sample Identification	Date Sampled	Diesel (ug/L)	Detect Limit (ug/L)
01F	MW-23	02/24/93	ND	
04C	MW-15	02/24/93	200 a	
05C	MW-14	02/24/93	660 a	
06A	METHOD BLANK	--	ND	

ND Not detected at or above limit of detection
< Not detected at or above limit of detection
-- Information not available or not applicable

^aNote: The hydrocarbons detected in these samples appear to be intermediate between diesel and motor oil: quantitation was based on diesel standards.

Clayton

ENVIRONMENTAL
CONSULTANTS

A Marsh & McLennan Company

REQUEST FOR LABORATORY ANALYTICAL SERVICES

For Clayton Use Only Page 1 of 3

Project No. 45210.01

Batch No. 9302280

Ind. Code _____ W.P. _____

Date Logged In 2/25/93 By TB

REPORT RESULTS TO	Name <u>D. DALSTIMACH</u>	Title _____	Purchase Order No. _____	Client Job No. _____
	Company <u>ERC</u>	Dept. <u>EE</u>		
	Mailing Address _____			
	City, State, Zip _____			
	Telephone No. _____	Telefax No. _____		

SEND INVOICE TO	Name _____
	Company <u>HARSCO</u>
	Address _____
	City, State, Zip <u>ALAMEDA</u>

Date Results Req.: STANDARD Rush Charges Authorized? Yes No Phone / Fax Results

Special Instructions: (method, limit of detection, etc.)
* - Cd, Cr, Pb, Zn, Ni
Explanation of Preservative: HCl, HNO3

Samples are: (check if applicable)
 Drinking Water
 Collected in the State of New York

ANALYSIS REQUESTED
(Enter an 'X' in the box below to indicate request; Enter a 'P' if Preservative added.)

Number of Containers

5770/8015-8030
225 FT2
601
6010 WARS *
350/8015 DIESEL
5520 D/K D/L
TDS
8270 + 700'S
H027

CLIENT SAMPLE IDENTIFICATION	DATE SAMPLED	MATRIX/MEDIA	AIR VOLUME (specify units)	Number of Containers	ANALYSIS REQUESTED										FOR LAB USE ONLY			
MW-23 w/HCl	2-24-93	H2O	40ML	2	X													OIA, B
"	"	"	40ML	2		X												C, D
" w/HNO3	"	"	500ML	1			X											E
" w/Hcl	"	"	1L	2				X										FG
" w/Hcl	"	"	1L	2					X									HI
"	"	"	500ML	1						X								J
"	"	"	1L	2							X							KL
TRIP w/O PRES.	"	"	400ml ²	2														Q2AB
TRIP w/PRES Hcl	"	"	↓	2														VC, D

CHAIN OF CUSTODY	Collected by: <u>G. WILLIAMS</u> (print)	Collector's Signature: <u>[Signature]</u>
	Relinquished by: <u>G. WILLIAMS</u>	Date/Time: <u>2-24-93 1800</u>
	Relinquished by: _____	Date/Time: _____
	Method of Shipment: _____	Date/Time: <u>2/24/93 6:00</u>
Authorized by: _____ Date: _____ (Client Signature <u>Must Accompany Request</u>)		Sample Condition Upon Receipt: <input checked="" type="checkbox"/> Acceptable <input type="checkbox"/> Other (explain) _____

Clayton

ENVIRONMENTAL
CONSULTANTS

A Marsh & McLennan Company

REQUEST FOR LABORATORY ANALYTICAL SERVICES

For Clayton Use Only Page 2 of 3

Project No. 45040.01

Batch No. 9302280

Ind. Code _____ W.P. _____

Date Logged In 2/25/93 By TS

REPORT RESULTS TO	Name <u>D. DALSCHWACH 1</u>		Title _____		Purchase Order No. _____		Client Job No. _____																																																																																			
	Company <u>SEC</u>		Dept. <u>EE-</u>		Name _____		Dept. _____																																																																																			
	Mailing Address _____				Address _____																																																																																					
	City, State, Zip _____		Telephone No. _____		City, State, Zip <u>ALAMEDA</u>		Telefax No. _____																																																																																			
Date Results Req.: <u>STANDARD</u>		Rush Charges Authorized? <input type="checkbox"/> Yes <input checked="" type="checkbox"/> No		Phone / Fax Results <input type="checkbox"/> <input type="checkbox"/>		ANALYSIS REQUESTED (Enter an 'X' in the box below to indicate request; Enter a 'P' if Preservative added. *)																																																																																				
Special Instructions: (method, limit of detection, etc.) _____				Samples are: (check if applicable) <input type="checkbox"/> Drinking Water <input type="checkbox"/> Collected in the State of New York		<table border="1"> <tr> <td rowspan="10">Number of Containers</td> <td colspan="8" style="text-align: center;">/</td> </tr> <tr> <td colspan="8" style="text-align: center;">601 TDS 50% 50% 50% 50% 50% 50% 50% 50%</td> </tr> <tr> <td colspan="8" style="text-align: center;">3510/0015 PIGSW</td> </tr> <tr> <td colspan="8" style="text-align: center;">/</td> </tr> <tr> <td colspan="8" style="text-align: center;">/</td> </tr> <tr> <td colspan="8" style="text-align: center;">/</td> </tr> <tr> <td colspan="8" style="text-align: center;">/</td> </tr> <tr> <td colspan="8" style="text-align: center;">/</td> </tr> <tr> <td colspan="8" style="text-align: center;">/</td> </tr> <tr> <td colspan="8" style="text-align: center;">/</td> </tr> </table>				Number of Containers	/								601 TDS 50% 50% 50% 50% 50% 50% 50% 50%								3510/0015 PIGSW								/								/								/								/								/								/								/							
Number of Containers	/																																																																																									
	601 TDS 50% 50% 50% 50% 50% 50% 50% 50%																																																																																									
	3510/0015 PIGSW																																																																																									
	/																																																																																									
	/																																																																																									
	/																																																																																									
	/																																																																																									
	/																																																																																									
	/																																																																																									
	/																																																																																									
* Explanation of Preservative: _____						FOR LAB USE ONLY																																																																																				
CLIENT SAMPLE IDENTIFICATION			DATE SAMPLED	MATRIX/MEDIA	AIR VOLUME (specify units)																																																																																					
MW-16			2-24-93	1L20	40ML	2	X		03A,B																																																																																	
MW-16			"	"	250ML	1		X	V,C																																																																																	
MW-15			"	"	40ML	2		X	04A,B																																																																																	
MW-15			"	"	1 LITER	2		X	C,D																																																																																	
MW-15			"	"	40ML	2	X		E,F																																																																																	
MW-15			"	"	250ML	1		X	V,G																																																																																	
MW-14			"	"	40ML	2		X	05A,B																																																																																	
MW-14			"	"	1 LITER	2		X	C,D																																																																																	
MW-14			"	"	40ML	2	X		E,F																																																																																	
MW-14			"	"	250ML	1		X	V,G																																																																																	
CHAIN OF CUSTODY	Collected by: <u>G WILLIAMS</u> (print)				Collector's Signature: <u>[Signature]</u>																																																																																					
	Relinquished by: <u>G WILLIAMS</u>			Date/Time: <u>2-24-93 1800</u>	Received by: <u>[Signature]</u>			Date/Time: _____																																																																																		
	Relinquished by: _____			Date/Time: _____	Received at Lab by: <u>[Signature]</u>			Date/Time: <u>2/24/93 600</u>																																																																																		
	Method of Shipment: _____				Sample Condition Upon Receipt: <input checked="" type="checkbox"/> Acceptable <input type="checkbox"/> Other (explain) _____																																																																																					
Authorized by: _____ Date: _____ (Client Signature Must Accompany Request)																																																																																										

Please return completed form and samples to one of the Clayton Environmental Consultants, Inc. labs listed below:

22345 Rosalind Drive Raritan Center 400 Chastain Center Blvd., N.W. 1252 Quarry Lane

DISTRIBUTION:
WHITE - Clayton Laboratory

