

Restructure Petroleum Marketing Services of California

3343 Kingfisher Drive

Holiday FL 34690

Telephone: 727-940-3630 • Fax: 727-940-3630

October 20, 2011

Alameda County Environmental Health Dept (ACEHD)
Attn: Mark Detterman, PG, CEG
1131 Harbor Bay Park Way
Alameda, CA 94502

RECEIVED

9:50 am, Oct 28, 2011

Alameda County
Environmental Health

Former E-Z Serve Location 100877
525 West A Street
Hayward, CA
Fuel Leak Case No. RO0000023

**Subject: 2011 THIRD QUARTER GROUNDWATER SAMPLING RESULTS FOR FORMER
RPMS (E-Z SERVE) SITE 100877 LOCATED AT: 525 West A Street in Hayward,
California**

Dear Mr. Detterman:

I declare under penalty of perjury that to the best of my knowledge, the information and/or recommendations contained in the attached report is/are true and correct.

Please contact us with questions at 727-940-3630.

Respectfully,
Restructure Petroleum Marketing Services of California



Janet S. Ceccarelli
President

GALLARDO & ASSOCIATES, INC.

304 Belle Court, El Dorado Hills, CA 95762
(916) 358-3719 and (707) 332-0966
(916) 358-3719 FAX

Environmental and Geological Services

We solve the problem!

October 17, 2011

Ms. Janet Ceccarelli

Restructure Petroleum Marketing Services of California, (RPMS)

9519 E. ML King Blvd., Suite 100

Tampa, Florida 33610

Job No. 001.11

Subject: 2011 THIRD QUARTER GROUNDWATER SAMPLING RESULTS FOR FORMER RPMS (E-Z SERVE) SITE 100877 LOCATED AT: 525 West A Street in Hayward, California.

Dear Ceccarelli:

Gallardo & Associates, Inc. is pleased to submit the following Groundwater Monitoring Report for the following location: **525 West A Street in Hayward, California.**

Water samples were collected from 12 groundwater monitoring wells on **July 25, 2011** and analyzed for the following petroleum constituents: total petroleum hydrocarbons as gasoline (**TPH-g**), the fuel constituents benzene, toluene, ethylbenzene, and xylenes (**BTEX**), and the fuel Oxygenates Methyl tert-Butyl Ether (**MTBE**), Di-isopropyl Ether (**DIPE**), Ethyl Tert-Butyl Ether (**ETBE**), tert-Amyl Methyl Ether (**Tame**), and tert-Butanol (**TBA**). The groundwater laboratory results for the wells sampled are represented within the attached report. The next quarterly sampling is scheduled for January 2012.

Gallardo & Associates, Inc. understands that you will forward a copy of this report to the **Alameda County Environmental Health Department (ACEHD)** for their review. Please call me, if you have any questions at (916)358-3719

Respectfully,

Gallardo & Associates, Inc.

Rafael Gallardo
President/Professional Geologist, P.G.

GALLARDO & ASSOCIATES, INC.
Environmental and Geological Services

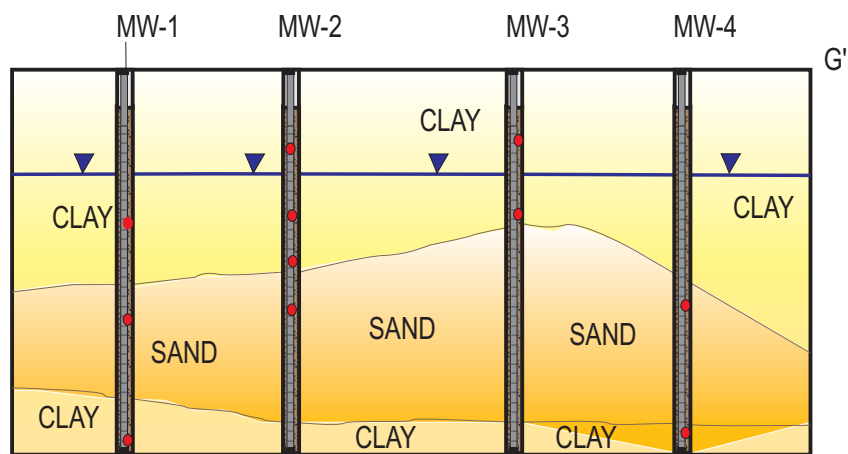

**GROUNDWATER QUARTERLY MONITORING
WELL REPORT**
for
Former EZ-SERVE 100979 King City Site

2011 THIRD QUARTER

GALLARDO & ASSOCIATES, INC.

304 Belle Court, El Dorado Hills, CA 95762
(916) 358-3719 and (707) 332-0966
(916) 358-3719 FAX

Environmental and Geological Services

We solve the problem!

**2011 THIRD QUARTER GROUNDWATER MONITORING REPORT
for
FORMER RPMS (E-Z SERVE) SITE 100877
525 WEST A STREET IN HAYWARD, CALIFORNIA.**

**PREPARED FOR:
Restructure Petroleum Marketing Services of California, (RPMS)
9519 E. ML King Blvd., Suite 100
Tampa, Florida 33610**

**SUBMITTED TO:
Mr. Mark Detterman, P.G., C.E.G.
Alameda County Environmental Health Department (ACEHD)
1131 Harbor Bay Parkway
Alameda, CA. 94502**

**PREPARED BY:
Rafael L. Gallardo**

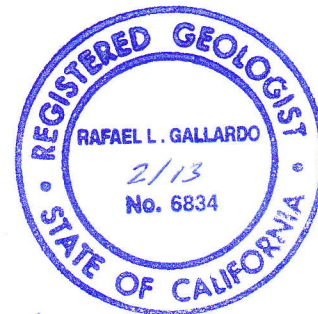

Rafael L. Gallardo, President/Professional Geologist, P. G. No. 6834

GALLARDO & ASSOCIATES, INC. PROJECT NO. 001.11

October 17, 2011

TABLE OF CONTENTS

	Page
1.0 INTRODUCTION	1
1.1 Site Location and Description	1
1.2 Previous Work and Site Conditions	1
1.3 Site Conceptual Model	4
1.3.1 Soil Model	4
1.3.2 Groundwater Model	4
2.0 GROUNDWATER SAMPLING	5
2.1 Groundwater Elevation Measurements	5
2.3 Well Survey	5
2.2 Monitoring Well Sampling	23
3.0 ANALYTICAL RESULTS	23
3.1 Monitoring Well Sampling Analytical Results	23
4.0 CONCLUSIONS	58
5.0 RECOMMENDATIONS	58
6.0 SCHEDULE OF ACTIVITIES FOR NEXT QUARTER	58
7.0 REPORT DISTRIBUTION	58
8.0 LIMITATIONS	59
9.0 REFERENCES	59
9.1 Geological References	59
 APPENDIX A	
Purge Data (July 25, 2011).	
 APPENDIX B	
Analytical Data Sheets and Chain-of-Custody Records for Monitoring Well Sampling (July 25, 2011).	

LIST OF TABLES

TABLE 1 Groundwater Elevation Data 6
TABLE 2 Historical Groundwater Analytical Results 24
TABLE 2A Historical Fuel Oxygenates Groundwater Analytical Results 41

LIST OF FIGURES

FIGURE 1 Site Area Location Map 2
FIGURE 2 Monitoring Well Location Map 3
FIGURE 3 Groundwater Gradient Map (**July 25, 2011**) **Appendix C**
FIGURE 4 TPH-g Groundwater Isoconcentration Map (**July 25, 2011**) **Appendix C**

1.0 INTRODUCTION

1.1 Site Location and Description

The site is located at 525 West A Street in Hayward, California, (See **Figure 1**). The property is an active gasoline station and convenience store bordered along the south side by West A Street and along the east side by Garden Street. The west side of the property is bordered by retail and commercial property, while the north side is bordered by a small trailer park. The site is relatively flat and the surface consists of natural ground planters, concrete and asphalt. According to previous consultants, the former owner (EZ-Serve) removed four UST's in 1990. The site remained an empty lot until the current Vallero station was constructed in 2008. The site currently contains two active underground fuel storage tanks (UST's), containing gasoline and diesel fuel, and one UST for bio-diesel fuel storage. which were removed in August 1989. The site currently contains ten on-site and eight off-site groundwater monitoring wells. However, four have been covered over and cannot be found (MW-8, MW-10, MW-15, and MW-16). According to the USGS Topographic map and Virgil Chavez Land Surveying the site rests at an approximate elevation of between 46.28 and 48.26 feet, (See **Figure 2**).

1.2 Previous Work and Site Condition

In 1986, *Converse Environmental Consultants of California (CECC)* conducted an initial site evaluation consisting of three exploratory soil borings to a depth of 30 feet and converted them into groundwater monitoring wells (**MW-1** through **MW-3**).

According to the previous consultants, the first leakage of the UST's occurred November 1986, and the UST's were removed in June 1990.

In January 1992, *Associated Soils Analysis (ASA)* installed six new groundwater monitoring wells to replace the previously installed wells (**MW-1** through **MW-6**). Apparently, wells MW-2, MW-5, and MW-6 were destroyed and wells MW-1, MW-3, and MW-4 were damaged during tank removal activities. CECC well MW-1 (installed in 1987) was redesigned as **MW-1A**.

In June 1993, ASA installed four additional wells to a depth of 30 feet bgs (**MW-7** through **MW-10**).

In February 1995, Brown and Caldwell (BAC) conducted an environmental site evaluation consisting of 17 groundwater hydro-punch samples and the installation of four additional wells (MW-11 through MW-14). They also conducted a utilities search and well search within a half-mile radius of the site.

In 1995 BAC conducted a Human Health Risk Assessment (HHRA). The results of the HHRA indicated that the underlying soil site did not pose a threat both current and future to children or adults. However, there was an unacceptable risk associated with residential use of groundwater.

In June 1997 CECC installed three additional groundwater monitoring wells to a depth between 30 and 31 feet bgs (**MW-4** through **MW-6**).

In June 2002, ATC Associates, Inc. (ATC) installed three, four-inch diameter vapor extraction/air-

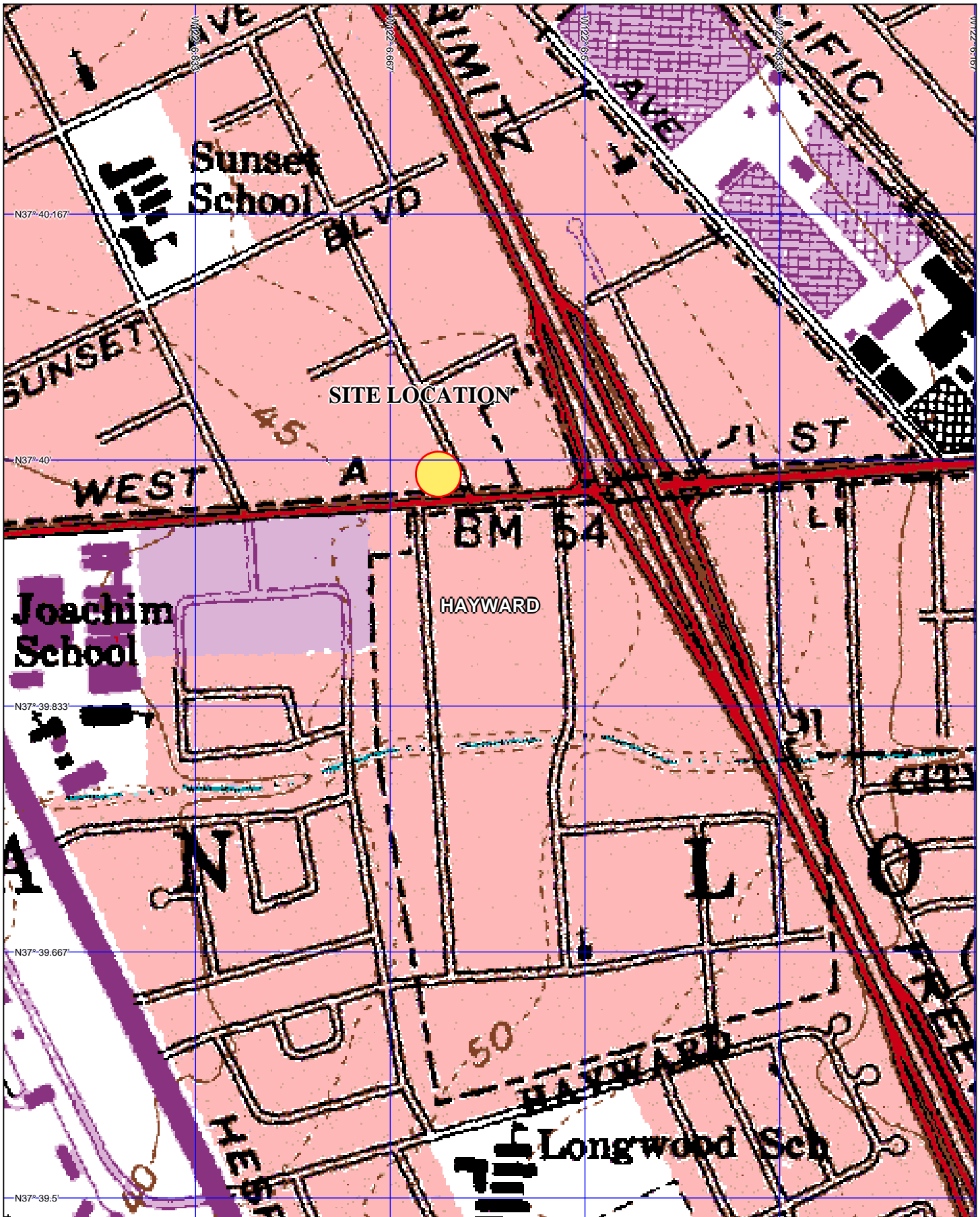



EXPLANATION
 ● (MW-1) Groundwater Monitoring Well Location.



GALLARDO & ASSOCIATES, INC.
Environmental and Geological Services

SITE MAP
 FORMER EZ SERVE NO.100877 HAYWARD SITE

FIGURE
2

sparging wells (**VEAS-1** through **VEAS-3**). The VE wells were screened from 5 to 15 feet bgs, while the AS wells were screened between 28 and 30 feet bgs. ATC also installed one, six-inch diameter extraction well (**EX-1**) to a depth of 25 feet bgs.

In September 2002, ATC prepared a Corrective Action Plan (CAP). The report included the results of two pilot tests: soil vapor extraction/air-sparging and a groundwater pump test.

Between January and July 2008, approximately 988 cubic yards of soil were excavated from the west and central areas of the site.

On September 24, 2009, GeoEnviro Services, Inc. (GESI) collected soil samples from six geoprobe direct-push drilled borings (**SB-1** through **SB-6**) and hydropunched six groundwater locations (**SB-1** through **SB-3**, **SB-4A**, **SB-5**, and **SB-6**).

In February 2011, GESI presented a Site Conceptual Model and Preferential Pathway Study report dated February 28, 2011.

In late summer 2011, *Gallardo & Associates, Inc.* was retained by RPMS to take over all environmental work at the site.

1.3 Site Conceptual Model

1.3.1 Soil Model

Based on the data collected and evaluated by GESI, the site soils consist mainly of clay and silty clay, with discontinuous layers of silt and clayey silt within the upper ten feet. Several thin layers of silty sand with minor sand zones are present at depths between 10 and 22 feet bgs.

The soil has been impacted by petroleum hydrocarbons in the form of TPH-g and BTEX. The highest concentration of TPH-g (670 ppm) were detected beneath VEAS-1 at a depth of 20 feet bgs, while the highest benzene (2.7 ppm) concentration was detected beneath MW-4 at a depth of 16 feet bgs.

Based on the data reviewed, it appears that the impacted soil has been defined laterally to the west. However, the lateral extent of the impacted soil plume still needs to be defined to the north, east, and to the south. In addition, the vertical extent of the impacted soil still needs to be defined.

1.3.2 Groundwater Model

The direction of groundwater flow beneath the site has been historically to the west. Groundwater depth varies from season to season and fluctuates between 10.5 and 21.7 feet bgs. Historically, the highest concentration of TPH-g was detected within well MW-9 (86,000 ppb), while the highest concentration of benzene was detected beneath well MW-2 (23,000 ppb), and the highest concentration of MTBE was detected beneath well MW-6 (2,700 ppb). The highest current groundwater concentrations detected at the site are from MW-1, (TPH-g @ **3,600** ppb) MW-9 (benzene @ **88** ppb) and MW-3 (MTBE 320 ppb).

Based on the data reviewed, it appears that the extent of the groundwater plume has not been defined laterally or vertically.

2.0 GROUNDWATER SAMPLING

2.1 Groundwater Elevation Measurements

On **July 25, 2011**, groundwater elevations were measured for monitoring wells MW-1, MW-1A, MW-3, MW-4, MW-5, MW-6, MW-9, MW-12, MW-13, MW-14, EX-1, VEAS-2, and VEAS-3 prior to purging. The depth to groundwater was measured using a Slope Indicator electronic groundwater measuring device equipped with a 100-foot tape capable of measuring the depth to water within a 100th-of-an-foot. The data was recorded on Sample Event Data Sheets and is presented in **Appendix A**.

The groundwater flow direction was calculated from the **July 25, 2011** measurements. The groundwater elevation data is shown on **Figure 3**. Groundwater flow beneath the property for this quarter was generally to the Northwest, with a hydraulic gradient was approximately 0.008 ft/ft. However, a groundwater depression was observed around wells MW-3, MW-4, MW-5, and EX-1.

2.2 Groundwater Well Survey

Wells MW-1, MW-1A, MW-3, MW-4, MW-5, MW-6, MW-9, MW-12, MW-13, MW-14, EX-1, VEAS-2, and VEAS-3 were re-surveyed initially on July 12, 2011 and completed on August 4, 2011. The survey was performed by Virgil Chavez Land Surveying. The benchmark used for the survey was a City disk at Victoria on the south side of A Street. The latitude, Longitude, and coordinates are for top of casings and are based on the California State Coordinate System, Zone II, (NAD83). Benchmark Elevation = 46.15 feet (NGVD 29).

2.3 Monitoring Well Sampling

Table 1 contains monitoring well elevations, depths to static water, and groundwater surface elevations.

TABLE 1
Historical Groundwater Elevation Data for
525 West A Street in Hayward, California

WELL	DATE MEASURED	ELEVATION OF TOP OF CASING (Feet)	DEPTH TO WATER (Feet)	ELEVATION OF STATIC WATER LEVEL (Feet)
MW-1	2/5/92	41.75	20.82	20.93
	9/11/92		20.08	21.67
	12/22/92		19.79	21.96
	3/3/93		16.23	25.52
	6/23/93		16.86	24.89
	9/30/93		18.04	23.71
	2/6/94		18.15	23.60
	5/2/94		17.26	24.49
	7/1/94		17.60	24.15
	9/20/94		20.59	21.16
	12/5/92		17.83	23.92
	3/10/95		14.67	27.08
	3/15/95		14.43	27.32
	9/23/96		14.92	26.83
	12/4/96		15.61	26.14
	4/8/97		13.25	28.50
	6/30/97		14.68	27.07
	11/25/97		15.99	25.76
	6/1/98		9.98	31.77
	6/14/01		15.05	26.70
	11/7/01		16.31	25.44
	1/30/02		14.15	27.60
	5/29/02		14.55	27.20
	8/14/02		15.56	26.19
	11/15/02		16.10	25.65
	10/25/04		15.99	25.76
	12/23/04		15.64	26.11
	2/25/05		12.79	28.96
	5/19/05		12.27	29.48
	9/15/05		14.30	27.45
	3/20/06		11.44	30.31
	5/25/06		11.05	30.70
	8/23/06	12.75	29.00	
3/14/07	13.12	28.63		
6/11/07	14.42	27.33		
8/1/07	14.97	26.78		
2/27/08	13.35	28.40		
5/13/08	14.51	27.24		
8/27/08	15.37	26.38		
11/18/08	15.88	25.87		
3/11/09	13.65	28.10		
9/22/09	16.41	25.34		
3/9/10	13.84	27.91		
9/9/10	14.96	26.79		
01/25/11	13.85	27.90		
07/25/11	46.28	13.41	32.87	

TABLE 1
Historical Groundwater Elevation Data for
525 West A Street in Hayward, California

WELL	DATE MEASURED	ELEVATION OF TOP OF CASING (Feet)	DEPTH TO WATER (Feet)	ELEVATION OF STATIC WATER LEVEL (Feet)
MW-1A	06/23/93	43.40	17.80	25.75
	09/30/93		--	--
	02/06/94		18.89	24.51
	05/02/94		18.35	38.40
	07/01/94		18.45	24.95
	09/20/94		21.72	21.84
	12/05/94		18.87	24.58
	03/10/95		15.83	27.57
	03/15/95		15.55	27.89
	09/23/96		16.00	27.41
	12/04/96		16.55	26.85
	04/08/97		14.15	29.25
	06/30/97		15.57	27.83
	11/25/97		16.91	26.49
	06/01/98		10.78	32.62
	06/14/01		15.93	27.48
	11/07/01		17.32	26.08
	01/30/02		15.05	28.35
	05/29/02		15.49	27.91
	08/14/02		16.50	26.90
	11/15/02		17.04	26.36
	10/25/04		16.90	26.50
	12/23/04		16.60	26.80
	02/25/05		13.75	29.65
	05/19/05		13.12	30.28
	09/15/05		15.16	28.24
	11/10/05		15.78	27.62
	03/20/06		12.64	30.76
	05/25/06		11.85	31.55
	08/23/06		13.55	29.85
	03/14/07		14.00	29.40
	06/12/07		15.30	28.10
	08/01/07	15.84	27.56	
02/27/08	14.10	29.30		
05/13/08	--	--		
08/27/08	--	--		
11/18/08	--	--		
03/11/09	--	--		
09/22/09	--	--		
03/09/10	--	--		
09/09/10	--	--		
01/25/11	--	--		
07/25/11	47.00	Dry	--	

TABLE 1
Historical Groundwater Elevation Data for
525 West A Street in Hayward, California

WELL	DATE MEASURED	ELEVATION OF TOP OF CASING (Feet)	DEPTH TO WATER (Feet)	ELEVATION OF STATIC WATER LEVEL (Feet)
MW-2	02/05/92	43.26	22.35	20.91
	09/11/92		21.67	21.59
	12/22/92		21.39	21.87
	03/03/93		17.75	25.51
	06/23/93		18.42	24.84
	09/30/93		19.63	23.63
	02/06/94		19.61	23.65
	05/02/94		19.84	23.42
	07/01/94		19.18	24.08
	09/20/94		22.17	21.09
	12/06/94		19.37	23.89
	03/10/95		16.33	26.93
	03/15/95		16.89	26.37
	09/23/96		16.61	26.65
	12/04/96		17.19	26.07
	04/08/97		14.86	28.40
	06/30/97		16.28	26.98
	11/25/97		17.56	25.70
	06/01/98		11.58	31.68
	06/14/01		16.63	26.63
	11/07/01		17.85	25.41
	01/30/02		15.65	27.61
	05/29/02		16.12	27.14
	08/14/02		17.20	26.06
	11/15/02		17.63	25.63
	10/25/04		17.53	25.73
	12/23/04		17.15	26.11
	02/25/05		14.30	28.96
	05/19/05		13.81	29.45
	09/15/05		Inaccessible	-
11/10/05	16.39	26.87		
03/20/06	13.00	30.26		
05/25/06	Destroyed 03/02/06	-		

TABLE 1
Historical Groundwater Elevation Data for
525 West A Street in Hayward, California

WELL	DATE MEASURED	ELEVATION OF TOP OF CASING (Feet)	DEPTH TO WATER (Feet)	ELEVATION OF STATIC WATER LEVEL (Feet)
MW-3	02/05/92	43.89	21.85	22.04
	09/11/92		21.13	22.76
	12/22/92		20.88	23.01
	03/03/93		17.29	26.60
	06/23/93		17.88	26.01
	09/30/93		19.18	24.71
	02/06/94		19.21	24.68
	05/02/94		18.30	25.59
	07/01/94		18.63	25.26
	09/20/94		21.64	22.25
	12/06/94		19.15	24.74
	03/10/95		16.33	27.56
	03/15/95		16.89	27.00
	09/23/96		16.11	27.78
	12/04/96		16.63	27.26
	04/08/97		14.25	29.64
	06/30/97		15.70	28.19
	11/25/97		16.99	26.90
	06/01/98		--	--
	06/14/01		16.02	27.87
	11/07/01		17.33	26.56
	01/30/02		15.10	28.79
	05/29/02		15.63	28.26
	08/14/02	16.63	27.26	
	11/15/02	17.10	26.79	
	10/25/04	17.01	26.88	
	12/20/04	16.64	27.25	
	02/25/05	Could not Locate	Could not locate	-
	05/19/05	Could not locate	Couldn't locate	--
	09/15/05	Couldn't locate	Couldn't locate	--
	11/10/05	Couldn't locate	Couldn't locate	--
	03/20/06	12.44	31.45	
	05/25/06	12.05	31.84	
08/23/06	13.75	30.14		
03/14/07	14.11	29.78		
06/12/07	15.43	28.46		
08/01/07	15.97	27.92		
02/27/08	14.40	29.49		
05/13/08	15.52	28.37		
08/27/08	16.79	27.10		
11/18/08	17.30	26.59		
03/11/09	15.37	28.52		
09/22/09	17.86	26.03		
03/09/10	15.11	28.78		
09/09/10	16.39	27.50		
01/25/11	15.19	28.70		
07/25/11	14.90	32.34		
		47.24		

TABLE 1
Historical Groundwater Elevation Data for
525 West A Street in Hayward, California

WELL	DATE MEASURED	ELEVATION OF TOP OF CASING (Feet)	DEPTH TO WATER (Feet)	ELEVATION OF STATIC WATER LEVEL (Feet)
MW-4	2/5/92	42.76	21.31	21.45
	9/11/92		20.62	22.14
	12/22/92		20.37	22.39
	3/3/93		16.78	25.98
	6/23/93		17.45	25.31
	9/30/93		18.64	24.12
	2/6/94		18.59	24.17
	5/2/94		17.81	24.95
	7/1/94		18.13	24.63
	9/20/94		21.13	21.63
	12/6/94		18.36	24.40
	3/10/95		15.25	27.51
	3/15/95		14.89	27.87
	9/23/96		15.56	27.20
	12/4/96		16.11	26.65
	4/8/97		13.73	29.03
	6/30/97		15.19	27.57
	11/25/97		16.49	26.27
	6/1/98		10.42	32.34
	6/14/01		15.55	27.21
	11/7/01		16.81	25.95
	1/30/02		14.60	28.16
	5/29/02		15.14	27.62
	8/14/02		16.07	26.69
	11/15/02		16.61	26.15
	10/25/04		16.50	26.26
	12/23/04		16.20	26.56
	2/25/05		13.30	29.46
	5/19/05		12.74	30.02
	9/15/05		14.80	27.96
	11/10/06		15.45	27.31
	3/20/06		11.93	30.83
	5/25/06		11.49	31.27
	8/23/06		13.23	29.53
	3/14/07		13.65	29.11
	6/12/07		14.92	27.84
	8/1/07		15.48	27.28
	2/27/08		Could not locate well	-
	5/13/08		15.02	27.74
	8/27/08		16.28	26.48
11/18/08	16.81	25.95		
3/11/09	14.87	27.89		
9/22/09	17.33	25.43		
3/9/10	14.60	28.16		
9/9/10	15.88	26.88		
11/22/10	17.15	25.61		
½5/11	14.47	28.29		
07/25/11	46.70	14.38	32.32	

TABLE 1
Historical Groundwater Elevation Data for
525 West A Street in Hayward, California

WELL	DATE MEASURED	ELEVATION OF TOP OF CASING (Feet)	DEPTH TO WATER (Feet)	ELEVATION OF STATIC WATER LEVEL (Feet)
MW-5	2/5/92	42.10	20.93	21.17
	9/11/92		20.27	21.83
	12/22/92		19.99	22.11
	3/3/93		16.49	25.61
	6/23/93		17.02	25.08
	9/30/93		18.25	23.85
	2/6/94		18.26	23.84
	5/2/94		17.50	24.60
	7/1/94		17.79	24.31
	9/20/94		20.77	21.33
	15/5/92		18.02	24.08
	3/10/95		14.93	27.17
	3/15/95		14.70	27.40
	9/23/96		15.19	26.91
	12/4/96		15.78	26.32
	4/8/97		13.39	28.71
	6/30/97		14.83	27.27
	11/25/97		16.14	25.96
	6/1/98		10.10	32.00
	6/14/01		15.19	26.91
	11/7/01		16.47	25.63
	1/30/02		14.27	27.83
	5/29/02		14.73	27.37
	8/14/02		15.73	26.37
	11/15/02		16.27	25.83
	10/25/04		16.15	25.95
	12/23/04		15.88	26.22
	2/25/05		12.97	29.13
	5/19/05		12.48	29.62
	9/15/05		15.47	26.63
11/10/08	15.03	27.07		
3/20/06	11.79	30.31		
5/25/06	11.15	30.95		
8/23/06	12.88	29.22		
3/14/07	13.28	28.82		
6/11/07	14.56	27.54		
8/1/07	15.11	26.99		
2/27/08	13.49	28.61		
5/13/08	14.64	27.46		
8/27/08	15.93	26.17		
11/18/08	16.43	25.67		
3/11/09	14.53	27.57		
9/22/09	16.95	25.15		
3/9/10	14.25	27.85		
9/9/10	15.50	26.60		
11/22/10	16.78	25.32		
1/25/11	14.42	27.68		
07/25/11	46.33	14.03	32.30	

TABLE 1
Historical Groundwater Elevation Data for
525 West A Street in Hayward, California

WELL	DATE MEASURED	ELEVATION OF TOP OF CASING (Feet)	DEPTH TO WATER (Feet)	ELEVATION OF STATIC WATER LEVEL (Feet)
MW-6	02/05/92	42.33	21.29	21.04
	09/11/92		20.56	21.77
	12/22/92		20.31	22.02
	03/03/93		16.83	25.50
	06/23/93		17.30	25.03
	09/30/93		19.05	23.28
	02/06/94		18.55	23.78
	05/02/94		17.74	24.59
	07/01/94		18.09	24.24
	09/20/94		21.05	21.28
	12/06/94		18.33	24.00
	03/10/95		15.35	26.98
	03/15/95		14.91	27.42
	09/23/96		15.50	26.83
	12/04/96		16.06	26.27
	04/08/97		13.64	28.69
	06/30/97		15.08	27.25
	11/25/97		16.40	25.93
	06/01/98		10.31	32.02
	06/14/01		15.46	26.87
	11/07/01		16.71	25.62
	01/30/02		14.60	27.73
	05/29/02		14.99	27.34
	08/14/02		16.03	26.30
	11/15/02		16.53	25.80
	10/25/04		16.43	25.90
	12/23/04		16.12	26.21
	02/25/05		13.13	29.20
	05/19/05		12.61	29.72
	09/15/05		14.69	27.64
	11/10/05		15.30	27.03
	03/20/06		11.88	30.45
	05/25/06	11.38	30.95	
08/23/06	13.10	29.23		
03/14/07	13.52	28.81		
06/12/07	14.80	27.53		
08/01/07	15.38	26.95		
02/27/08	13.79	28.54		
05/13/08	14.93	27.40		
08/27/08	Not Accessible	-		
11/18/08	Not Accessible	-		
03/11/09	Not Accessible	-		
09/22/09	Not Accessible	-		
03/09/10	Not Accessible	-		
09/09/10	Not Accessible	-		
01/25/11	Not Accessible	-		
07/25/11	47.23	14.31	32.92	

TABLE 1
Historical Groundwater Elevation Data for
525 West A Street in Hayward, California

WELL	DATE MEASURED	ELEVATION OF TOP OF CASING (Feet)	DEPTH TO WATER (Feet)	ELEVATION OF STATIC WATER LEVEL (Feet)
MW-7	06/23/93	42.70	17.87	24.83
	09/30/93		18.94	23.76
	02/06/94		19.11	23.63
	05/02/94		18.11	24.59
	07/01/94		18.72	23.98
	09/20/94		21.41	21.29
	12/05/94		18.66	24.04
	03/10/95		15.72	26.98
	03/14/95		15.23	27.47
	09/23/96		15.94	26.76
	12/04/96		16.43	26.27
	04/08/97		14.10	28.60
	06/30/97		15.51	27.19
	11/25/97		16.80	25.90
	06/01/98		10.31	32.39
	06/14/01		15.46	27.24
	11/07/01		--	--
	01/30/02		14.97	27.73
	05/29/02		15.49	27.21
	08/14/02		16.44	26.26
	11/15/02		16.91	25.79
	10/25/04		not located	-
	05/19/05		13.06	29.64
	09/15/05		not located	-
	11/10/05		15.78	26.92
	03/20/06		not located	-
	05/25/06		Well was blocked	-
	08/23/06		13.60	29.10
	03/14/07		14.00	28.70
	06/12/07		Well not accessible	-
	08/01/07		15.82	26.88
	02/27/08		14.24	28.46
	05/13/08		14.37	28.33
	08/27/08		16.62	26.08
11/18/08	17.12	25.58		
03/11/09	15.28	27.42		
09/22/09	17.65	25.05		
03/09/10	14.95	27.75		
09/09/10	16.23	26.47		
01/25/11	15.02	27.68		
07/25/11	Well not accessible	--		

TABLE 1
Historical Groundwater Elevation Data for
525 West A Street in Hayward, California

WELL	DATE MEASURED	ELEVATION OF TOP OF CASING (Feet)	DEPTH TO WATER (Feet)	ELEVATION OF STATIC WATER LEVEL (Feet)
MW-8	06/23/93	97.61	17.64	79.97
	09/30/93		18.85	78.76
	02/06/94		18.91	78.70
	05/02/94		18.11	79.50
	07/01/94		18.43	79.18
	09/20/94		21.43	76.18
	12/05/94		18.72	78.89
	03/10/95		18.69	78.92
	03/15/95		14.83	82.78
	09/23/96		15.83	81.78

TABLE 1
Historical Groundwater Elevation Data for
525 West A Street in Hayward, California

WELL	DATE MEASURED	ELEVATION OF TOP OF CASING (Feet)	DEPTH TO WATER (Feet)	ELEVATION OF STATIC WATER LEVEL (Feet)
MW-9	06/23/93	95.41	15.94	79.47
	09/30/93		17.05	78.36
	02/06/94		17.07	78.34
	05/02/94		16.24	79.17
	07/01/94		15.59	79.82
	09/20/94		16.61	78.80
	12/05/94		16.58	78.83
	03/10/95		--	--
	03/15/95		14.18	81.23

TABLE 1
Historical Groundwater Elevation Data for
525 West A Street in Hayward, California

WELL	DATE MEASURED	ELEVATION OF TOP OF CASING (Feet)	DEPTH TO WATER (Feet)	ELEVATION OF STATIC WATER LEVEL (Feet)
MW-10	06/23/93	97.11	17.39	79.72
	09/30/93		18.58	78.53
	02/06/94		18.61	78.50
	05/02/94		17.83	79.28
	07/01/94		18.17	78.94
	09/20/94		21.15	75.96
	12/05/94		18.43	78.68
	03/10/95		15.37	81.74
	03/15/95		15.97	81.14
	09/23/96		15.59	81.52
	12/04/96		16.15	80.96

TABLE 1
Historical Groundwater Elevation Data for
525 West A Street in Hayward, California

WELL	DATE MEASURED	ELEVATION OF TOP OF CASING (Feet)	DEPTH TO WATER (Feet)	ELEVATION OF STATIC WATER LEVEL (Feet)
MW-11	02/10/95	92.68	11.80	80.88
	03/10/95		11.58	81.10
	03/15/95		13.96	78.72
	09/23/96		12.29	80.39
	12/04/96		--	--
	04/08/97		10.51	82.17

TABLE 1
Historical Groundwater Elevation Data for
525 West A Street in Hayward, California

WELL	DATE MEASURED	ELEVATION OF TOP OF CASING (Feet)	DEPTH TO WATER (Feet)	ELEVATION OF STATIC WATER LEVEL (Feet)
MW-12	02/10/95	43.25	16.30	26.95
	03/10/95		16.37	26.88
	03/14/95		15.69	27.56
	09/23/96		16.67	26.58
	12/04/96		17.16	26.09
	04/08/97		14.88	28.37
	06/30/97		16.33	26.92
	11/25/97		17.61	25.64
	06/01/98		11.58	31.67
	06/14/01		16.62	26.63
	11/07/01		17.91	25.34
	01/30/02		15.60	27.65
	05/29/02		16.24	27.01
	08/14/02		17.20	26.05
	11/15/02		17.62	25.63
	10/25/04		Well not sampled	-
	02/25/05		14.72	28.53
	05/19/05		13.80	29.45
	09/15/05		15.94	27.31
	11/10/05		16.51	26.74
	03/20/06	13.04	30.21	
	05/25/06	12.65	30.60	
	08/23/06	14.44	28.81	
	03/14/07	14.70	28.55	
	06/11/07	16.02	27.23	
	08/01/07	16.57	26.68	
	02/27/08	14.99	28.26	
	05/13/08	16.12	27.13	
	08/27/08	17.37	25.88	
	11/18/08	17.82	25.43	
03/11/09	15.88	27.37		
09/22/09	18.33	24.92		
03/09/10	15.61	27.64		
01/25/11	15.71	27.54		
07/25/11	47.91	15.54	32.37	

TABLE 1
Historical Groundwater Elevation Data for
525 West A Street in Hayward, California

WELL	DATE MEASURED	ELEVATION OF TOP OF CASING (Feet)	DEPTH TO WATER (Feet)	ELEVATION OF STATIC WATER LEVEL (Feet)
MW-13	02/10/95	40.97	14.45	26.52
	03/10/95		14.30	26.67
	03/14/95		15.81	25.16
	09/23/96		14.60	26.37
	12/04/96		--	--
	04/08/97		12.75	28.22
	06/30/97		14.13	26.84
	11/25/97		15.48	25.49
	06/01/98		9.58	31.39
	06/14/01		14.51	26.46
	11/07/01		15.85	25.12
	01/30/02		13.65	27.32
	05/29/02		14.10	26.87
	08/14/02		15.13	25.84
	11/15/02		--	--
10/25/04	13.28	27.69		

TABLE 1
Historical Groundwater Elevation Data for
525 West A Street in Hayward, California

WELL	DATE MEASURED	ELEVATION OF TOP OF CASING (Feet)	DEPTH TO WATER (Feet)	ELEVATION OF STATIC WATER LEVEL (Feet)
MW-14	02/10/95	43.19	16.28	26.91
	03/10/95		16.33	26.86
	03/14/95		14.87	28.32
	09/23/96		16.67	26.52
	12/04/96		17.06	26.13
	04/08/97		14.77	28.42
	06/30/97		16.22	26.97
	11/25/97		17.52	25.67
	06/01/98		11.46	31.73
	06/14/01		16.53	26.66
	11/07/01		17.84	25.35
	01/30/02		15.55	27.64
	05/29/02		16.14	27.05
	08/14/02		17.12	26.07
	11/15/02		17.56	25.63
	10/25/04		-	-
	02/25/05		14.20	28.99
	05/19/05		13.71	29.48
	09/15/05		-	-
	11/10/05		-	-
	03/20/06		12.94	30.25
	05/25/06		12.68	30.51
	08/23/06		15.32	27.87
	03/14/07		14.58	28.61
	06/11/07		15.95	27.24
	08/01/07		16.47	26.72
	02/27/08		14.91	28.28
	05/13/08		16.03	27.16
	08/27/08	17.28	25.91	
	11/18/08	17.75	25.44	
03/11/09	15.83	27.36		
09/22/09	18.28	24.91		
03/09/10	15.54	27.65		
01/25/11	15.63	27.56		
07/25/11	47.90	15.43	32.47	

TABLE 1
Historical Groundwater Elevation Data for
525 West A Street in Hayward, California

WELL	DATE MEASURED	ELEVATION OF TOP OF CASING (Feet)	DEPTH TO WATER (Feet)	ELEVATION OF STATIC WATER LEVEL (Feet)
EX-1	08/14/02	47.15	16.58	--
	11/15/02		17.02	--
	10/25/04		16.91	--
	12/23/04		16.60	--
	02/25/05		13.72	--
	05/19/05		13.13	--
	09/15/05		15.20	--
	11/10/05		15.80	--
	03/20/06		12.35	--
	05/25/06		11.88	--
	08/23/06		13.62	--
	03/14/07		14.00	--
	06/11/07		15.34	--
	08/01/07		15.89	--
	02/27/08		Could not locate well	--
	05/13/08		Could not locate well	--
	08/27/08		16.70	--
	11/18/08		17.20	--
	03/11/09		15.38	--
	09/22/09		17.71	--
03/09/10	15.00	--		
09/09/10	16.38	--		
07/25/11	14.81	32.34		

TABLE 1
Historical Groundwater Elevation Data for
525 West A Street in Hayward, California

WELL	DATE MEASURED	ELEVATION OF TOP OF CASING (Feet)	DEPTH TO WATER (Feet)	ELEVATION OF STATIC WATER LEVEL (Feet)
VEAS-2	02/25/05	-	13.68	00.00
	05/19/05		13.11	
	11/10/05		DRY	
	07/25/11	47.19	14.68	32.51

TABLE 1
Historical Groundwater Elevation Data for
525 West A Street in Hayward, California

WELL	DATE MEASURED	ELEVATION OF TOP OF CASING (Feet)	DEPTH TO WATER (Feet)	ELEVATION OF STATIC WATER LEVEL (Feet)
VEAS-3	07/25/11	47.27	14.10	33.17

2.2 Monitoring Well Sampling

The monitoring wells were sampled on **July 25, 2011**. A total of three well volumes were purged from each well so that a full recharge could occur prior to sampling. During purging, temperature, conductivity, and pH readings were taken until stabilization of these three groundwater monitoring parameters was accomplished (three consecutive readings within ten percent of each other). After each well recharged to approximately 80 % or more of its original water column height, groundwater samples were then collected for laboratory analysis.

Groundwater samples were collected by placing a disposable bailer down the center of each well casing to allow for an in-situ water sample collection. Water was captured in each bailer and was placed in 40 ml VOA vials containing HCL as a preservative. The samples were prepared according to EPA SW 849 and capped with Teflon-lined septa caps. A new bailer was used at each monitoring well location. The purged water was placed in a 55-gallon D.O.T. approved drum and stored on-site for subsequent disposal by the owner Bert Lathrop. The sampling event data sheets are presented in **Appendix A**.

Please note that all wells, with the exception of wells MW-7, MW-8, MW-10, MW-15, and MW-16 were sampled this quarter. MW-7 could not be sampled due to access problems and will need to be moved. MW-8 appears to be covered by sidewalk and will need an encroachment permit to drill out, while wells MW-10, MW-15, and MW-16 could not be located.

3.0 ANALYTICAL RESULTS

3.1 Monitoring Well Sampling Analytical Results

The cumulative analytical groundwater data is summarized in **Tables 2** and **2A**. The laboratory analytical data sheets and chain-of-custody records for the **July 25, 2011** sampling are included as **Appendix A**. The laboratory reporting limits for MTBE analysis are 5.0 ug/L (ppb), for TPH-g analysis 50 ug/L (ppb) and for BTEX analysis 0.5 ug/L (ppb).

The groundwater laboratory results for the wells sampled are summarized in **Tables 2** and **2A**.

TABLE 2
Groundwater Sample Results for 525 West A Street in Hayward, California

WELL NUMBER	DATE	TPH-d ug/L	TPH-g ug/L	Benzene ug/L	Toluene ug/L	Ethyl Benzene ug/L	Xylenes ug/L	
MW-1	02/05/92	-	46,000	7,600	2,300	2,400	6,500	
	09/11/92		48,000	9,000	1,200	1,800	4,600	
	12/22/92		84,000	22,000	1,600	4,800	17,000	
	03/03/93		54,000	16,000	1,600	1,900	4,300	
	06/23/93		30,000	18,000	1,100	1,400	3,700	
	09/30/93		33,000	10,000	440	940	1,700	
	02/06/94		64,000	18,000	1,600	4,700	12,000	
	05/02/94		7,200	2,100	29	490	520	
	07/01/94		13,000	3,700	150	550	12,000	
	09/20/94		10,000	3,100	75	440	870	
	12/05/92		8,700	3,700	87	520	950	
	03/10/95		--	--	--	--	--	--
	03/15/95			290	56	2	12	47
	09/23/96			20,000	5,200	860	700	1,100
	12/04/96			17,000	3,100	64	610	1,200
	04/08/97			2,100	430	15	52	85
	06/30/97			10,000	2,100	<	<	320
	11/25/97			16,000	2,100	23	76	240
	06/01/98			19,000	6,100	460	1,100	2,300
	06/14/01			6,000	380	8.4	260	180
	11/07/01			12,000	1,000	30	1,000	740
	01/30/02			8,800	690	16	480	270
	05/29/02			6,400	330	13	250	260
	08/14/02			5,500	470	14	360	160
	11/15/02			10,000	440	16	310	150
	10/25/04			4,300	260	3.3	150	32
	12/23/04			11,000	860	6.1	880	280
	02/25/05			11,000	710	6.7	720	330
	05/19/05			7,500	610	12	370	140
	09/15/05			6,100	300	3.5	280	71
	03/20/06			6,400	290	3.2	330	61
	05/25/06			4,200	300	6.4	100	40
	08/23/06			3,400	140	1.9	92	9.2
03/14/07			5,600	75	0.83	160	20	
06/11/07			5,400	90	<1.0	220	12	
08/01/07			5,300	130	<0.74	450	36	
02/27/08			1,090	11	<0.24	40	9.1	
05/13/08			4,530	77	<0.25	457	56	
08/27/08			3,350	45	1.1	261	16	
11/18/08			4,680	42	0.7	266	6.9	
03/11/09			5,180	69	2.0	440	10	
09/22/09			6,600	54	0.7	137	2.7	
03/09/10			4,670	70	<0.5	83	2.9	
09/09/10		1.7	4,750	39	0.7	46	2.4	
01/25/11			3,530	30	<0.5	85	1.7	
07/25/11			3,600	8.9	10	27	ND < 2.5	
#California Department of Health Services primary maximum contamination level for drinking water.			None Listed	1.0	150	300	1,750	

TABLE 2
Groundwater Sample Results for 525 West A Street in Hayward, California

WELL NUMBER	DATE	TPH-d ug/L	TPH-g ug/L	Benzene ug/L	Toluene ug/L	Ethyl Benzene ug/L	Xylenes ug/L
MW-1A	06/23/93	-	--	--	--	--	--
	09/30/93	-	--	--	--	--	--
	02/06/94	-	8,900	1,700	42	1,000	400
	05/02/94	-	--	--	--	--	--
	07/01/94	-	12,000	1,100	<1	920	1,100
	09/20/94	-	--	--	--	--	--
	12/05/94	-	--	--	--	--	--
	03/10/95	-	--	--	--	--	--
	03/15/95	-	--	--	--	--	--
	09/23/96	-	--	--	--	--	--
	12/04/96	-	52,000	420	140	1,000	3,500
	04/08/97	-	--	--	--	--	--
	06/30/97	-	17,000	180	<	140	1,100
	11/25/97	-	19,000	110	37	290	910
	06/01/98	-	18,000	200	17	230	820
	06/14/01	-	27,000	29	<5.0	620	520
	11/07/01	-	21,000	51	<5.0	700	510
	01/30/02	-	24,000	22	<5.0	390	330
	05/29/02	-	12,000	32	<5.0	550	270
	08/14/02	-	14,000	22	<2.0	510	240
	11/15/02	-	17,000	59	2.4	630	250
	10/25/04	-	2,200	1.3	<0.50	58	3.7
	12/23/04	-	3,100	2.2	<0.50	96	5.4
	02/25/05	-	7,300	4.7	1.1	140	24
	05/19/05	-	13,000	3.1	1.7	190	50
	09/15/05	-	4,000	0.84	<0.50	52	2.5
	11/10/05	-	12,000	<2.0	0.76	130	3.6
	03/20/06	-	3,300	1.1	<0.50	17	1
	05/25/06	-	1,600	0.79	<0.50	22	0.94
	08/23/06	-	4,700	1.6	1.1	84	1.8
	03/14/07	-	610	<0.50	<0.50	12	<0.50
	06/12/07	-	3,200	1.1	0.84	79	0.76
	08/01/07	-	440	0.31	<0.15	6.2	<0.34
	02/27/08	-	1,660	<0.18	<0.24	50	<0.45
	11/18/08	-	Dry	Dry	Dry	Dry	Dry
	03/11/09	-	Dry	Dry	Dry	Dry	Dry
#California Department of Health Services primary maximum contamination level for drinking water.			None Listed	1.0	150	300	1,750

TABLE 2
Groundwater Sample Results for 525 West A Street in Hayward, California

WELL NUMBER	DATE	TPH-d ug/L	TPH-g ug/L	Benzene ug/L	Toluene ug/L	Ethyl Benzene ug/L	Xylenes ug/L	
MW-2	02/05/92	-	67,000	13,000	4,700	820	1,300	
	09/11/92	-	57,000	9,000	1,400	1,200	8,400	
	12/22/92	-	31,000	9,900	350	2,000	4,100	
	03/03/93	-	17,000	5,100	1,300	720	1,900	
	06/23/93	-	60,000	23,000	1,500	4,500	17,000	
	09/30/93	-	38,000	12,000	780	1,500	6,500	
	02/06/94	-	34,000	8,900	450	2,000	5,500	
	05/02/94	-	18,000	3,800	260	1,100	3,500	
	07/01/94	-	18,000	3,700	510	870	2,600	
	09/20/94	-	19,000	4,500	300	1,200	4,000	
	12/06/94	-	22,000	4,700	340	1,400	4,500	
	03/10/95	-	--	--	--	--	--	--
	03/15/95	-	29,000	5,600	350	1,900	6,300	
	09/23/96	-	29,000	3,700	150	1,000	4,300	
	12/04/96	-	31,000	3,800	140	2,000	5,100	
	04/08/97	-	20,000	2,500	80	1,300	3,400	
	06/30/97	-	41,000	2,700	130	1,200	4,000	
	11/25/97	-	51,000	2,900	140	1,800	7,000	
	06/01/98	-	33,000	2,700	130	1,800	5,700	
	06/14/01	-	18,000	860	14	1,100	2,200	
	11/07/01	-	20,000	880	20	1,100	2,600	
	01/30/02	-	19,000	880	19	1,100	2,400	
	05/29/02	-	8,100	390	16	560	1,400	
	08/14/02	-	19,000	820	21	1,200	2,600	
	11/15/02	-	34,000	910	31	1,000	1,400	
	10/25/04	-	9,300	280	3.8	500	980	
	12/23/04	-	10,000	310	3.9	470	840	
	02/25/05	-	15,000	320	4.8	860	1,600	
	05/19/05	-	15,000	300	3.6	770	1,200	
	09/15/05	-	--	--	--	--	--	
11/10/05	-	14,000	230	2.6	530	1,000		
03/20/06	-	8,700	170	<1.5	360	530		
05/25/06	-	--	--	--	--	--		
#California Department of Health Services primary maximum contamination level for drinking water.			None Listed	1.0	150	300	1,750	

Title 22 MCL Tables, dated March 12, 1999. California MCL's.

TABLE 2
Groundwater Sample Results for 525 West A Street in Hayward, California

WELL NUMBER	DATE	TPH-d ug/L	TPH-g ug/L	Benzene ug/L	Toluene ug/L	Ethyl Benzene ug/L	Xylenes ug/L
MW-3	02/05/92	-	16,000	2,700	410	<1	3,400
	09/11/92	-	43,000	7,600	1,600	1,400	4,100
	12/22/92	-	29,000	8,800	1,200	1,500	3,700
	03/03/93	-	17,000	5,000	1,500	680	1,700
	06/23/93	-	5,700	3,000	120	560	790
	09/30/93	-	21,000	7,000	2,100	970	2,600
	02/06/94	-	24,000	7,200	1,600	990	3,200
	05/02/94	-	10,000	2,200	440	470	1,200
	07/01/94	-	8,200	2,000	370	350	930
	09/20/94	-	7,200	2,000	360	380	1,000
	12/06/94	-	9,000	2,300	400	440	1,100
	03/10/95	-	--	--	--	--	--
	03/15/95	-	4,300	980	47	370	780
	09/23/96	-	10,000	950	20	700	780
	12/04/96	-	13,000	1,100	25	1,000	1,100
	04/08/97	-	3,800	210	4.6	270	280
	06/30/97	-	3,500	280	<	32	180
	11/25/97	-	6,800	230	<	370	290
	06/01/98	-	--	--	--	--	--
	06/14/01	-	2,100	9	<0.5	78	43
	11/07/01	-	7,700	75	<5.0	410	150
	01/30/02	-	3,600	27	<5.0	120	34
	05/29/02	-	2,000	18	<5.0	53	13
	08/14/02	-	2,400	19	<0.5	50	6.5
	11/15/02	-	4,300	7.5	<0.5	22	1.1
	10/25/04	-	460	0.6	<0.50	9.6	1.7
	12/20/04	-	5,400	9	<0.50	280	74
	02/25/05	-	Not Found	Not Found	Not Found	Not Found	Not Found
	05/19/05	-	Not Found	Not Found	Not Found	Not Found	Not Found
	09/15/05	-	Not Found	Not Found	Not Found	Not Found	Not Found
	11/10/05	-	Not Found	Not Found	Not Found	Not Found	Not Found
	03/20/06	-	800	0.76	<0.50	19	3.7
	05/25/06	-	500	0.59	<0.50	3.8	0.96
	08/23/06	-	550	<0.50	<0.50	2.2	<0.50
	03/14/07	-	660	0.85	<0.50	22	3.7
	06/12/07	-	540	<0.50	<0.50	14	2.2
	08/01/07	-	2,300	2.3	<0.15	87	13
	02/27/08	-	1,360	<0.18	<0.24	32	3
	05/13/08	-	1,160	1.2	0.6	28	2.2
	08/27/08	-	2,790	1.4	<0.5	56	4.0
	11/18/08	-	1,800	0.8	<0.5	50	1.4
	03/11/09	-	957	1.2	0.9	37	4.0
	09/22/09	-	533	1.6	<0.5	8.8	<0.5
	03/09/10	-	537	<0.5	<0.5	8.8	<0.5
	09/09/10	< 0.1	272	<0.5	<0.5	1.5	<0.5
	01/25/11	-	377	<0.5	<0.5	8.5	<0.5
	07/25/11	-	230	< 0.5	1.4	2.2	< 0.5
#California Department of Health Services primary maximum contamination level for drinking water.			None Listed	1.0	150	300	1,750

Title 22 MCL Tables, dated March 12, 1999. California MCL's.

TABLE 2
Groundwater Sample Results for 525 West A Street in Hayward, California

WELL NUMBER	DATE	TPH-d ug/L	TPH-g ug/L	Benzene ug/L	Toluene ug/L	Ethyl Benzene ug/L	Xylenes ug/L
MW-4	02/05/92	-	16,000	2,700	410	< 1	3,400
	09/11/92	-	43,000	7,600	1,600	1,400	4,100
	12/22/92	-	29,000	8,800	1,200	1,500	3,700
	03/03/93	-	17,000	5,000	1,500	680	1,700
	06/23/93	-	5,700	3,000	120	560	790
	09/30/93	-	21,000	7,000	2,100	970	2,600
	02/06/94	-	24,000	7,200	1,600	990	3,200
	05/02/94	-	10,000	2,200	440	470	1,200
	07/01/94	-	8,200	2,000	370	350	930
	09/20/94	-	7,200	2,000	360	380	1,000
	12/06/94	-	9,000	2,300	400	440	1,100
	03/10/95	-	--	--	--	--	--
	03/15/95	-	15,000	4,400	600	770	2,660
	09/23/96	-	32,000	7,400	540	1,500	2,800
	12/04/96	-	23,000	7,800	140	1,200	1,200
	04/08/97	-	16,000	3,900	680	850	2,300
	06/30/97	-	63,000	7,000	430	1,400	4,400
	11/25/97	-	30,000	4,300	61	810	1,500
	06/01/98	-	33,000	5,700	710	1,700	2,900
	06/14/01	-	9,500	690	45	560	600
	11/07/01	-	6,000	710	20	630	190
	01/30/02	-	4,800	830	16	600	61
	05/29/02	-	5,300	720	57	600	200
	08/14/02	-	5,000	640	15	550	35
	11/15/02	-	3,700	330	10	260	200
	10/25/04	-	4,000	180	15	200	190
	12/23/04	-	7,400	280	24	340	340
	02/25/05	-	4,200	160	15	280	420
	05/19/05	-	15,000	480	76	1,100	1,600
	09/15/05	-	5,400	220	22	250	430
	11/10/06	-	8,000	320	37	530	670
	03/20/06	-	3,900	91	26	5.8	360.0
	05/25/06	-	8,300	300	77	570	730
	08/23/06	-	9,400	240	79	490	860
	03/14/07	-	4,600	100	20	350	570
	06/12/07	-	3,700	120	14	150	230
	08/01/07	-	3,700	120	15	280	310
	02/27/08	Not Found	Not Found	Not Found	Not Found	Not Found	Not Found
	05/13/08	-	2,800	102	18	329	343
	08/27/08	-	4,730	72	12	318	233
	11/18/08	-	2,430	39	6.6	163	102
	03/11/09	-	3,470	67	12	402	340
	09/22/09	-	1,590	25	<0.5	84	52
	03/09/10	-	1,790	21	4.3	94	65
	09/09/10	0.1	77300*	15,800	2,980	2,770	6,490
	11/22/10	-	2,160	27	5	82	57
	01/25/11	-	651	4.6	2.2	5.9	3.5
	07/25/11	-	2,600	32	13	180	170
#California Department of Health Services primary maximum contamination level for drinking water			None Listed	1.0	150	300	1,750

Title 22 MCL Tables, dated March 12, 1999. California M.C.L.'s.

TABLE 2
Groundwater Sample Results for 525 West A Street in Hayward, California

WELL NUMBER	DATE	TPH-d ug/L	TPH-g ug/L	Benzene ug/L	Toluene ug/L	Ethyl Benzene ug/L	Xylenes ug/L
MW-5	02/05/92	-	78,000	7,900	5,000	2,900	1,800
	09/11/92	-	49,000	4,700	400	1,400	4,100
	12/22/92	-	34,000	8,600	340	2,200	4,800
	03/03/93	-	22,000	7,500	640	1,300	3,400
	06/23/93	-	15,000	5,800	120	1,100	2,100
	09/30/93	-	25,000	7,600	410	1,000	4,400
	02/06/94	-	23,000	6,000	180	2,000	5,900
	05/02/94	-	8,000	1,300	29	440	770
	07/01/94	-	10,000	1,700	97	600	1,400
	09/20/94	-	8,400	1,600	54	650	1,400
	12/06/94	-	10,000	1,800	<50	620	1,400
	03/10/95	-	--	--	--	--	--
	03/15/95	-	5,300	1,100	11	180	320
	09/23/96	-	9,800	1,800	11	470	510
	12/04/96	-	10,000	2,200	9	550	430
	04/08/97	-	11,000	1,300	15	450	720
	06/30/97	-	3,800	500	<	75	84
	11/25/97	-	8,200	1,300	14	310	220
	06/01/98	-	3,600	290	12	52	52
	06/14/01	-	5,100	44	0.71	110	23
	11/07/01	-	7,600	220	<5.0	550	30
	01/30/02	-	6,200	180	<20	310	130
	05/29/02	-	3,900	66	0.8	110	7.4
	08/14/02	-	4,300	80	0.9	150	12
	11/15/02	-	7,000	99	<5.0	250	500
	10/25/04	-	4,800	27	0.5	50	3.7
	12/23/04	-	6,300	55	<0.90	140	5.6
	02/25/05	-	4,700	44	0.59	110	4.8
	05/19/05	-	3,800	32	0.61	66	4.4
	09/15/05	-	4,500	22	0.65	78	4
	11/10/06	-	4,000	19	0.52	77	4.3
	03/20/06	-	4,000	9.5	<0.50	4.9	4
	05/25/06	-	3,400	12	<0.50	46	3.8
	08/23/06	-	4,000	5.6	0.75	42	3.6
	03/14/07	-	3,500	3.1	1	31	1.6
	06/12/07	-	2,500	3.0	0.83	14	1.4
	08/01/07	-	2,700	3.6	1.1	21	1.1
	02/27/08	-	628	1.5	<0.24	8.9	4.2
	05/13/08	-	752	1.3	1.1	1.9	1.8
	08/27/08	-	3,100	2.9	2.9	12	6.8
	11/18/08	-	2,490	1.9	0.7	8.7	2.4
	03/11/09	-	2,210	3.3	1.1	8.5	1.3
	09/22/09	-	2,870	4.4	1.1	11	2.9
	03/09/10	-	103	<0.5	<0.5	<0.5	<0.5
	09/09/10	0.2	31700*	9,730	333	905	848
	11/22/10	-	3,500	2.7	<1.0	4.6	<1.0
	01/25/11	-	1,140	1.8	<0.5	2.9	<0.5
	07/25/11	-	2,900	1.8	12	2.2	1.9
#California Department of Health Services primary maximum contamination level for drinking water.			None Listed	1.0	150	300	1,750

TABLE 2
Groundwater Sample Results for 525 West A Street in Hayward, California

WELL NUMBER	DATE	TPH-d ug/L	TPH-g ug/L	Benzene ug/L	Toluene ug/L	Ethyl Benzene ug/L	Xylenes ug/L
MW-6	02/05/92	-	51,000	5,400	3,500	3,600	10,000
	09/11/92	-	24,000	2,500	830	1,400	2,300
	12/22/92	-	23,000	5,100	630	2,000	3,100
	03/03/93	-	18,000	4,400	820	1,400	2,400
	06/23/93	-	18,000	4,600	850	2,700	3,400
	09/30/93	-	--	--	--	--	--
	02/06/94	-	20,000	4,600	690	2,100	2,500
	05/02/94	-	5,300	930	54	610	240
	07/01/94	-	10,000	1,500	160	850	690
	09/20/94	-	11,000	2,000	140	1,200	760
	12/06/94	-	8,600	1,300	87	980	610
	03/10/95	-	--	--	--	--	--
	03/15/95	-	9,800	1,600	110	1,000	1,000
	09/23/96	-	12,000	520	55	930	350
	12/04/96	-	11,000	390	25	680	170
	04/08/97	-	17,000	700	92	1,400	900
	06/30/97	-	11,000	270	37	590	450
	11/25/97	-	9,100	130	26	500	150
	06/01/98	-	14,000	190	50	680	400
	06/14/01	-	6,400	29	6.3	200	55
	11/07/01	-	7,200	34	8.7	180	31
	01/30/02	-	6,600	32	7.2	130	28
	05/29/02	-	5,200	26	7	150	27
	08/14/02	-	5,300	24	6.6	120	22
	11/15/02	-	5,000	19	4.7	70	38
	10/25/04	-	3,600	9.8	2.1	83	16
	12/23/04	-	2,100	8.2	1.3	10	2.4
	02/25/05	-	2,500	6.6	1.4	29	5.2
	05/19/05	-	3,800	7.5	2.2	54	12
	09/15/05	-	1,900	2.9	0.88	12	2.7
	11/10/06	-	1,700	2.1	0.6	5.4	1.7
	03/20/06	-	2,300	3.6	1.0	12	3.9
	05/25/06	-	2,400	5	1.8	31	14
08/23/06	-	2,300	2.3	0.84	7.8	4.2	
03/14/07	-	3,300	2.8	0.7	49	6.5	
06/12/07	-	2,000	1.4	0.54	3.2	2.1	
08/01/07	-	1,500	0.99	0.4	2.1	1.2	
02/27/08	-	1,520	<0.18	<0.24	2.4	1.3	
05/13/08	-	1,530	1.0	0.8	4.0	1.5	
08/27/08	-	Not Found	Not Found	Not Found	Not Found	Not Found	
11/18/08	-	Not Found	Not Found	Not Found	Not Found	Not Found	
03/11/09	-	Not Found	Not Found	Not Found	Not Found	Not Found	
03/09/10	-	Not Found	Not Found	Not Found	Not Found	Not Found	
07/25/11	-	2,000	1.0	23	7.6	3.2	
#California Department of Health Services primary maximum contamination level for drinking water.			None Listed	1.0	150	300	1,750

TABLE 2
Groundwater Sample Results for 525 West A Street in Hayward, California

WELL NUMBER	DATE	TPH-d ug/L	TPH-g ug/L	Benzene ug/L	Toluene ug/L	Ethyl Benzene ug/L	Xylenes ug/L
MW-7	06/23/93	-	29,000	4,200	71	4,400	5,600
	09/30/93	-	30,000	3,200	71	2,800	3,400
	02/06/94	-	--	--	--	--	--
	05/02/94	-	5,700	630	13	660	400
	07/01/94	-	3,100	180	99	160	520
	09/20/94	-	6,100	540	6	750	730
	12/06/94	-	3,700	280	<10	430	350
	03/10/95	-	3,900	310	<10	540	540
	03/15/95	-	1,900	290	4	26	296
	09/23/96	-	6,300	76	<	420	270
	12/04/96	-	7,800	67	<	600	350
	04/08/97	-	5,600	42	<	240	96
	06/30/97	-	5,500	<	79	<	44
	11/25/97	-	2,400	23	5.4	<	54
	06/01/98	-	14,000	190	50	680	400
	06/14/01	-	6,400	29	6	200	55
	11/07/01	-	--	--	--	--	--
	01/30/02	-	6,200	1.5	<0.50	96	4.6
	05/29/02	-	1,600	1	<0.50	3.4	1.9
	08/14/02	-	4,100	1.3	<0.50	74	1.3
	11/15/02	-	1,000	0.6	<0.50	<0.5	0.6
	10/25/04	-	Not Found	-	-	-	-
	05/19/05	-	660	<0.50	<0.50	1.8	<0.50
	09/15/05	-	Not Found	-	-	-	-
	11/10/06	-	340	<0.50	<0.50	<0.50	<0.50
	03/20/06	-	Not Found	-	-	-	-
	05/25/06	-	Not Found	-	-	-	-
	08/23/06	-	380	<0.50	<0.50	<0.50	<0.50
	03/14/07	-	170	<0.50	<0.50	<0.50	<0.50
	06/12/07	-	Not Found	-	-	-	-
	08/01/07	-	470	<0.12	<0.15	1.7	0.5
	02/27/08	-	257	<0.18	<0.24	<0.21	<0.45
	05/13/08	-	241	<0.5	<0.5	<0.5	<0.5
	08/27/08	-	514	<0.5	<0.5	0.9	<0.5
	11/18/08	-	281	<0.5	<0.5	0.7	<0.5
	03/11/09	-	327	<0.5	<0.5	1.2	<0.5
	09/22/09	-	216	<0.5	<0.5	<0.5	<0.5
	03/09/10	-	143	<0.5	<0.5	<0.5	<0.5
	09/09/10	< 0.1	100	<0.5	<0.5	<0.5	<0.5
	01/25/11	-	218	<0.5	<0.5	<0.5	<0.5
#California Department of Health Services primary maximum contamination level for drinking water.			None Listed	1.0	150	300	1,750

TABLE 2
Groundwater Sample Results for 525 West A Street in Hayward, California

WELL NUMBER	DATE	TPH-d ug/L	TPH-g ug/L	Benzene ug/L	Toluene ug/L	Ethyl Benzene ug/L	Xylenes ug/L
MW-8	06/23/93	-	350	43	9	35	67
	09/30/93	-	2,700	190	340	170	720
	02/06/94	-	<100	<1	1	1	2
	05/02/94	-	<100	<1	3	<1	7
	07/01/94	-	300	18	48	19	37
	09/20/94	-	<100	<1	<1	<1	<1
	12/06/94	-	<50	<0.5	<0.5	<0.5	<0.5
	03/10/95	-	--	--	--	--	--
	03/15/95	-	<50	<0.5	<0.5	<0.5	1
	09/23/96	-	<	<	<	<	<
#California Department of Health Services primary maximum contamination level for drinking water.			None Listed	1.0	150	300	1,750

TABLE 2
Groundwater Sample Results for 525 West A Street in Hayward, California

WELL NUMBER	DATE	TPH-d ug/L	TPH-g ug/L	Benzene ug/L	Toluene ug/L	Ethyl Benzene ug/L	Xylenes ug/L
MW-9	06/23/93	-	45,000	14,000	1,200	2,800	12,000
	09/30/93	-	86,000	22,000	1,100	3,300	15,000
	02/06/94	-	43,000	10,000	460	2,100	7,500
	05/02/94	-	17,000	5,400	270	1,300	4,700
	07/01/94	-	10,000	2,100	120	450	1,300
	09/20/94	-	7,500	2,200	97	400	1,200
	12/06/94	-	10,000	2,700	130	530	1,600
	03/10/95	-	--	--	--	--	--
	03/15/95	-	18,000	5,900	270	1,200	3,680
	07/25/11	-	2,800	88	7.7	19	5.4
#California Department of Health Services primary maximum contamination level for drinking water.			None Listed	1.0	150	300	1,750

TABLE 2
Groundwater Sample Results for 525 West A Street in Hayward, California

WELL NUMBER	DATE	TPH-d ug/L	TPH-g ug/L	Benzene ug/L	Toluene ug/L	Ethyl Benzene ug/L	Xylenes ug/L
MW-10	06/23/93	-	35,000	980	640	3,500	12,000
	09/30/93	-	4,000	230	12	100	680
	02/06/94	-	2,000	69	12	220	120
	05/02/94	-	710	16	6	85	62
	07/01/94	-	2,000	52	43	120	210
	09/20/94	-	2,800	34	16	270	560
	12/06/94	-	2,700	30	13	260	430
	03/10/95	-	--	--	--	--	--
	03/15/95	-	1,400	18	6	200	239
	09/23/96	-	3,800	4	2.9	220	170
	12/04/96	-	4,600	1.6	7.7	260	150
	#California Department of Health Services primary maximum contamination level for drinking water.			None Listed	1.0	150	300

TABLE 2
Groundwater Sample Results for 525 West A Street in Hayward, California

WELL NUMBER	DATE	TPH-d ug/L	TPH-g ug/L	Benzene ug/L	Toluene ug/L	Ethyl Benzene ug/L	Xylenes ug/L
MW-11	02/10/95	-	7,000	140	22	600	1,000
	03/10/95	-	--	--	--	--	--
	03/15/95	-	6,000	200	17	750	1,276
	09/23/96	-	27,000	55	81	300	3,500
	12/04/96	-	--	--	--	--	--
	04/08/97	-	24,000	280	130	3,000	3,700
#California Department of Health Services primary maximum contamination level for drinking water.			None Listed	1.0	150	300	1,750

TABLE 2
Groundwater Sample Results for 525 West A Street in Hayward, California

WELL NUMBER	DATE	TPH-d ug/L	TPH-g ug/L	Benzene ug/L	Toluene ug/L	Ethyl Benzene ug/L	Xylenes ug/L
MW-12	02/10/95	-	<50	<0.5	<0.5	<0.5	<0.5
	03/10/95	-	--	--	--	--	--
	03/14/95	-	<50	<0.5	<0.5	<0.5	0.9
	09/23/96	-	<	<	1.6	<	<
	12/04/96	-	<	3.2	<	1.9	3.4
	04/08/97	-	<	<	<	<	<
	06/30/97	-	--	--	--	--	--
	11/25/97	-	--	--	--	--	--
	06/01/98	-	--	--	--	--	--
	06/14/01	-	<50	<0.50	<0.50	<0.50	<0.50
	11/07/01	-	<50	<0.5	<0.5	<0.5	<0.5
	01/30/02	-	<50	<0.5	<0.5	<0.5	<0.5
	05/29/02	-	<50	<0.5	<0.5	<0.5	<0.5
	08/14/02	-	<50	<0.5	<0.5	<0.5	<0.5
	11/15/02	-	<50	<0.5	<0.5	<0.5	<0.5
	10/25/04	Not Accessible	Not Accessible	--	--	--	--
	02/25/05	-	<50	<0.5	<0.5	<0.5	<0.5
	05/19/05	-	<50	<0.5	<0.5	<0.5	<0.5
	09/15/05	-	<50	<0.5	<0.5	<0.5	<0.5
	11/10/05	-	<50	<0.50	<0.50	<0.50	<0.50
	03/20/06	-	<50	<0.50	<0.50	<0.50	<0.50
	05/25/06	-	<50	<0.50	<0.50	<0.50	<0.50
	08/23/06	-	<50	<0.50	<0.50	<0.50	<0.50
	03/14/07	-	<50	<0.50	<0.50	<0.50	<0.50
	06/11/07	-	<50	<0.50	<0.50	<0.50	<0.50
	08/01/07	-	45	<0.12	<0.15	<0.17	<0.34
	02/27/08	-	<6.6	<0.18	<0.24	<0.21	<0.45
	05/13/08	-	<50	<0.5	<0.5	<0.5	<0.5
	08/27/08	-	<50	<0.5	<0.5	<0.5	<0.5
	11/18/08	-	<50	<0.5	<0.5	<0.5	<0.5
	03/11/09	-	<50	<0.5	<0.5	<0.5	<0.5
	09/22/09	-	<50	<0.5	<0.5	<0.5	<0.5
	03/09/10	-	<50	<0.5	<0.5	<0.5	<0.5
01/25/11	-	<50	<0.5	<0.5	<0.5	<0.5	
07/25/11	-	<50	<0.5	<0.5	<0.5	<0.5	
#California Department of Health Services primary maximum contamination level for drinking water.			None Listed	1.0	150	300	1,750

TABLE 2
Groundwater Sample Results for 525 West A Street in Hayward, California

WELL NUMBER	DATE	TPH-d ug/L	TPH-g ug/L	Benzene ug/L	Toluene ug/L	Ethyl Benzene ug/L	Xylenes ug/L
MW-13	02/10/95	-	<50	<0.5	<0.5	<0.5	<0.5
	03/10/95	-	--	--	--	--	--
	03/14/95	-	<50	<0.5	<0.5	<0.5	1
	09/23/96	-	<	<	0.8	1	<
	12/04/96	-	--	--	--	--	--
	04/08/97	-	<	<	<	<	<
	06/30/97	-	--	--	--	--	--
	11/25/97	-	--	--	--	--	--
	06/01/98	-	--	--	--	--	--
	06/14/01	-	<50	<0.50	<0.50	<0.50	<0.50
	11/07/01	-	<50	<0.5	<0.5	<0.5	<0.5
	01/30/02	-	<50	<0.5	<0.5	<0.5	<0.5
	05/29/02	-	<50	<0.5	<0.5	<0.5	<0.5
	08/14/02	-	<50	<0.5	<0.5	<0.5	<0.5
	11/15/02	-	--	--	--	-	--
	10/25/04	-	NT	NT	NT	NT	NT
07/25/11	-	< 50	< 0.5	< 0.5	< 0.5	< 0.5	
#California Department of Health Services primary maximum contamination level for drinking water.			None Listed	1.0	150	300	1,750

TABLE 2
Groundwater Sample Results for 525 West A Street in Hayward, California

WELL NUMBER	DATE	TPH-d ug/L	TPH-g ug/L	Benzene ug/L	Toluene ug/L	Ethyl Benzene ug/L	Xylenes ug/L
MW-14	02/10/95	-	12,000	42	8	740	2,100
	03/10/95	-	--	--	--	--	--
	03/14/95	-	1,400	6	2	36	298
	09/23/96	-	6,400	2.8	<	690	96
	12/04/96	-	9,500	6.3	<	1,100	400
	04/08/97	-	2,900	<	2.7	220	21
	06/30/97	-	74	1.3	<	0.51	0.68
	11/25/97	-	<	<	<	<	<
	06/01/98	-	<50	<0.5	<0.5	<0.5	<0.5
	06/14/01	-	470	<0.5	<0.5	2.8	1
	11/07/01	-	<50	<0.5	<0.5	<0.5	<0.5
	01/30/02	-	<50	<0.5	<0.5	<0.5	<0.5
	05/29/02	-	<50	<0.5	<0.5	<0.5	<0.5
	08/14/02	-	<50	<0.5	<0.5	<0.5	<0.5
	11/15/02	-	<50	<0.5	<0.5	<0.5	<0.5
	10/25/04	-	Not Accessible	--	--	--	--
	02/25/05	-	210	<0.5	<0.5	<0.5	<0.5
	05/19/05	-	230	<0.5	<0.5	<0.5	<0.5
	09/15/05	-	Not Accessible	-	--	--	--
	11/10/05	-	Not Accessible	-	--	--	--
	03/20/06	-	180	<0.5	<0.5	<0.5	<0.5
	05/25/06	-	<50	<0.5	<0.5	<0.5	<0.5
	08/23/06	-	99	<0.5	<0.5	<0.5	<0.5
	03/14/07	-	<50	<0.5	<0.5	<0.5	<0.5
	06/11/07	-	<50	<0.5	<0.5	<0.5	<0.5
	08/01/07	-	53	<0.12	<0.15	<0.17	<0.34
	02/27/08	-	<6.6	<0.18	<0.24	<0.21	<0.45
	05/13/08	-	<50	<0.5	<0.5	<0.5	<0.5
	08/27/08	-	<50	<0.5	<0.5	<0.5	<0.5
	11/18/08	-	<50	<0.5	<0.5	<0.5	<0.5
	03/11/09	-	<50	<0.5	<0.5	<0.5	<0.5
09/22/09	-	<50	<0.5	<0.5	<0.5	<0.5	
03/09/10	-	<50	<0.5	<0.5	<0.5	<0.5	
01/25/11	-	<50	<0.5	<0.5	<0.5	<0.5	
07/25/11	-	<50	<0.5	<0.5	<0.5	<0.5	
#California Department of Health Services primary maximum contamination level for drinking water.			None Listed	1.0	150	300	1,750

TABLE 2
Groundwater Sample Results for 525 West A Street in Hayward, California

WELL NUMBER	DATE	TPH-d ug/L	TPH-g ug/L	Benzene ug/L	Toluene ug/L	Ethyl Benzene ug/L	Xylenes ug/L
EX-1	08/14/02	-	250	31	<0.5	<0.5	4
	11/15/02	-	67	4.1	<0.5	<0.5	<0.5
	10/25/04	-	96	2.1	<0.50	4.9	1.8
	02/25/05	-	<50	<0.50	<0.50	0.87	<0.50
	05/19/05	-	59	1.4	<0.50	2	0.87
	09/15/05	-	200	3.4	<0.50	3.7	1.8
	11/10/05	-	290	7.5	<0.50	2.8	0.66
	03/20/06	-	270	5.1	<0.50	9.2	1.5
	05/25/06	-	820	7.5	<0.50	15	7.2
	08/23/06	-	100	<0.50	<0.50	1	0.9
	03/14/07	-	440	7.3	<0.50	0.72	0.61
	06/11/07	-	360	1.6	<0.50	8.8	1.8
	08/01/07	-	240	1.1	<0.50	6.0	1.4
	02/27/08	-	410	2.5	<0.15	4.2	0.92
	05/13/08	-	Not Accessible	-	--	--	--
	08/27/08	-	348	0.9	<0.5	0.8	<0.5
	11/18/08	-	459	0.8	<0.5	<0.5	<0.5
	03/11/09	-	371	<0.5	<0.5	3.6	<0.5
	09/22/09	-	295	<0.5	<0.5	<0.5	<0.5
	03/09/10	-	344	0.5	<0.5	1.2	<0.5
09/09/10	< 0.1	759	2.1	<1.0	1.3	<1.0	
01/25/11	-	Not Sampled	-	-	-	-	
07/25/11	-	250	< 0.5	1.6	1.1	< 0.5	
#California Department of Health Services primary maximum contamination level for drinking water.			None Listed	1.0	150	300	1,750

Title 22 MCL Tables, dated March 12, 1999. California MCL's.

TABLE 2
Groundwater Sample Results for 525 West A Street in Hayward, California

WELL NUMBER	DATE	TPH-d ug/L	TPH-g ug/L	Benzene ug/L	Toluene ug/L	Ethyl Benzene ug/L	Xylenes ug/L
VEAS-2	05/19/05	-	90	1.1	<0.50	0.7	1.3
	09/15/05	-	<50	<0.50	<0.50	<0.50	<0.50
	11/10/05	-	--	-	-	-	-
	07/25/11	-	< 50	< 0.5	< 0.5	< 0.5	< 0.5
#California Department of Health Services primary maximum contamination level for drinking water		None Listed	None Listed	1.0	150	300	1,750

Title 22 MCL Tables, dated March 12, 1999. California MCL's.

TABLE 2
Groundwater Sample Results for 525 West A Street in Hayward, California

WELL NUMBER	DATE	TPH-d ug/L	TPH-g ug/L	Benzene ug/L	Toluene ug/L	Ethyl Benzene ug/L	Xylenes ug/L
VEAS-3	07/25/11		3,000	ND < 1.0	9.9	ND < 1.0	ND < 1.0
#California Department of Health Services primary maximum contamination level for drinking water		None Listed	None Listed	1.0	150	300	1,750

Title 22 MCL Tables, dated March 12, 1999. California MCL's.

TABLE 2A
Groundwater Sample Results for Oxygenated Volatile Organics
for 525 West A Street in Hayward, California

WELL NUMBER	DATE	DIPE ug/L	ETBE ug/L	MTBE ug/L	1,2-DCA ug/L	TAME ug/L	TBA ug/L
MW-1	02/05/92	-	-	-	-	-	-
	09/11/92	-	-	-	-	-	-
	12/22/92	-	-	-	-	-	-
	03/03/93	-	-	-	-	-	-
	06/23/93	-	-	-	-	-	-
	09/30/93	-	-	-	-	-	-
	02/06/94	-	-	-	-	-	-
	05/02/94	-	-	-	-	-	-
	07/01/94	-	-	-	-	-	-
	09/20/94	-	-	-	-	-	-
	12/05/92	-	-	-	-	-	-
	03/10/95	-	-	-	-	-	-
	03/15/95	-	-	-	-	-	-
	09/23/96	-	-	270	-	-	-
	12/04/96	-	-	280	-	-	-
	04/08/97	-	-	100	-	-	-
	06/30/97	-	-	<	-	-	-
	11/25/97	-	-	<	-	-	-
	06/01/98	-	-	420	-	-	-
	06/14/01	-	-	<25	-	-	-
	11/07/01	<5.0	<5.0	11	-	<5.0	<50
	01/30/02	<5.0	<5.0	14	-	<5.0	<50
	05/29/02	2.5	<2.0	12	-	<2.0	<20
	08/14/02	<10	<10	10	-	<10	<100
	11/15/02	<10	<10	15	-	<10	<100
	10/25/04	<0.90	<0.90	14	-	<0.90	5.8
	12/23/04	<0.90	<0.90	16	-	<0.90	11
	02/25/05	<1.5	<1.5	24	-	<1.5	11
	05/19/05	<1.5	<1.5	20	-	<1.5	11
	09/15/05	<0.90	<0.90	12	-	<0.90	7.8
	03/20/06	<0.90	<0.90	8.8	-	<0.90	6
	05/25/06	<0.90	<0.90	11	-	<0.90	6.7
	08/23/06	<0.50	<0.50	4.2	-	<0.50	<5.0
	03/14/07	<0.50	<0.50	2.5	-	<0.50	<5.0
	06/11/07	<1.0	<1.0	2.4	-	<1.0	<5.0
	08/01/07	<0.60	<0.63	<0.77	-	<0.83	<35
	02/27/08	<0.18	<0.23	<0.19	-	<0.19	<10
	05/13/08	<2.5	<2.5	6.9	-	<2.5	<25.0
	08/27/08	<0.5	<0.5	12	-	<0.5	9.1
	11/18/08	<0.5	<0.5	15	-	<0.5	6.9
	03/11/09	<0.5	<0.5	20	-	<0.5	<5.0
	09/22/09	<0.5	<0.5	18	-	<0.5	<5.0
	03/09/10	<0.5	<0.5	50	-	<0.5	<5.0
	09/09/10	<1.0	<1.0	85	< 0.5	<1.0	<10.0
	01/25/11	<0.5	< 0.5	50	< 0.5	<0.5	<5.0
	07/25/11	ND < 10	ND < 10	230	ND < 10	ND < 10	ND < 40
#California Department of Health Services primary maximum contamination level for drinking water.		None Listed	None Listed	5		None Listed	

Drinking Water Standards and Health Advisories for MTBE and TBA, SWRCB April 13, 2000. California MCL's.
 EPA Method 8260

TABLE 2A
Groundwater Sample Results for Oxygenated Volatile Organics
for 525 West A Street in Hayward, California

WELL NUMBER	DATE	DIPE ug/L	ETBE ug/L	MTBE ug/L	1,2-DCA ug/L	TAME ug/L	TBA ug/L
MW-1A	06/23/93	--	--	--	-	--	--
	09/30/93	--	--	--	-	--	--
	02/06/94	--	--	--	-	--	--
	05/02/94	--	--	--	-	--	--
	07/01/94	--	--	--	-	--	--
	09/20/94	--	--	--	-	--	--
	12/05/94	--	--	--	-	--	--
	03/10/95	--	--	--	-	--	--
	03/15/95	--	--	--	-	--	--
	09/23/96	--	--	-	-	--	--
	12/04/96	--	--	130	-	--	--
	04/08/97	--	--	--	-	--	--
	06/30/97	--	--	<	-	--	--
	11/25/97	--	--	<	-	--	--
	06/01/98	--	--	91	-	--	--
	06/14/01	--	--	<5.0	-	-	-
	11/07/01	<5.0	<5.0	<5.0	-	<5.0	<50
	01/30/02	<5.0	<5.0	<5.0	-	<5.0	<50
	05/29/02	<5.0	<5.0	<5.0	-	<5.0	<50
	08/14/02	<2.0	<2.0	<2.0	-	<2.0	<20
	11/15/02	<2.0	<2.0	<2.0	-	<2.0	<20
	10/25/04	<0.50	<0.50	<0.50	-	<0.50	<5.0
	12/23/04	<0.50	<0.50	<0.50	-	<0.50	<5.0
	02/25/05	<0.50	<0.50	<0.50	-	<0.50	<5.0
	05/19/05	<1.5	<1.5	<1.5	-	<1.5	<7.0
	09/15/05	<0.50	<0.50	<0.50	-	<0.50	<5.0
	11/10/05	<0.50	<0.50	<0.50	-	<0.50	<5.0
	03/20/06	<0.50	<0.50	<0.50	-	<0.50	<5.0
	05/25/06	<0.50	<0.50	<0.50	-	<0.50	<5.0
	08/23/06	<0.50	<0.50	<0.50	-	<0.50	<5.0
	03/14/07	<0.50	<0.50	7.5	-	<0.50	<5.0
	06/12/07	<0.50	<0.50	20	-	<0.50	<5.0
	08/01/07	<0.12	<0.13	79	-	<0.17	<6.9
	02/27/08	<0.20	<0.23	21	-	<0.19	<10
	11/18/08	--	-	--	-	--	--
	03/11/09	--	-	--	-	--	--
#California Department of Health Services primary maximum contamination level for drinking water.		None Listed	None Listed	5		None Listed	

Drinking Water Standards and Health Advisories for MTBE and TBA, SWRCB April 13, 2000. California MCL's.
 EPA Method 8260

TABLE 2A
Groundwater Sample Results for Oxygenated Volatile Organics
for 525 West A Street in Hayward, California

WELL NUMBER	DATE	DIPE ug/L	ETBE ug/L	MTBE ug/L	TAME ug/L	TBA ug/L
MW-2	02/05/92	-	-	--	-	-
	09/11/92	-	-	--	-	-
	12/22/92	-	-	--	-	-
	03/03/93	-	-	--	-	-
	06/23/93	-	-	--	-	-
	09/30/93	-	-	--	-	-
	02/06/94	-	-	--	-	-
	05/02/94	-	-	--	-	-
	07/01/94	-	-	--	-	-
	09/20/94	-	-	--	-	-
	12/06/94	-	-	--	-	-
	03/10/95	-	-	--	-	-
	03/15/95	-	-	--	-	-
	09/23/96	-	-	860	-	-
	12/04/96	-	-	690	-	-
	04/08/97	-	-	880	-	-
	06/30/97	-	-	890	-	-
	11/25/97	-	-	1,200	-	-
	06/01/98	-	-	610	-	-
	06/14/01	-	-	<100	-	-
	11/07/01	<5.0	<5.0	21	<5.0	<50
	01/30/02	<5.0	<5.0	56	<5.0	<50
	05/29/02	<5.0	<5.0	32	<5.0	<50
	08/14/02	<20	<20	29	<20	<200
	11/15/02	<20	<20	39	<20	<200
	10/25/04	<2.0	<2.0	8.2	<2.0	<9.0
	12/23/04	<2.0	<2.0	9.5	<2.0	<9.0
	02/25/05	<2.0	<2.0	7.7	<2.0	<9.0
	05/19/05	<2.5	<2.5	9.2	<2.5	<15
	09/15/05	--	--	--	--	--
	11/10/05	<2.5	<2.5	6.2	<2.5	<15
	03/20/06	<1.5	<1.5	3.8	<1.5	<7.0
	05/25/06	--	--	--	--	--
#California Department of Health Services primary maximum contamination level for drinking water:		None Listed	None Listed	5	None Listed	Action Level 12

Drinking Water Standards and Health Advisories for MTBE and TBA, SWRCB April 13, 2000. California MCL's. EPA Method 8260

TABLE 2A
Groundwater Sample Results for Oxygenated Volatile Organics
for 525 West A Street in Hayward, California

WELL NUMBER	DATE	DIPE ug/L	ETBE ug/L	MTBE ug/L	TAME ug/L	TBA ug/L
MW-3	02/05/92	--	--	--	--	--
	09/11/92	--	--	--	--	--
	12/22/92	--	--	--	--	--
	03/03/93	--	--	--	--	--
	06/23/93	--	--	--	--	--
	09/30/93	--	--	--	--	--
	02/06/94	--	--	--	--	--
	05/02/94	--	--	--	--	--
	07/01/94	--	--	--	--	--
	09/20/94	--	--	--	--	--
	12/06/94	--	--	--	--	--
	03/10/95	--	--	--	--	--
	03/15/95	--	--	--	--	--
	09/23/96	--	--	80	--	--
	12/04/96	--	--	67	--	--
	04/08/97	--	--	56	--	--
	06/30/97	--	--	<	--	--
	11/25/97	--	--	130	--	--
	06/01/98	--	--	--	--	--
	06/14/01	--	--	<5.0	--	--
	11/07/01	<5.0	<5.0	<5.0	<5.0	<5.0
	01/30/02	<5.0	<5.0	<5.0	<5.0	<5.0
	05/29/02	<5.0	<5.0	<5.0	<5.0	<5.0
	08/14/02	<0.5	<0.5	<0.5	<0.5	<5.0
	11/15/02	0.5	0.5	0.5	0.5	<5.0
	10/25/04	<0.50	<0.50	<0.50	<0.50	<5.0
	12/20/04	<0.50	<0.50	<0.50	<0.50	<5.0
	02/25/05	--	--	--	--	--
	05/19/05	--	--	--	--	--
	09/15/05	--	--	--	--	--
	11/10/05	--	--	--	--	--
	03/20/06	<0.50	<0.50	<0.50	<0.50	<5.0
	05/25/06	<0.50	<0.50	<0.50	<0.50	<5.0
	08/23/06	<0.50	<0.50	<0.50	<0.50	<5.0
	03/14/07	<0.50	<0.50	1.3	<0.50	<5.0
06/12/07	<0.50	<0.50	6.0	<0.50	<5.0	
08/01/07	<0.12	<0.13	<0.15	<0.17	<6.9	
02/27/08	<0.20	<0.23	7.7	<0.19	<10	
05/13/08	<0.5	<0.5	31	<0.5	<5.0	
08/27/08	<0.5	<0.5	40	<0.5	18	
11/18/08	<0.5	<0.5	31	<0.5	13	
03/11/09	<0.5	<0.5	155	<0.5	<5.0	
09/22/09	<0.5	<0.5	238	<0.5	<5.0	
03/09/10	<0.5	<0.5	114	<0.5	<5.0	
09/09/10	<1.0	<1.0	36	<1.0	<10	
01/25/11	<0.5	<0.5	5.1	<0.5	<5.0	
07/25/11	ND < 5.0	ND < 5.0	240	ND < 5.0	ND < 20	
#California Department of Health Services primary maximum contamination level for drinking water.		None Listed	None Listed	5	None Listed	Action Level 12

TABLE 2A
Groundwater Sample Results for Oxygenated Volatile Organics
for 525 West A Street in Hayward, California

WELL NUMBER	DATE	DIPE ug/L	ETBE ug/L	MTBE ug/L	TAME ug/L	TBA ug/L
MW-4	02/05/92	--	--	--	--	--
	09/11/92	--	--	--	--	--
	12/22/92	--	--	--	--	--
	03/03/93	--	--	--	--	--
	06/23/93	--	--	--	--	--
	09/30/93	--	--	--	--	--
	02/06/94	--	--	--	--	--
	05/02/94	--	--	--	--	--
	07/01/94	--	--	--	--	--
	09/20/94	--	--	--	--	--
	12/06/94	--	--	--	--	--
	03/10/95	--	--	--	--	--
	03/15/95	--	--	--	--	--
	09/23/96	--	--	2,100	--	--
	12/04/96	--	--	1,900	--	--
	04/08/97	--	--	980	--	--
	06/30/97	--	--	1,700	--	--
	11/25/97	--	--	880	--	--
	06/01/98	--	--	720	--	--
	06/14/01	<5.0	<5.0	<5.0	<5.0	<5.0
	11/07/01	<5.0	<5.0	27	<5.0	<5.0
	01/30/02	<20	<20	42	<20	<200
	05/29/02	<2.0	<2.0	35	<2.0	<20
	08/14/02	<2.0	<2.0	28	<2.0	<20
	11/15/02	<0.50	<0.50	20	<0.50	<5.0
	10/25/04	<0.90	<0.90	4.1	<0.90	<5.0
	12/23/04	<0.90	<0.90	7.9	<0.90	<5.0
	02/25/05	<4.0	<4.0	6.2	<4.0	<20
	05/19/05	<0.90	<0.90	14	<0.90	5.4
	09/15/05	<0.50	<0.50	10	<0.50	<5.0
	11/10/06	<0.50	<0.50	9.3	<0.50	<5.0
	03/20/06	<0.50	<0.50	5.7	<0.50	<5.0
	05/25/06	<0.50	<0.50	5.4	<0.50	<5.0
	08/23/06	<0.50	<0.50	6.1	<0.50	<5.0
	03/14/07	<0.50	<0.50	2.3	<0.50	<5.0
	06/12/07	<0.50	<0.50	2.5	<0.50	<5.0
	08/01/07	<0.60	<0.63	<0.77	<0.83	<35
	02/27/08	--	--	--	--	--
	05/13/08	<2.5	<2.5	8.0	<2.5	<25.0
	08/27/08	<0.5	<0.5	33	<0.5	18
	11/18/08	<0.5	<0.5	29	<0.5	8.1
	03/11/09	<0.5	<0.5	86	<0.5	<5.0
	09/22/09	<0.5	<0.5	116	<0.5	<5.0
	03/09/10	<0.5	<0.5	220	<0.5	<5.0
	09/09/10	<10.0	<10.0	<5.0	<10.0	506
	11/22/10	<5.0	<5.0	384	<5.0	<50
	01/25/11	<1.0	<1.0	161	<1.0	116
	07/25/11	ND < 10	ND < 10	320	ND < 10	56
#California Department of Health Services primary maximum contamination level for drinking water.		None Listed	None Listed	5	None Listed	Action Level 12

TABLE 2A
Groundwater Sample Results for Oxygenated Volatile Organics
for 525 West A Street in Hayward, California

WELL NUMBER	DATE	DIPE ug/L	ETBE ug/L	MTBE ug/L	TAME ug/L	TBA ug/L
MW-5	02/05/92	--	--	--	--	--
	09/11/92	--	--	--	--	--
	12/22/92	--	--	--	--	--
	03/03/93	--	--	--	--	--
	06/23/93	--	--	--	--	--
	09/30/93	--	--	--	--	--
	02/06/94	--	--	--	--	--
	05/02/94	--	--	--	--	--
	07/01/94	--	--	--	--	--
	09/20/94	--	--	--	--	--
	12/06/94	--	--	--	--	--
	03/10/95	--	--	--	--	--
	03/15/95	--	--	--	--	--
	09/23/96	--	--	100	--	--
	12/04/96	--	--	70	--	--
	04/08/97	--	--	180	--	--
	06/30/97	--	--	<	--	--
	11/25/97	--	--	<	--	--
	06/01/98	--	--	81	--	--
	06/14/01	--	--	<5.0	--	--
	11/07/01	<5.0	<5.0	<5.0	<5.0	<50
	01/30/02	<20	<20	<20	<20	<200
	05/29/02	2	<0.5	0.9	<0.5	<5.0
	08/14/02	<0.5	<0.5	1.1	<0.5	<5.0
	11/15/02	<5.0	<5.0	<5.0	<5.0	<5.0
	10/25/04	<0.50	<0.50	0.79	<0.50	<5.0
	12/23/04	<0.90	<0.90	<0.90	<0.90	<5.0
	02/25/05	<0.50	<0.50	0.85	<0.50	<5.0
	05/19/05	<0.50	<0.50	1	<0.50	<5.0
	09/15/05	<0.50	<0.50	9.5	<0.50	<5.0
	11/10/06	<0.50	<0.50	0.8	<0.50	<5.0
	03/20/06	<0.50	<0.50	1.5	<0.50	<5.0
	05/25/06	<0.50	<0.50	1.6	<0.50	<5.0
	08/23/06	<0.50	<0.50	1.3	<0.50	<5.0
	03/14/07	<0.50	<0.50	1.8	<0.50	<5.0
	06/12/07	<0.50	<0.50	1.9	<0.50	<5.0
	08/01/07	<0.12	<0.12	<0.15	<0.12	<6.9
	02/27/08	<0.20	<0.23	1.6	<0.19	<10
	05/13/08	<0.5	<0.5	7.9	<0.5	<5.0
	08/27/08	<0.5	<0.5	64	<0.5	30
	11/18/08	<0.5	<0.5	60	<0.5	27
	03/11/09	<0.5	<0.5	72	<0.5	<5.0
	09/22/09	<0.5	<0.5	88	<0.5	<5.0
	03/09/10	<0.5	<0.5	7.8	<0.5	<5.0
	09/09/10	<10.0	<10.0	<5.0	<10.0	199
	11/22/10	<1.0	<1.0	136	<1.0	<10
	01/25/11	<0.5	<0.5	84	<0.5	<5.0
	07/25/11	ND < 5.0	ND < 5.0	95	ND < 5.0	ND < 20
#California Department of Health Services primary maximum contamination level for drinking water.		None Listed	None Listed	5	None Listed	Action Level 12

TABLE 2A
Groundwater Sample Results for Oxygenated Volatile Organics
for 525 West A Street in Hayward, California

WELL NUMBER	DATE	DIPE ug/L	ETBE ug/L	MTBE ug/L	TAME ug/L	TBA ug/L
MW-6	02/05/92	--	--	--	--	--
	09/11/92	--	--	--	--	--
	12/22/92	--	--	--	--	--
	03/03/93	--	--	--	--	--
	06/23/93	--	--	--	--	--
	09/30/93	--	--	--	--	--
	02/06/94	--	--	--	--	--
	05/02/94	--	--	--	--	--
	07/01/94	--	--	--	--	--
	09/20/94	--	--	--	--	--
	12/06/94	--	--	--	--	--
	03/10/95	--	--	--	--	--
	03/15/95	--	--	--	--	--
	09/23/96	--	--	51	--	--
	12/04/96	--	--	130	--	--
	04/08/97	--	--	2,700	--	--
	06/30/97	--	--	<	--	--
	11/25/97	--	--	310	--	--
	06/01/98	--	--	160	--	--
	06/14/01	--	--	<20	--	--
	11/07/01	<5.0	<5.0	<5.0	<5.0	<50
	01/30/02	<5.0	<5.0	<5.0	<5.0	<50
	05/29/02	<0.5	<0.5	<5.0	<0.5	<50
	08/14/02	<2.0	<2.0	<2.0	<2.0	<20
	11/15/02	<0.5	<0.5	<0.5	<0.5	<5.0
	10/25/04	<0.50	<0.50	2.3	<0.50	<5.0
	12/23/04	<0.90	<0.90	1.5	<0.90	<5.0
	02/25/05	<0.50	<0.50	0.74	<0.50	<5.0
	05/19/05	<0.50	<0.50	3.1	<0.50	<5.0
	09/15/05	<0.50	<0.50	0.94	<0.50	<5.0
	11/10/06	<0.50	<0.50	0.81	<0.50	<5.0
	03/20/06	<0.50	<0.50	1.1	<0.50	<5.0
	05/25/06	<0.50	<0.50	3	<0.50	<5.0
	08/23/06	<0.50	<0.50	1.7	<0.50	<5.0
	03/14/07	<0.50	<0.50	10	<0.50	<5.0
	06/12/07	<0.50	<0.50	32	<0.50	<5.0
	08/01/07	<0.12	<0.13	50	<0.17	<6.9
	02/27/08	<0.20	<0.23	140	<0.19	<10
	05/13/08	<0.5	<0.5	127	<0.5	<5.0
	08/27/08	--	--	--	--	--
	11/18/08	--	--	--	--	--
	03/11/09	--	--	--	--	--
	03/09/10	--	--	--	--	--
	07/25/11	ND < 5.0	ND < 5.0	150	ND < 5.0	ND < 20
#California Department of Health Services primary maximum contamination level for drinking water.		None Listed	None Listed	5	None Listed	Action Level 12

Drinking Water Standards and Health Advisories for MTBE and TBA, SWRCB April 13, 2000. California MCL's. EPA Method 8260

TABLE 2A
Groundwater Sample Results for Oxygenated Volatile Organics
for 525 West A Street in Hayward, California

WELL NUMBER	DATE	DIPE ug/L	ETBE ug/L	MTBE ug/L	TAME ug/L	TBA ug/L
MW-7	06/23/93	--	--	--	--	--
	09/30/93	--	--	--	--	--
	02/06/94	--	--	--	--	--
	05/02/94	--	--	--	--	--
	07/01/94	--	--	--	--	--
	09/20/94	--	--	--	--	--
	12/06/94	--	--	--	--	--
	03/10/95	--	--	--	--	--
	03/15/95	--	--	--	--	--
	09/23/96	--	--	15	--	--
	12/04/96	--	--	22	--	--
	04/08/97	--	--	<	--	--
	06/30/97	--	--	280	--	--
	11/25/97	--	--	120	--	--
	06/01/98	--	--	160	--	--
	06/14/01	--	--	<20	--	--
	11/07/01	--	--	--	--	--
	01/30/02	<0.5	<0.5	<0.5	<0.5	<50
	05/29/02	<0.5	<0.5	<0.5	<0.5	<5.0
	08/14/02	<0.5	<0.5	<0.5	<0.5	<5.0
	11/15/02	<0.5	<0.5	<0.5	<0.5	<5.0
	10/25/04	--	--	--	--	--
	05/19/05	<0.50	<0.50	<0.50	<0.50	<5.0
	09/15/05	--	--	--	--	--
	11/10/06	<0.50	<0.50	<0.50	<0.50	<5.0
	03/20/06	--	--	--	--	--
	05/25/06	--	--	--	--	--
	08/23/06	<0.50	<0.50	<0.50	<0.50	<5.0
	03/14/07	<0.50	<0.50	<0.50	<0.50	<5.0
	06/12/07	--	--	--	--	--
	08/01/07	<0.12	<0.13	<0.15	<0.17	<6.9
	02/27/08	<0.20	<0.23	<0.19	<0.19	<10
	05/13/08	<0.5	<0.5	<0.5	<0.5	<5.0
	08/27/08	<0.5	<0.5	<0.5	<0.5	<5.0
	11/18/08	<0.5	<0.5	<0.5	<0.5	<5.0
	03/11/09	<0.5	<0.5	<0.5	<0.5	<5.0
	09/22/09	<0.5	<0.5	<0.5	<0.5	<5.0
	03/09/10	<0.5	<0.5	<0.5	<0.5	<5.0
	09/09/10	<1.0	<1.0	0.5	<1.0	<10
	01/25/11	<0.5	<0.5	0.7	<0.5	<5.0
#California Department of Health Services primary maximum contamination level for drinking water.		None Listed	None Listed	5	None Listed	Action Level 12

Drinking Water Standards and Health Advisories for MTBE and TBA, SWRCB April 13, 2000. California MCL's. EPA Method 8260

TABLE 2A
Groundwater Sample Results for Oxygenated Volatile Organics
for 525 West A Street in Hayward, California

WELL NUMBER	DATE	DIPE ug/L	ETBE ug/L	MTBE ug/L	TCE ug/L	TAME ug/L	TBA ug/L
MW-8	06/23/93	--	--	--	--	--	--
	09/30/93	--	--	--	--	--	--
	02/06/94	--	--	--	--	--	--
	05/02/94	--	--	--	--	--	--
	07/01/94	--	--	--	--	--	--
	09/20/94	--	--	--	--	--	--
	12/06/94	--	--	--	--	--	--
	03/10/95	--	--	--	--	--	--
	03/15/95	--	--	--	--	--	--
	09/23/96	<	<	<	<	<	<
#California Department of Health Services primary maximum contamination level for drinking water.		None Listed	None Listed	5		None Listed	Action Level 12

Drinking Water Standards and Health Advisories for MTBE and TBA, SWRCB April 13, 2000. California MCL's. EPA Method 8260

TABLE 2A
Groundwater Sample Results for Oxygenated Volatile Organics
for 525 West A Street in Hayward, California

WELL NUMBER	DATE	DIPE ug/L	ETBE ug/L	MTBE ug/L	TAME ug/L	TBA ug/L
MW-9	06/23/93	-	-	-	-	-
	09/30/93	-	-	-	-	-
	02/06/94	-	-	-	-	-
	05/02/94	-	-	-	-	-
	07/01/94	-	-	-	-	-
	09/20/94	-	-	-	-	-
	12/06/94	-	-	-	-	-
	03/10/95	-	-	-	-	-
	03/15/95	-	-	-	-	-
	07/25/11	ND < 2.5	ND < 2.5	110	ND < 2.5	12
#California Department of Health Services primary maximum contamination level for drinking water.		None Listed	None Listed	5	None Listed	Action Level 12

Drinking Water Standards and Health Advisories for MTBE and TBA, SWRCB April 13, 2000. California MCL's.
 * EPA Method 8260

TABLE 2A
Groundwater Sample Results for Oxygenated Volatile Organics
for 525 West A Street in Hayward, California

WELL NUMBER	DATE	DIPE ug/L	ETBE ug/L	MTBE ug/L	TAME ug/L	TBA ug/L
MW- 10	06/23/93	-	-	--	-	-
	09/30/93	-	-	--	-	-
	02/06/94	-	-	--	-	-
	05/02/94	-	-	--	-	-
	07/01/94	-	-	--	-	-
	09/20/94	-	-	--	-	-
	12/06/94	-	-	--	-	-
	03/10/95	-	-	--	-	-
	03/15/95	-	-	--	-	-
	09/23/96	-	-	397	-	-
	12/04/96	-	-	20	-	-
	#California Department of Health Services primary maximum contamination level for drinking water.		None Listed	None Listed	5	None Listed

Drinking Water Standards and Health Advisories for MTBE and TBA, SWRCB April 13, 2000. California MCL's.
 * EPA Method 8260

TABLE 2A
Groundwater Sample Results for Oxygenated Volatile Organics
for 525 West A Street in Hayward, California

WELL NUMBER	DATE	DIPE ug/L	ETBE ug/L	MTBE ug/L	TAME ug/L	TBA ug/L
MW-11	02/10/95	-	-	--	-	-
	03/10/95	-	-	--	-	-
	03/15/95	-	-	--	-	-
	09/23/96	-	-	40	-	-
	12/04/96	-	-	--	-	-
	04/08/97	-	-	<	-	-
#California Department of Health Services primary maximum contamination level for drinking water.		None Listed	None Listed	5	None Listed	Action Level 12

TABLE 2A
Groundwater Sample Results for Oxygenated Volatile Organics
for 525 West A Street in Hayward, California

WELL NUMBER	DATE	DIPE ug/L	ETBE ug/L	MTBE ug/L	TAME ug/L	TBA ug/L
MW-12	02/10/95	--	--	--	--	--
	03/10/95	--	--	--	--	--
	03/14/95	--	--	--	--	--
	09/23/96	--	--	--	--	--
	12/04/96	--	--	--	--	--
	04/08/97	--	--	--	--	--
	06/30/97	--	--	--	--	--
	11/25/97	--	--	--	--	--
	06/01/98	--	--	--	--	--
	06/14/01	--	--	--	<5.0	--
	11/07/01	<0.5	<0.5	<0.5	<0.5	<5.0
	01/30/02	<0.5	<0.5	<0.5	<0.5	<5.0
	05/29/02	<0.5	<0.5	<0.5	<0.5	<5.0
	08/14/02	<0.5	<0.5	<0.5	<0.5	<5.0
	11/15/02	<0.5	<0.5	<0.5	<0.5	<5.0
	10/25/04	--	--	--	--	--
	02/25/05	<0.5	<0.5	<0.5	<0.5	<5.0
	05/19/05	<0.5	<0.5	<0.5	<0.5	<5.0
	09/15/05	<0.5	<0.5	<0.5	<0.5	<5.0
	11/10/05	<0.50	<0.50	<0.50	<0.50	<5.0
	03/20/06	<0.50	<0.50	<0.50	<0.50	<5.0
	05/25/06	<0.50	<0.50	<0.50	<0.50	<5.0
	08/23/06	<0.50	<0.50	<0.50	<0.50	<5.0
	03/14/07	<0.50	<0.50	<0.50	<0.50	<5.0
	06/11/07	<0.50	<0.50	<0.50	<0.50	<5.0
	08/01/07	<0.12	<0.13	<0.15	<0.17	<6.9
	02/27/08	<0.20	<0.23	<0.19	<0.19	<10
	05/13/08	<0.5	<0.5	<0.5	<0.5	<5.0
	08/27/08	<0.5	<0.5	<0.5	<0.5	<5.0
	11/18/08	<0.5	<0.5	<0.5	<0.5	<5.0
03/11/09	<0.5	<0.5	<0.5	<0.5	<5.0	
09/22/09	<0.5	<0.5	<0.5	<0.5	<5.0	
03/09/10	<0.5	<0.5	<0.5	<0.5	<5.0	
01/25/11	<0.5	<0.5	<0.5	<0.5	<5.0	
07/25/11	<0.5	<0.5	<0.5	<0.5	<2.0	
#California Department of Health Services primary maximum contamination level for drinking water.		None Listed	None Listed	5	None Listed	Action Level 12

* Drinking Water Standards and Health Advisories for MTBE and TBA, SWRCB April 13, 2000. California MCL's.
 * EPA Method 8260

TABLE 2A
Groundwater Sample Results for Oxygenated Volatile Organics
for 525 West A Street in Hayward, California

WELL NUMBER	DATE	DIPE ug/L	ETBE ug/L	MTBE ug/L	TAME ug/L	TBA ug/L
MW-13	02/10/95	--	--	--	--	--
	03/10/95	--	--	--	--	--
	03/14/95	--	--	--	--	--
	09/23/96	--	--	<	--	--
	12/04/96	--	--	--	--	--
	04/08/97	--	--	<	--	--
	06/30/97	--	--	--	--	--
	11/25/97	--	--	--	--	--
	06/01/98	--	--	--	--	--
	06/14/01	--	--	<5.0	--	--
	11/07/01	<0.5	<0.5	<0.5	<0.5	<5.0
	01/30/02	<0.5	<0.5	<0.5	<0.5	<5.0
	05/29/02	<0.5	<0.5	<0.5	<0.5	<5.0
	08/14/02	<0.5	<0.5	<0.5	<0.5	<5.0
	11/15/02	--	--	--	--	--
10/25/04	--	--	--	--	--	
07/25/11	<0.5	<0.5	<0.5	<0.5	<2.0	
#California Department of Health Services primary maximum contamination level for drinking water.		None Listed	None Listed	5	None Listed	Action Level 12

Drinking Water Standards and Health Advisories for MTBE and TBA, SWRCB April 13, 2000. California MCL's.
 * EPA Method 8260

TABLE 2A
Groundwater Sample Results for Oxygenated Volatile Organics
for 525 West A Street in Hayward, California

WELL NUMBER	DATE	DIPE ug/L	ETBE ug/L	MTBE ug/L	TAME ug/L	TBA ug/L
MW-14	02/10/95	--	--	--	--	--
	03/10/95	--	--	--	--	--
	03/14/95	--	--	--	--	--
	09/23/96	--	--	9.6	--	--
	12/04/96	--	--	30	--	--
	04/08/97	--	--	<	--	--
	06/30/97	--	--	<	--	--
	11/25/97	--	--	<	--	--
	06/01/98	--	--	<5	--	--
	06/14/01	--	--	<5	--	--
	11/07/01	<0.5	<0.5	<0.5	<0.5	<5.0
	01/30/02	<0.5	<0.5	<0.5	<0.5	<5.0
	05/29/02	<0.5	<0.5	<0.5	<0.5	<5.0
	08/14/02	<0.5	<0.5	<0.5	<0.5	<5.0
	11/15/02	<0.5	<0.5	<0.5	<0.5	<5.0
	10/25/04	--	--	--	--	--
	02/25/05	<0.5	<0.5	<0.5	<0.5	<5.0
	05/19/05	<0.5	<0.5	<0.5	<0.5	<0.5
	09/15/05	--	--	--	--	--
	11/10/05	--	--	--	--	--
	03/20/06	<0.5	<0.5	<0.5	<0.5	<5.0
	05/25/06	<0.5	<0.5	<0.5	<0.5	<5.0
	08/23/06	<0.5	<0.5	<0.5	<0.5	<5.0
	03/14/07	<0.5	<0.5	<0.5	<0.5	<5.0
	06/11/07	<0.5	<0.5	<0.5	<0.5	<5.0
	08/01/07	<0.12	<0.13	<0.15	<0.17	<6.9
	02/27/08	<0.20	<0.23	<0.19	<0.19	<10
	05/13/08	<0.5	<0.5	<0.5	<0.5	<5.0
	08/27/08	<0.5	<0.5	<0.5	<0.5	<5.0
	11/18/08	<0.5	<0.5	<0.5	<0.5	<5.0
	03/11/09	<0.5	<0.5	<0.5	<0.5	<5.0
	09/22/09	<0.5	<0.5	<0.5	<0.5	<5.0
03/09/10	<0.5	<0.5	<0.5	<0.5	<5.0	
01/25/11	<0.5	<0.5	<0.5	<0.5	<5.0	
07/25/11	<0.5	<0.5	<0.5	<0.5	<2.0	
#California Department of Health Services primary maximum contamination level for drinking water.		None Listed	None Listed	5	None Listed	Action Level 12

Drinking Water Standards and Health Advisories for MTBE and TBA, SWRCB April 13, 2000. California MCL's.
 * EPA Method 8260

TABLE 2A
Groundwater Sample Results for Oxygenated Volatile Organics
for 525 West A Street in Hayward, California

WELL NUMBER	DATE	DIPE ug/L	ETBE ug/L	MTBE ug/L	TAME ug/L	TBA ug/L
EX-1	08/14/02	<0.5	<0.5	1.4	<0.5	<5.0
	11/15/02	<0.5	<0.5	0.7	<0.5	<5.0
	10/25/04	<0.5	<0.5	<0.5	<0.5	<5.0
	02/25/05	<0.50	<0.50	<0.50	<0.50	<5.0
	05/19/05	<0.50	<0.50	<0.50	<0.50	<5.0
	09/15/05	<0.50	<0.50	1.3	<0.50	<5.0
	11/10/05	<0.50	<0.50	1.2	<0.50	<5.0
	03/20/06	<0.50	<0.50	0.94	<0.50	<5.0
	05/25/06	<0.50	<0.50	0.94	<0.50	<5.0
	08/23/06	<0.50	<0.50	0.79	<0.50	<5.0
	03/14/07	<0.50	<0.50	1.2	<0.50	<5.0
	06/11/07	<0.50	<0.50	1.7	<0.50	<5.0
	08/01/07	<0.50	<0.50	4.3	<0.50	<5.0
	02/27/08	<0.12	<0.13	3.6	<0.17	<6.9
	05/13/08	--	--	--	--	--
	08/27/08	<0.5	<0.5	94	<0.5	22
	11/18/08	<0.5	<0.5	16	<0.5	7.9
	03/11/09	<0.5	<0.5	151	<0.5	<5.0
	09/22/09	<0.5	<0.5	79	<0.5	<5.0
	03/09/10	<0.5	<0.5	239	<0.5	<5.0
09/09/10	<2.0	<2.0	217	<2.0	<20.0	
01/25/11	NT	NT	NT	NT	NT	
07/25/11	ND < 10	ND < 10	320	ND < 10	< 2.0	
#California Department of Health Services primary maximum contamination level for drinking water.		None Listed	None Listed	5	None Listed	Action Level 12

Drinking Water Standards and Health Advisories for MTBE and TBA, SWRCB April 13, 2000. California MCL's.
 * EPA Method 8260

TABLE 2A
Groundwater Sample Results for Oxygenated Volatile Organics
for 525 West A Street in Hayward, California

WELL NUMBER	DATE	DIPE ug/L	ETBE ug/L	MTBE ug/L	TAME ug/L	TBA ug/L
VEAS-2	05/19/05	<0.50	<0.50	1.4	<0.50	< 5.0
	09/15/05	<0.50	<0.50	<0.50	<0.50	< 5.0
	11/10/05	--	--	--	--	--
	07/25/11	< 0.5	< 0.5	< 0.5	< 0.5	< 2.0
#California Department of Health Services primary maximum contamination level for drinking water.		None Listed	None Listed	5	None Listed	Action Level 12

Drinking Water Standards and Health Advisories for MTBE and TBA, SWRCB April 13, 2000. California MCL's.
 * EPA Method 8260

TABLE 2A
Groundwater Sample Results for Oxygenated Volatile Organics
for 525 West A Street in Hayward, California

WELL NUMBER	DATE	DIPE ug/L	ETBE ug/L	MTBE ug/L	TAME ug/L	TBA ug/L
VEAS-3	07/25/11	ND < 1.7	ND < 1.7	ND < 1.7	ND < 1.7	ND < 6.7
#California Department of Health Services primary maximum contamination level for drinking water.		None Listed	None Listed	5	None Listed	Action Level 12

Drinking Water Standards and Health Advisories for MTBE and TBA, SWRCB April 13, 2000. California MCL's.
 * EPA Method 8260

4.0 CONCLUSIONS

Based upon the current groundwater flow calculations, *Gallardo & Associates, Inc.* concludes that groundwater flow beneath the property for this quarter was generally to the northwest, with a hydraulic gradient was approximately 0.008 ft/ft. However, a groundwater depression was observed around wells MW-3, MW-4, MW-5, and EX-1. Current analytical results reveal increasing concentrations of TPH-g within wells MW-1, MW-4, and MW-5. Increased concentrations of benzene were also detected within well MW-4. The center of the TPH-g groundwater plume rests within MW-1, while the center of the benzene groundwater plume rests within MW-4. The center of the MTBE groundwater plume rests within wells MW-4 and EX-1. The off-site extent of the groundwater plume appears to extend across West A street and Garden Street. Additional wells will need to be placed in these areas to define the lateral extent of the groundwater plumes.

5.0 RECOMMENDATIONS

Based upon the above observations and conclusions, and to approach eventual closure at this site, *Gallardo & Associates, Inc.* recommends the following work:

- Continuation of bi-annual sampling of wells EX-1, VEAS-2, MW-1A, MW-12, MW-13, and MW-14. However, quarterly groundwater sampling of wells MW-1, MW-3, MW-4, MW-5, MW-6, MW-9, and VEAS-3 is highly recommended so that plume definition and the groundwater flow pattern can be better established.
- Additional groundwater monitoring wells to define the lateral extent and vertical extent of the soil and groundwater plumes to the south, north, east, and west of the site property lines.

6.0 SCHEDULE OF ACTIVITIES FOR NEXT QUARTER

The next bi-annual sampling event is scheduled to occur in January 2012. After groundwater levels are measured, samples will be collected from each well and analyzed for **TPH-g**, **BTEX**, by EPA Method 8015/8020 and **Volatile Halocarbons** including the **Fuel Oxygenates** by EPA Method 8260. The First quarter 2012 report will present *Gallardo & Associates, Inc.'s* 2nd episode of groundwater sampling results for this site.

7.0 REPORT DISTRIBUTION

Gallardo & Associates, Inc. recommends that this report be distributed to the following agencies:

- *Alameda County Environmental Health Department (ACEHD)*
1131 Harbor Bay Parkway
Alameda, CA. 94502
Attention: *Mr. Mark Detterman, P.G., C.E.G.*

8.0 LIMITATIONS

This report has been prepared in accordance with generally accepted environmental, geological and engineering practices. ***Gallardo & Associates, Inc.*** makes no warranty, either expressed or implied, as to the professional advice presented herein. The analysis, conclusions and recommendations contained in this quarterly monitoring report are based upon site conditions as they existed at the time of the investigation and they are subject to change. The conclusions presented in this report are professional opinions based solely upon past and present laboratory analytical results, visual observations of the site and vicinity, and interpretation of available information as described in this report. Any use or reuse of this document or its findings, conclusions or recommendations presented herein is at the sole risk of said user. This report was prepared by or under the direction and supervision of a California licensed Professional Geologist.

9.0 REFERENCES

Well Destruction Report, Former RPMS, (E-Z Serve 100877) Located at 525 West A Street in Hayward, California., by Delta Environmental Consultants, Inc., dated April 28, 2006.

Site Conceptual Model and Preferential Pathway Study, Former RPMS, (E-Z Serve 100877) Located at 525 West A Street in Hayward, California., by GeoEnviro Services, Inc., dated February 2011.

9.1 Geological References:

None at this time.

APPENDIX A

WELL AND PURGE DATA
(July 25, 2011)

WELL/HYDROLOGIC STATISTICS

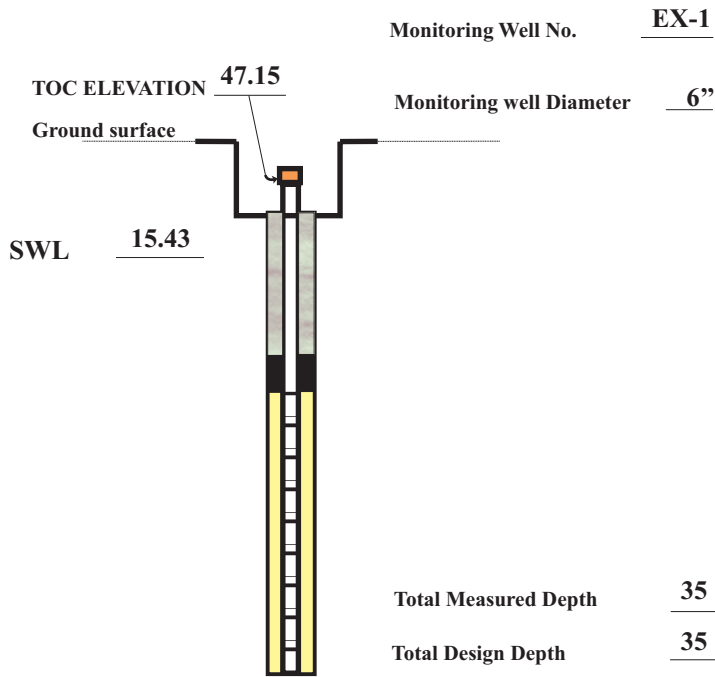

Action	Surger Block	Development Tool used	Well Depth
Depth of well @ Start			
Surged well from bottom to top of well Screen			
Well purging			
Depth of well @ Finish			
Stop			
Sampled			
(Final IWL)			

Purge Calculator

$1.469 \text{ Gal/ft} \times 19.57 \text{ ft} = 28.74 \text{ gals.}$ (SWL to BOP or packer to BOP one volume)

$28.74 \text{ gals.} \times 3 = 86.24 \text{ gals.}$ (purge volume- 3 casings)

Actual Gallons Purged:	86.5
Actual Volumes Purged:	3.00
Well Yield:	

Equipment Used/Sampling method/Description of Event:

- Slope Indicator
- Hydac Kit
- Tool Box
- Bag of Ice
- 55-Gallon D.O.T. Drum
- 3/8-inch diameter tubing () Feet
- One Pair of Nitrile Gloves
- 3/4-inch diameter disposable bailer

Additional Comments:

Car parked over well during initial depth to water readings

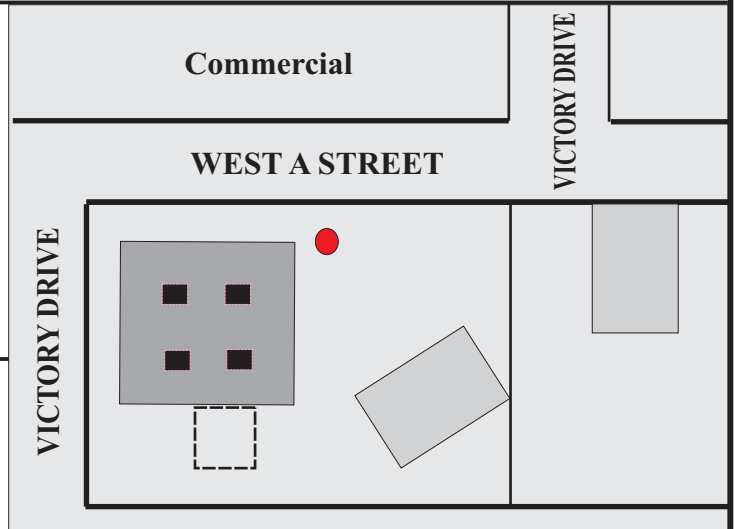

Gallons Purged	TEMP C/F (Circle One)	EC (us/cm)	PH	TURBIDITY (NTU)	HEAD (FT)	TIME
1. 85.5	67.4	1215	6.61			
2. 86.0	67.4	1212	6.60			
3. 86.5	67.5	1214	6.52			
4.						

VOLUME OF WATER IN CASING OR BOREHOLE

1.0 = 0.041	4.0 = 0.653	7.0 = 2.00
1.5 = 0.092	4.5 = 0.826	8.0 = 2.611
2.0 = 0.163	5.0 = 1.020	9.0 = 3.305
2.5 = 0.255	6.0 = 1.469	

**GROUNDWATER MONITORING
WELL SAMPLING EVENT SHEET**

EX-1

GALLARDO & ASSOCIATES, INC.

ENVIRONMENTAL AND GEOLOGICAL SERVICES

304 Belle Court, El Dorado Hills, CA 95762

(916) 358-3719

(916) 358-3719 FAX

PROJECT NAME: **525 West A Street (EZ-SERVE) Hayward**

PROJECT No.: **001.11**

SAMPLER: **Gallardo**

DATE: **07/25/11**

WELL/HYDROLOGIC STATISTICS

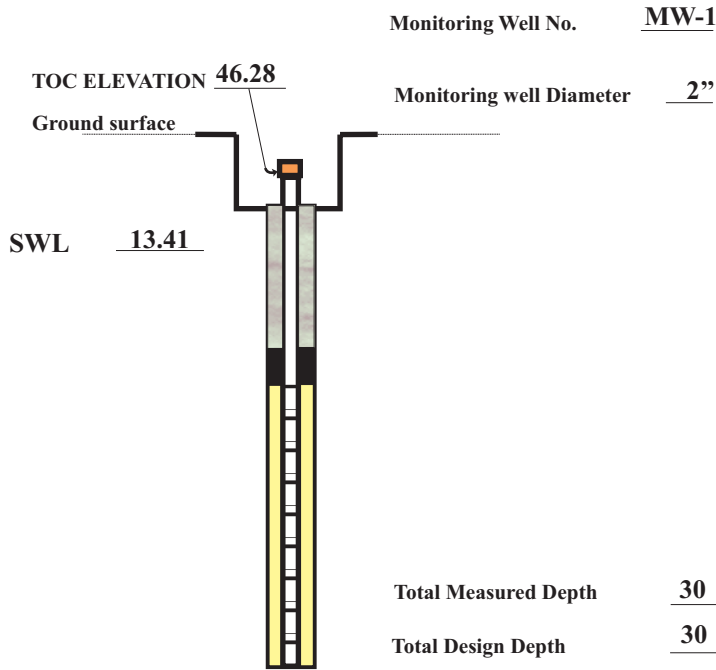

Action	Surger Block	Development Tool used	Well Depth
Depth of well @ Start			
Surged well from bottom to top of well Screen			
Well purging			
Depth of well @ Finish			
Stop			
Sampled			
(Final IWL)			

Purge Calculator

$$0.163 \text{ Gal/ft} \times 16.59 \text{ ft} \times 2.70 \text{ gals.} \times 3 = 8.11 \text{ gals.}$$

SWL to BOP or packer to BOP
one volume
purge volume- 3 casings

Actual Gallons Purged:	<u>8.5</u>
Actual Volumes Purged:	<u>3.14</u>
Well Yield:	<u> </u>

Equipment Used/Sampling method/Description of Event:

- Slope Indicator
- Hydac Kit
- Tool Box
- Bag of Ice
- 55-Gallon D.O.T. Drum
- 3/8-inch diameter tubing () Feet
- One Pair of Nitrile Gloves
- 3/4-inch diameter disposable bailer

Additional Comments:

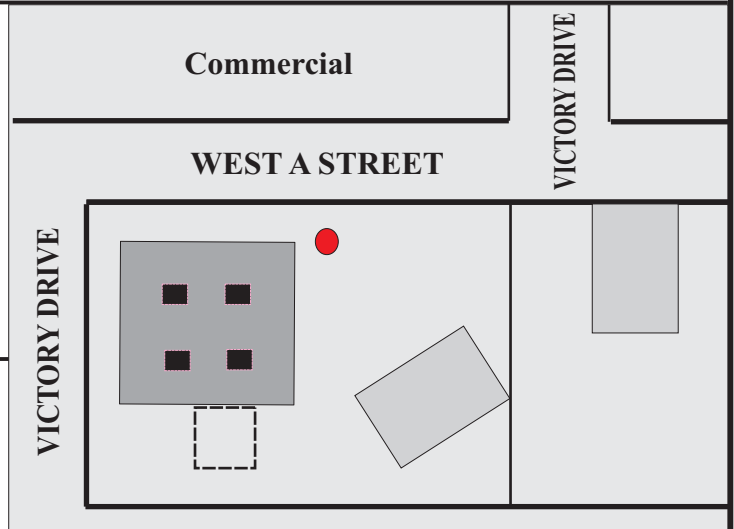

Gallons Purged	TEMP C/F (Circle One)	EC (us/cm)	PH	TURBIDITY (NTU)	HEAD (FT)	TIME
1. 7.5	71.0	1,189	6.51			
2. 8.0	69.9	1,180	6.48			
3. 8.5	69.6	1,174	6.47			
4.						

VOLUME OF WATER IN CASING OR BOREHOLE

1.0 = 0.041	4.0 = 0.653	7.0 = 2.00
1.5 = 0.092	4.5 = 0.826	8.0 = 2.611
2.0 = 0.163	5.0 = 1.020	9.0 = 3.305
2.5 = 0.255	6.0 = 1.469	

**GROUNDWATER MONITORING
WELL SAMPLING EVENT SHEET**

MW-1

WELL/HYDROLOGIC STATISTICS

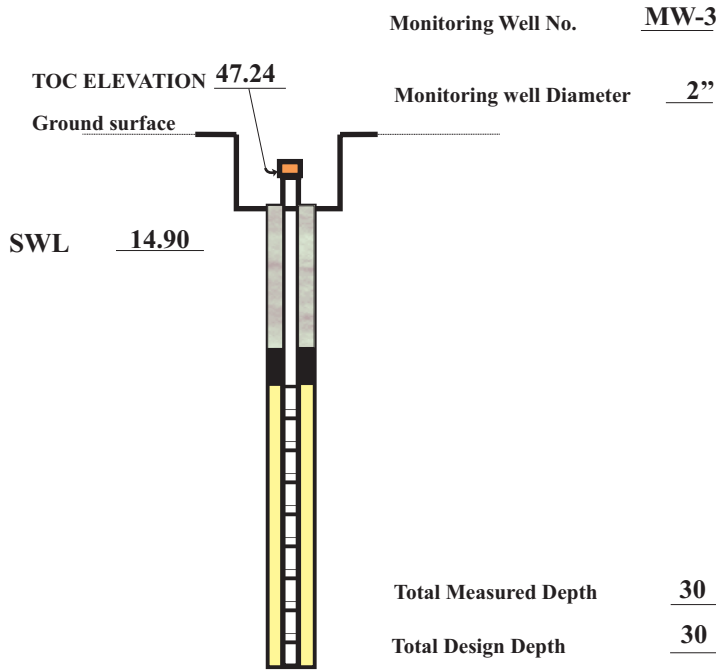

Action	Surger Block	Development Tool used	Well Depth
Depth of well @ Start			
Surged well from bottom to top of well Screen			
Well purging			
Depth of well @ Finish			
Stop			
Sampled			
(Final IWL)			

Purge Calculator

0.163 Gal/ft 15.10 ft 2.46 gals. X 3 = 7.38 gals.

SWL to BOP or packer to BOP one volume purge volume-3 casings

Actual Gallons Purged:	<u>7.5</u>
Actual Volumes Purged:	<u>3.04</u>
Well Yield:	

Equipment Used/Sampling method/Description of Event:

- Slope Indicator
- Hydac Kit
- Tool Box
- Bag of Ice
- 55-Gallon D.O.T. Drum
- 3/8-inch diameter tubing () Feet
- One Pair of Nitrile Gloves
- 3/4-inch diameter disposable bailer

Additional Comments:

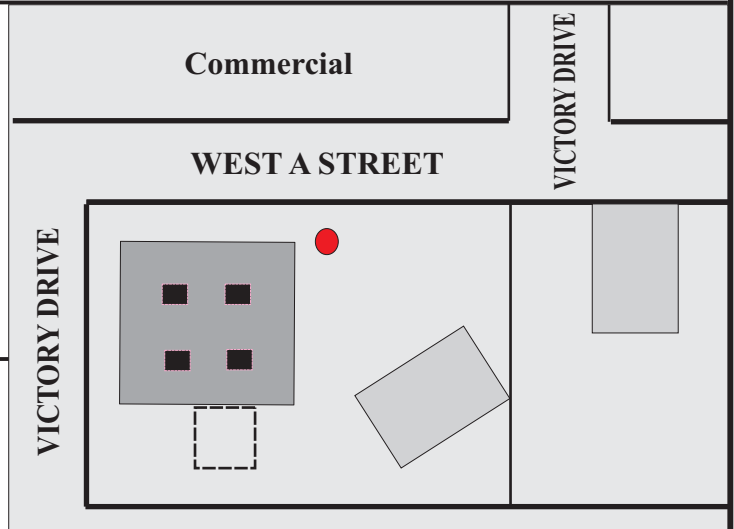

Gallons Purged	TEMP C/F (Circle One)	EC (us/cm)	PH	TURBIDITY (NTU)	HEAD (FT)	TIME
1. 6.5	67.9	1,111	6.86			
2. 7.0	67.3	1,113	6.69			
3. 7.5	67.0	1,117	6.70			
4.						

VOLUME OF WATER IN CASING OR BOREHOLE

1.0 = 0.041	4.0 = 0.653	7.0 = 2.00
1.5 = 0.092	4.5 = 0.826	8.0 = 2.611
2.0 = 0.163	5.0 = 1.020	9.0 = 3.305
2.5 = 0.255	6.0 = 1.469	

**GROUNDWATER MONITORING
WELL SAMPLING EVENT SHEET**

MW-3

WELL/HYDROLOGIC STATISTICS

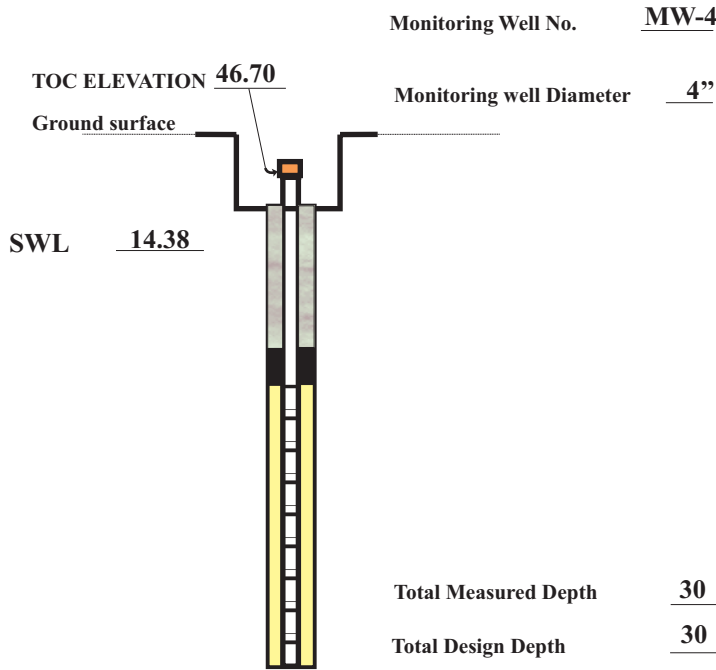

Action	Surger Block	Development Tool used	Well Depth
Depth of well @ Start			
Surged well from bottom to top of well Screen			
Well purging			
Depth of well @ Finish			
Stop			
Sampled			
(Final IWL)			

Purge Calculator

0.653 Gal/ft **15.62** ft **10.19** gals. X 3 = **30.59** gals.

SWL to BOP or packer to BOP one volume purge volume-3 casings

Actual Gallons Purged:	31.0
Actual Volumes Purged:	3.04
Well Yield:	

Equipment Used/Sampling method/Description of Event:

- Slope Indicator
- Hydac Kit
- Tool Box
- Bag of Ice
- 55-Gallon D.O.T. Drum
- 3/8-inch diameter tubing () Feet
- One Pair of Nitrile Gloves
- 3/4-inch diameter disposable bailer

Additional Comments:

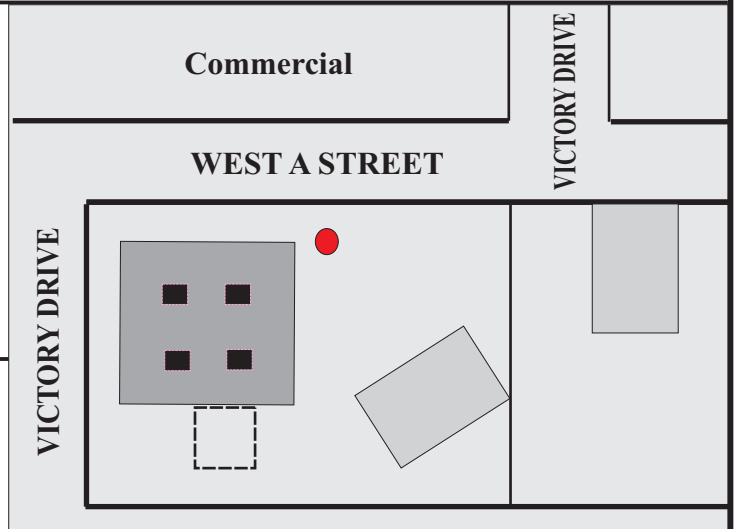

Gallons Purged	TEMP C/F (Circle One)	EC (us/cm)	PH	TURBIDITY (NTU)	HEAD (FT)	TIME
1. 30.0	68.4	1,232	6.83			
2. 30.5	67.7	1,245	6.63			
3. 31.0	67.7	1,245	6.57			
4.						

VOLUME OF WATER IN CASING OR BOREHOLE

1.0 = 0.041	4.0 = 0.653	7.0 = 2.00
1.5 = 0.092	4.5 = 0.826	8.0 = 2.611
2.0 = 0.163	5.0 = 1.020	9.0 = 3.305
2.5 = 0.255	6.0 = 1.469	

GROUNDWATER MONITORING WELL SAMPLING EVENT SHEET

MW-4

GALLARDO & ASSOCIATES, INC.

ENVIRONMENTAL AND GEOLOGICAL SERVICES

304 Belle Court, El Dorado Hills, CA 95762

(916) 358-3719

(916) 358-3719 FAX

PROJECT NAME: **525 West A Street (EZ-SERVE) Hayward**

PROJECT No.: **001.11**

SAMPLER: **Gallardo**

DATE: **07/25/11**

WELL/HYDROLOGIC STATISTICS

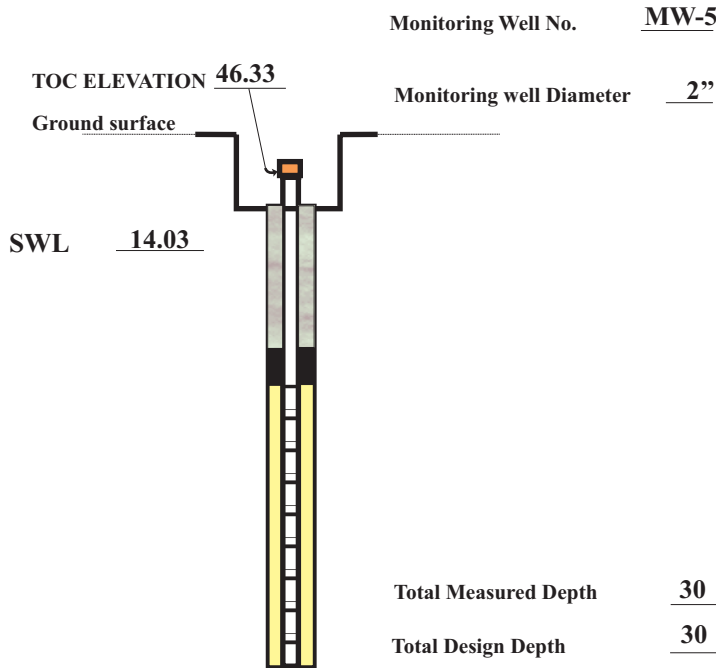

Action	Surger Block	Development Tool used	Well Depth
Depth of well @ Start			
Surged well from bottom to top of well Screen			
Well purging			
Depth of well @ Finish			
Stop			
Sampled			
(Final IWL)			

Purge Calculator

$$0.163 \text{ Gal/ft} \times 15.97 \text{ ft} \times 2.60 \text{ gals.} \times 3 = 7.80 \text{ gals.}$$

SWL to BOP or packer to BOP
one volume
purge volume- 3 casings

Actual Gallons Purged:	<u>8.0</u>
Actual Volumes Purged:	<u>3.07</u>
Well Yield:	<u> </u>

Equipment Used/Sampling method/Description of Event:

- Slope Indicator
- Hydac Kit
- Tool Box
- Bag of Ice
- 55-Gallon D.O.T. Drum
- 3/8-inch diameter tubing () Feet
- One Pair of Nitrile Gloves
- 3/4-inch diameter disposable bailer

Additional Comments:

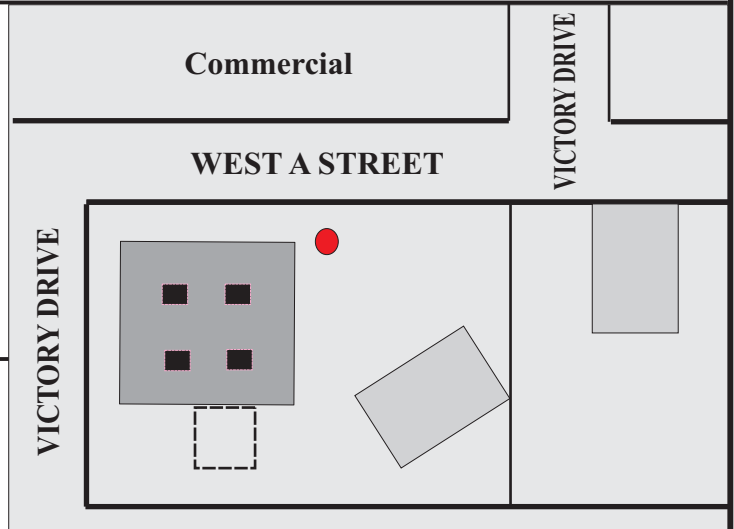

Gallons Purged	TEMP C/F (Circle One)	EC (us/cm)	PH	TURBIDITY (NTU)	HEAD (FT)	TIME
1. 7.0	68.0	1,222	6.58			
2. 7.5	69.0	1,228	6.57			
3. 8.0	69.3	1,246	6.57			
4.						

VOLUME OF WATER IN CASING OR BOREHOLE

1.0 = 0.041	4.0 = 0.653	7.0 = 2.00
1.5 = 0.092	4.5 = 0.826	8.0 = 2.611
2.0 = 0.163	5.0 = 1.020	9.0 = 3.305
2.5 = 0.255	6.0 = 1.469	

**GROUNDWATER MONITORING
WELL SAMPLING EVENT SHEET**

MW-5

WELL/HYDROLOGIC STATISTICS

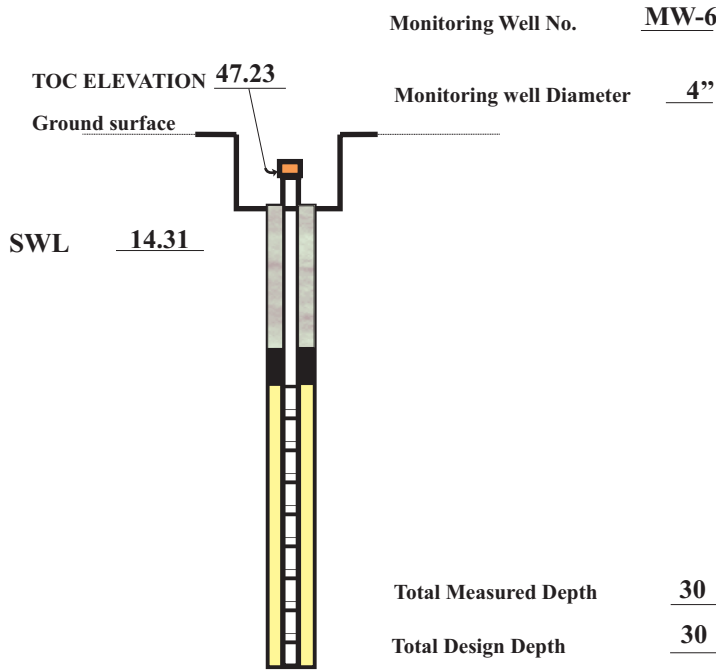

Action	Surger Block	Development Tool used	Well Depth
Depth of well @ Start			
Surged well from bottom to top of well Screen			
Well purging			
Depth of well @ Finish			
Stop			
Sampled			
(Final IWL)			

Purge Calculator

$$0.653 \text{ Gal/ft} \times 15.69 \text{ ft} = 10.24 \text{ gals.} \times 3 = 30.73 \text{ gals.}$$

SWL to BOP or packer to BOP
one volume
purge volume- 3 casings

Actual Gallons Purged:	31.0
Actual Volumes Purged:	3.02
Well Yield:	

Equipment Used/Sampling method/Description of Event:

- Slope Indicator
- Hydac Kit
- Tool Box
- Bag of Ice
- 55-Gallon D.O.T. Drum
- 3/8-inch diameter tubing () Feet
- One Pair of Nitrile Gloves
- 3/4-inch diameter disposable bailer

Additional Comments:

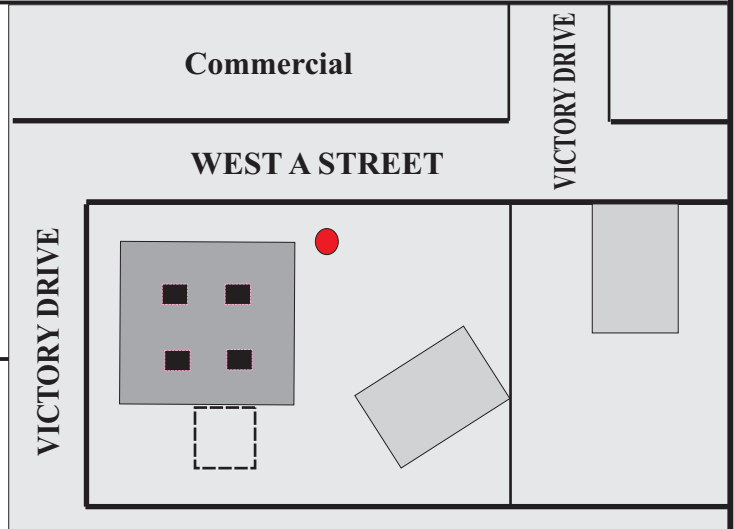

Gallons Purged	TEMP C/F (Circle One)	EC (us/cm)	PH	TURBIDITY (NTU)	HEAD (FT)	TIME
1. 30.0	68.4	1,180	6.63			
2. 30.5	67.8	1,188	6.55			
3. 31.0	67.4	1,183	6.54			
4.						

VOLUME OF WATER IN CASING OR BOREHOLE

1.0 = 0.041	4.0 = 0.653	7.0 = 2.00
1.5 = 0.092	4.5 = 0.826	8.0 = 2.611
2.0 = 0.163	5.0 = 1.020	9.0 = 3.305
2.5 = 0.255	6.0 = 1.469	

**GROUNDWATER MONITORING
WELL SAMPLING EVENT SHEET**

MW-6

WELL/HYDROLOGIC STATISTICS

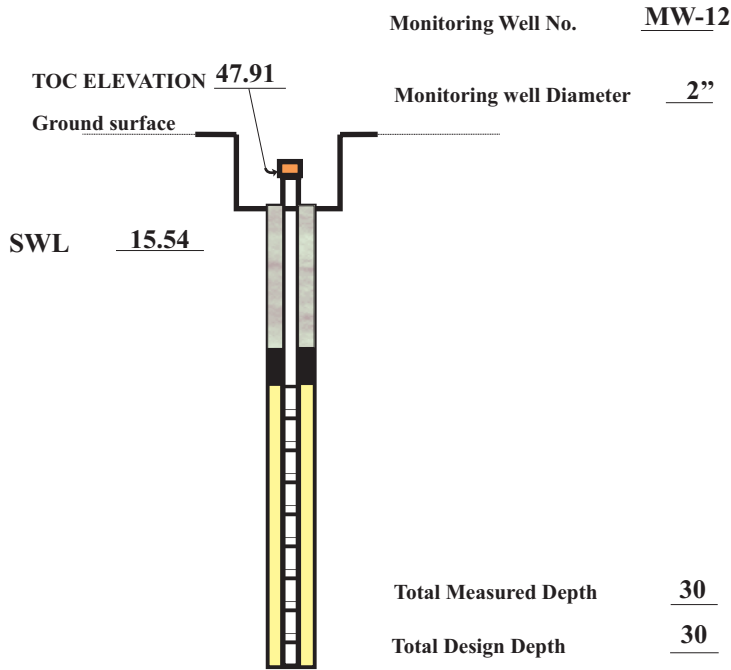

Action	Surger Block	Development Tool used	Well Depth
Depth of well @ Start			
Surged well from bottom to top of well Screen			
Well purging			
Depth of well @ Finish			
Stop			
Sampled			
(Final IWL)			

Purge Calculator

0.163 Gal/ft 14.46 ft 2.35 gals. X 3 = 7.07 gals.

SWL to BOP or packer to BOP one volume purge volume-3 casings

Actual Gallons Purged:	<u>7.5</u>
Actual Volumes Purged:	<u>3.19</u>
Well Yield:	

Equipment Used/Sampling method/Description of Event:

- Slope Indicator
- Hydac Kit
- Tool Box
- Bag of Ice
- 55-Gallon D.O.T. Drum
- 3/8-inch diameter tubing () Feet
- One Pair of Nitrile Gloves
- 3/4-inch diameter disposable bailer

Additional Comments:

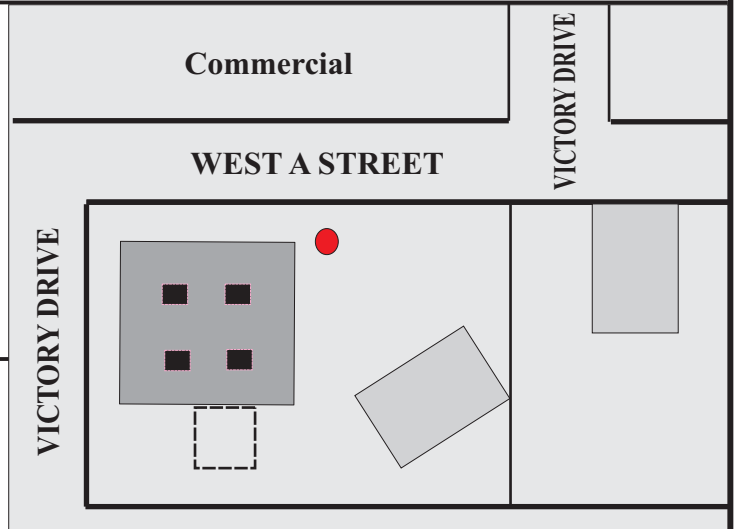

Gallons Purged	TEMP C/F (Circle One)	EC (us/cm)	PH	TURBIDITY (NTU)	HEAD (FT)	TIME
1. 6.5	65.3	674	7.36			
2. 7.0	65.2	693	6.97			
3. 7.5	64.7	686	6.89			
4.						

VOLUME OF WATER IN CASING OR BOREHOLE

1.0 = 0.041	4.0 = 0.653	7.0 = 2.00
1.5 = 0.092	4.5 = 0.826	8.0 = 2.611
2.0 = 0.163	5.0 = 1.020	9.0 = 3.305
2.5 = 0.255	6.0 = 1.469	

**GROUNDWATER MONITORING
WELL SAMPLING EVENT SHEET**

MW-12

WELL/HYDROLOGIC STATISTICS

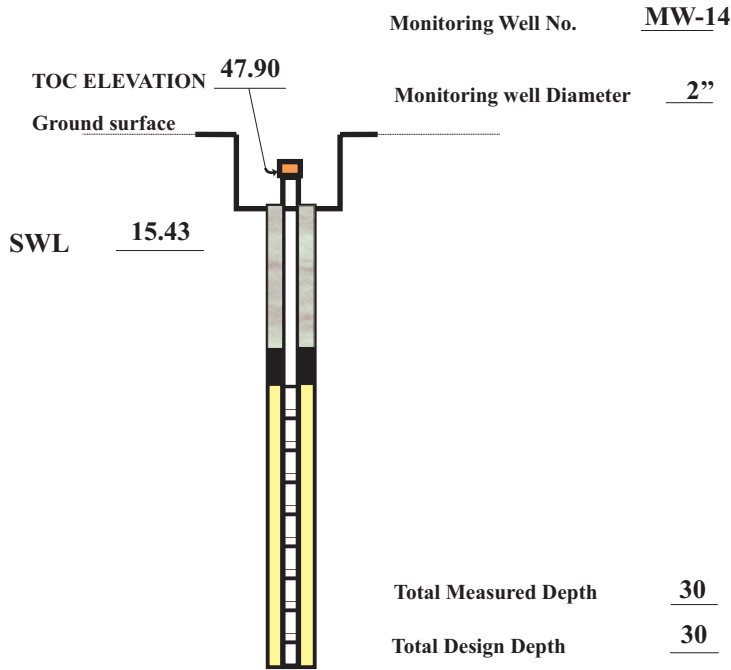

Action	Surger Block	Development Tool used	Well Depth
Depth of well @ Start			
Surged well from bottom to top of well Screen			
Well purging			
Depth of well @ Finish			
Stop			
Sampled			
(Final IWL)			

Purge Calculator

$$0.163 \text{ Gal/ft} \times 14.57 \text{ ft} = 2.37 \text{ gals.} \times 3 = 7.12 \text{ gals.}$$

SWL to BOP or packer to BOP one volume purge volume-3 casings

Actual Gallons Purged:	7.5
Actual Volumes Purged:	3.16
Well Yield:	

Equipment Used/Sampling method/Description of Event:

- Slope Indicator
- Hydac Kit
- Tool Box
- Bag of Ice
- 55-Gallon D.O.T. Drum
- 3/8-inch diameter tubing () Feet
- One Pair of Nitrile Gloves
- 3/4-inch diameter disposable bailer

Additional Comments:

Car parked over well during initial depth to water readings

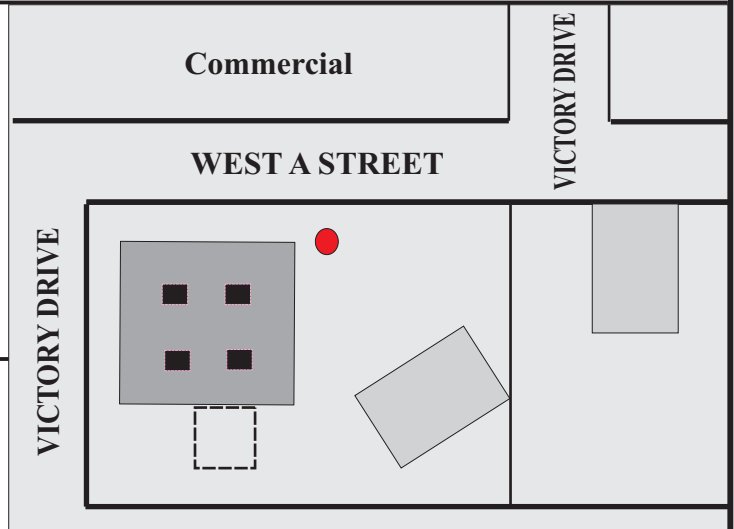

Gallons Purged	TEMP C/F (Circle One)	EC (us/cm)	PH	TURBIDITY (NTU)	HEAD (FT)	TIME
1. 6.5	65.9	883	6.87			
2. 7.0	65.5	885	6.88			
3. 7.5	65.2	891	6.81			
4.						

VOLUME OF WATER IN CASING OR BOREHOLE

1.0 = 0.041	4.0 = 0.653	7.0 = 2.00
1.5 = 0.092	4.5 = 0.826	8.0 = 2.611
2.0 = 0.163	5.0 = 1.020	9.0 = 3.305
2.5 = 0.255	6.0 = 1.469	

**GROUNDWATER MONITORING
WELL SAMPLING EVENT SHEET**

MW-14

Virgil Chavez Land Surveying

721 Tuolumne Street

Vallejo, California 94590

(707) 553-2476 • Fax (707) 553-8698

August 16, 2011

Project No.: 2933-01

Rafael Gallardo
Gallardo & Associates
304 Belle Court
El Dorado Hills, CA 95762

Subject: Monitoring Well Survey
525 West A Street
Hayward, Ca

Dear Rafael:

This is to confirm that we have proceeded at your request to survey the monitoring wells at the above referenced location. The survey was initiated on July 12, 2011, and completed on August 4, 2011. The benchmark for this survey was a City disk at Victoria on the south side of A Street. The latitude, longitude and coordinates are for top of casings and are based on the California State Coordinate System, Zone II (NAD83).
Benchmark Elevation = 46.15 feet (NGVD 29).

<u>Latitude</u>	<u>Longitude</u>	<u>Northing</u>	<u>Easting</u>	<u>Elev.</u>	<u>Desc.</u>
				46.66	RIM MW-1
37.6662790	-122.1106330	2069081.22	6095500.94	46.28	TOC MW-1
				47.46	RIM MW-1A
37.6664180	-122.1102666	2069129.99	6095607.84	47.00	TOC MW-1A
				47.73	RIM MW-3
37.6665283	-122.1103925	2069170.76	6095572.08	47.24	TOC MW-3
				47.82	RIM MW-4
37.6664253	-122.1104787	2069133.70	6095546.49	46.70	TOC MW-4
				46.82	RIM MW-5
37.6662873	-122.1104865	2069083.50	6095543.39	46.33	TOC MW-5
				47.53	RIM MW-6
37.6662973	-122.1102734	2069086.09	6095605.11	47.23	TOC MW-6
				46.33	RIM MW-9
37.6662635	-122.1108991	2069076.89	6095423.82	45.93	TOC MW-9
				48.16	RIM MW-12
37.6673576	-122.1107575	2069474.52	6095471.65	47.91	TOC MW-12
				45.75	RIM MW-13
37.6652234	-122.1107725	2068697.60	6095453.95	45.48	TOC MW-13
				48.26	RIM MW-14
37.6671851	-122.1106229	2069411.03	6095509.53	47.90	TOC MW-14

Virgil Chavez Land Surveying

721 Tuolumne Street

Vallejo, California 94590

(707) 553-2476 • Fax (707) 553-8698

August 16, 2011

Project No.: 2933-01

Page 2

<u>Latitude</u>	<u>Longitude</u>	<u>Northing</u>	<u>Easting</u>	<u>Elev.</u>	<u>Desc.</u>
37.6664760	-122.1103862	2069151.70	6095573.58	47.58	RIM EX-1
				47.15	TOC EX-1
				47.44	RIM VEAS-2
37.6664938	-122.1104474	2069158.50	6095555.99	47.19	TOC VEAS-2
				47.40	RIM VEAS-3
37.6664196	-122.1103072	2069130.79	6095596.11	47.27	TOC VEAS-3

Sincerely,



Virgil D. Chavez
Virgil D. Chavez, PLS 6323

APPENDIX B

**ANALYTICAL DATA SHEETS
AND
CHAIN-OF-CUSTODY RECORDS
FOR MONITORING WELL SAMPLING
(July 25, 2011)**



Analytical Report

Gallardo & Associates, INC. 304 Belle Court El Dorado Hills, CA 95762	Client Project ID: #001.11; Former E-Z Serve No. 100877	Date Sampled: 07/25/11
		Date Received: 07/27/11
	Client Contact: Rafael Gallardo	Date Reported: 08/02/11
	Client P.O.:	Date Completed: 08/02/11

WorkOrder: 1107758

August 03, 2011

Dear Rafael:

Enclosed within are:

- 1) The results of the **12** analyzed samples from your project: **#001.11; Former E-Z Serve No. 100877,**
- 2) A QC report for the above samples,
- 3) A copy of the chain of custody, and
- 4) An invoice for analytical services.

All analyses were completed satisfactorily and all QC samples were found to be within our control limits.

If you have any questions or concerns, please feel free to give me a call. Thank you for choosing McC Campbell Analytical Laboratories for your analytical needs.

Best regards,

Angela Rydelius
Laboratory Manager
McC Campbell Analytical, Inc.

The analytical results relate only to the items tested.

1107758

GALLARDO & ASSOCIATES, INC.

304 Belle Court in El Dorado Hills, CA 95762.

Environmental and Geological Services

We Solve The Problem

CHAIN OF CUSTODY RECORD

Date _____ Sheet 1 of 2

Project Name Former E-Z Serve No. 100877				Parameters										Lab Name _____				
Project Number 00L11														Address _____				
Address 525 West A Street in Hayward, CA														Phone Number _____				
Sampler's Name: Rafael Gallardo														Turnaround Time				
Sampler's Signature: _____														<input type="checkbox"/> Rush <input type="checkbox"/> 24 Hour <input type="checkbox"/> 48 Hour <input checked="" type="checkbox"/> 5-Day				
Repeat to: _____														Comments				
Sampler's Number	Location	Date	Time	TPH as Gasoline 8015	TPH as Diesel 8015	TPH-G and BTEX 8015/8020	BTX & E 8020	Oil and Grease 5520	Volatile Organics (8010)	CAM Metals (17)	Pr. Pollutant Metals (13)	Base/Neu/Acids (Organic)	Pesticides 8140/8141	82060 + Fuel Oxygenates	MTBE	Purgeable Halocarbons	TPH as Gasoline S015	Comments
MW-1		7-25-11				X								X				Please Bill: G&A.I.
MW-2						X								X				
MW-3						X								X				
MW-4						X								X				
MW-5						X								X				
MW-6						X								X				PDF and EDF Results to Gallardo & Associates, Inc.
MW-7						X								X				
MW-8 EX-1						X								X				ICE/IT 5.6 GOOD CONDITION <input checked="" type="checkbox"/> APPROPRIATE HEAD SPACE ABSENT <input checked="" type="checkbox"/> CONTAINERS DECHLORINATED IN LAB <input checked="" type="checkbox"/> PRESERVED IN LAB PRESERVATION <input checked="" type="checkbox"/> VOAS <input checked="" type="checkbox"/> O&G <input checked="" type="checkbox"/> METALS <input checked="" type="checkbox"/> OTHER
MW-9						X								X				
MW-10						X								X				
Relinquished By		Date	Time	Received By		Date	Time	Total Number of Containers this Sheet:										
<i>[Signature]</i>		7-26-11	2:30pm	Kyle/environ-tech		7-26-11	2:30pm	Method of Shipment:										
Kyle/environ-tech		7-26-11	6:00pm	Joe Juarez		7-26-11	4:55	Special Shipment/Handling or Storage Requirements:										
Joe Juarez		7-26-11	5:54	Received in Lab By		Date	Time											
Dispatched By		Date	Time	<i>[Signature]</i>		7-27-11	9:00am											

GALLARDO & ASSOCIATES, INC.

304 Belle Court in El Dorado Hills, CA 95762.

Environmental and Geological Services

We Solve The Problem

CHAIN OF CUSTODY RECORD

Date _____ Sheet 2 of 2

Project Name Former E-Z Serve No. 100877

Project Number 00L11

Address 525 West A Street in Hayward, CA

Sampler's Name: Rafael Gallardo

Sampler's Signature: _____

Parameters

Lab Name _____

Address _____

Phone Number _____

Turnaround Time

Rush 24 Hour 48 Hour 5-Day

Repeat to: _____

Comments

Sampler's Number	Location	Date	Time	TPH as Gasoline 8015	TPH as Diesel 8015	TPH-G and BTEX 8015/8020	BTX & E 8020	Oil and Grease 5520	Volatile Organics (8010)	CAM Metals (17)	Pr. Pollutant Metals (13)	Base/Neu/Acids (Organic)	Pesticides 8140/8141	82060 + Fuel Oxygenates	MTBE	Purgeable Halocarbons	TPH as Gasoline S015	
MW-11		7-25-11				X								X				
MW-12		↓				X								X				
MW-13						X								X				
MW-14							X							X				
VEAS-1							X								X			
VEAS-2							X								X			
VEAS-3						X								X				

Please Bill: G&A.I.

PDF and EDF Results to
Gallardo & Associates, Inc.

H x
+2 x
+x

+5x
60x

Relinquished By <i>[Signature]</i>	Date 7-26-11	Time 2:38pm	Received By Kyle/Enviro-tech	Date 7-26-11	Time 2:40pm
<i>[Signature]</i>	7-26-11	5:00pm	<i>[Signature]</i>	7-26-11	4:55
<i>[Signature]</i>	7-26-11	4:54	<i>[Signature]</i>	7-26-11	5:54
Dispatched By <i>[Signature]</i>	Date 7-27-11	Time 09:00	Received in Lab By <i>[Signature]</i>	Date 7-26-11	Time 6:30.

Total Number of Containers this Sheet:

Method of Shipment:

Special Shipment/Handling or Storage Requirements:

7-27-11 *[Signature]* 7/27/11 0900

McC Campbell Analytical, Inc.



1534 Willow Pass Rd
Pittsburg, CA 94565-1701
(925) 252-9262

CHAIN-OF-CUSTODY RECORD

WorkOrder: 1107758

ClientCode: GASR

WaterTrax WriteOn EDF Excel Fax Email HardCopy ThirdParty J-flag

Report to:

Rafael Gallardo
Gallardo & Associates, INC.
304 Belle Court
El Dorado Hills, CA 95762
916-358-3719 FAX: (916) 358-3719

Email: rafaelgallardo777@hotmail.com
cc:
PO:
ProjectNo: #001.11; Former E-Z Serve No. 100877

Bill to:

Rafael Gallardo
Gallardo & Associates, INC.
304 Belle Court
El Dorado Hills, CA 95762

Requested TAT: 5 days

Date Received: 07/27/2011

Date Printed: 07/27/2011

Lab ID	Client ID	Matrix	Collection Date	Hold	Requested Tests (See legend below)												
					1	2	3	4	5	6	7	8	9	10	11	12	
1107758-001	MW-1	Water	7/25/2011	<input type="checkbox"/>	B	A	A										
1107758-002	MW-3	Water	7/25/2011	<input type="checkbox"/>	B	A											
1107758-003	MW-4	Water	7/25/2011	<input type="checkbox"/>	B	A											
1107758-004	MW-5	Water	7/25/2011	<input type="checkbox"/>	B	A											
1107758-005	MW-6	Water	7/25/2011	<input type="checkbox"/>	B	A											
1107758-006	EX-1	Water	7/25/2011	<input type="checkbox"/>	B	A											
1107758-007	MW-9	Water	7/25/2011	<input type="checkbox"/>	B	A											
1107758-008	MW-12	Water	7/25/2011	<input type="checkbox"/>	B	A											
1107758-009	MW-13	Water	7/25/2011	<input type="checkbox"/>	B	A											
1107758-010	MW-14	Water	7/25/2011	<input type="checkbox"/>	B	A											
1107758-011	VEAS-2	Water	7/25/2011	<input type="checkbox"/>	B	A											
1107758-012	VEAS-3	Water	7/25/2011	<input type="checkbox"/>	B	A											

Test Legend:

1	8260B_W	2	G-MBTEX_W	3	PREFD REPORT	4		5	
6		7		8		9		10	
11		12							

Prepared by: Maria Venegas

Comments:

NOTE: Soil samples are discarded 60 days after results are reported unless other arrangements are made (Water samples are 30 days).
Hazardous samples will be returned to client or disposed of at client expense.



Sample Receipt Checklist

Client Name: **Gallardo & Associates, INC.**

Date and Time Received: **7/27/2011 12:38:52 PM**

Project Name: **#001.11; Former E-Z Serve No. 100877**

Checklist completed and reviewed by: **Maria Venegas**

WorkOrder N°: **1107758** Matrix: Water

Carrier: Courier

Chain of Custody (COC) Information

- Chain of custody present? Yes No
- Chain of custody signed when relinquished and received? Yes No
- Chain of custody agrees with sample labels? Yes No
- Sample IDs noted by Client on COC? Yes No
- Date and Time of collection noted by Client on COC? Yes No
- Sampler's name noted on COC? Yes No

Sample Receipt Information

- Custody seals intact on shipping container/cooler? Yes No NA
- Shipping container/cooler in good condition? Yes No
- Samples in proper containers/bottles? Yes No
- Sample containers intact? Yes No
- Sufficient sample volume for indicated test? Yes No

Sample Preservation and Hold Time (HT) Information

- All samples received within holding time? Yes No
- Container/Temp Blank temperature Cooler Temp: 5.6°C NA
- Water - VOA vials have zero headspace / no bubbles? Yes No No VOA vials submitted
- Sample labels checked for correct preservation? Yes No
- Metal - pH acceptable upon receipt (pH<2)? Yes No NA
- Samples Received on Ice? Yes No

(Ice Type: WET ICE)

* NOTE: If the "No" box is checked, see comments below.

Client contacted:

Date contacted:

Contacted by:

Comments:



Gallardo & Associates, INC.
304 Belle Court
El Dorado Hills, CA 95762

Client Project ID: #001.11; Former E-Z Serve No. 100877
Client Contact: Rafael Gallardo
Client P.O.:

Date Sampled: 07/25/11
Date Received: 07/27/11
Date Extracted: 07/29/11
Date Analyzed: 07/29/11

Volatile Organics by P&T and GC/MS (Basic Target List)*

Extraction Method: SW5030B

Analytical Method: SW8260B

Work Order: 1107758

Lab ID		1107758-001B					
Client ID		MW-1					
Matrix		Water					
Compound	Concentration *	DF	Reporting Limit	Compound	Concentration *	DF	Reporting Limit
Acetone	ND<200	20	10	tert-Amyl methyl ether (TAME)	ND<10	20	0.5
Benzene	ND<10	20	0.5	Bromobenzene	ND<10	20	0.5
Bromochloromethane	ND<10	20	0.5	Bromodichloromethane	ND<10	20	0.5
Bromoform	ND<10	20	0.5	Bromomethane	ND<10	20	0.5
2-Butanone (MEK)	ND<40	20	2.0	t-Butyl alcohol (TBA)	ND<40	20	2.0
n-Butyl benzene	24	20	0.5	sec-Butyl benzene	11	20	0.5
tert-Butyl benzene	ND<10	20	0.5	Carbon Disulfide	ND<10	20	0.5
Carbon Tetrachloride	ND<10	20	0.5	Chlorobenzene	ND<10	20	0.5
Chloroethane	ND<10	20	0.5	Chloroform	ND<10	20	0.5
Chloromethane	ND<10	20	0.5	2-Chlorotoluene	ND<10	20	0.5
4-Chlorotoluene	ND<10	20	0.5	Dibromochloromethane	ND<10	20	0.5
1,2-Dibromo-3-chloropropane	ND<4.0	20	0.2	1,2-Dibromoethane (EDB)	ND<10	20	0.5
Dibromomethane	ND<10	20	0.5	1,2-Dichlorobenzene	ND<10	20	0.5
1,3-Dichlorobenzene	ND<10	20	0.5	1,4-Dichlorobenzene	ND<10	20	0.5
Dichlorodifluoromethane	ND<10	20	0.5	1,1-Dichloroethane	ND<10	20	0.5
1,2-Dichloroethane (1,2-DCA)	ND<10	20	0.5	1,1-Dichloroethene	ND<10	20	0.5
cis-1,2-Dichloroethene	ND<10	20	0.5	trans-1,2-Dichloroethene	ND<10	20	0.5
1,2-Dichloropropane	ND<10	20	0.5	1,3-Dichloropropane	ND<10	20	0.5
2,2-Dichloropropane	ND<10	20	0.5	1,1-Dichloropropene	ND<10	20	0.5
cis-1,3-Dichloropropene	ND<10	20	0.5	trans-1,3-Dichloropropene	ND<10	20	0.5
Diisopropyl ether (DIPE)	ND<10	20	0.5	Ethylbenzene	28	20	0.5
Ethyl tert-butyl ether (ETBE)	ND<10	20	0.5	Freon 113	ND<200	20	10
Hexachlorobutadiene	ND<10	20	0.5	Hexachloroethane	ND<10	20	0.5
2-Hexanone	ND<10	20	0.5	Isopropylbenzene	43	20	0.5
4-Isopropyl toluene	ND<10	20	0.5	Methyl-t-butyl ether (MTBE)	230	20	0.5
Methylene chloride	ND<10	20	0.5	4-Methyl-2-pentanone (MIBK)	ND<10	20	0.5
Naphthalene	35	20	0.5	n-Propyl benzene	130	20	0.5
Styrene	ND<10	20	0.5	1,1,1,2-Tetrachloroethane	ND<10	20	0.5
1,1,2,2-Tetrachloroethane	ND<10	20	0.5	Tetrachloroethene	ND<10	20	0.5
Toluene	ND<10	20	0.5	1,2,3-Trichlorobenzene	ND<10	20	0.5
1,2,4-Trichlorobenzene	ND<10	20	0.5	1,1,1-Trichloroethane	ND<10	20	0.5
1,1,2-Trichloroethane	ND<10	20	0.5	Trichloroethene	ND<10	20	0.5
Trichlorofluoromethane	ND<10	20	0.5	1,2,3-Trichloropropane	ND<10	20	0.5
1,2,4-Trimethylbenzene	ND<10	20	0.5	1,3,5-Trimethylbenzene	ND<10	20	0.5
Vinyl Chloride	ND<10	20	0.5	Xylenes, Total	ND<10	20	0.5

Surrogate Recoveries (%)

%SS1:	103	%SS2:	99
%SS3:	86		

Comments:

* water and vapor samples are reported in µg/L, soil/sludge/solid samples in mg/kg, product/oil/non-aqueous liquid samples and all TCLP & SPLP extracts are reported in mg/L, wipe samples in µg/wipe.

ND means not detected above the reporting limit/method detection limit; N/A means analyte not applicable to this analysis; %SS = Percent Recovery of Surrogate Standard; DF = Dilution Factor

surrogate diluted out of range or coelutes with another peak; &) low surrogate due to matrix interference.

b1) aqueous sample that contains greater than ~1 vol. % sediment



Gallardo & Associates, INC.
304 Belle Court
El Dorado Hills, CA 95762

Client Project ID: #001.11; Former E-Z Serve No. 100877
Client Contact: Rafael Gallardo
Client P.O.:

Date Sampled: 07/25/11
Date Received: 07/27/11
Date Extracted: 07/29/11
Date Analyzed: 07/29/11

Volatile Organics by P&T and GC/MS (Basic Target List)*

Extraction Method: SW5030B

Analytical Method: SW8260B

Work Order: 1107758

Lab ID	1107758-002B
Client ID	MW-3
Matrix	Water

Compound	Concentration *	DF	Reporting Limit	Compound	Concentration *	DF	Reporting Limit
Acetone	ND<100	10	10	tert-Amyl methyl ether (TAME)	ND<5.0	10	0.5
Benzene	ND<5.0	10	0.5	Bromobenzene	ND<5.0	10	0.5
Bromochloromethane	ND<5.0	10	0.5	Bromodichloromethane	ND<5.0	10	0.5
Bromoform	ND<5.0	10	0.5	Bromomethane	ND<5.0	10	0.5
2-Butanone (MEK)	ND<20	10	2.0	t-Butyl alcohol (TBA)	ND<20	10	2.0
n-Butyl benzene	ND<5.0	10	0.5	sec-Butyl benzene	ND<5.0	10	0.5
tert-Butyl benzene	ND<5.0	10	0.5	Carbon Disulfide	ND<5.0	10	0.5
Carbon Tetrachloride	ND<5.0	10	0.5	Chlorobenzene	ND<5.0	10	0.5
Chloroethane	ND<5.0	10	0.5	Chloroform	ND<5.0	10	0.5
Chloromethane	ND<5.0	10	0.5	2-Chlorotoluene	ND<5.0	10	0.5
4-Chlorotoluene	ND<5.0	10	0.5	Dibromochloromethane	ND<5.0	10	0.5
1,2-Dibromo-3-chloropropane	ND<2.0	10	0.2	1,2-Dibromoethane (EDB)	ND<5.0	10	0.5
Dibromomethane	ND<5.0	10	0.5	1,2-Dichlorobenzene	ND<5.0	10	0.5
1,3-Dichlorobenzene	ND<5.0	10	0.5	1,4-Dichlorobenzene	ND<5.0	10	0.5
Dichlorodifluoromethane	ND<5.0	10	0.5	1,1-Dichloroethane	ND<5.0	10	0.5
1,2-Dichloroethane (1,2-DCA)	ND<5.0	10	0.5	1,1-Dichloroethene	ND<5.0	10	0.5
cis-1,2-Dichloroethene	ND<5.0	10	0.5	trans-1,2-Dichloroethene	ND<5.0	10	0.5
1,2-Dichloropropane	ND<5.0	10	0.5	1,3-Dichloropropane	ND<5.0	10	0.5
2,2-Dichloropropane	ND<5.0	10	0.5	1,1-Dichloropropene	ND<5.0	10	0.5
cis-1,3-Dichloropropene	ND<5.0	10	0.5	trans-1,3-Dichloropropene	ND<5.0	10	0.5
Diisopropyl ether (DIPE)	ND<5.0	10	0.5	Ethylbenzene	ND<5.0	10	0.5
Ethyl tert-butyl ether (ETBE)	ND<5.0	10	0.5	Freon 113	ND<100	10	10
Hexachlorobutadiene	ND<5.0	10	0.5	Hexachloroethane	ND<5.0	10	0.5
2-Hexanone	ND<5.0	10	0.5	Isopropylbenzene	ND<5.0	10	0.5
4-Isopropyl toluene	ND<5.0	10	0.5	Methyl-t-butyl ether (MTBE)	240	10	0.5
Methylene chloride	ND<5.0	10	0.5	4-Methyl-2-pentanone (MIBK)	ND<5.0	10	0.5
Naphthalene	ND<5.0	10	0.5	n-Propyl benzene	7.6	10	0.5
Styrene	ND<5.0	10	0.5	1,1,1,2-Tetrachloroethane	ND<5.0	10	0.5
1,1,2,2-Tetrachloroethane	ND<5.0	10	0.5	Tetrachloroethene	ND<5.0	10	0.5
Toluene	ND<5.0	10	0.5	1,2,3-Trichlorobenzene	ND<5.0	10	0.5
1,2,4-Trichlorobenzene	ND<5.0	10	0.5	1,1,1-Trichloroethane	ND<5.0	10	0.5
1,1,2-Trichloroethane	ND<5.0	10	0.5	Trichloroethene	ND<5.0	10	0.5
Trichlorofluoromethane	ND<5.0	10	0.5	1,2,3-Trichloropropane	ND<5.0	10	0.5
1,2,4-Trimethylbenzene	ND<5.0	10	0.5	1,3,5-Trimethylbenzene	ND<5.0	10	0.5
Vinyl Chloride	ND<5.0	10	0.5	Xylenes, Total	ND<5.0	10	0.5

Surrogate Recoveries (%)

%SS1:	93	%SS2:	99
%SS3:	97		

Comments:

* water and vapor samples are reported in µg/L, soil/sludge/solid samples in mg/kg, product/oil/non-aqueous liquid samples and all TCLP & SPLP extracts are reported in mg/L, wipe samples in µg/wipe.

ND means not detected above the reporting limit/method detection limit; N/A means analyte not applicable to this analysis; %SS = Percent Recovery of Surrogate Standard; DF = Dilution Factor

surrogate diluted out of range or coelutes with another peak; &) low surrogate due to matrix interference.

b1) aqueous sample that contains greater than ~1 vol. % sediment



Gallardo & Associates, INC.
304 Belle Court
El Dorado Hills, CA 95762

Client Project ID: #001.11; Former E-Z Serve No. 100877
Client Contact: Rafael Gallardo
Client P.O.:

Date Sampled: 07/25/11
Date Received: 07/27/11
Date Extracted: 07/29/11
Date Analyzed: 07/29/11

Volatile Organics by P&T and GC/MS (Basic Target List)*

Extraction Method: SW5030B

Analytical Method: SW8260B

Work Order: 1107758

Lab ID		1107758-003B					
Client ID		MW-4					
Matrix		Water					
Compound	Concentration *	DF	Reporting Limit	Compound	Concentration *	DF	Reporting Limit
Acetone	ND<200	20	10	tert-Amyl methyl ether (TAME)	ND<10	20	0.5
Benzene	32	20	0.5	Bromobenzene	ND<10	20	0.5
Bromochloromethane	ND<10	20	0.5	Bromodichloromethane	ND<10	20	0.5
Bromoform	ND<10	20	0.5	Bromomethane	ND<10	20	0.5
2-Butanone (MEK)	ND<40	20	2.0	t-Butyl alcohol (TBA)	56	20	2.0
n-Butyl benzene	ND<10	20	0.5	sec-Butyl benzene	ND<10	20	0.5
tert-Butyl benzene	ND<10	20	0.5	Carbon Disulfide	ND<10	20	0.5
Carbon Tetrachloride	ND<10	20	0.5	Chlorobenzene	ND<10	20	0.5
Chloroethane	ND<10	20	0.5	Chloroform	ND<10	20	0.5
Chloromethane	ND<10	20	0.5	2-Chlorotoluene	ND<10	20	0.5
4-Chlorotoluene	ND<10	20	0.5	Dibromochloromethane	ND<10	20	0.5
1,2-Dibromo-3-chloropropane	ND<4.0	20	0.2	1,2-Dibromoethane (EDB)	ND<10	20	0.5
Dibromomethane	ND<10	20	0.5	1,2-Dichlorobenzene	ND<10	20	0.5
1,3-Dichlorobenzene	ND<10	20	0.5	1,4-Dichlorobenzene	ND<10	20	0.5
Dichlorodifluoromethane	ND<10	20	0.5	1,1-Dichloroethane	ND<10	20	0.5
1,2-Dichloroethane (1,2-DCA)	ND<10	20	0.5	1,1-Dichloroethene	ND<10	20	0.5
cis-1,2-Dichloroethene	ND<10	20	0.5	trans-1,2-Dichloroethene	ND<10	20	0.5
1,2-Dichloropropane	ND<10	20	0.5	1,3-Dichloropropane	ND<10	20	0.5
2,2-Dichloropropane	ND<10	20	0.5	1,1-Dichloropropene	ND<10	20	0.5
cis-1,3-Dichloropropene	ND<10	20	0.5	trans-1,3-Dichloropropene	ND<10	20	0.5
Diisopropyl ether (DIPE)	ND<10	20	0.5	Ethylbenzene	170	20	0.5
Ethyl tert-butyl ether (ETBE)	ND<10	20	0.5	Freon 113	ND<200	20	10
Hexachlorobutadiene	ND<10	20	0.5	Hexachloroethane	ND<10	20	0.5
2-Hexanone	ND<10	20	0.5	Isopropylbenzene	13	20	0.5
4-Isopropyl toluene	ND<10	20	0.5	Methyl-t-butyl ether (MTBE)	320	20	0.5
Methylene chloride	ND<10	20	0.5	4-Methyl-2-pentanone (MIBK)	ND<10	20	0.5
Naphthalene	51	20	0.5	n-Propyl benzene	36	20	0.5
Styrene	ND<10	20	0.5	1,1,1,2-Tetrachloroethane	ND<10	20	0.5
1,1,2,2-Tetrachloroethane	ND<10	20	0.5	Tetrachloroethene	ND<10	20	0.5
Toluene	ND<10	20	0.5	1,2,3-Trichlorobenzene	ND<10	20	0.5
1,2,4-Trichlorobenzene	ND<10	20	0.5	1,1,1-Trichloroethane	ND<10	20	0.5
1,1,2-Trichloroethane	ND<10	20	0.5	Trichloroethene	ND<10	20	0.5
Trichlorofluoromethane	ND<10	20	0.5	1,2,3-Trichloropropane	ND<10	20	0.5
1,2,4-Trimethylbenzene	40	20	0.5	1,3,5-Trimethylbenzene	ND<10	20	0.5
Vinyl Chloride	ND<10	20	0.5	Xylenes, Total	150	20	0.5

Surrogate Recoveries (%)

%SS1:	102	%SS2:	99
%SS3:	85		

Comments:

* water and vapor samples are reported in µg/L, soil/sludge/solid samples in mg/kg, product/oil/non-aqueous liquid samples and all TCLP & SPLP extracts are reported in mg/L, wipe samples in µg/wipe.

ND means not detected above the reporting limit/method detection limit; N/A means analyte not applicable to this analysis; %SS = Percent Recovery of Surrogate Standard; DF = Dilution Factor

surrogate diluted out of range or coelutes with another peak; &) low surrogate due to matrix interference.

b1) aqueous sample that contains greater than ~1 vol. % sediment



Gallardo & Associates, INC.
304 Belle Court
El Dorado Hills, CA 95762

Client Project ID: #001.11; Former E-Z Serve No. 100877
Client Contact: Rafael Gallardo
Client P.O.:

Date Sampled: 07/25/11
Date Received: 07/27/11
Date Extracted: 07/29/11
Date Analyzed: 07/29/11

Volatile Organics by P&T and GC/MS (Basic Target List)*

Extraction Method: SW5030B

Analytical Method: SW8260B

Work Order: 1107758

Lab ID	1107758-004B
Client ID	MW-5
Matrix	Water

Compound	Concentration *	DF	Reporting Limit	Compound	Concentration *	DF	Reporting Limit
Acetone	ND<100	10	10	tert-Amyl methyl ether (TAME)	ND<5.0	10	0.5
Benzene	ND<5.0	10	0.5	Bromobenzene	ND<5.0	10	0.5
Bromochloromethane	ND<5.0	10	0.5	Bromodichloromethane	ND<5.0	10	0.5
Bromoform	ND<5.0	10	0.5	Bromomethane	ND<5.0	10	0.5
2-Butanone (MEK)	ND<20	10	2.0	t-Butyl alcohol (TBA)	ND<20	10	2.0
n-Butyl benzene	21	10	0.5	sec-Butyl benzene	16	10	0.5
tert-Butyl benzene	ND<5.0	10	0.5	Carbon Disulfide	ND<5.0	10	0.5
Carbon Tetrachloride	ND<5.0	10	0.5	Chlorobenzene	ND<5.0	10	0.5
Chloroethane	ND<5.0	10	0.5	Chloroform	ND<5.0	10	0.5
Chloromethane	ND<5.0	10	0.5	2-Chlorotoluene	ND<5.0	10	0.5
4-Chlorotoluene	ND<5.0	10	0.5	Dibromochloromethane	ND<5.0	10	0.5
1,2-Dibromo-3-chloropropane	ND<2.0	10	0.2	1,2-Dibromoethane (EDB)	ND<5.0	10	0.5
Dibromomethane	ND<5.0	10	0.5	1,2-Dichlorobenzene	ND<5.0	10	0.5
1,3-Dichlorobenzene	ND<5.0	10	0.5	1,4-Dichlorobenzene	ND<5.0	10	0.5
Dichlorodifluoromethane	ND<5.0	10	0.5	1,1-Dichloroethane	ND<5.0	10	0.5
1,2-Dichloroethane (1,2-DCA)	ND<5.0	10	0.5	1,1-Dichloroethene	ND<5.0	10	0.5
cis-1,2-Dichloroethene	ND<5.0	10	0.5	trans-1,2-Dichloroethene	ND<5.0	10	0.5
1,2-Dichloropropane	ND<5.0	10	0.5	1,3-Dichloropropane	ND<5.0	10	0.5
2,2-Dichloropropane	ND<5.0	10	0.5	1,1-Dichloropropene	ND<5.0	10	0.5
cis-1,3-Dichloropropene	ND<5.0	10	0.5	trans-1,3-Dichloropropene	ND<5.0	10	0.5
Diisopropyl ether (DIPE)	ND<5.0	10	0.5	Ethylbenzene	ND<5.0	10	0.5
Ethyl tert-butyl ether (ETBE)	ND<5.0	10	0.5	Freon 113	ND<100	10	10
Hexachlorobutadiene	ND<5.0	10	0.5	Hexachloroethane	ND<5.0	10	0.5
2-Hexanone	ND<5.0	10	0.5	Isopropylbenzene	53	10	0.5
4-Isopropyl toluene	ND<5.0	10	0.5	Methyl-t-butyl ether (MTBE)	95	10	0.5
Methylene chloride	ND<5.0	10	0.5	4-Methyl-2-pentanone (MIBK)	ND<5.0	10	0.5
Naphthalene	ND<5.0	10	0.5	n-Propyl benzene	130	10	0.5
Styrene	ND<5.0	10	0.5	1,1,1,2-Tetrachloroethane	ND<5.0	10	0.5
1,1,2,2-Tetrachloroethane	ND<5.0	10	0.5	Tetrachloroethene	ND<5.0	10	0.5
Toluene	ND<5.0	10	0.5	1,2,3-Trichlorobenzene	ND<5.0	10	0.5
1,2,4-Trichlorobenzene	ND<5.0	10	0.5	1,1,1-Trichloroethane	ND<5.0	10	0.5
1,1,2-Trichloroethane	ND<5.0	10	0.5	Trichloroethene	ND<5.0	10	0.5
Trichlorofluoromethane	ND<5.0	10	0.5	1,2,3-Trichloropropane	ND<5.0	10	0.5
1,2,4-Trimethylbenzene	ND<5.0	10	0.5	1,3,5-Trimethylbenzene	ND<5.0	10	0.5
Vinyl Chloride	ND<5.0	10	0.5	Xylenes, Total	ND<5.0	10	0.5

Surrogate Recoveries (%)

%SS1:	94	%SS2:	97
%SS3:	90		

Comments:

* water and vapor samples are reported in µg/L, soil/sludge/solid samples in mg/kg, product/oil/non-aqueous liquid samples and all TCLP & SPLP extracts are reported in mg/L, wipe samples in µg/wipe.

ND means not detected above the reporting limit/method detection limit; N/A means analyte not applicable to this analysis; %SS = Percent Recovery of Surrogate Standard; DF = Dilution Factor

surrogate diluted out of range or coelutes with another peak; &) low surrogate due to matrix interference.

b1) aqueous sample that contains greater than ~1 vol. % sediment



Gallardo & Associates, INC.
304 Belle Court
El Dorado Hills, CA 95762

Client Project ID: #001.11; Former E-Z Serve No. 100877
Client Contact: Rafael Gallardo
Client P.O.:

Date Sampled: 07/25/11
Date Received: 07/27/11
Date Extracted: 07/29/11
Date Analyzed: 07/29/11

Volatile Organics by P&T and GC/MS (Basic Target List)*

Extraction Method: SW5030B

Analytical Method: SW8260B

Work Order: 1107758

Lab ID	1107758-005B
Client ID	MW-6
Matrix	Water

Compound	Concentration *	DF	Reporting Limit	Compound	Concentration *	DF	Reporting Limit
Acetone	ND<100	10	10	tert-Amyl methyl ether (TAME)	ND<5.0	10	0.5
Benzene	ND<5.0	10	0.5	Bromobenzene	ND<5.0	10	0.5
Bromochloromethane	ND<5.0	10	0.5	Bromodichloromethane	ND<5.0	10	0.5
Bromoform	ND<5.0	10	0.5	Bromomethane	ND<5.0	10	0.5
2-Butanone (MEK)	ND<20	10	2.0	t-Butyl alcohol (TBA)	ND<20	10	2.0
n-Butyl benzene	ND<5.0	10	0.5	sec-Butyl benzene	8.5	10	0.5
tert-Butyl benzene	ND<5.0	10	0.5	Carbon Disulfide	ND<5.0	10	0.5
Carbon Tetrachloride	ND<5.0	10	0.5	Chlorobenzene	ND<5.0	10	0.5
Chloroethane	ND<5.0	10	0.5	Chloroform	ND<5.0	10	0.5
Chloromethane	ND<5.0	10	0.5	2-Chlorotoluene	ND<5.0	10	0.5
4-Chlorotoluene	ND<5.0	10	0.5	Dibromochloromethane	ND<5.0	10	0.5
1,2-Dibromo-3-chloropropane	ND<2.0	10	0.2	1,2-Dibromoethane (EDB)	ND<5.0	10	0.5
Dibromomethane	ND<5.0	10	0.5	1,2-Dichlorobenzene	ND<5.0	10	0.5
1,3-Dichlorobenzene	ND<5.0	10	0.5	1,4-Dichlorobenzene	ND<5.0	10	0.5
Dichlorodifluoromethane	ND<5.0	10	0.5	1,1-Dichloroethane	ND<5.0	10	0.5
1,2-Dichloroethane (1,2-DCA)	ND<5.0	10	0.5	1,1-Dichloroethene	ND<5.0	10	0.5
cis-1,2-Dichloroethene	ND<5.0	10	0.5	trans-1,2-Dichloroethene	ND<5.0	10	0.5
1,2-Dichloropropane	ND<5.0	10	0.5	1,3-Dichloropropane	ND<5.0	10	0.5
2,2-Dichloropropane	ND<5.0	10	0.5	1,1-Dichloropropene	ND<5.0	10	0.5
cis-1,3-Dichloropropene	ND<5.0	10	0.5	trans-1,3-Dichloropropene	ND<5.0	10	0.5
Diisopropyl ether (DIPE)	ND<5.0	10	0.5	Ethylbenzene	8.0	10	0.5
Ethyl tert-butyl ether (ETBE)	ND<5.0	10	0.5	Freon 113	ND<100	10	10
Hexachlorobutadiene	ND<5.0	10	0.5	Hexachloroethane	ND<5.0	10	0.5
2-Hexanone	ND<5.0	10	0.5	Isopropylbenzene	28	10	0.5
4-Isopropyl toluene	ND<5.0	10	0.5	Methyl-t-butyl ether (MTBE)	150	10	0.5
Methylene chloride	ND<5.0	10	0.5	4-Methyl-2-pentanone (MIBK)	ND<5.0	10	0.5
Naphthalene	ND<5.0	10	0.5	n-Propyl benzene	48	10	0.5
Styrene	ND<5.0	10	0.5	1,1,1,2-Tetrachloroethane	ND<5.0	10	0.5
1,1,2,2-Tetrachloroethane	ND<5.0	10	0.5	Tetrachloroethene	ND<5.0	10	0.5
Toluene	ND<5.0	10	0.5	1,2,3-Trichlorobenzene	ND<5.0	10	0.5
1,2,4-Trichlorobenzene	ND<5.0	10	0.5	1,1,1-Trichloroethane	ND<5.0	10	0.5
1,1,2-Trichloroethane	ND<5.0	10	0.5	Trichloroethene	ND<5.0	10	0.5
Trichlorofluoromethane	ND<5.0	10	0.5	1,2,3-Trichloropropane	ND<5.0	10	0.5
1,2,4-Trimethylbenzene	ND<5.0	10	0.5	1,3,5-Trimethylbenzene	ND<5.0	10	0.5
Vinyl Chloride	ND<5.0	10	0.5	Xylenes, Total	ND<5.0	10	0.5

Surrogate Recoveries (%)

%SS1:	101	%SS2:	98
%SS3:	84		

Comments:

* water and vapor samples are reported in µg/L, soil/sludge/solid samples in mg/kg, product/oil/non-aqueous liquid samples and all TCLP & SPLP extracts are reported in mg/L, wipe samples in µg/wipe.

ND means not detected above the reporting limit/method detection limit; N/A means analyte not applicable to this analysis; %SS = Percent Recovery of Surrogate Standard; DF = Dilution Factor

surrogate diluted out of range or coelutes with another peak; &) low surrogate due to matrix interference.

b1) aqueous sample that contains greater than ~1 vol. % sediment



Gallardo & Associates, INC.
304 Belle Court
El Dorado Hills, CA 95762

Client Project ID: #001.11; Former E-Z Serve No. 100877
Client Contact: Rafael Gallardo
Client P.O.:

Date Sampled: 07/25/11
Date Received: 07/27/11
Date Extracted: 07/29/11
Date Analyzed: 07/29/11

Volatile Organics by P&T and GC/MS (Basic Target List)*

Extraction Method: SW5030B

Analytical Method: SW8260B

Work Order: 1107758

Lab ID		1107758-006B					
Client ID		EX-1					
Matrix		Water					
Compound	Concentration *	DF	Reporting Limit	Compound	Concentration *	DF	Reporting Limit
Acetone	ND<200	20	10	tert-Amyl methyl ether (TAME)	ND<10	20	0.5
Benzene	ND<10	20	0.5	Bromobenzene	ND<10	20	0.5
Bromochloromethane	ND<10	20	0.5	Bromodichloromethane	ND<10	20	0.5
Bromoform	ND<10	20	0.5	Bromomethane	ND<10	20	0.5
2-Butanone (MEK)	ND<40	20	2.0	t-Butyl alcohol (TBA)	ND<40	20	2.0
n-Butyl benzene	ND<10	20	0.5	sec-Butyl benzene	ND<10	20	0.5
tert-Butyl benzene	ND<10	20	0.5	Carbon Disulfide	ND<10	20	0.5
Carbon Tetrachloride	ND<10	20	0.5	Chlorobenzene	ND<10	20	0.5
Chloroethane	ND<10	20	0.5	Chloroform	ND<10	20	0.5
Chloromethane	ND<10	20	0.5	2-Chlorotoluene	ND<10	20	0.5
4-Chlorotoluene	ND<10	20	0.5	Dibromochloromethane	ND<10	20	0.5
1,2-Dibromo-3-chloropropane	ND<4.0	20	0.2	1,2-Dibromoethane (EDB)	ND<10	20	0.5
Dibromomethane	ND<10	20	0.5	1,2-Dichlorobenzene	ND<10	20	0.5
1,3-Dichlorobenzene	ND<10	20	0.5	1,4-Dichlorobenzene	ND<10	20	0.5
Dichlorodifluoromethane	ND<10	20	0.5	1,1-Dichloroethane	ND<10	20	0.5
1,2-Dichloroethane (1,2-DCA)	ND<10	20	0.5	1,1-Dichloroethene	ND<10	20	0.5
cis-1,2-Dichloroethene	ND<10	20	0.5	trans-1,2-Dichloroethene	ND<10	20	0.5
1,2-Dichloropropane	ND<10	20	0.5	1,3-Dichloropropane	ND<10	20	0.5
2,2-Dichloropropane	ND<10	20	0.5	1,1-Dichloropropene	ND<10	20	0.5
cis-1,3-Dichloropropene	ND<10	20	0.5	trans-1,3-Dichloropropene	ND<10	20	0.5
Diisopropyl ether (DIPE)	ND<10	20	0.5	Ethylbenzene	ND<10	20	0.5
Ethyl tert-butyl ether (ETBE)	ND<10	20	0.5	Freon 113	ND<200	20	10
Hexachlorobutadiene	ND<10	20	0.5	Hexachloroethane	ND<10	20	0.5
2-Hexanone	ND<10	20	0.5	Isopropylbenzene	ND<10	20	0.5
4-Isopropyl toluene	ND<10	20	0.5	Methyl-t-butyl ether (MTBE)	320	20	0.5
Methylene chloride	ND<10	20	0.5	4-Methyl-2-pentanone (MIBK)	ND<10	20	0.5
Naphthalene	ND<10	20	0.5	n-Propyl benzene	ND<10	20	0.5
Styrene	ND<10	20	0.5	1,1,1,2-Tetrachloroethane	ND<10	20	0.5
1,1,2,2-Tetrachloroethane	ND<10	20	0.5	Tetrachloroethene	ND<10	20	0.5
Toluene	ND<10	20	0.5	1,2,3-Trichlorobenzene	ND<10	20	0.5
1,2,4-Trichlorobenzene	ND<10	20	0.5	1,1,1-Trichloroethane	ND<10	20	0.5
1,1,2-Trichloroethane	ND<10	20	0.5	Trichloroethene	ND<10	20	0.5
Trichlorofluoromethane	ND<10	20	0.5	1,2,3-Trichloropropane	ND<10	20	0.5
1,2,4-Trimethylbenzene	ND<10	20	0.5	1,3,5-Trimethylbenzene	ND<10	20	0.5
Vinyl Chloride	ND<10	20	0.5	Xylenes, Total	ND<10	20	0.5

Surrogate Recoveries (%)

%SS1:	103	%SS2:	97
%SS3:	81		

Comments:

* water and vapor samples are reported in µg/L, soil/sludge/solid samples in mg/kg, product/oil/non-aqueous liquid samples and all TCLP & SPLP extracts are reported in mg/L, wipe samples in µg/wipe.

ND means not detected above the reporting limit/method detection limit; N/A means analyte not applicable to this analysis; %SS = Percent Recovery of Surrogate Standard; DF = Dilution Factor

surrogate diluted out of range or coelutes with another peak; &) low surrogate due to matrix interference.

b1) aqueous sample that contains greater than ~1 vol. % sediment



Gallardo & Associates, INC.
304 Belle Court
El Dorado Hills, CA 95762

Client Project ID: #001.11; Former E-Z Serve No. 100877
Client Contact: Rafael Gallardo
Client P.O.:

Date Sampled: 07/25/11
Date Received: 07/27/11
Date Extracted: 07/29/11
Date Analyzed: 07/29/11

Volatile Organics by P&T and GC/MS (Basic Target List)*

Extraction Method: SW5030B

Analytical Method: SW8260B

Work Order: 1107758

Lab ID	1107758-007B
Client ID	MW-9
Matrix	Water

Compound	Concentration *	DF	Reporting Limit	Compound	Concentration *	DF	Reporting Limit
Acetone	ND<50	5.0	10	tert-Amyl methyl ether (TAME)	ND<2.5	5.0	0.5
Benzene	94	5.0	0.5	Bromobenzene	ND<2.5	5.0	0.5
Bromochloromethane	ND<2.5	5.0	0.5	Bromodichloromethane	ND<2.5	5.0	0.5
Bromoform	ND<2.5	5.0	0.5	Bromomethane	ND<2.5	5.0	0.5
2-Butanone (MEK)	ND<10	5.0	2.0	t-Butyl alcohol (TBA)	12	5.0	2.0
n-Butyl benzene	13	5.0	0.5	sec-Butyl benzene	8.0	5.0	0.5
tert-Butyl benzene	4.4	5.0	0.5	Carbon Disulfide	ND<2.5	5.0	0.5
Carbon Tetrachloride	ND<2.5	5.0	0.5	Chlorobenzene	ND<2.5	5.0	0.5
Chloroethane	ND<2.5	5.0	0.5	Chloroform	ND<2.5	5.0	0.5
Chloromethane	ND<2.5	5.0	0.5	2-Chlorotoluene	ND<2.5	5.0	0.5
4-Chlorotoluene	ND<2.5	5.0	0.5	Dibromochloromethane	ND<2.5	5.0	0.5
1,2-Dibromo-3-chloropropane	ND<1.0	5.0	0.2	1,2-Dibromoethane (EDB)	ND<2.5	5.0	0.5
Dibromomethane	ND<2.5	5.0	0.5	1,2-Dichlorobenzene	ND<2.5	5.0	0.5
1,3-Dichlorobenzene	ND<2.5	5.0	0.5	1,4-Dichlorobenzene	ND<2.5	5.0	0.5
Dichlorodifluoromethane	ND<2.5	5.0	0.5	1,1-Dichloroethane	ND<2.5	5.0	0.5
1,2-Dichloroethane (1,2-DCA)	ND<2.5	5.0	0.5	1,1-Dichloroethene	ND<2.5	5.0	0.5
cis-1,2-Dichloroethene	ND<2.5	5.0	0.5	trans-1,2-Dichloroethene	ND<2.5	5.0	0.5
1,2-Dichloropropane	ND<2.5	5.0	0.5	1,3-Dichloropropane	ND<2.5	5.0	0.5
2,2-Dichloropropane	ND<2.5	5.0	0.5	1,1-Dichloropropene	ND<2.5	5.0	0.5
cis-1,3-Dichloropropene	ND<2.5	5.0	0.5	trans-1,3-Dichloropropene	ND<2.5	5.0	0.5
Diisopropyl ether (DIPE)	ND<2.5	5.0	0.5	Ethylbenzene	20	5.0	0.5
Ethyl tert-butyl ether (ETBE)	ND<2.5	5.0	0.5	Freon 113	ND<50	5.0	10
Hexachlorobutadiene	ND<2.5	5.0	0.5	Hexachloroethane	ND<2.5	5.0	0.5
2-Hexanone	ND<2.5	5.0	0.5	Isopropylbenzene	48	5.0	0.5
4-Isopropyl toluene	ND<2.5	5.0	0.5	Methyl-t-butyl ether (MTBE)	110	5.0	0.5
Methylene chloride	ND<2.5	5.0	0.5	4-Methyl-2-pentanone (MIBK)	ND<2.5	5.0	0.5
Naphthalene	6.0	5.0	0.5	n-Propyl benzene	97	5.0	0.5
Styrene	ND<2.5	5.0	0.5	1,1,1,2-Tetrachloroethane	ND<2.5	5.0	0.5
1,1,2,2-Tetrachloroethane	ND<2.5	5.0	0.5	Tetrachloroethene	ND<2.5	5.0	0.5
Toluene	ND<2.5	5.0	0.5	1,2,3-Trichlorobenzene	ND<2.5	5.0	0.5
1,2,4-Trichlorobenzene	ND<2.5	5.0	0.5	1,1,1-Trichloroethane	ND<2.5	5.0	0.5
1,1,2-Trichloroethane	ND<2.5	5.0	0.5	Trichloroethene	ND<2.5	5.0	0.5
Trichlorofluoromethane	ND<2.5	5.0	0.5	1,2,3-Trichloropropane	ND<2.5	5.0	0.5
1,2,4-Trimethylbenzene	ND<2.5	5.0	0.5	1,3,5-Trimethylbenzene	ND<2.5	5.0	0.5
Vinyl Chloride	ND<2.5	5.0	0.5	Xylenes, Total	4.5	5.0	0.5

Surrogate Recoveries (%)

%SS1:	97	%SS2:	98
%SS3:	97		

Comments:

* water and vapor samples are reported in µg/L, soil/sludge/solid samples in mg/kg, product/oil/non-aqueous liquid samples and all TCLP & SPLP extracts are reported in mg/L, wipe samples in µg/wipe.

ND means not detected above the reporting limit/method detection limit; N/A means analyte not applicable to this analysis; %SS = Percent Recovery of Surrogate Standard; DF = Dilution Factor

surrogate diluted out of range or coelutes with another peak; &) low surrogate due to matrix interference.

b1) aqueous sample that contains greater than ~1 vol. % sediment



Gallardo & Associates, INC.
304 Belle Court
El Dorado Hills, CA 95762

Client Project ID: #001.11; Former E-Z Serve No. 100877
Client Contact: Rafael Gallardo
Client P.O.:

Date Sampled: 07/25/11
Date Received: 07/27/11
Date Extracted: 07/29/11
Date Analyzed: 07/29/11

Volatile Organics by P&T and GC/MS (Basic Target List)*

Extraction Method: SW5030B

Analytical Method: SW8260B

Work Order: 1107758

Lab ID		1107758-008B					
Client ID		MW-12					
Matrix		Water					
Compound	Concentration *	DF	Reporting Limit	Compound	Concentration *	DF	Reporting Limit
Acetone	16	1.0	10	tert-Amyl methyl ether (TAME)	ND	1.0	0.5
Benzene	ND	1.0	0.5	Bromobenzene	ND	1.0	0.5
Bromochloromethane	ND	1.0	0.5	Bromodichloromethane	ND	1.0	0.5
Bromoform	ND	1.0	0.5	Bromomethane	ND	1.0	0.5
2-Butanone (MEK)	ND	1.0	2.0	t-Butyl alcohol (TBA)	ND	1.0	2.0
n-Butyl benzene	ND	1.0	0.5	sec-Butyl benzene	ND	1.0	0.5
tert-Butyl benzene	ND	1.0	0.5	Carbon Disulfide	ND	1.0	0.5
Carbon Tetrachloride	ND	1.0	0.5	Chlorobenzene	ND	1.0	0.5
Chloroethane	ND	1.0	0.5	Chloroform	ND	1.0	0.5
Chloromethane	ND	1.0	0.5	2-Chlorotoluene	ND	1.0	0.5
4-Chlorotoluene	ND	1.0	0.5	Dibromochloromethane	ND	1.0	0.5
1,2-Dibromo-3-chloropropane	ND	1.0	0.2	1,2-Dibromoethane (EDB)	ND	1.0	0.5
Dibromomethane	ND	1.0	0.5	1,2-Dichlorobenzene	ND	1.0	0.5
1,3-Dichlorobenzene	ND	1.0	0.5	1,4-Dichlorobenzene	ND	1.0	0.5
Dichlorodifluoromethane	ND	1.0	0.5	1,1-Dichloroethane	ND	1.0	0.5
1,2-Dichloroethane (1,2-DCA)	ND	1.0	0.5	1,1-Dichloroethene	ND	1.0	0.5
cis-1,2-Dichloroethene	ND	1.0	0.5	trans-1,2-Dichloroethene	ND	1.0	0.5
1,2-Dichloropropane	ND	1.0	0.5	1,3-Dichloropropane	ND	1.0	0.5
2,2-Dichloropropane	ND	1.0	0.5	1,1-Dichloropropene	ND	1.0	0.5
cis-1,3-Dichloropropene	ND	1.0	0.5	trans-1,3-Dichloropropene	ND	1.0	0.5
Diisopropyl ether (DIPE)	ND	1.0	0.5	Ethylbenzene	ND	1.0	0.5
Ethyl tert-butyl ether (ETBE)	ND	1.0	0.5	Freon 113	ND	1.0	10
Hexachlorobutadiene	ND	1.0	0.5	Hexachloroethane	ND	1.0	0.5
2-Hexanone	ND	1.0	0.5	Isopropylbenzene	ND	1.0	0.5
4-Isopropyl toluene	ND	1.0	0.5	Methyl-t-butyl ether (MTBE)	ND	1.0	0.5
Methylene chloride	ND	1.0	0.5	4-Methyl-2-pentanone (MIBK)	ND	1.0	0.5
Naphthalene	ND	1.0	0.5	n-Propyl benzene	ND	1.0	0.5
Styrene	ND	1.0	0.5	1,1,1,2-Tetrachloroethane	ND	1.0	0.5
1,1,2,2-Tetrachloroethane	ND	1.0	0.5	Tetrachloroethene	ND	1.0	0.5
Toluene	ND	1.0	0.5	1,2,3-Trichlorobenzene	ND	1.0	0.5
1,2,4-Trichlorobenzene	ND	1.0	0.5	1,1,1-Trichloroethane	ND	1.0	0.5
1,1,2-Trichloroethane	ND	1.0	0.5	Trichloroethene	ND	1.0	0.5
Trichlorofluoromethane	ND	1.0	0.5	1,2,3-Trichloropropane	ND	1.0	0.5
1,2,4-Trimethylbenzene	ND	1.0	0.5	1,3,5-Trimethylbenzene	ND	1.0	0.5
Vinyl Chloride	ND	1.0	0.5	Xylenes, Total	ND	1.0	0.5

Surrogate Recoveries (%)

%SS1:	104	%SS2:	97
%SS3:	81		

Comments: b1

* water and vapor samples are reported in µg/L, soil/sludge/solid samples in mg/kg, product/oil/non-aqueous liquid samples and all TCLP & SPLP extracts are reported in mg/L, wipe samples in µg/wipe.

ND means not detected above the reporting limit/method detection limit; N/A means analyte not applicable to this analysis; %SS = Percent Recovery of Surrogate Standard; DF = Dilution Factor

surrogate diluted out of range or coelutes with another peak; &) low surrogate due to matrix interference.

b1) aqueous sample that contains greater than ~1 vol. % sediment



Gallardo & Associates, INC.
304 Belle Court
El Dorado Hills, CA 95762

Client Project ID: #001.11; Former E-Z Serve No. 100877
Client Contact: Rafael Gallardo
Client P.O.:

Date Sampled: 07/25/11
Date Received: 07/27/11
Date Extracted: 07/29/11
Date Analyzed: 07/29/11

Volatile Organics by P&T and GC/MS (Basic Target List)*

Extraction Method: SW5030B

Analytical Method: SW8260B

Work Order: 1107758

Lab ID		1107758-009B					
Client ID		MW-13					
Matrix		Water					
Compound	Concentration *	DF	Reporting Limit	Compound	Concentration *	DF	Reporting Limit
Acetone	14	1.0	10	tert-Amyl methyl ether (TAME)	ND	1.0	0.5
Benzene	ND	1.0	0.5	Bromobenzene	ND	1.0	0.5
Bromochloromethane	ND	1.0	0.5	Bromodichloromethane	ND	1.0	0.5
Bromoform	ND	1.0	0.5	Bromomethane	ND	1.0	0.5
2-Butanone (MEK)	ND	1.0	2.0	t-Butyl alcohol (TBA)	ND	1.0	2.0
n-Butyl benzene	ND	1.0	0.5	sec-Butyl benzene	ND	1.0	0.5
tert-Butyl benzene	ND	1.0	0.5	Carbon Disulfide	ND	1.0	0.5
Carbon Tetrachloride	ND	1.0	0.5	Chlorobenzene	ND	1.0	0.5
Chloroethane	ND	1.0	0.5	Chloroform	ND	1.0	0.5
Chloromethane	ND	1.0	0.5	2-Chlorotoluene	ND	1.0	0.5
4-Chlorotoluene	ND	1.0	0.5	Dibromochloromethane	ND	1.0	0.5
1,2-Dibromo-3-chloropropane	ND	1.0	0.2	1,2-Dibromoethane (EDB)	ND	1.0	0.5
Dibromomethane	ND	1.0	0.5	1,2-Dichlorobenzene	ND	1.0	0.5
1,3-Dichlorobenzene	ND	1.0	0.5	1,4-Dichlorobenzene	ND	1.0	0.5
Dichlorodifluoromethane	ND	1.0	0.5	1,1-Dichloroethane	ND	1.0	0.5
1,2-Dichloroethane (1,2-DCA)	ND	1.0	0.5	1,1-Dichloroethene	ND	1.0	0.5
cis-1,2-Dichloroethene	ND	1.0	0.5	trans-1,2-Dichloroethene	ND	1.0	0.5
1,2-Dichloropropane	ND	1.0	0.5	1,3-Dichloropropane	ND	1.0	0.5
2,2-Dichloropropane	ND	1.0	0.5	1,1-Dichloropropene	ND	1.0	0.5
cis-1,3-Dichloropropene	ND	1.0	0.5	trans-1,3-Dichloropropene	ND	1.0	0.5
Diisopropyl ether (DIPE)	ND	1.0	0.5	Ethylbenzene	ND	1.0	0.5
Ethyl tert-butyl ether (ETBE)	ND	1.0	0.5	Freon 113	ND	1.0	10
Hexachlorobutadiene	ND	1.0	0.5	Hexachloroethane	ND	1.0	0.5
2-Hexanone	ND	1.0	0.5	Isopropylbenzene	ND	1.0	0.5
4-Isopropyl toluene	ND	1.0	0.5	Methyl-t-butyl ether (MTBE)	ND	1.0	0.5
Methylene chloride	ND	1.0	0.5	4-Methyl-2-pentanone (MIBK)	ND	1.0	0.5
Naphthalene	ND	1.0	0.5	n-Propyl benzene	ND	1.0	0.5
Styrene	ND	1.0	0.5	1,1,1,2-Tetrachloroethane	ND	1.0	0.5
1,1,2,2-Tetrachloroethane	ND	1.0	0.5	Tetrachloroethene	ND	1.0	0.5
Toluene	ND	1.0	0.5	1,2,3-Trichlorobenzene	ND	1.0	0.5
1,2,4-Trichlorobenzene	ND	1.0	0.5	1,1,1-Trichloroethane	ND	1.0	0.5
1,1,2-Trichloroethane	ND	1.0	0.5	Trichloroethene	ND	1.0	0.5
Trichlorofluoromethane	ND	1.0	0.5	1,2,3-Trichloropropane	ND	1.0	0.5
1,2,4-Trimethylbenzene	ND	1.0	0.5	1,3,5-Trimethylbenzene	ND	1.0	0.5
Vinyl Chloride	ND	1.0	0.5	Xylenes, Total	ND	1.0	0.5

Surrogate Recoveries (%)

%SS1:	103	%SS2:	97
%SS3:	82		

Comments: b1

* water and vapor samples are reported in µg/L, soil/sludge/solid samples in mg/kg, product/oil/non-aqueous liquid samples and all TCLP & SPLP extracts are reported in mg/L, wipe samples in µg/wipe.

ND means not detected above the reporting limit/method detection limit; N/A means analyte not applicable to this analysis; %SS = Percent Recovery of Surrogate Standard; DF = Dilution Factor

surrogate diluted out of range or coelutes with another peak; &) low surrogate due to matrix interference.

b1) aqueous sample that contains greater than ~1 vol. % sediment

Gallardo & Associates, INC.
304 Belle Court
El Dorado Hills, CA 95762Client Project ID: #001.11; Former E-Z Serve No. 100877
Client Contact: Rafael Gallardo
Client P.O.:Date Sampled: 07/25/11
Date Received: 07/27/11
Date Extracted: 07/29/11
Date Analyzed: 07/29/11**Volatile Organics by P&T and GC/MS (Basic Target List)***

Extraction Method: SW5030B

Analytical Method: SW8260B

Work Order: 1107758

Lab ID	1107758-010B						
Client ID	MW-14						
Matrix	Water						
Compound	Concentration *	DF	Reporting Limit	Compound	Concentration *	DF	Reporting Limit
Acetone	ND	1.0	10	tert-Amyl methyl ether (TAME)	ND	1.0	0.5
Benzene	ND	1.0	0.5	Bromobenzene	ND	1.0	0.5
Bromochloromethane	ND	1.0	0.5	Bromodichloromethane	ND	1.0	0.5
Bromoform	ND	1.0	0.5	Bromomethane	ND	1.0	0.5
2-Butanone (MEK)	ND	1.0	2.0	t-Butyl alcohol (TBA)	ND	1.0	2.0
n-Butyl benzene	ND	1.0	0.5	sec-Butyl benzene	ND	1.0	0.5
tert-Butyl benzene	ND	1.0	0.5	Carbon Disulfide	ND	1.0	0.5
Carbon Tetrachloride	ND	1.0	0.5	Chlorobenzene	ND	1.0	0.5
Chloroethane	ND	1.0	0.5	Chloroform	ND	1.0	0.5
Chloromethane	ND	1.0	0.5	2-Chlorotoluene	ND	1.0	0.5
4-Chlorotoluene	ND	1.0	0.5	Dibromochloromethane	ND	1.0	0.5
1,2-Dibromo-3-chloropropane	ND	1.0	0.2	1,2-Dibromoethane (EDB)	ND	1.0	0.5
Dibromomethane	ND	1.0	0.5	1,2-Dichlorobenzene	ND	1.0	0.5
1,3-Dichlorobenzene	ND	1.0	0.5	1,4-Dichlorobenzene	ND	1.0	0.5
Dichlorodifluoromethane	ND	1.0	0.5	1,1-Dichloroethane	ND	1.0	0.5
1,2-Dichloroethane (1,2-DCA)	ND	1.0	0.5	1,1-Dichloroethene	ND	1.0	0.5
cis-1,2-Dichloroethene	ND	1.0	0.5	trans-1,2-Dichloroethene	ND	1.0	0.5
1,2-Dichloropropane	ND	1.0	0.5	1,3-Dichloropropane	ND	1.0	0.5
2,2-Dichloropropane	ND	1.0	0.5	1,1-Dichloropropene	ND	1.0	0.5
cis-1,3-Dichloropropene	ND	1.0	0.5	trans-1,3-Dichloropropene	ND	1.0	0.5
Diisopropyl ether (DIPE)	ND	1.0	0.5	Ethylbenzene	ND	1.0	0.5
Ethyl tert-butyl ether (ETBE)	ND	1.0	0.5	Freon 113	ND	1.0	10
Hexachlorobutadiene	ND	1.0	0.5	Hexachloroethane	ND	1.0	0.5
2-Hexanone	ND	1.0	0.5	Isopropylbenzene	ND	1.0	0.5
4-Isopropyl toluene	ND	1.0	0.5	Methyl-t-butyl ether (MTBE)	ND	1.0	0.5
Methylene chloride	ND	1.0	0.5	4-Methyl-2-pentanone (MIBK)	ND	1.0	0.5
Naphthalene	ND	1.0	0.5	n-Propyl benzene	ND	1.0	0.5
Styrene	ND	1.0	0.5	1,1,1,2-Tetrachloroethane	ND	1.0	0.5
1,1,2,2-Tetrachloroethane	ND	1.0	0.5	Tetrachloroethene	ND	1.0	0.5
Toluene	ND	1.0	0.5	1,2,3-Trichlorobenzene	ND	1.0	0.5
1,2,4-Trichlorobenzene	ND	1.0	0.5	1,1,1-Trichloroethane	ND	1.0	0.5
1,1,2-Trichloroethane	ND	1.0	0.5	Trichloroethene	ND	1.0	0.5
Trichlorofluoromethane	ND	1.0	0.5	1,2,3-Trichloropropane	ND	1.0	0.5
1,2,4-Trimethylbenzene	ND	1.0	0.5	1,3,5-Trimethylbenzene	ND	1.0	0.5
Vinyl Chloride	ND	1.0	0.5	Xylenes, Total	ND	1.0	0.5

Surrogate Recoveries (%)

%SS1:	100	%SS2:	98
%SS3:	94		

Comments:

* water and vapor samples are reported in µg/L, soil/sludge/solid samples in mg/kg, product/oil/non-aqueous liquid samples and all TCLP & SPLP extracts are reported in mg/L, wipe samples in µg/wipe.

ND means not detected above the reporting limit/method detection limit; N/A means analyte not applicable to this analysis; %SS = Percent Recovery of Surrogate Standard; DF = Dilution Factor

surrogate diluted out of range or coelutes with another peak; &) low surrogate due to matrix interference.

b1) aqueous sample that contains greater than ~1 vol. % sediment



Gallardo & Associates, INC.
304 Belle Court
El Dorado Hills, CA 95762

Client Project ID: #001.11; Former E-Z Serve No. 100877
Client Contact: Rafael Gallardo
Client P.O.:

Date Sampled: 07/25/11
Date Received: 07/27/11
Date Extracted: 07/29/11
Date Analyzed: 07/29/11

Volatile Organics by P&T and GC/MS (Basic Target List)*

Extraction Method: SW5030B

Analytical Method: SW8260B

Work Order: 1107758

Lab ID	1107758-011B
Client ID	VEAS-2
Matrix	Water

Compound	Concentration *	DF	Reporting Limit	Compound	Concentration *	DF	Reporting Limit
Acetone	ND	1.0	10	tert-Amyl methyl ether (TAME)	ND	1.0	0.5
Benzene	ND	1.0	0.5	Bromobenzene	ND	1.0	0.5
Bromochloromethane	ND	1.0	0.5	Bromodichloromethane	ND	1.0	0.5
Bromoform	ND	1.0	0.5	Bromomethane	ND	1.0	0.5
2-Butanone (MEK)	ND	1.0	2.0	t-Butyl alcohol (TBA)	ND	1.0	2.0
n-Butyl benzene	ND	1.0	0.5	sec-Butyl benzene	ND	1.0	0.5
tert-Butyl benzene	ND	1.0	0.5	Carbon Disulfide	1.9	1.0	0.5
Carbon Tetrachloride	ND	1.0	0.5	Chlorobenzene	ND	1.0	0.5
Chloroethane	ND	1.0	0.5	Chloroform	ND	1.0	0.5
Chloromethane	ND	1.0	0.5	2-Chlorotoluene	ND	1.0	0.5
4-Chlorotoluene	ND	1.0	0.5	Dibromochloromethane	ND	1.0	0.5
1,2-Dibromo-3-chloropropane	ND	1.0	0.2	1,2-Dibromoethane (EDB)	ND	1.0	0.5
Dibromomethane	ND	1.0	0.5	1,2-Dichlorobenzene	ND	1.0	0.5
1,3-Dichlorobenzene	ND	1.0	0.5	1,4-Dichlorobenzene	ND	1.0	0.5
Dichlorodifluoromethane	ND	1.0	0.5	1,1-Dichloroethane	ND	1.0	0.5
1,2-Dichloroethane (1,2-DCA)	ND	1.0	0.5	1,1-Dichloroethene	ND	1.0	0.5
cis-1,2-Dichloroethene	ND	1.0	0.5	trans-1,2-Dichloroethene	ND	1.0	0.5
1,2-Dichloropropane	ND	1.0	0.5	1,3-Dichloropropane	ND	1.0	0.5
2,2-Dichloropropane	ND	1.0	0.5	1,1-Dichloropropene	ND	1.0	0.5
cis-1,3-Dichloropropene	ND	1.0	0.5	trans-1,3-Dichloropropene	ND	1.0	0.5
Diisopropyl ether (DIPE)	ND	1.0	0.5	Ethylbenzene	ND	1.0	0.5
Ethyl tert-butyl ether (ETBE)	ND	1.0	0.5	Freon 113	ND	1.0	10
Hexachlorobutadiene	ND	1.0	0.5	Hexachloroethane	ND	1.0	0.5
2-Hexanone	ND	1.0	0.5	Isopropylbenzene	ND	1.0	0.5
4-Isopropyl toluene	ND	1.0	0.5	Methyl-t-butyl ether (MTBE)	ND	1.0	0.5
Methylene chloride	ND	1.0	0.5	4-Methyl-2-pentanone (MIBK)	ND	1.0	0.5
Naphthalene	ND	1.0	0.5	n-Propyl benzene	ND	1.0	0.5
Styrene	ND	1.0	0.5	1,1,1,2-Tetrachloroethane	ND	1.0	0.5
1,1,2,2-Tetrachloroethane	ND	1.0	0.5	Tetrachloroethene	ND	1.0	0.5
Toluene	ND	1.0	0.5	1,2,3-Trichlorobenzene	ND	1.0	0.5
1,2,4-Trichlorobenzene	ND	1.0	0.5	1,1,1-Trichloroethane	ND	1.0	0.5
1,1,2-Trichloroethane	ND	1.0	0.5	Trichloroethene	ND	1.0	0.5
Trichlorofluoromethane	ND	1.0	0.5	1,2,3-Trichloropropane	ND	1.0	0.5
1,2,4-Trimethylbenzene	ND	1.0	0.5	1,3,5-Trimethylbenzene	ND	1.0	0.5
Vinyl Chloride	ND	1.0	0.5	Xylenes, Total	ND	1.0	0.5

Surrogate Recoveries (%)

%SS1:	100	%SS2:	96
%SS3:	91		

Comments: b1

* water and vapor samples are reported in µg/L, soil/sludge/solid samples in mg/kg, product/oil/non-aqueous liquid samples and all TCLP & SPLP extracts are reported in mg/L, wipe samples in µg/wipe.

ND means not detected above the reporting limit/method detection limit; N/A means analyte not applicable to this analysis; %SS = Percent Recovery of Surrogate Standard; DF = Dilution Factor

surrogate diluted out of range or coelutes with another peak; &) low surrogate due to matrix interference.

b1) aqueous sample that contains greater than ~1 vol. % sediment



Gallardo & Associates, INC.
304 Belle Court
El Dorado Hills, CA 95762

Client Project ID: #001.11; Former E-Z Serve No. 100877
Client Contact: Rafael Gallardo
Client P.O.:

Date Sampled: 07/25/11
Date Received: 07/27/11
Date Extracted: 07/30/11
Date Analyzed: 07/30/11

Volatile Organics by P&T and GC/MS (Basic Target List)*

Extraction Method: SW5030B

Analytical Method: SW8260B

Work Order: 1107758

Lab ID		1107758-012B					
Client ID		VEAS-3					
Matrix		Water					
Compound	Concentration *	DF	Reporting Limit	Compound	Concentration *	DF	Reporting Limit
Acetone	ND<33	3.3	10	tert-Amyl methyl ether (TAME)	ND<1.7	3.3	0.5
Benzene	ND<1.7	3.3	0.5	Bromobenzene	ND<1.7	3.3	0.5
Bromochloromethane	ND<1.7	3.3	0.5	Bromodichloromethane	ND<1.7	3.3	0.5
Bromoform	ND<1.7	3.3	0.5	Bromomethane	ND<1.7	3.3	0.5
2-Butanone (MEK)	ND<6.7	3.3	2.0	t-Butyl alcohol (TBA)	ND<6.7	3.3	2.0
n-Butyl benzene	38	3.3	0.5	sec-Butyl benzene	21	3.3	0.5
tert-Butyl benzene	ND<1.7	3.3	0.5	Carbon Disulfide	7.5	3.3	0.5
Carbon Tetrachloride	ND<1.7	3.3	0.5	Chlorobenzene	ND<1.7	3.3	0.5
Chloroethane	ND<1.7	3.3	0.5	Chloroform	ND<1.7	3.3	0.5
Chloromethane	ND<1.7	3.3	0.5	2-Chlorotoluene	ND<1.7	3.3	0.5
4-Chlorotoluene	ND<1.7	3.3	0.5	Dibromochloromethane	ND<1.7	3.3	0.5
1,2-Dibromo-3-chloropropane	ND<0.67	3.3	0.2	1,2-Dibromoethane (EDB)	ND<1.7	3.3	0.5
Dibromomethane	ND<1.7	3.3	0.5	1,2-Dichlorobenzene	ND<1.7	3.3	0.5
1,3-Dichlorobenzene	ND<1.7	3.3	0.5	1,4-Dichlorobenzene	ND<1.7	3.3	0.5
Dichlorodifluoromethane	ND<1.7	3.3	0.5	1,1-Dichloroethane	ND<1.7	3.3	0.5
1,2-Dichloroethane (1,2-DCA)	ND<1.7	3.3	0.5	1,1-Dichloroethene	ND<1.7	3.3	0.5
cis-1,2-Dichloroethene	ND<1.7	3.3	0.5	trans-1,2-Dichloroethene	ND<1.7	3.3	0.5
1,2-Dichloropropane	ND<1.7	3.3	0.5	1,3-Dichloropropane	ND<1.7	3.3	0.5
2,2-Dichloropropane	ND<1.7	3.3	0.5	1,1-Dichloropropene	ND<1.7	3.3	0.5
cis-1,3-Dichloropropene	ND<1.7	3.3	0.5	trans-1,3-Dichloropropene	ND<1.7	3.3	0.5
Diisopropyl ether (DIPE)	ND<1.7	3.3	0.5	Ethylbenzene	ND<1.7	3.3	0.5
Ethyl tert-butyl ether (ETBE)	ND<1.7	3.3	0.5	Freon 113	ND<33	3.3	10
Hexachlorobutadiene	ND<1.7	3.3	0.5	Hexachloroethane	ND<1.7	3.3	0.5
2-Hexanone	ND<1.7	3.3	0.5	Isopropylbenzene	13	3.3	0.5
4-Isopropyl toluene	ND<1.7	3.3	0.5	Methyl-t-butyl ether (MTBE)	ND<1.7	3.3	0.5
Methylene chloride	ND<1.7	3.3	0.5	4-Methyl-2-pentanone (MIBK)	ND<1.7	3.3	0.5
Naphthalene	ND<1.7	3.3	0.5	n-Propyl benzene	60	3.3	0.5
Styrene	ND<1.7	3.3	0.5	1,1,1,2-Tetrachloroethane	ND<1.7	3.3	0.5
1,1,2,2-Tetrachloroethane	ND<1.7	3.3	0.5	Tetrachloroethene	ND<1.7	3.3	0.5
Toluene	ND<1.7	3.3	0.5	1,2,3-Trichlorobenzene	ND<1.7	3.3	0.5
1,2,4-Trichlorobenzene	ND<1.7	3.3	0.5	1,1,1-Trichloroethane	ND<1.7	3.3	0.5
1,1,2-Trichloroethane	ND<1.7	3.3	0.5	Trichloroethene	ND<1.7	3.3	0.5
Trichlorofluoromethane	ND<1.7	3.3	0.5	1,2,3-Trichloropropane	ND<1.7	3.3	0.5
1,2,4-Trimethylbenzene	ND<1.7	3.3	0.5	1,3,5-Trimethylbenzene	ND<1.7	3.3	0.5
Vinyl Chloride	ND<1.7	3.3	0.5	Xylenes, Total	ND<1.7	3.3	0.5

Surrogate Recoveries (%)

%SS1:	100	%SS2:	97
%SS3:	95		

Comments: b1

* water and vapor samples are reported in µg/L, soil/sludge/solid samples in mg/kg, product/oil/non-aqueous liquid samples and all TCLP & SPLP extracts are reported in mg/L, wipe samples in µg/wipe.

ND means not detected above the reporting limit/method detection limit; N/A means analyte not applicable to this analysis; %SS = Percent Recovery of Surrogate Standard; DF = Dilution Factor

surrogate diluted out of range or coelutes with another peak; &) low surrogate due to matrix interference.

b1) aqueous sample that contains greater than ~1 vol. % sediment



McC Campbell Analytical, Inc.

"When Quality Counts"

1534 Willow Pass Road, Pittsburg, CA 94565-1701
Web: www.mcccampbell.com E-mail: main@mcccampbell.com
Telephone: 877-252-9262 Fax: 925-252-9269

Gallardo & Associates, INC. 304 Belle Court El Dorado Hills, CA 95762	Client Project ID: #001.11; Former E-Z Serve No. 100877	Date Sampled: 07/25/11
	Client Contact: Rafael Gallardo	Date Received: 07/27/11
	Client P.O.:	Date Extracted: 07/28/11-07/29/11
		Date Analyzed: 07/28/11-07/29/11

Gasoline Range (C6-C12) Volatile Hydrocarbons as Gasoline with BTEX and MTBE*

Extraction method: SW5030B

Analytical methods: SW8021B/8015Bm

Work Order: 1107758

Lab ID	Client ID	Matrix	TPH(g)	MTBE	Benzene	Toluene	Ethylbenzene	Xylenes	DF	% SS	Comments
001A	MW-1	W	3600	---	8.9	10	27	ND<2.5	5	115	d2,d9
002A	MW-3	W	230	---	ND	1.4	2.2	ND	1	120	d2,d9
003A	MW-4	W	2600	---	32	13	180	170	1	105	d1
004A	MW-5	W	2900	---	1.8	12	2.2	1.9	1	98	d1
005A	MW-6	W	2000	---	1.0	23	7.6	3.2	1	104	d1
006A	EX-1	W	250	---	ND	1.6	1.1	ND	1	95	d1
007A	MW-9	W	2800	---	88	7.7	19	5.4	1	124	d1
008A	MW-12	W	ND	---	ND	ND	ND	ND	1	98	b1
009A	MW-13	W	ND	---	ND	ND	ND	ND	1	98	b1
010A	MW-14	W	ND	---	ND	ND	ND	ND	1	99	
011A	VEAS-2	W	ND	---	ND	ND	ND	ND	1	104	b1
012A	VEAS-3	W	3000	---	ND<1.0	9.9	ND<1.0	ND<1.0	2	110	d2,d9,b1

Reporting Limit for DF =1; ND means not detected at or above the reporting limit	W	50	5.0	0.5	0.5	0.5	0.5	0.5	0.5	0.5	µg/L
	S	1.0	0.05	0.005	0.005	0.005	0.005	0.005	0.005	0.005	mg/Kg

* water and vapor samples are reported in ug/L, soil/sludge/solid samples in mg/kg, wipe samples in µg/wipe, product/oil/non-aqueous liquid samples and all TCLP & SPLP extracts in mg/L.

cluttered chromatogram; sample peak coelutes w/surrogate peak; low surrogate recovery due to matrix interference. %SS = Percent Recovery of Surrogate Standard; DF = Dilution Factor

The following descriptions of the TPH chromatogram are cursory in nature and McC Campbell Analytical is not responsible for their interpretation:
b1) aqueous sample that contains greater than ~1 vol. % sediment
d1) weakly modified or unmodified gasoline is significant
d2) heavier gasoline range compounds are significant (aged gasoline?)
d9) no recognizable pattern



QC SUMMARY REPORT FOR SW8260B

W.O. Sample Matrix: Water

QC Matrix: Water

BatchID: 59996

WorkOrder: 1107758

Table with columns: EPA Method: SW8260B, Extraction: SW5030B, Spiked Sample ID: 1107758-009B. Rows include analytes like tert-Amyl methyl ether (TAME), Benzene, t-Butyl alcohol (TBA), Chlorobenzene, 1,2-Dibromoethane (EDB), 1,2-Dichloroethane (1,2-DCA), 1,1-Dichloroethene, Diisopropyl ether (DIPE), Ethyl tert-butyl ether (ETBE), Methyl-t-butyl ether (MTBE), Toluene, Trichloroethene, %SS1, %SS2, %SS3. Columns include Sample, Spiked, MS, MSD, MS-MSD, LCS, LCSD, LCS-LCSD, and Acceptance Criteria (%).

All target compounds in the Method Blank of this extraction batch were ND less than the method RL with the following exceptions: NONE

BATCH 59996 SUMMARY

Summary table with columns: Lab ID, Date Sampled, Date Extracted, Date Analyzed. Rows list lab IDs from 1107758-001B to 1107758-011B with corresponding dates and times.

MS = Matrix Spike; MSD = Matrix Spike Duplicate; LCS = Laboratory Control Sample; LCSD = Laboratory Control Sample Duplicate; RPD = Relative Percent Deviation.
% Recovery = 100 * (MS-Sample) / (Amount Spiked); RPD = 100 * (MS - MSD) / ((MS + MSD) / 2).
MS / MSD spike recoveries and / or %RPD may fall outside of laboratory acceptance criteria due to one or more of the following reasons: a) the sample is inhomogenous AND contains significant concentrations of analyte relative to the amount spiked, or b) the spiked sample's matrix interferes with the spike recovery.
N/A = not enough sample to perform matrix spike and matrix spike duplicate.
NR = analyte concentration in sample exceeds spike amount for soil matrix or exceeds 2x spike amount for water matrix or sample diluted due to high matrix or analyte content.
surrogate diluted out of range or coelutes with another peak; &) low surrogate due to matrix interference.
Laboratory extraction solvents such as methylene chloride and acetone may occasionally appear in the method blank at low levels.



QC SUMMARY REPORT FOR SW8021B/8015Bm

W.O. Sample Matrix: Water

QC Matrix: Water

BatchID: 60030

WorkOrder: 1107758

Table with columns: EPA Method: SW8021B/8015Bm, Extraction: SW5030B, Spiked Sample ID: 1107758-010A. Rows include Analyte (TPH, MTBE, Benzene, Toluene, Ethylbenzene, Xylenes, %SS) and Acceptance Criteria (%).

All target compounds in the Method Blank of this extraction batch were ND less than the method RL with the following exceptions: NONE

BATCH 60030 SUMMARY

Table with columns: Lab ID, Date Sampled, Date Extracted, Date Analyzed. Lists multiple sample IDs and their corresponding dates and times.

MS = Matrix Spike; MSD = Matrix Spike Duplicate; LCS = Laboratory Control Sample; LCSD = Laboratory Control Sample Duplicate; RPD = Relative Percent Deviation.
% Recovery = 100 * (MS-Sample) / (Amount Spiked); RPD = 100 * (MS - MSD) / ((MS + MSD) / 2).
MS / MSD spike recoveries and / or %RPD may fall outside of laboratory acceptance criteria due to one or more of the following reasons: a) the sample is inhomogenous AND contains significant concentrations of analyte relative to the amount spiked, or b) the spiked sample's matrix interferes with the spike recovery.
£ TPH(btex) = sum of BTEX areas from the FID.
cluttered chromatogram; sample peak coelutes with surrogate peak.
N/A = not enough sample to perform matrix spike and matrix spike duplicate.
NR = matrix interference and/or analyte concentration in sample exceeds spike amount for soil matrix or exceeds 2x spike amount for water matrix or sample diluted due to high matrix or analyte content, or inconsistency in sample containers.

APPENDIX C

FIGURES

Figure 3: Groundwater Contour Map

**Figure 4: TPH-G and benzene Isoconcentration Map
(July 25, 2011)**

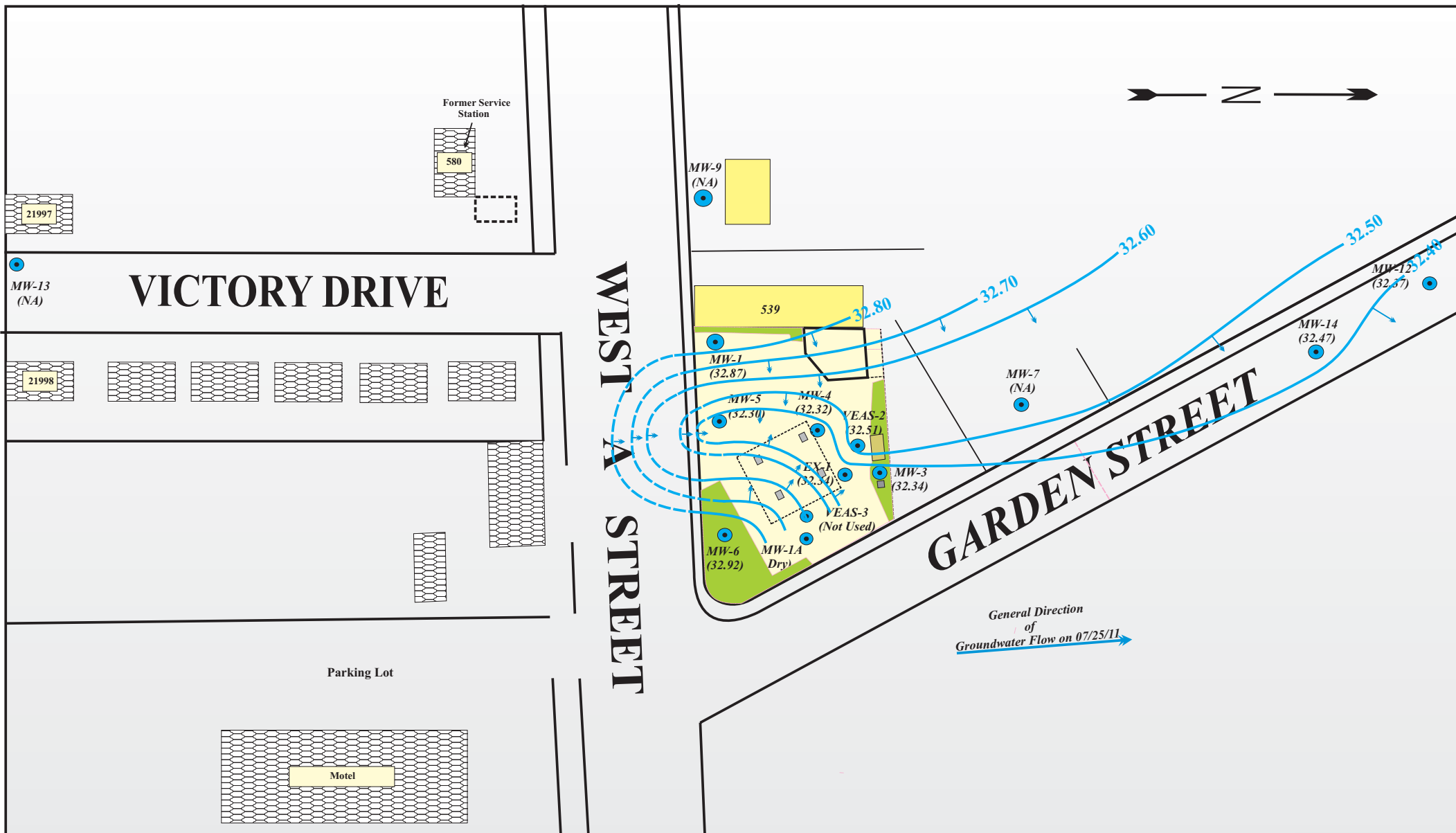

General Direction of Groundwater Flow on 07/25/11

GALLARDO & ASSOCIATES, INC.
 Environmental and Geological Services
 SITE MAP
 FORMER EZ SERVE NO.100877 HAYWARD SITE

EXPLANATION

- (MW-1) Groundwater Monitoring Well Location.
- (139.32) Approximate Elevation of Groundwater Measured in Feet.
- Approximate Direction of Groundwater Flow.
- Line of Equal Elevation of Groundwater Measured in Feet.

SCALE

0 30 60

- 136.00 -

FIGURE
3



GALLARDO & ASSOCIATES, INC.
Environmental and Geological Services

FIGURE
4